

**TABELE PERMBLEDHESE (Perm
komunitetet e varfera**

Nr.	Emer & Mbiemer	Propozimi
1	ALI AGAJ + ARTAN AGAJ	Objekt dy familjar
2	THOMA AGARAJ	Objekt nje familjar (1+1)
3	MENO KOJDHELAJ	Rikon. objekt ekzistues
4	SERVET ISLAMAJ	Objekt nje familjar (1+1)
5	RIZA MUSTA	Rik. Ob. Ekz.
6	BASHKIME SALAJ	Rik. Ob. Ekz.
7	DEMIR HALILAJ	Rik. Ob. Ekz.
8	PASHO FILAJ	Rik. Ob. Ekz.
9	AFRIM ISLAMAJ	Rik. Ob. Ekz.
10	LEONARD XHELAJ	Rik. Ob. Ekz.
11	RAJMONDA KACANI	Rik. Ob. Ekz.
12	VALENTINA BOMBAJ	Rik. Ob. Ekz.
13	ALUSH DALIPAJ	Rik. Ob. Ekz.
14	PANDELI HAMETAJ	Rik. Ob. Ekz.
15	ZANI KAHARAJ	Rik. Ob. Ekz.
16	JETNOR MUCAJ	Rik. Ob. Ekz.
17	TEFERI KARABINA	Rikon. objekt ekzistues
	SHUMA PA TVSH	Leke
	TVSH 20 %	Leke
	SHUMA PA TVSH	Leke

Pergatiti:

ING. Klevis BEDINAJ

ARK. Tea HAXHIAJ

TOP. Agim VEIZAJ

PREVENTIV

OBJEKTI: RIKONSTRUKSION I BANESES TE Z. JETNOR MUCAJ

NR	NR/AN	EMERTIMI I PUNIMEVE	NJESIA	SASIA
PUNIME SHITESHESH				
1	2.267/a	Shtrese me pllaka grez porcelanato	m ²	50.5
PUNIME SHITESHESH				
1	2.404/1	Boje Hidroplastike cilesi e larte	m ²	140.0
PUNIME SUVA TENDI				
1	2.310	Suva brenda mur tulle h~4m me krah, llaç perzier M 25	m ²	65
2	2.331	Suva e zakonshme fasade mur tulle ~ 8m	m ²	47
PUNIME DYER DRITE				
2	2.386/2	Dyer te blinduara importi	m ²	3.4
3	2.375/a	Dritare d/alumini dyfish xham	m ²	
SHUMA (1,2,3,4)				
TVSH 20%				
SHUMA				

PREVENTIVOI
ING. Klevis BEDINAJ
ARK. Tea HAXHIAJ
TOP. Agim VEIZAJ

Pe

PREVENTIV

OBJEKTI: RIKONSTRUKSION I BANESES TE Z.PASHO FILAJ

NR	NR/AN	EMERTIMI I PUNIMEVE	NJESIA	SASIA
PUNIME PRISHJE				
1	An	Prishje Suvatim Muri I Brendshem dhe I Jashtem	m ²	140.0
3	R.80	Prishje Tavan Drrase I thjeshte	m ²	36.0
4	An	Heqje dyer druri+largim nga objekti	m ²	5.1
5	An	Heqje dritaresh +largim nga objekti	m ²	2.1
PUNIME SHITESH				
1	2.267/a	Shtrese me pllaka grez porcelanato	m ²	36
PUNIME BOLLIMISHT				
1	2.404/1	Boje Hidroplastike cilesi e larte	m ²	140.0
PUNIME TAVANESH				
1	2.219	Cati vendi kapriat derrase,tjegulla importi	m ²	55
2	R.80	Tavan Drrase I thjeshte	m ²	47.6
PUNIME FASADESH				
1	2.310	Suva brenda mur tulle h~4m me krah, llaç perzier M 25	m ²	100
2	2.331	Suva e zakonshme fasade mur tulle ~ 8m	m ²	40
PUNIME DYER DRITE				
1	2.386/2	Dyer te blinduara importi	m ²	5.1
2	2.375/a	Dritare d/alumini dyfish xham	m ²	2.1
SHUMA (1,2,3,4,5,6)				
TVSH 20%				
SHUMA				

PREVENTIVOI
ING. Klevis BEDINAJ
ARK. Tea HAXHIAJ
TOP. Agim VEIZAJ

M
Pelli



PREVENTIV
OBJEKTI RIKONSTRUKSION I BANESES TE Z.MENO KOJDHELAJ

NR	NR/AN	EMERTIMI I PUNIMEVE	NJESIA	SASIA
PUNIME PRISHJE				
1	An	Prishje suvatim muri I brendshem	m ²	134.7
2	An	Prishje suvatim Tavani	m ²	33.6
3	R.80	Prishje Tavan Drrase I thjeshte	m ²	18.6
4	An	Heqje dyer druri+largim nga objekti	m ²	8.0
5	An	Heqje dritaresh +largim nga objekti	m ²	3.2
PUNIME SHTRESASH				
1	2.267/a	Shtrese me pllaka grez porcelanato	m ²	57.2
PUNIME BOJE THESHTJE				
1	2.404/1	Boje Hidroplastike cilesi e larte	m ²	168.2
PUNIME TAVANE				
1	R.80	Tavan Drrase I thjeshte	m ²	18.6
2	2.196/c	Hidroizolim 3 duar bitum =2 shtresa	m ²	71.22
PUNIME SHTRESA				
1	2.310	Suva brenda mur tulle h~4m me krah, llaç perzier M 25	m ²	134.7
2	2.3	Suva solete h ~ 4 m me drejtues, me krah	m ²	33.6
3	2.331	Suva e zakonshme fasade mur tulle ~ 8m	m ²	71.5
PUNIME DYER DRTIARE				
1	2.383/1	F V dyer te brendeshme druri importi cilesi e I-re.	m ²	5.0
2	2.386/2	Dyer te blinduara importi	m ²	3.0
3	2.375/a	Dritare d/alumini dyfish xham	m ²	3.2
SHUMA (1,2,3,4,5,6)				
TVSH 20%				
SHUMA				

PREVENTIVOI
 ING. Klevis BEDINAJ
 ARK. Tea HAXHIAJ
 TOP. Agim VEIZAJ



PREVENTIV

OBJEKTI: RIKONSTRUKSION I BANESES TE Z.RAIMONDA KACANI

NR	NR/AN	EMERTIMI I PUNIMEVE	NJESIA	SASIA
EMERTIMI I PUNIMEVE				
1	An	Prishje suvatim muri I brendshem	m ²	218.4
4	An	Heqje dyer druri +largim nga objekti	m ²	5.0
5	An	Heqje dritaresh +largim nga objekti	m ²	3.1
PUNIME SHITESASH				
1	2.267/a	Shtrese me pllaka grez porcelanato	m ²	42
PUNIME BOJE TISE				
1	2.404/1	Boje Hidroplastike cilesi e larte	m ²	183.4
PUNIME TAPACE				
1	2.264	Shtrese lluster cemento 1;2 per nivelim	m ²	50.9
2	2.196/c	Hidroizolim 3 duar bitunm =2 shtresa	m ²	51.0
4	2.203	Veshje kornize llamarine xingat	m ²	13.7
PUNIME SUVATIMI				
1	2.310	Suva brenda mur tulle h~4m me krah, llaç perzier M 25	m ²	146.4
2	2.331	Suva e zakonshme fasade mur tulle ~ 8m	m ²	63.6
PUNIME DRYTARE				
1	2.383/1	F V dyer te brendeshme druri importi cilesi e I-re.	m ²	3.70
2	2.386/2	Dyer te blinduara importi	m ²	2.1
3	2.375/a	Dritare d/alumini dyfish xham	m ²	2.70
SHUMA (1,2,3,4,5,6)				
TVSH 20%				
SHUMA				

PREVENTIVOI
ING. Klevis BEDINAJ
ARK. Tea HAXHIAJ
TOP. Agim VEIZAJ

1
Pe



PREVENTIV
OBJEKTI RIKONSTRUKSION I BANESES TE Z.SERVET ISLAMAJ

NR	NR/AN	EMERTIMI I PUNIMEVE	NJESIA	SASIA
1	2.267/a	Shtrese me pllaka grez porcelanato	m ²	81
1	2.404/1	Boje Hidroplastike cilesi e larte	m ²	100.0
1	2.264	Shtrese lluster cemento 1;2 per nivelim	m ²	94.2
2	2.196/c	Hidroizolim 3 duar bitumm =2 shtresa	m ²	94.2
3	2.264	Shtrese lluster çimento 1:2	m ²	94.2
1	2.383/1	F V dyer te brendeshme druri importi cilesi e l-re.	m ²	1.52
SHUMA (1,2,3,4)				
TVSH 20%				
SHUMA				

PREVENTIVOI
 ING. Klevis BEDINAJ
 ARK. Tea HAXHIAJ
 TOP. Agim VEIZAJ

Pe



PREVENTIV

OBJEKTI RIKONSTRUKSION I BANESES TE Z.RIZA MUSTA

NR	NR/AN	EMERTIMI I PUNIMEVE	NJESIA	SASIA
PUNIME PRISHJE				
3	R.80	Prishje Tavan Drrase I thjeshte	m ²	28.0
PUNIME SHITESASH				
1	2.262	Shtrese betoni C 6/10	m ²	0.30
PUNIME SHITESHIA DRETE				
1	2.71/2	Mur me tulla te lehtesuara dopio deri 8 m, LL.P. M-25	m ²	3.2
PUNIME DORATISJE				
1	2.404/1	Boje Hidroplastike cilesi e larte	m ²	86.0
PUNIME PUNITEVE				
1	2.219	Cati vendi kapriat derrase,tjegulla importi	m ²	53.0
2	R.80	Tavan Drrase I thjeshte	m ²	34
PUNIME SIVATIMI				
1	2.310	Suva brenda mur tulle h~4m me krah, llaç perzier M 25	m ²	30.0
2	2.331	Suva e zakonshme fasade mur tulle ~ 8m	m ²	25.0
PUNIME DYER DRITARE				
1	2.383/1	F V dyer te brendeshme druri importi cilesi e I-re.	m ²	4.80
3	2.375/a	Dritare d/alumini dyfish xham	m ²	1.6
SHUMA (1,2,3,4,5,6)				
TVSH 20%				
SHUMA				

PREVENTIVOI
ING. Klevis BEDINAJ
ARK. Tea HAXHIAJ
TOP. Agim VEIZAJ

P



PREVENTIV
OBJEKTI RIKONSTRUKSION I BANESES TE Z.BASHKIME SALAJ

NR	NR/AN	EMERTIMI I PUNIMEVE	NJESIA	SASIA
PUNIME PRISHJE				
1	An	Heqje dyer druri+largim nga objekti	m ²	8.277
2	R.80	Prishje Tavan Drrase I thjeshte	m ²	38.0
3	An	Heqje dritaresh +largim nga objekti	m ²	2.96
PUNIME SHITESH				
1	2.267/a	Shtrese me pllaka grez porcelanato	m ²	35
PUNIME KOPRIME				
1	2.404/1	Boje Hidroplastike cilesi e larte	m ²	95.0
PUNIME TAVANE				
1	2.219	Cati vendi kapriat derrase,tjegulla importi	m ²	42.0
2	R.80	Tavan Drrase I thjeshte	m ²	38.0
PUNIME DRYE				
1	2.383/1	F V dyer te brendeshme druri importi cilesi e l-re.	m ²	6.32
2	2.386/2	Dyer te blinduara importi	m ²	1.95
3	2.375/a	Dritare d/alumini dyfish xham	m ²	3.0
SHUMA (1,2,3,4,5,6)				
TVSH 20%				
SHUMA				

PREVENTIVOI
ING. Klevis BEDINAJ
ARK. Tea HAXHIAJ
TOP. Agim VEIZAJ

1

REPUBLIKA E

PREVENTIV
OBJEKTI RIKONSTRUKSION I BANESES TE Z.ZANI KAHARAJ

NR	NR/AN	EMERTIMI I PUNIMEVE	NJESIA	SASIA
PUNIME PRISHJE				
1	An	Prishje suvatim muri I brendshem	m ²	102.0
4	An	Heqje dyer druri +largim nga objekti	m ²	12.5
5	An	Heqje dritaresh +largim nga objekti	m ²	2.6
PUNIME SHITESHASE				
1	2.267/a	Shtrese me pllaka grez porcelanato	m ²	78
PUNIME HIDROIZOLIM				
1	2.404/1	Boje Hidroplastike cilesi e larte	m ²	147.0
PUNIME TERRACE				
1	2.264	Shtrese lluster cemento 1:2 per nivelim	m ²	85
2	2.196/b	Hidroizolim me nje shtrese mapej	m ²	85
PUNIME SUVA				
1	2.310	Suva brenda mur tulle h~4m me krah, llaç perzier M 25	m ²	102
2	2.331	Suva e zakonshme fasade mur tulle ~ 8m	m ²	45.0
PUNIME DRYER				
1	2.383/1	F V dyer te brendeshme druri importi cilesi e l-re.	m ²	10.60
2	2.386/2	Dyer te blinduara importi	m ²	2.0
3	2.375/a	Dritare d/alumini dyfish xham	m ²	2.6
SHUMA (1,2,3,4,5,6)				
TVSH 20%				
SHUMA				

PREVENTIVOI
ING. Klevis BEDINAJ
ARK. Tea HAXHIAJ
TOP. Agim VEIZAJ

M
Pel

PREVENTIV
OBJEKTI RIKONSTRUKSION I BANESES TE Z. VALENTINA BOMBAJ

NR	NR/AN	EMERTIMI I PUNIMEVE	NJESIA	SASIA
PUNIME PRISHJE				
1	An	Heqje dyer druri+largim nga objekti	m ²	7.08
1	An	Prishje suvatim muri I brendshem	m ²	56.52
3	An	Heqje dritaresh +largim nga objekti	m ²	3.9
PUNIME SHITESASH				
1	2.267/a	Shtrese me pllaka grez porcelanato	m ²	35.31
PUNIME BOJATISIE				
1	2.404/1	Boje Hidroplastike cilesi e larte	m ²	150.0
PUNIME SUVAZIMI				
1	2.310	Suva brenda mur tulle h~4m me krah, llaç perzier M 25	m ²	56.52
PUNIME DRYER DREZARE				
1	2.383/1	F V dyer te brendeshme druri importi cilesi e l-re.	m ²	4.68
2	2.386/2	Dyer te blinduara importi	m ²	2.4
3	2.375/a	Dritare d/alumini dyfish xham	m ²	3.9
PUNIME HIDKOSANITARI				
1	2.506	F.V bide importi porcelani	cope	1
2	2.501	F.V WC allafrenga importi	cope	1
3	2.495	F.V lavaman porcelani importi me mishelator	cope	1
SHUMA (1,2,3,4,5,6)				
TVSH 20%				
SHUMA				

PREVENTIVOI
ING. Klevis BEDINAJ
ARK. Tea HAXHIAJ
TOP. Agim VEIZAJ

REPUBLIK

PREVENTIV
OBJEKTI RIKONSTRUKSION I BANESES TE Z.DEMIR HALILAJ

NR	NR/AN	EMERTIMI I PUNIMEVE	NJESIA	SASIA
PUNIME PRISHJE				
1	R.80	Prishje Tavan Drrase I thjeshte	m ²	70.0
2	An	Heqje dyer druri + dritare+largim nga objekti	m ²	5.3
3	An	Heqje dritaresh +largim nga objekti	m ²	3.8
PUNIME SHITURRESH				
1	2.267/a	Shitrese me pllaka grez porcelanato	m ²	45
PUNIME BOJATRIE				
1	2.404/a	Boje Hidroplastike cilesi e larte	m ²	110
PUNIME TARRACE				
1	2.219	Cati vendi kapriat derrase,tjegulla importi	m ²	48
2	R.80	Tavan Drrase I thjeshte	m ²	48
PUNIME DYER DITARE				
1	2.383/1	F V dyer te brendeshme druri importi cilesi e I-re.	m ²	3.50
2	2.386/2	Dyer te blinduara importi	m ²	1.8
3	2.375/a	Dritare d/alumini dyfish xham	m ²	3.8
SHUMA (1,2,3,4,5,6)				
TVSH 20%				
SHUMA				

PREVENTIVOI
ING. Klevis BEDINAJ
ARK. Tea HAXHIAJ
TOP. Agim VEIZAJ

Pe

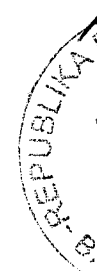

PREVENTIV
OBJEKTI RIKONSTRUKSION I BANESES TE Z.AFRIM ISLAMAJ

NR	NR/AN	EMERTIMI I PUNIMEVE	NJESIA	SASIA
PUNIME PRISHJE				
1	An	Prishje suvatim muri I brendshem	m ²	31.0
3	R.80	Prishje Tavan Drrase I thjeshte	m ²	114.6
4	An	Heqje dyer druri + dritare+largim nga objekti	m ²	4.2
5	An	Heqje dritarësh +largim nga objekti	m ²	3.2
PUNIME SHITESASH				
1	2.267/a	Shtrese me pllaka grez porcelanato	m ²	51
PUNIME DORRASE				
1	2.404/1	Boje Hidroplastike cilesi e larte	m ²	186.0
PUNIME TARRAGE				
1	2.219	Cati vendi kapriat derrase,tjegulla importi	m ²	72
2	R.80	Tavan Drrase I thjeshte	m ²	46.3
PUNIME SUVATIMI				
1	2.310	Suva brenda mur tulle h~4m me krah, llaç perzier M 25	m ²	141
2	2.331	Suva e zakonshme fasade mur tulle ~ 8m	m ²	81
PUNIME DYER DRITARE				
1	2.383/1	F V dyer te brendeshme druri importi cilesi e I-re.	m ²	2.10
2	2.386/2	Dyer te blinduara importi	m ²	2.1
3	2.375/a	Dritare d/alumini dyfish xham	m ²	3.2
SHUMA (1,2,3,4,5,6)				
TVSH 20%				
SHUMA				

PREVENTIVOI
 ING. Klevis BEDINAJ
 ARK. Tea HAXHIAJ
 TOP. Agim VEIZAJ

I
 Pe

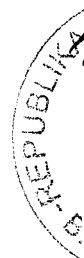

PREVENTIV
OBJEKTI RIKONSTRUKSION I BANESES TE Z.ALUSH DALIPAJ, SELENICE

NR	NR/AN	EMERTIMI I PUNIMEVE	NJESIA	SASIA
REKONSTRUKSIONI				
1	R.80	Prishje Tavan Drrase I thjeshte	m ²	65.0
2	An	Prishje suvatim muri I brendshem	m ²	99.0
3	An	Heqje dyer druri +largim nga objekti	m ²	4.3
4	An	Heqje dritaresh +largim nga objekti	m ²	1.4
REKONSTRUKSIONI				
1	2.267/a	Shtrese me pllaka grez porcelanato	m ²	52.0
REKONSTRUKSIONI				
1	2.404/1	Boje Hidroplastike cilesi e larte	m ²	180.0
PUNIME TARRACE				
1	2.219	Cati vendi kapriat derrase,tjegulla importi	m ²	65.0
2	R.80	Tavan Drrase I thjeshte	m ²	47.9
PUNIME DRYE/DRIVE				
1	2.310	Suva brenda mur tulle h~4m me krah, llaç perzier M 25	m ²	98.0
2	2.331	Suva e zakonshme fasade mur tulle ~ 8m	m ²	62.0
PUNIME DYER DRITARE				
1	2.383/1	F V dyer te brendeshme druri importi cilesi e I-re.	m ²	2.1
2	2.386/2	Dyer te blinduara importi	m ²	1.5
3	2.375/a	Dritare d/alumini dyfish xham	m ²	1.4
SHUMA (1,2,3,4,5,6)				
TVSH 20%				
SHUMA				

PREVENTIVOI
ING. Klevis BEDINAJ
ARK. Tea HAXHIAJ
TOP. Agim VEIZAJ

M
Pel

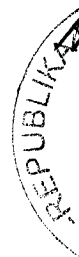

PREVENTIV
OBJEKTI RIKONSTRUKSION I BANESES TE Z.PANDELI HAMETAJ

NR	NR/AN	EMERTIMI I PUNIMEVE	NJESIA	SASIA
PUNIME PRISHJE				
1	R.121	Prishje suvatimi	m ²	62.0
4	An	Heqje dyer druri +largim nga objekti	m ²	6.5
5	An	Heqje dritaresh +largim nga objekti	m ²	2.6
PUNIME SHITRESH				
1	2.267/a	Shtrese me pllaka grez porcelanato	m ²	37.6
PUNIME BOJATISJE				
1	2.404/1	Boje Hidroplastike cilesi e larte	m ²	153.0
PUNIME TARRACE				
1	2.219	Cati vendi kapriat derrase,tjegulla importi	m ²	44
PUNIME DRYATIMI				
1	2.310	Suva brenda mur tulle h~4m me krah, llaç perzier M 25	m ²	130.0
2	2.331	Suva e zakonshme fasade mur tulle ~ 8m	m ²	23.0
PUNIME DYER DRIARE				
1	2.383/1	F V dyer te brendeshme druri importi cilesi e I-re.	m ²	4.4
2	2.386/2	Dyer te blinduara importi	m ²	2.1
3	2.375/a	Dritare d/alumini dyfish xham	m ²	2.6
SHUMA (1,2,3,4,5,6)				
TVSH 20%				
SHUMA				

PREVENTIVOI
ING. Klevis BEDINAJ
ARK. Tea HAXHIAJ
TOP. Agim VEIZAJ

Pe

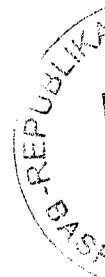

PREVENTIV
OBJEKTI RIKONSTRUKSION I BANESES TE Z.ALI AGAJ

NR	NR/AN	EMERTIMI I PUNIMEVE	NJESIA	SASIA
PUNIME PRISHJE				
1	An	Heqje dyer druri+largim nga objekti	m ²	3.6
2	R.80	Prishje Tavan Drrase I thjeshte	m ²	12.0
4	An	Heqje dritaresh +largim nga objekti	m ²	3.6
PUNIME PLOTIM				
1	2.267/a	Shtrese me pllaka grez porcelanato	m ²	35
PUNIME BOJATISJE				
1	2.404/1	Boje Hidroplastike cilesi e larte	m ²	65.0
PUNIME MUR				
1	2.310	Suva brenda mur tulle h~4m me krah, llaç perzier M 25	m ²	52
2	2.331	Suva e zakonshme fasade mur tulle ~ 8m	m ²	20
PUNIME DRYER				
1	2.383/1	F V dyer te brendeshme druri importi cilesi e l-re.	m ²	1.80
2	2.386/2	Dyer te blinduara importi	m ²	1.8
3	2.375/a	Dritare d/alumini dyfish xham	m ²	3.6
PUNIME TAVANI				
1	2.219	Cati vendi kapriat derrase,tjegulla importi	m ²	32.0
2	R.80	Tavan Derrase I thjeshte	m ²	27.5
SHUMA (1,2,3,4,5,6)				
TVSH 20%				
SHUMA				

PREVENTIVOI
 ING. Klevis BEDINAJ
 ARK. Tea HAXHIAJ
 TOP. Agim VEIZAJ

Pe



PREVENTIV
OBJEKTI RIKONSTRUKSION I BANESES TE Z.ARTAN AGAJ

NR	NR/AN	EMERTIMI I PUNIMEVE	NJESIA	SASIA
PUNIME PRISHJE				
1	An	Heqje dyer druri+largim nga objekti	m ²	5.4
2	R.80	Prishje Tavan Drrase I thjeshte	m ²	52.0
4	An	Heqje dritaresh +largim nga objekti	m ²	3.6
PUNIME SHTRESH				
1	2.267/a	Shtrese me pllaka grez porcelanato	m ²	57.8
PUNIME BOJATISE				
1	2.404/1	Boje Hidroplastike cilesi e larte	m ²	234.0
PUNIME TAVANI				
1	2.219	Cati vendi kapriat derrase,tjegulla importi	m ²	55.0
2	R.80	Tavan Drrase I thjeshte	m ²	48.0
PUNIME SUVA				
1	2.310	Suva brenda mur tulle h~4m me krah, llaç perzier M 25	m ²	40
2	2.331	Suva e zakonshme fasade mur tulle ~ 8m	m ²	35
PUNIME DYER DITARE				
1	2.383/1	F V dyer te brendeshme druri importi cilesi e I-re.	m ²	3.6
2	2.386/2	Dyer te blinduara importi	m ²	1.8
3	2.375/a	Dritare d/alumini dyfish xham	m ²	1.8
PUNIME HIDROSANTARE				
1	2.506	F.V bide importi porcelani	cope	1
2	2.501	F.V WC allafrenga importi	cope	1
3	2.495	F.V lavaman porcelani importi me mishelator	cope	1
SHUMA (1,2,3,4,5,6)				
TVSH 20%				
SHUMA				

PREVENTIVOI
ING. Klevis BEDINAJ
ARK. Tea HAXHIAJ
TOP. Agim VEIZAJ

Pe



PREVENTIV
OBJEKTI RIKONSTRUKSION I BANESES TE Z.LEONARD XHELAJ

NR	NR/AN	EMERTIMI I PUNIMEVE	NJESIA	SASIA
PUNIME PRISHJE				
1	An	Heqje dyer druri+largim nga objekti	m ²	8.5
2	R.80	Prishje Tavan Drrase I thjeshte	m ²	18.0
3	An	Heqje dritaresh +largim nga objekti	m ²	3.6
PUNIME SHTRESASH				
1	2.267/a	Shtrese me pllaka grez porcelanato	m ²	43
PUNIME BOJATISJE				
1	2.404/1	Boje Hidroplastike cilesi e larte	m ²	168.0
PUNIME SUXHTIMI				
1	2.358/b	Veshje fasade me polisterol kompakt jeshil t=5cm + rrjete + grafiato	m ²	58
PUNIME TAVANI				
1	2.219	Cati vendi kapriat derrase,tjegulla importi	m ²	15.3
2	R.80	Tavan Drrase I thjeshte	m ²	50.0
PUNIME DYER DRITARE				
1	2.383/1	F V dyer te brendeshme druri importi cilesi e I-re.	m ²	6.6
2	2.386/2	Dyer te blinduara importi	m ²	1.9
3	2.375/a	Dritare d/alumini dyfish xham	m ²	3.6
PUNIME HIDRO-SANITARE				
1	2.506	F.V bide importi porcelani	cope	1
2	2.501	F.V WC allafrenga importi	cope	1
3	2.495	F.V lavaman porcelani importi me mishelator	cope	1
SHUMA (1,2,3,4,5,6)				
TVSH 20%				
SHUMA				

PREVENTIVOI
ING. Klevis BEDINAJ
ARK. Tea HAXHIAJ
TOP. Agim VEIZAJ

Pe



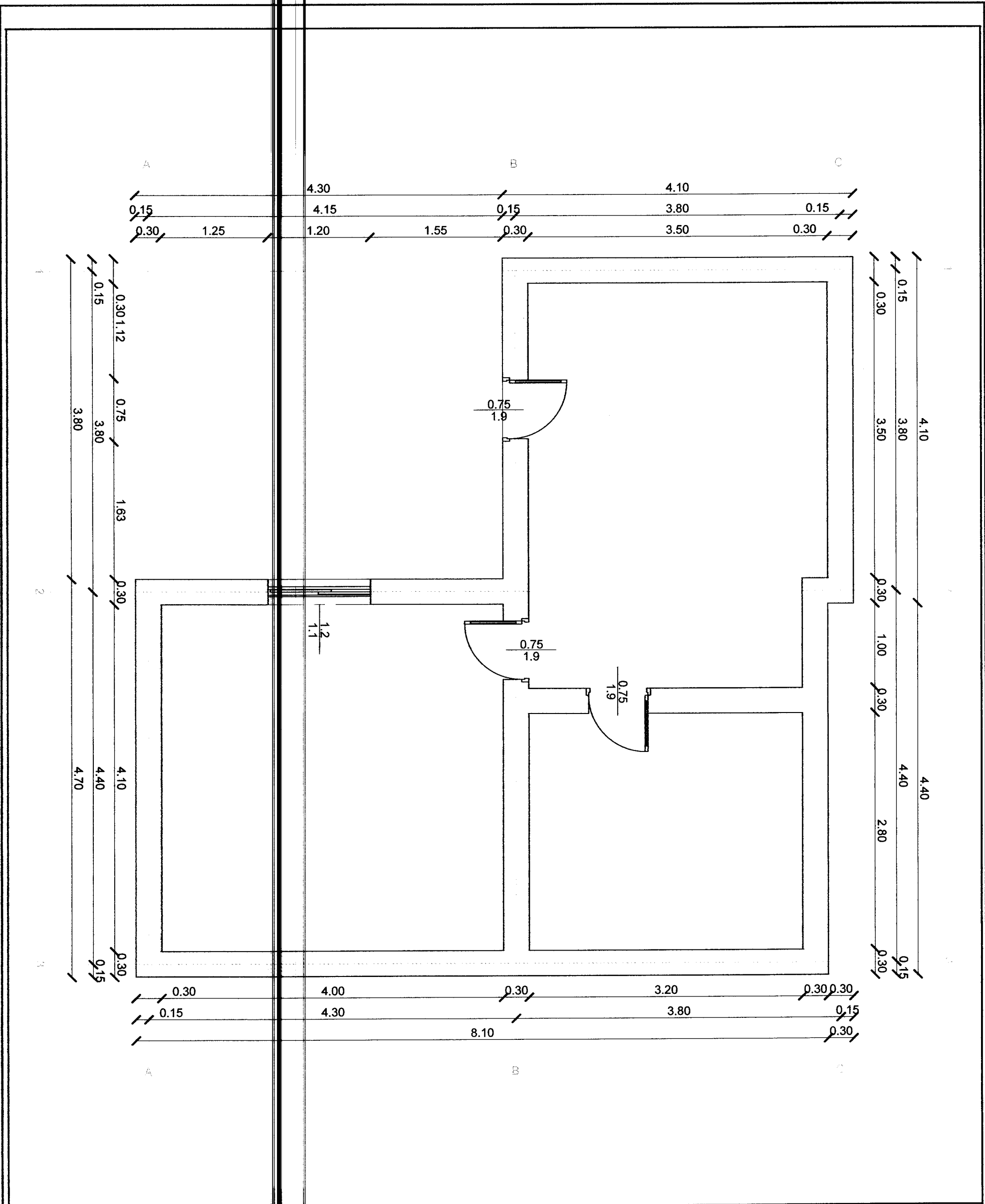

Shtetimi

Legjende:

Inventar
Bashkia Selence



Emeritimi I projektit
Selence-Rikonstruksioni I
baneses se Z. Alush Dalipaj

Faza e Projektit
PROJEKT ZBATIM

Planimetria

Projektori	Emer Mblenar	Firma
Titulli	Arbn VERDA	SELLENCE

Mirator	Emer Mblenar	Firma
Titulli	Arbn VERDA	SELLENCE

Dwg. N°/M/1.01
Emeritimi i eteles:
Planimetria

KM
Shtetimi

A3 - 1:40

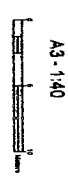

Skenime

Legjende:

Investitor
Bashkia Selence

Emeritimi I projektit
Selence - Rikonstrukcion per z.Aluash
Dallipaj

Faza e Projektit
PROJEKT ZBATIM

Planimetria

Projekto Emer Mblomer Firma

Emri, Mblomeri, Adresa

Adresa, Nr. Nivellimit

Mirretori Emer Mblomeri Etime

Emri, Mblomeri, Adresa

Emertimi i fletes:

Drejtore e Celles SMOE

K.M.

Shkalla:

A3-1:100



Dwg.Nomri 1.04

Emertimi i fletes:

Drejtore e Celles SMOE

Shkalla:

A3-1:100

Detaj i kullimit te qetes

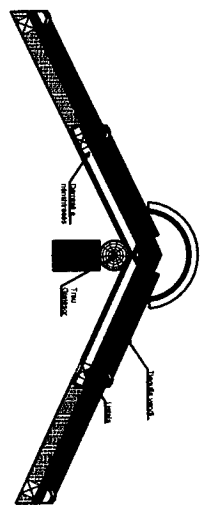

DETAJ I BASHKIMIT NE CEP TE CATISE

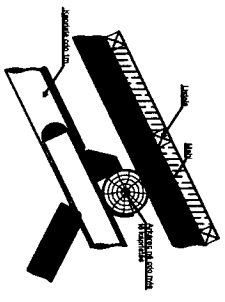

DETAJ I BASHKIMIT NE KULMIN E CATISE

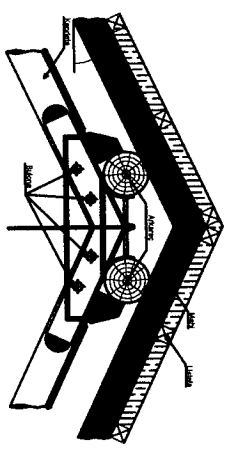

DETAJ I MBULIMIT TE CATISE

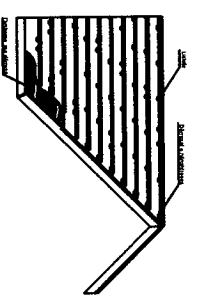

Shenime

Investitori

BASHKIA SELENICE



Emertimi i projektit

Selenice : Rikonstruksioni i objektit te Pandas
Ahmetaj

Faza e Projektit

Projekt zbatimi

Projektor

Emert Mbaneset

Firma

bash. Keshori

KESHORIBINDAS

Adresa

TERRAVALLI

bash. Trepur

Adresa Vendi

Emert Mbaneset

Ejma

Mirrored

Emertimi i objektit

Planimetria e Perqirimit

Shtetit

A3 - 140

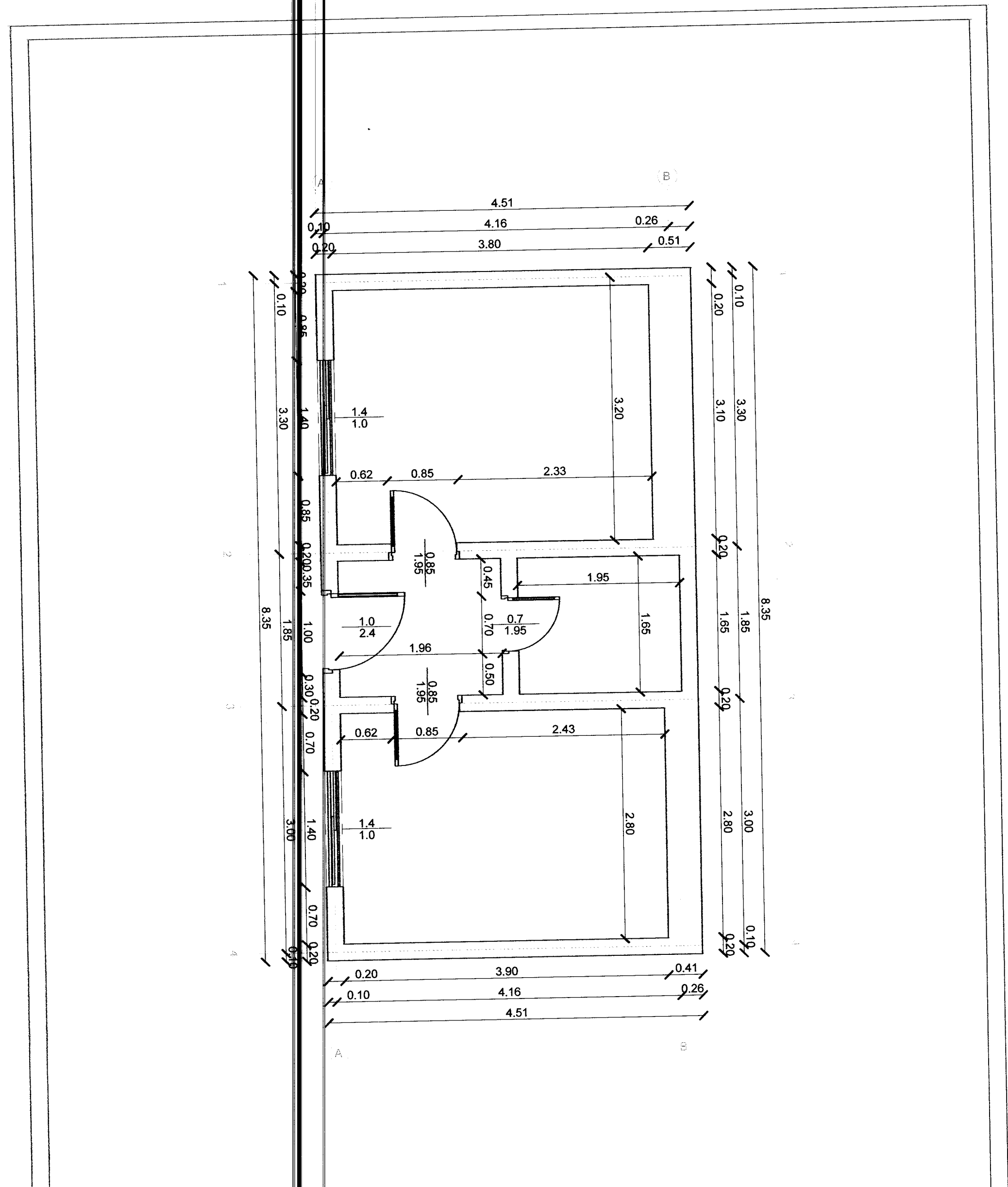

Skenime

Legjende:

Inveshtitor
Bashkia Selanice



Emertimi i projektit
Rikonstrukcion per z.Pandell Ahmetaj

Faza e Projektit
PROJEKT ZBATIM

Planimetria

Projekto	Emer Mblemer	Firma
Udh. Hapshim	Kozma BESHKIU	
Sh. No.	100/2004	
Akt.	Te Hapshim	

Mirretel	Emer	Firma
Projekt		

Dwg: 07/03
Emertimi i tijesori
Detaje Catite SAJUCE

K.M.
Shkakli

A3-1:50

Detaji i kullimit te catites

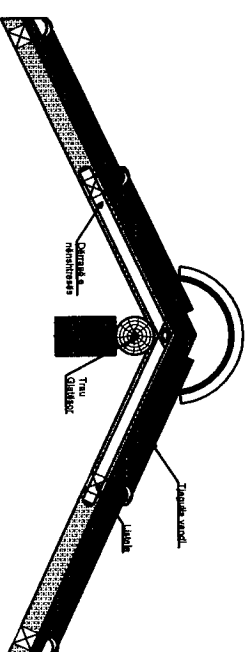

DETAJ I BASHKIMIT NE CEP TE CATITSE

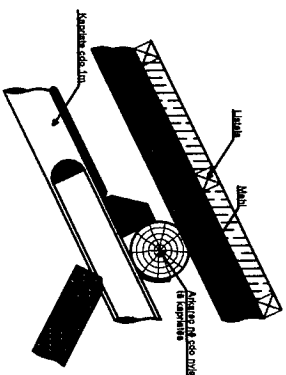

DETAJ I BASHKIMIT NE KUJMIN E CATITSE

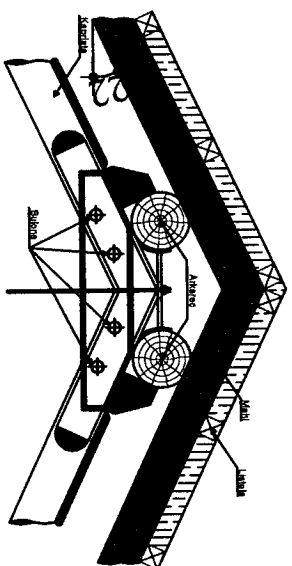

SHKURIME
1. Materiali i izolimit te njezimit te catites te jete i nevojshem te jete i kualitetit te nevojshem.
2. Materiali i izolimit te njezimit te catites te jete i nevojshem te jete i kualitetit te nevojshem.
3. Materiali i izolimit te njezimit te catites te jete i nevojshem te jete i kualitetit te nevojshem.

DETAJ I MBULIMIT TE CATITSE

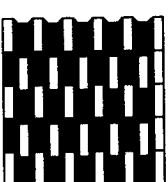
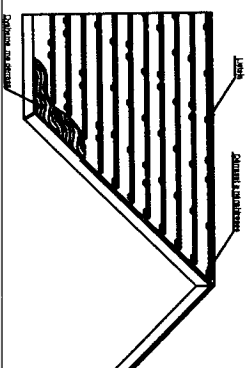

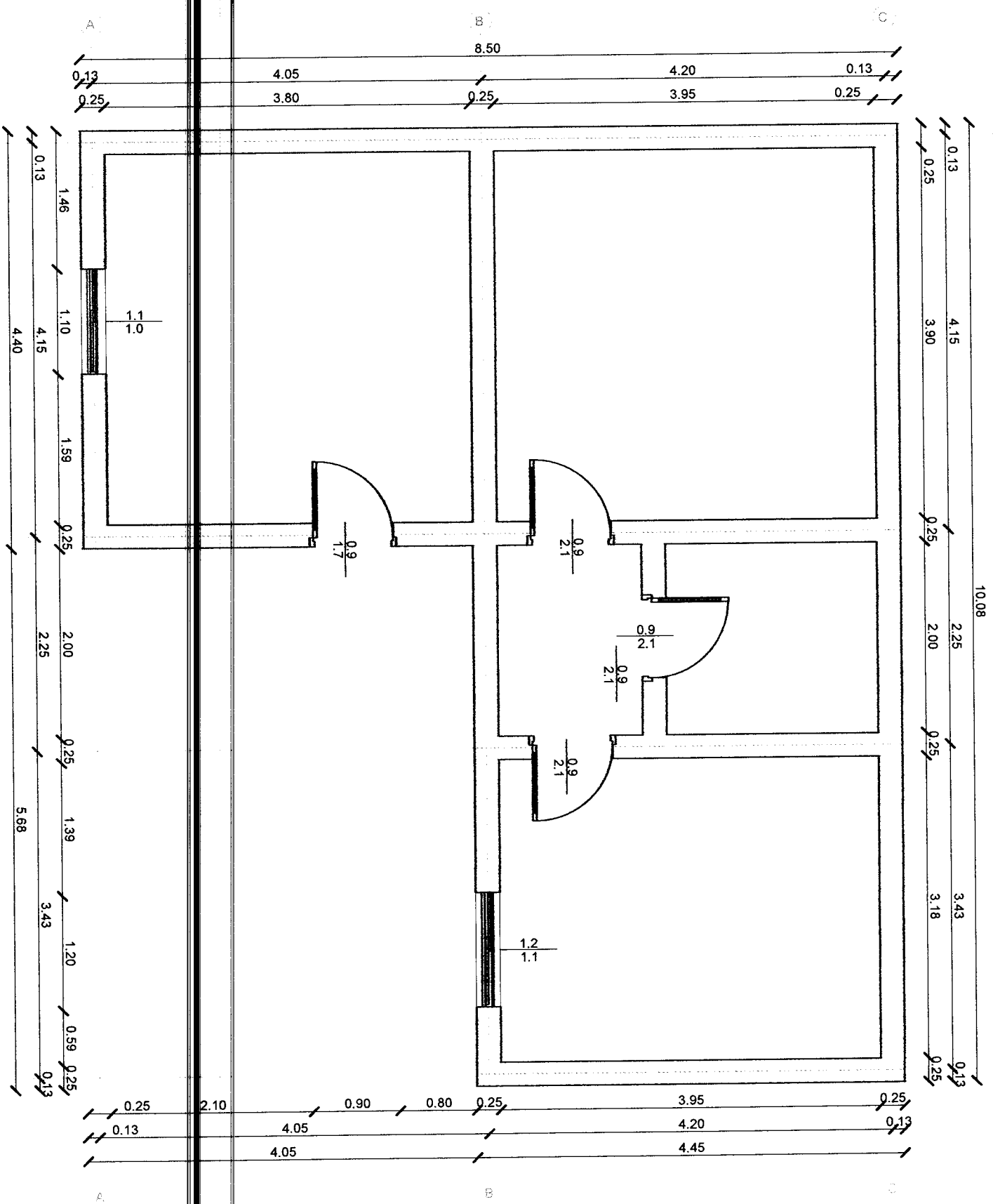

Skenime

Investitori

BASHKIA SELENICE



Emertimi i projektit

Selenice - Rikonstruksioni i objektit te Z. Zani Kalliraj

Faza e Projektit:

Projekt zbatimi

Projektori

Emri Mbledhës

Firma

Adresa

Emri i Autorit

Materialet

Emri i Mbledhës

Firma

DWG.NF.16/01

Emertimi i Projektit:
Planimetria e Rregullimit

Shtylla:

A3 - 1:50

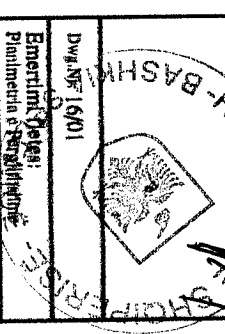

Sherime

Legende:

Inventar
Bashkia Selencia



Emertimi i projektit
Rikonstrukcion per zarrin Kahiraj

Faza e Projektit
PROJEKT ZBATIM

Planimetria

Projektori Emer Mblomer Firma
 Sh. Mblomeri Rreze BASHKIA
 Nr. Adresa: ZARRIN
 Adh. Tel. Numri:

Mirretaj Ergje Mblomeri Sipas
 Projektor Shkencor Shtetror
 Detyr. Nr. 18/02
 Emertimi i Projektit
 Detyrja e Celles
 KM.
 Shtetliri

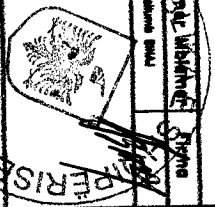

A3-1:50

Detaj i kulmit te catise

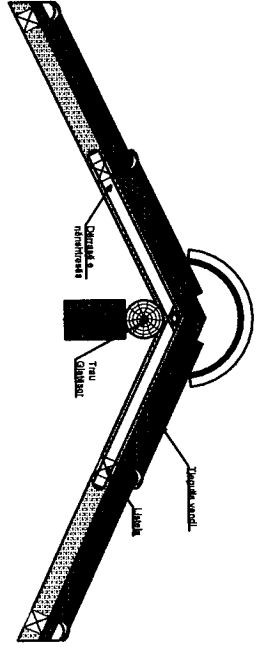

DETAJ I BASHKIMIT NE CEP TE CATISE

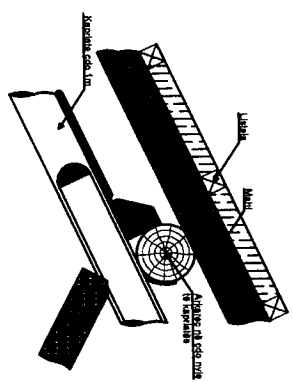

DETAJ I BASHKIMIT NE KULMIN E CATISE

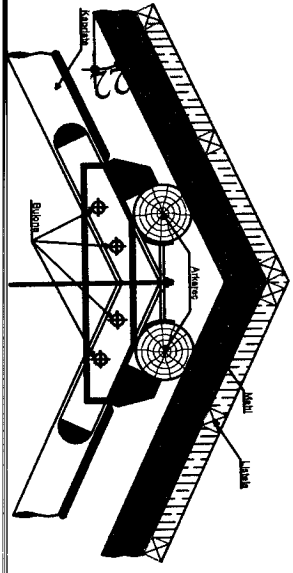

SHENIMET:
 1. Niveli i krahut te catise te rreze eshte i barabarte me nivelin e krahut te catise te bashkimit.
 2. Niveli i krahut te catise te bashkimit eshte i barabarte me nivelin e krahut te catise te rreze.
 3. Niveli i krahut te catise te bashkimit eshte i barabarte me nivelin e krahut te catise te rreze.

DETAJ I MBULIMIT TE CATISE

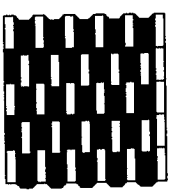
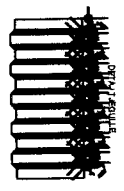
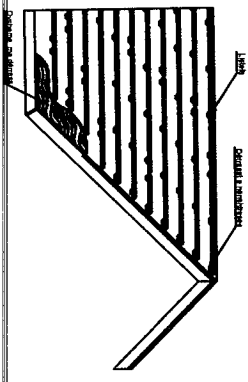

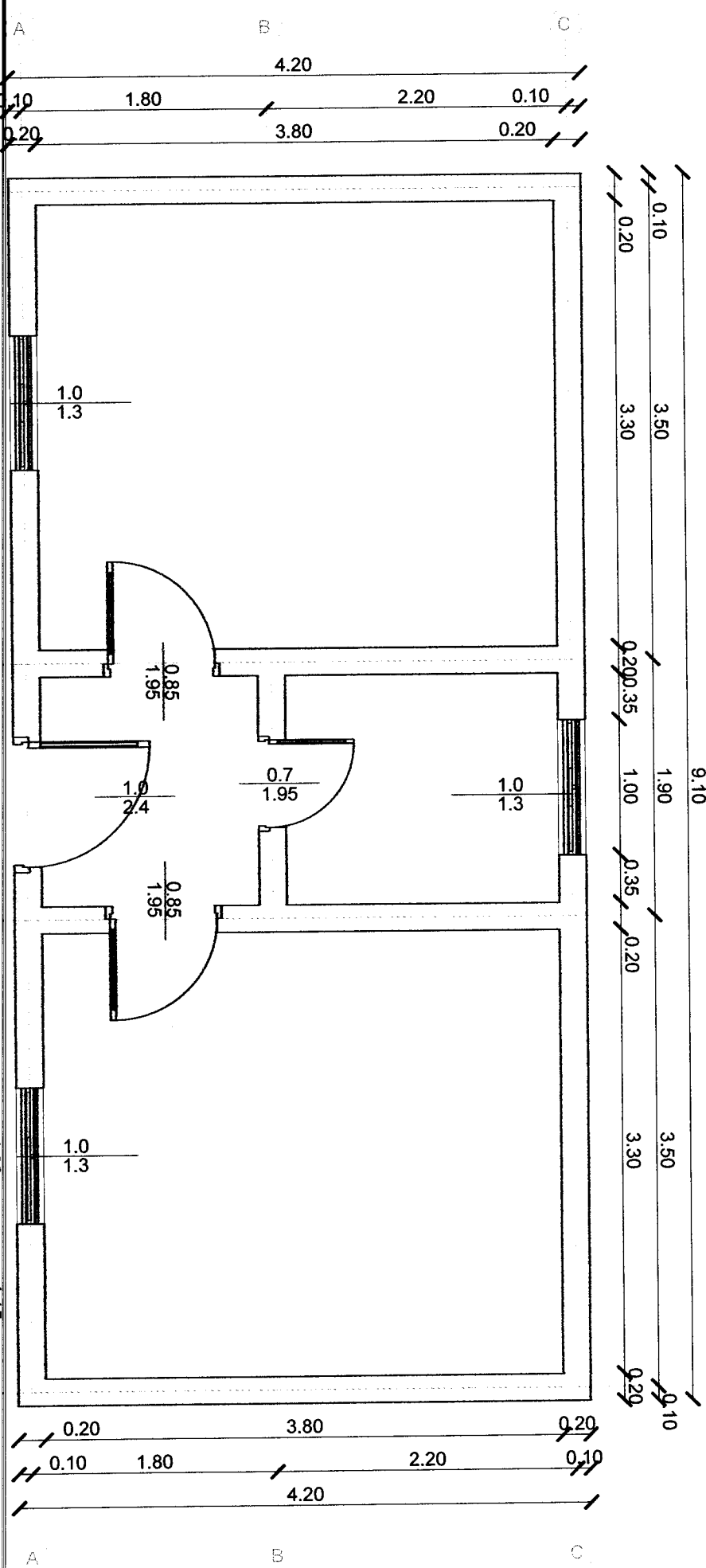

Shenime

Investitori

BASHKIA SELENICE



Emertimi i projektit

Rikonstruksioni i objektit te z/Vlentinna Bombaj

Faza e Projektit

Projekt zbatimi

Projektori

Emert Mblener

Firma

Emertimi i projektit

Emertimi i projektit

Emertimi i projektit

Emertimi i projektit

Emertimi i projektit

Emertimi i projektit

Emertimi i projektit

Emertimi i projektit

Emertimi i projektit

Emertimi i projektit

Emertimi i projektit

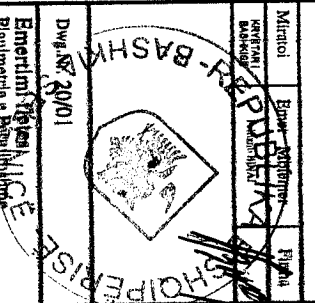

Dwg. Nr. 20/01

Emertimi i projektit

Emertimi i projektit

Emertimi i projektit

Shtylla: A3-140

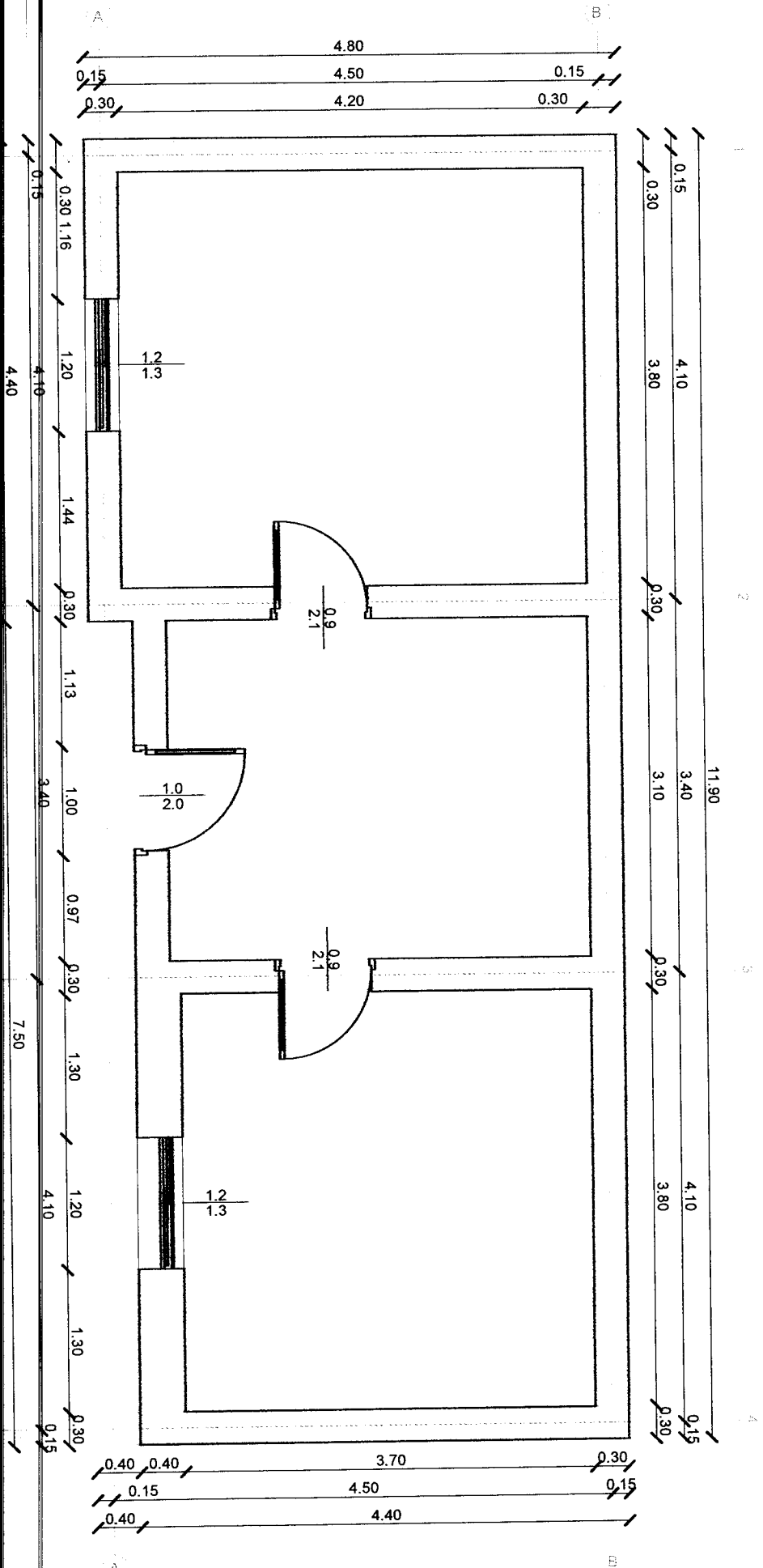

Shtemime

Investitori

BASHKUA SELENIÇE



Emertimi i projektit

Salerica : Rikonstruksion i objektit te 2 Rajonada Kaserit

Faza e Projektit

Projekt zbatimi

Projektori	Enver Mblenari	Etim
Shtab Ndihmës	Krenar BASHKIRI	
Adresë	Forat, Selencia	
Shtab Tregues	Adnan VALLI	

Mirrored: Enver Mblenari, 12.08.2014

INSTITUTI BASHKIRI

BASHKIRI

D/W. Nr. 14/04

Emertimi i fletës: NIVEU

Planimetri e Përqilshme

Shtallat

A3 - 1:50

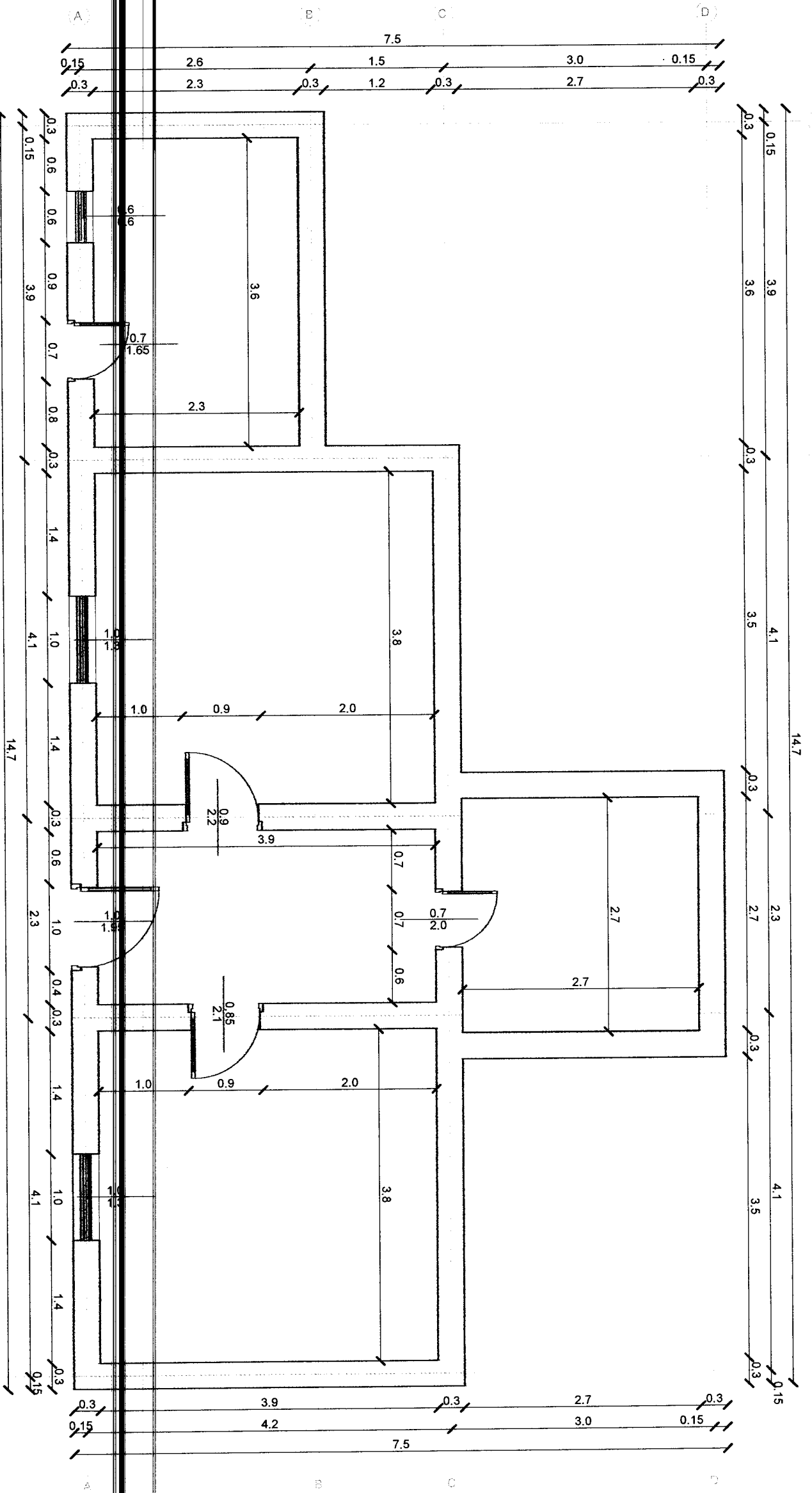

Shenime

Investitori

BASHKIA BELENICE



Emertimi i projektit

Selencia - Rikonstruksioni i objektit te z.Bashkine Seali

Faza e Projektit

Projekt zbatimi

Projektori

Emri Mblener

Adresa

Adresa

Adresa

Adresa

Adresa

Adresa

Adresa

Adresa

Adresa

Adresa

Adresa

Adresa

Adresa

Adresa

Adresa

Adresa

Adresa

Adresa

Adresa

Adresa

Adresa

Adresa

Adresa

Adresa

Adresa

Adresa

Adresa

Adresa

Adresa

Adresa

Adresa

Adresa

Adresa

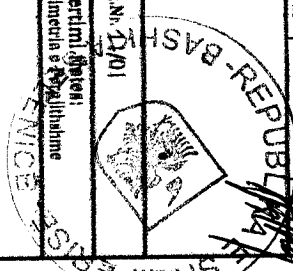

Dwg. Nr. 22/01

Emertimi, shpirti
Planifikimi e Kontrollimi

Shtetli:

A3-1/80

Sherime

Legende:

Investitor
Bashkia Selencia

Emeritimi i projektit
Selencia: Rikonstrukcion per
z.Bashkime Salej

Faza e Projektit
PROJEKT ZBATIM

Planimetria

Projektori Emer Mblomer Firma

Adh. Hendori Sema JONALI
Adh. Tere BASHKILI

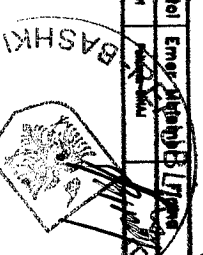

Dwg.Nr. 13/02
Emeritimi i projektit
Detaje Calle

KM/
Shkallori
A3-1:50

Detaj i kulmit te qelise

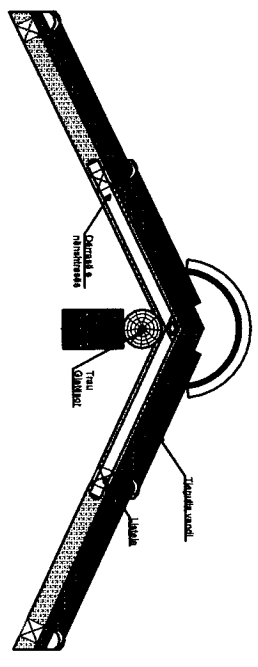

DETAJ I BASHKIMIT NE CEP TE CATISE

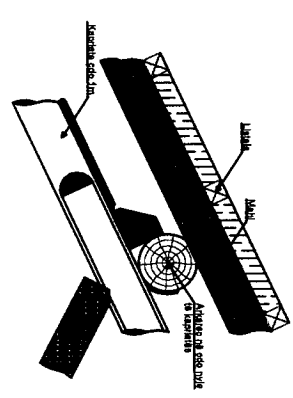

DETAJ I BASHKIMIT NE KULMIN E CATISE

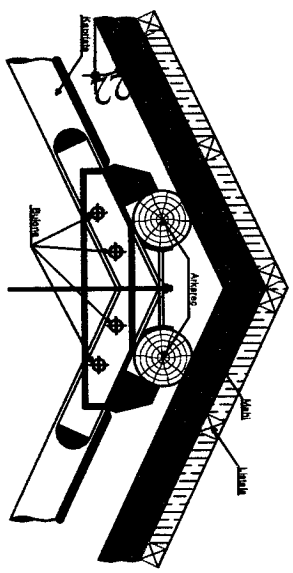

DETAJ I MBULIMIT TE CATISE

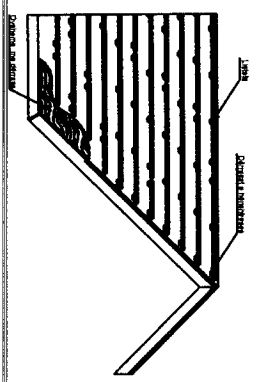

SHENIMET E NEVESHME
1. NIVEU I DETAJIT I KULMIT I CATISE
2. NIVEU I DETAJIT I BASHKIMIT NE CEP TE CATISE
3. NIVEU I DETAJIT I BASHKIMIT NE KULMIN E CATISE
4. NIVEU I DETAJIT I MBULIMIT TE CATISE

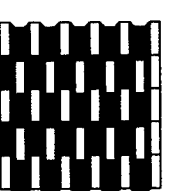

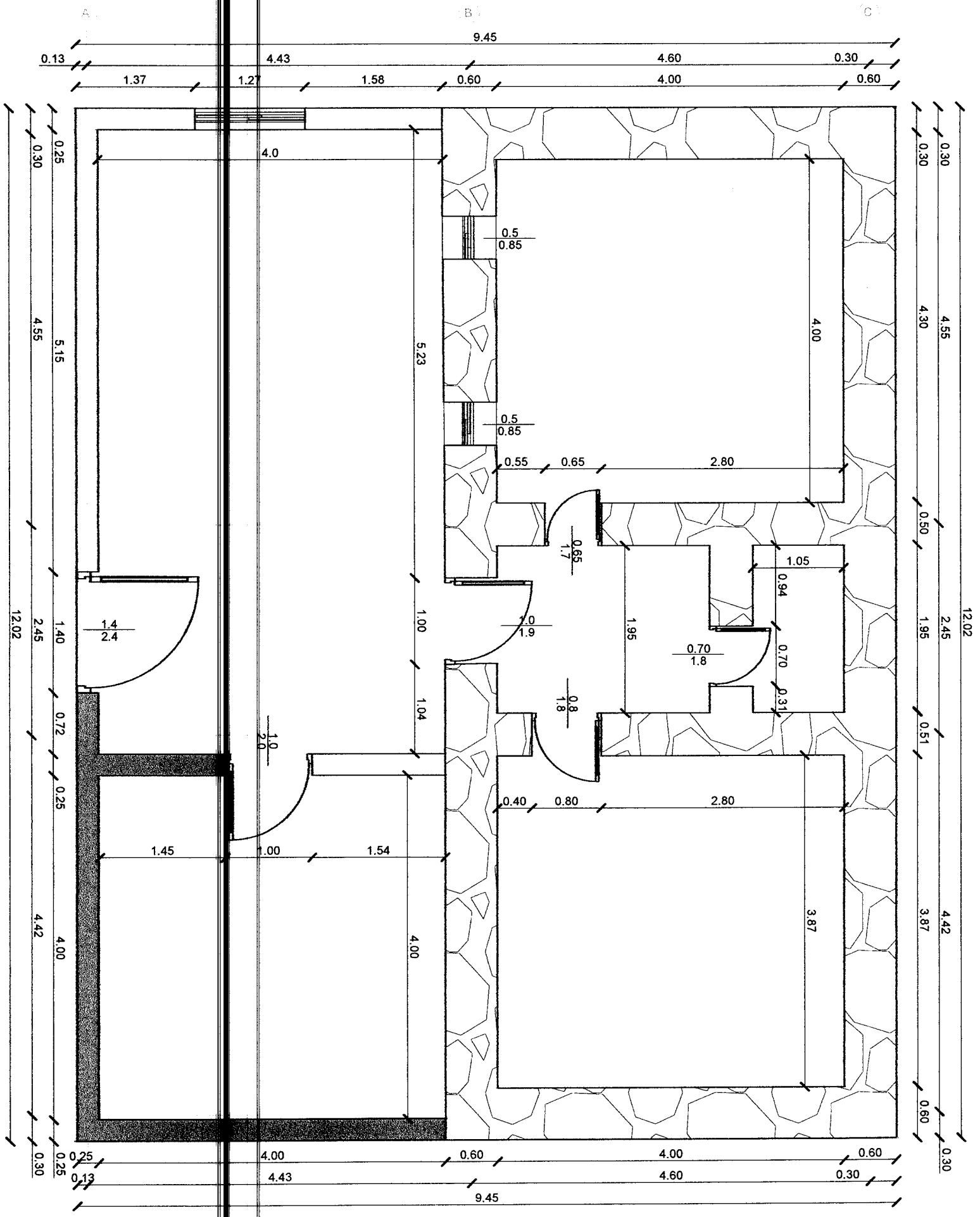

Shtetimi

Investitori

BAHUKIA SELENICE

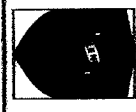

Emertimi i projektit

Brndi : Rikonstruksion i objektit te Jethor Mucoll

Faza e Projektit

Projekt zbatimi

Projektori	Emert Mblamer	Etym
Emert Mblamer	Kren BEHUKIA	

Miratori	Emert Mblamer	Etym
Konstruktivi		

REPUBLIKA E ALBANIJE

DIKONSTRUKSIONI

Emertimi i Etymit

Planimetria e Projektimit

Duke Nr. 05

100

100

100

Shkalja: A3 - 1:80

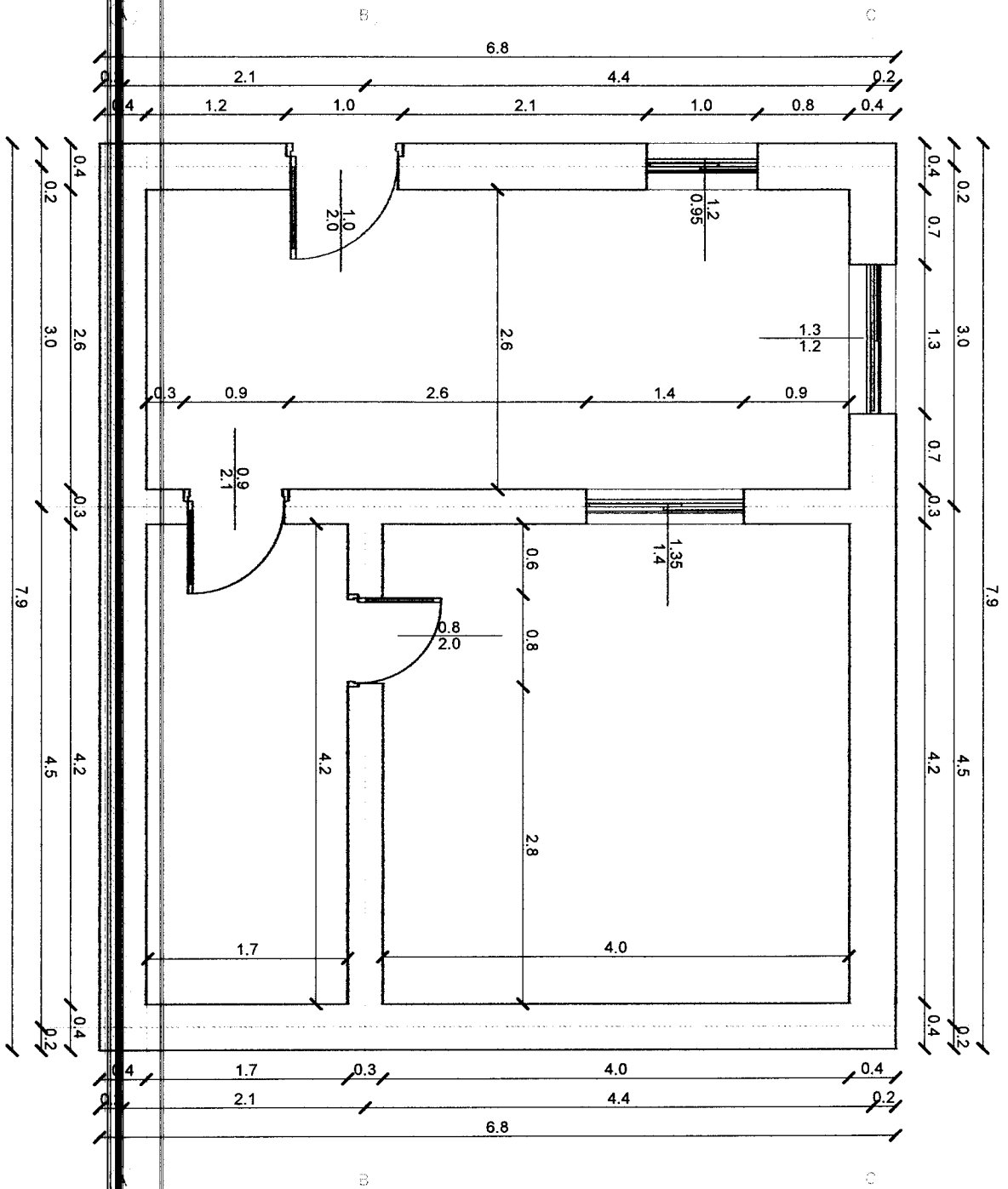

Shtetimi

Investitori

BASHKIA BELENICE



Emertimi i projektit

Rikonstruksioni i objektit te Derrit Hallin

Faza e Projektit

Projekt zbatim

Projektori

Emert. Mblenmer

Emertimi

holl. tekn. shprehje

holl. tekn. shprehje

holl. tekn. shprehje

holl. tekn. shprehje

holl. tekn. shprehje

holl. tekn. shprehje

holl. tekn. shprehje

holl. tekn. shprehje

holl. tekn. shprehje

holl. tekn. shprehje

holl. tekn. shprehje

holl. tekn. shprehje

Dwg. Nr. 09/01

Emertimi i objektit: Pambretoria e Derrit Hallin

SHQIPËRI
MINISTRI I PLANIMIT URBAN DHE BASHKËVITIMIT

Shkalla:

A3 - 1:50

Shenime

Legjende:

Investitor
Bashkia Selenice



Emeritimi i projektit
Picer :Rikonstrukcion per zDemit
Hallit

Faza e Projektit
PROJEKT ZBATIM

Planimetria

Projektori Emer Mblenar Firma
Adi, Tm Miroslav

Mirretol Emer Mblenar Firma
Projektor

Dwg:K/09/08
Emeritimi i tatesit
Detele Catise
KM

Shkallet 1:80

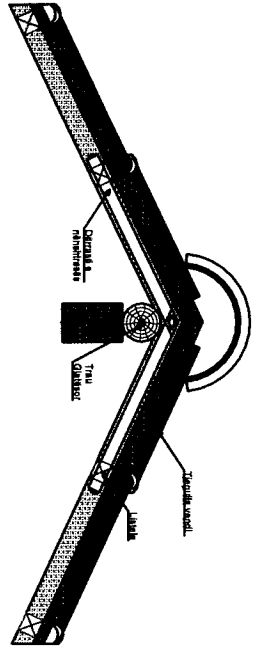

Detaj | Kulmit te catise

DETAJ I BASHKIMIT NE CEP TE CATISE

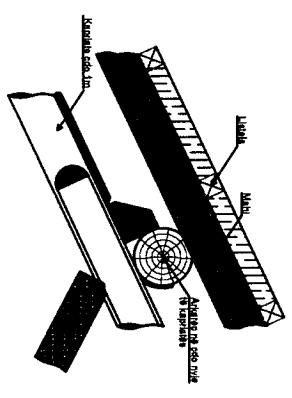

DETAJ I BASHKIMIT NE KULMIN E CATISE

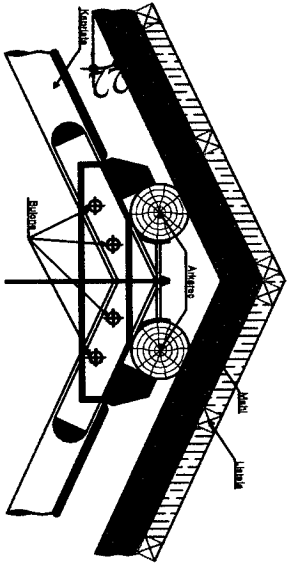

DETAJ I MBULIMIT TE CATISE

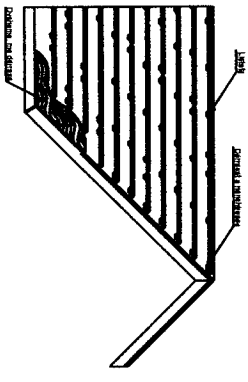

SHENIME
1. NIVELI I DETAJIT ESHTË NE NIVELIN E DETAJIT
2. NIVELI I DETAJIT ESHTË NE NIVELIN E DETAJIT
3. NIVELI I DETAJIT ESHTË NE NIVELIN E DETAJIT

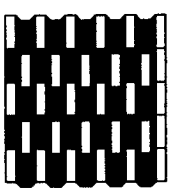

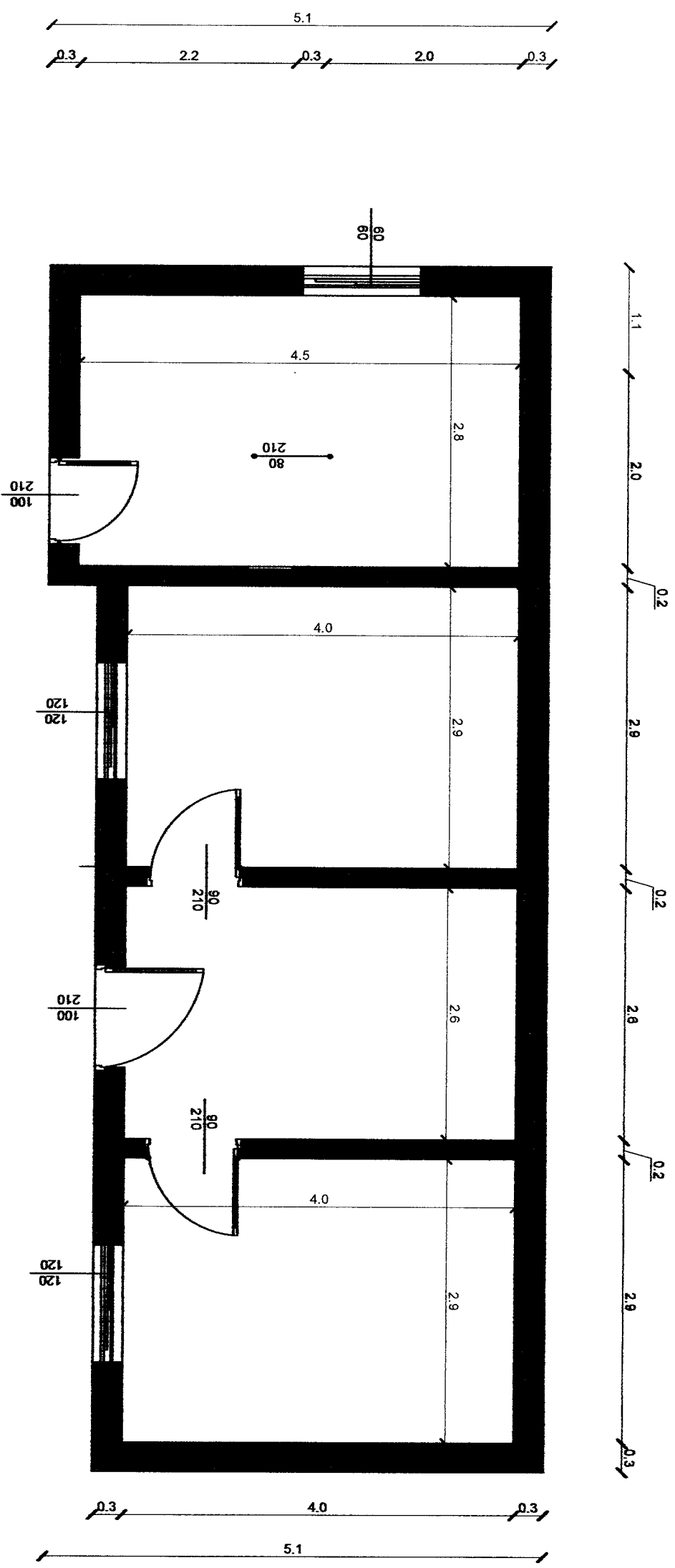

Shenime

Investitori

BASHKIA SELEINCE



Emeritimi i projektit

Armen: Rikonstruksioni i objektit te Admi Ielamaj

Faza e Projektit

Projekt zbatimi

Projektori Emer Mblender Firme

Miratori Emer Mblender Firme



Emeritimi i objektit
Planimetri dhe Regjistrimi

Shkalla: A3 - 1:80

Sherime

Legjende:

Investitor:
Bashkia Selenice

Emergjimi i projektit:
Armeni: Rikonstrukcion per z.Aftim
Islamaj

Faza e Projektit:
PROJEKT ZBATIM

Planimetria

Projektori Emer Mblenzer Firms

Titulli: Armeni

Mirretol: Epaq: Pajonaj: Tyra

Dhjetor/02/02

Emergjimi i jolesari:
Detyra e bashkepunimit ENICCE

KM/

Shkallat:
A3-1:50

Detaj | kulmit te gatise

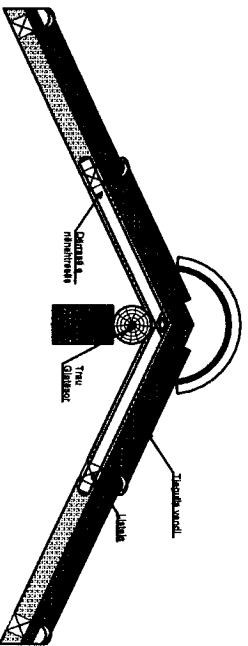

DETAJ I BASHKIMIT NE CEP TE CATISE

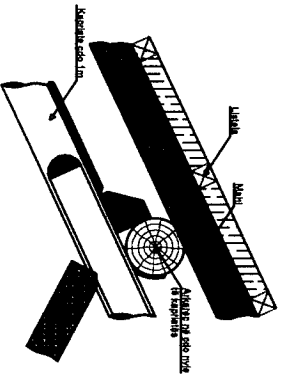

DETAJ I BASHKIMIT NE KULMIN E CATISE

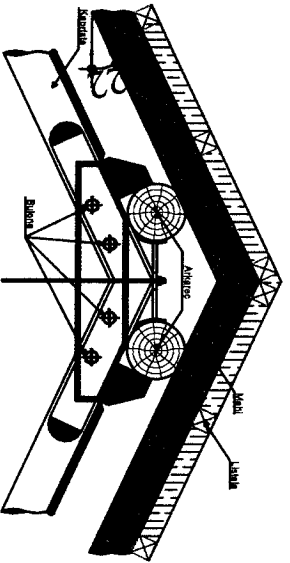

DETAJ I MBULIMIT TE CATISE

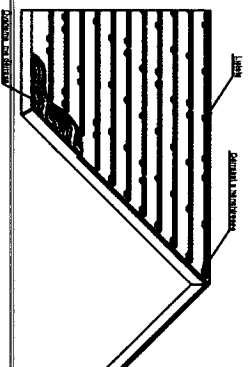

SHKALLA: 1:50
KONSTRUKSIONI: 1:50
LAMA: 1:50
KONSTRUKSIONI: 1:50

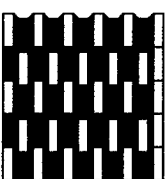

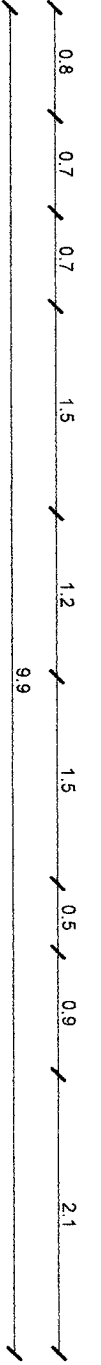
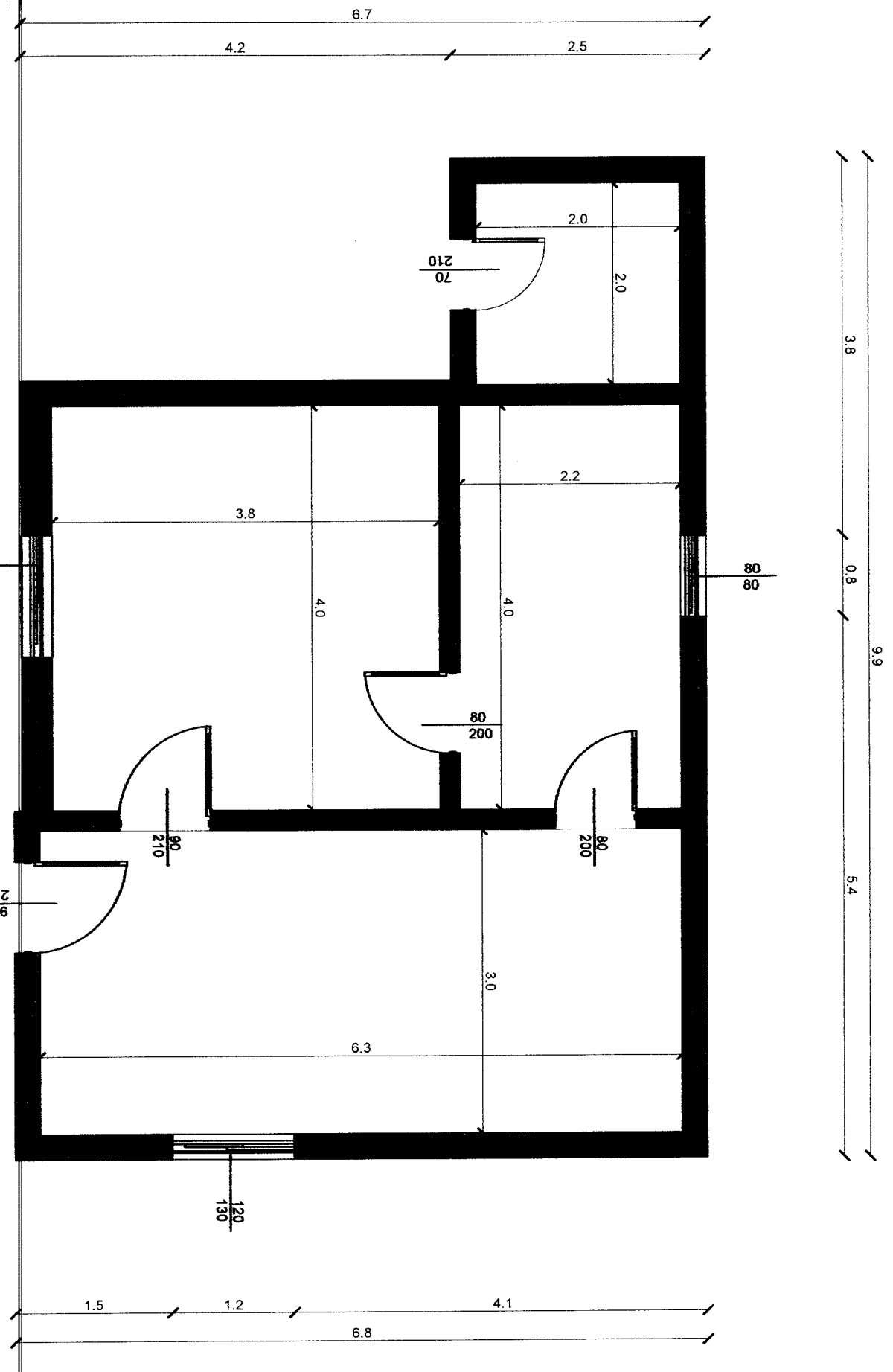

Shtetimi

Investitor:
BASHKIA SHELLENCE



Emertimi i projektit:
 Shënjës Rikonstruksioni i objektit të zënornd
 Xhiesh

Faza e Projektit:
Projekt zbatim

Projektor	Emert Mbledhës	Emert
Dot. Neshir	Erion BERISHA	
Arziani	VESTIURIMAT	

Mirritor	Emert Mbledhës	Emert
Arziani	VESTIURIMAT	

Emertimi i Xhiesh Planimetrija e Përgjithshme
Dwg No: 30/01
Shtetimi: A3 - 1:50

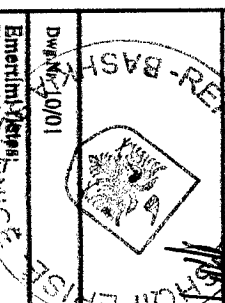

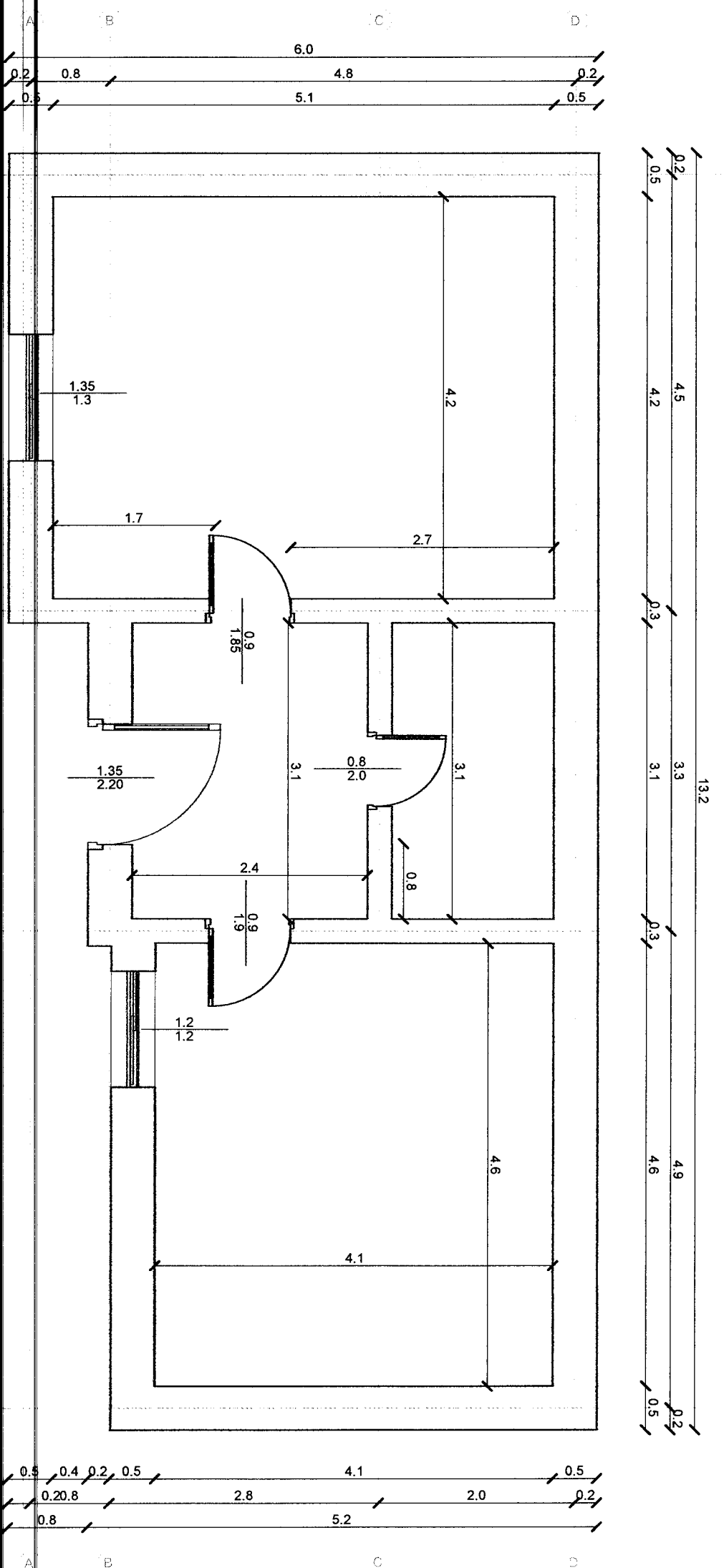

Sherime

Investitori

BASHKIA SELENICE



Emertimi i projektit

Trabllore : Rikonstruksion i objektit te z.Mano Kodriajt

Faza e Projektit

Projekt zbatimi

Projektor

Elmer Mhomer

Shef Mestr

Adite

Te DASHKIA

Figura

Emertimi i bashkise

Emertimi i bashkise

Emertimi i bashkise

Emertimi i bashkise

Emertimi i bashkise

Emertimi i bashkise

Emertimi i bashkise

Emertimi i bashkise

Emertimi i bashkise

Emertimi i bashkise

Emertimi i bashkise

Emertimi i bashkise

Emertimi i bashkise

Emertimi i bashkise

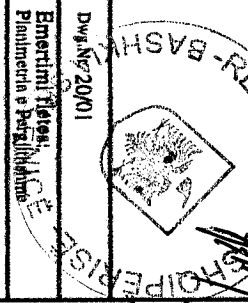

Skalla: A3 - 1:50

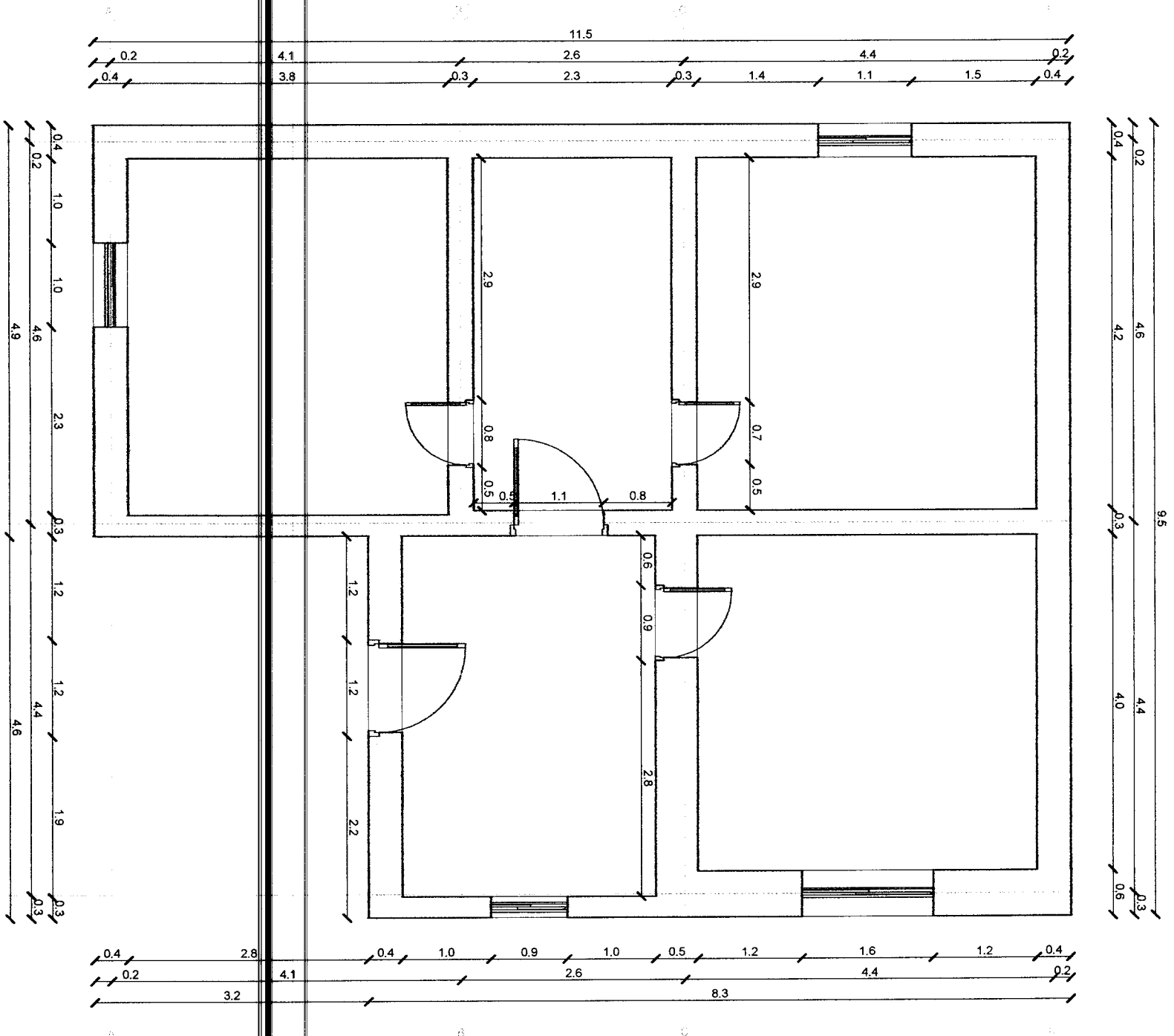

Skenime

Investitor:

BASHKIA SELENICE



Emertimi i projektit:

Selence - Rikonstruksioni i objektit te z.Servet Islamaj

Faza e Projektit:

Projekt zbatimi

Projektori:

Emner Mblenener

Firma:

Adresa:

Te Haxhiu

Mirmonoi	Emner Mblenener	Firma
ORREKTORI	Nilimë SHKAI	

Dita Nr. 17/01
 Bashkia e Selence
 Emertimi i fazei
 Planifikimi e Pergjithshme

Shtylla:

A3-180

654.95
249.00 165.95 240.00
20.00 229.00 20.00 145.95 20.00 200.00 20.00

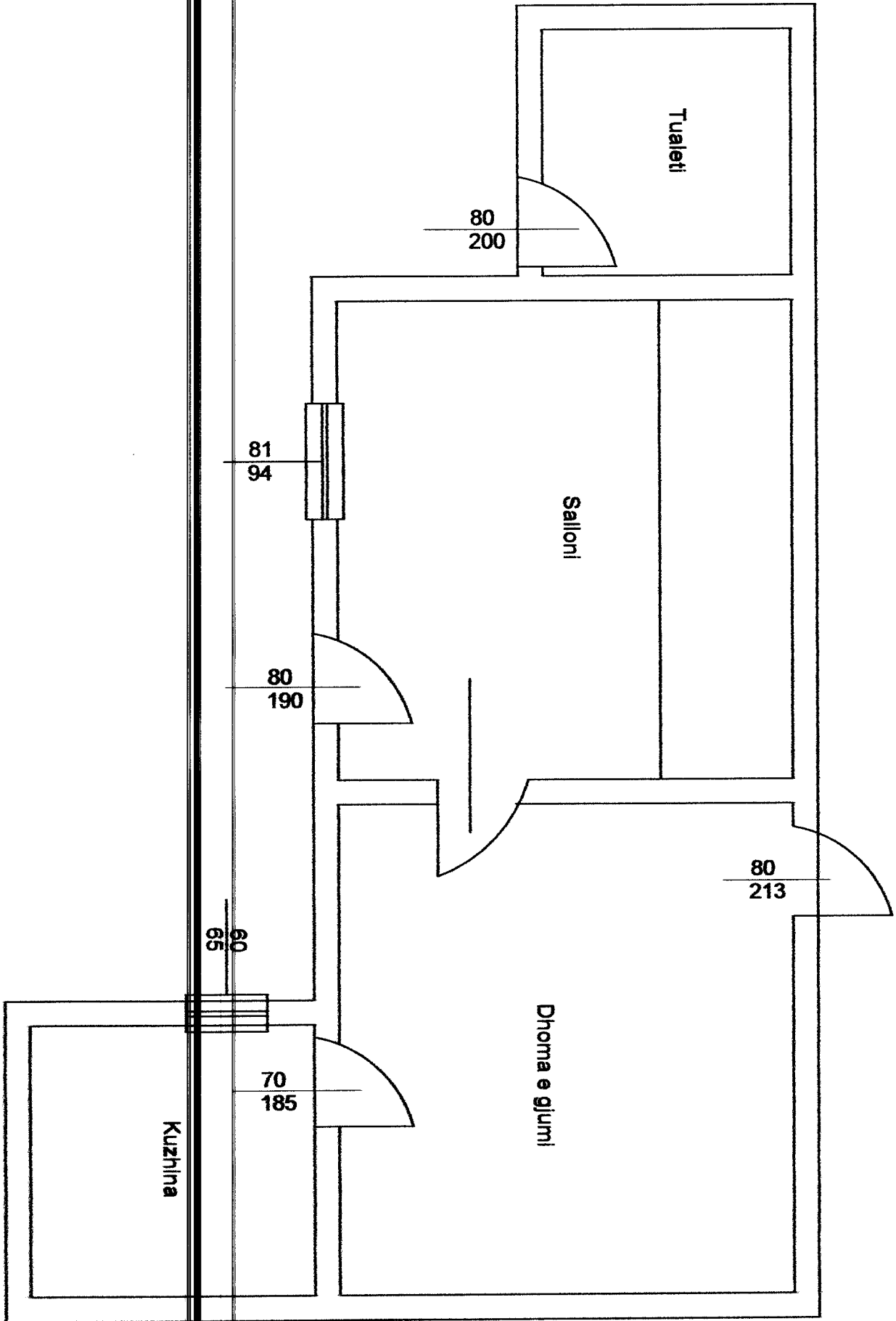

220.00
200.00
130.00
380.00
1089.00
419.00
388.00
20.00

Shtemime

Investitori

BARRKUA BELENICE



Zemërtimi i projektit

Lubërisë : Rikonstrukcioni i objektit të Riza Klusës

Faza e Projektit

Projekt zbatim

Projektori: Enver Mblenzer

Shkollë: Kuvën BISHKAVI

Adresa: TIRANË

Mbledhje: 01/01/2019

Emri: Enver Mblenzer

Titulli: Inxhinier



DWG No: 01

Emertimi i objektit

Planimetria e Përkrahshme

Shkallë:

A3 - 1:40

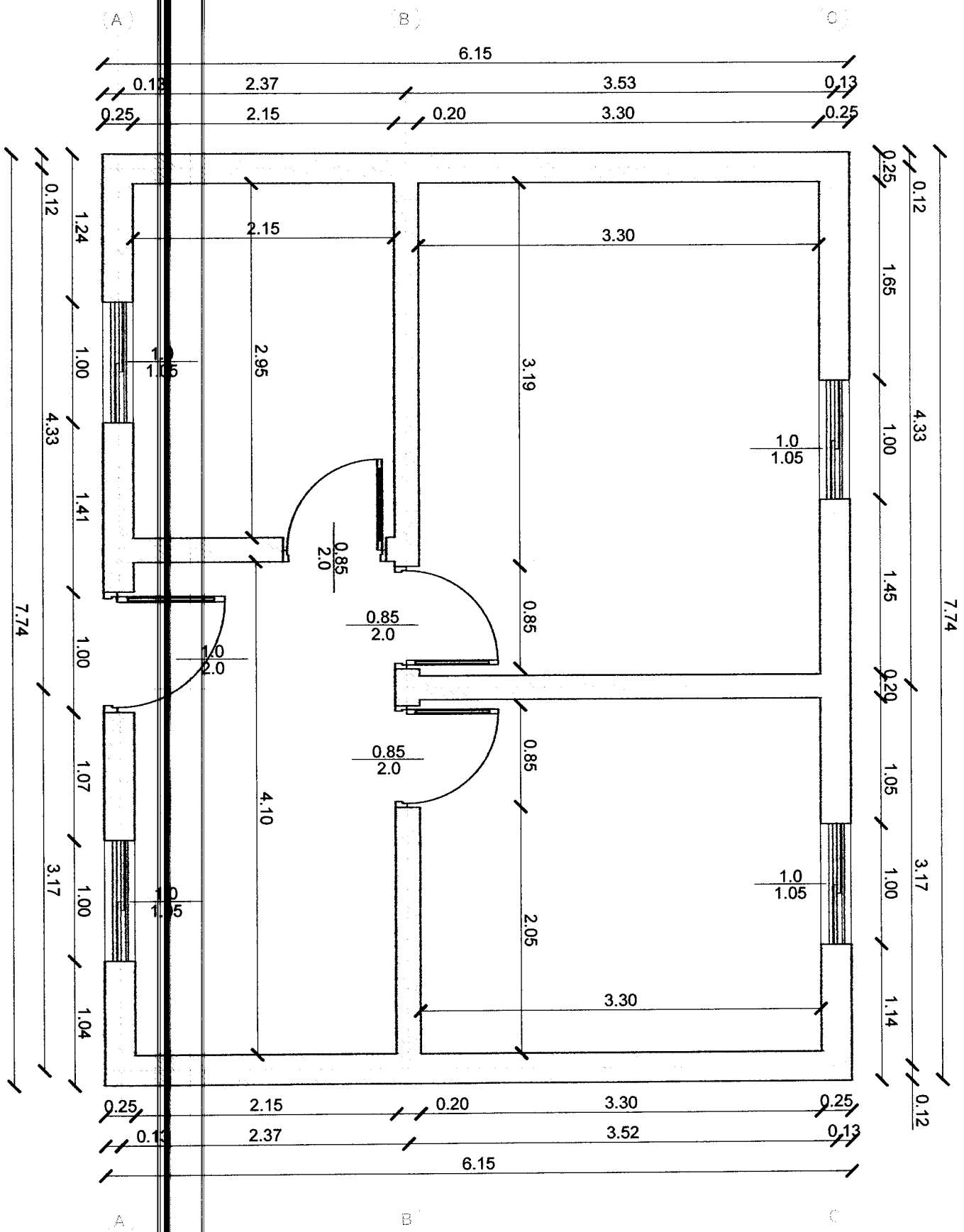

Shenime

Investitori

BASHKIA SELENCE

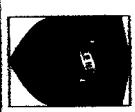

Emertimi I projektit

Pricar: Rikonstruksioni i objektit te 2 Prasho Filial

Faza e Projektit

Projekt zbatimi

Projektor	Emri Mblamer	Figura
Isht. Mblamer	Niveli BIRIMIAI	
Adresa	Te HAKSHKUA	

Mblamer	Emri Mblamer	Figura
Isht. Mblamer	Niveli BIRIMIAI	
Adresa	Te HAKSHKUA	

Dwg. Nr. 04/01

Emertimi i Projektit e Niveli BIRIMIAI

Planimetria e Pergjithshme



Shkalles

A3 - 1:40

Shenime

Legendë:

Investitor
Bashkia Selence

Emeritimi i projektit
Pisat : Rikonstrukcion per z.Pesho
Filaj

Faza e Projektit
PROJEKT ZBATIM

Planimetria

Projektori Emer Mblenar Firma

Adresa: Rruga BASHKIA
Tirane

Mirretol
Emri i Bashkisë së
Tiranesë
Dhuratimi: 08/02
Emeritimi i Bashkisë së
Tiranesë
Detaje Catite
KM
Shkallë: A3 - 1:80

Detaj i kulmit te catise

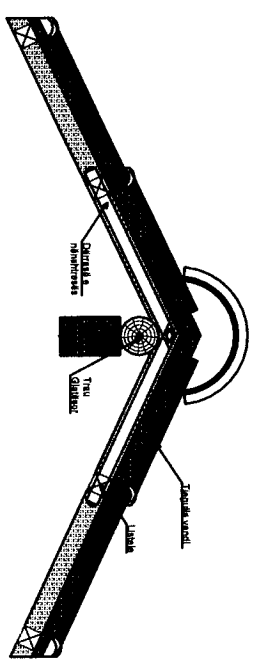

DETAJ I BASHKIMIT NE CEP TE CATISE

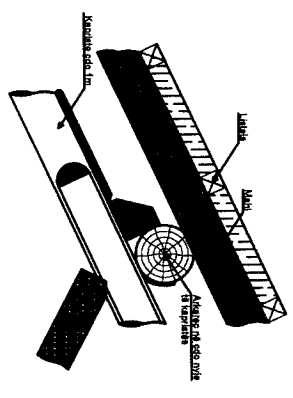

DETAJ I BASHKIMIT NE KULMIN E CATISE

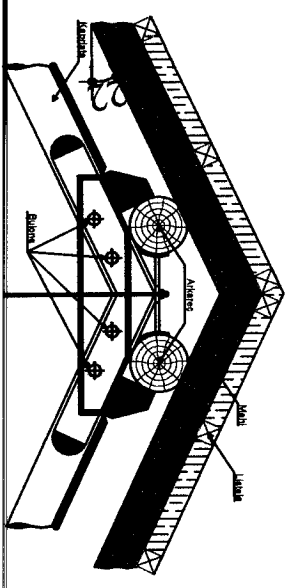

DETAJ I MBULIMIT TE CATISE

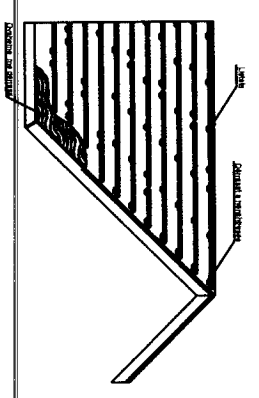

SHENIME TËRTHORJE
1. PËR SHËNIMET E DETAJEVE TË KULMIT, TË ÇEPIT DHE TË MBULIMIT TË CATISESË, SHIHINI DETAJET E PËRSHIUT.
2. DETAJET E KULMIT, TË ÇEPIT DHE TË MBULIMIT TË CATISESË SËNDOJNË NË SHËNIMET E DETAJEVE TË PËRSHIUT.

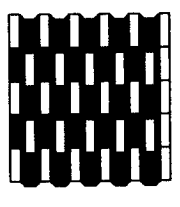

Shenime



BASHKIA BELENICE

Investitori

Emertimi i projektit

Lubonja : Rikonstruksion i objektit te Riza Muste

Faza e Projektit

Projekt zbatimi

Projektol	Emer Mblomer	Firma
Jash, N. Kallit	Novo BUDIMAI	
ALBANI	TRITASHITIA	
Em. Topogor	Agim Vllas	

Mirato	Emri i Miratorit	Firma
	Relatimi BIRAI	



Dwg/No: 05

Emertimi i objektit i
Planimetria e Pergjithshme

Shkali:

A3 - 1:40

