

BASHKIA MIRDITE

PROJEKT - ZBATIMI

*OBJEKTI : "PLOTESIMI I RRJETIT UJITES FSHATI
KODER RRESHEN, LAGJA ZALLI I ZMESE"*

POROSITES:

BASHKIA MIRDITE

PROJEKTUES:

"ANGERBA" SH.P.K.



SHTATOR 2022

HARTA E ZONES

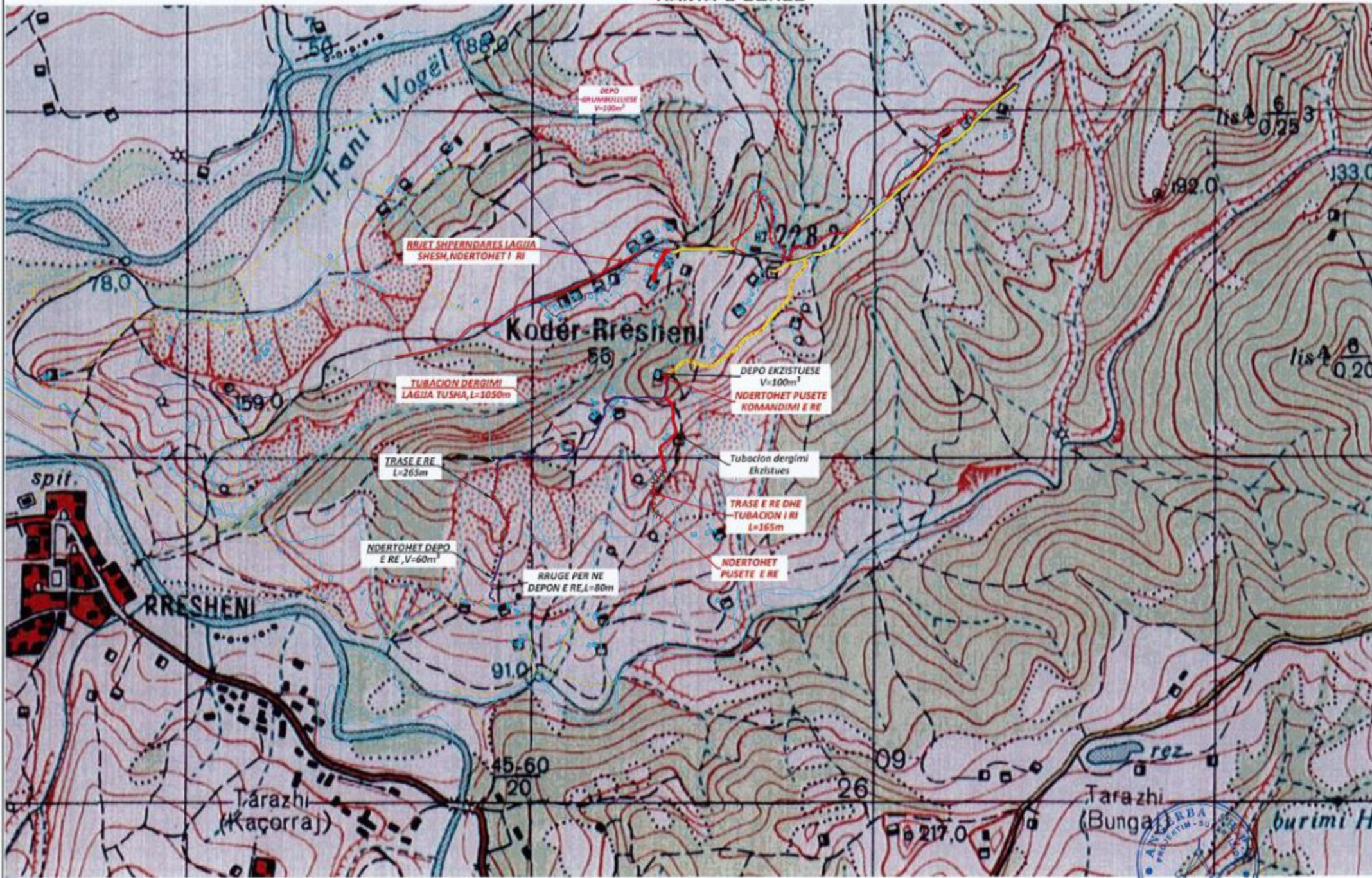

POROSITESI

BASHKIA MIRDITE



"ANGERBA" shpk

Adresa: Rr. "Irfan Tomini" Tiranë.
Cel: 059 20 95 862
E-mail: burhanhafizi@gmail.com

VENDOSURIA
Bashkia Mirdite

TITULLI I PROJEKTTIT

PLOTESIMI I RRJETIT UJITES FSHATI
KODER RRESHEN, LAGJA ZALLI ZMESE"

FAZA E PROJEKTTIT:

PROJEKT ZBATIMI

TITULLI I VIZATIMIT:

HARTA E ZONES

Grupi Projektimit

Ing. Burhan HAFIZI
Ing. Servet VERÇANI
Ing. Gerti HAFIZI



Shkalla 1:10 000

Data: Shtator 2022

FLETA Nr.1

SKEMA E PERGJITHSHME



POROSITESI
BASHKIA MIRDITE



"ANGERBA" shpk
Adresa: Rr. "Irfan Tomini" Tirane.
Cel: 069 20 95 802
E-mail: burhanhafizi@gmail.com

VENDOSJA
Bashkia Mirdite

TITULLI I PROJEKTIT
**PLOTESIMI I RRJETIT UJITES FSHATI
KODER RRESHEN, LAGJA ZALLI ZMESE"**

FAZA E PROJEKTIMIT
PROJEKT ZBATIMI

TITULLI I VIZATIMIT
SKEMA E PERGJITHSHME

Grupi i Projektimit
Ing. Burhan HAFIZI
Ing. Servet VERCANI
Ing. Gerti HAFIZI



Shkalla 1:3 500
Data: Shtator 2022
FLETA Nr. 2

PLANIMETRIA E PERGJITHSHME



<p>POROSITESI</p>	<p>"ANGERBA" shpk</p>	<p>VENDOBRIA <i>Bashkia Mirdite</i></p>	<p>FAZA E PROJEKTIMIT: PROJEKT ZBATIMI</p>	<p>Grupi i Projektimit: Ing. Burhan HAFIZI</p>	<p>Shkalla 1:3 500</p>
<p>BASHKIA MIRDITE</p>	<p>Adresa: Rr. "Irfan Tomini" Tizano. Cel: 069 20 95 862 Email: burhanhafizi@gmail.com</p>	<p>TITULLI I PROJEKTIT: PLOTESIMI I IRRJETIT UJTES FSHATI KODER RRESHEN, LAGJA ZALLI ZMESE"</p>	<p>TITULLI I VEGATIMIT: PLANIMETRIA E PERGJITHSHME LAGJIA TUSHA</p>	<p>Ing. Servet VERÇANI Ing. Gerti HAFIZI</p>	<p>Data: Shtator 2022 FLETA Nr.3</p>

PLANIMETRIA E PERGJITHSHME



POROSITESI
BASHKIA MIRDITE

"ANGERBA" shpk
Adresa: Rr. "Irfan Tomari" Tirane.
Cel: 069 20 95 862
E-mail: burhanhafizi@gmail.com

VENDOSJA
Bashkia Mirdite
TITULLI I PROJEKTI
**FLOTESDMI I RRJETIT UJTES FSHATI
KODER RRESHEN, LAGJA ZALLI ZMESE"**

FAZA E PROJEKTIMIT
PROJEKT ZBATIMI
TITULLI I VIZATIMIT
**PLANIMETRIA E PERGJITHSHME
LAGJGJA TUSHA**

Grupi i Projektimit
Ing. Burhan HAFIZI
Ing. Servet VERÇANI
Ing. Gerti HAFIZI
Skallë 1:1000
Data: Shtator 2022
FLETA Nr.4



PLANIMETRIA E PERGJITHSHME



POROSITESI

BASHKIA MIRDITE



"ANGERBA" shpk

Adresa: Rr. "Iman Tomini" Tirane.
 Cel: 069 20 95 882
 E-mail: burhanhafizi@gmail.com

VENDOSJA

Bashkia Mirdite

TITULLI I PROJEKTI

PLOTESIMI I RRJETIT UJITES FSHATI
 KODER RRESHEN, LAGJA ZALLI ZMESH

FAZA E PROJEKTIMIT

PROJEKT ZBATIMI

TITULLI I VIZATIMIT

PLANIMETRIA E PERGJITHSHME
 LAGJJA TUSHA

Grupi i Projektimit

Ing. Burhan HAFIZI

Ing. Servet VERÇANI

Ing. Gerti HAFIZI

Shkalla 1:1000

Data: Shtator 2022

FLETA Nr.5

PLANIMETRIA E PERGJITHSHME

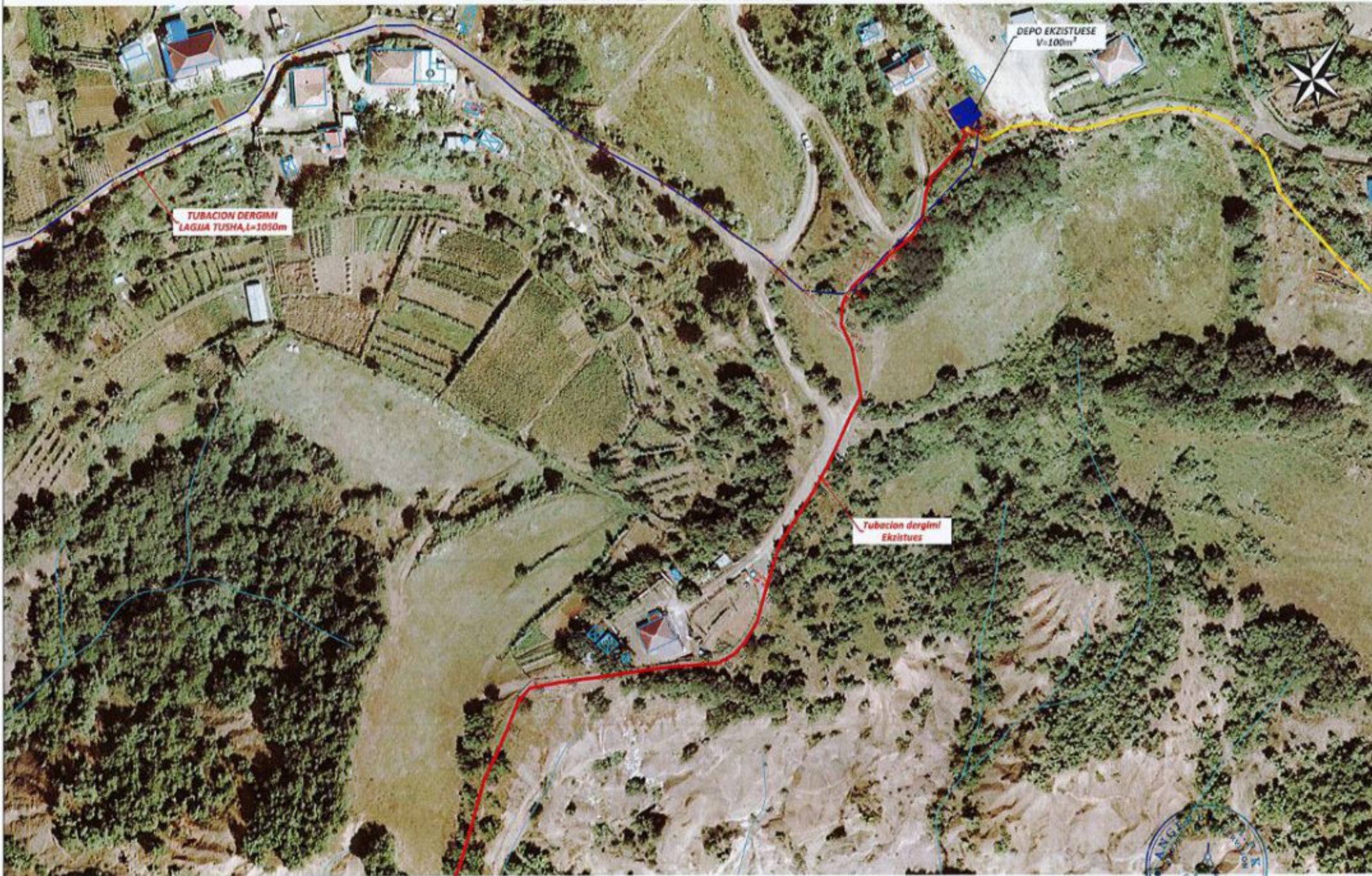

<p>POROSITESI</p>	<p>"ANGERBA" shpk Adresa: Rr. "Irfan Tomini" Tiranë. Cel: 069 20 95 862 E-mail: burhanhafizi@gmail.com</p>	<p>VENDOSURJA <i>Bashkia Mirdite</i></p> <p>TITULLI I PROJEKTI FLOTESIMI I RRJETIT UJITESH FSHATI KODER RRESHEN, LAGJA ZALLI ZMESE"</p>	<p>FAZA E PROJEKTIMIT: PROJEKT ZBATIMI</p> <p>TITULLI I VEZATIMIT: PLANIMETRIA E PERGJITHSHME LAGJIA ZMEJE</p>	<p>Grupi i Projektit Ing. Burhan HAFIZI Ing. Servet VERÇANI Ing. Gerti HAFIZI</p>	<p>Shkalla 1:1000 Data: Shtator 2022 FLETA Nr.6</p>
<p>BASHKIA MIRDITE</p>					

PLANIMETRIA E PERGJITHSHME



POROSITESI
BASHKIA MIRDITE



"ANGERBA" shpk
Adresa: Rr. "Mfan Tomini" Tirane,
Cel: 069 20 95 362
E-mail: burhanhafizi@gmail.com

VENDOSJA
Bashkia Mirdite

TITULLI I PROJEKUT

PLOTESIMI I RRJETIT UJITESH FSHAT
KODER RRESHEN, LAGJIA ZALLI ZMESE"

FAZA E PROJEKUTIMIT:
PROJEKT ZBATIMI

TITULLI I VEZATIMIT:

PLANIMETRIA E PERGJITHSHME
LAGJIA ZMEJE

Grupi i Projektimit
Ing. Burhan HAFIZI
Ing. Servet VERÇANI
Ing. Gerti HAFIZI



Skalla 1:1000
Data: Shtator 2022
FLETA Nr.7

PLANIMETRIA E PERGJITHSHME



<p>POROSITESI</p>	<p>"ANGERBA" shpk Adresa: Rr. "Irfan Tomasi" Tiranë. Cel: 069 20 95 862 E-mail: burhanhafizi@gmail.com</p>	<p>VENDOSHJA Bashkia Mirdite</p> <p>TITULLI I PROJEKTIT PLOTESIMI I RRJETIT UJITES FSHATI KODER RRESHEN, LAGJIA ZALLI ZMESE"</p>	<p>FAZA E PROJEKTIMIT: PROJEKT ZBATIMI</p> <p>TITULLI I UJZATIMIT: PLANIMETRIA E PERGJITHSHME LAGJIA ZMEJE</p>	<p>Grupi i Projektimit: Ing. Burhan HAFIZI Ing. Servet VERÇANI Ing. Gerti HAFIZI</p>	<p>Shkalla 1:1000 Data: Shtator 2022</p>
<p>BASHKIA MIRDITE</p>					<p>FLETA Nr.8</p>

PROFILI GJATESOR, TUBACIONI I DERGIMIT

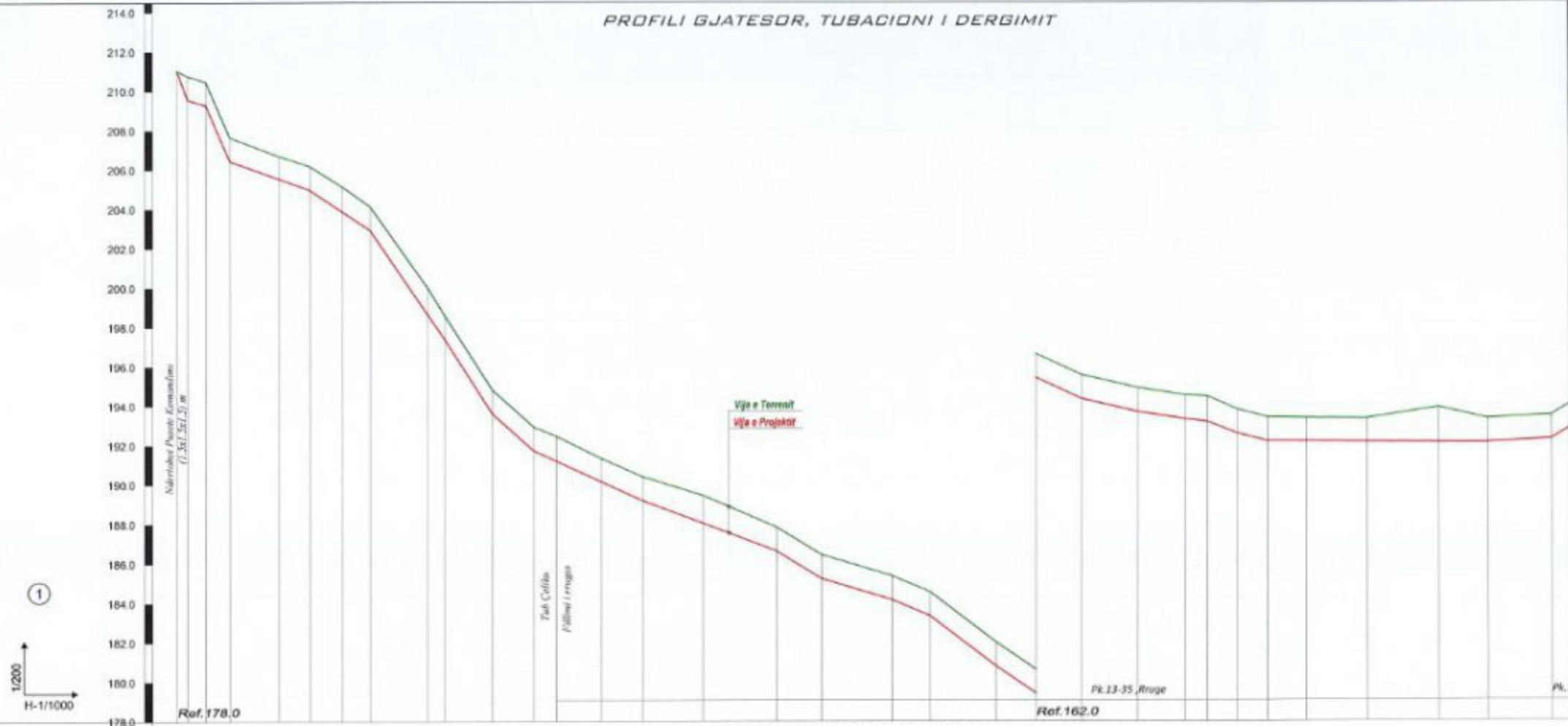

ELEMENTET HIDRAULIK	Tub HDPE 100, RC 1, DN 90, PN 16 Q=10 l/sek, V=2.35 m/sek, h=63.66 m/km																																			
	GERMIM ose MBUSHJE	KUJOTA E PROJEKTI	KUJOTA E TOKES	Nr. PIKETES	DISTANCA PJESORE	DISTANCA PROGRESIVE	KILOMETRAZHI																													
GERMIM ose MBUSHJE	0.00	-1.20	-1.20	-1.20	-1.14	-1.20	-1.26	-1.17	-1.20	-1.39	-1.20	-1.20	-1.20	-1.20	-1.20	-1.20	-1.20	-1.20	-1.20	-1.20	-1.20	-1.20	-1.20	-1.20	-1.20	-1.20	-1.20	-1.20	-1.20	-1.20	-1.20	-1.20	-1.20	-1.20	-1.20	-1.20
KUJOTA E PROJEKTI	211.04	209.56	209.28	208.45	205.56	204.99	203.89	202.54	198.87	197.42	193.60	191.72	190.15	189.20	188.05	186.63	185.24	184.16	183.35	182.01	179.42	178.36	177.60	177.32	177.18	176.60	176.20	175.19	173.33	178.14	175.14	176.12	170.28	170.28	170.28	
KUJOTA E TOKES	211.04	209.56	209.28	208.45	205.56	204.99	203.89	202.54	198.87	197.42	193.60	191.72	190.15	189.20	188.05	186.63	185.24	184.16	183.35	182.01	179.42	178.36	177.60	177.32	177.18	176.60	176.20	175.19	173.33	178.14	175.14	176.12	170.28	170.28	170.28	
Nr. PIKETES	1	2	3	4	5	6	7	8	9	10	11	12	13	14	15	16	17	18	19	20	21	22	23	24	25	26	27	28	29	30	31	32	33	33	33	33
DISTANCA PJESORE	2.74	6.2	12.4	7.9	8.3	7.1	14.7	4.3	12.1	10.5	5.8	11.5	10.5	15.4	18.9	11.4	18.0	9.7	16.8	10.2	11.5	14.4	12.2	5.8	7.8	7.9	10.2	15.6	18.4	12.8	16.4	351.0	351.0	351.0	351.0	
DISTANCA PROGRESIVE	0.0	2.7	7.4	13.5	25.9	33.8	42.1	49.2	63.9	68.2	80.3	90.8	98.6	108.1	118.6	133.9	162.8	164.2	182.2	191.8	208.6	218.8	230.3	244.6	256.9	262.5	270.0	277.9	288.1	303.7	322.1	338.5	351.0	351.0	351.0	351.0
KILOMETRAZHI	0.00						0.05							0.10																						0.25

POROSITESI
BASHKIA MIRDITE



"ANGERBA" shpk
Adresa: Rr. "Irfan Tomari" Tirane,
Cel: 069 20 95 862
E-mail: burhanhafizi@gmail.com

VENDUESHIA
Bashkia Mirdite
TITULLI I PROJEKTI
**PROTESIMI I RRJETIT UJTES FSHATI
KODER RRESHEN, LAGJA ZALLI ZMESE"**

FAZA E PROJEKTIMIT:
PROJEKT ZBATIMI
TITULLI I VIZAZIMIT:
**PROFILI GJATESOR
TUBACIONI I DERGIMIT**

Grupi i Projektimit:
Ing. Burhan HAFIZI
Ing. Servet VERÇANI
Ing. Geri HAFIZI
Shkalla 1:200; 1:1000
Data: Shtator 2022
FLETA Nr.9



PROFILI GJATESOR, TUBACIONI I DERGIMIT

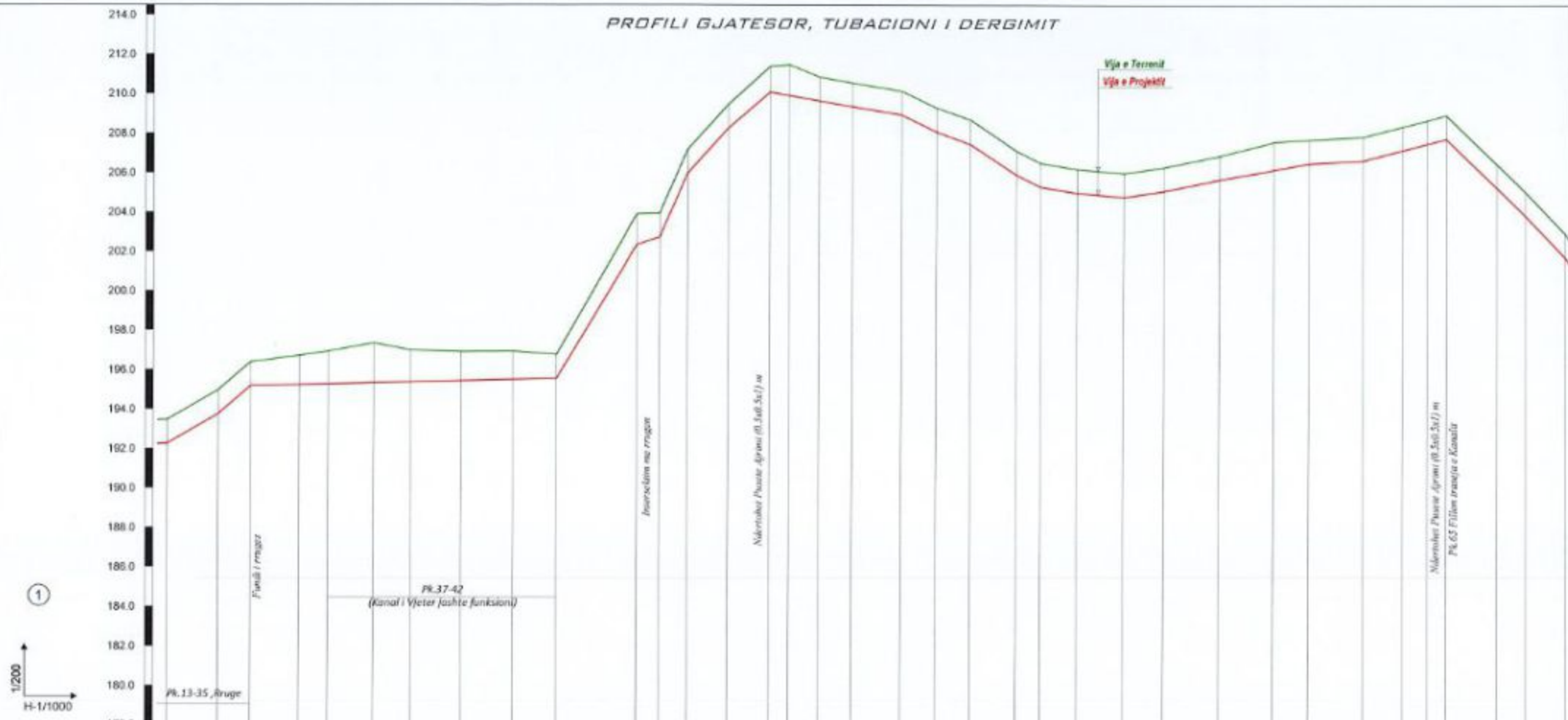

ELEMENTET HIDRAULIK		Tub HDPE 100, RC 1, DN 90, PN 16 Q=10 l/sek, V=2.35 m/sek, h=63.66 m/km	
GERMIM ose MBUSHJE		-1.20	-1.20
KUOTA E PROJEKTI		176.26	177.76
KUOTA E TOKES		177.46	178.96
Nr. PIKETES		33	34
DISTANCA PUESORE		13.0	8.3
DISTANCA PROGRESIVE		361.0	369.3
KILOMETRAZHI		0.35	0.40

POROSITESI
BASHKIA MIRDITE



"ANGERBA" shpk
Adresa: Rr. "Ivan Tomini" Tiranë.
Cel: 069 20 95 862
E-mail: burhanhafizi@gmail.com

VENDEDHORA
Bashkia Mirdite
TITULLI I PROJEKTI
**FLOTESIMI I RRJETIT UJTES FSHATI
KODER KRESHEN, LAGJA ZALLI ZMESE"**

FAZA E PROJEKTIMIT:
PROJEKT ZBATIMI
TITULLI I VIZATIMIT:
**PROFILI GJATESOR
TUBACIONI I DERGIMIT**



Grupi i Projektimit
Ing. Burhan HAFIZI
Ing. Sertver VERÇANI
Ing. Gerti HAFIZI

Shkalta 1:200; 1:1000
Data: Shtator 2022
FLETA Nr.10

PROFILI GJATESOR, TUBACIONI I DERGIMIT

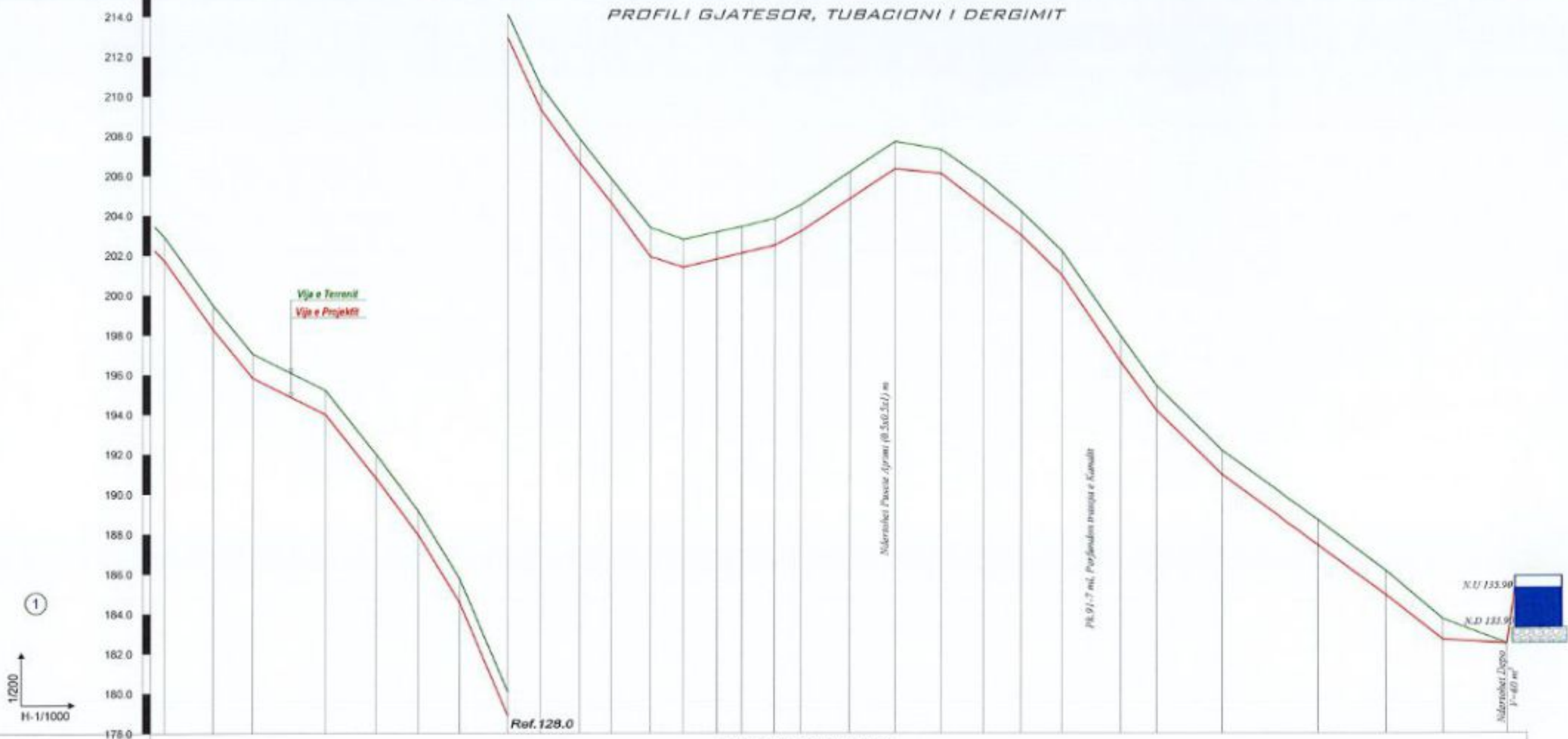

ELEMENTET HIDRAULIK
Tub HDPE 100, RC 1, DN 90, PN 16
 $Q=10 \text{ l/sek}, V=2.35 \text{ m/sek}, h=63.66 \text{ m/km}$

GERMIM ose MBUSHJE	-1.20	-1.20	-1.20	-1.20	-1.20	-1.20	-1.20	-1.20	-1.20	-1.20	-1.20	-1.20	-1.45	-1.40	-1.36	-1.32	-1.34	-1.32	-1.34	-1.36	-1.20	-1.35	-1.20	-1.20	-1.30	-1.23	-1.20	-1.25	-1.03	0.00
KUOTA E PROJEKTTIT	185.72	182.28	179.85	176.02	174.79	171.97	168.55	162.50	159.30	156.62	154.64	151.50	151.39	151.80	152.11	152.50	153.19	154.83	156.34	156.11	154.48	153.01	151.52	148.81	144.20	140.89	137.46	134.95	132.70	132.50
KUOTA E TOKES	186.92	183.48	181.05	179.22	175.99	173.17	169.75	164.10	160.50	157.82	155.84	153.38	152.79	153.16	153.43	153.84	154.81	156.17	157.70	157.31	155.83	154.21	152.22	147.81	145.43	142.19	138.71	136.15	133.73	132.50
Nr. PIKETES	68	69	70	71	72	73	74	75	76	77	78	79	80	81	82	83	84	85	86	87	88	89	90	91	92	93	94	95	96	97
DISTANCA P.JESORE		12.2	10.0	18.3	12.8	10.5	10.6	12.1	8.3	9.8	7.8	9.9	8.3	8.5	0.2	8.2	6.6	12.4	11.5	11.5	10.6	9.6	10.2	15.0	9.0	16.5	24.5		16.1	
DISTANCA PROGRESIVE	707.9	720.1	730.1	748.4	761.2	771.7	782.3	794.4	802.6	812.4	820.2	830.1	838.4	846.9	853.1	861.3	867.9	880.3	891.8	903.3	913.9	923.4	933.6	946.6	967.6	974.1	998.6	1014.9	1046.5	
KILOMETRAZHI	0	0.75		0.80			0.85		0.90		0.95																			

POROSITESI	BASHKIA MIRDITE	 "ANGERBA" shpk Adrese: Rr. "Irfan Tomini" Tirane. Cel: 069 20 95 852 E-mail: burhanhafizi@gmail.com	VENDORRIA: Bashkia Mirdite TITULLI I PROJEKTTIT: PLOTESIMI I RRJETIT UJITES FSHATI KODER RRRESHEN, LAGJA ZALLI ZMESE"	FAZA E PROJEKTTIMIT: PROJEKT ZBATIMI TITULLI I VIZATIMIT: PROFILI GJATESOR TUBACIONI I DERGIMIT	Grupi i Projektimit: Ing. Burhan HAFIZI Ing. Servet VERÇANI Ing. Gerti HAFIZI	Shkalla 1:200; 1:1000 Data: Shtator 2022 FLETA Nr.11
-------------------	------------------------	---	---	--	--	--

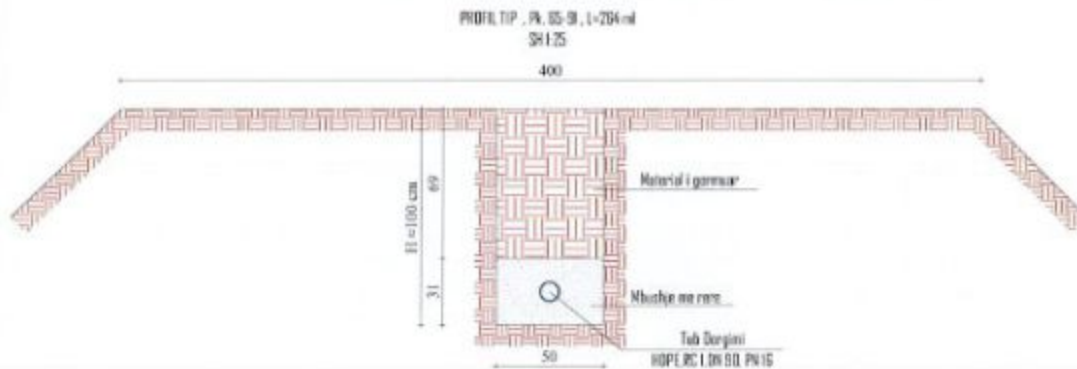
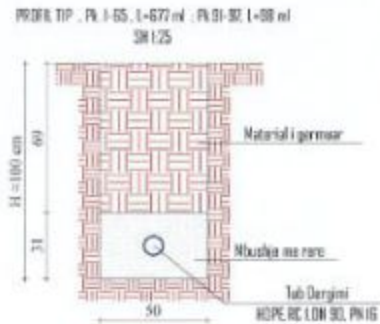

VOLUMET E GERMIMEVE					
Nr	Siperfaqe	Siperfaqe Mesatare	D.Pjesore	V.Pjesor	V.Progresiv (m³)
1	0.048				
2	0.00	0.02	12.61	0.30	0.30
3	0.20	0.10	7.39	0.74	1.04
4	2.13	1.17	10.00	11.65	12.69
5	5.62	3.88	11.72	45.42	58.11
6	4.18	4.90	9.69	47.48	105.59
7	2.03	3.11	18.34	56.95	162.53
8	0.66	1.35	12.41	16.69	179.22
9	2.85	1.76	10.04	17.62	196.84
10	7.13	4.99	10.17	50.75	247.59
11	3.51	5.32	10.72	57.03	304.62
12	5.82	4.67	7.38	34.43	339.05
13	5.43	5.63	9.40	52.88	391.93
14	5.13	5.28	7.64	40.34	432.27
15	2.57	3.85	9.56	36.81	469.07
16	2.68	2.63	8.26	21.68	490.75
17	6.60	4.64	8.46	39.25	530.01
18	5.98	6.29	6.21	39.06	569.07
19	6.00	5.99	8.15	48.82	617.89
20	3.75	4.88	6.77	33.00	650.89
21	11.74	7.75	12.05	93.33	744.22
22	4.13	7.94	11.40	90.46	834.68
23	3.97	4.05	11.63	47.10	881.78
24	1.54	2.76	10.72	29.53	911.31
25	4.88	3.21	9.28	29.79	941.10
26	1.15	3.02	10.00	30.15	971.25
27	1.46	1.31	14.40	18.79	990.04
			264.40	990.04	

POROSITESI

BASHKIA MIRDITE



"ANGERBA" shpk

Adresa: Rr. "Irfan Tomini" Tirane.
Coi: 069 20 95 862
E-mail: burhanhafizi@gmail.com

VENDOBORJA
Bashkia Mirdite

TITULLI I PROJEKTT

PLOTESIMI I RRJETIT UJTES FSHATI
KODER RRESHEN, LAGJA ZALLI ZMESH

FAZA I PROJEKTIMIT:

PROJEKT ZBATIMI

TITULLI I VEZATIMIT:

SEKSIONET TIP
TUBACIONI I DERGIMIT

Grupi i Projektimit

Ing. Burhan HAFIZI

Ing. Servet VERÇANI

Ing. Gerti HAFIZI



Shkalla 1:25

Data: Shtator 2022

FLETA Nr.12

PROFLET TERTHORE

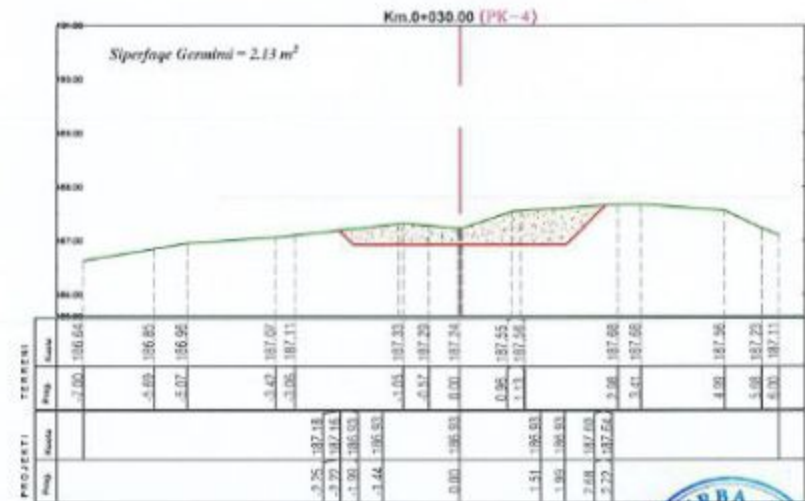
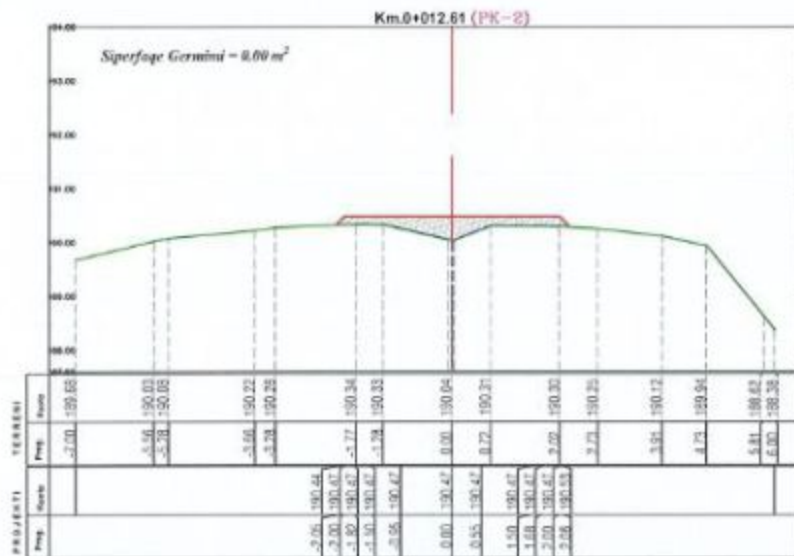
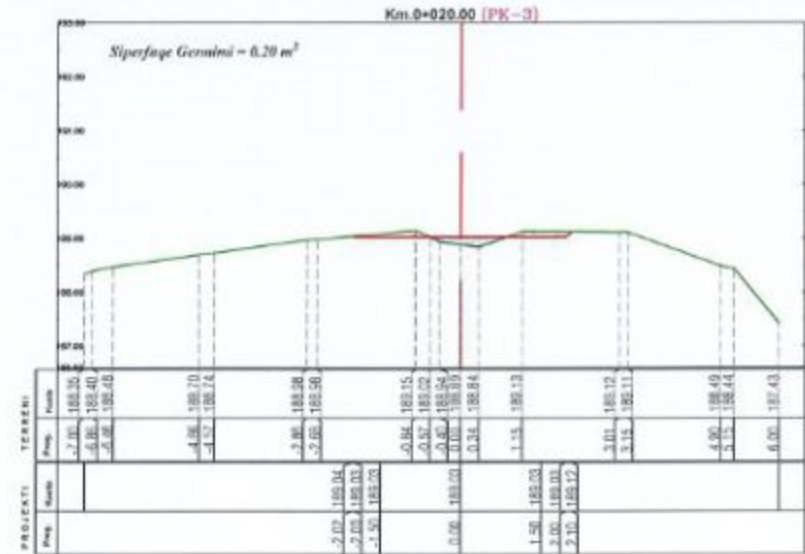
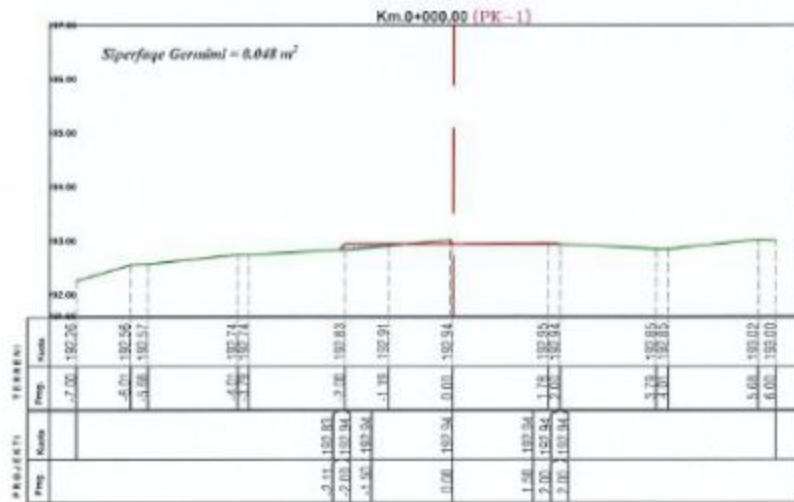

POROSITESI

BASHKIA MIRDITE



"ANGERBA" shpk

Adresa: Rr. "Irfan Tomiel" Tiranë.
Cel: 069 20 95 882
E-mail: burhanhafizi@gmail.com

VENDIMORJA

Bashkia Mirdite

TITULLI I PROJEKTI

PLOTESIMI I RRJETIT UJITES FSHATI
KODER RRESHEN, LAGJA ZALLI ZMESE"

FAZAT E PROJEKTIMIT:

PROJEKT ZBATIMI

TITULLI I VIZATIMIT:

PROFLET TERTHORE
TE TRASESE

Grupi i Projektimit:

Ing. Burhan HAFIZI
Ing. Servet VERÇANI
Ing. Gerti HAFIZI

Shkalla 1:100

Data: Shtator 2022

FLETA Nr.13



PROFLET TERTHORE

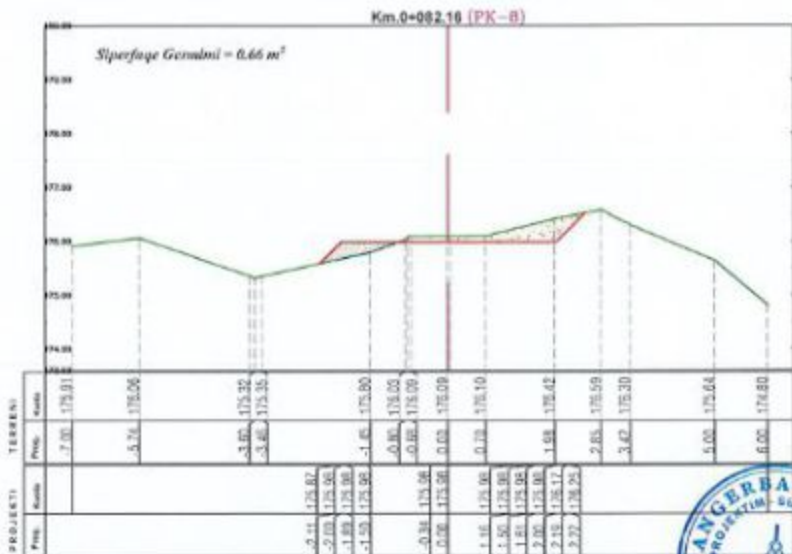
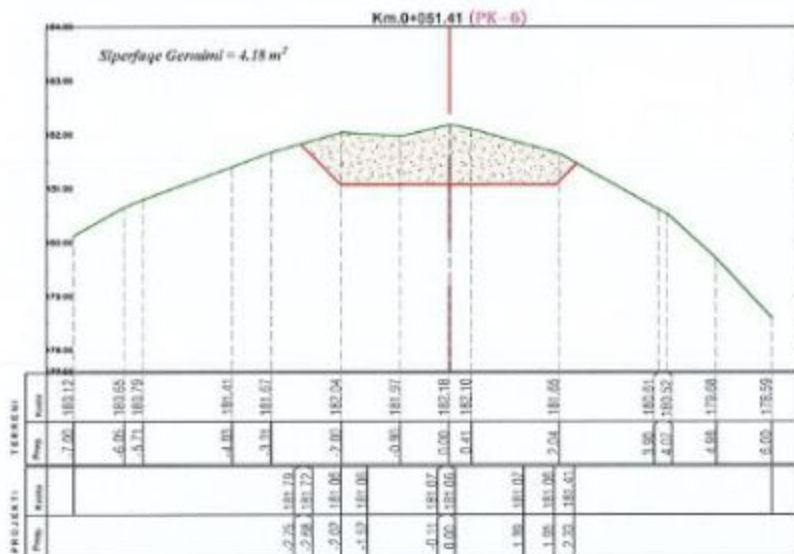
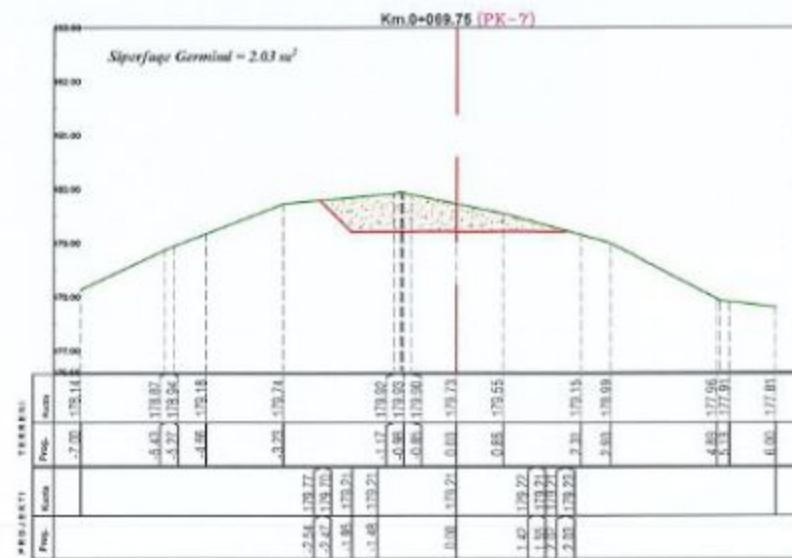
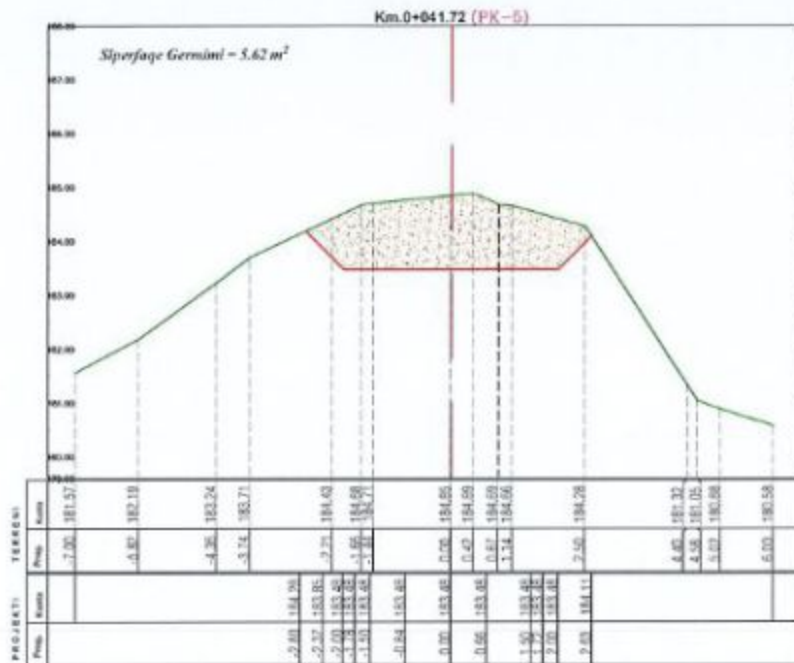

POROSITESI

BASHKIA MIRDITE



"ANGERBA" shpk

Adresa: Rr. "Jovan Tomasi" Tiranë
 Cel: 060 20 95 962
 E-mail: buwhenhafizi@gmail.com

VENDOSHJA

Bashkia Mirdite

TITULLI I PROJEKTI

PLOTESIMI I RRJETIT UJTES FSHATI
 KODER RRESHEN, LAGJA ZALLI ZMUSE"

FAZA E PROJEKTIMIT

PROJEKT ZBATIMI

TITULLI I VIZATIMIT

PROFLET TERTHORE
 TE TRASESE

Grupi i Projektimit

Ing. Burhan HAFIZI
 Ing. Servet VERÇANI
 Ing. Gerti HAFIZI



Shkalla 1:100

Data: Shtator 2022

FLETA Nr.14

PROFLET TERTHORE

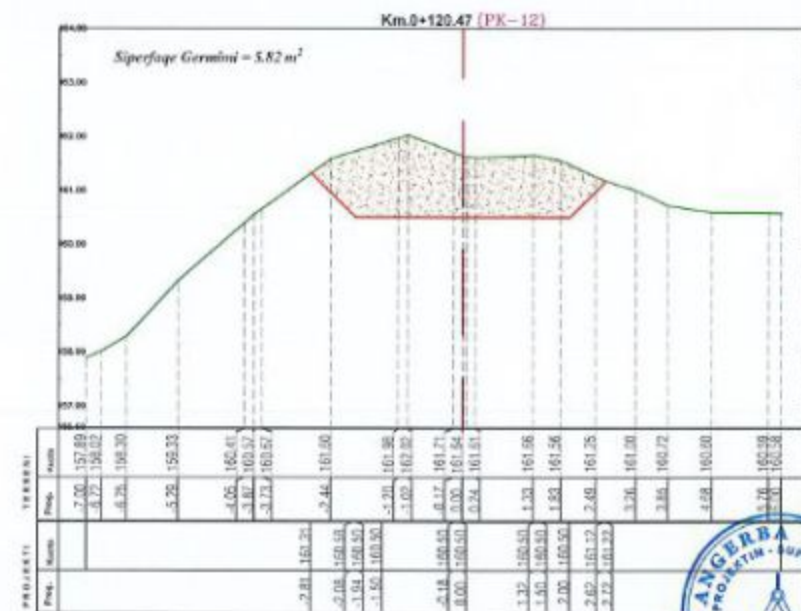
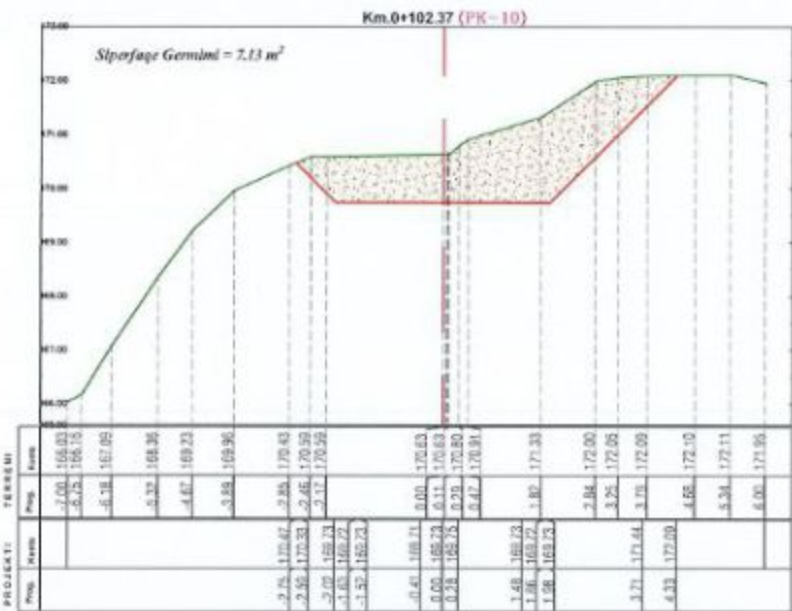
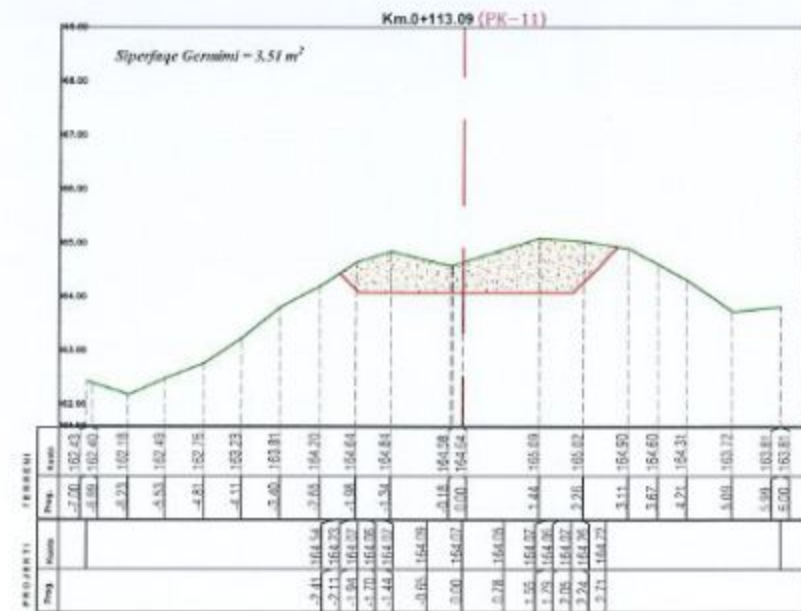
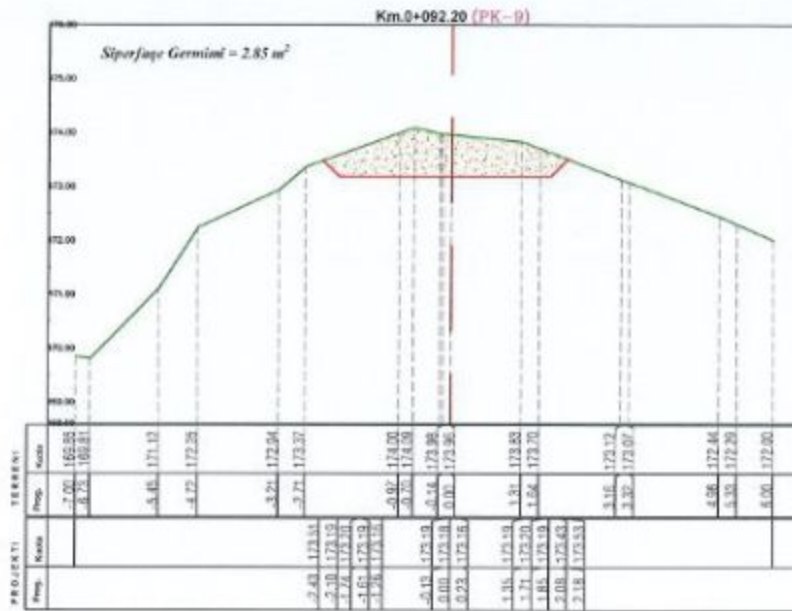

POROSITESI

BASHKIA MIRDITE



"ANGERBA" shpk

Adresa: Rr. "Jefan Tomini" Tirane.
Cel: 969 20 95 962
E-mail: burhanhazizi@gmail.com

VENDOSJA

Bashkia Mirdite

TITULLI I PROJEKTI

FLOTESIMI I RRJETIT UJTES FSHATI
KODER RRESHEN, LAGJA ZALLI ZMESH

FAZA E PROJEKTIMIT

PROJEKT ZBATIMI

TITULLI I VIZATIMIT

PROFLET TERTHORE
TE TRASESE

Grupi i Projektimit

Ing. Burhan HAFIZI
Ing. Servet VERÇANI
Ing. Gerti HAFIZI



Shkalla 1:100

Data: Shtator 2022

FLETA Nr.15

PROFILE TERTHORE

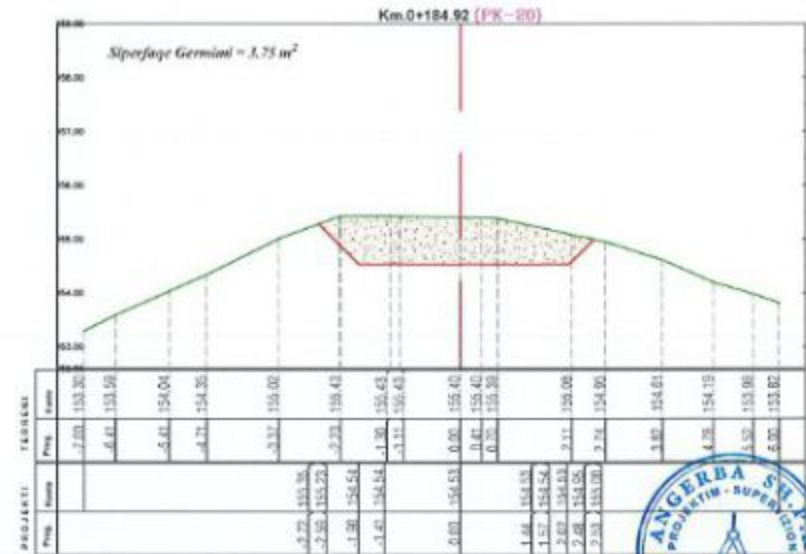
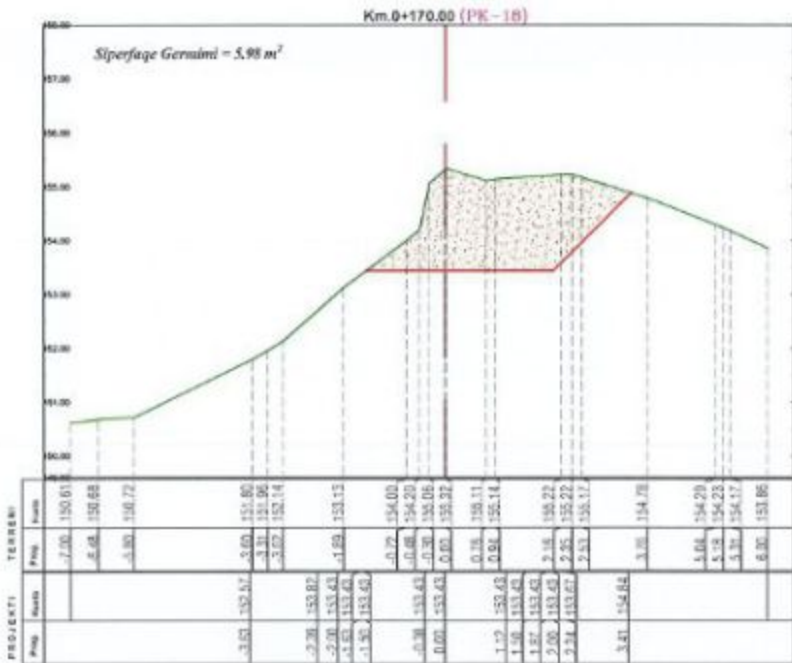
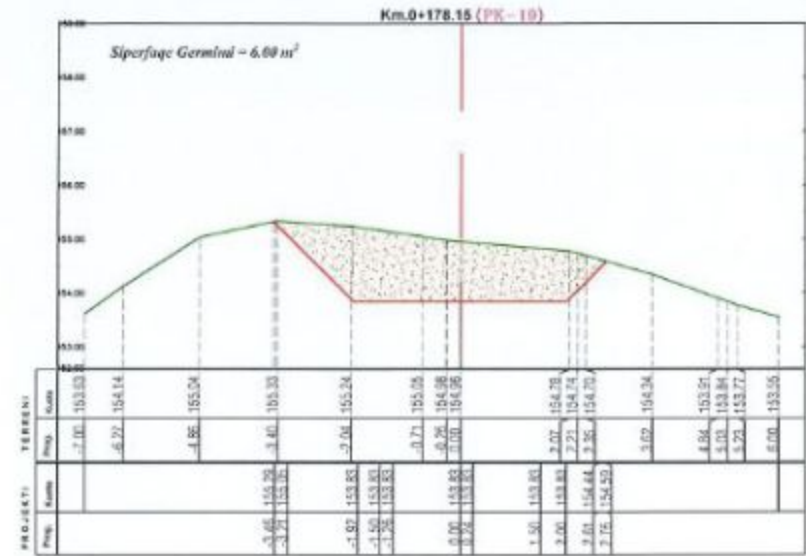
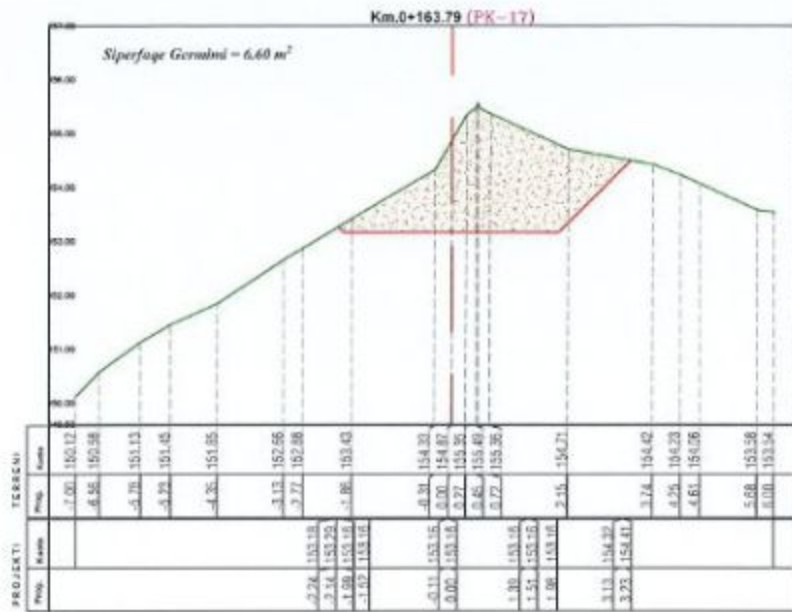

POROSITESI

BASHKIA MIRDITE



"ANGERBA" shpk

Adresa: Rr. "Irfan Tomasi" Tirane.
 Cel: 069 20 93 862
 E-mail: burhanhafizi@gmail.com

VENDOSURIA

Bashkia Mirdite

TITULLI I PROJEKTI

PLOTESIMI I RRJETIT UJYES FSHATI
 KODER RRESHEN, LAGJA ZALLI ZMESH

FAZAT E PROJEKTIMIT

PROJEKT ZBATIMI

TITULLI I VIZATIMIT

PROFILE TERTHORE
 TE TRASESE

Grupi i Projektimit:

Ing. Burhan HAFIZI
 Ing. Servet VERÇANI
 Ing. Gerti HAFIZI



Skala 1:100

Data: Shtator 2022

FLETA Nr.17

PROFLET TERTHORE

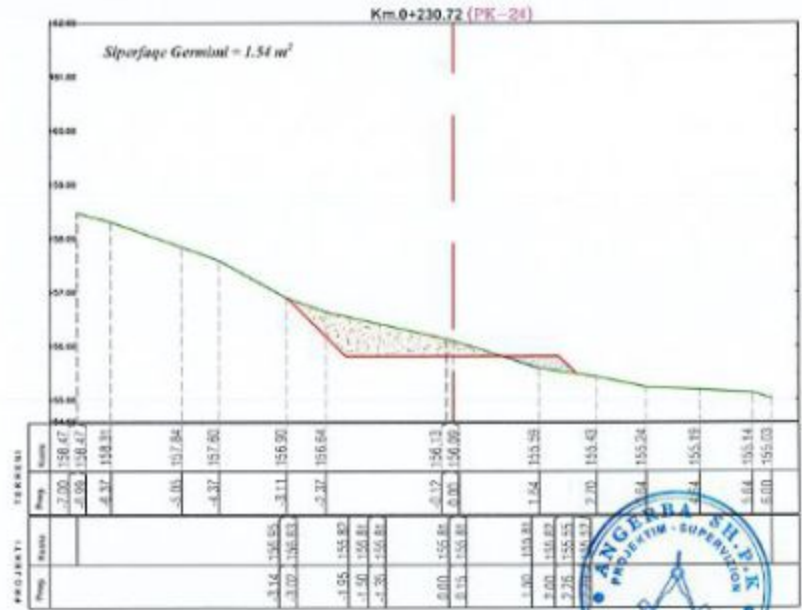
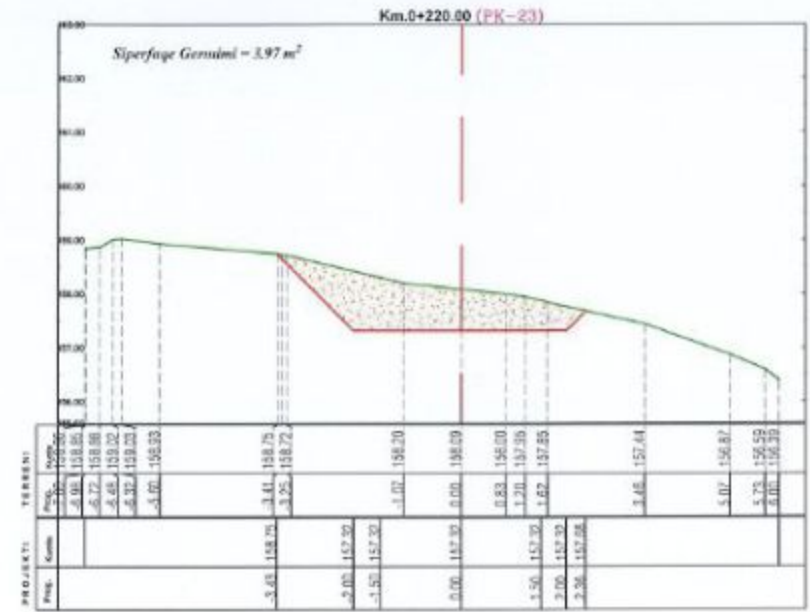
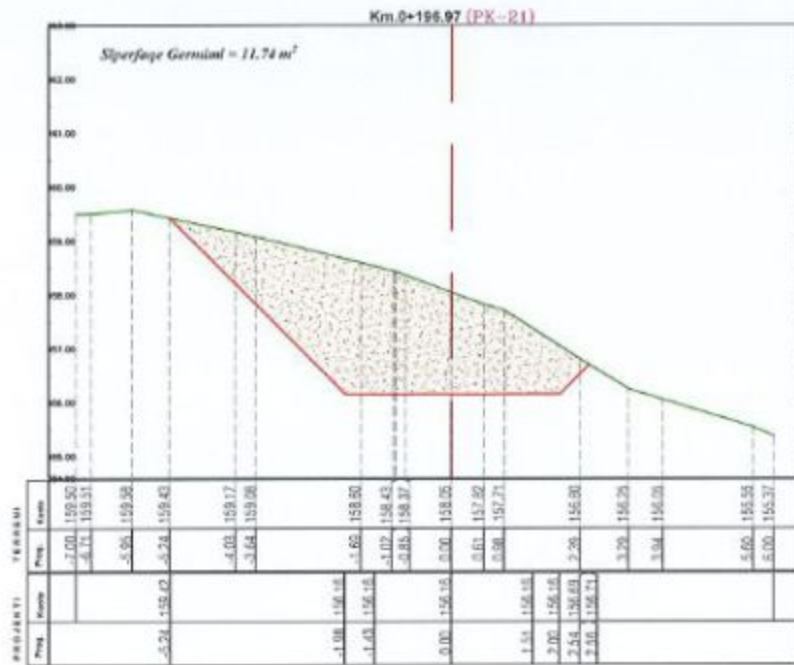

POROSITESI

BASHKIA MIRDITE

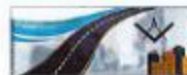

"ANGERBA" shpk

Adresa: Rr. "Irfan Tomian" Tërnane.
Cel: 049 20 95 892
E-mail: burhanhafizi@gmail.com

VISEKORHJA
Bashkia Mirdite

TITULLI I PROIEKMIT

PROTESIMI I RRJETIT UJITES FSHATI
KODER RRESHEN, LAGJA ZALLI ZMESH

FAZA E PROIEKTIMIT:
PROJEKT ZBATIMI

PROFLET TERTHORE
TE TRASESE

Grupi i Projektimit:

Ing. Burhan HAFIZI
Ing. Servet VERÇANI
Ing. Gerti HAFIZI



Shkalla 1:100

Data: Shtator 2022

FLETA Nr.18

PROFLET TERTHORE

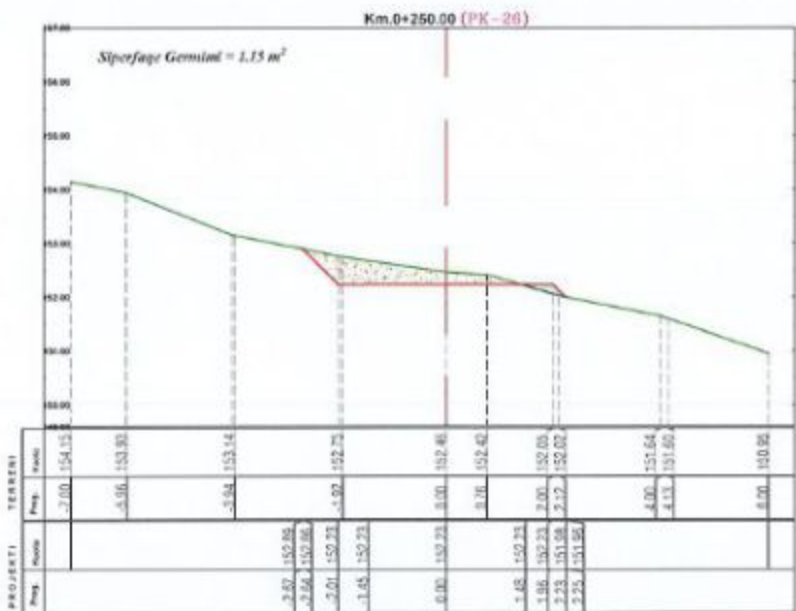
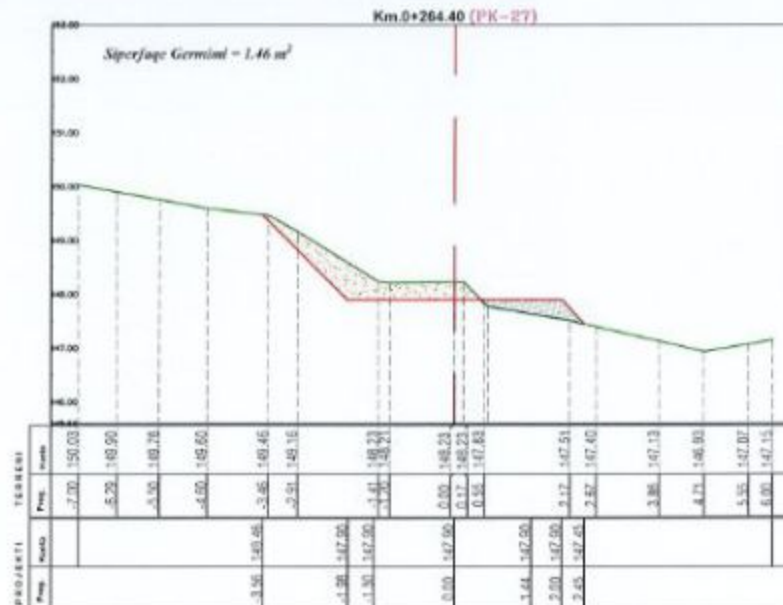
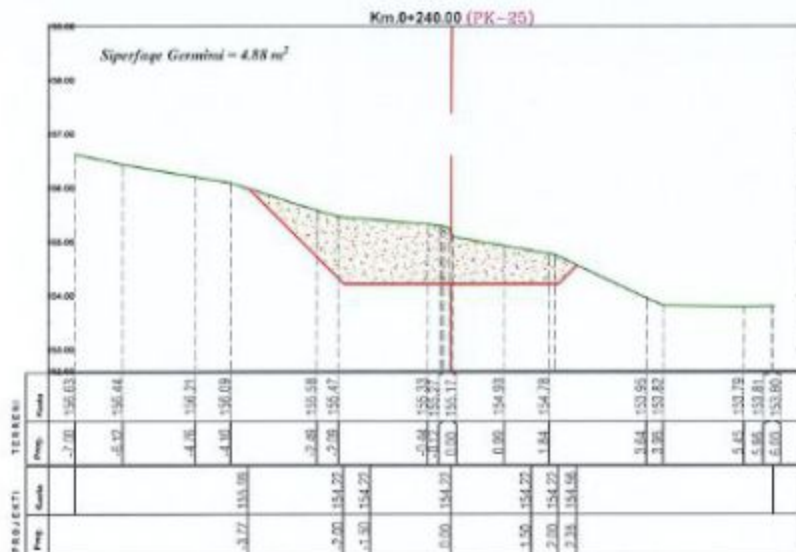

POROSITESI

BASHKIA MIRDITE



"ANGERBA" shpk

Adresa: Rr. "Tifan Tomini" Tiranë.
Cel: 090 20 95 892
E-mail: burhanhafizi@gmail.com

VENDOSURJA
Bashkia Mirdite

TITULLI I PROJEKTI

PLOTESIMI I RRJETIT UJTES FSHATI
KODER RRESHEN, LAGJA ZALLI ZMUSE"

FAZA E PROJEKTIMIT:
PROJEKT ZBATIMI

TITULLI I VIZATIMIT:
PROFLET TERTHORE
TE TRASESE

Grupi i Projektimit

Ing. Burhan HAFIZI
Ing. Servet VERÇANI
Ing. Gerti HAFIZI





Shkalla 1:100

Data: Shtator 2022

FLETA Nr.19

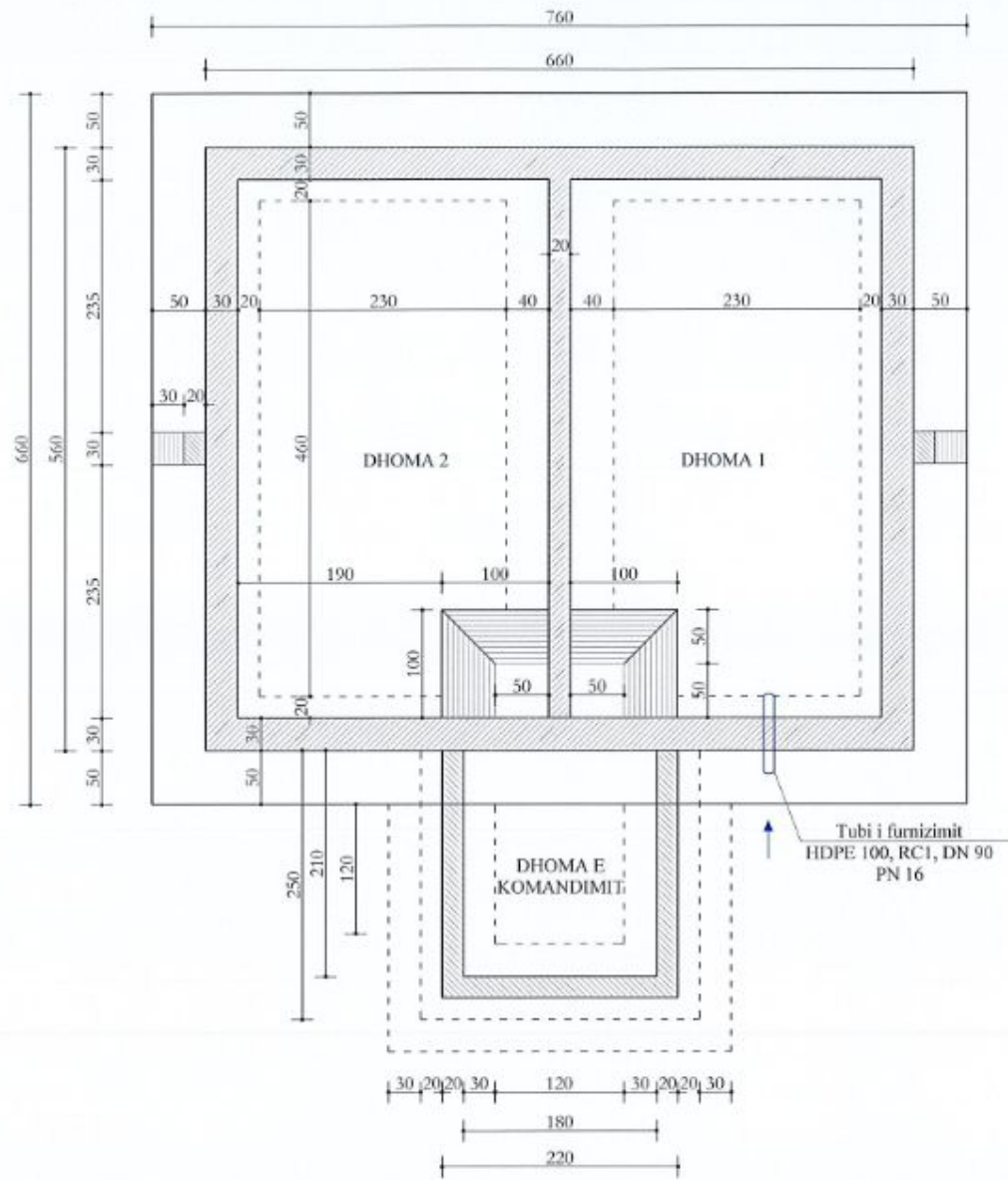
DEPO UJI, V= 60 M³
 PLANIMETRI
 SH. 1:50



POROSITESI BASHKIA MIRDITE	 <p>"ANGERBA" shpk Adresa: Rr. "Irfan Tomini" Tirane. Cel. 069 20 95 862 E-mail: burhanhafizi@gmail.com</p>	VENDODHJA Bashkia Mirdite TITULLI I PROJEKTTIT PLOTESIMI I RRJETIT UJITES FSHATI KODER RRESHEN, LAGJA ZALLI ZMESE"	FAZA E PROJEKTTIMIT : PROJEKT ZBATIMI TITULLI I VIZATIMIT : DEPO UJI, V=60 M³ PLANIMETRIA	Grupi i Projektimit : Ing. Burhan HAFIZI Ing. Servet VERÇANI Ing. Gerti HAFIZI Shkalla 1:50 Data: Shtator 2022 FLETA Nr.20
--	--	--	--	--

DEPO UJI, V= 60 M³
 PLANIMETRI ARMIMI
 SH. 1:50

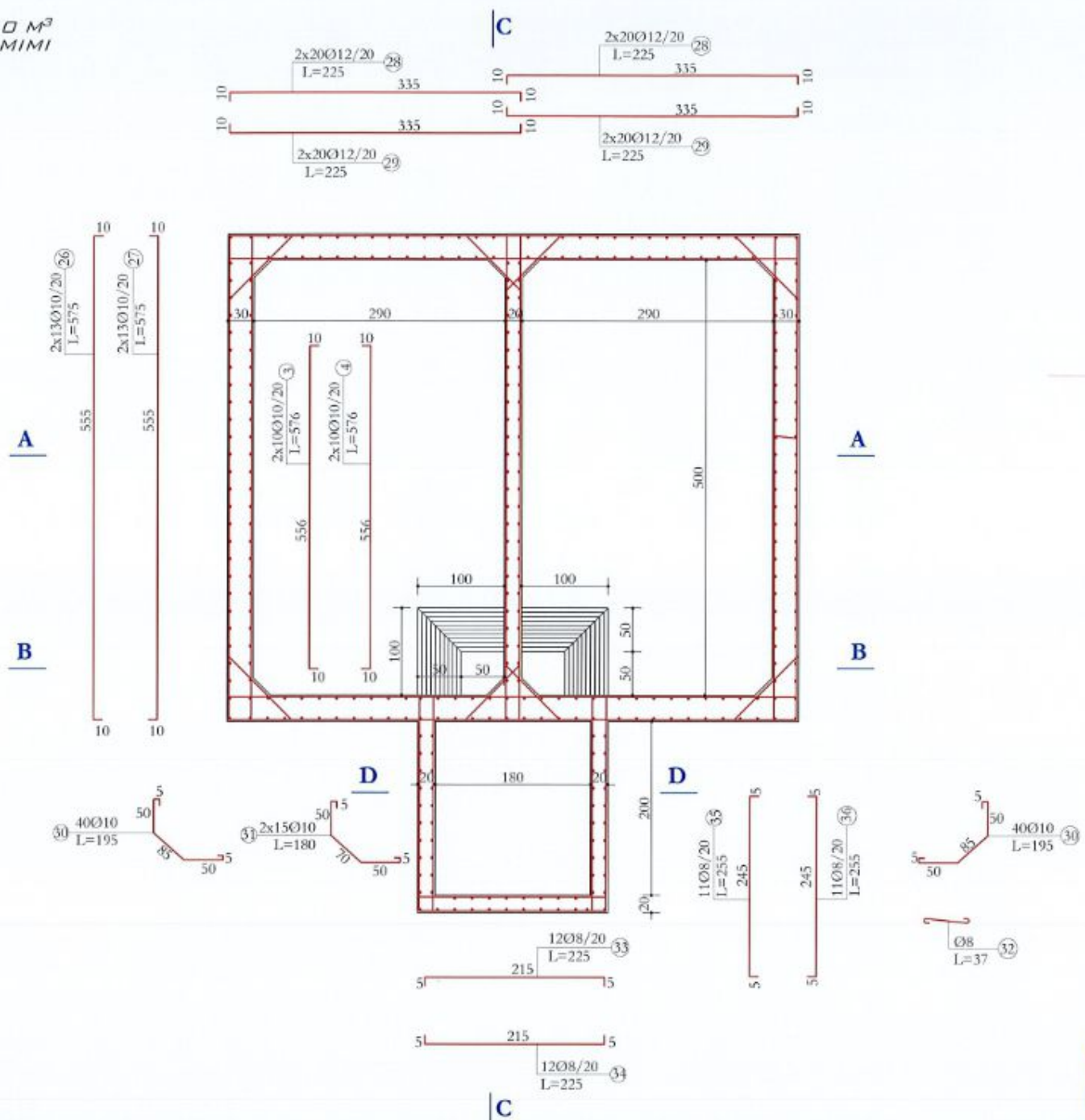

POROSITESI
BASHKIA MIRDITE



"ANGERBA" shpk
 Adresa: Rr. "Irfan Tomini" Tiranë.
 Cel. 069 20 95 862
 E-mail: burhanhafizi@gmail.com

VENDODHUA
Bashkia Mirdite
 TITULLI I PROJEKTIT
**PLOTESIMI I RRJETIT UJITES FSHATI
 KODER RRESHEN, LAGJA ZALLI ZMESE"**



FAZA E PROJEKTIMIT:
PROJEKT ZBATIMI
 TITULLI I VIZATIMIT:
**DEPO UJI, V=60 M³
 PLANIMETRIA E ARMIMIT**

Grupi i Projektimit
 Ing. Burhan HAFIZI
 Ing. Servet VERÇANI
 Ing. Gerti HAFIZI
 Shkalla 1:50
 Data: Shtator 2022
 FLETA Nr.21

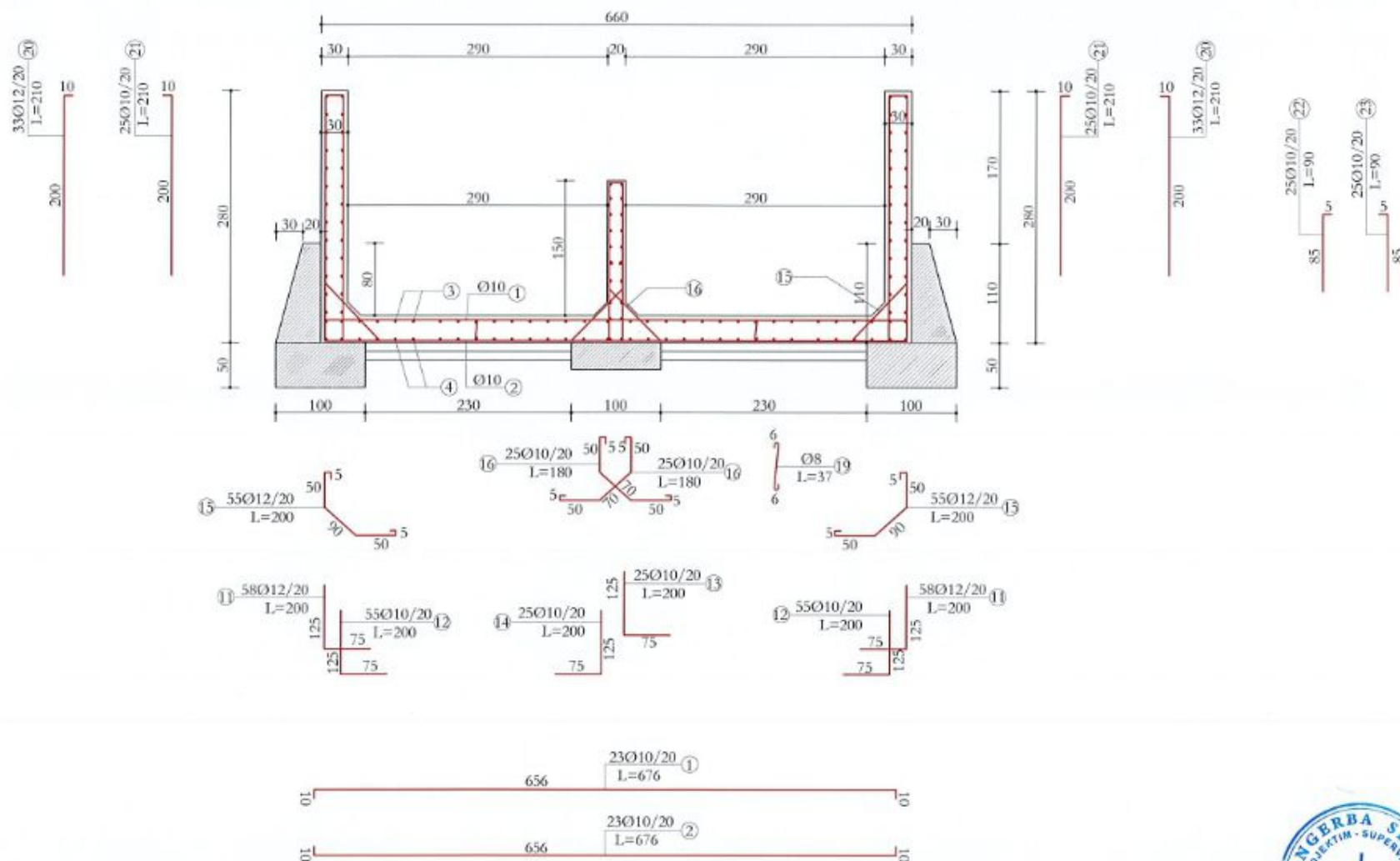

DEPO UJI, V= 60 M³
PRERJA A-A
SH. 1:50



<p>POROSITESI</p>	<p>"ANGERBA" shpk Adresa: Rr. "Irfan Tomini" Tirana. Cel. 069 20 95 862 E-mail: burhanhafizi@gmail.com</p>	<p>VENDDHIA Bashkia Mirdite</p>	<p>FAZAE PROJEKTIMIT: PROJEKT ZBATIMI</p>	<p>Grupi i Projektimit: Ing. Burhan HAFIZI Ing. Servet VERÇANI Ing. Gerti HAFIZI</p> <p>Shkalla 1:50 Data: Shtator 2022 FLETA Nr.22</p>
<p>BASHKIA MIRDITE</p>		<p>TITULLI I PROJEKTIT PLOTESIMI I RRJETIT UJITES FSHATI KODER RRESHEN, LAGJA ZALLI ZMESE"</p>	<p>TITULLI I VIZATIMIT: DEPO UJI, V=60 M³ PRERJA A-A</p>	

DEPO UJI, V= 60 M³
 PRERJA B-B
 SH. 1:50

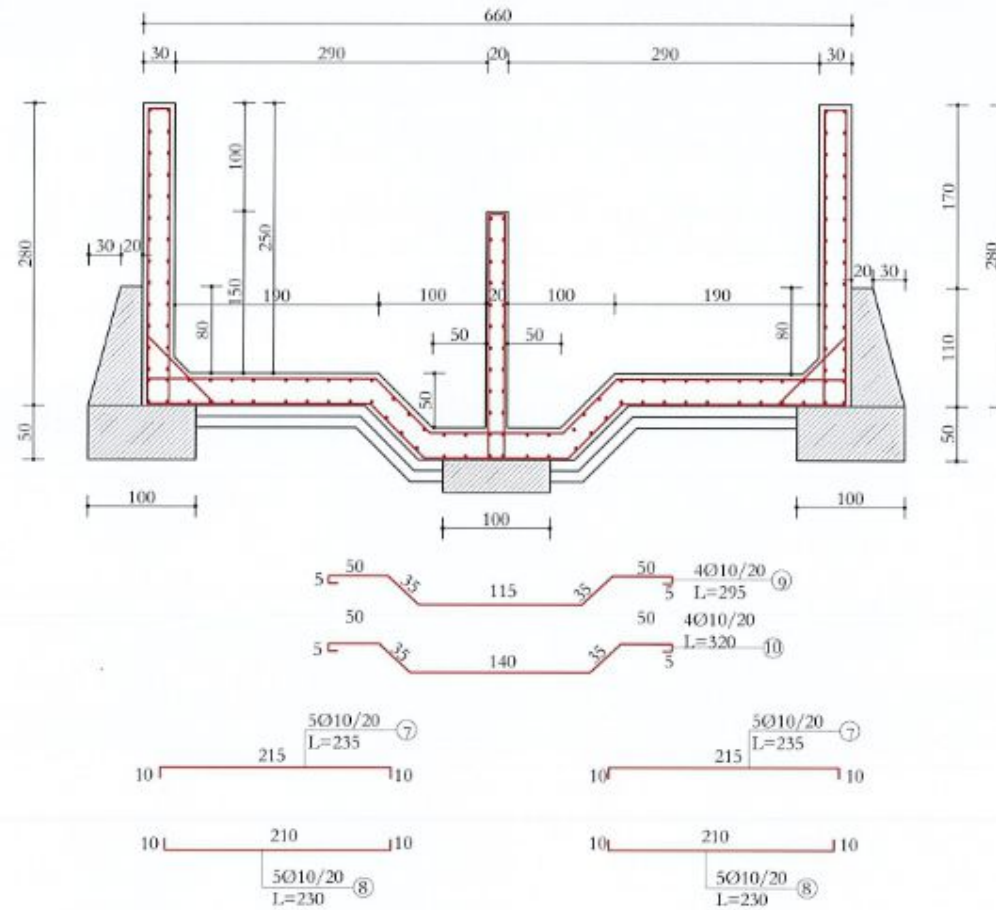

POROSITESI BASHKIA MIRDITE	 <p>"ANGERBA" shpk Adresa: Rr. "Irfan Tomini" Tirano. Cel: 069 20 95 862 E-mail: burhanhafizi@gmail.com</p>	VENDORRJA Bashkia Mirdite TITULLI I PROJEKTTI FLOTESIMI I RRJETIT UJTES FSHATI KODER KRESHEN, LAGJA ZALLI ZMESE"	FAZA E PROJEKTIMIT: PROJEKT ZBATIMI TITULLI I VIZATIMIT: DEPO UJI, V=60 M³ PRERJA B-B	Grupi i Projektimit: Ing. Burhan HAFIZI Ing. Servet VERCANI Ing. Gerti HAFIZI	Shkalla 1:50 Data: Shtator 2022 FLETA Nr.23
--	--	--	--	--	---

DEPO UJI, V= 60 M³
PRERJA C-C
SH. 1:50

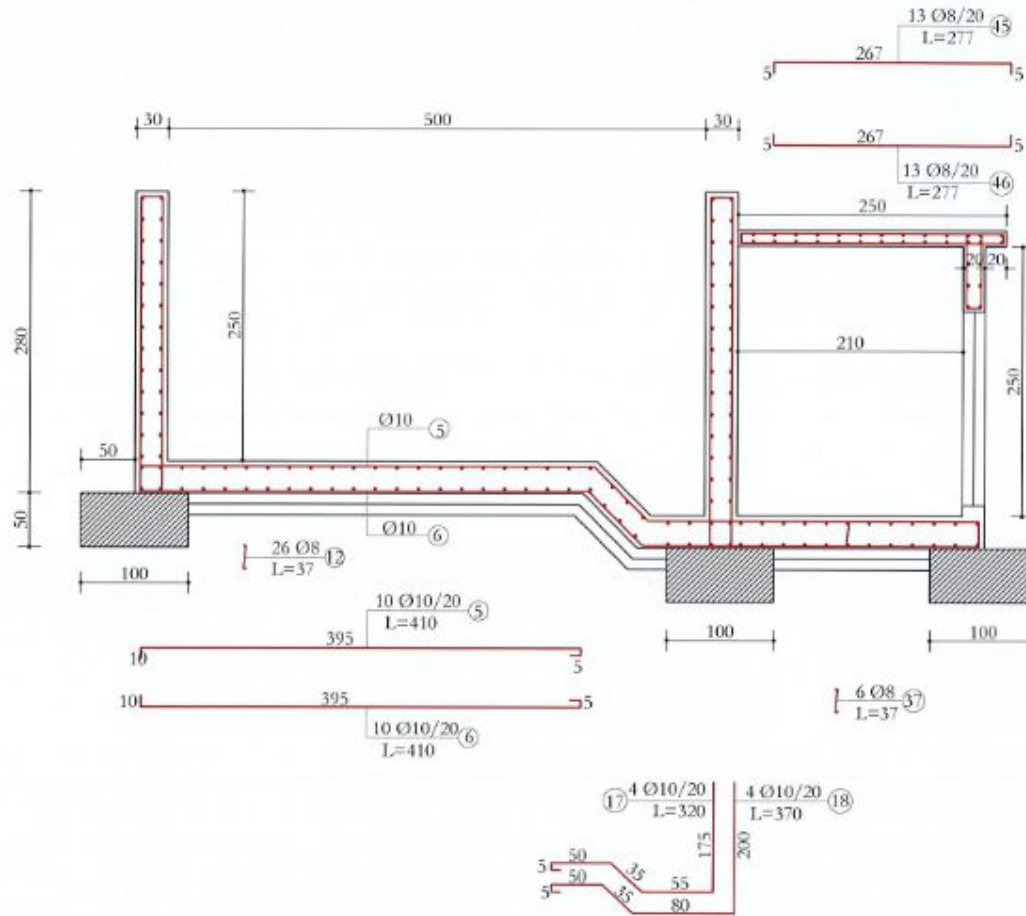
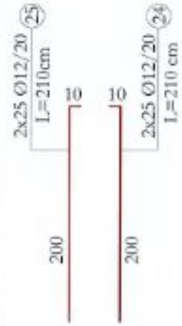

DEPO UJI, V= 60 M³
PRERJA D-D
SH. 1:50

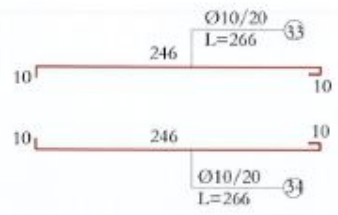
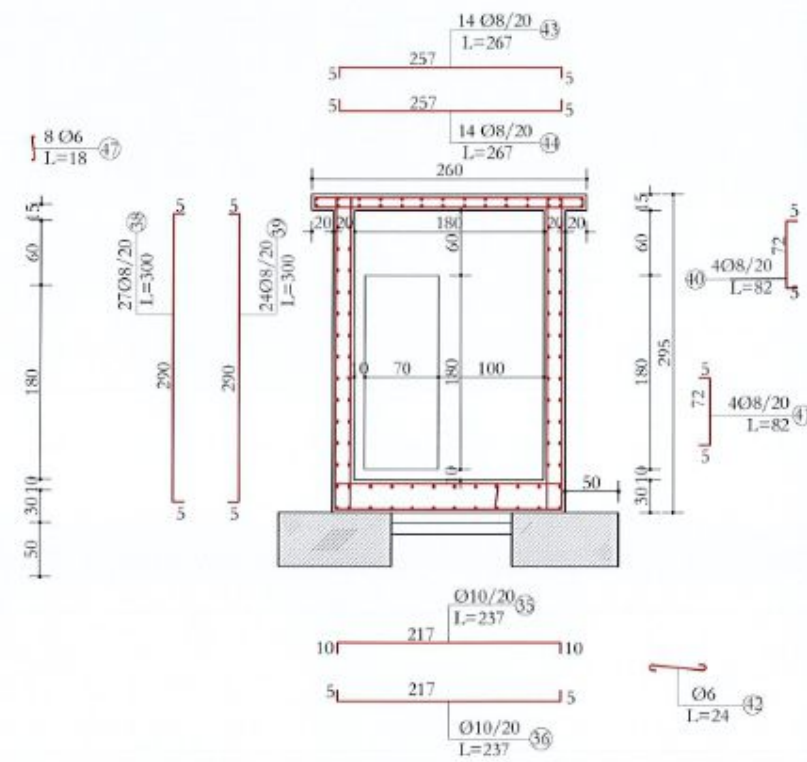

<p>POROSITESI</p>	<p>"ANGERBA" shpk Adresa: Rr. "Irfan Tomini" Tirane, Cel: 069 20 95 862 E-mail: burhanhafizi@gmail.com</p>	<p>VENDOSËSIA <i>Bashkia Mirdite</i></p>	<p>FAZA E PROJEKTIMIT: PROJEKT ZBATIMI</p>	<p>Grupi i Projektimit: Ing. Burhan HAFIZI Ing. Sertver VERÇANI Ing. Gerti HAFIZI</p>	<p>Shkalla 1:50</p>
<p>BASHKIA MIRDITE</p>		<p>TITULLI I PROJEKTIT PLOTESIMI I RRJETIT UJTES FSHATI KODER KRESHEN, LAGJA ZALLI ZMESE"</p>	<p>TITULLI I VIZATIMIT: DEPO UJI, V=60 M³ PRERJA C-C DHE D-D</p>	<p>Data: Shtator 2022</p>	<p>FLETA Nr.24</p>

SKEMA HIDRAULIKE E DEPOS, PRERJE
SH. 1:50

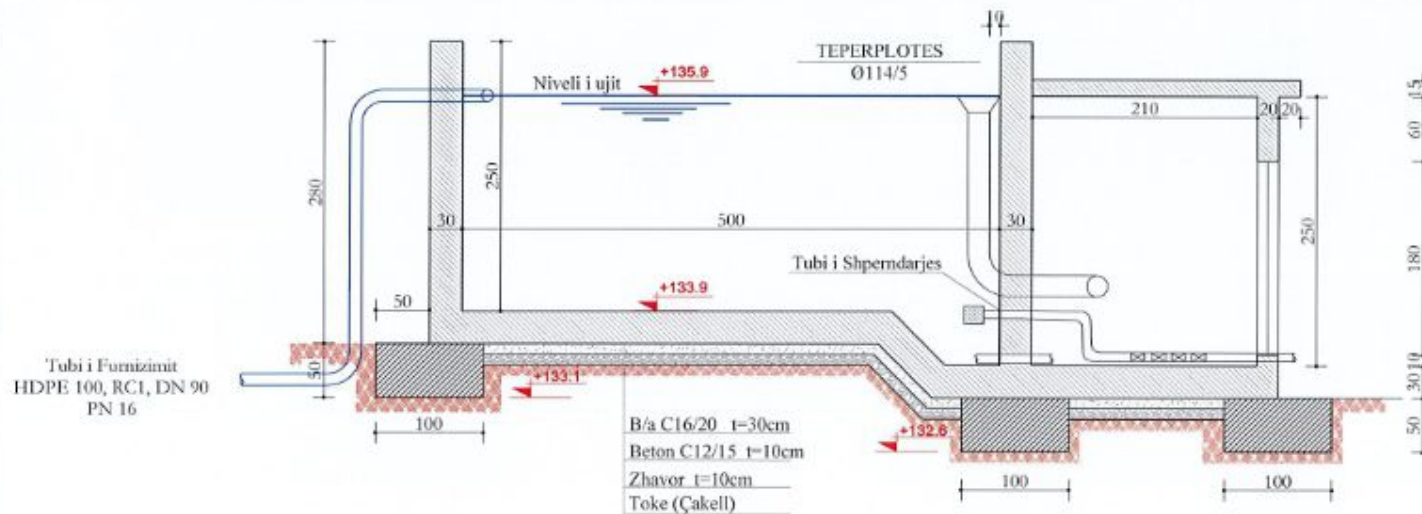

SKEMA HIDRAULIKE E DEPOS



TABELA E HEKURAVE
PUSETA E KOMANDIMIT

Nr	φ (mm)	L (cm)	Cope	L (m)	φ (mm)	L (m)	P (kg/m)	P (kg)
A-BAZA								
33	10	266	12	31.92	8	2.22	0.395	0.88
34	10	266	12	31.92	10	150.98	0.617	93.15
35	10	237	11	26.07				
36	10	237	11	26.07				
37	8	37	6	2.22				
B-MURET								
38	8	300	27	81	6	1.44	0.222	0.32
39	8	300	24	72	8	159.56	0.395	63.03
40	8	82	4	3.28				
41	8	82	4	3.28				
42	6	24	6	1.44				
C-SOLETA								
43	8	267	14	37.38	6	1.44	0.222	0.32
44	8	267	14	37.38	8	146.78	0.395	57.98
45	8	277	13	36.01				
46	8	277	13	36.01				
47	6	18	8	1.44				
Shuma Total								215.7
BETON C12/15 PER NENSHTRESE 10 CM								0.166
BETON C12/15 THEMEL								3.9
BETON C16/20 DHOME KOMANDIMI (MURE+BAZAMENT+SOLETE)								5.5

TABELA E HEKURAVE
DEPO

Nr	φ (mm)	L (cm)	Cope	L (m)	φ (mm)	L (m)	P (kg/m)	P (kg)
A-BAZAMENTI								
1	10	676	23	155.48	8	9.62	0.395	3.80
2	10	676	23	155.48	10	1364.56	0.617	841.93
3	10	576	20	115.2	12	220	0.888	195.36
4	10	576	20	115.2				Shuma 1041.09
5	10	410	10	41				
6	10	410	10	41				
7	10	235	10	23.5				
8	10	235	10	23.5				
9	10	295	4	11.8				
10	10	320	4	12.8				
11	10	200	116	232				
12	10	200	110	220				
13	10	200	25	50				
14	10	200	25	50				
15	12	200	110	220				
16	10	180	50	90				
17	10	320	4	12.8				
18	10	370	4	14.8				
19	8	37	26	9.62				
B-MURET								
20	12	210	66	138.6	8	48.84	0.395	19.29
21	10	210	50	105	10	1089	0.617	671.91
22	10	90	25	22.5	12	138.6	0.888	123.08
23	10	90	25	22.5				Shuma 814.28
24	10	210	50	105				
25	10	210	50	105				
26	10	575	26	149.5				
27	10	575	26	149.5				
28	10	195	40	78				
29	10	355	40	142				
30	10	195	80	156				
31	10	180	30	54				
32	8	37	132	48.84				Shuma Total 1855.38
BETON C12/15 PER NENSHTRESE 10 CM								2.11
BETON C12/15 THEMEL								15.7
BETON C16/20 (MURE + BAZAMENT)								31.01

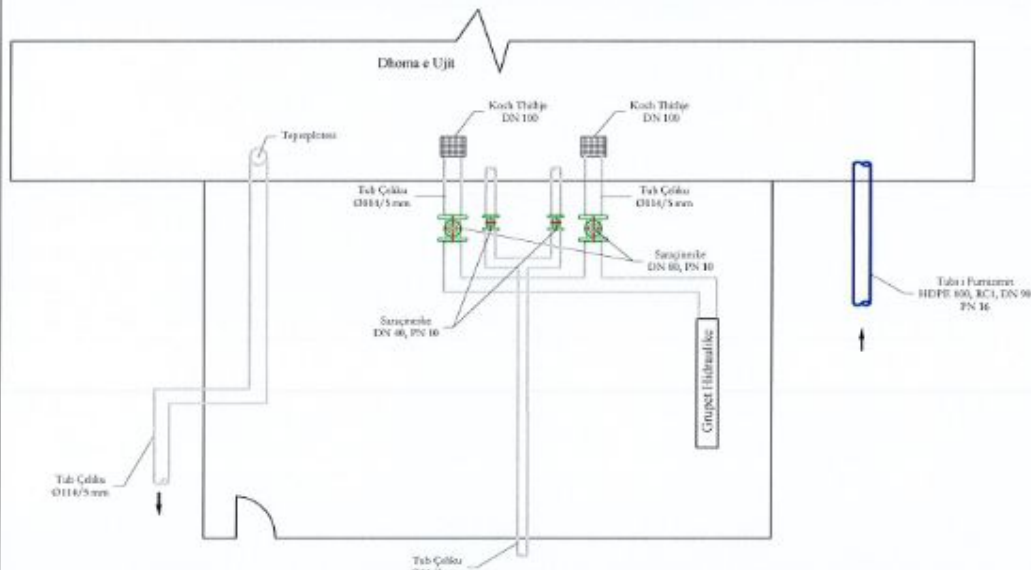

POROSITESI

BASHKIA MIRDITE



"ANGERBA" shpk

Adresa: Rr. "Irfan Tomini" Tirane.
Cel: 069 20 95 852
E-mail: burhanhafizi@gmail.com

VENDOBISHA
Bashkia Mirdite

TITULLI I PROJEKTI

PROTESIMI I RRJETIT UJITES FSHATI
KODER RRESHEN, LAGJA ZALLI ZMESE"

FAZA E PROJEKTIMIT:
PROJEKT ZBATIMI

TITULLI I VEZATIMIT:

DEPO UJI, V=60 M³
SKEMA HIDRAULIKE

Grupi i Projektimit:

Ing. Burhan HAFIZI
Ing. Servet VERÇANI
Ing. Gerti HAFIZI

Shkalla 1:50

Data: Shtator 2022

FLETA Nr.25

PLANIMETRIA E MBUSHJES SE BAZAMENTIT
SH. 1:100

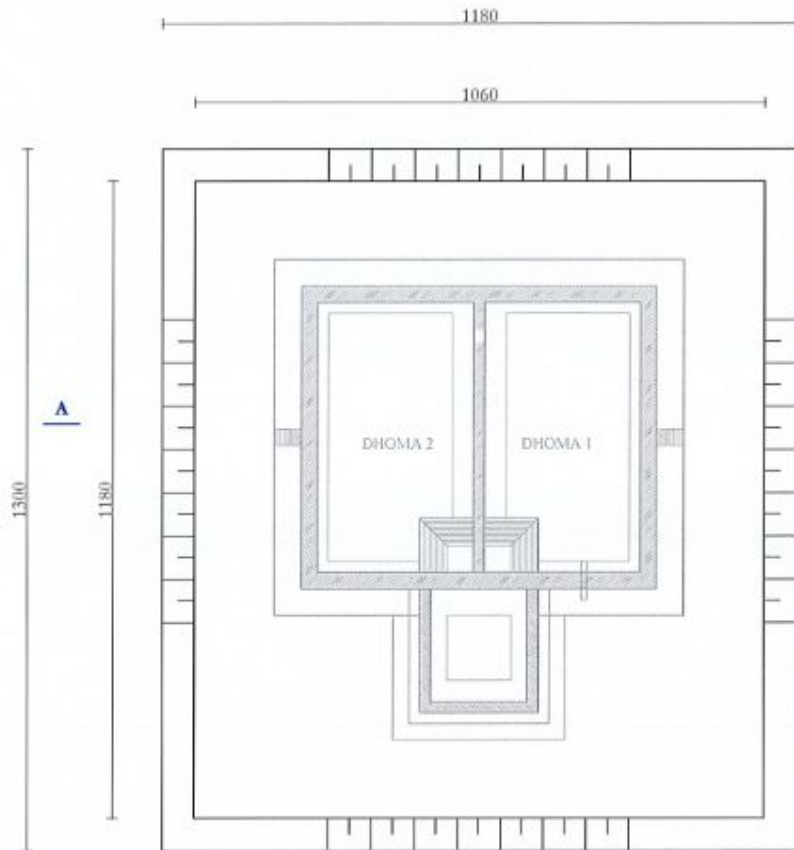

PRERJA A-A
SH. 1:100

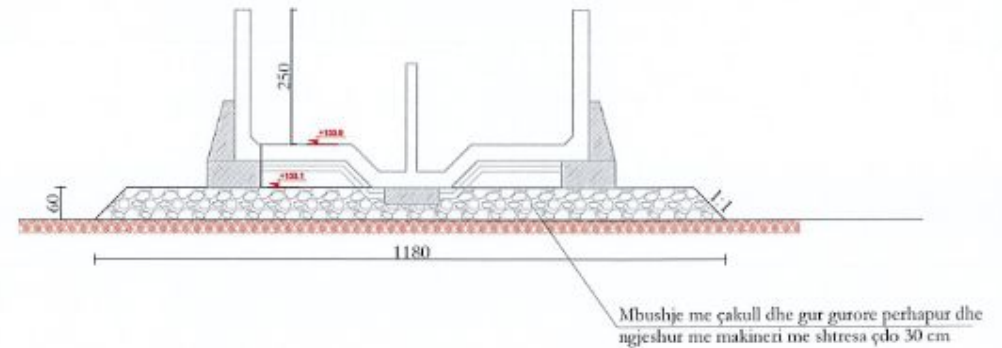

<p>POROSITESI</p>	 <p>"ANGERBA" shpk Adresa: Rr. "Irfan Tomini" Tirane. Cet: 069 20 95 862 E-mail: burhanhafizi@gmail.com</p>	<p>VENDODHJA <i>Bashkia Mirdite</i></p>	<p>FAZA E PROJEKTIMIT: PROJEKT ZBATIMI</p>	<p>Grupi i Projektimit: Ing. Burhan HAFIZI Ing. Servet VERÇANI Ing. Gerti HAFIZI</p>	<p>Shkalla 1:100 Data: Shtator 2022</p>
<p>BASHKIA MIRDITE</p>		<p>TITULLI I PROJEKTTIT PLOTESIMI I RRJETIT UJTES FSHATI KODER RRESHEN, LAGJA ZALLI ZMESE"</p>	<p>TITULLI I VIZATIMIT: DEPO UJI, V=60 M³ BAZAMENTI</p>		<p>FLETA Nr.26</p>

PROFILI GJATESOR, TUBACIONI I SHPERNDARJES

PROFIL TIP, PK.207-224, L=158 M
SH. 1:25

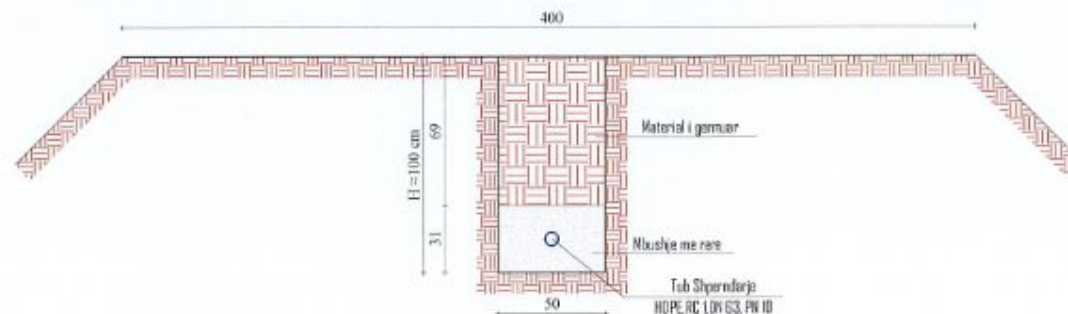
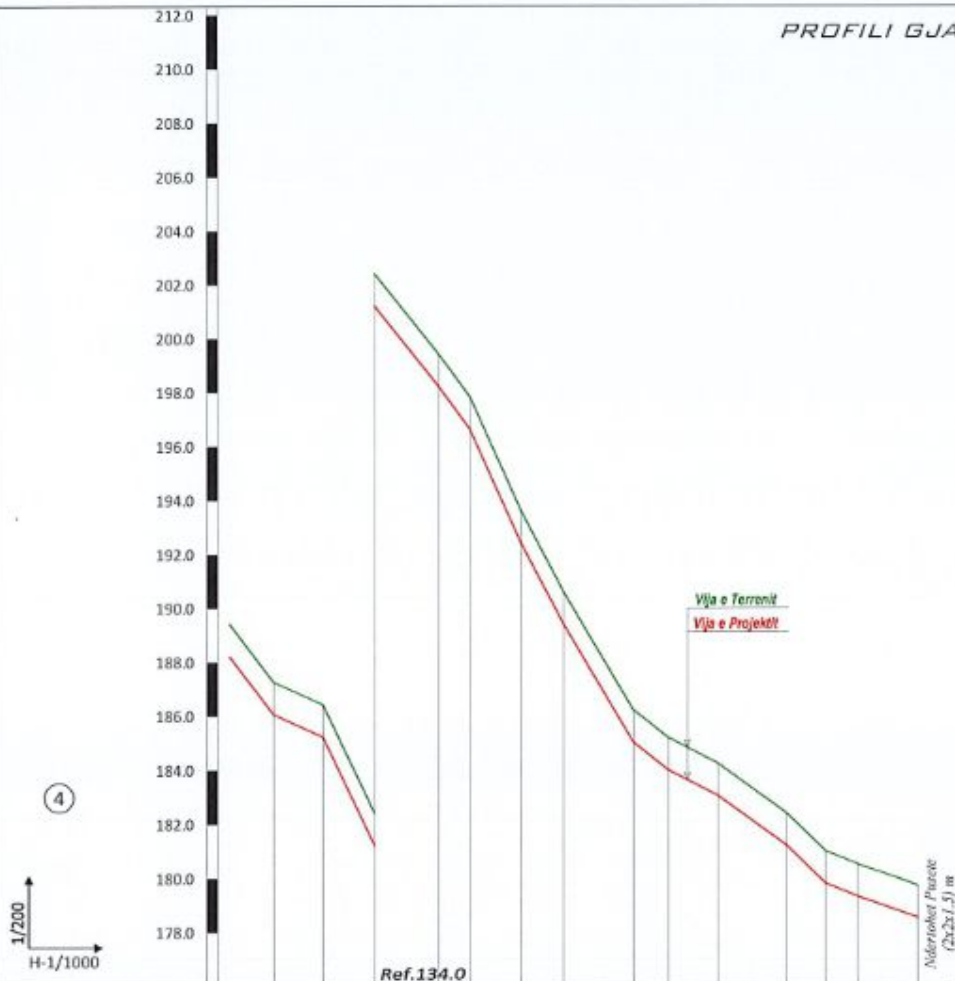

VOLUMET E GERMIMEVE					
Nr	Siperfaqe	Siperfaqe Mesatare	D.Pjesore	V.Pjesor	V.Progresiv (m³)
1	0.930				
2	0.87	0.90	3.70	3.33	3.33
3	0.57	0.72	10.27	7.39	10.72
4	1.04	0.81	13.04	10.50	21.22
5	1.55	1.30	11.20	14.50	35.73
6	2.11	1.83	9.17	16.78	52.51
7	1.77	1.94	9.61	18.64	71.15
8	3.85	2.81	11.98	33.66	104.81
9	2.57	3.21	5.75	18.46	123.27
10	1.44	2.01	9.62	19.29	142.56
11	3.36	2.40	7.92	19.01	161.57
12	3.77	3.57	12.88	45.92	207.48
13	5.71	4.74	6.45	30.57	238.06
14	6.92	6.32	9.33	58.92	296.98
15	1.57	4.25	12.76	54.17	351.14
16	0.98	1.28	7.26	9.26	360.40
17	1.91	1.45	5.98	8.64	369.04
18	0.37	1.14	11.16	12.72	381.76
			158.08		381.76

ELEMENTET HIDRAULIK	Vendoset Tub HOPE 100, RC 1, DN 63, PN 10																	
GERMIM ose MBUSHJE	-1.20	-1.20	-1.20	-1.20	-1.20	-1.20	-1.20	-1.20	-1.20	-1.20	-1.20	-1.20	-1.20	-1.20	-1.20	-1.20	-1.20	-1.20
KUOTA E PROJEKTTIT	164.07	163.24	159.21	156.23	154.65	150.40	147.39	143.04	142.01	141.04	139.20	137.79	137.30	136.52				
KUOTA E TOKES																		
Nr. PIKETES	211	212	213	214	215	216	217	218	219	220	221	222	223	224				
DISTANCA PJESORE	1.2	9.2	9.6	12.0	5.8	9.6	7.9	12.9	6.5	9.3	12.8	7.3	6.0	11.2				
DISTANCA PROGRESIVE	350.3	359.4	369.0	381.0	386.8	396.4	404.3	417.2	423.6	433.0	445.7	453.0	459.0	470.1				
KILOMETRAZHI	0.35			0.40						0.45								

POROSITESI
BASHKIA MIRDITE

"ANGERBA" shpk
Adresa: Rr. "Irfan Tomini" Tirane.
Cel. 069 20 95 862
E-mail: burhanhafizi@gmail.com

VENDODHJA
Bashkia Mirdite
TITULLI I PROJEKTTIT
PLOTESIMI I RRJETIT UJITES FSHATI KODER RRESHEN, LAGJA ZALLI ZMESE"

FAZA E PROJEKTTIMIT:
PROJEKT ZBATIMI
TITULLI I VIZATIMIT:
PROFILI GJATESOR TUBACIONI I SHPERNDARJES

Grupi i Projektimit:
Ing. Burhan HAFIZI
Ing. Servet VERÇANI
Ing. Gerti HAFIZI
Shkalla 1:200; 1:1000
Data: Shtator 2022
FLETA Nr.28



PROFLET TERTHORE

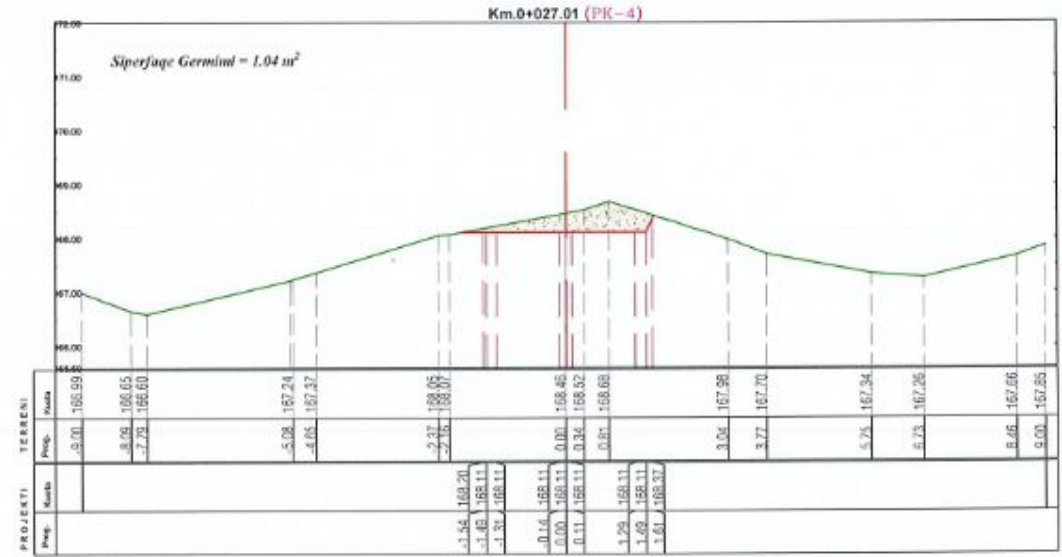
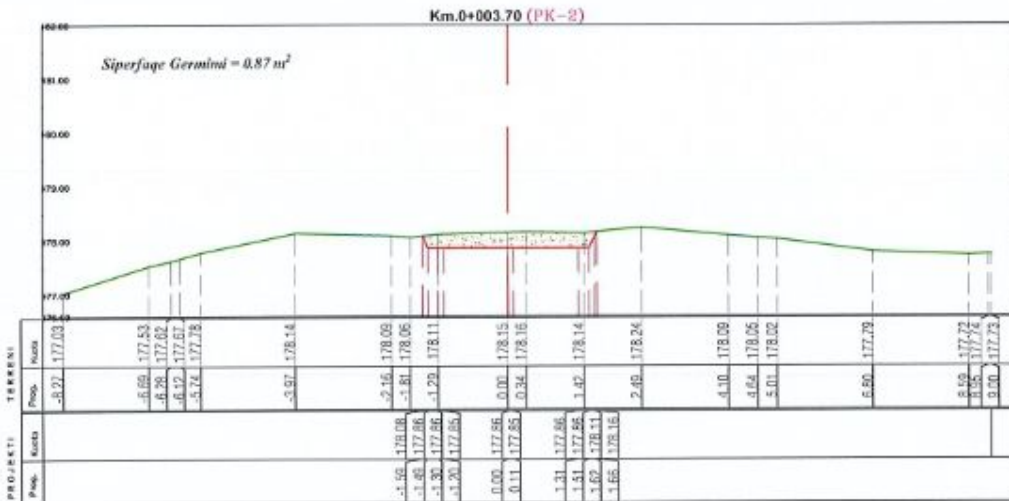
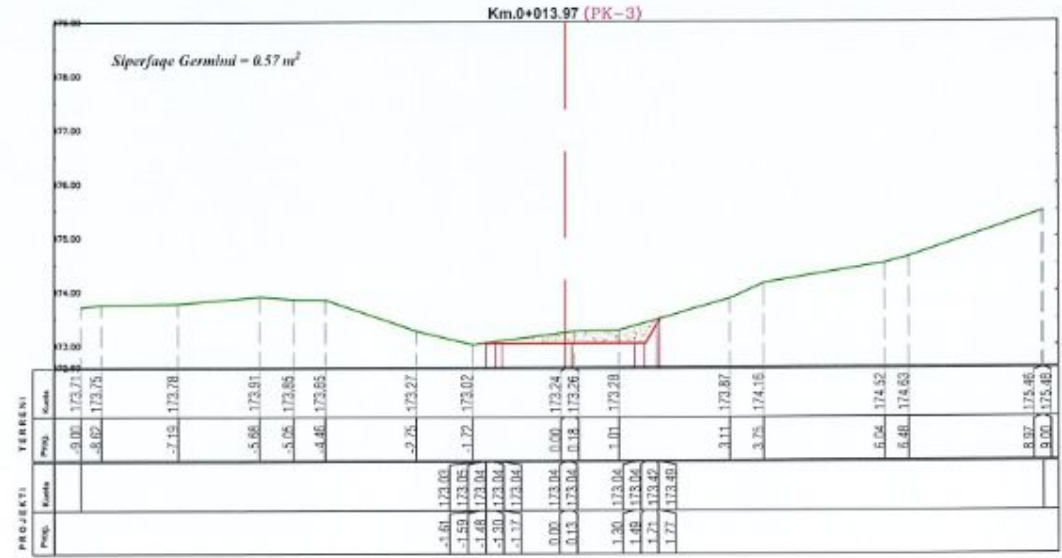
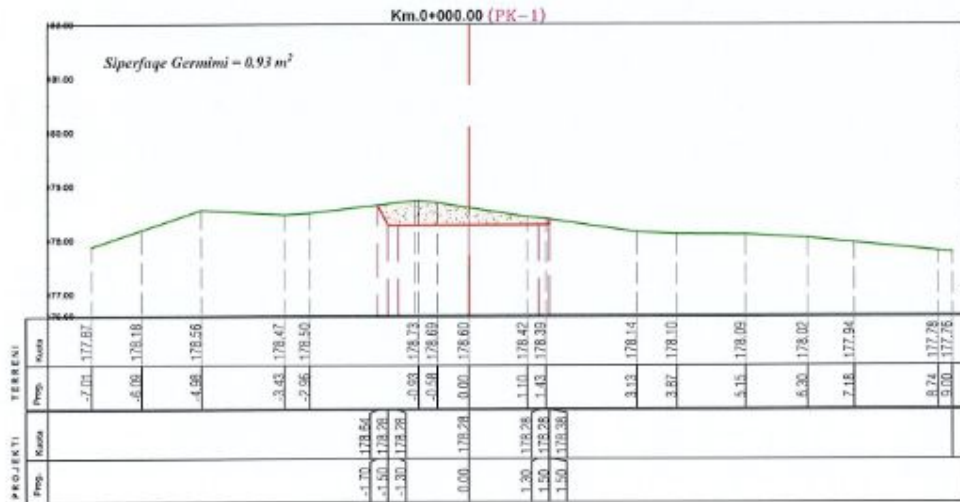

POROSITESI

BASHKIA MIRDITE



"ANGERBA" shpk

Adresa: Rr. "Irfan Tomini" Tirane.
 Cel: 069 20 95 862
 E-mail: burhanhafizi@gmail.com

VENDODHJA
 Bashkia Mirdite

ITULLI I PROJEKTI

PLOTESIMI I RRJETIT UJITES FSHATI
 KODER RRESHEN, LAGJA ZALLI ZMESE"

FAZA E PROJEKTIMIT:
 PROJEKT ZBATIMI

ITULLI I VIZATIMIT

PROFLET TERTHORE
 TE TRASESE, SHPERNDARJE

Grupi i Projektimit:

Ing. Burhan HAFIZI
 Ing. Servet VERÇANI
 Ing. Gerti HAFIZI



Shkalla 1:100

Data: Shtator 2022

FLETA Nr.29

PROFILI TERTHORE

Km.0+038.21 (PK-5)

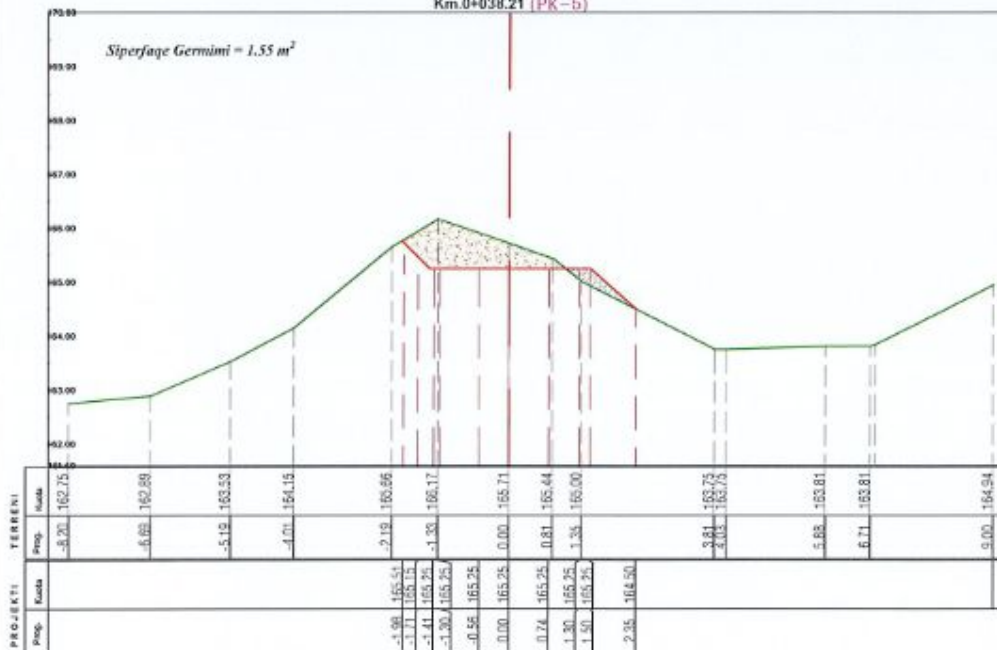

Km.0+058.99 (PK-7)

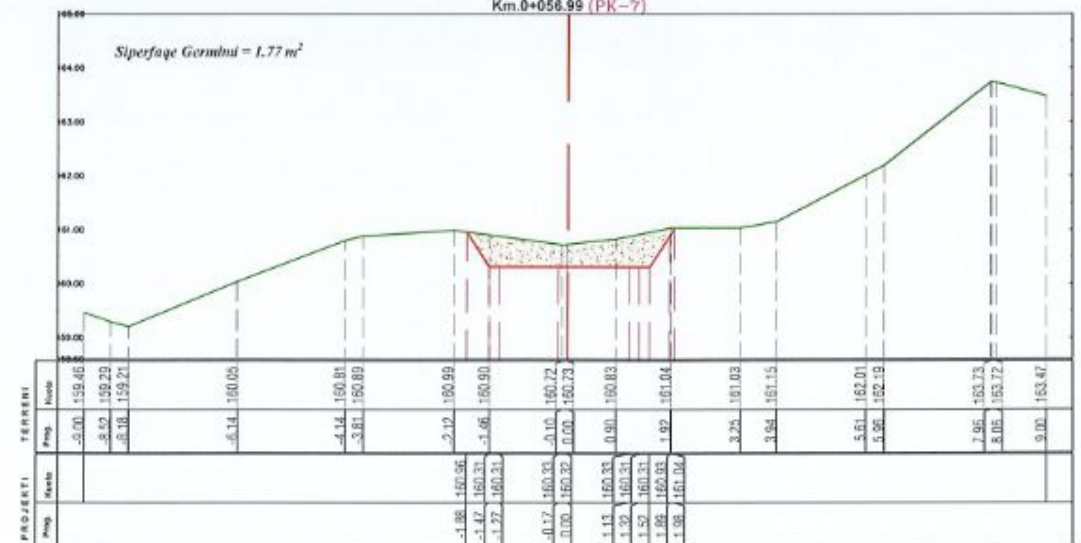

Km.0+047.38 (PK-6)

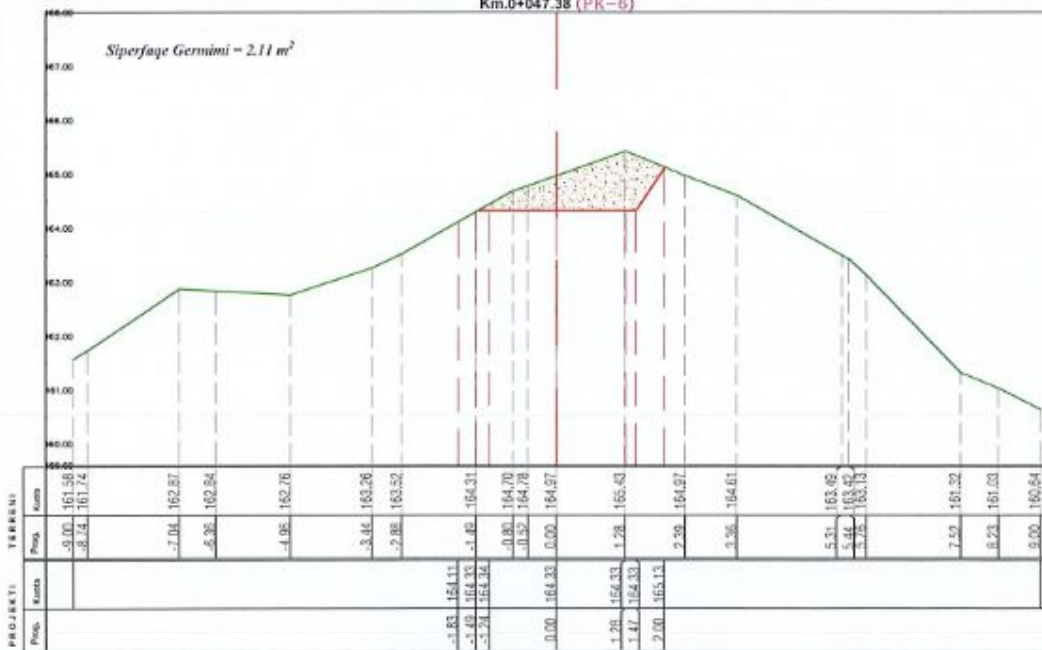

Km.0+068.97 (PK-8)

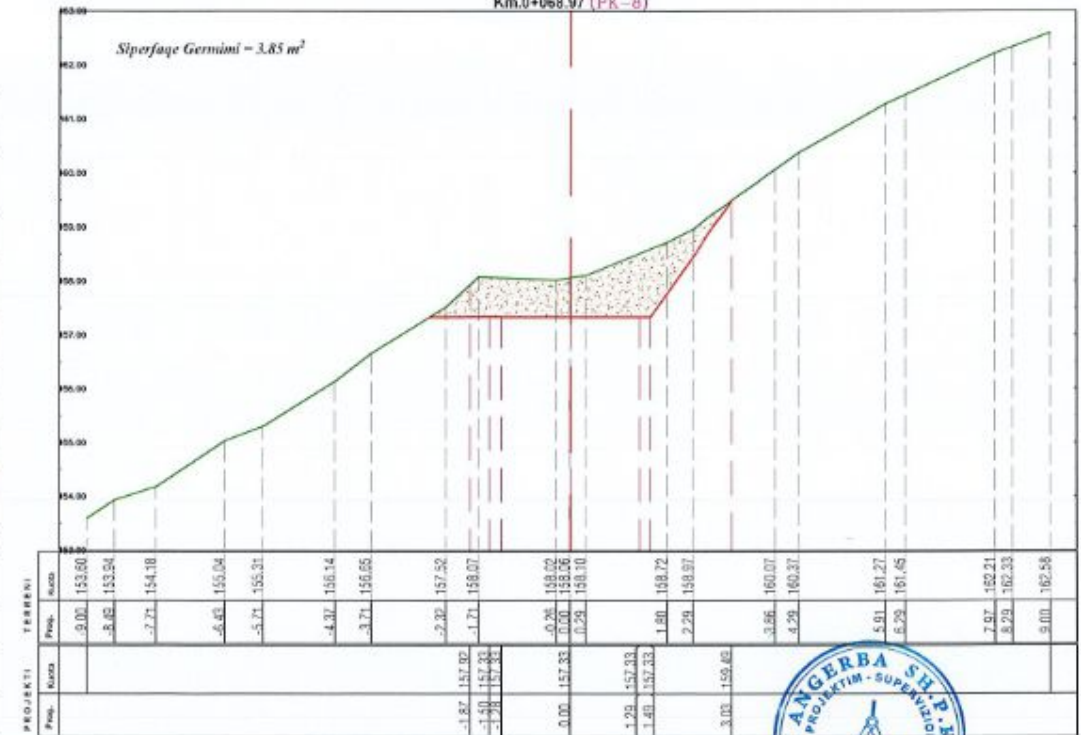

POROSITESI

BASHKIA MIRDITE



"ANGERBA" shpk

Adresa: Rr. "Irfan Tomini" Tirane.
Cel: 069 20 95 862
E-mail: burhanhafizi@gmail.com

VENDODHRIA

Bashkia Mirdite

TITULLI I PROJEKTI

PLOTESIMI I RRJETIT UJITES FSHATI
KODER RRESHEN, LAGJA ZALLI ZMESE"

FAZA E PROJEKTIMIT:

PROJEKT ZBATIMI

TITULLI I VIZATIMIT:

PROFILI TERTHORE
TE TRASESE, SHPERNDARJE

Grupi i Projektimit

Ing. Burhan HAFIZI
Ing. Servet VERÇANI
Ing. Gerti HAFIZI



Shkalla 1:100

Data: Shtator 2022

FLETA Nr.30

PROFLET TERTHORE

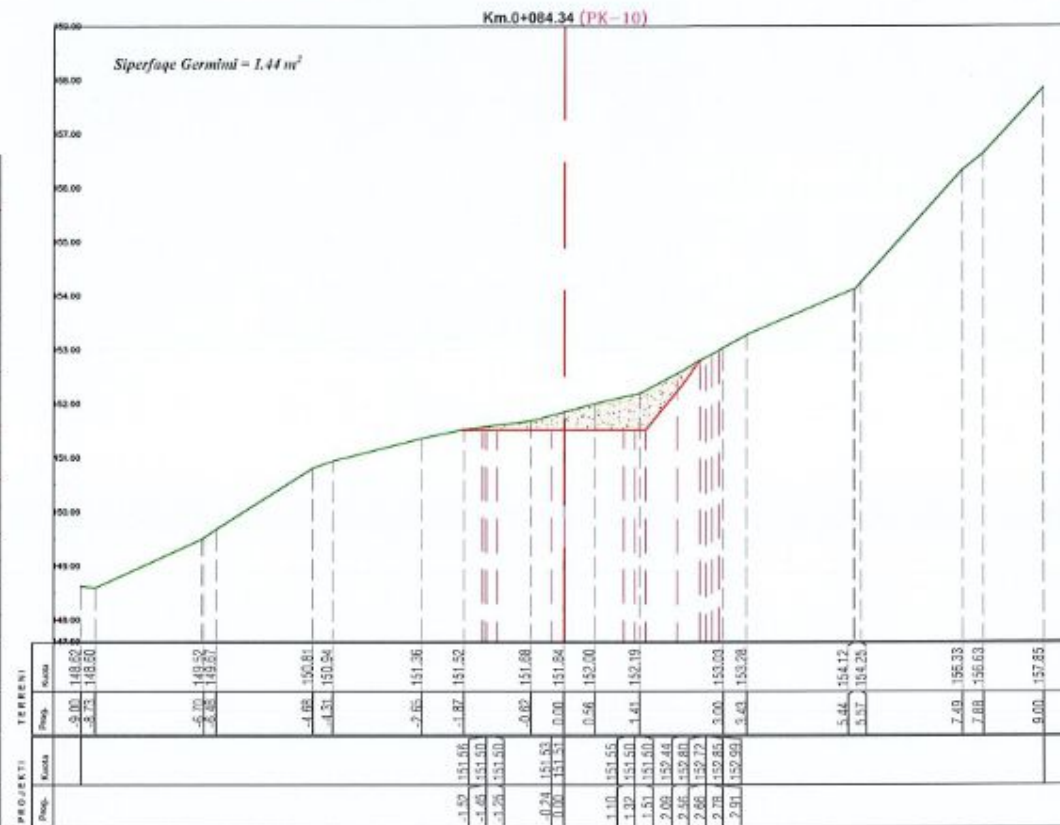
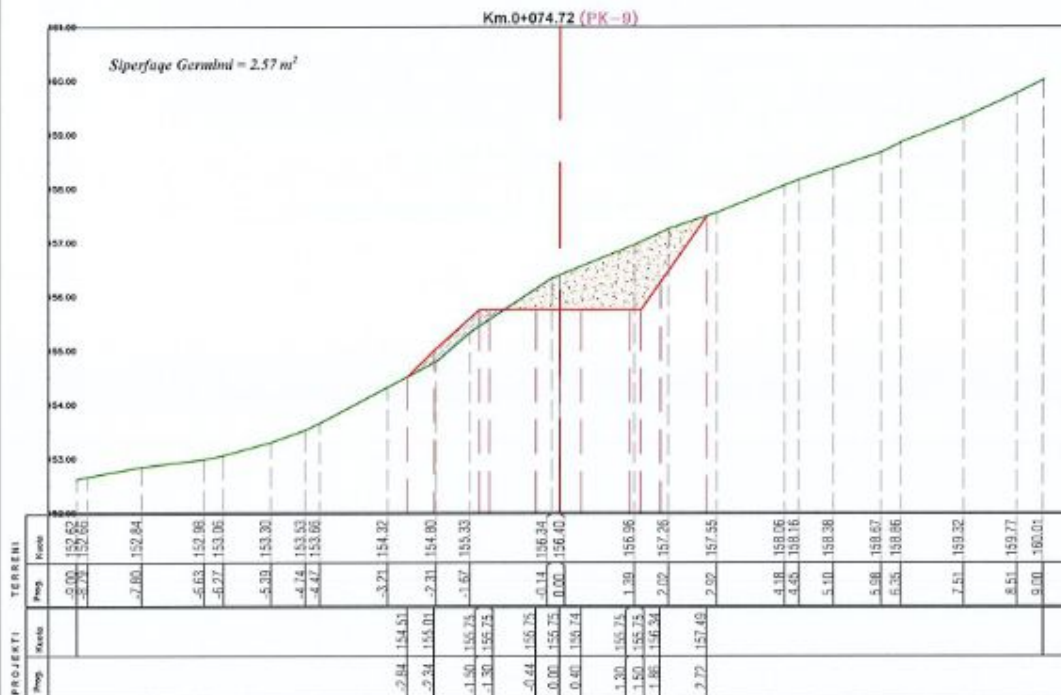

POROSITESI

BASHKIA MIRDITE



"ANGERBA" shpk

Adresa: Rr. "Irfan Tomini" Tirane.
 Cel: 069 20 95 862
 E-mail: burhanhafizi@gmail.com

VENDODHJA

Bashkia Mirdite

TITULLI I PROJEKTI

PLOTESIMI I RRJETIT UJITES FSHATI
 KODER RRESHEN, LAGJA ZALLI ZMESE"

FAZA E PROJEKTIMIT :

PROJEKT ZBATIMI

TITULLI I VIZATIMIT :

PROFLET TERTHORE
 TE TRASESE, SHPERNDARJE

Grupi i Projektimit

Ing. Burhan HAFIZI

Ing. Servet VERÇANI

Ing. Gerti HAFIZI



Shkalla 1:100

Data: Shtator 2022

FLETA Nr.31

PROFLET TERTHORE

Km 0+092.26 (PK-11)

Siperfaqe Gërmimi = 3.36 m²

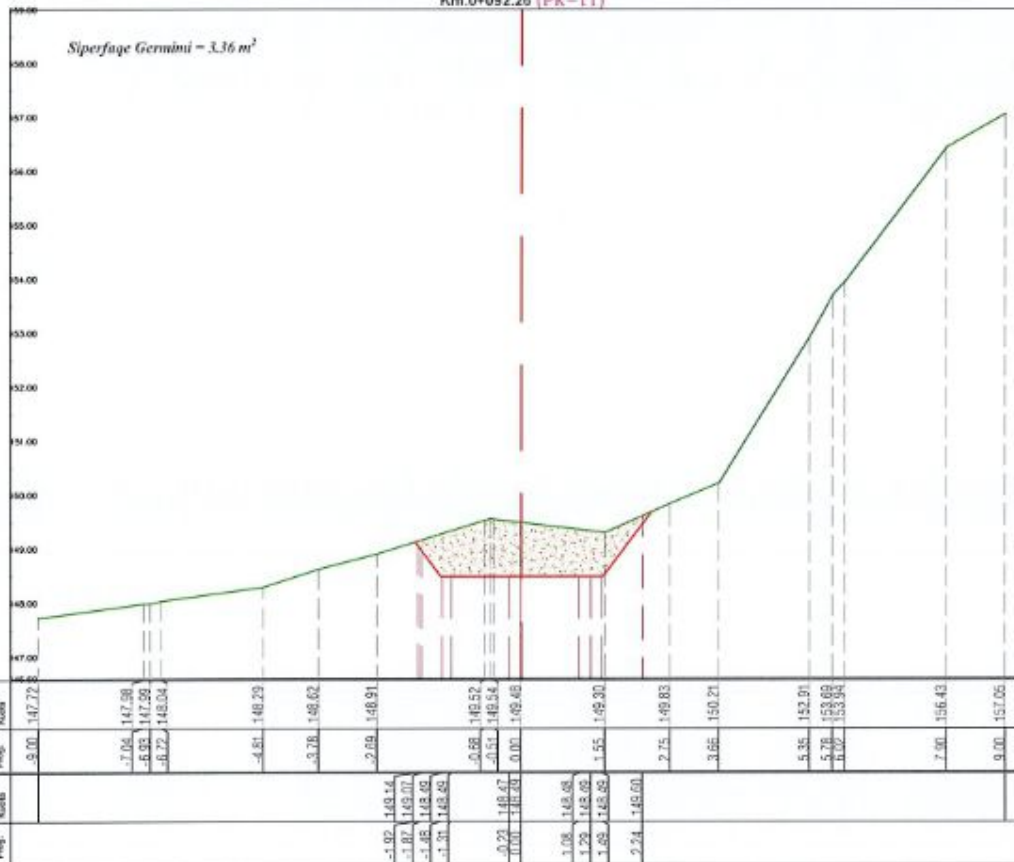

Km 0+105.14 (PK-12)

Siperfaqe Gërmimi = 3.77 m²

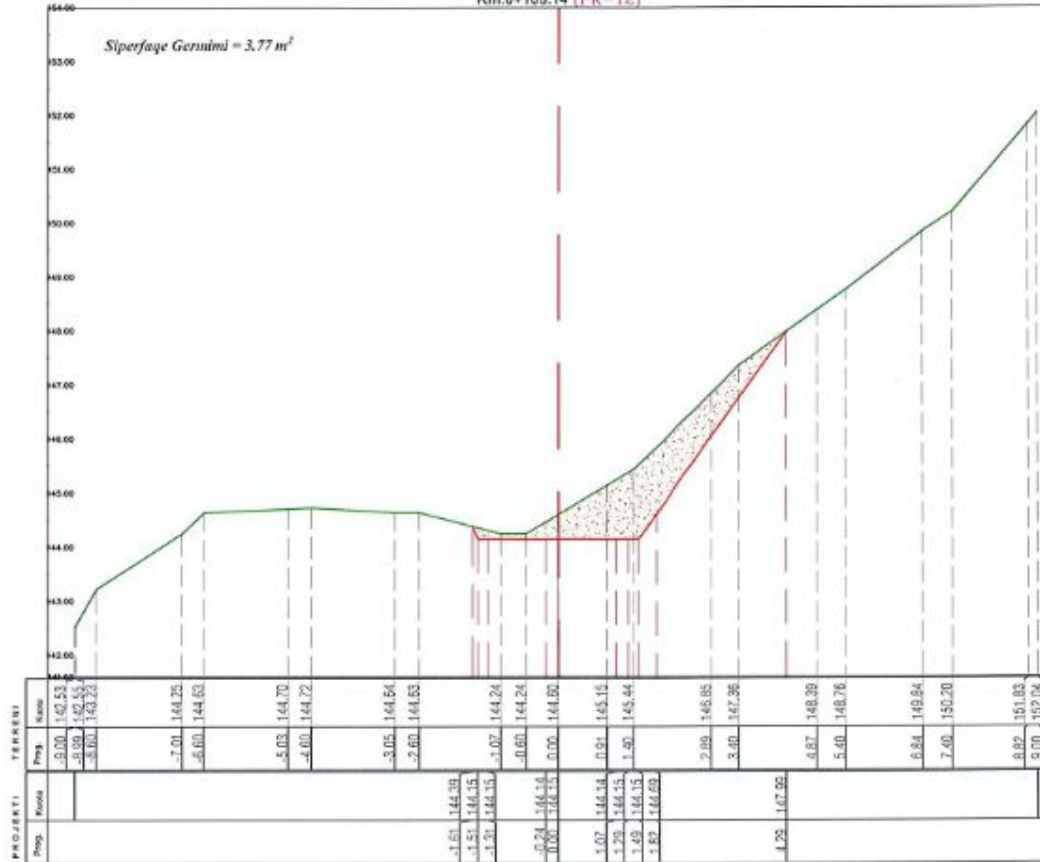

POROSITESI

BASHKIA MIRDITE



"ANGERBA" shpk

Adresa: Rr. "Irfan Tomini" Tirane.
 Cel: 069 20 95 862
 E-mail: burhanhafizi@gmail.com

VENDOSHJA
 Bashkia Mirdite

TITULLI I PROJEKTI

PLOTESIMI I RRJETIT UJTES FSHATI
 KODER RRESHEN, LAGJA ZALLI ZMESE"

FAZA E PROJEKTIMIT:

PROJEKT ZBATIMI

TITULLI I VIZATIMIT:

PROFLET TERTHORE
 TE TRASESE, SHPERNDARJE

Grupi i Projektimit:

Ing. Burhan HAFIZI
 Ing. Servet VERÇANI
 Ing. Gerti HAFIZI



Shkalla 1:100

Data: Shtator 2022

FLETA Nr.32

PROFLET TERTHORE

Km.0+111.59 (PK-13)

Siperfaqe Germimi = 5.71 m²

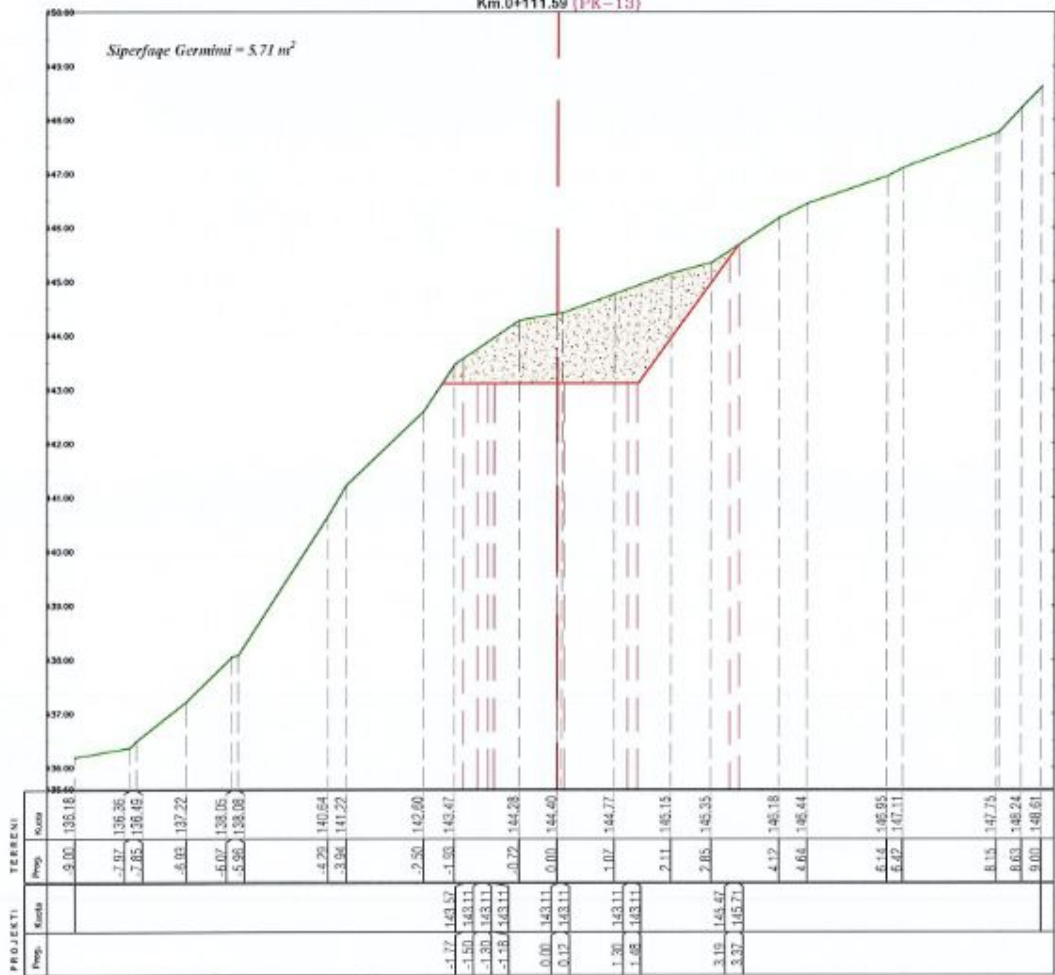

Km.0+120.92 (PK-14)

Siperfaqe Germimi = 6.92 m²

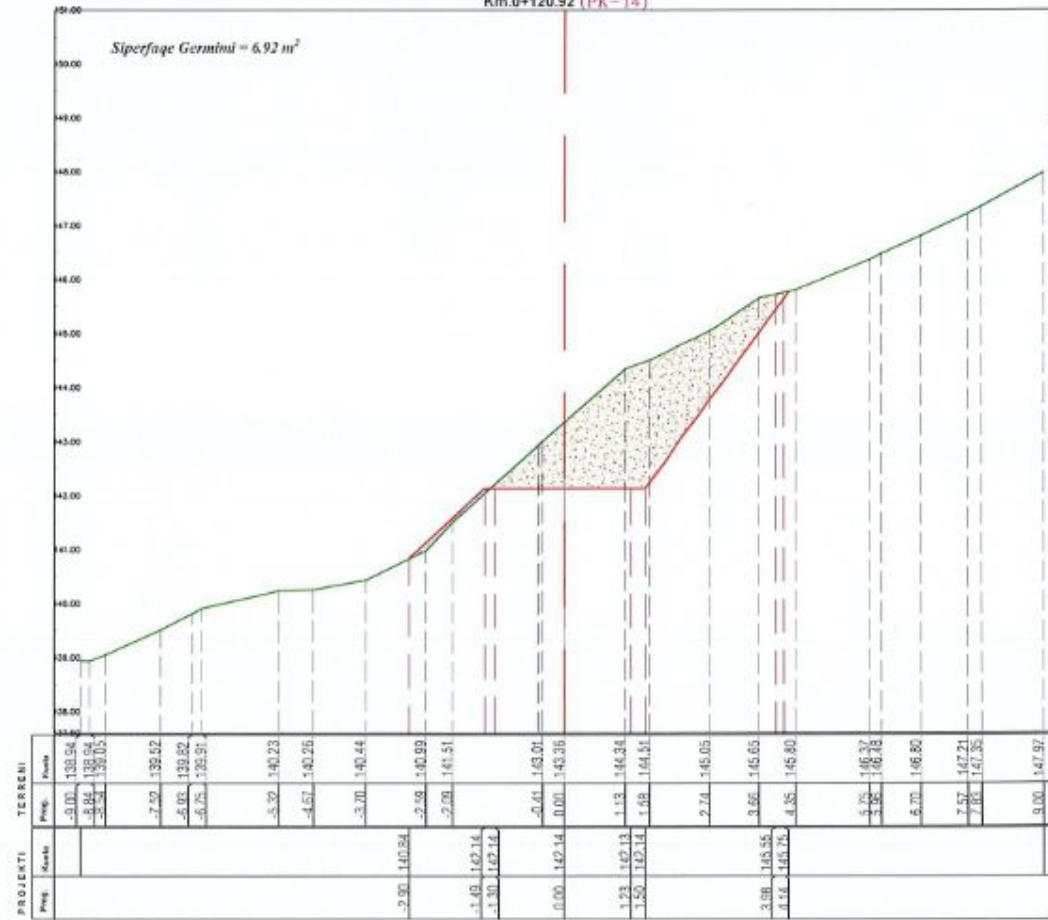

POROSITESI

BASHKIA MIRDITE



"ANGERBA" shpk

Adresa: Rr. "Wfan Tomini" Tirane.
 Cel: 069 20 95 862
 E-mail: burhanhafizi@gmail.com

VENDODHIA

Bashkia Mirdite

TITULLI I PROJEKTI

FLOTESIMI I RRJETIT UHTES FSHATI
 KODER RRESHEN, LAGJA ZALLI ZMESE"

FAZA E PROJEKTIMIT :

PROJEKT ZBATIMI

TITULLI I VIZATIMIT :

PROFLET TERTHORE
 TE TRASESE, SIPERNDARJE

Grupi i Projektorit :

Ing. Burhan HAFIZI
 Ing. Servet VERÇANI
 Ing. Gerti HAFIZI



Skala 1:100

Data: Shtator 2022

FLETA Nr.33

PROFLET TERTHORE

Km.0+133.68 (PK-15)

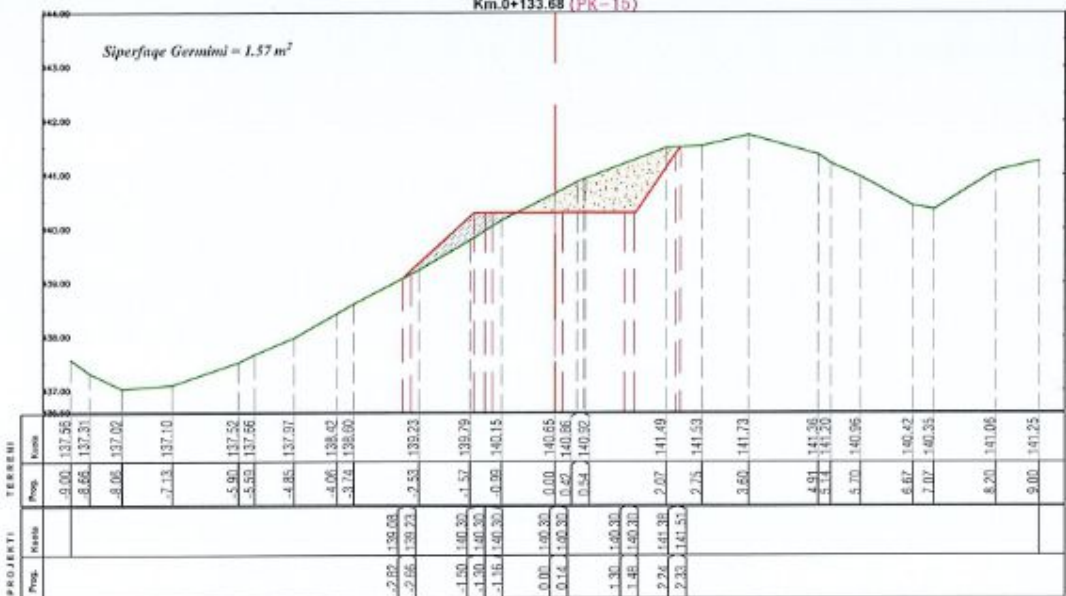

Km.0+146.92 (PK-17)

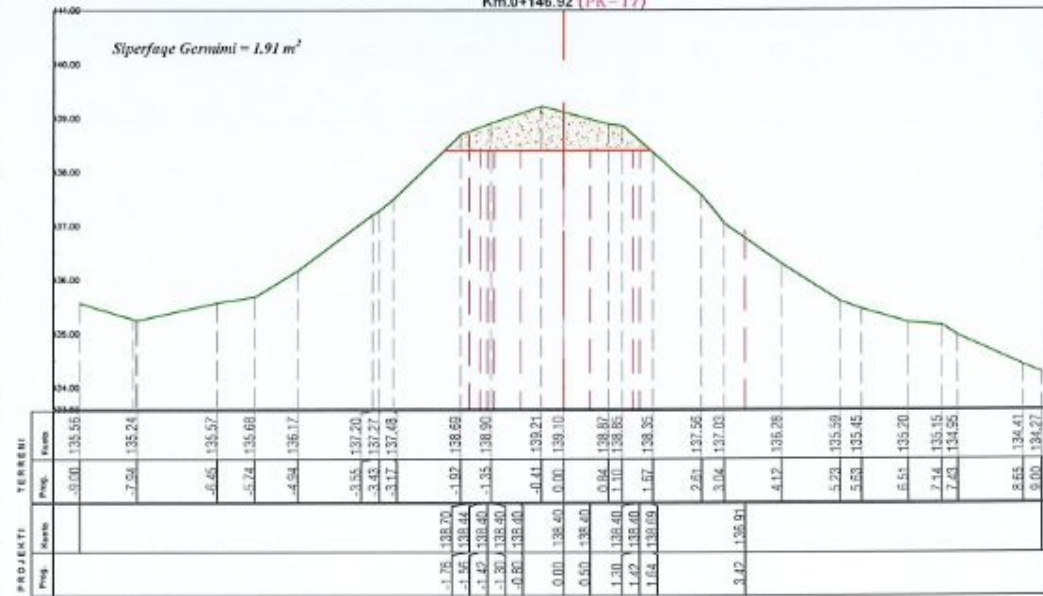

Km.0+140.94 (PK-16)

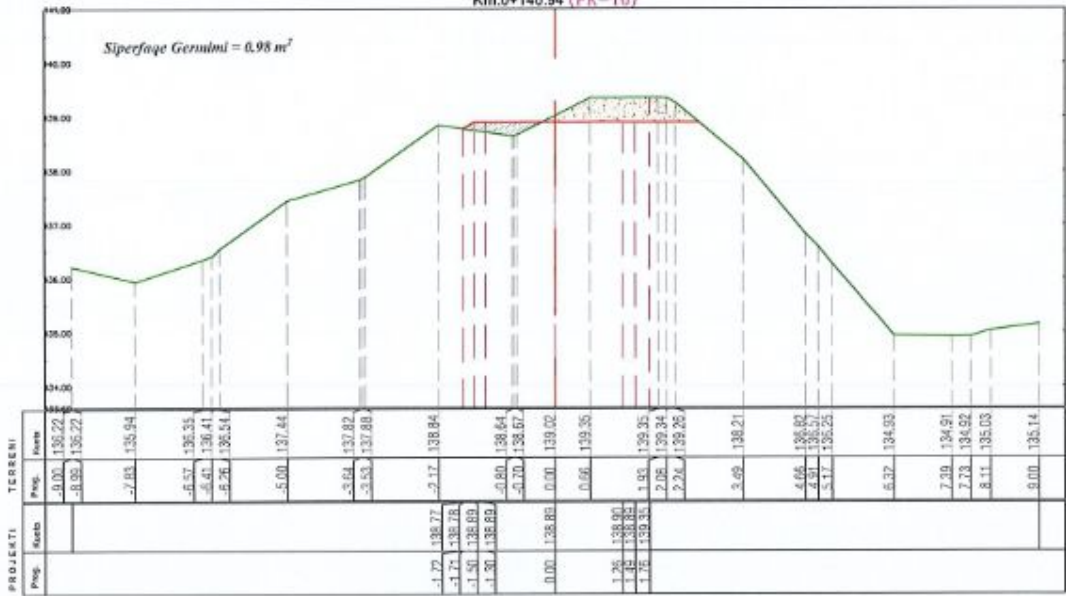

Km.0+158.08 (PK-18)

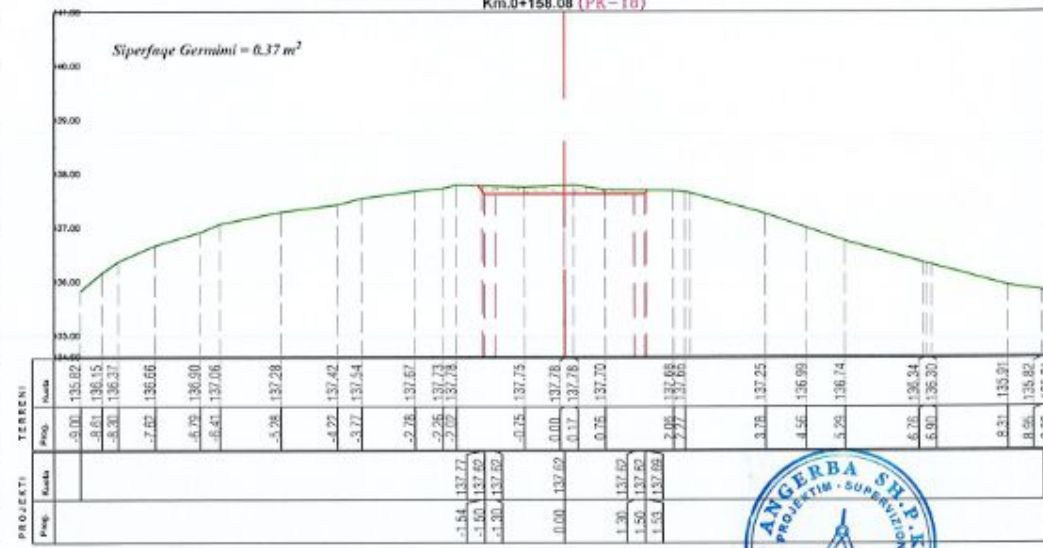

POROSITESI

BASHKIA MIRDITE



"ANGERBA" shpk

Adresa: Rr. 'Yrfan Tomini' Tirana.
Cei: 069 20 95 862
E-mail: burhanhafizi@gmail.com

VENDODHJA
Bashkia Mirdite

TITULLI I PROJEKTI

PLOTESIMI I RRJETIT UIJTES FSHATI
KODER RRESHEN, LAGJA ZALLI ZMESE"

FAZA E PROJEKTIMIT:
PROJEKT ZBATIMI

TITULLI I VIZATIMIT:
PROFLET TERTHORE
TE TRASESE, SHPERNDARJE

Grupi i Projektimit:

Ing. Burhan HAFIZI
Ing. Servet VERÇANI
Ing. Gerti HAFIZI



Skalla 1:100

Data: Shtator 2022

FLETA Nr.34

SKEMAT HIDRAULIKE

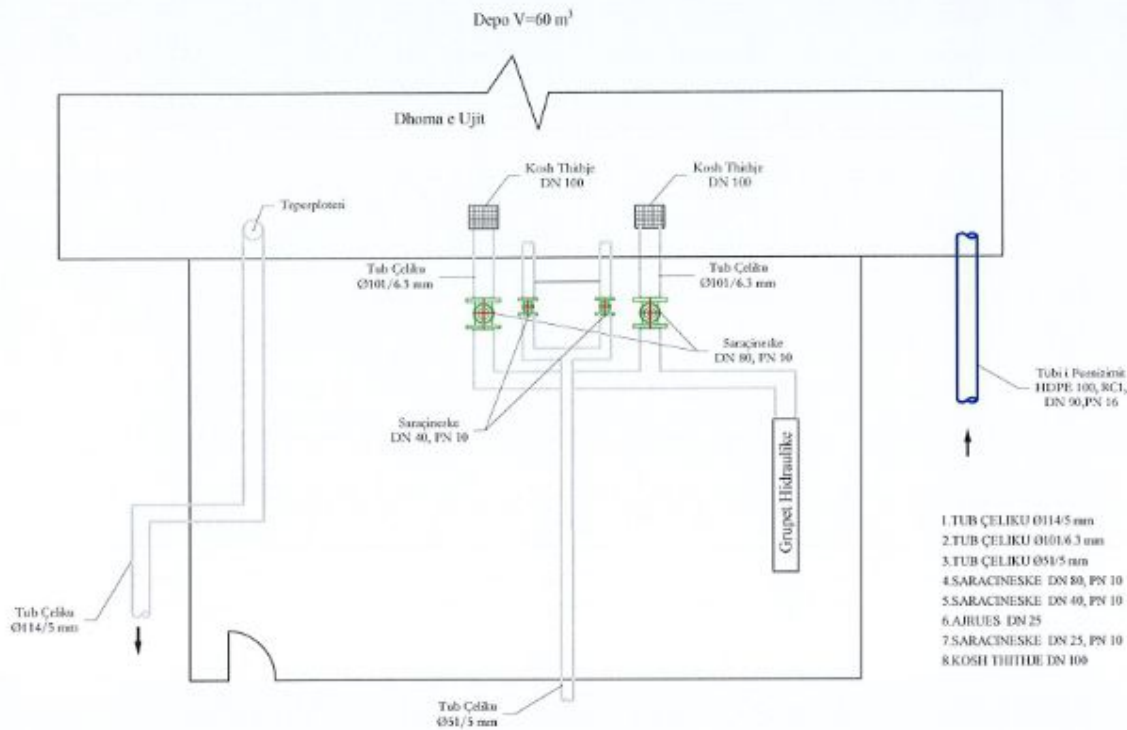

- | | |
|----------------------------|----------|
| 1.TUB ÇELIKU Ø114/5 mm | L= 10 ML |
| 2.TUB ÇELIKU Ø101/6.3 mm | L= 12 ML |
| 3.TUB ÇELIKU Ø51/5 mm | L= 12 ML |
| 4.SARACINESKE DN 80, PN 10 | Copë 2 |
| 5.SARACINESKE DN 40, PN 10 | Copë 2 |
| 6.AJRUES DN 25 | Copë 1 |
| 7.SARACINESKE DN 25, PN 10 | Copë 1 |
| 8.KOSH THIBJE DN 100 | Copë 2 |

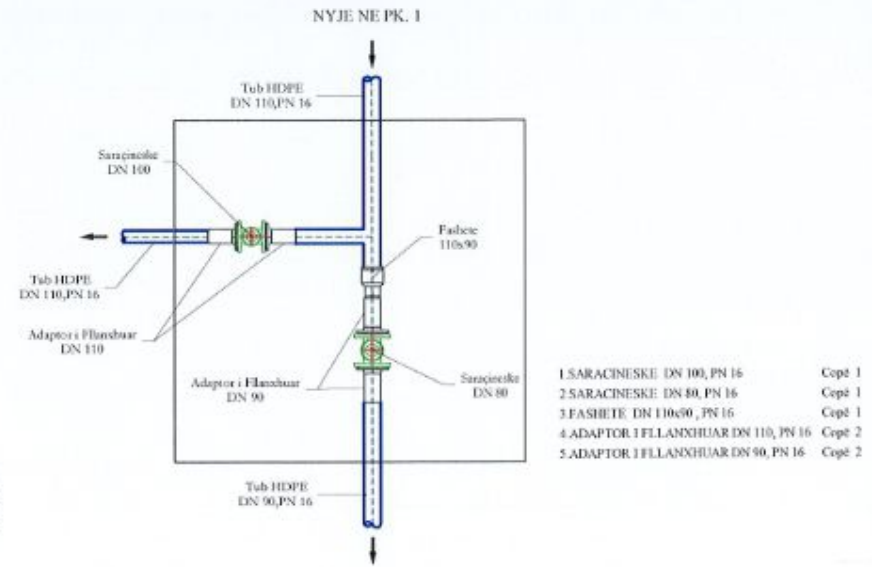

- | | |
|--------------------------------------|--------|
| 1.SARACINESKE DN 100, PN 16 | Copë 1 |
| 2.SARACINESKE DN 80, PN 16 | Copë 1 |
| 3.FASHETE DN 110x90, PN 16 | Copë 1 |
| 4.ADAPTOR I FLLANXHUAR DN 110, PN 16 | Copë 2 |
| 5.ADAPTOR I FLLANXHUAR DN 90, PN 16 | Copë 2 |

PUSETE AJRIMI NE PK.47,65,86, PRERJE

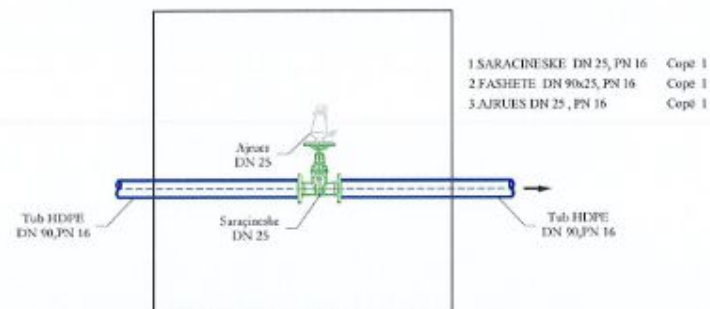

<p>POROSITESI</p>	<p>"ANGERBA" shpk</p> <p>Adresa:Rr. "Irfan Tomini" Tirane. Cel: 069 20 95 882 E-mail: burhanhafizi@gmail.com</p>	<p>VENDOSHJA <i>Bashkia Mirdite</i></p> <p>TITULLI I PROJEKTTIT <i>PLOTESIMI I RRJETIT UJITES FSHATI KODER RRESHEN, LAG-JA ZALLI ZMESE"</i></p>	<p>FAZA E PROJEKTIMIT: PROJEKT ZBATIMI</p> <p>TITULLI I VIZATIMIT: SKEMAT HIDRAULIKE TUBACIONI I DERGIMIT</p>	<p>Grupi i Projektimit Ing. Burhan HAFIZI Ing. Servet VERÇANI Ing. Gerti HAFIZI</p>	<p>Shkalla Data: Shtator 2022 FLETA Nr.35</p>
<p>BASHKIA MIRDITE</p>					

PUSETE KOMANDIMI TIP (1.5x1.5x1.5)M

PLANIMETRIA
SH 1:25

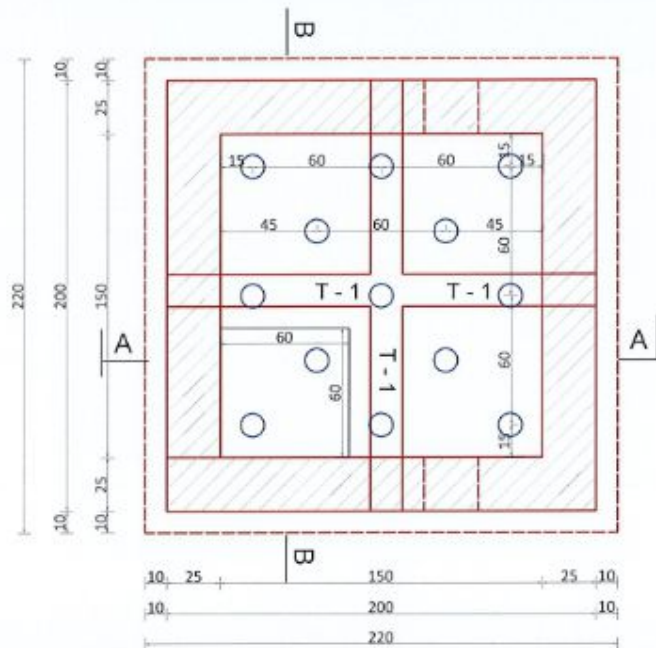

PRERJA A-A
SH 1:25

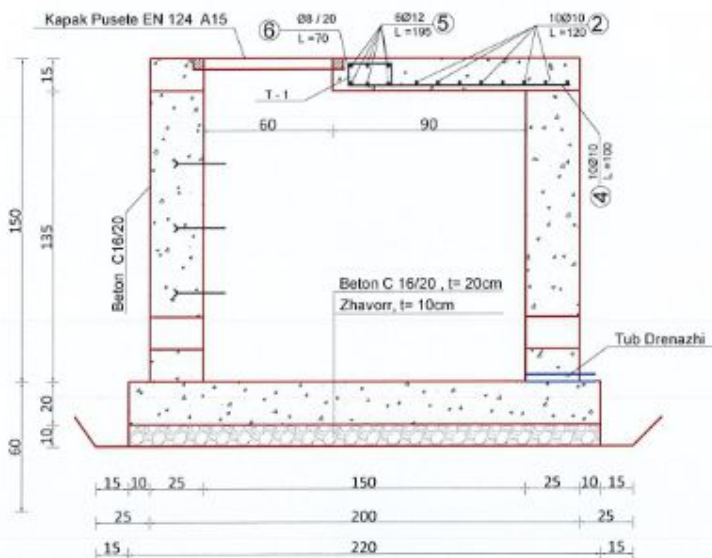

PRERJA B-B
SH 1:25



TABELA E ARMIMIT

ELEMENTI		SPECIFIKIME E ARMIMIT				PER 1 ELEMENT			PESHA		
TYPE	PIECE	NR	Ø	L/cm	COPE	L/m	Ø	IL/m	P/kg	TOTAL	
SECTION 1-1 SECTION 2-2		1	10	210	10	21	8	28	0.395	11.06	
		2	10	120	10	12	10	62	0.617	38.25	
		3	10	190	10	19	12	23.4	0.888	20.78	
		4	10	100	10	10	16	5.2	1.578	8.21	
		5	12	195	12	23.4					78.30
		7	8	70	40	28					
		8	16	110	2	2.2					
		9	16	100	3	3.0					

SHENIM:
PER PIKETAT SE KU DO TE ZBATOHET, SHIKO PROFILET
GJATESORE TE PROJEKTTIT.

ARMIMI I SOLETES
SH 1:25

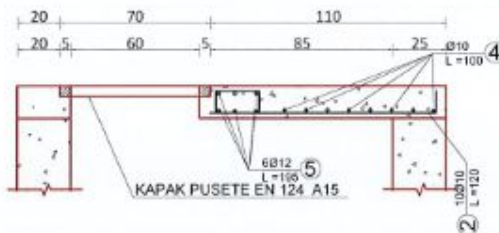
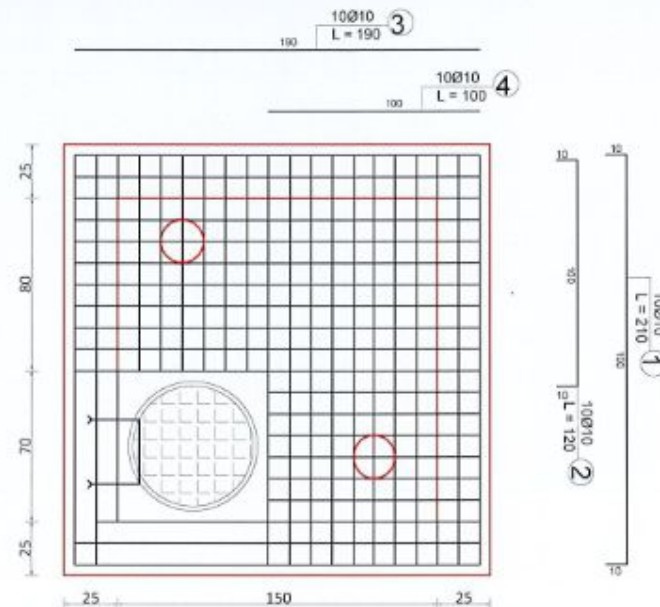

T-1
SH 1:25

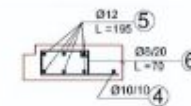

GANXHA
SH 1:25



TABELA E VOLUMEVE TE PUNES

Pusetat (1.5x1.5x1.5) m;			
Nr.	Emertimi	Njesia	Sasia
1	Germim dheu toke e forte	m ²	6
2	Mbushje me dhe te germuar	m ²	3
3	Shtrese zhavorri nen beton	m ²	0.48
4	Beton C 16/20 per puseten.	m ²	4.13
5	Hekur betoni Ø>12, soleta.	kg	74
6	Hekur betoni Ø>12, shkalle.	kg	7.9
7	Dy duar bitum per mung.	m ²	12.4
8	F.V.tub PE DN 250	ml	20
9	Kapak gize	cap	1

POROSITESI

BASHKIA MIRDITE

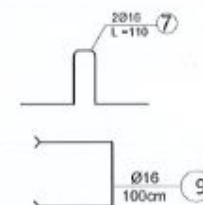

"ANGERBA" shpk

Adresa: Rr. "Irfan Tomini" Tirane.
Cel: 069 20 95 862
E-mail: burhanhafizi@gmail.com

VENDOSHA

Bashkia Mirdite

TITULLI I PROJEKTTIT

PLOTESIMI I RRJETIT UJTES FSHATI
KODER RRESHEN, LAGJA ZALLI ZMESE"

FAZA E PROJEKTTIMIT:

PROJEKT ZBATIMI

TITULLI I VIZATIMIT:

PUSETE KOMANDIMI
PLAN, PRERJE, ARMIMI

Grupi i Projektimit

Ing. Burhan HAFIZI

Ing. Servet VERÇAN

Ing. Gerti HAFIZI

Shkalla 1:25

Data: Shtator 2022

FLETA Nr.36

PUSETE AJRIMI TIP (0.5X0.5X1) M

PLANIMETRIA
SH. 1:25

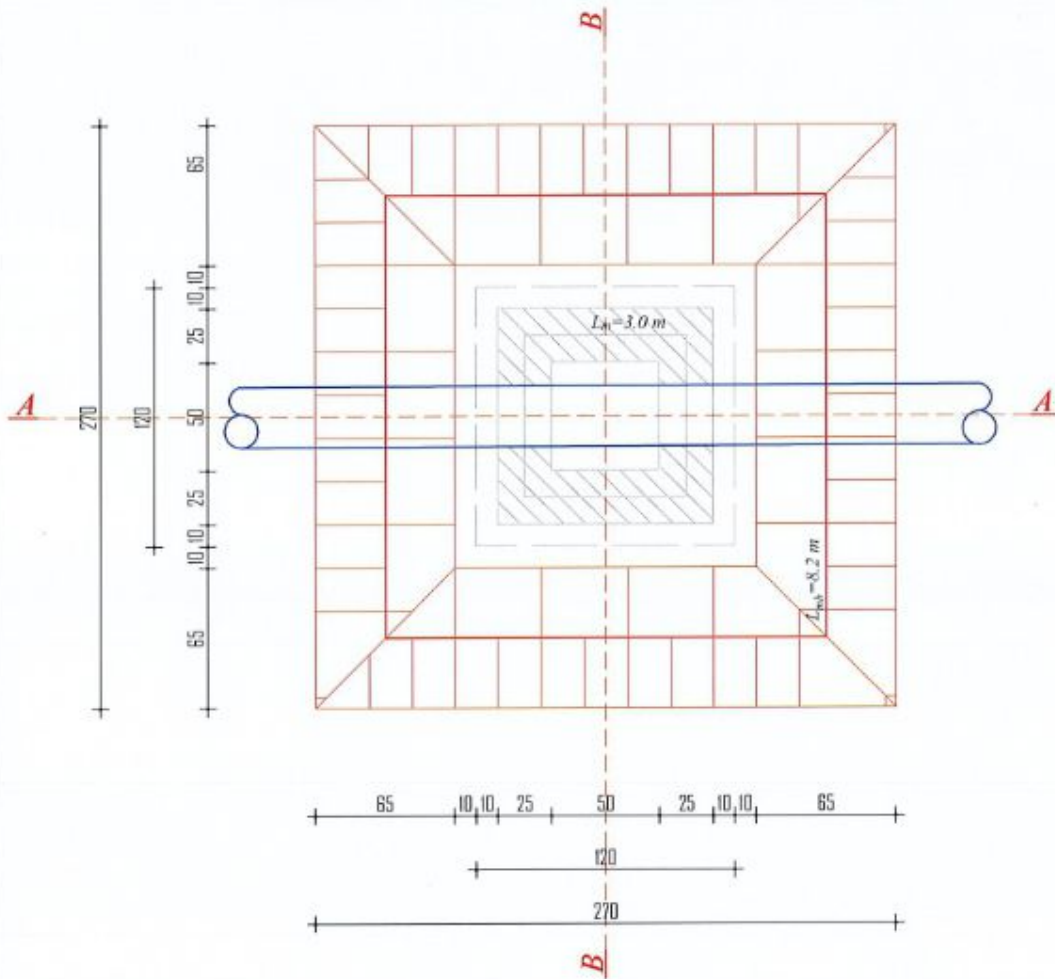

PRERJA A-A
SH. 1:25

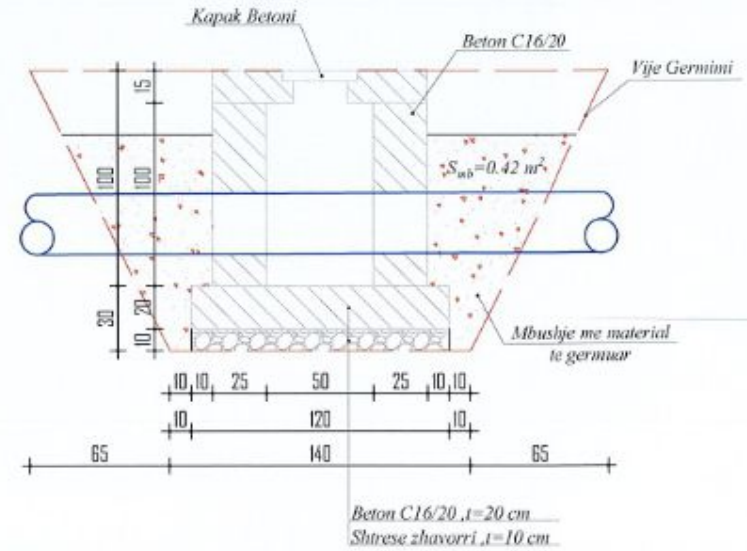

PRERJA B-B
SH. 1:25

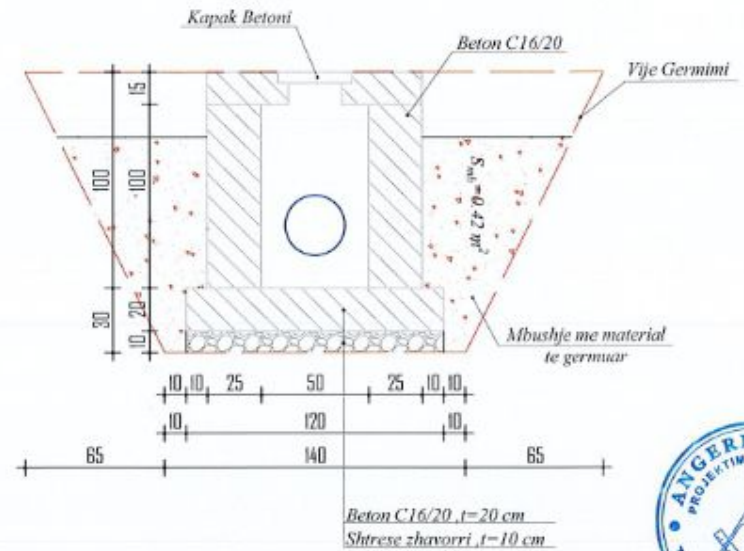

<p>POROSITESI</p>	<p>"ANGERBA" shpk Adresa: Rr. "Yfan Tomini" Tirane. Cel: 069 20 95 862 E-mail: burhanhafizi@gmail.com</p>	<p>VENDORËSIA Bashkia e Mirditës</p> <p>TITULLI I PROJEKTIT PLOTESIMI I RRJETIT UJITES FSHATI KODER RRESHEN, LAGJA ZALLI ZMESE"</p>	<p>FAZA E PROJEKTIMIT : PROJEKT ZBATIMI</p> <p>TITULLI I VEZATIMIT : PUSETE AJRIMI TIP</p>	<p>Grupi i Projektimit Ing. Burhan HAFIZI Ing. Servet VERÇANI Ing. Gerti HAFIZI</p> <p>Shkalla 1:25 Data: Shtator 2022 FLETA Nr.37</p>
<p>BASHKIA MIRDITE</p>				

PUSETA NE LAGJEN SHESH

PLANIMETRIA
SH. 1:25

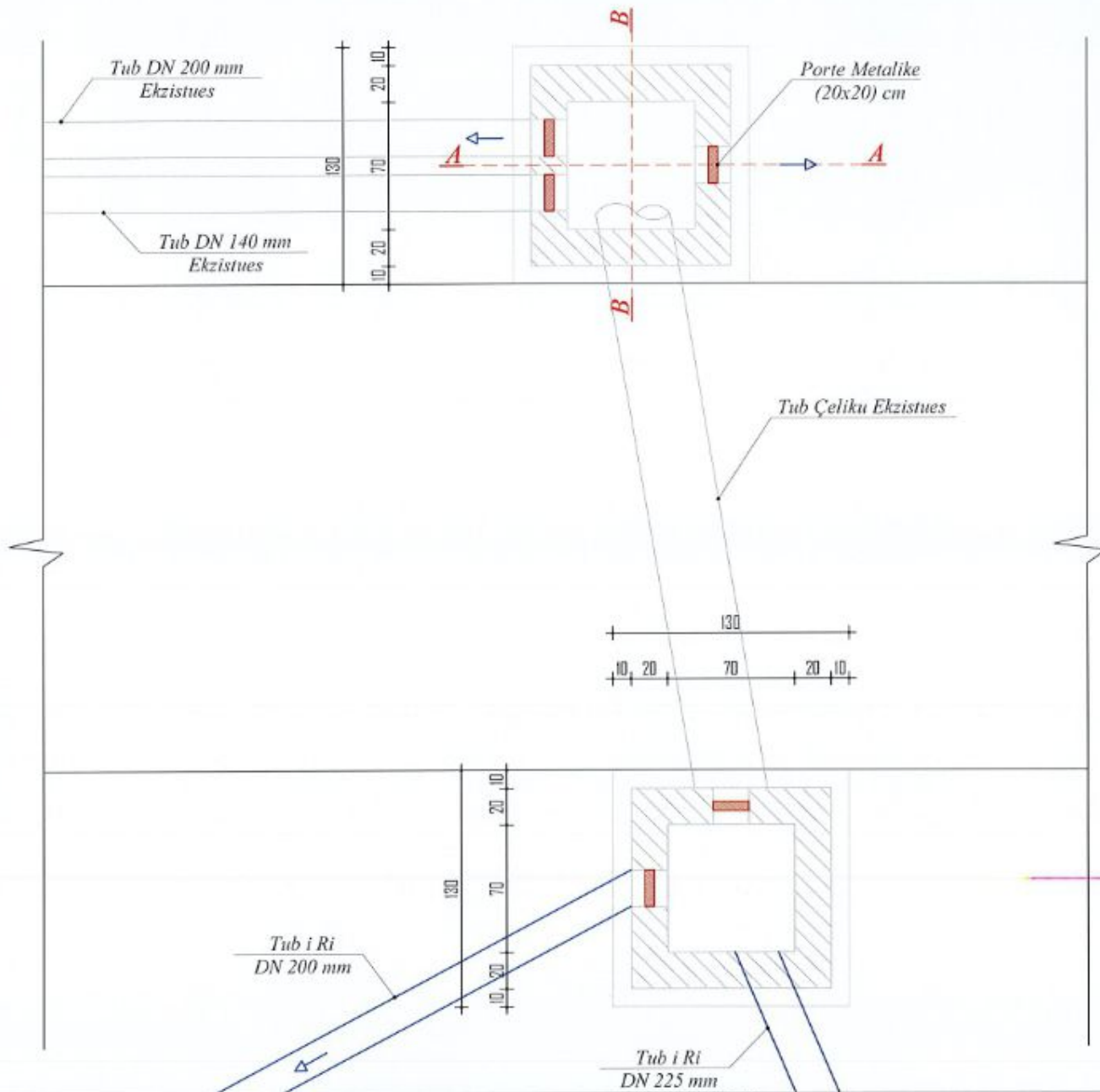

PRERJA B-B
SH. 1:25

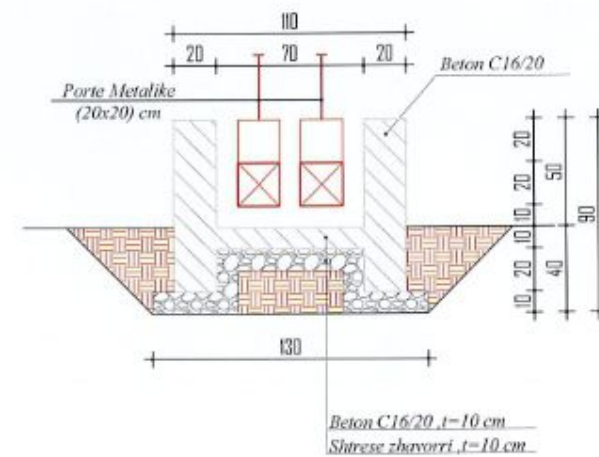

PRERJA A-A
SH. 1:25

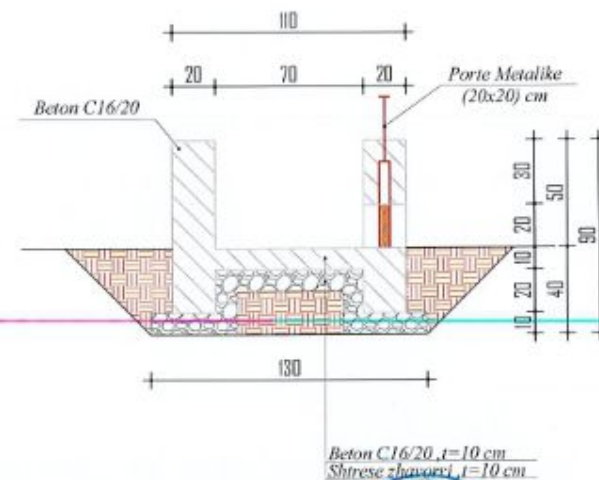

POROSITESI

BASHKIA MIRDITE



"ANGERBA" shpk

Adresa: Rr. "Mfan Tomini" Tirane.
Cel: 069 20 95 862
E-mail: burhanhafizi@gmail.com

VENDODHJA

Bashkia Mirdite

TITULLI I PROJEKTT

PLOTESIMI I RRJETIT UJITES FSHATI
KODER RRESHEN, LAGJA ZALLI ZMESE"

FAZA E PROJEKTTMIT :

PROJEKT ZBATIMI

TITULLI I VEZATIMIT :

PUSETA NE LAGJEN SHESH
PLAN, PRERJE

Grupi i Projektimit

Ing. Burhan HAFIZI

Ing. Servet VERÇANI

Ing. Gerti HAFIZI



Shkalla 1:25

Data: Shtator 2022

FLETA Nr.38