



REPUBLIKA E SHQIPERISË
BASHKIA MAT

MIRATOHET
BASHKIA MAT
KRYETARI
Z.Agron MALAJ

PROJEKT ZBATIMI

OBJEKTI:

Ndertimi i rruges fshati Bater, bashkia Mat

	POROSITESI : BASHKIA MAT	Emertimi: Kapaku	Drejtues i projektit	Projektues		SHKALLA	FLETA
	OBJEKTI: "Ndertimi i rruges fshati Bater ,bashkia Mat"	 "Imperium Construction", shpk Adresa: njesi Bashkiake nr.9 Rruga "Shyqyri Peza" Pallati 21, Hyrja 1,Kati 2 ,Tirane	Adm. Arber TOLA	Inxh. Elton LLAPUSHI	Mek. Bujar MERAJ	1- 500	1 - 01
				Inxh. Ilir Hodaj	Elek. Altin ALLKAJ	MAT 2022	Format A3
				Ark. Rigert HYRA	Top. Iv BEQARI		

LEGJENDA:

- 1.HOROGRAFIA E RRUGES
- 2.PLAN RILEVIMI,GJENDJA EKZISTUESE
- 3.PLANPIKETIMI I RRUGE
- 4.PLANIMETRIA E RRUGES
- 5.PLANIMETRIA E SINJALISTIKES
- 6.PLANIMETRIA E NDRICIMI
- 7.PROFILI GJATESORI RRUGES
- 8.PROFILET TERTHORE TIP TE RRUGES
- 9.PROFILET TERTHORETE RRUGES
- 10.DETAJET E RRUGES
- 11.TABELAT E VOLUMEVE TE RRUGES

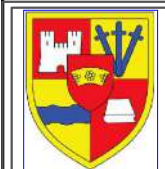

POROSITESI : BASHKIA MAT

OBJEKTI: "Ndertimi i rruges fshati Bater ,bashkia Mat"

Emertimi: Kapaku



“Imperium Construction”, shpk
Adresa: njesi Bashkiake nr.9 Rruga “Shyqyri Peza”
Pallati 21, Hyrja 1,Kati 2 ,Tirane

Drejtues i projektit

Adm. Arber TOLA

Projektues

Inxh. Elton LLAPUSHI

Inxh.Illir Hodaj

Ark. Rigert HYRA

Mek. Bujar MERAJ

Elek. Altin ALLKAJ

Top. Iv BEQARI

SHKALLA

1- 500

MAT 2022

FLETA

1 - 01

Format A3



REPUBLIKA E SHQIPERISË
BASHKIA MAT

PROJEKT ZBATIMI

OBJEKTI:

Ndertimi i rruges fshati Bater ,bashkia Mat
HOROGRAFIA

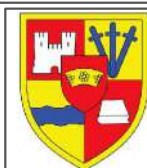

POROSITESI : BASHKIA MAT

OBJEKTI: "Ndertimi i rruges fshati Bater ,bashkia Mat"

Emertimi: HOROGRAFIA



"Imperium Construction", shpk
Adresa: njesi Bashkiake nr.9 Rruga "Shyqyri Peza"
Pallati 21, Hyrja 1,Kati 2 ,Tirane

Drejtues i projektit

Adm. Arber TOLA

Projektues

Inxh. Elton LLAPUSHI
Inxh. Ilir Hodaj
Ark. Rigert HYRA

Mek. Bujar MERAJ
Elek. Altin ALLKAJ
Top. Iv BEQARI

SHKALLA

1- 500

MAT 2022

FLETA

1 - 01

Format A3

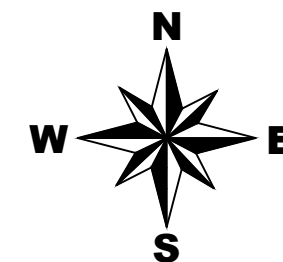

POROSITESI : BASHKIA MAT

OBJEKTI: "Ndertimi i rruges fshati Bater ,bashkia Mat"

Emertimi: HOROGRAFIA



"Imperium Construction", shpk
 Adresa: njesi Bashkiake nr.9 Rruga "Shyqyri Peza"
 Pallati 21, Hyrja 1,Kati 2 ,Tirane

Drejtues i projektit

Adm. Arber TOLA

Projektues

Inxh. Elton LLAPUSHI	Mek. Bujar MERAJ	
Inxh. Ilir Hodaj	Elek. Altin ALLKAJ	
Ark. Rigert HYRA	Top. Iv BEQARI	

SHKALLA

1- 500

MAT 2022

FLETA

1 - 01

Format A3

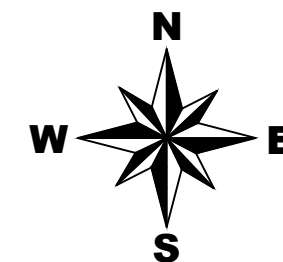

POROSITESI : BASHKIA MAT

OBJEKTI: "Ndertimi i rruges fshati Bater ,bashkia Mat"

Emertimi: HOROGRAFIA



"Imperium Construction", shpk
 Adresa: njesi Bashkiake nr.9 Rruga "Shyqyri Peza"
 Pallati 21, Hyrja 1,Kati 2 ,Tirane

Drejtues i projektit

Adm. Arber TOLA

Projektues

Inxh. Elton LLAPUSHI	Mek. Bujar MERAJ	
Inxh. Ilir Hodaj	Elek. Altin ALLKAJ	
Ark. Rigert HYRA	Top. Iv BEQARI	

SHKALLA

1- 500



MAT 2022

FLETA

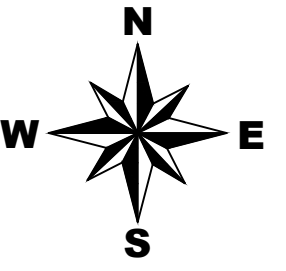

1 - 01

Format A3

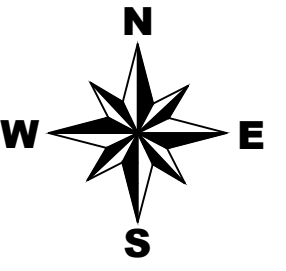
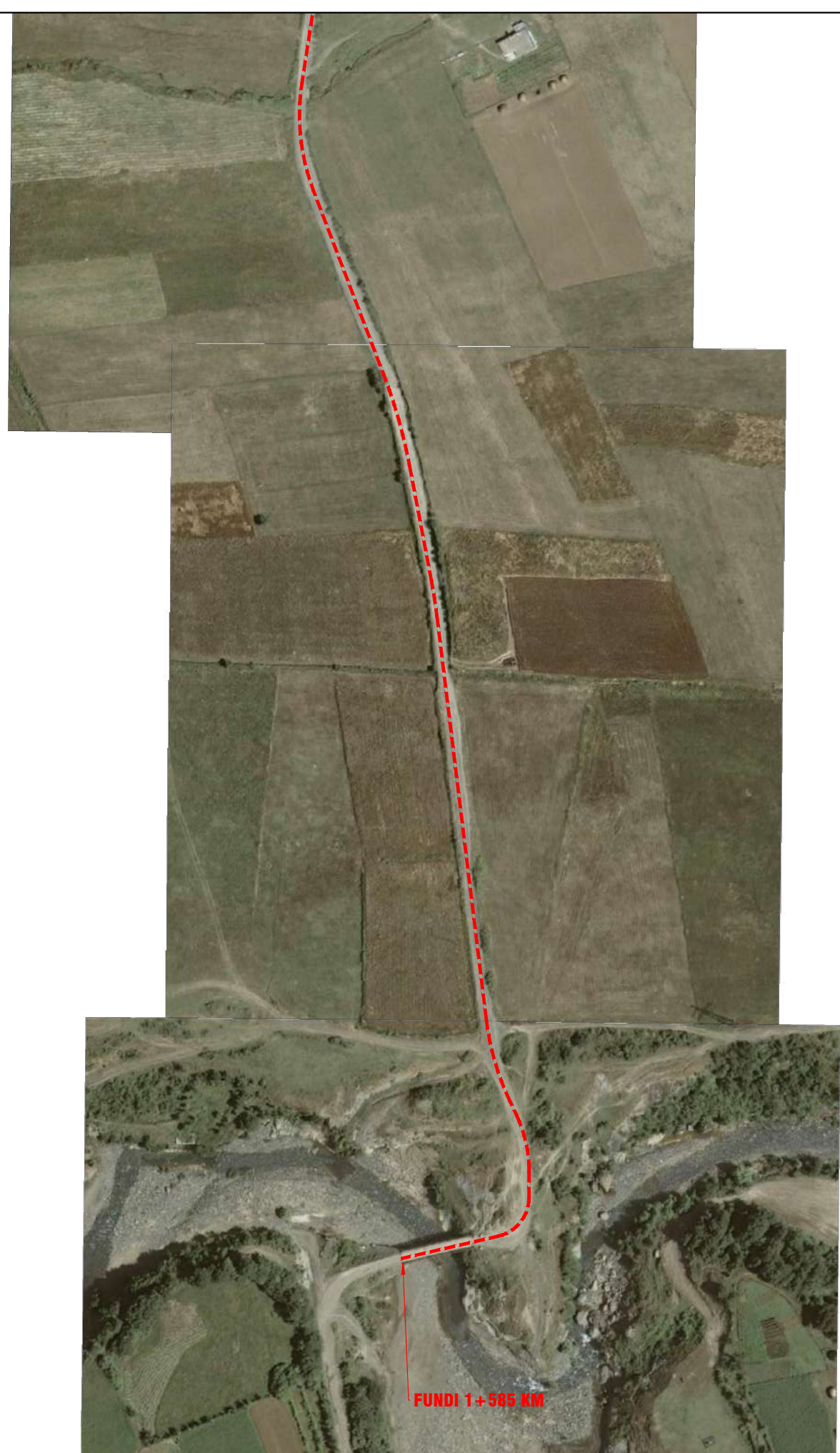

 POROSITESI : BASHKIA MAT	Emertimi: HOROGRAFIA		Drejtues i projektit		Projektues		SHKALLA	FLETA
	OBJEKTI: "Ndertimi i rruges fshati Bater ,bashkia Mat"	 "Imperium Construction", shpk Adresa: njesi Bashkiake nr.9 Rruga "Shyqyri Peza" Pallati 21, Hyrja 1,Kati 2 ,Tirane	Adm. Arber TOLA	Inxh. Elton LLAPUSHI Inxh. Ilir Hodaj Ark. Rigert HYRA	Mek. Bujar MERAJ Elek. Altin ALLKAJ Top. Iv BEQARI	1- 500	1 - 01	MAT 2022



	POROSITESI : BASHKIA MAT		Emertimi: HOROGRAFIA		Drejtues i projektit		Projektues		SHKALLA	FLETA								
	OBJEKTI: "Ndertimi i rruges fshati Bater ,bashkia Mat"		 "Imperium Construction", shpk Adresa: njesi Bashkiake nr.9 Rruga "Shyqyri Peza" Pallati 21, Hyrja 1,Kati 2 ,Tirane		Adm. Arber TOLA		<table border="1"> <tr> <td>Inxh. Elton LLAPUSHI</td> <td>Mek. Bujar MERAJ</td> <td></td> </tr> <tr> <td>Inxh. Ilir Hodaj</td> <td>Elek. Altin ALLKAJ</td> <td></td> </tr> <tr> <td>Ark. Rigert HYRA</td> <td>Top. Iv BEQARI</td> <td></td> </tr> </table>		Inxh. Elton LLAPUSHI	Mek. Bujar MERAJ		Inxh. Ilir Hodaj	Elek. Altin ALLKAJ		Ark. Rigert HYRA	Top. Iv BEQARI		1- 500
Inxh. Elton LLAPUSHI	Mek. Bujar MERAJ																	
Inxh. Ilir Hodaj	Elek. Altin ALLKAJ																	
Ark. Rigert HYRA	Top. Iv BEQARI																	
								MAT 2022	Format A3									



REPUBLIKA E SHQIPERISË
BASHKIA MAT

PROJEKT ZBATIMI

OBJEKTI:

Ndertimi i rruges fshati Bater, bashkia Mat
GJENDJA EKZISTUESE

LEGJENDA	
	URE
	MUR
	RRUGE EKZ
	RELIEVI
	URE METALIKE



POROSITESI : BASHKIA MAT

OBJEKTI: "Ndertimi i rruges fshati Bater ,bashkia Mat"

Emertimi: GJENDJA EKZISTUESE



"Imperium Construction", shpk
Adresa: njesi Bashkiake nr.9 Rruga "Shyqyri Peza"
Pallati 21, Hyrja 1,Kati 2 ,Tirane

Drejtues i projektit

Adm. Arber TOLA

Projektues

Inxh. Elton LLAPUSHI
Inxh. Ilir Hodaj
Ark. Rigert HYRA

Mek. Bujar MERAJ
Elek. Altin ALLKAJ
Top. Iv BEQARI

SHKALLA

1- 500

MAT 2022

FLETA

1 - 01

Format A3



LEGJENDA	
—	URE
—	MUR
—	RRUGE EKZ
—	RELIEVI
—	URE METALIKE



POROSITESI : BASHKIA MAT

OBJEKTI: "Ndertimi i rruges fshati Bater ,bashkia Mat"

Emertimi: **GJENDJA EKZISTUESE**



“Imperium Construction”, shpk
 Adresa: njesi Bashkiake nr.9 Rruga “Shyqyri Peza”
 Pallati 21, Hyrja 1,Kati 2 ,Tirane

Drejtues i projektit

Adm. Arber TOLA

Projektues	
Inxh. Elton LLAPUSHI	Mek. Bujar MERAJ
Inxh. Ilir Hodaj	Elek. Altin ALLKAJ
Ark. Rigert HYRA	Top. Iv BEQARI

SHKALLA	FLETA
1- 500	1 - 01
MAT 2022	Format A3



LEGJENDA	
—	URE
—	MUR
—	RRUGE EKZ
—	RELIEVI
—	URE METALIKE



POROSITESI : BASHKIA MAT

OBJEKTI: "Ndertimi i rruges fshati Bater ,bashkia Mat"

Emertimi: **GJENDJA EKZISTUESE**



"Imperium Construction", shpk
 Adresa: njesi Bashkiake nr.9 Rruga "Shyqyri Peza"
 Pallati 21, Hyrja 1,Kati 2 ,Tirane

Drejtues i projektit

Adm. Arber TOLA

Projektues

Inxh. Elton LLAPUSHI	Mek. Bujar MERAJ
Inxh. Ilir Hodaj	Elek. Altin ALLKAJ
Ark. Rigert HYRA	Top. Iv BEQARI

SHKALLA

1- 500

MAT 2022

FLETA

1 - 02

Format A3



LEGJENDA	
—	URE
—	MUR
—	RRUGE EKZ
—	RELIEVI
—	URE METALIKE

	POROSITESI : BASHKIA MAT
	OBJEKTI: "Ndertimi i rruges fshati Bater ,bashkia Mat"

Emertimi: GJENDJA EKZISTUESE
 "Imperium Construction", shpk Adresa: njesi Bashkiake nr.9 Rruga "Shyqyri Peza" Pallati 21, Hyrja 1,Kati 2 ,Tirane

Drejtues i projektit
Adm. Arber TOLA

Projektues	
Inxh. Elton LLAPUSHI	Mek. Bujar MERAJ
Inxh. Ilir Hodaj	Elek. Altin ALLKAJ
Ark. Rigert HYRA	Top. Iv BEQARI

SHKALLA	FLETA
1- 500	1 - 03
MAT 2022	Format A3



LEGJENDA	
	URE
	MUR
	RRUGE EKZ
	RELIEVI
	URE METALIKE



	POROSITESI : BASHKIA MAT
	OBJEKTI: "Ndertimi i rruges fshati Bater ,bashkia Mat"

Emertimi: GJENDJA EKZISTUESE
"Imperium Construction", shpk Adresa: njesi Bashkiake nr.9 Rruga "Shyqyri Peza" Pallati 21, Hyrja 1,Kati 2 ,Tirane

Drejtues i projektit
Adm. Arber TOLA

Projektues	
Inxh. Elton LLAPUSHI	Mek. Bujar MERAJ
Inxh. Ilir Hodaj	Elek. Altin ALLKAJ
Ark. Rigert HYRA	Top. Iv BEQARI

SHKALLA	FLETA
1- 500	1 - 04
MAT 2022	Format A3



LEGJENDA	
—	URE
—	MUR
—	RRUGE EKZ
—	RELIEVI
—	URE METALIKE

	POROSITESI : BASHKIA MAT
	OBJEKTI: "Ndertimi i rruges fshati Bater ,bashkia Mat"

Emertimi: GJENDJA EKZISTUESE
 "Imperium Construction", shpk Adresa: njesi Bashkiake nr.9 Rruga "Shyqyri Peza" Pallati 21, Hyrja 1,Kati 2 ,Tirane

Drejtues i projektit
Adm. Arber TOLA

Projektues	
Inxh. Elton LLAPUSHI	Mek. Bujar MERAJ
Inxh. Ilir Hodaj	Elek. Altin ALLKAJ
Ark. Rigert HYRA	Top. Iv BEQARI

SHKALLA	FLETA
1- 500	1 - 05
MAT 2022	Format A3



LEGJENDA	
—	URE
—	MUR
—	RRUGE EKZ
—	RELIEVI
—	URE METALIKE

	POROSITESI : BASHKIA MAT
	OBJEKTI: "Ndertimi i rruges fshati Bater ,bashkia Mat"

Emertimi: GJENDJA EKZISTUESE
 "Imperium Construction", shpk Adresa: njesi Bashkiake nr.9 Rruga "Shyqyri Peza" Pallati 21, Hyrja 1,Kati 2 ,Tirane

Drejtues i projektit	Adm. Arber TOLA
----------------------	-----------------

Projektues	
Inxh. Elton LLAPUSHI	Mek. Bujar MERAJ
Inxh. Ilir Hodaj	Elek. Altin ALLKAJ
Ark. Rigert HYRA	Top. Iv BEQARI

SHKALLA	FLETA
1- 500	1 - 06
MAT 2022	Format A3



LEGJENDA	
—	URE
—	MUR
—	RRUGE EKZ
—	RELIEVI
—	URE METALIKE



POROSITESI : BASHKIA MAT

OBJEKTI: "Ndertimi i rruges fshati Bater ,bashkia Mat"

Emertimi: **GJENDJA EKZISTUESE**



"Imperium Construction", shpk
 Adresa: njesi Bashkiake nr.9 Rruga "Shyqyri Peza"
 Pallati 21, Hyrja 1,Kati 2 ,Tirane

Drejtues i projektit

Adm. Arber TOLA

Projektues

Inxh. Elton LLAPUSHI	Mek. Bujar MERAJ
Inxh. Ilir Hodaj	Elek. Altin ALLKAJ
Ark. Rigert HYRA	Top. Iv BEQARI

SHKALLA

1- 500

MAT 2022

FLETA

1 - 07

Format A3

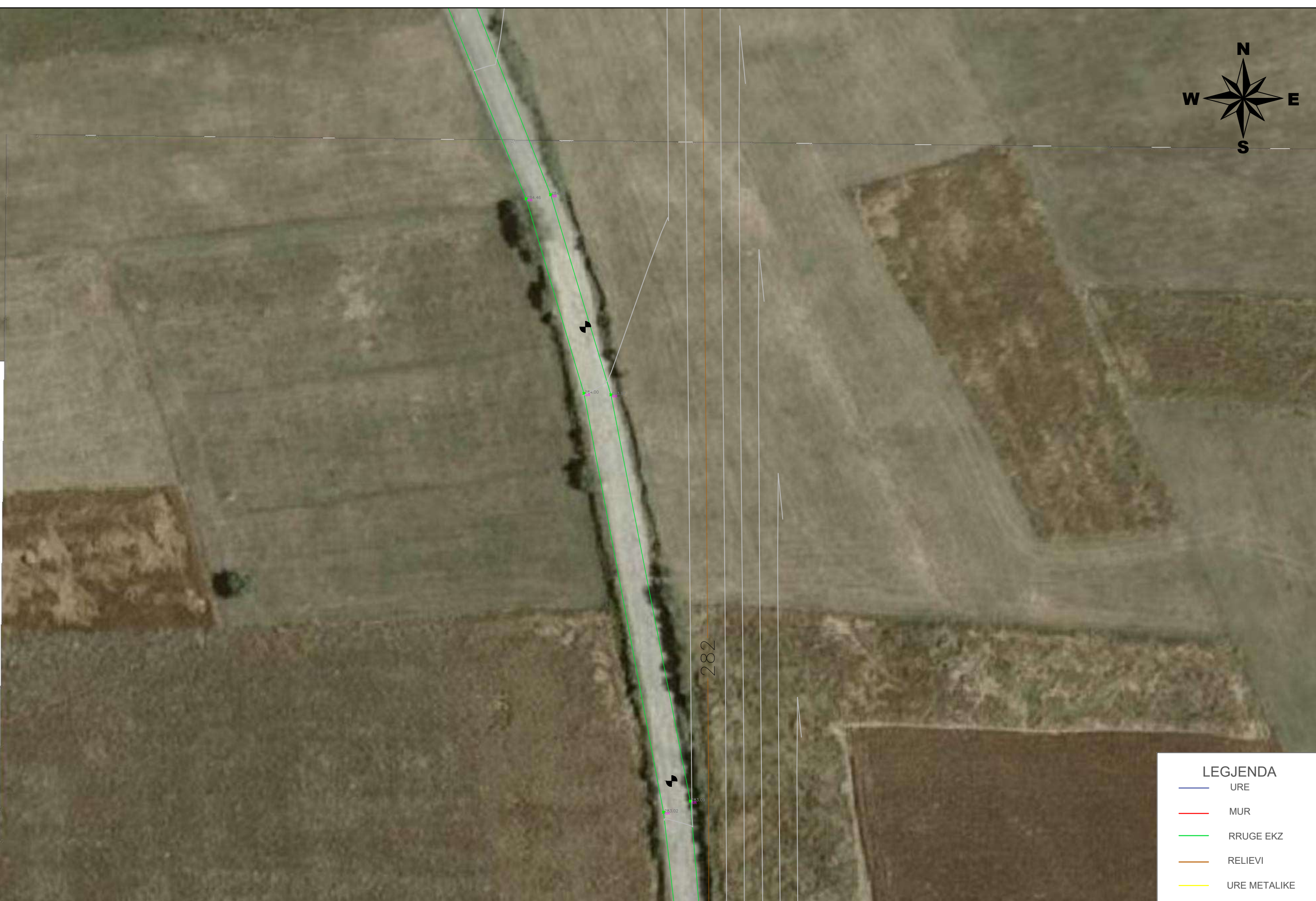

LEGJENDA	
	URE
	MUR
	RRUGE EKZ
	RELIEVI
	URE METALIKE



POROSITESI : BASHKIA MAT

OBJEKTI: "Ndertimi i rruges fshati Bater ,bashkia Mat"

Emertimi: **GJENDJA EKZISTUESE**



"Imperium Construction", shpk
 Adresa: njesi Bashkiake nr.9 Rruga "Shyqyri Peza"
 Pallati 21, Hyrja 1,Kati 2 ,Tirane

Drejtues i projektit

Adm. Arber TOLA

Projektues

Inxh. Elton LLAPUSHI	Mek. Bujar MERAJ	
Inxh. Ilir Hodaj	Elek. Altin ALLKAJ	
Ark. Rigert HYRA	Top. Iv BEQARI	

SHKALLA

1- 500

MAT 2022

FLETA

1 - 08

Format A3



82.58
82.55
82.59
82.44
82.72

276

LEGJENDA	
	URE
	MUR
	RRUGE EKZ
	RELIEVI
	URE METALIKE



POROSITESI : BASHKIA MAT

OBJEKTI: "Ndertimi i rruges fshati Bater ,bashkia Mat"

Emertimi: **GJENDJA EKZISTUESE**



“Imperium Construction”, shpk
Adresa: njesi Bashkiake nr.9 Rruga “Shyqyri Peza”
Pallati 21, Hyrja 1,Kati 2 ,Tirane

Drejtues i projektit

Adm. Arber TOLA

Projektues	
Inxh. Elton LLAPUSHI	Mek. Bujar MERAJ
Inxh. Ilir Hodaj	Elek. Altin ALLKAJ
Ark. Rigert HYRA	Top. Iv BEQARI

SHKALLA	FLETA
1- 500	1 - 09
MAT 2022	Format A3



82.58
82.55
82.59
82.44
82.72

276

LEGJENDA	
	URE
	MUR
	RRUGE EKZ
	RELIEVI
	URE METALIKE



POROSITESI : BASHKIA MAT
 OBJEKTI: "Ndertimi i rruges fshati Bater ,bashkia Mat"

Emertimi: **GJENDJA EKZISTUESE**
 **"Imperium Construction", shpk**
 Adresa: njesi Bashkiake nr.9 Rruga "Shyqyri Peza"
 Pallati 21, Hyrja 1,Kati 2 ,Tirane

Drejtues i projektit
 Adm. Arber TOLA

Projektues	
Inxh. Elton LLAPUSHI	Mek. Bujar MERAJ
Inxh. Ilir Hodaj	Elek. Altin ALLKAJ
Ark. Rigert HYRA	Top. Iv BEQARI

SHKALLA	FLETA
1- 500	1 - 10
MAT 2022	Format A3



LEGJENDA	
	URE
	MUR
	RRUGE EKZ
	RELIEVI
	URE METALIKE

	POROSITESI : BASHKIA MAT
	OBJEKTI: "Ndertimi i rruges fshati Bater ,bashkia Mat"

Emertimi: GJENDJA EKZISTUESE
"Imperium Construction", shpk Adresa: njesi Bashkiake nr.9 Rruga "Shyqyri Peza" Pallati 21, Hyrja 1,Kati 2 ,Tirane

Drejtues i projektit	Adm. Arber TOLA
----------------------	-----------------

Projektues	
Inxh. Elton LLAPUSHI	Mek. Bujar MERAJ
Inxh. Ilir Hodaj	Elek. Altin ALLKAJ
Ark. Rigert HYRA	Top. Iv BEQARI

SHKALLA	FLETA
1- 500	1 - 11
MAT 2022	Format A3



REPUBLIKA E SHQIPERISË
BASHKIA MAT

PROJEKT ZBATIMI

OBJEKTI:

Ndertimi i rruges fshati Bater, bashkia Mat
Planpiketimi i rruges



POROSITESI : BASHKIA MAT

OBJEKTI: "Ndertimi i rruges fshati Bater ,bashkia Mat"

Emertimi: Planpiketimi i rruges



"Imperium Construction", shpk
Adresa: njesi Bashkiake nr.9 Rruga "Shyqyri Peza"
Pallati 21, Hyrja 1,Kati 2 ,Tirane

Drejtues i projektit

Adm. Arber TOLA

Projektues

Inxh. Elton LLAPUSHI
Inxh. Ilir Hodaj
Ark. Rigert HYRA

Mek. Bujar MERAJ
Elek. Altin ALLKAJ
Top. Iv BEQARI

SHKALLA

1- 500

MAT 2022

FLETA

1 - 01

Format A3

1V3	a = 24.52958c
EI	E= 417913.243
Ec	N= 4606199.765
Nc	Kurba:1V3
R	417930.401
a	4606141.091
Sv	60.000
Tg	24.52958c
Bs	23.119
	11.704
	1.131

1V5	a = 165.12980c
EI	E= 417997.988
Ec	N= 4606216.111
Nc	Kurba:1V5
R	8.000
a	165.12980c
Sv	20.751
Tg	28.477
Bs	21.579

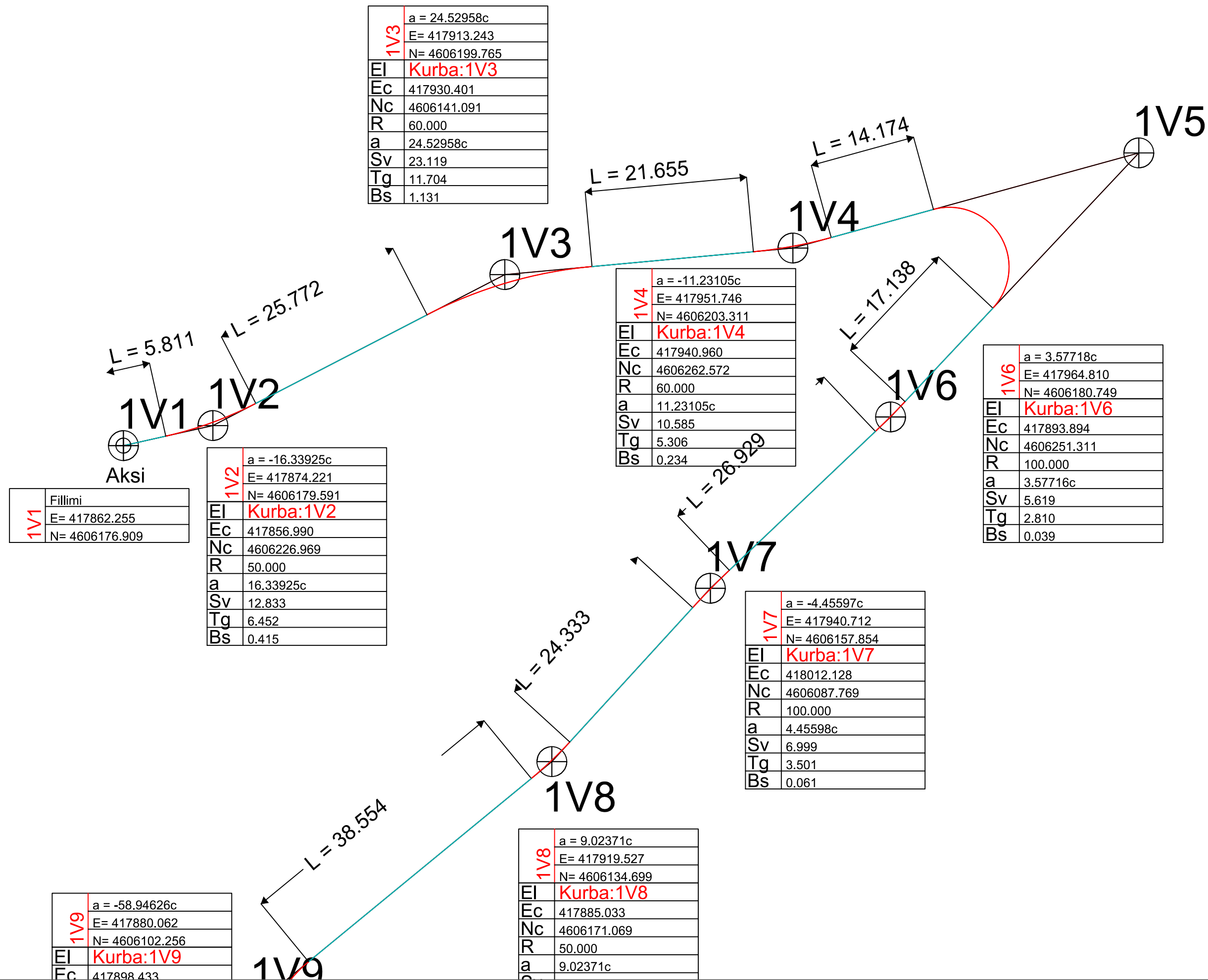
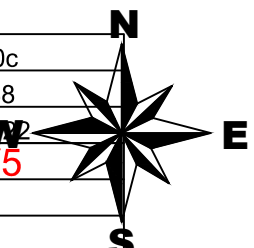

1V1	Fillimi
EI	E= 417862.255
Ec	N= 4606176.909

1V2	a = -16.33925c
EI	E= 417874.221
Ec	N= 4606179.591
Nc	Kurba:1V2
R	417856.990
a	4606226.969
Sv	50.000
Tg	16.33925c
Bs	12.833
	6.452
	0.415

1V4	a = -11.23105c
EI	E= 417951.746
Ec	N= 4606203.311
Nc	Kurba:1V4
R	417940.960
a	4606262.572
Sv	60.000
Tg	11.23105c
Bs	10.585
	5.306
	0.234

1V6	a = 3.57718c
EI	E= 417964.810
Ec	N= 4606180.749
Nc	Kurba:1V6
R	417893.894
a	4606251.311
Sv	100.000
Tg	3.57718c
Bs	5.619
	2.810
	0.039

1V7	a = -4.45597c
EI	E= 417940.712
Ec	N= 4606157.854
Nc	Kurba:1V7
R	418012.128
a	4606087.769
Sv	100.000
Tg	4.45598c
Bs	6.999
	3.501
	0.061

1V8	a = 9.02371c
EI	E= 417919.527
Ec	N= 4606134.699
Nc	Kurba:1V8
R	417885.033
a	4606171.069
Sv	50.000
Tg	9.02371c
Bs	

1V9	a = -58.94626c
EI	E= 417880.062
Ec	N= 4606102.256
Nc	Kurba:1V9
R	417898.433
a	
Sv	
Tg	
Bs	



POROSITESI : BASHKIA MAT

OBJEKTI: "Ndertimi i rruges fshati Bater ,bashkia Mat"

Emertimi: Planpiketimi i rruges



"Imperium Construction", shpk
Adresa: njesi Bashkiake nr.9 Rruga "Shyqyri Peza"
Pallati 21, Hyrja 1,Kati 2 ,Tirane

Drejtues i projektit

Adm. Arber TOLA

Projektues

Inxh. Elton LLAPUSHI
Inxh. Ilir Hodaj
Ark. Rigert HYRA

Mek. Bujar MERAJ
Elek. Altin ALLKAJ
Top. Iv BEQARI

SHKALLA

1- 500

MAT 2022

FLETA

1 - 01

Format A3

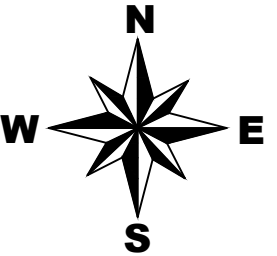

1V30	a = -20.34344c
	E= 418084.686
	N= 4605128.248
EI	Kurba:1V30
EC	418181.984
Nc	4605156.403
R	100.000
a	20.34344c
Sv	31.955
Tg	16.115
Bs	1.290

1V31	a = 28.25606c
	E= 418098.942
	N= 4605098.080
EI	Kurba:1V31
EC	418048.915
Nc	4605086.918
R	50.000
a	28.25606c
Sv	22.192
Tg	11.282
Bs	1.257

1V32	a = 85.42062c
	E= 418098.863
	N= 4605065.091
EI	Kurba:1V32
EC	418083.892
Nc	4605077.032
R	15.000
a	85.42062c
Sv	20.127
Tg	11.906
Bs	4.151

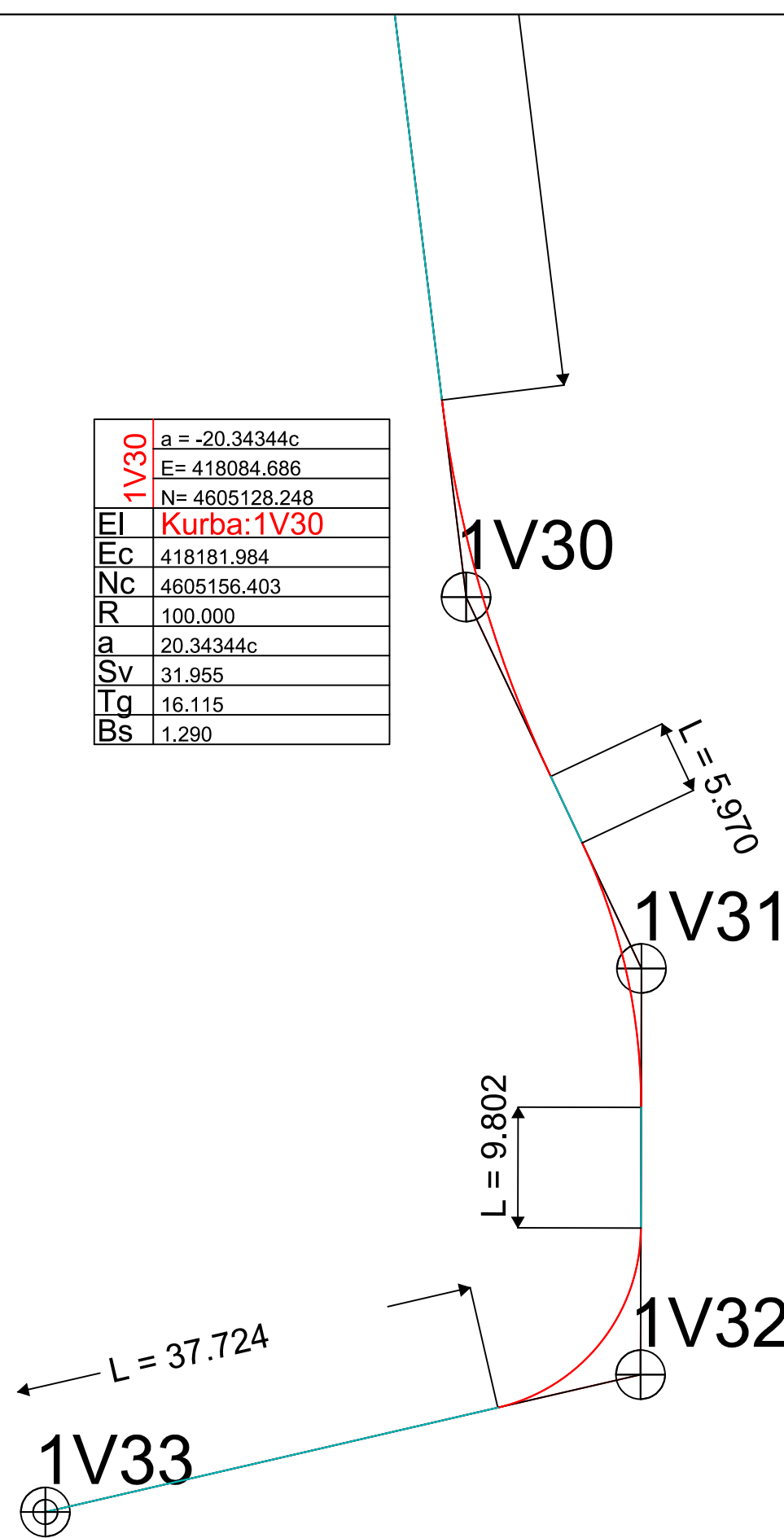

33	Fine
	E= 418050.502



POROSITESI : BASHKIA MAT

OBJEKTI: "Ndertimi i rruges fshati Bater ,bashkia Mat"

Emertimi: Planpiketimi i rruges

"Imperium Construction", shpk
 Adresa: njesi Bashkiake nr.9 Rruga "Shyqyri Peza"
 Pallati 21, Hyrja 1,Kati 2 ,Tirane



Drejtues i projektit

Adm. Arber TOLA

Projektues

Inxh. Elton LLAPUSHI	Mek. Bujar MERAJ
Inxh. Ilir Hodaj	Elek. Altin ALLKAJ
Ark. Rigert HYRA	Top. Iv BEQARI

SHKALLA

1- 500

MAT 2022

FLETA

1 - 01

Format A3

1V9	N= 4606102.256
EI	Kurba:1V9
Ec	417898.433
Nc	4606094.057
R	18.000
a	58.94626c
Sv	16.667
Tg	8.985
Bs	2.118

1V10	a = -88.41868c
	E= 417880.953
	N= 4606081.636
EI	Kurba:1V10
Ec	417892.510
Nc	4606092.139
R	12.000
a	88.41868c
Sv	16.667
Tg	9.994
Bs	3.617

1V11	4606171.069
R	50.000
a	9.02371c
Sv	7.087
Tg	3.550
Bs	0.126

1V12	a = 8.45217c
	E= 417962.641
	N= 4606055.087
EI	Kurba:1V12
Ec	417907.302
Nc	4605971.530
R	100.000
a	8.45218c
Sv	13.277
Tg	6.648
Bs	0.221

1V11	a = 24.18179c
	E= 417927.511
	N= 4606075.135
EI	Kurba:1V11
Ec	417911.077
Nc	4606026.945
R	50.000
a	24.18179c
Sv	18.992
Tg	9.612
Bs	0.916

1V13	a = 141.16876c
	E= 418018.543
	N= 4606012.471
EI	Kurba:1V13
Ec	417994.309
Nc	4606017.114
R	11.000
a	141.16876c
Sv	24.392
Tg	22.088
Bs	13.675

1V15	a = -7.07202c
	E= 417925.466
	N= 4605969.502
EI	Kurba:1V15
Ec	417971.514
Nc	4605949.822
R	50.000
a	7.07201c
Sv	5.554

1V14	a = -53.38697c
	E= 417935.188
	N= 4605989.153
EI	Kurba:1V14

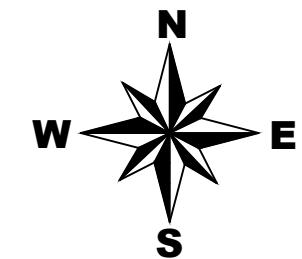
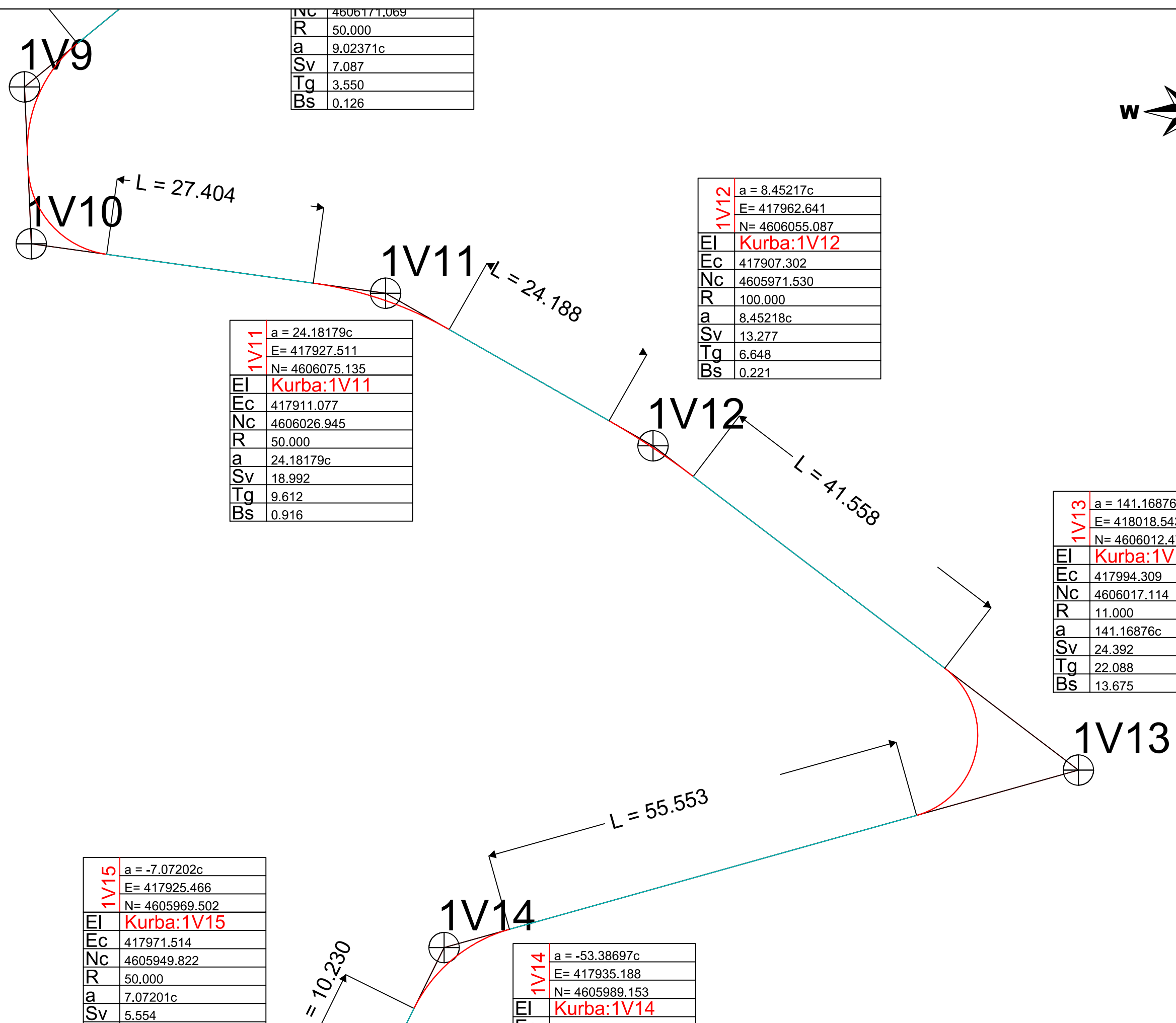

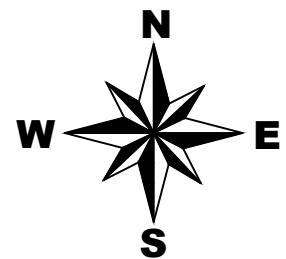

1V14	E= 417925.466
	N= 4605969.502
EI	Kurba:1V15
Ec	417971.514
Nc	4605949.822
R	50.000
a	7.07201c
Sv	5.554
Tg	2.780
Bs	0.077

1V14	a = -53.38697c
	E= 417935.188
	N= 4605989.153
EI	Kurba:1V14
Ec	417949.161
Nc	4605972.294
R	20.000
a	53.38697c
Sv	16.772
Tg	8.915
Bs	1.897

1V16	a = 17.96867c
	E= 417920.614
	N= 4605956.141
EI	Kurba:1V16
Ec	417893.871
Nc	4605970.387
R	30.000
a	17.96867c
Sv	8.468
Tg	4.262
Bs	0.301

1V19	a = 99.22773c
	E= 417968.591
	N= 4605905.656
EI	Kurba:1V19
Ec	417958.012
Nc	4605890.756
R	13.000
a	99.22773c
Sv	20.263
Tg	12.843
Bs	5.274

1V17	a = -113.71252c
	E= 417894.456
	N= 4605920.309
EI	Kurba:1V17
Ec	417914.479
Nc	4605925.689
R	13.000
a	113.71252c
Sv	23.220
Tg	16.152
Bs	7.734

1V18	a = -36.74011c
	E= 417938.753
	N= 4605900.782
EI	Kurba:1V18
Ec	417941.388
Nc	4605921.477
R	20.000
a	36.74011c
Sv	11.542
Tg	5.937
Bs	0.863

1V20	a = 56.87264c
	E= 417973.408
	N= 4605878.260
EI	Kurba:1V20
Ec	417957.390
Nc	4605882.738
R	15.000
a	56.87264c
Sv	13.400
Tg	7.184
Bs	1.632

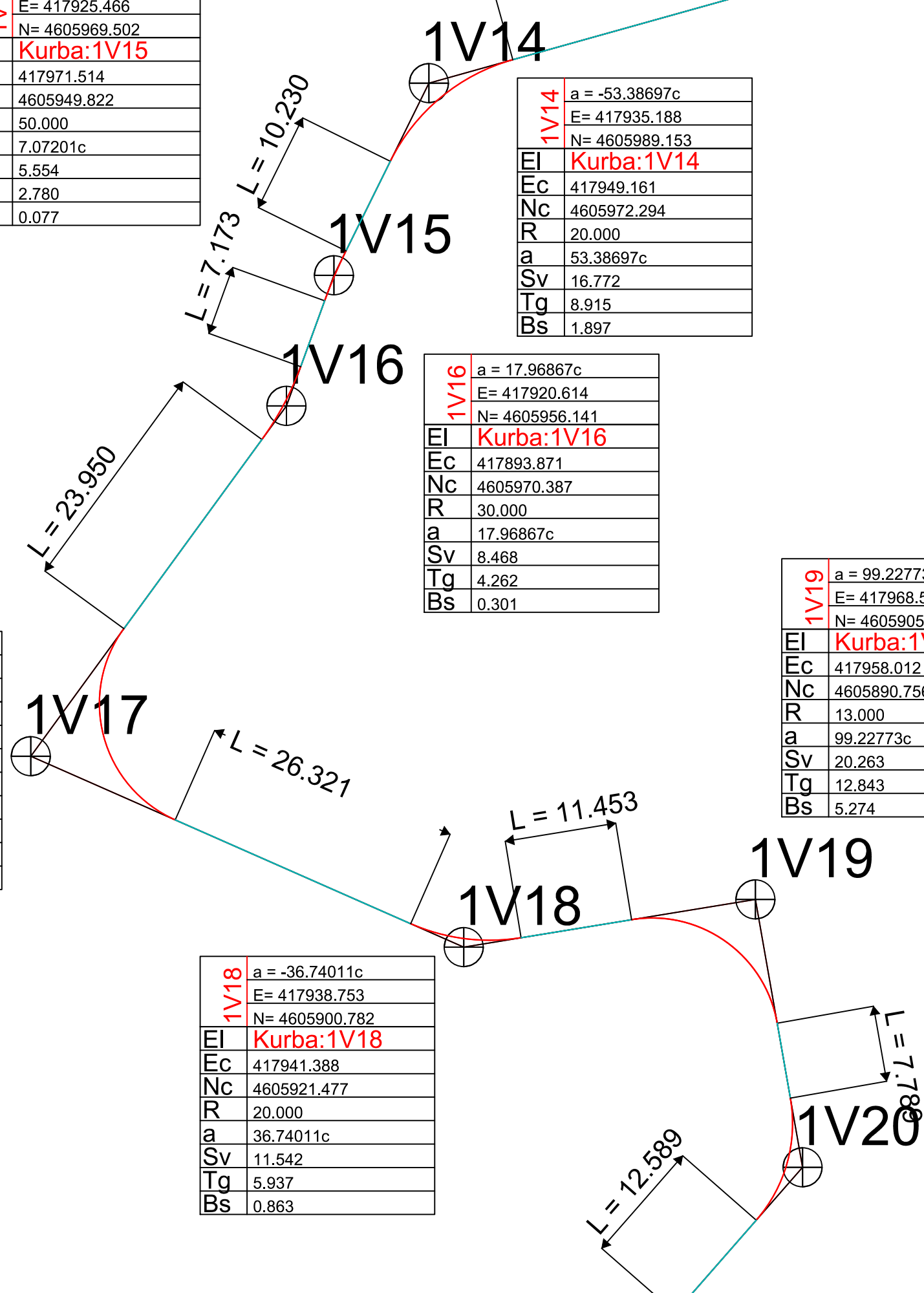

Nc	4605921.477
R	20.000
a	36.74011c
Sv	11.542
Tg	5.937
Bs	0.863

Sv	13.400
Tg	7.184
Bs	1.632

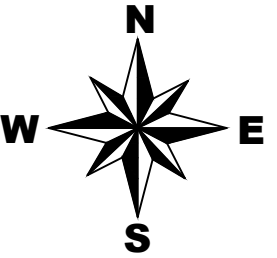

1V21	a = -79.47574c
	E= 417953.262
	N= 4605855.258
EI	Kurba:1V21
EC	417971.664
Nc	4605853.503
R	15.000
a	79.47574c
Sv	18.726
Tg	10.804
Bs	3.486

1V22	a = 9.31230c
	E= 417990.882
	N= 4605790.918
EI	Kurba:1V22
EC	417945.870
Nc	4605768.843
R	50.000
a	9.31230c
Sv	7.314
Tg	3.663
Bs	0.134

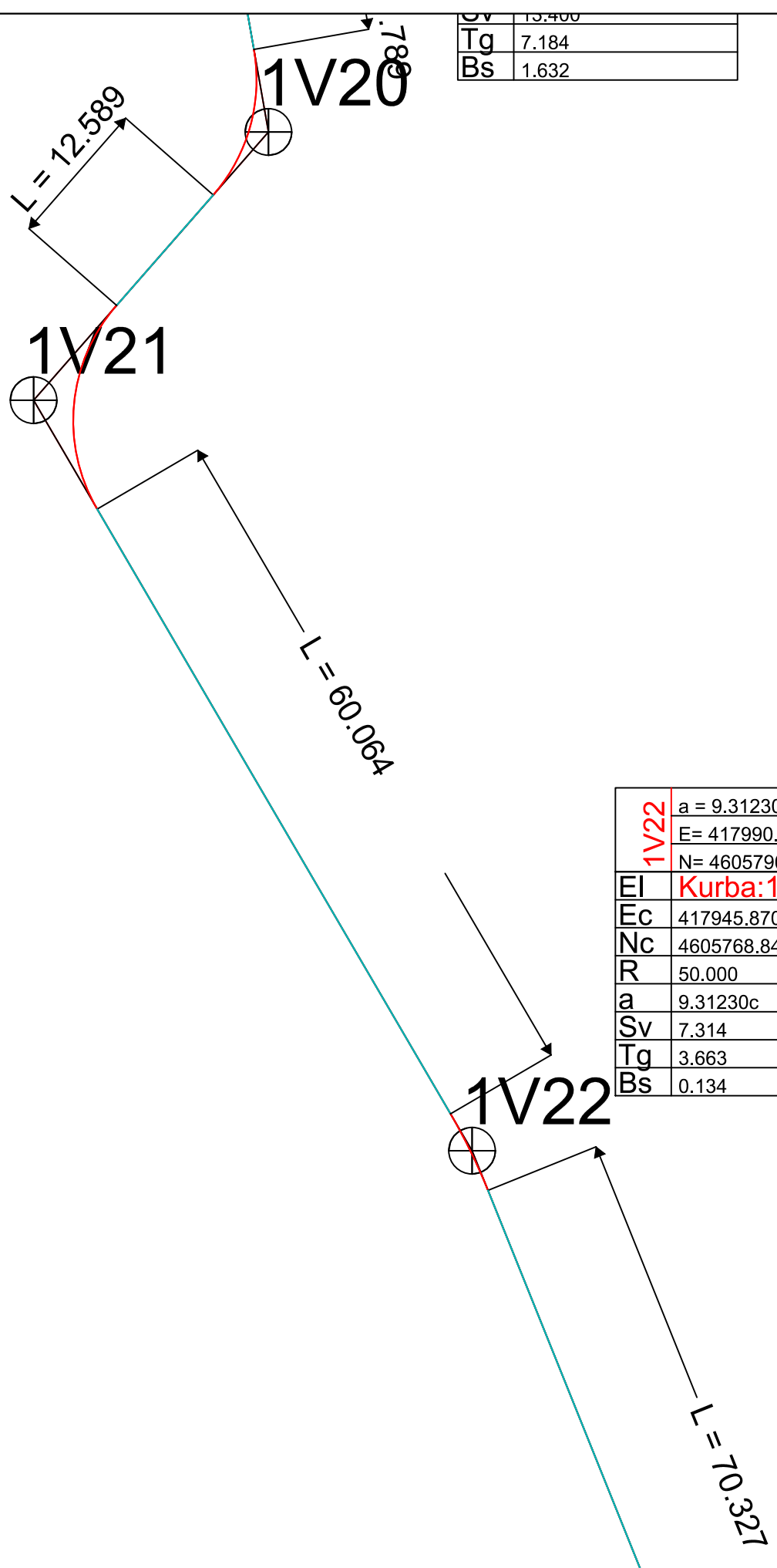

POROSITESI : BASHKIA MAT
 OBJEKTI: "Ndertimi i rruges fshati Bater ,bashkia Mat"

Emertimi: **Planpiketimi i rruges**
 "Imperium Construction", shpk
 Adresa: njesi Bashkiake nr.9 Rruga "Shyqyri Peza"
 Pallati 21, Hyrja 1,Kati 2 ,Tirane

Drejtues i projektit
 Adm. Arber TOLA

Projektues

Inxh. Elton LLAPUSHI	Mek. Bujar MERAJ
Inxh. Ilir Hodaj	Elek. Altin ALLKAJ
Ark. Rigert HYRA	Top. Iv BEQARI

SHKALLA	FLETA
1- 500	1 - 01
MAT 2022	Format A3

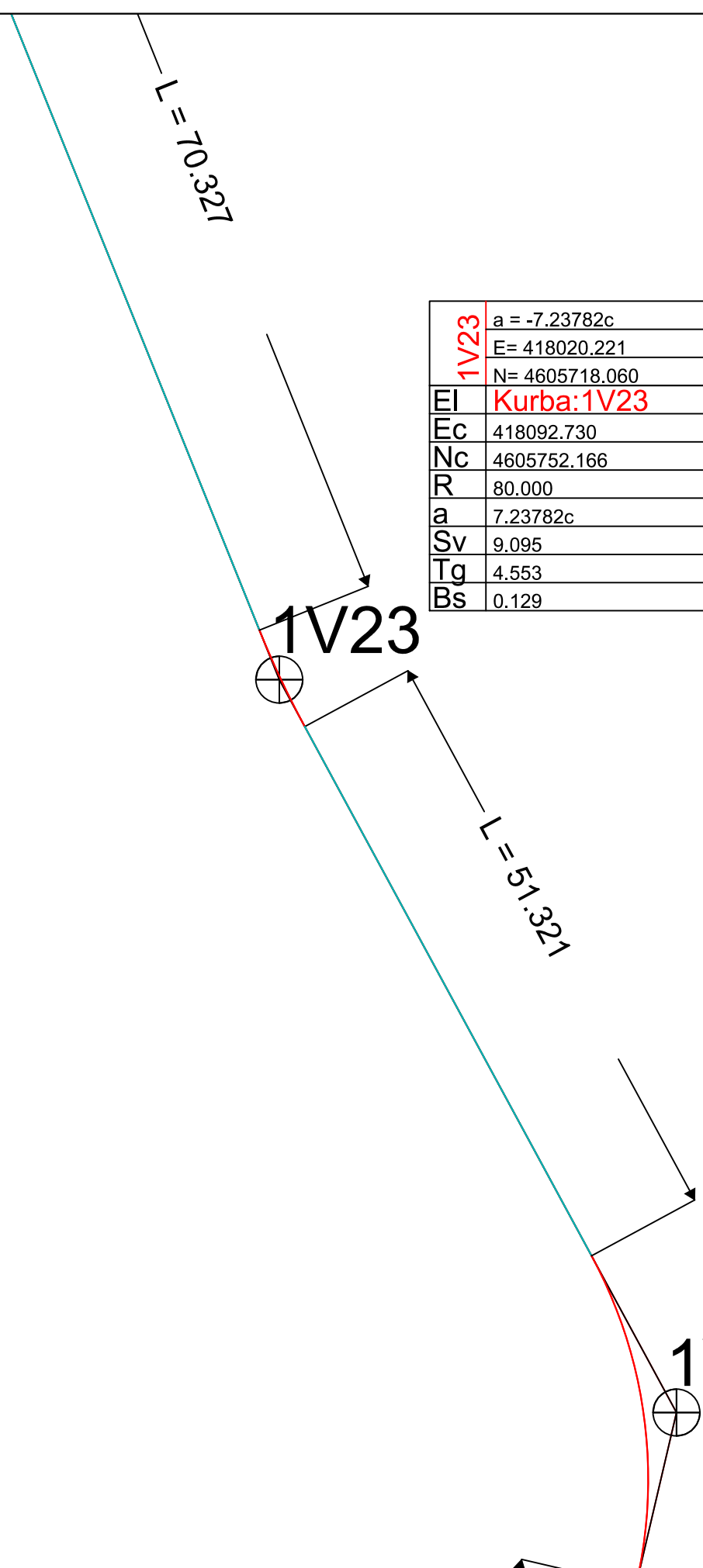
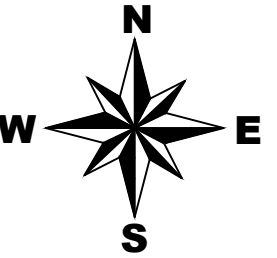

1V23	a = -7.23782c
EI	E= 418020.221
EC	N= 4605718.060
EC	Kurba:1V23
Nc	418092.730
R	4605752.166
a	80.000
Sv	7.23782c
Tg	9.095
Bs	4.553
	0.129

1V24	a = 46.23324c
EI	E= 418054.077
EC	N= 4605655.570
EC	Kurba:1V24
Nc	418011.667
R	4605649.879
a	40.000
Sv	46.23324c
Tg	29.049
Bs	15.199
	2.790



POROSITESI : BASHKIA MAT
 OBJEKTI: "Ndertimi i rruges fshati Bater ,bashkia Mat"

Emertimi: **Planpiketimi i rruges**
 "Imperium Construction", shpk
 Adresa: njesi Bashkiake nr.9 Rruga "Shyqyri Peza"
 Pallati 21, Hyrja 1,Kati 2 ,Tirane



Drejtues i projektit
 Adm. Arber TOLA

Projektues
 Inxh. Elton LLAPUSHI
 Inxh. Ilir Hodaj
 Ark. Rigert HYRA
 Mek. Bujar MERAJ
 Elek. Altin ALLKAJ
 Top. Iv BEQARI

SHKALLA	FLETA
1- 500	1 - 01
MAT 2022	Format A3

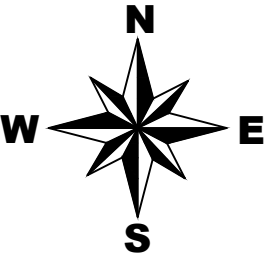

R	40.000
a	46.23324c
Sv	29.049
Tg	15.199
Bs	2.790

1V25	a = 8.95658c
	E= 418044.885
	N= 4605616.262
EI	Kurba:1V25
Ec	417968.270
Nc	4605639.967
R	80.000
a	8.95658c
Sv	11.255
Tg	5.637
Bs	0.198

1V26	a = -13.86205c
	E= 418021.848
	N= 4605556.939
EI	Kurba:1V26
Ec	418070.435
Nc	4605543.934
R	50.000
a	13.86205c
Sv	10.887
Tg	5.465
Bs	0.298

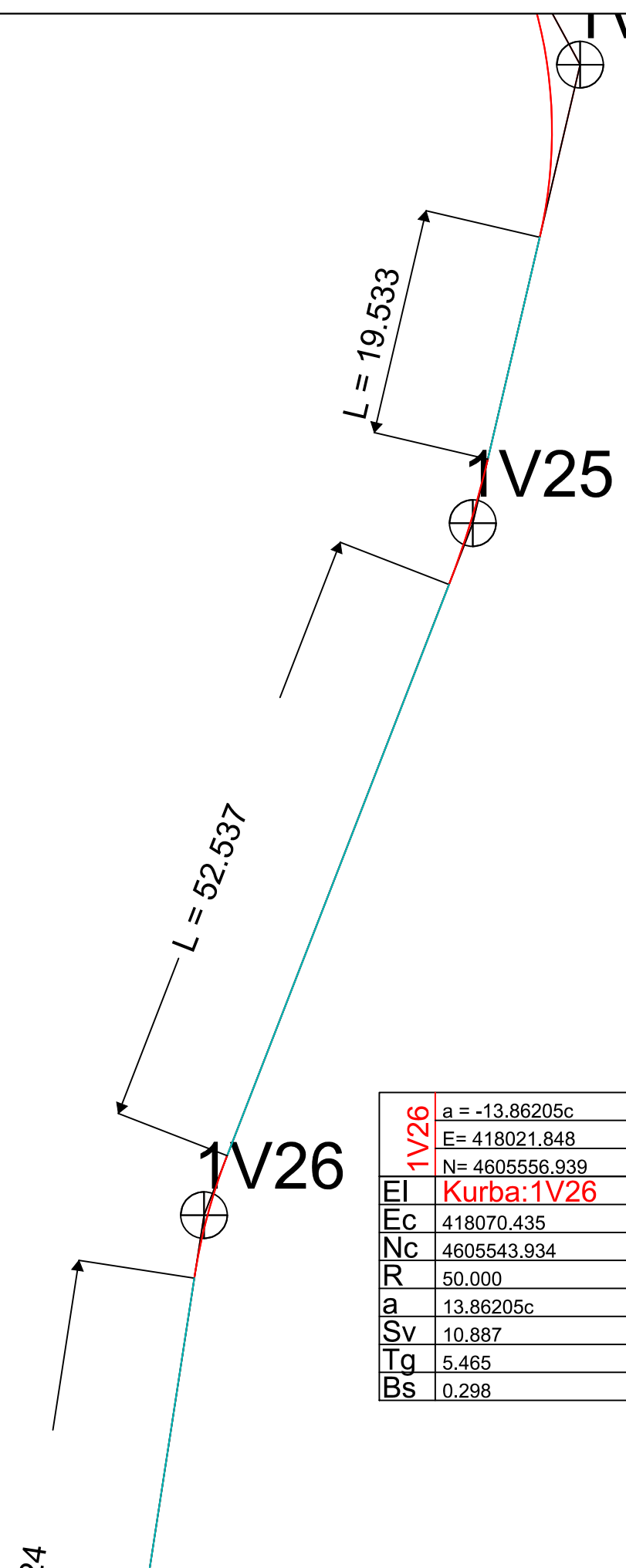

POROSITESI : BASHKIA MAT
 OBJEKTI: "Ndertimi i rruges fshati Bater ,bashkia Mat"

Emertimi: **Planpiketimi i rruges**

"Imperium Construction", shpk
 Adresa: njesi Bashkiake nr.9 Rruga "Shyqyri Peza"
 Pallati 21, Hyrja 1,Kati 2 ,Tirane

Drejtues i projektit
 Adm. Arber TOLA

Projektues	
Inxh. Elton LLAPUSHI	Mek. Bujar MERAJ
Inxh. Ilir Hodaj	Elek. Altin ALLKAJ
Ark. Rigert HYRA	Top. Iv BEQARI

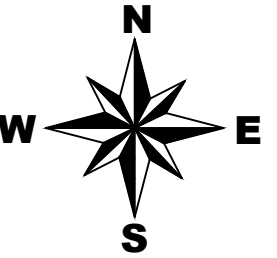
SHKALLA	FLETA
1- 500	1 - 01
MAT 2022	Format A3



1V27	a = -32.95094c
	E= 418009.672
	N= 4605477.802
EI	Kurba:1V27
Ec	418091.962
Nc	4605486.569
R	80.000
a	32.95094c
Sv	41.407
Tg	21.179
Bs	2.756

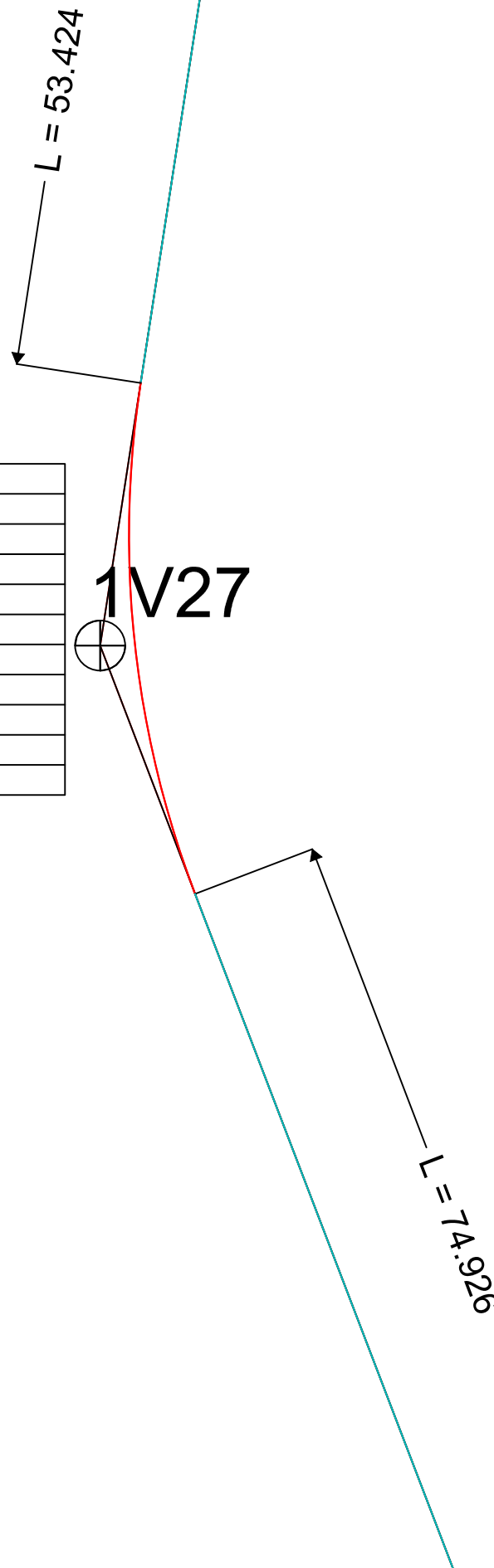

POROSITESI : BASHKIA MAT

OBJEKTI: "Ndertimi i rruges fshati Bater ,bashkia Mat"

Emertimi: Planpiketimi i rruges



"Imperium Construction", shpk
 Adresa: njesi Bashkiake nr.9 Rruga "Shyqyri Peza"
 Pallati 21, Hyrja 1,Kati 2 ,Tirane

Drejtues i projektit

Adm. Arber TOLA

Projektues

Inxh. Elton LLAPUSHI	Mek. Bujar MERAJ
Inxh. Ilir Hodaj	Elek. Altin ALLKAJ
Ark. Rigert HYRA	Top. Iv BEQARI

SHKALLA

1- 500

MAT 2022

FLETA

1 - 01

Format A3

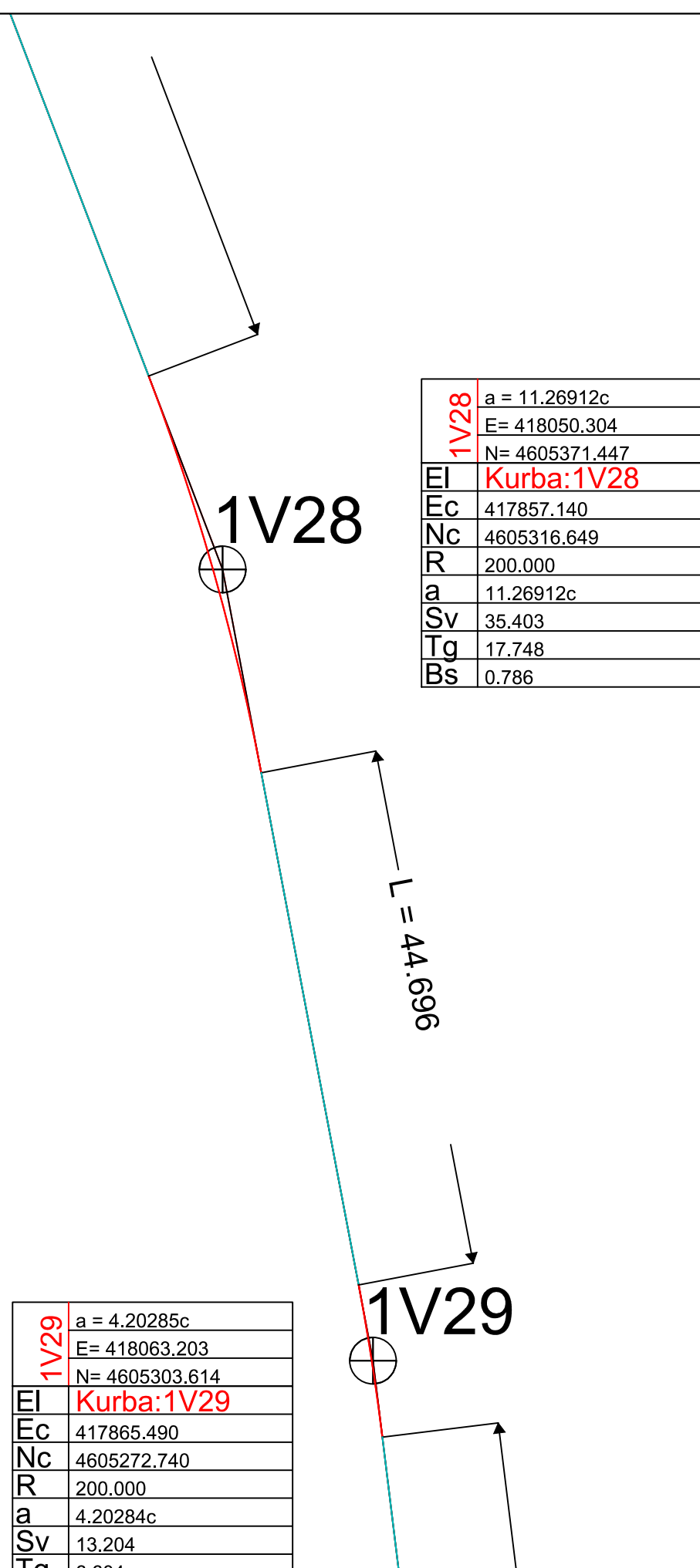
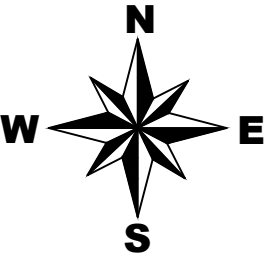

1V28	a = 11.26912c
	E= 418050.304
	N= 4605371.447
EI	Kurba:1V28
Ec	417857.140
Nc	4605316.649
R	200.000
a	11.26912c
Sv	35.403
Tg	17.748
Bs	0.786

1V29	a = 4.20285c
	E= 418063.203
	N= 4605303.614
EI	Kurba:1V29
Ec	417865.490
Nc	4605272.740
R	200.000
a	4.20284c
Sv	13.204
Tg	6.604

L = 44.696



POROSITESI : BASHKIA MAT
 OBJEKTI: "Ndertimi i rruges fshati Bater ,bashkia Mat"

Emertimi: **Planpiketimi i rruges**
 "Imperium Construction", shpk
 Adresa: njesi Bashkiake nr.9 Rruga "Shyqyri Peza"
 Pallati 21, Hyrja 1,Kati 2 ,Tirane



Drejtues i projektit
 Adm. Arber TOLA

Projektues	
Inxh. Elton LLAPUSHI	Mek. Bujar MERAJ
Inxh. Ilir Hodaj	Elek. Altin ALLKAJ
Ark. Rigert HYRA	Top. Iv BEQARI

SHKALLA	FLETA
1- 500	1 - 01
MAT 2022	Format A3

NC	4605272.740
R	200.000
a	4.20284c
Sv	13.204
Tg	6.604
Bs	0.109

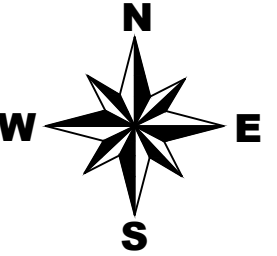

L = 153.958



POROSITESI : BASHKIA MAT

OBJEKTI: "Ndertimi i rruges fshati Bater ,bashkia Mat"

Emertimi: **Planpiketimi i rruges**



"Imperium Construction", shpk
 Adresa: njesi Bashkiake nr.9 Rruga "Shyqyri Peza"
 Pallati 21, Hyrja 1,Kati 2 ,Tirane

Drejtues i projektit

Adm. Arber TOLA

Projektues

Inxh. Elton LLAPUSHI	Mek. Bujar MERAJ	
Inxh. Ilir Hodaj	Elek. Altin ALLKAJ	
Ark. Rigert HYRA	Top. Iv BEQARI	

SHKALLA

1- 500

MAT 2022

FLETA

1 - 01

Format A3

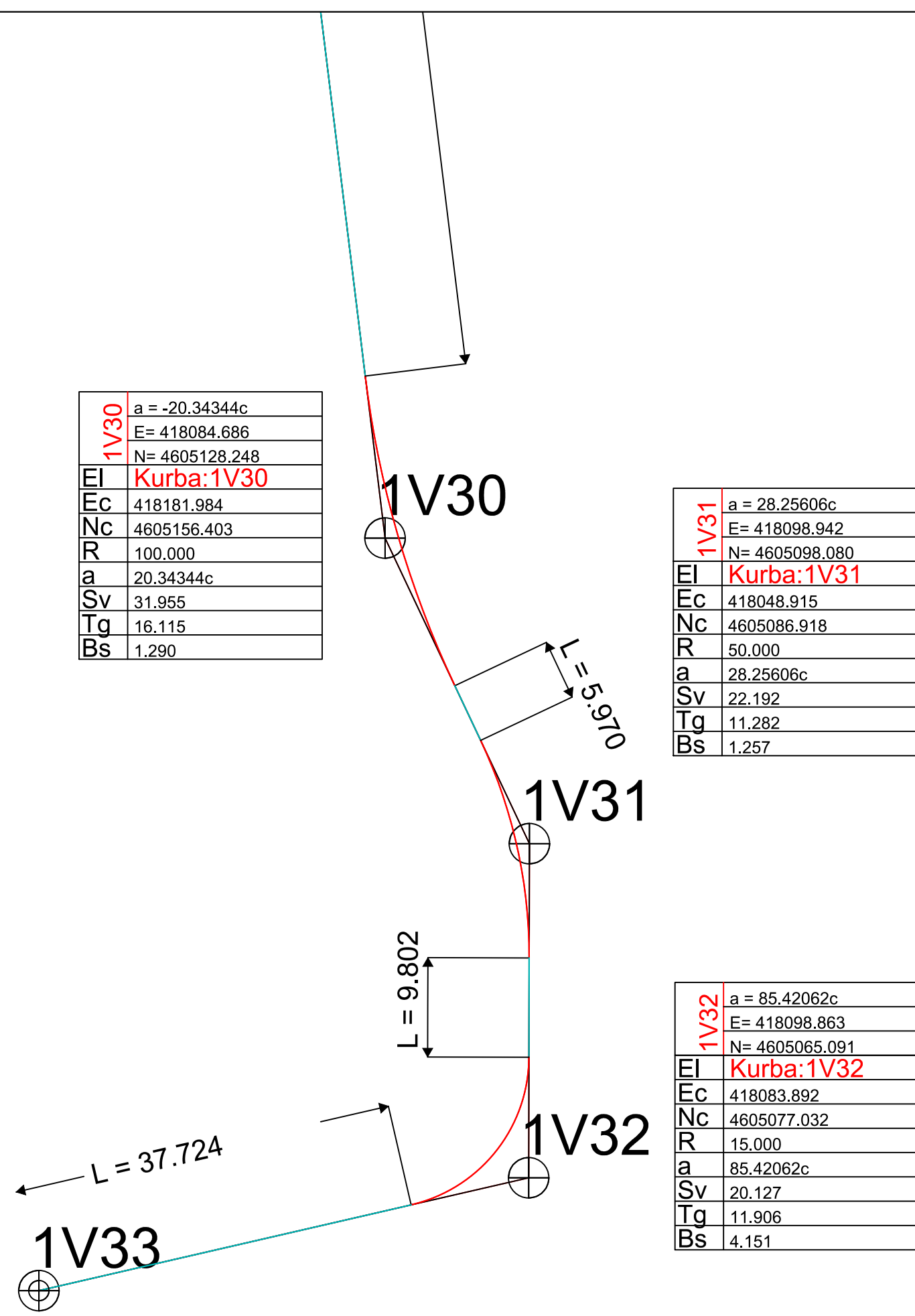
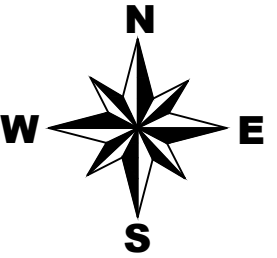

1V30	a = -20.34344c
	E= 418084.686
	N= 4605128.248
EI	Kurba:1V30
EC	418181.984
Nc	4605156.403
R	100.000
a	20.34344c
Sv	31.955
Tg	16.115
Bs	1.290

1V31	a = 28.25606c
	E= 418098.942
	N= 4605098.080
EI	Kurba:1V31
EC	418048.915
Nc	4605086.918
R	50.000
a	28.25606c
Sv	22.192
Tg	11.282
Bs	1.257

1V32	a = 85.42062c
	E= 418098.863
	N= 4605065.091
EI	Kurba:1V32
EC	418083.892
Nc	4605077.032
R	15.000
a	85.42062c
Sv	20.127
Tg	11.906
Bs	4.151



POROSITESI : BASHKIA MAT
 OBJEKTI: "Ndertimi i rruges fshati Bater ,bashkia Mat"

Emertimi: Planpiketimi i rruges
 **"Imperium Construction", shpk**
 Adresa: njesi Bashkiake nr.9 Rruga "Shyqyri Peza"
 Pallati 21, Hyrja 1,Kati 2 ,Tirane

Drejtues i projektit
 Adm. Arber TOLA

Projektues

Inxh. Elton LLAPUSHI	Mek. Bujar MERAJ
Inxh. Ilir Hodaj	Elek. Altin ALLKAJ
Ark. Rigert HYRA	Top. Iv BEQARI

SHKALLA	FLETA
1- 500	1 - 01
MAT 2022	Format A3



REPUBLIKA E SHQIPERISË
BASHKIA MAT

PROJEKT ZBATIMI

OBJEKTI:

Ndertimi i rruges fshati Bater, bashkia Mat
Planimetria e pergjithshme

LEGJENDA	
	ASFALT
	TROTUAR
	AKSI
	RELIEVI
	URE METALIKE
	TOMBINO
	MUR BUTOBETONI



POROSITESI : BASHKIA MAT

OBJEKTI: "Ndertimi i rruges fshati Bater ,bashkia Mat"

Emertimi: Planimetria e pergjithshme



"Imperium Construction", shpk
Adresa: njesi Bashkiake nr.9 Rruga "Shyqyri Peza"
Pallati 21, Hyrja 1,Kati 2 ,Tirane

Drejtues i projektit

Adm. Arber TOLA

Projektues

Inxh. Elton LLAPUSHI
Inxh. Ilir Hodaj
Ark. Rigert HYRA

Mek. Bujar MERAJ
Elek. Altin ALLKAJ
Top. Iv BEQARI

SHKALLA

1- 500

MAT 2022

FLETA

1 - 01

Format A3

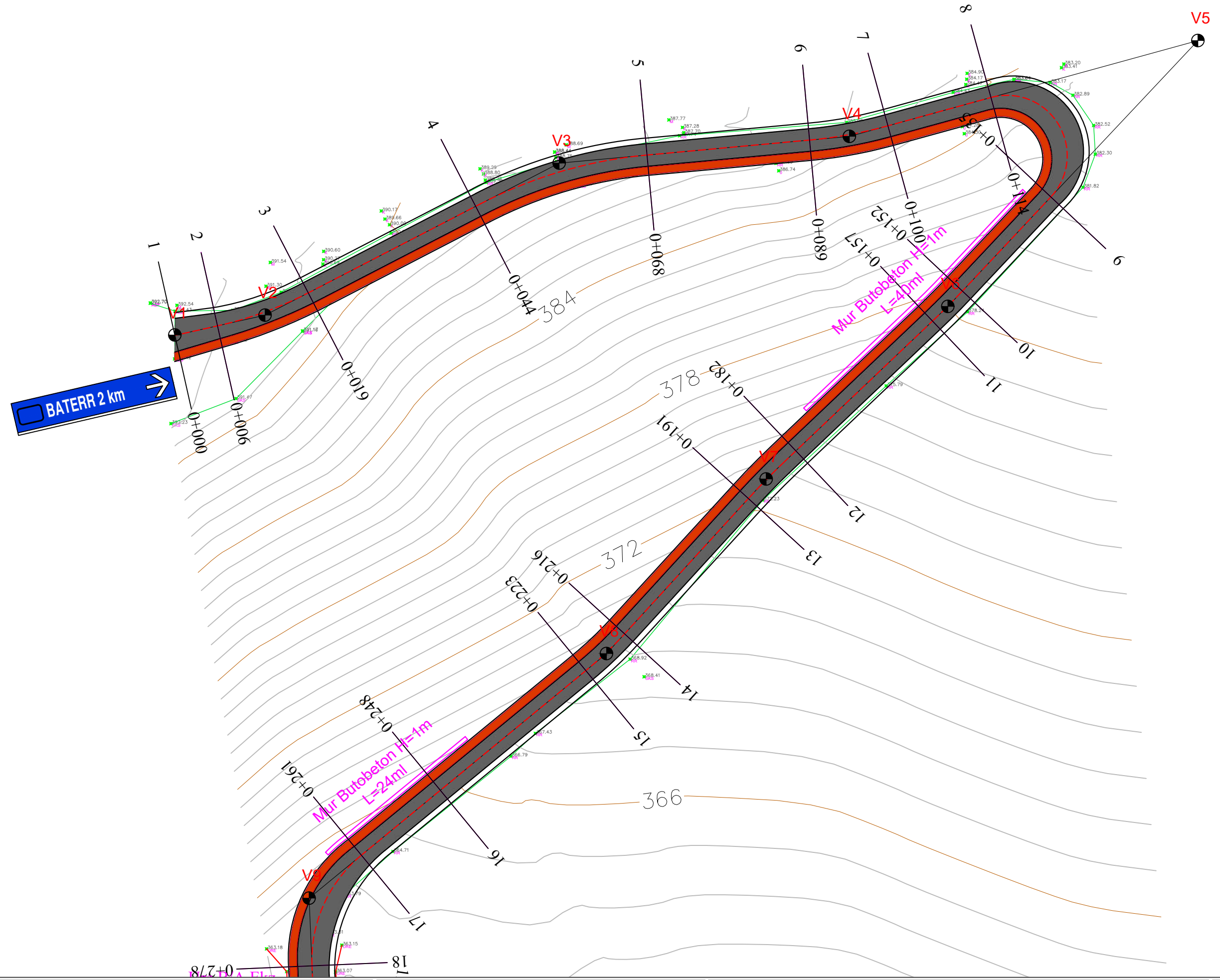
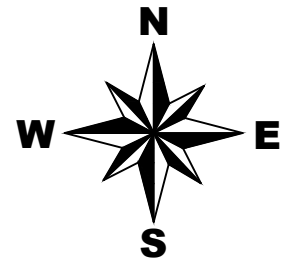

LEGJENDA	
	ASFALT
	TROTUAR
	AKSI
	RELIEVI
	URE METALIKE
	TOMBINO
	MUR BUTOBETONI

POROSITESI : BASHKIA MAT
 OBJEKTI: "Ndertimi i rruges fshati Bater ,bashkia Mat"

Emertimi: Planimetria e pergjithshme
"Imperium Construction", shpk
 Adresa: njesi Bashkiake nr.9 Rruga "Shyqyri Peza"
 Pallati 21, Hyrja 1,Kati 2 ,Tirane

Drejtues i projektit
 Adm. Arber TOLA

Projektues	
Inxh. Elton LLAPUSHI	Mek. Bujar MERAJ
Inxh. Ilir Hodaj	Elek. Altin ALLKAJ
Ark. Rigert HYRA	Top. Iv BEQARI

SHKALLA	FLETA
1- 500	1 - 01
MAT 2022	Format A3

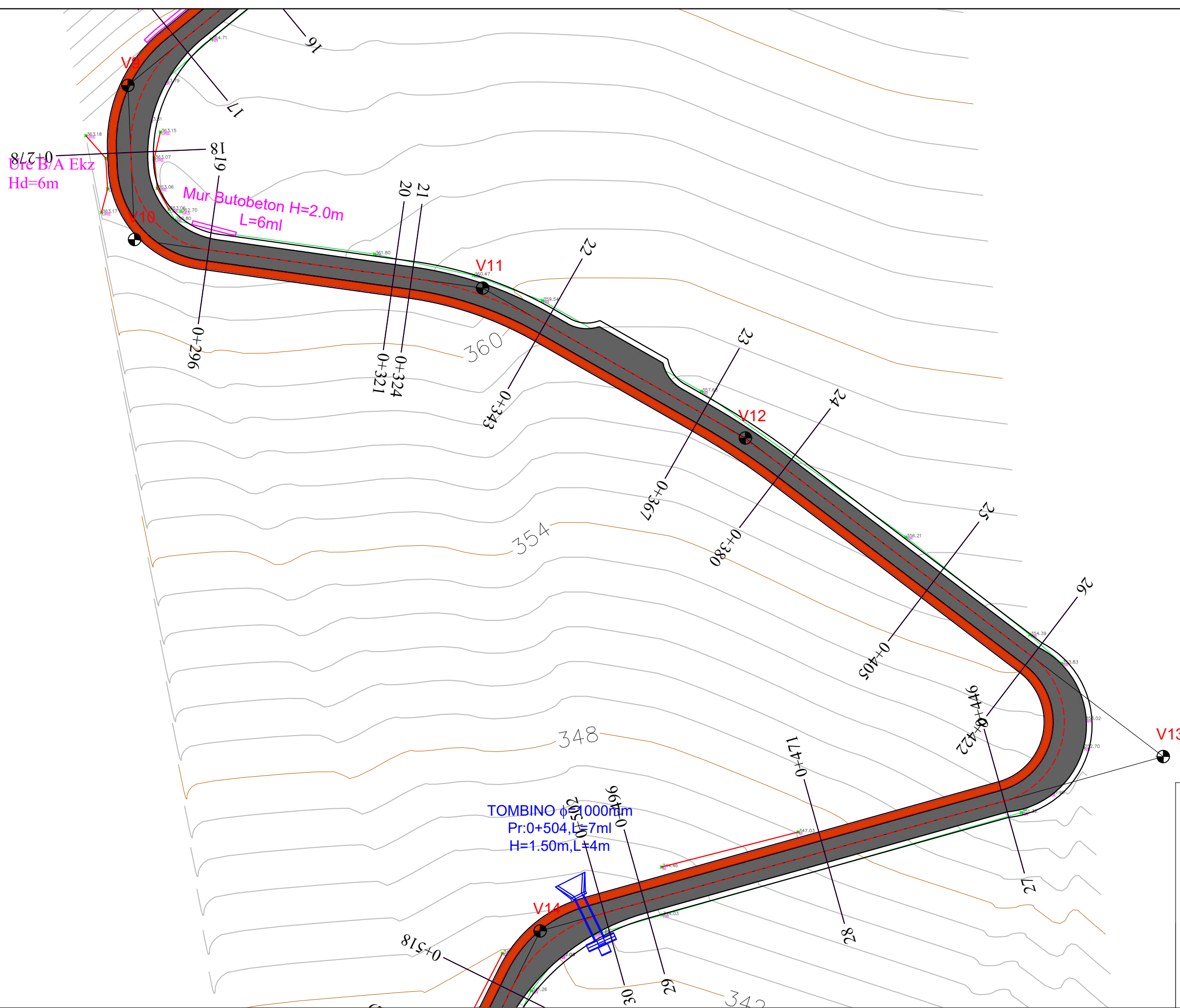
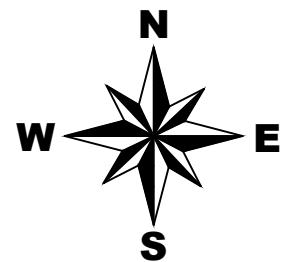

LEGJENDA	
	ASFALT
	TROTUAR
	AKSI
	RELIEVI
	URE METALIKE
	TOMBINO
	MUR BUTOBETONI

	POROSITESI : BASHKIA MAT
	OBJEKTI: "Ndertimi i rruges fshati Bater ,bashkia Mat"

Emertimi: Planimetria e pergjithshme
"Imperium Construction", shpk
Adresa: njesi Bashkiake nr.9 Rruga "Shyqyri Peza"
Pallati 21, Hyrja 1,Kati 2 ,Tirane

Drejtues i projektit
Adm. Arber TOLA

Projektues	
Inxh. Elton LLAPUSHI	Mek. Bujar MERAJ
Inxh. Ilir Hodaj	Elek. Altin ALLKAJ
Ark. Rigert HYRA	Top. Iv BEQARI

SHKALLA	FLETA
1- 500	1 - 01
MAT 2022	Format A3

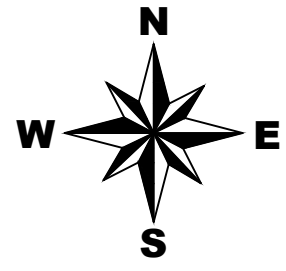
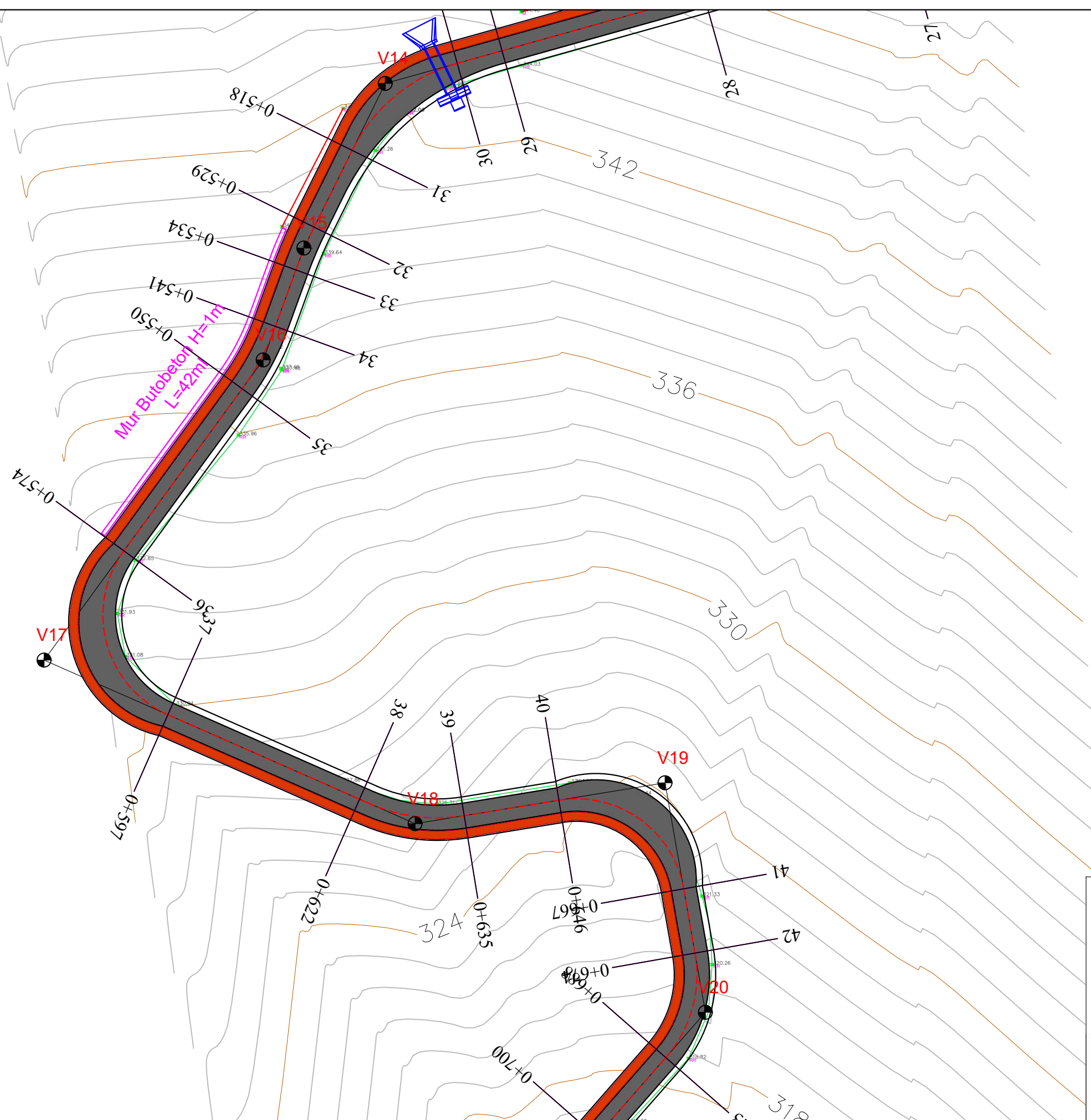

LEGJENDA	
	ASFALT
	TROTUAR
	AKSI
	RELIEVI
	URE METALIKE
	TOMBINO
	MUR BUTOBETONI

POROSITESI : BASHKIA MAT

OBJEKTI: "Ndertimi i rruges fshati Bater ,bashkia Mat"

Emertimi: **Planimetria e pergjithshme**

"Imperium Construction", shpk

Adresa: njesi Bashkiake nr.9 Rruga "Shyqyri Peza"
Pallati 21, Hyrja 1,Kati 2 ,Tirane

Drejtues i projektit

Adm. Arber TOLA

Projektues	
Inxh. Elton LLAPUSHI	Mek. Bujar MERAJ
Inxh. Ilir Hodaj	Elek. Altin ALLKAJ
Ark. Rigert HYRA	Top. Iv BEQARI

SHKALLA	FLETA
1- 500	1 - 01
MAT 2022	Format A3

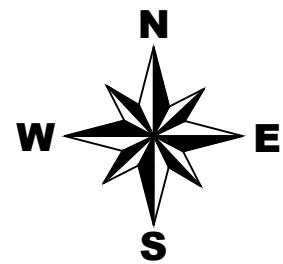

LEGJENDA	
	ASFALT
	TROTUAR
	AKSI
	RELIEVI
	URE METALIKE
	TOMBINO
	MUR BUTOBETONI

POROSITESI : BASHKIA MAT

OBJEKTI: "Ndertimi i rruges fshati Bater ,bashkia Mat"

Emertimi: **Planimetria e pergjithshme**

"Imperium Construction", shpk
 Adresa: njesi Bashkiake nr.9 Rruga "Shyqyri Peza"
 Pallati 21, Hyrja 1,Kati 2 ,Tirane

Drejtues i projektit: **Adm. Arber TOLA**

Projektues:

Inxh. Elton LLAPUSHI	Mek. Bujar MERAJ
Inxh. Ilir Hodaj	Elek. Altin ALLKAJ
Ark. Rigert HYRA	Top. Iv BEQARI

SHKALLA	FLETA
1- 500	1 - 01
MAT 2022	Format A3

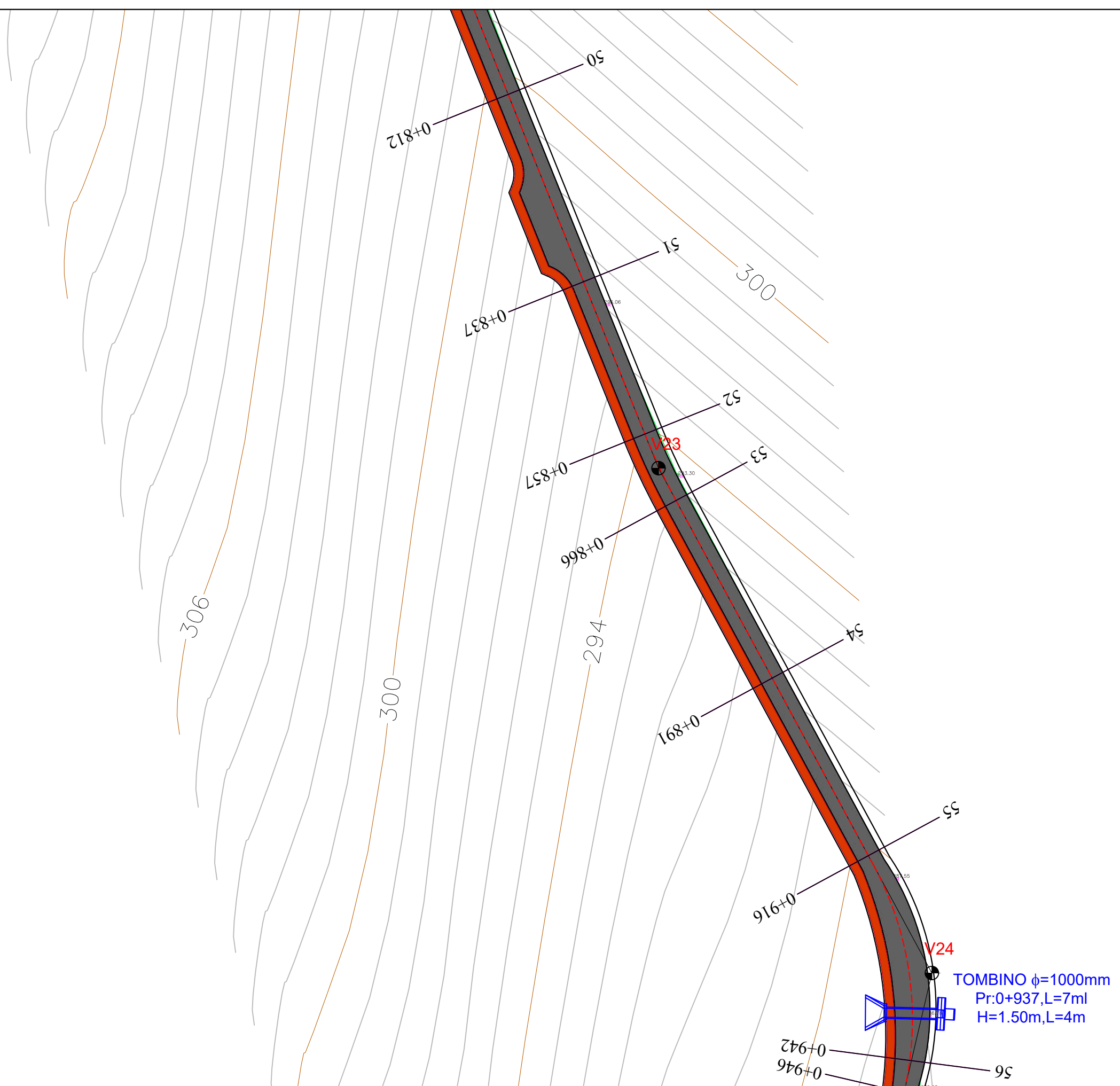
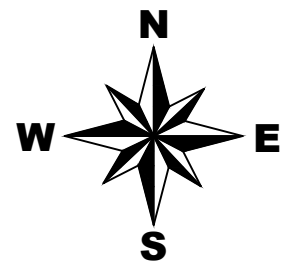

LEGJENDA	
	ASFALT
	TROTUAR
	AKSI
	RELIEVI
	URE METALIKE
	TOMBINO
	MUR BUTOBETONI

POROSITESI : BASHKIA MAT

OBJEKTI: "Ndertimi i rruges fshati Bater ,bashkia Mat"

Emertimi: **Planimetria e pergjithshme**

"Imperium Construction", shpk
 Adresa: njesi Bashkiake nr.9 Rruga "Shyqyri Peza"
 Pallati 21, Hyrja 1,Kati 2 ,Tirane

Drejtesues i projektit: **Adm. Arber TOLA**

Projektues:

Inxh. Elton LLAPUSHI	Mek. Bujar MERAJ
Inxh. Ilir Hodaj	Elek. Altin ALLKAJ
Ark. Rigert HYRA	Top. Iv BEQARI

SHKALLA	FLETA
1- 500	1 - 01
MAT 2022	Format A3

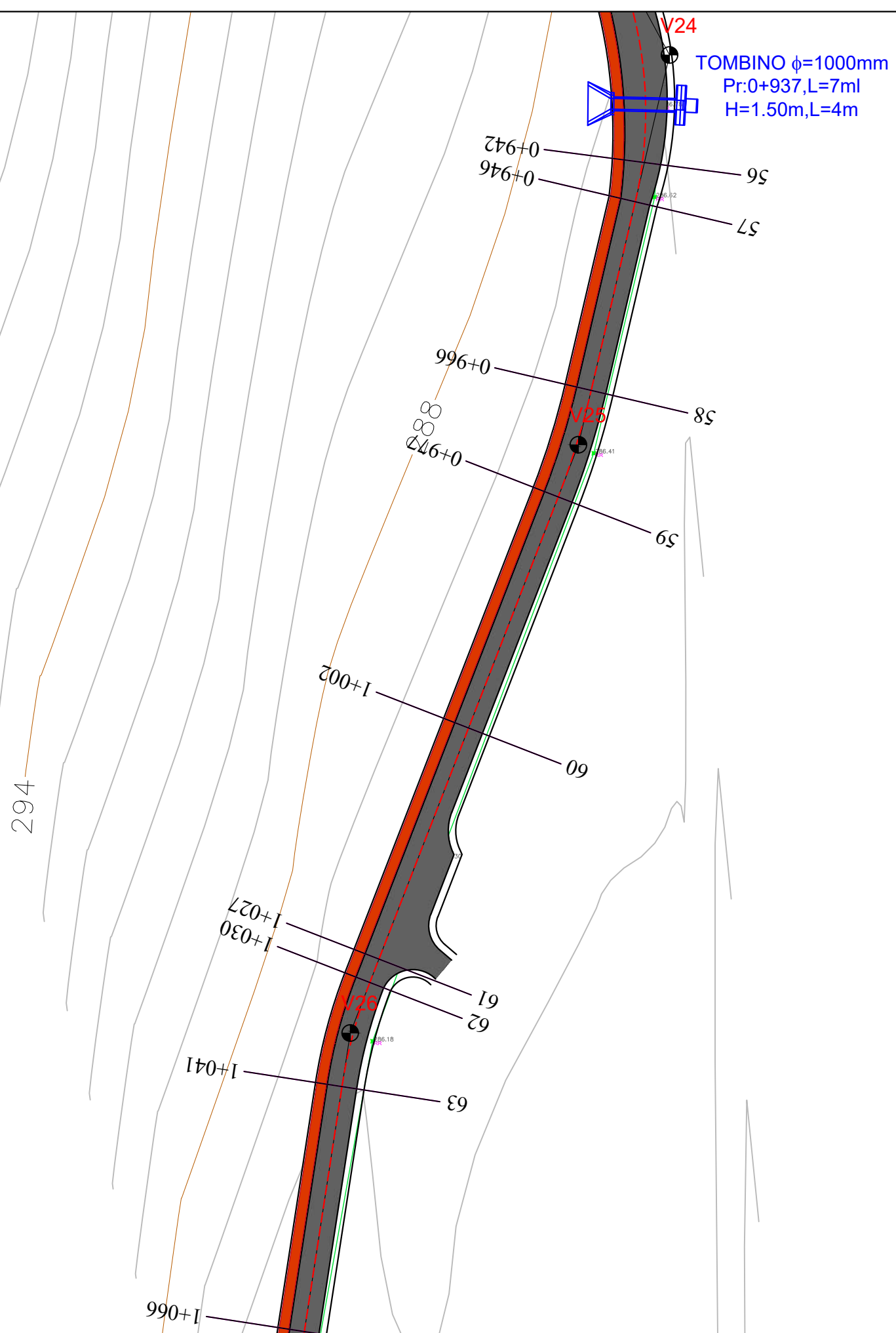
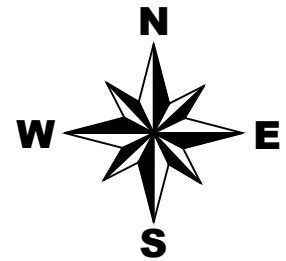

LEGJENDA	
	ASFALT
	TROTUAR
	AKSI
	RELIEVI
	URE METALIKE
	TOMBINO
	MUR BUTOBETONI

POROSITESI : BASHKIA MAT
 OBJEKTI: "Ndertimi i rruges fshati Bater ,bashkia Mat"

Emertimi: Planimetria e pergjithshme
"Imperium Construction", shpk
 Adresa: njesi Bashkiake nr.9 Rruga "Shyqyri Peza"
 Pallati 21, Hyrja 1,Kati 2 ,Tirane

Drejtues i projektit
 Adm. Arber TOLA

Projektues	
Inxh. Elton LLAPUSHI	Mek. Bujar MERAJ
Inxh. Ilir Hodaj	Elek. Altin ALLKAJ
Ark. Rigert HYRA	Top. Iv BEQARI

SHKALLA	FLETA
1- 500	1 - 01
MAT 2022	Format A3



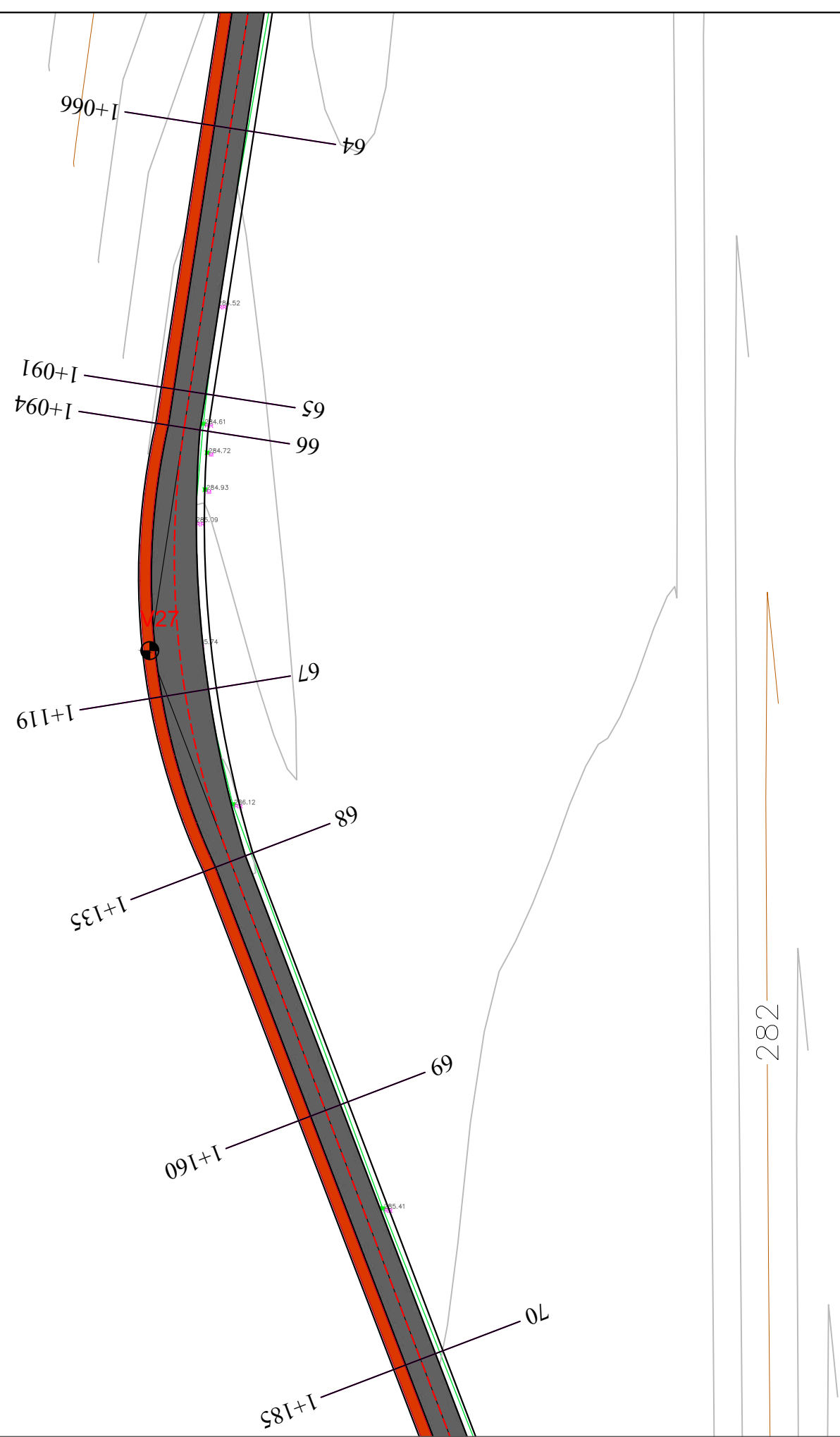
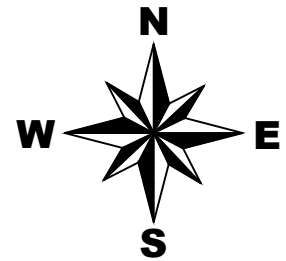

LEGJENDA	
	ASFALT
	TROTUAR
	AKSI
	RELIEVI
	URE METALIKE
	TOMBINO
	MUR BUTOBETONI

 **POROSITESI : BASHKIA MAT**
 OBJEKTI: "Ndertimi i rruges fshati Bater ,bashkia Mat"

Emertimi: **Planimetria e pergjithshme**
 **"Imperium Construction", shpk**
 Adresa: njesi Bashkiake nr.9 Rruga "Shyqyri Peza"
 Pallati 21, Hyrja 1,Kati 2 ,Tirane

Drejtues i projektit
 Adm. Arber TOLA

Projektues	
Inxh. Elton LLAPUSHI	Mek. Bujar MERAJ
Inxh. Ilir Hodaj	Elek. Altin ALLKAJ
Ark. Rigert HYRA	Top. Iv BEQARI

SHKALLA	FLETA
1- 500	1 - 01
MAT 2022	Format A3

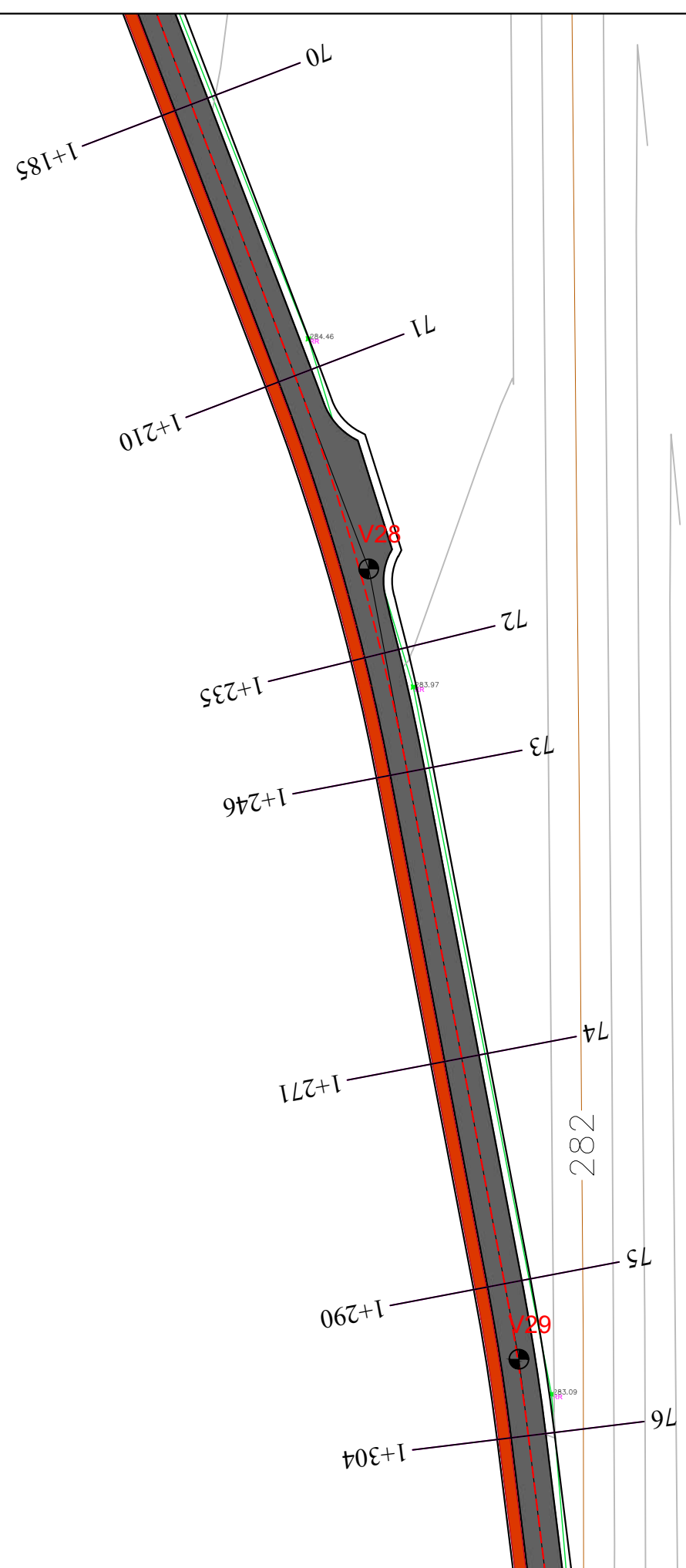
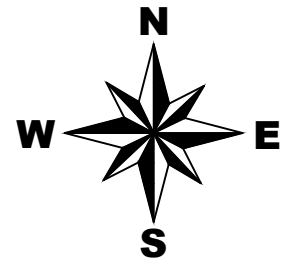

LEGJENDA	
	ASFALT
	TROTUAR
	AKSI
	RELIEVI
	URE METALIKE
	TOMBINO
	MUR BUTOBETONI



POROSITESI : BASHKIA MAT

OBJEKTI: "Ndertimi i rruges fshati Bater ,bashkia Mat"

Emertimi: Planimetria e pergjithshme



"Imperium Construction", shpk
Adresa: njesi Bashkiake nr.9 Rruga "Shyqyri Peza"
Pallati 21, Hyrja 1,Kati 2 ,Tirane

Drejtues i projektit

Adm. Arber TOLA

Projektues

Inxh. Elton LLAPUSHI
Inxh. Ilir Hodaj
Ark. Rigert HYRA

Mek. Bujar MERAJ
Elek. Altin ALLKAJ
Top. Iv BEQARI

SHKALLA

1- 500

MAT 2022

FLETA

1 - 01

Format A3

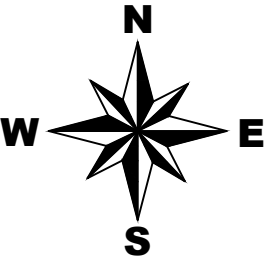

TOMBINO $\phi=1000\text{mm}$
 Pr:1+321,L=7ml
 H=1.50m,L=4m

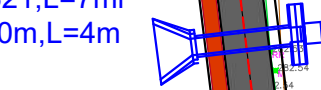

77
 1+329

78
 1+354

79
 1+379

80
 1+404

81
 1+429

276

LEGJENDA	
	ASFALT
	TROTUAR
	AKSI
	RELIEVI
	URE METALIKE
	TOMBINO
	MUR BUTOBETONI



POROSITESI : BASHKIA MAT
 OBJEKTI: "Ndertimi i rruges fshati Bater ,bashkia Mat"

Emertimi: **Planimetria e pergjithshme**



"Imperium Construction", shpk
 Adresa: njesi Bashkiake nr.9 Rruga "Shyqyri Peza"
 Pallati 21, Hyrja 1,Kati 2 ,Tirane

Drejtues i projektit
 Adm. Arber TOLA

Projektues	
Inxh. Elton LLAPUSHI	Mek. Bujar MERAJ
Inxh. Ilir Hodaj	Elek. Altin ALLKAJ
Ark. Rigert HYRA	Top. Iv BEQARI

SHKALLA	FLETA
1- 500	1 - 01
MAT 2022	Format A3

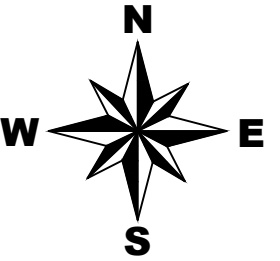

TOMBINO $\phi=1000\text{mm}$
 Pr:1+321,L=7ml
 H=1.50m,L=4m

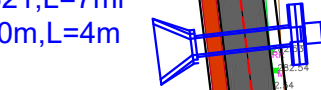

77
 1+329

78
 1+354

79
 1+379

80
 1+404

81
 1+429

276

LEGJENDA	
	ASFALT
	TROTUAR
	AKSI
	RELIEVI
	URE METALIKE
	TOMBINO
	MUR BUTOBETONI



POROSITESI : BASHKIA MAT

OBJEKTI: "Ndertimi i rruges fshati Bater ,bashkia Mat"

Emertimi: Planimetria e pergjithshme



"Imperium Construction", shpk
 Adresa: njesi Bashkiake nr.9 Rruga "Shyqyri Peza"
 Pallati 21, Hyrja 1,Kati 2 ,Tirane

Drejtues i projektit

Adm. Arber TOLA

Projektues

Inxh. Elton LLAPUSHI
 Inxh. Ilir Hodaj
 Ark. Rigert HYRA

Mek. Bujar MERAJ
 Elek. Altin ALLKAJ
 Top. Iv BEQARI

SHKALLA

1- 500

MAT 2022

FLETA

1 - 01

Format A3

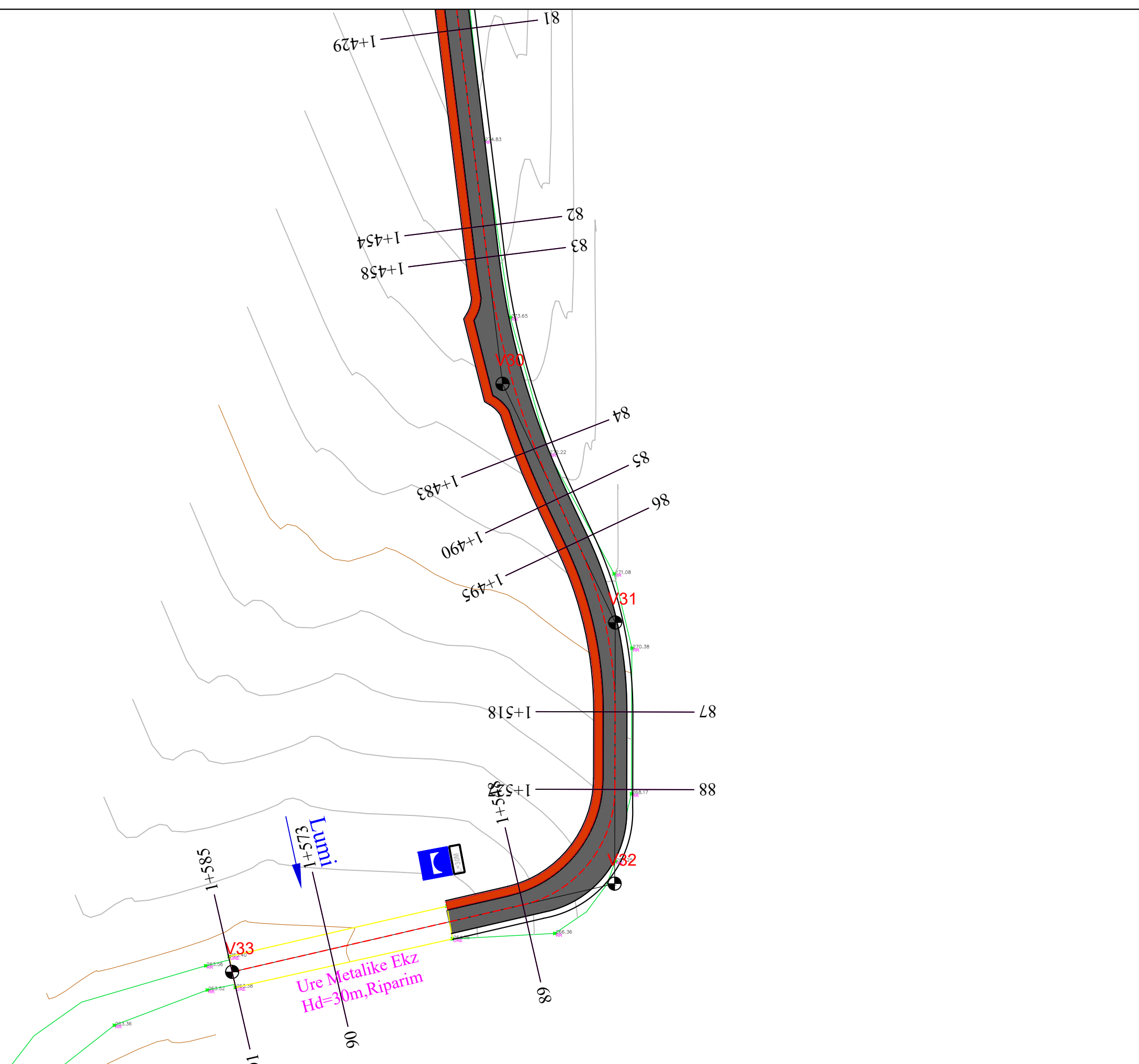
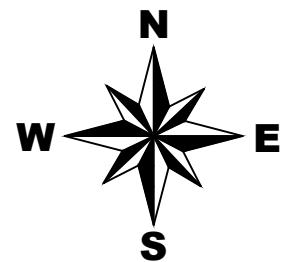

LEGJENDA	
	ASFALT
	TROTUAR
	AKSI
	RELIEVI
	URE METALIKE
	TOMBINO
	MUR BUTOBETONI

POROSITESI : BASHKIA MAT

OBJEKTI: "Ndertimi i rruges fshati Bater ,bashkia Mat"

Emertimi: **Planimetria e pergjithshme**

"Imperium Construction", shpk

Adresa: njesi Bashkiake nr.9 Rruga "Shyqyri Peza"
Pallati 21, Hyrja 1,Kati 2 ,Tirane

Drejtues i projektit

Adm. Arber TOLA

Projektues	
Inxh. Elton LLAPUSHI	Mek. Bujar MERAJ
Inxh. Ilir Hodaj	Elek. Altin ALLKAJ
Ark. Rigert HYRA	Top. Iv BEQARI

SHKALLA	FLETA
1- 500	1 - 01
MAT 2022	Format A3



REPUBLIKA E SHQIPERISË
BASHKIA MAT

PROJEKT ZBATIMI

OBJEKTI:

Ndertimi i rruges fshati Bater, bashkia Mat
Seksionet terthore



POROSITESI : BASHKIA MAT

OBJEKTI: "Ndertimi i rruges fshati Bater ,bashkia Mat"

Emertimi: Profili terthor



"Imperium Construction", shpk
Adresa: njesi Bashkiake nr.9 Rruga "Shyqyri Peza"
Pallati 21, Hyrja 1,Kati 2 ,Tirane

Drejtues i projektit

Adm. Arber TOLA

Projektues

Inxh. Elton LLAPUSHI
Inxh. Ilir Hodaj
Ark. Rigert HYRA

Mek. Bujar MERAJ
Elek. Altin ALLKAJ
Top. Iv BEQARI

SHKALLA

1- 200

MAT 2022

FLETA

1 - 01

Format A3

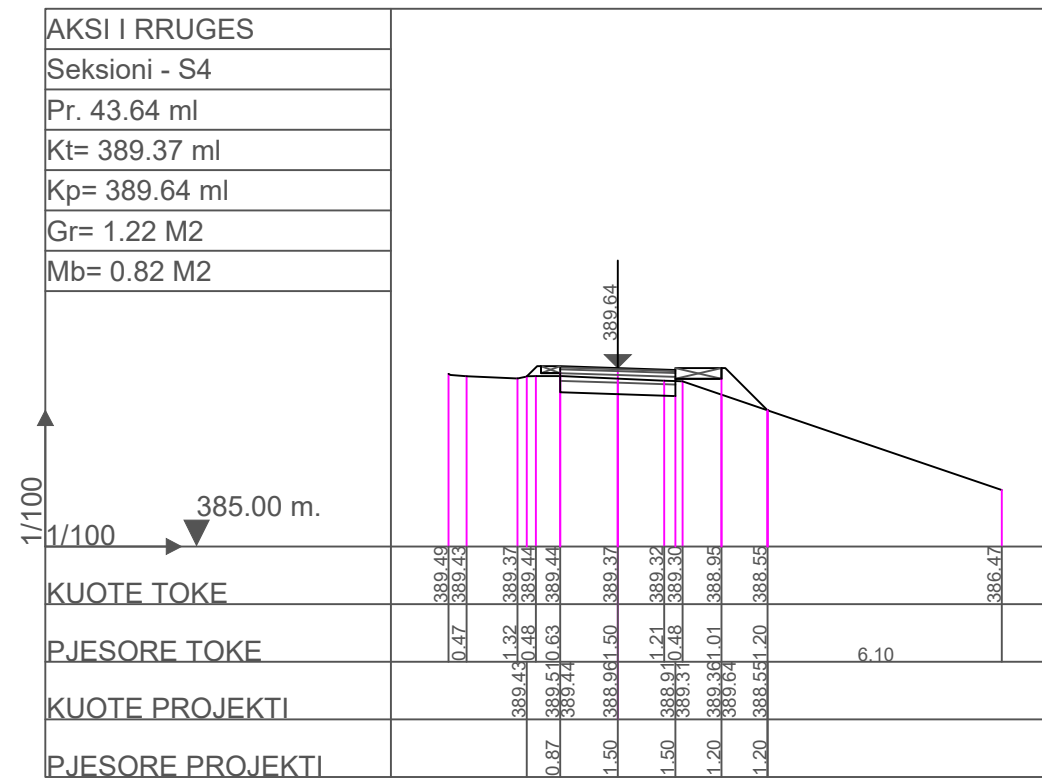
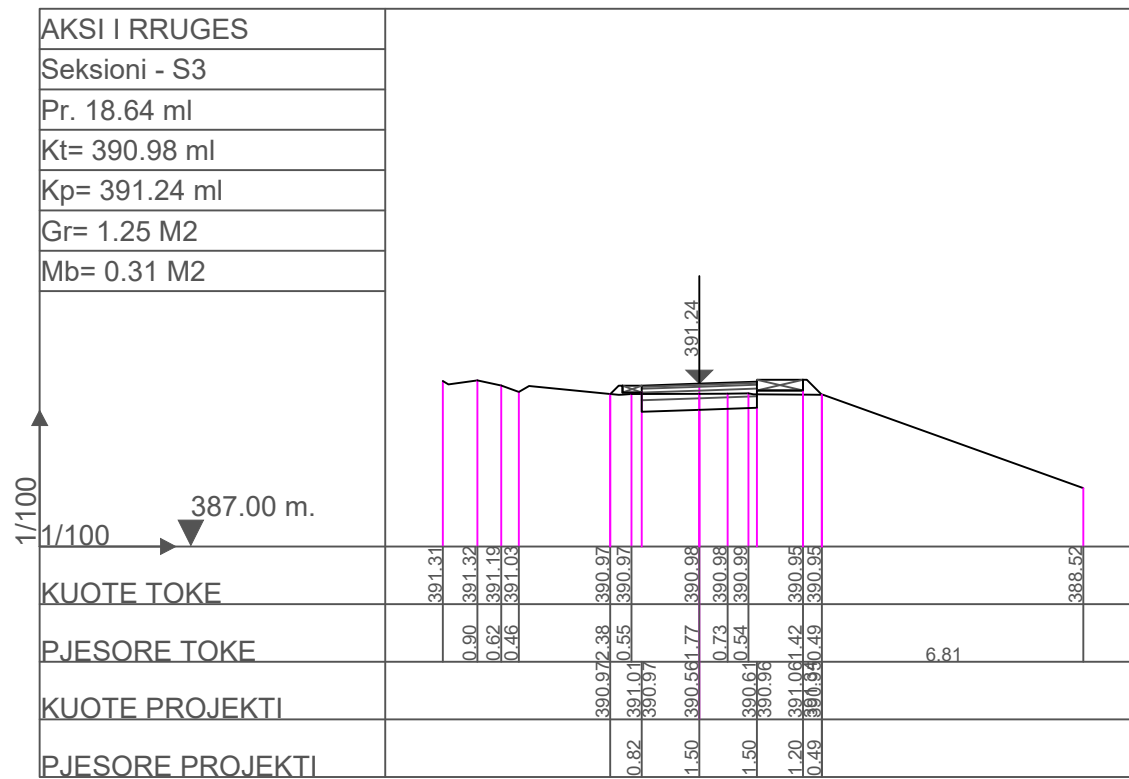
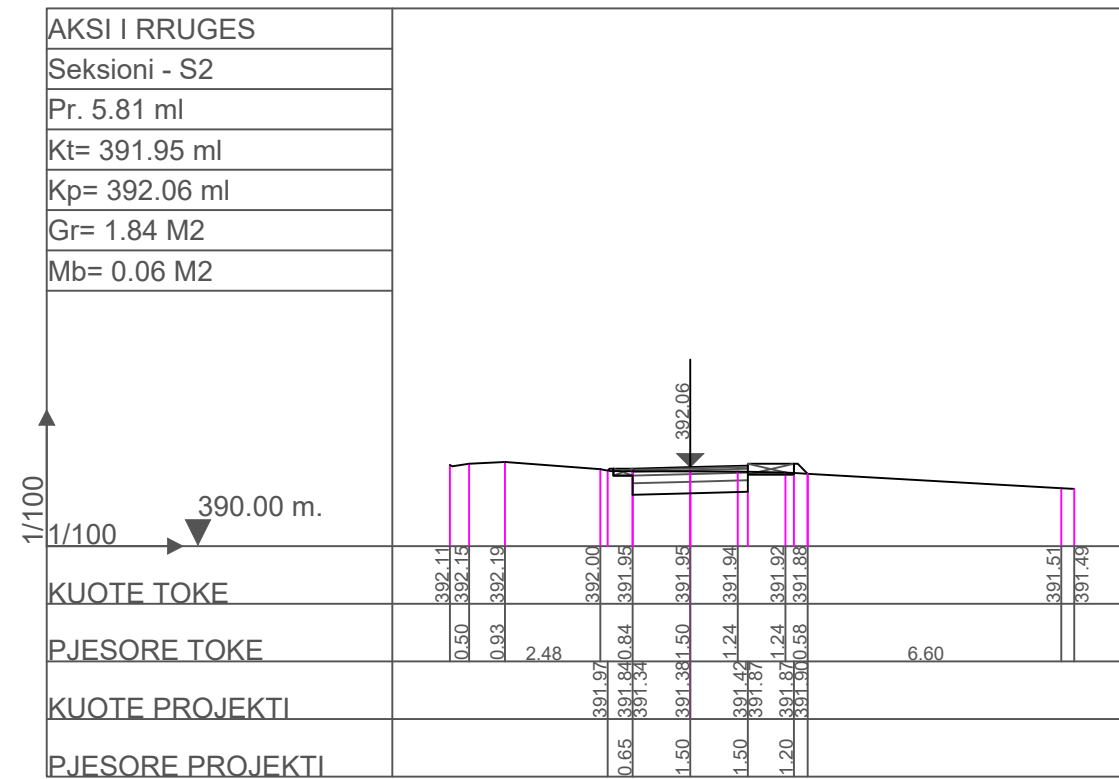
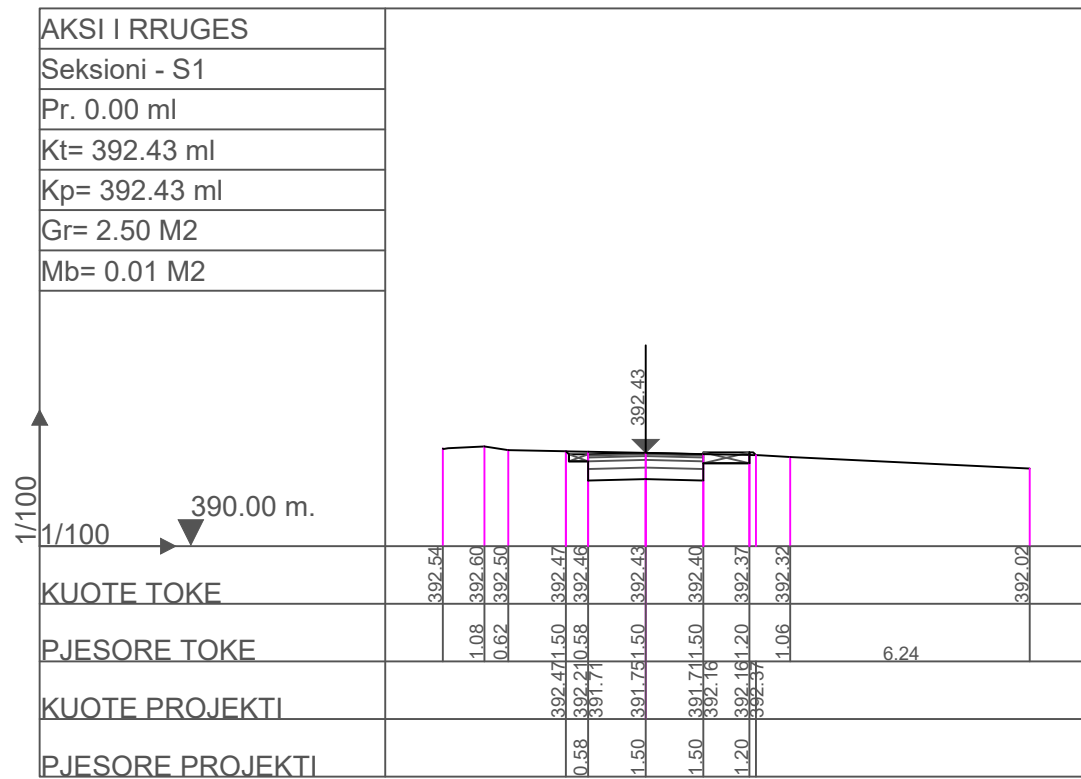

POROSITESI : BASHKIA MAT
 OBJEKTI: "Ndertimi i rruges fshati Bater ,bashkia Mat"

Emertimi: Profili terthor
 "Imperium Construction", shpk
 Adresa: njesi Bashkiake nr.9 Rruga "Shyqyri Peza"
 Pallati 21, Hyrja 1,Kati 2 ,Tirane



Drejtesues i projektit
 Adm. Arber TOLA

Projektues

Inxh. Elton LLAPUSHI	Mek. Bujar MERAJ
Inxh. Ilir Hodaj	Elek. Altin ALLKAJ
Ark. Rigert HYRA	Top. Iv BEQARI

SHKALLA	FLETA
1- 200	1 - 01
MAT 2022	Format A3

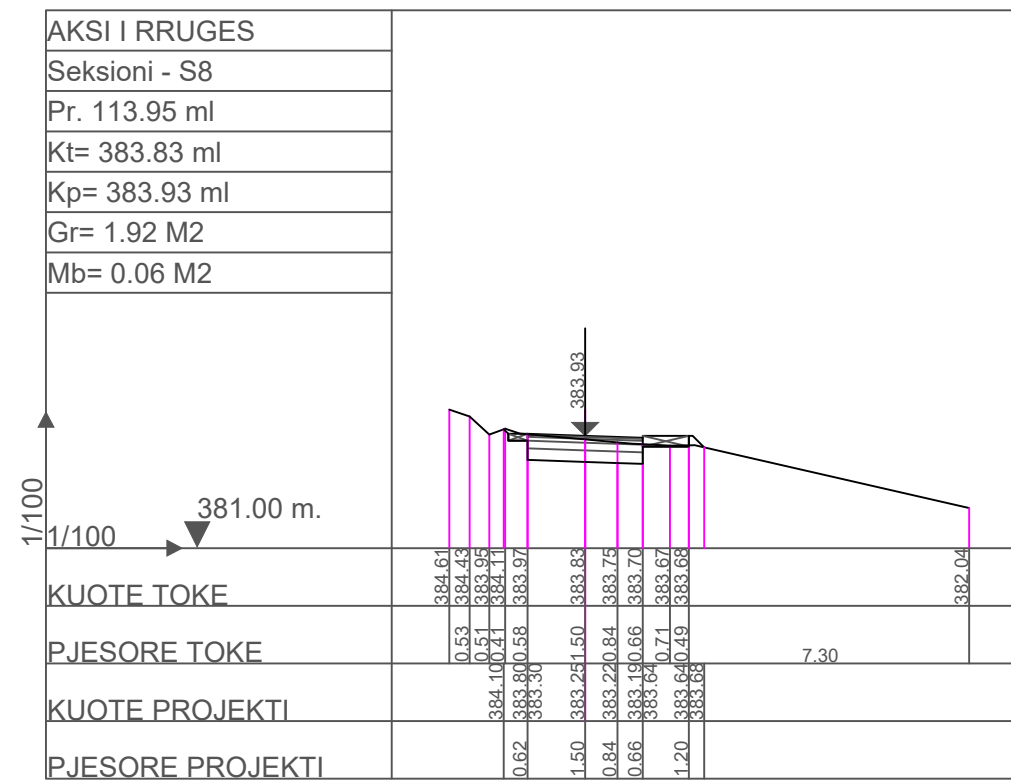
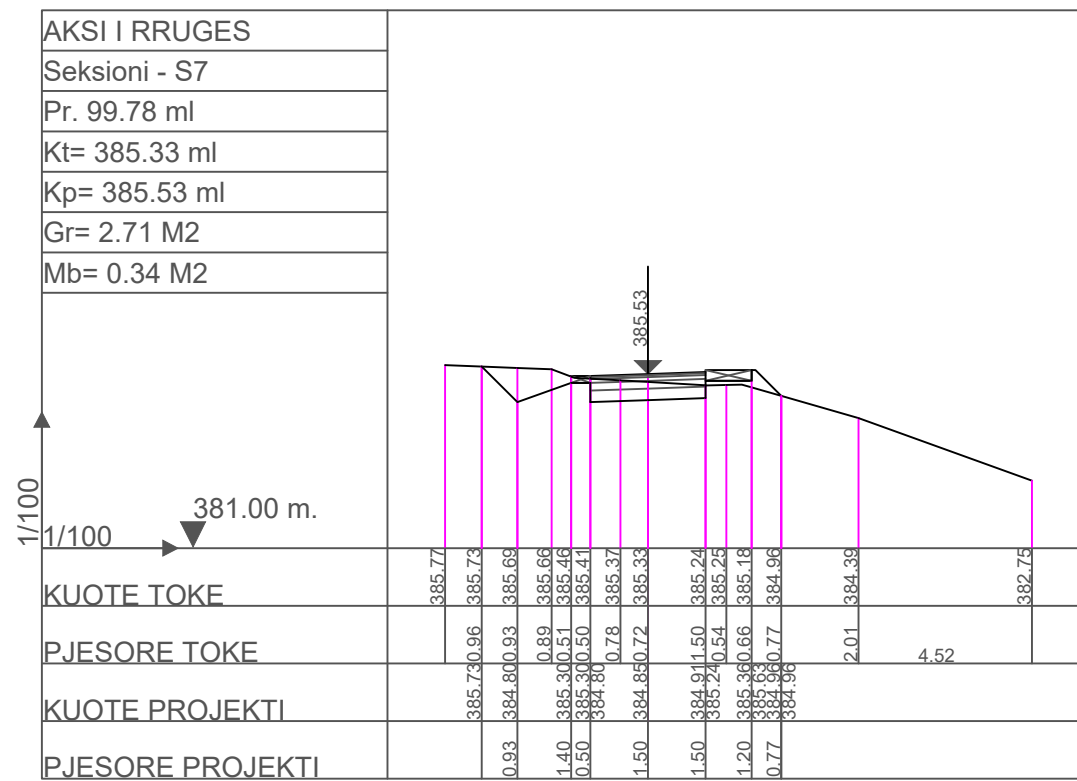
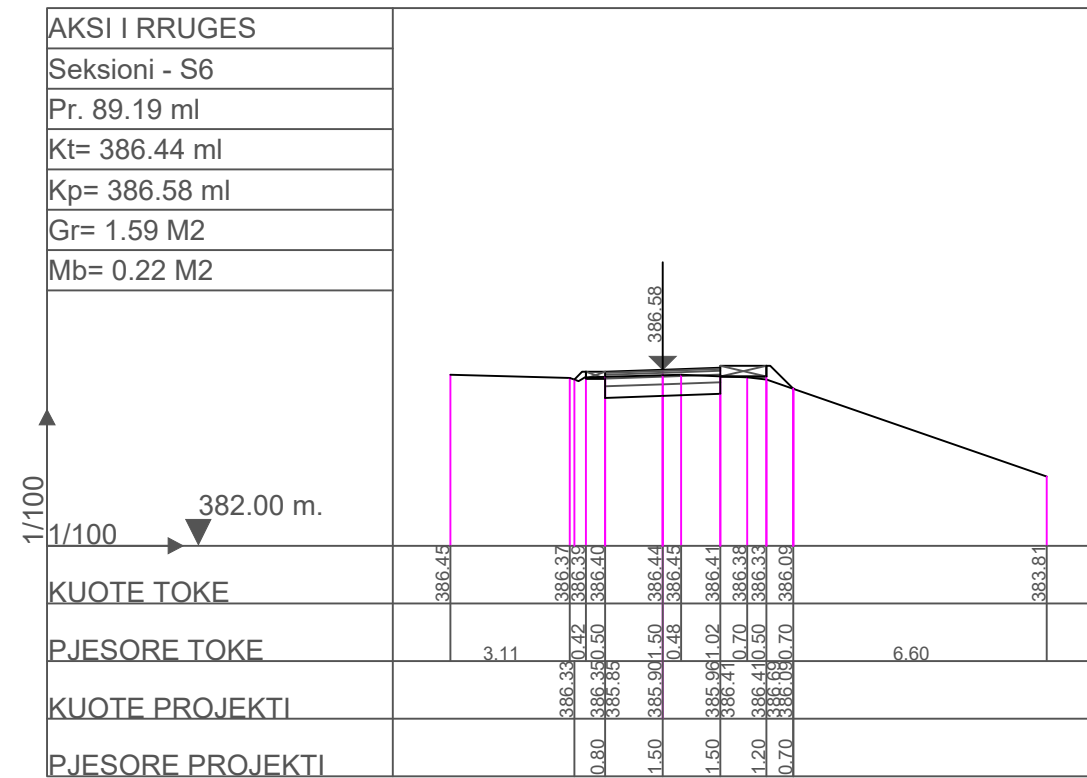
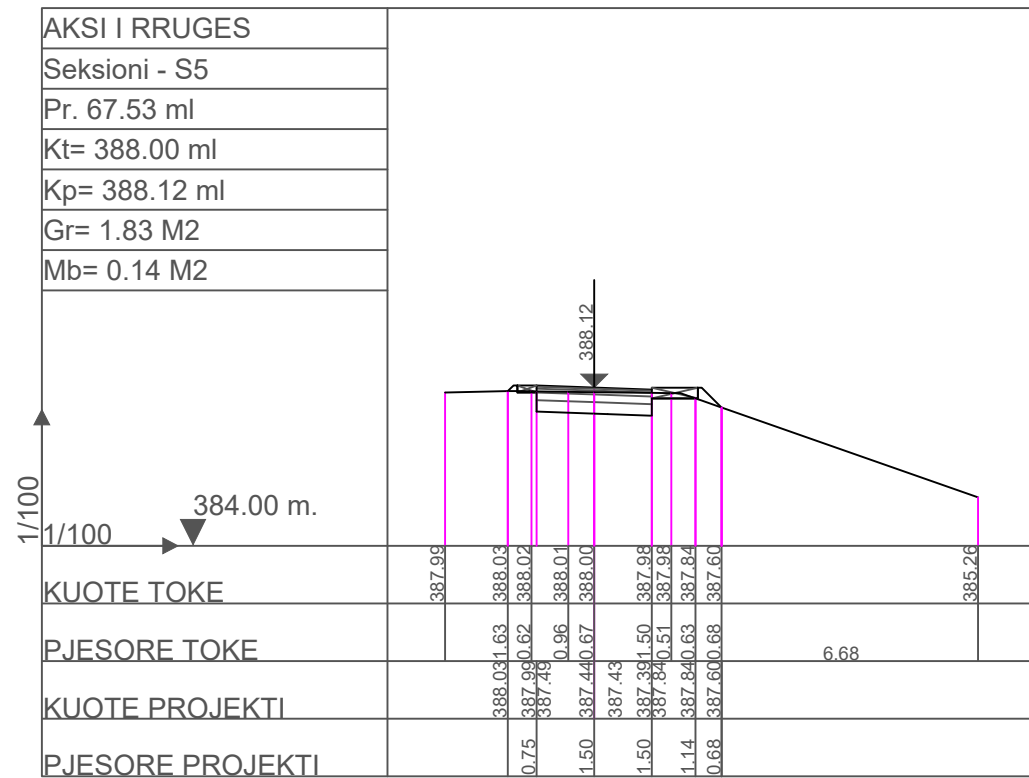

POROSITESI : BASHKIA MAT

OBJEKTI: "Ndertimi i rruges fshati Bater ,bashkia Mat"

Emertimi: Profili terthor



"Imperium Construction", shpk
 Adresa: njesi Bashkiake nr.9 Rruga "Shyqyri Peza"
 Pallati 21, Hyrja 1,Kati 2 ,Tirane

Drejtesues i projektit

Adm. Arber TOLA

Projektues

Inxh. Elton LLAPUSHI
 Inxh. Ilir Hodaj
 Ark. Rigert HYRA

Mek. Bujar MERAJ
 Elek. Altin ALLKAJ
 Top. Iv BEQARI

SHKALLA

1- 200

MAT 2022

FLETA

1 - 01

Format A3

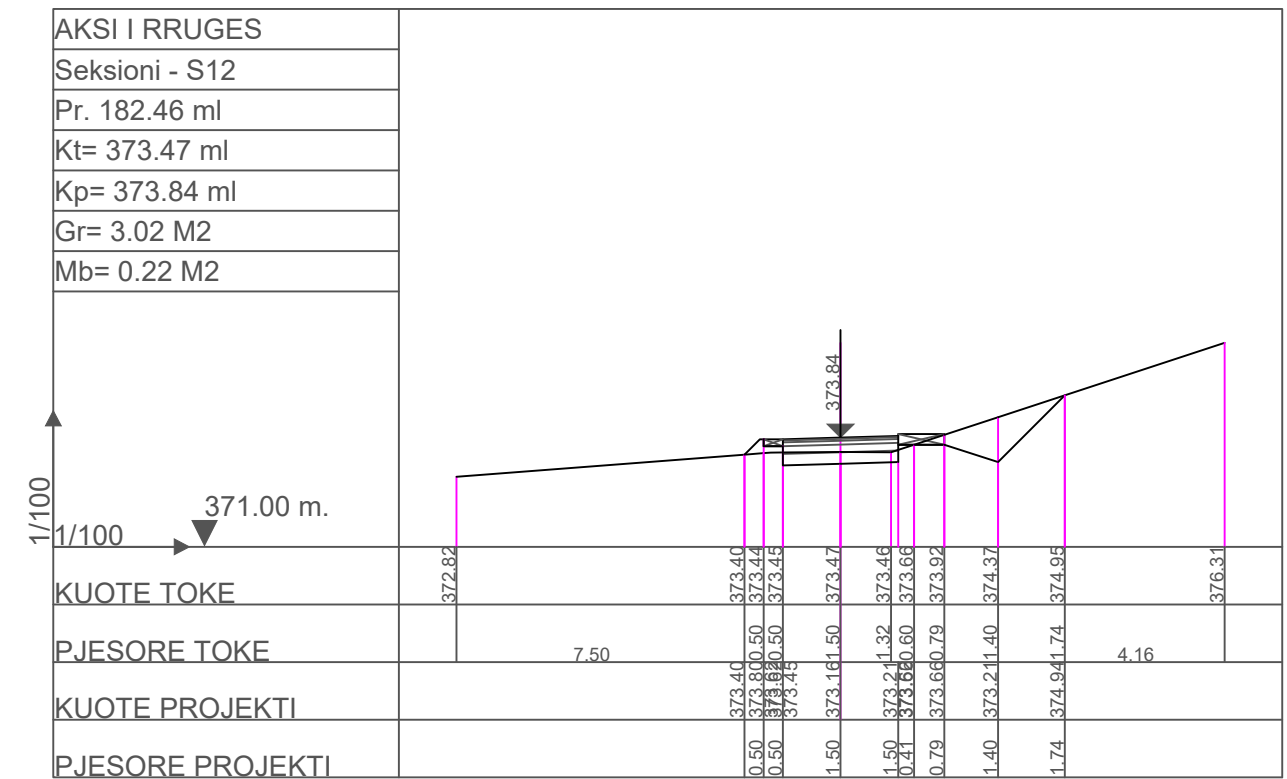
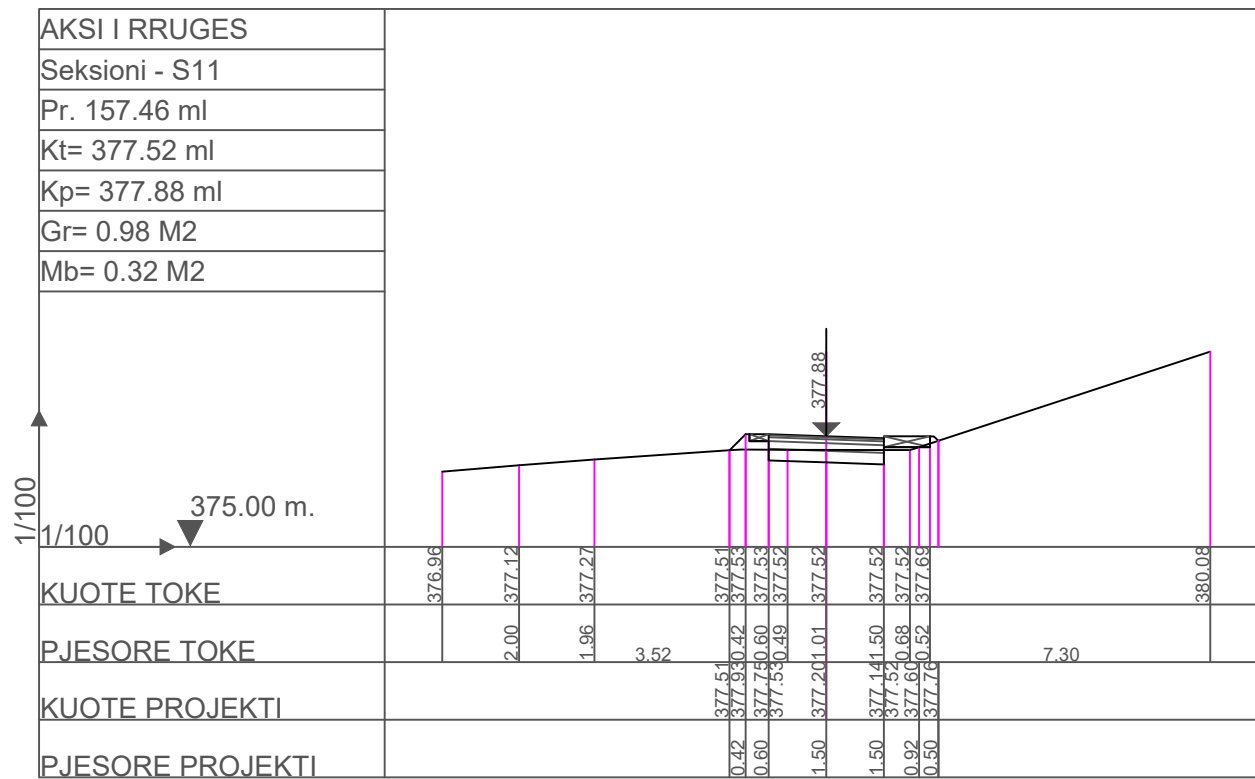
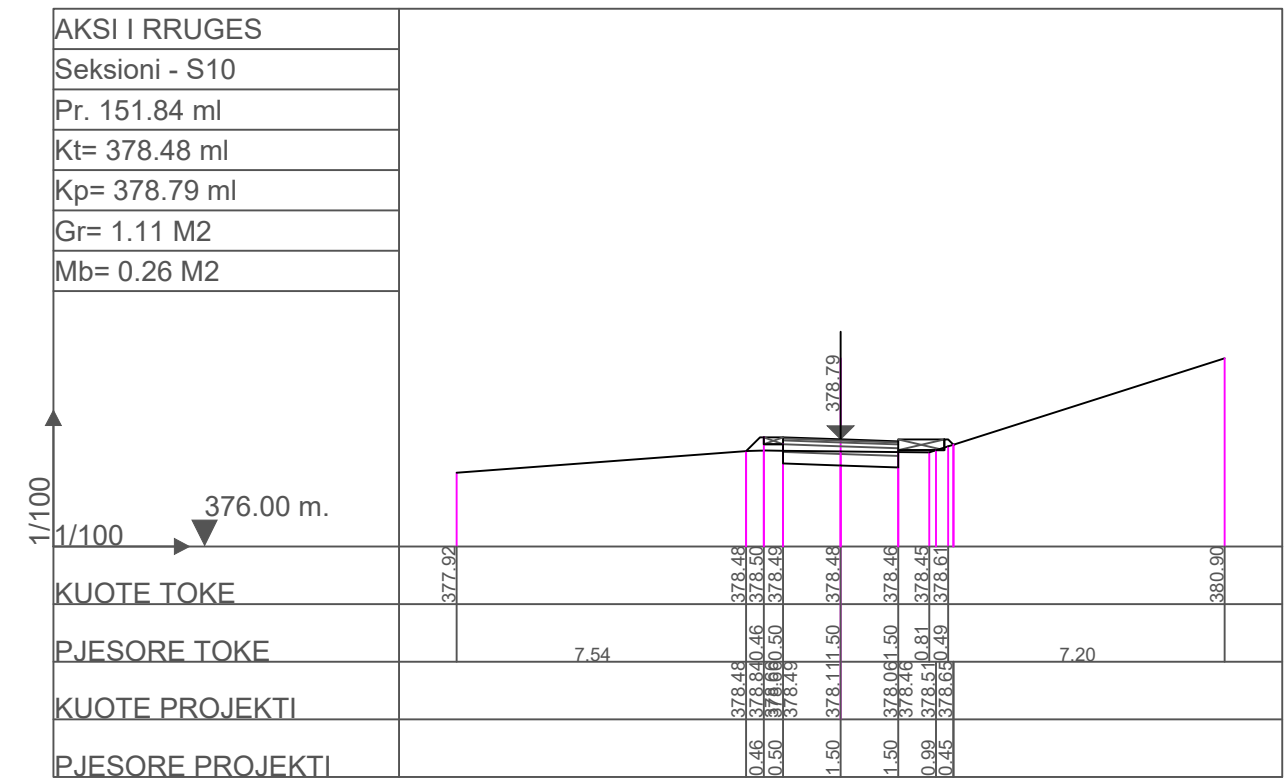
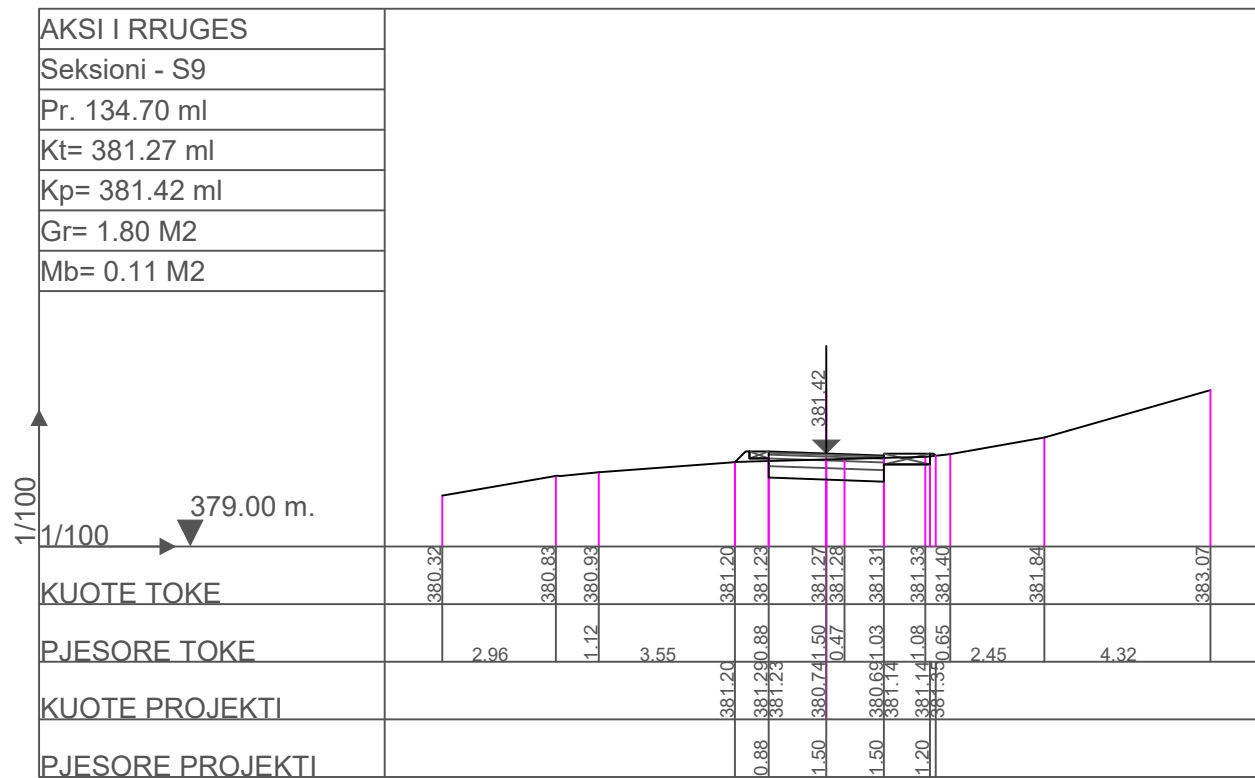

POROSITESI : BASHKIA MAT

OBJEKTI: "Ndertimi i rruges fshati Bater ,bashkia Mat"

Emertimi: Profili terthor



"Imperium Construction", shpk
Adresa: njesi Bashkiake nr.9 Rruga "Shyqyri Peza"
Pallati 21, Hyrja 1,Kati 2 ,Tirane

Drejtes i projektit

Adm. Arber TOLA

Projektues

Inxh. Elton LLAPUSHI
Inxh. Ilir Hodaj
Ark. Rigert HYRA

Mek. Bujar MERAJ
Elek. Altin ALLKAJ
Top. Iv BEQARI

SHKALLA

1- 200

MAT 2022

FLETA

1 - 01

Format A3

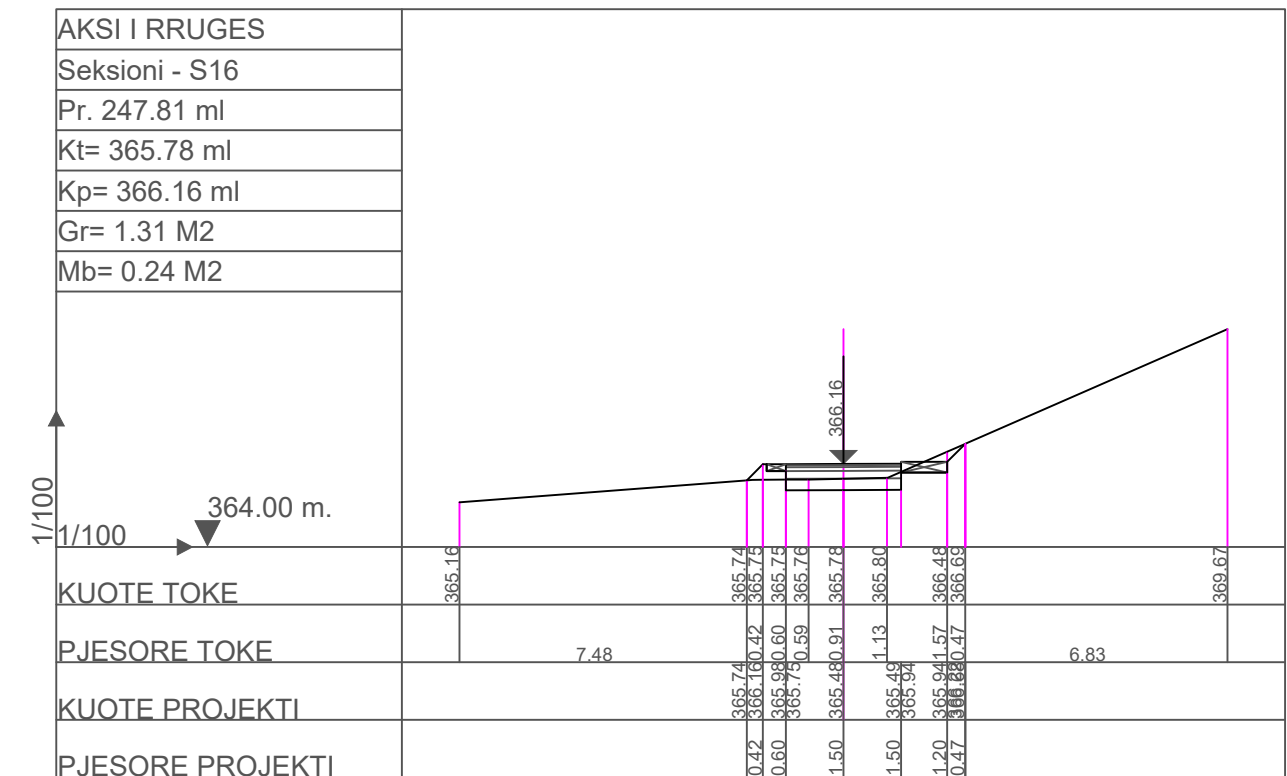
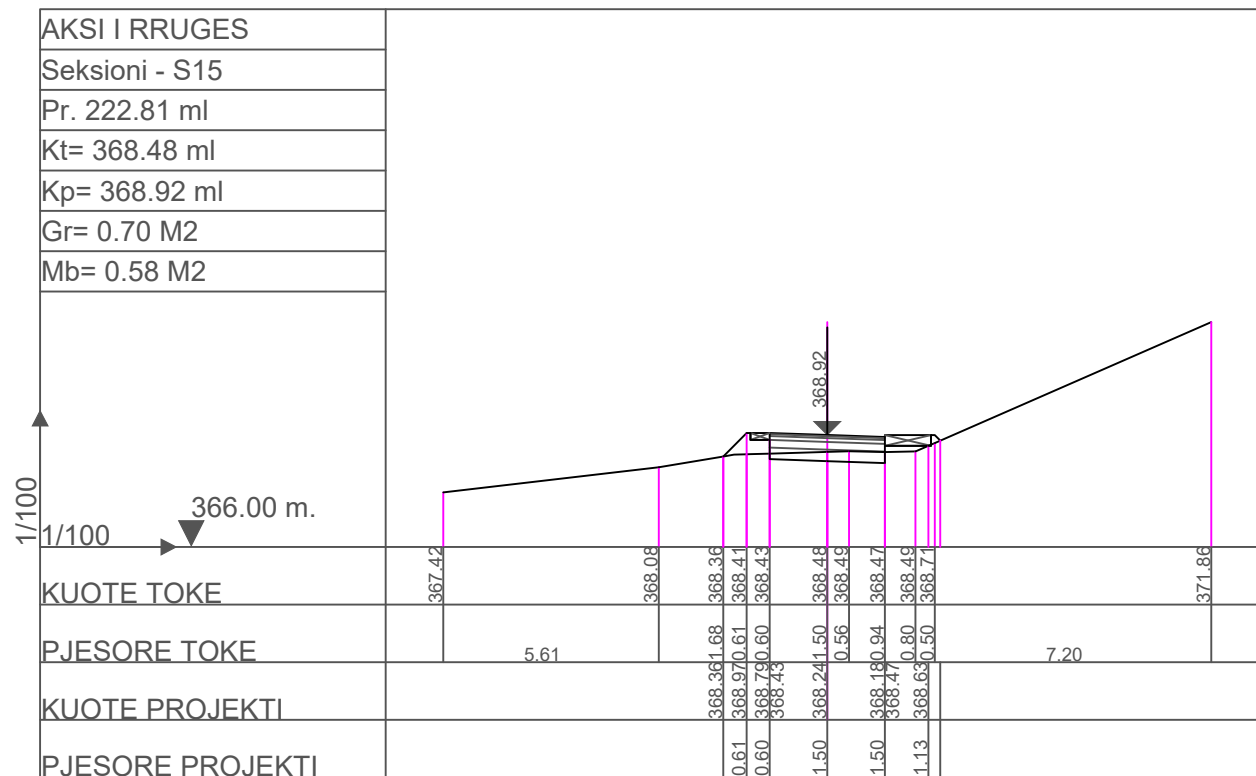
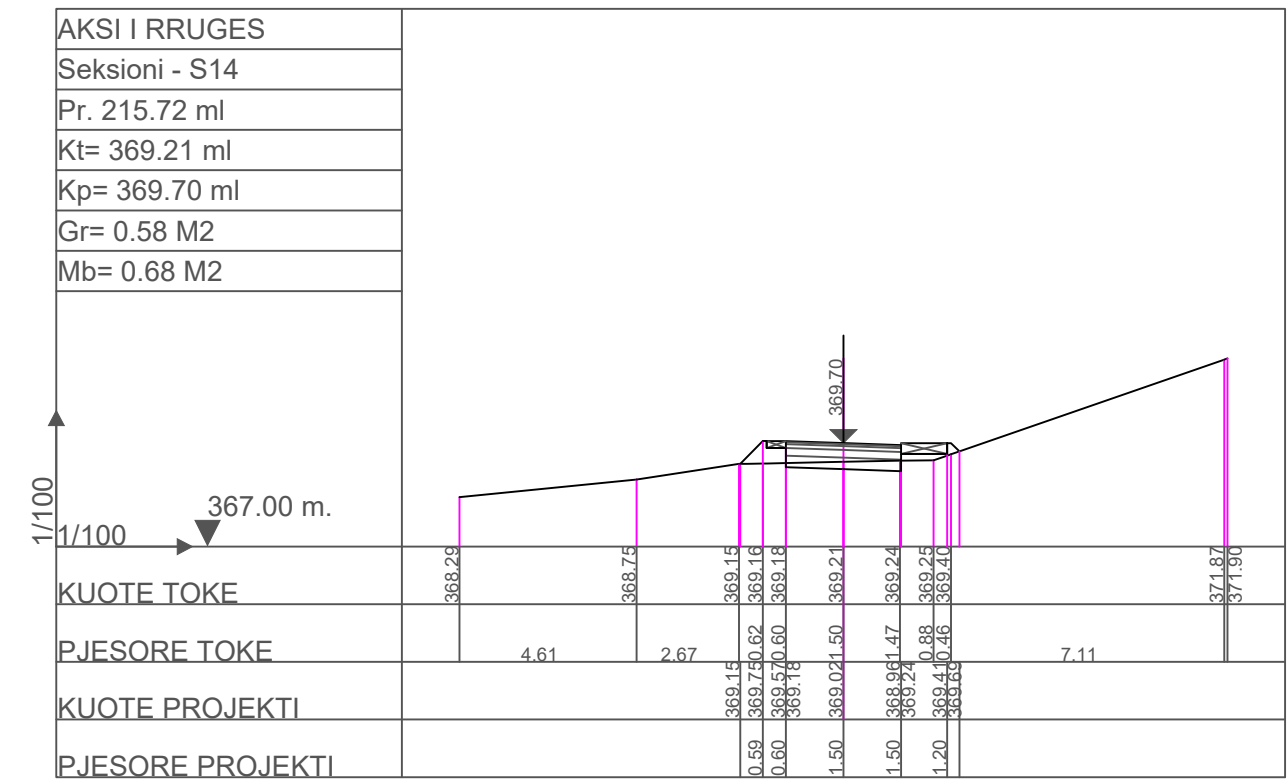
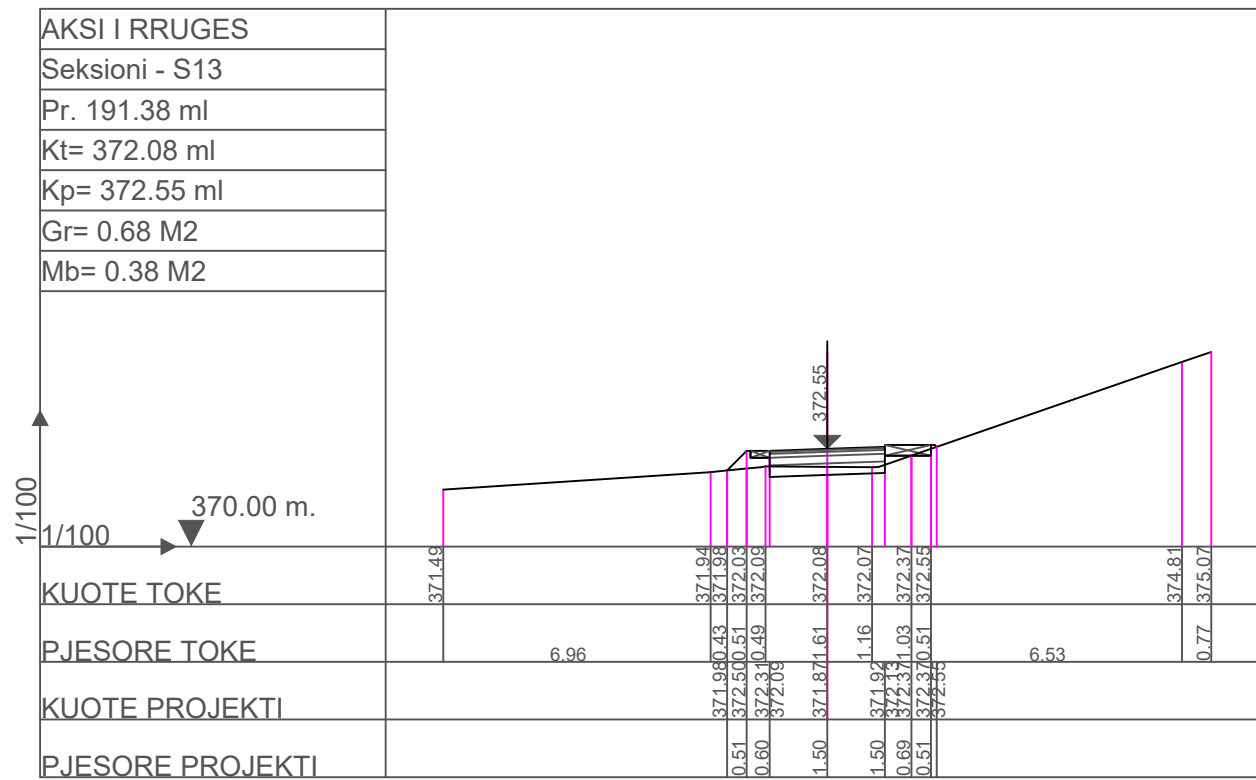

POROSITESI : BASHKIA MAT

OBJEKTI: "Ndertimi i rruges fshati Bater ,bashkia Mat"

Emertimi: Profili terthor



"Imperium Construction", shpk
 Adresa: njesi Bashkiake nr.9 Rruga "Shyqyri Peza"
 Pallati 21, Hyrja 1,Kati 2 ,Tirane

Drejtes i projektit

Adm. Arber TOLA

Projektues

Inxh. Elton LLAPUSHI
 Inxh. Ilir Hodaj
 Ark. Rigert HYRA

Mek. Bujar MERAJ
 Elek. Altin ALLKAJ
 Top. Iv BEQARI

SHKALLA

1- 200

MAT 2022

FLETA

1 - 01

Format A3

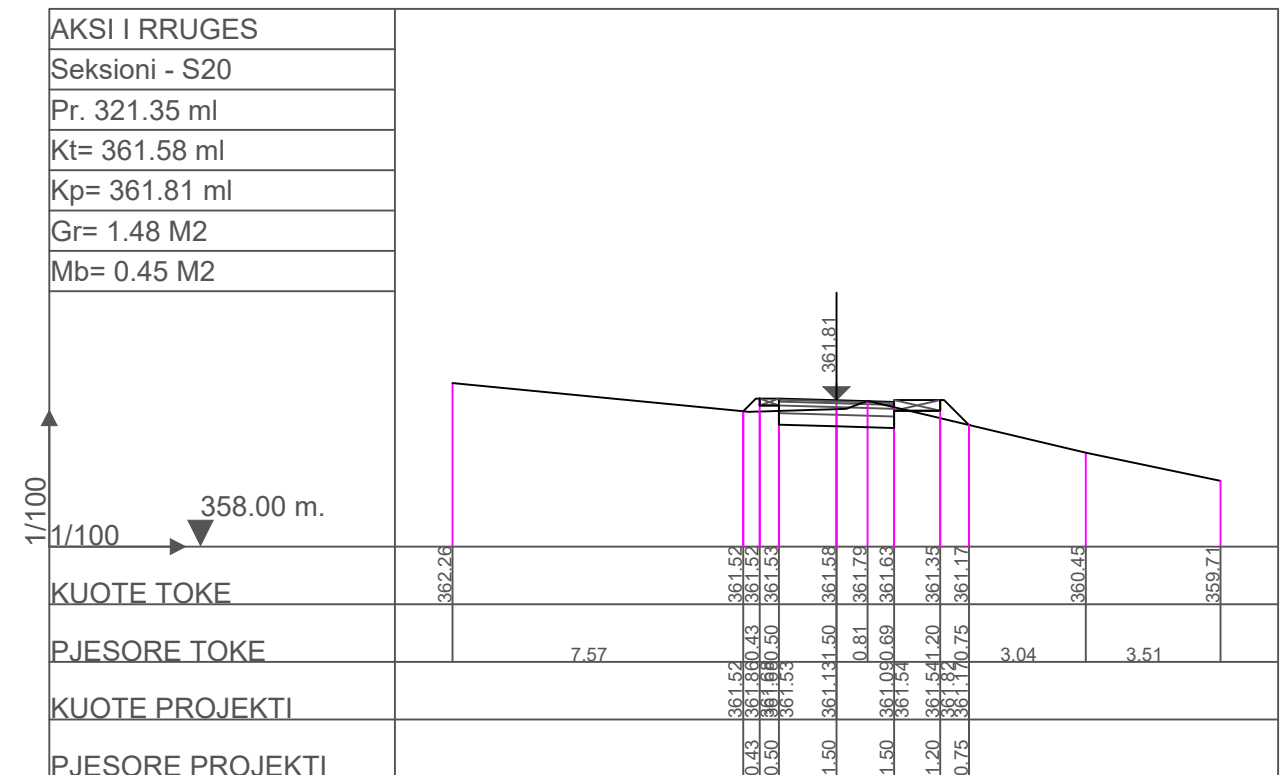
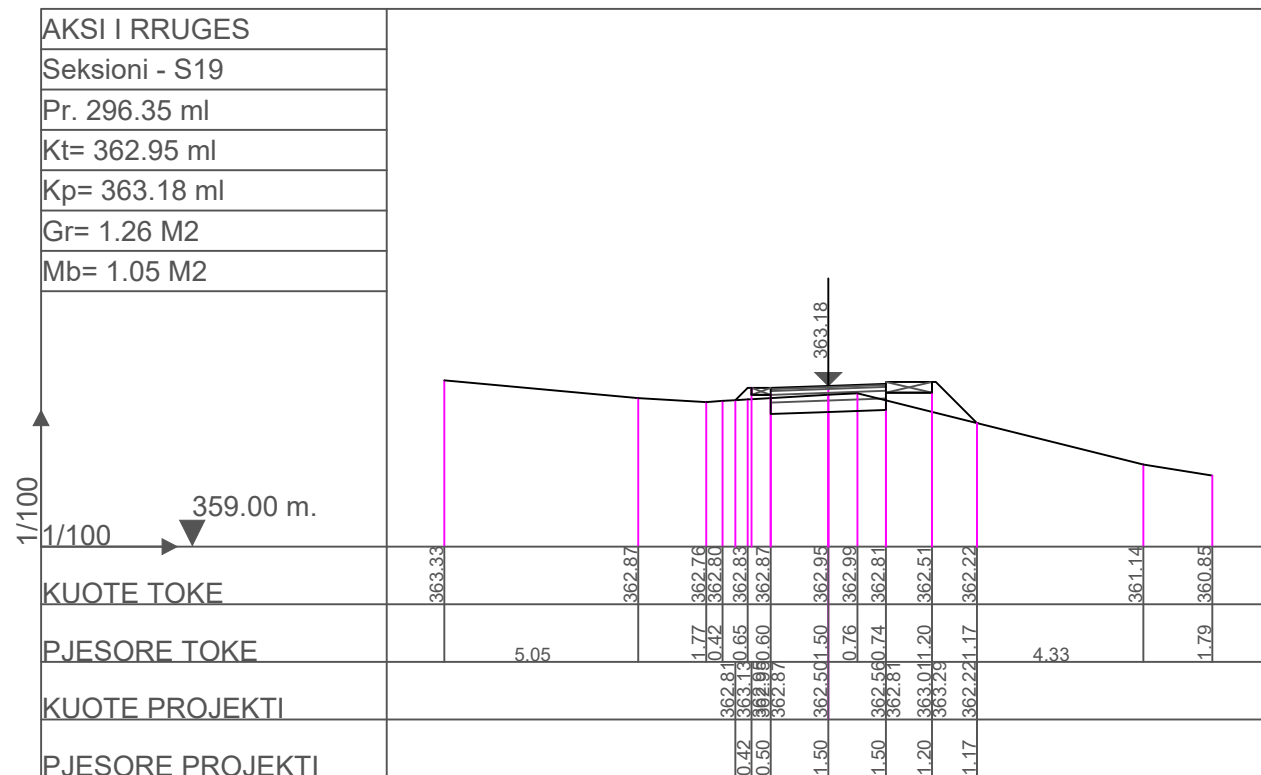
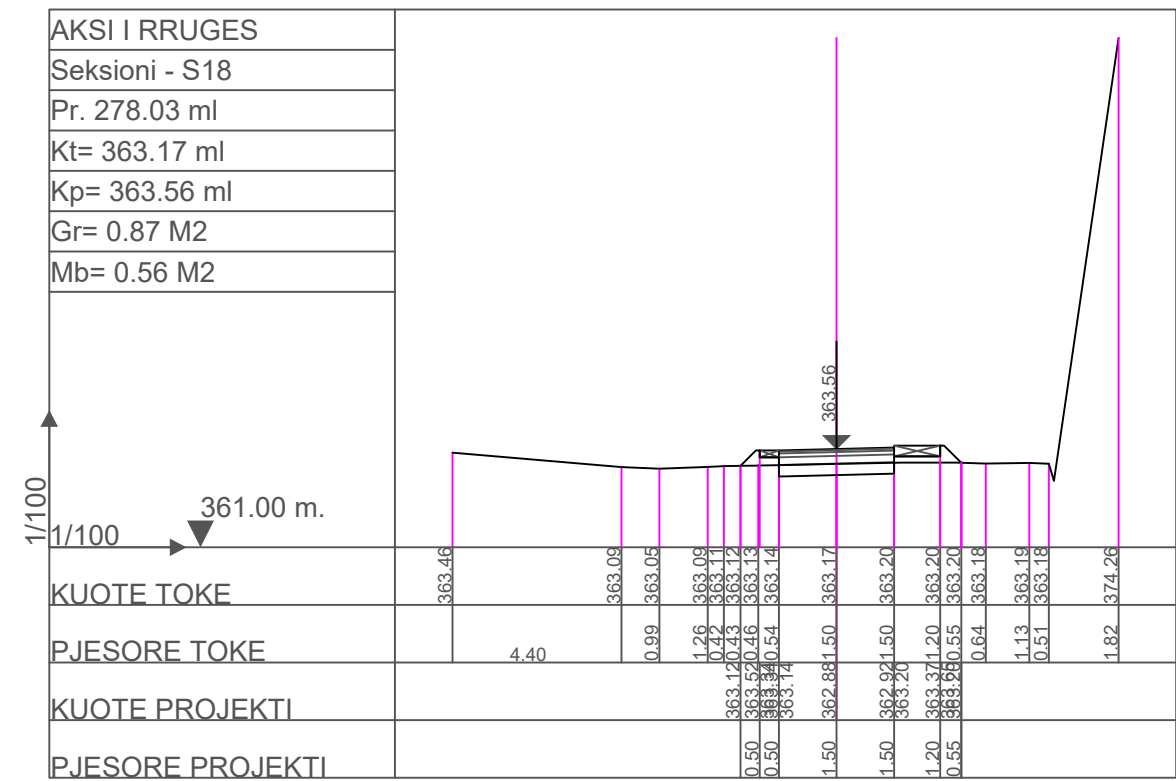
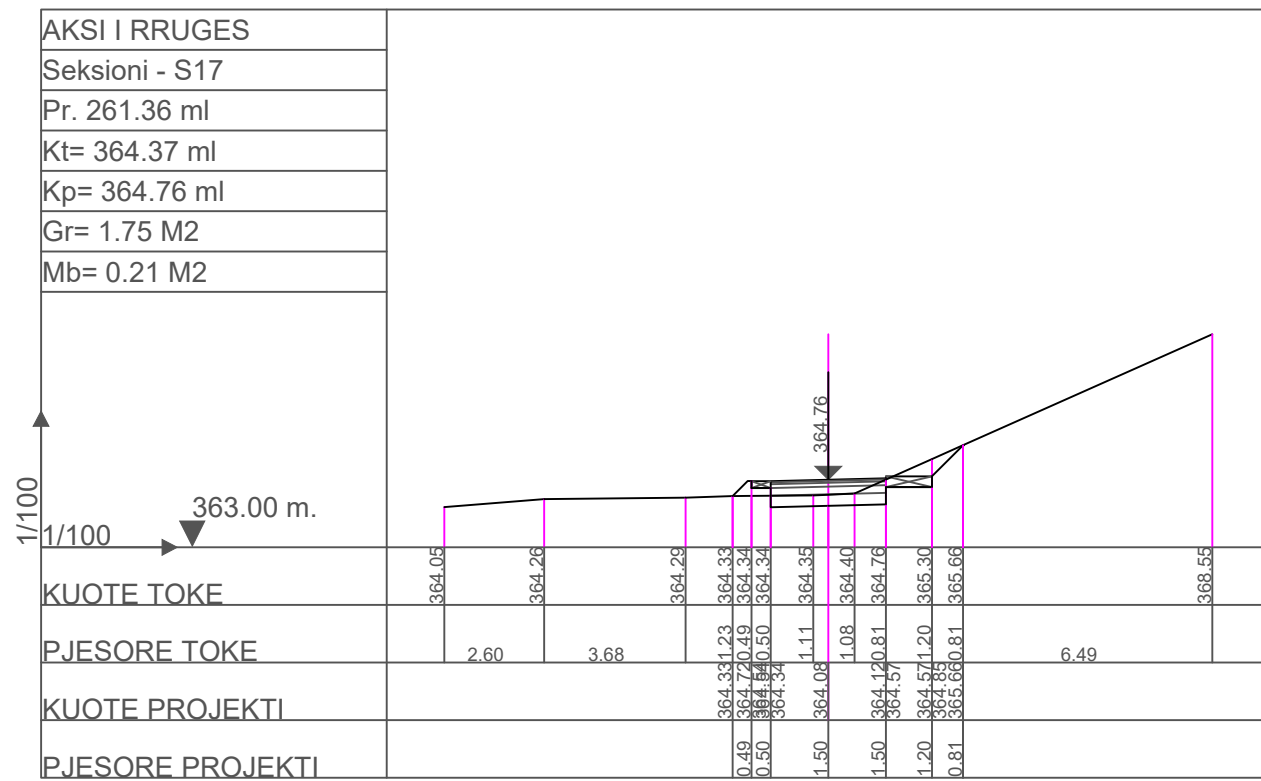

POROSITESI : BASHKIA MAT
 OBJEKTI: "Ndertimi i rruges fshati Bater ,bashkia Mat"

Emertimi: Profili terthor
"Imperium Construction", shpk
 Adresa: njesi Bashkiake nr.9 Rruga "Shyqyri Peza"
 Pallati 21, Hyrja 1,Kati 2 ,Tirane

Drejtes i projektit
 Adm. Arber TOLA

Projektues
 Inxh. Elton LLAPUSHI
 Inxh. Ilir Hodaj
 Ark. Rigert HYRA
 Mek. Bujar MERAJ
 Elek. Altin ALLKAJ
 Top. Iv BEQARI

SHKALLA	FLETA
1- 200	1 - 01
MAT 2022	Format A3

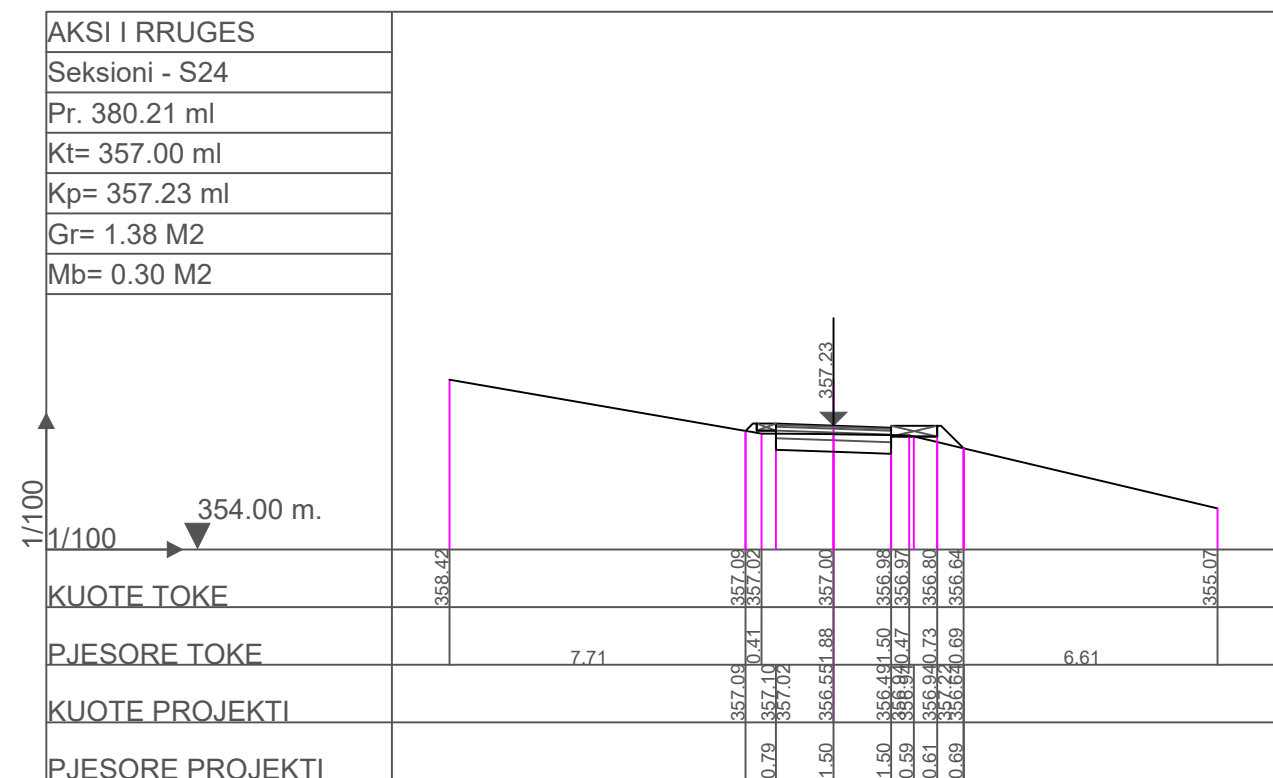
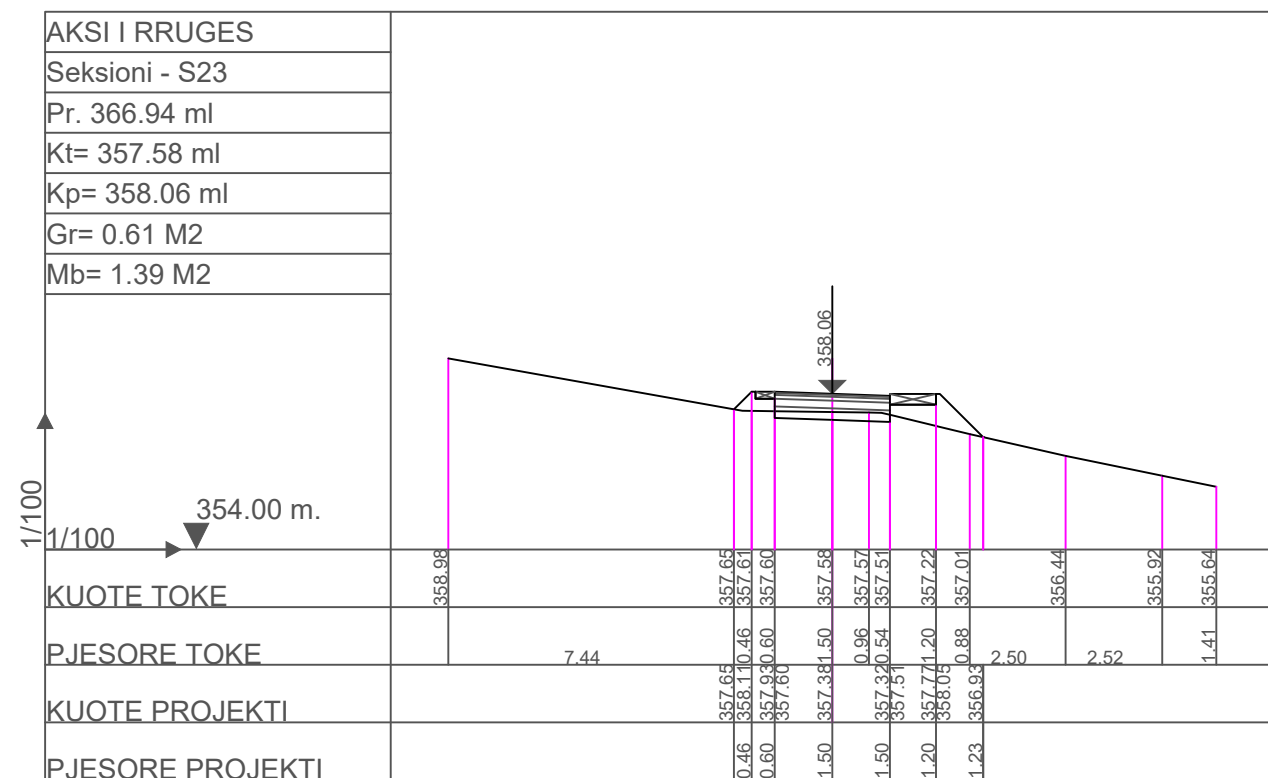
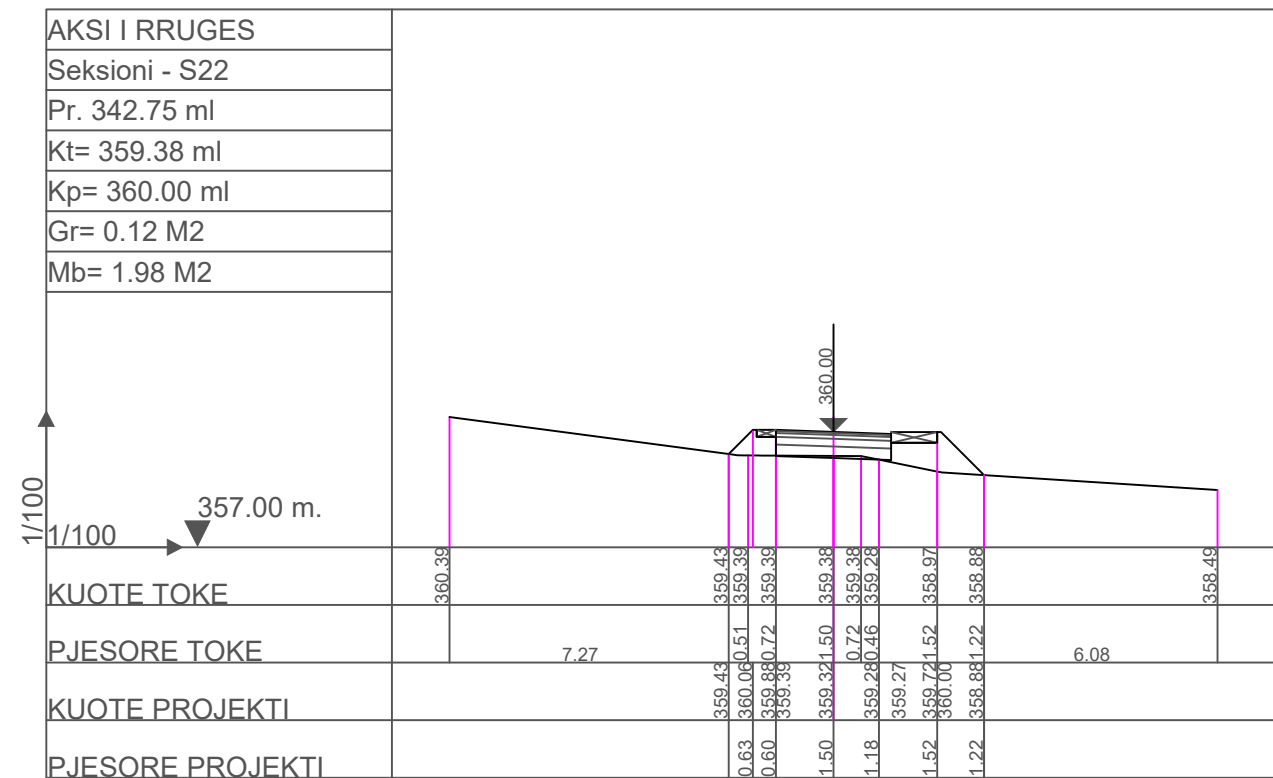
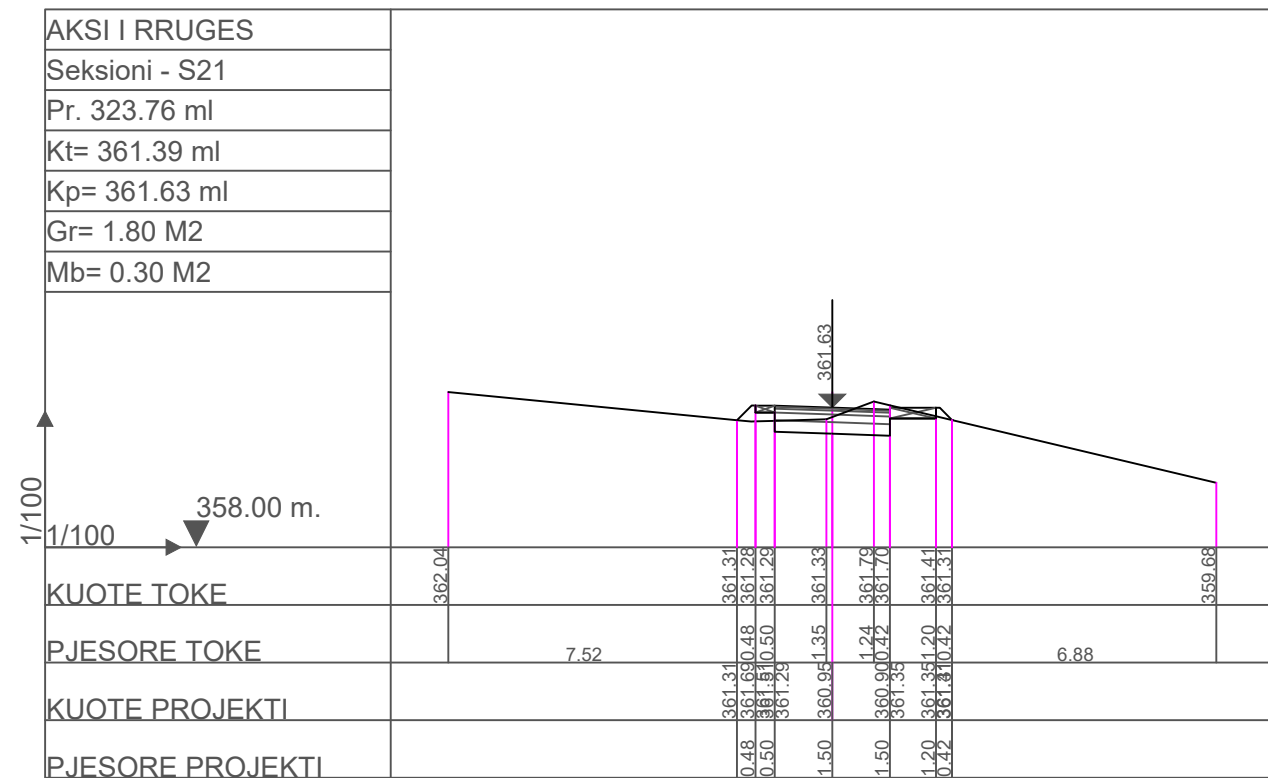

POROSITESI : BASHKIA MAT

OBJEKTI: "Ndertimi i rruges fshati Bater ,bashkia Mat"

Emertimi: **Profili terthor**



"Imperium Construction", shpk

Adresa: njesi Bashkiake nr.9 Rruga "Shyqyri Peza"
Pallati 21, Hyrja 1,Kati 2 ,Tirane

Drejtesues i projektit

Adm. Arber TOLA

Projektues

Inxh. Elton LLAPUSHI	Mek. Bujar MERAJ
Inxh. Ilir Hodaj	Elek. Altin ALLKAJ
Ark. Rigert HYRA	Top. Iv BEQARI

SHKALLA FLETA

1- 200

1- 01

MAT 2022

Format A3

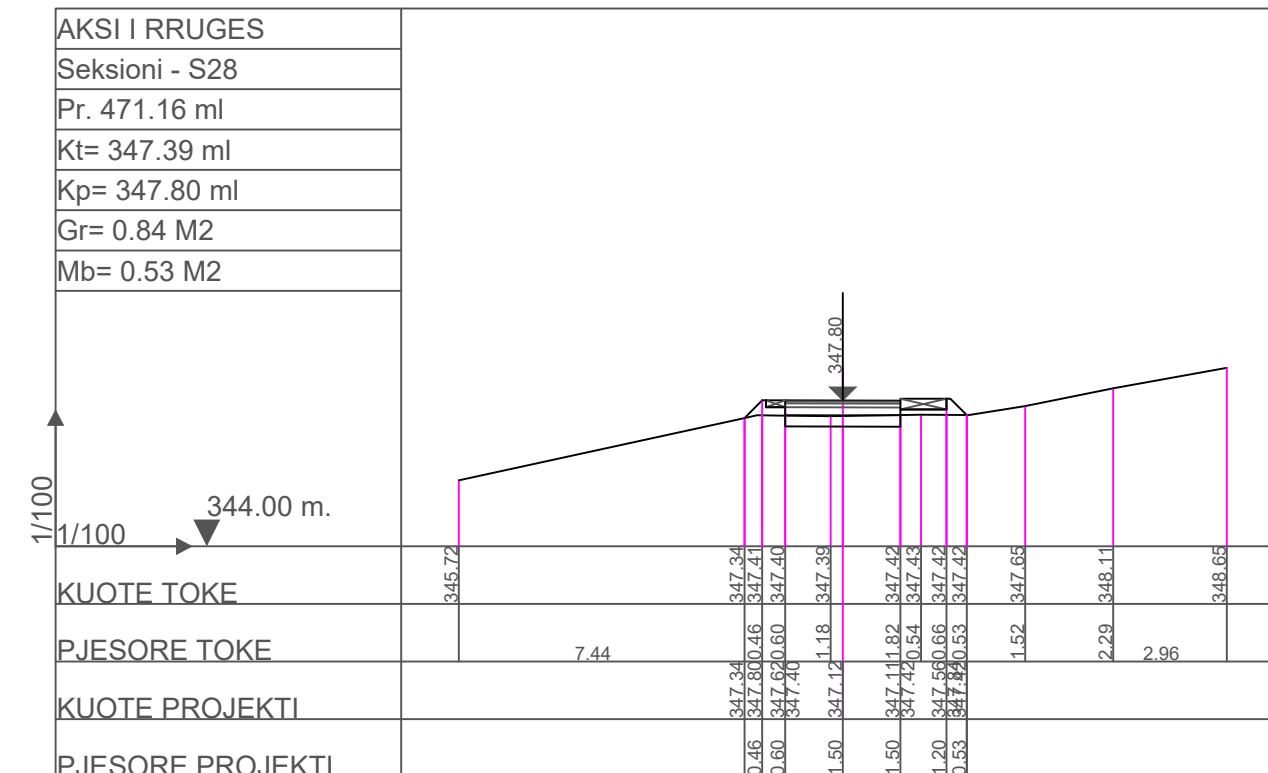
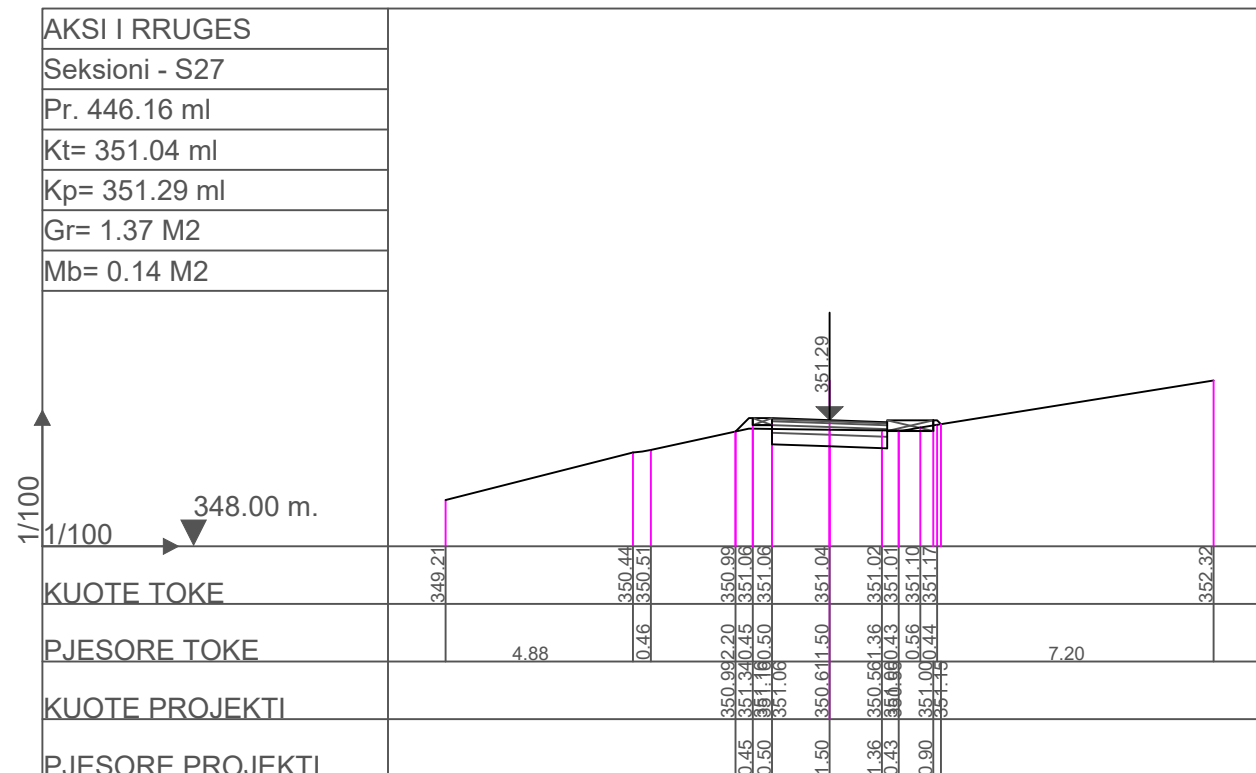
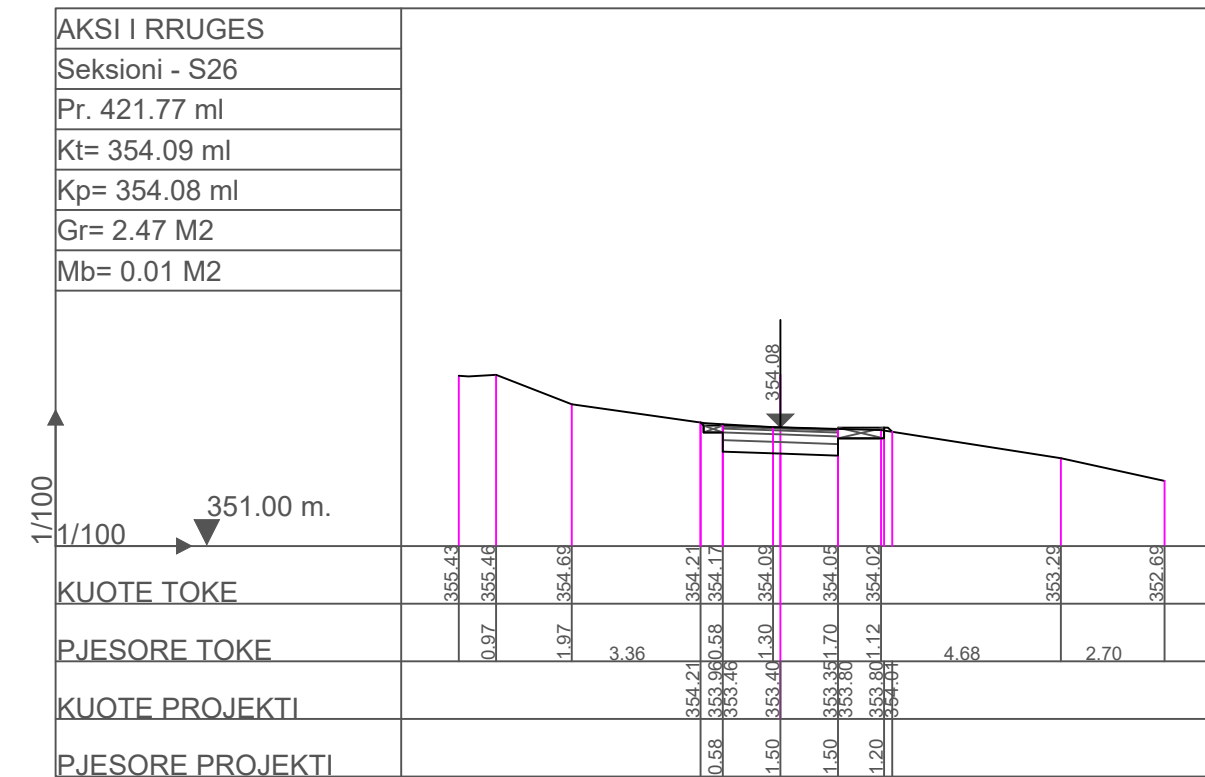
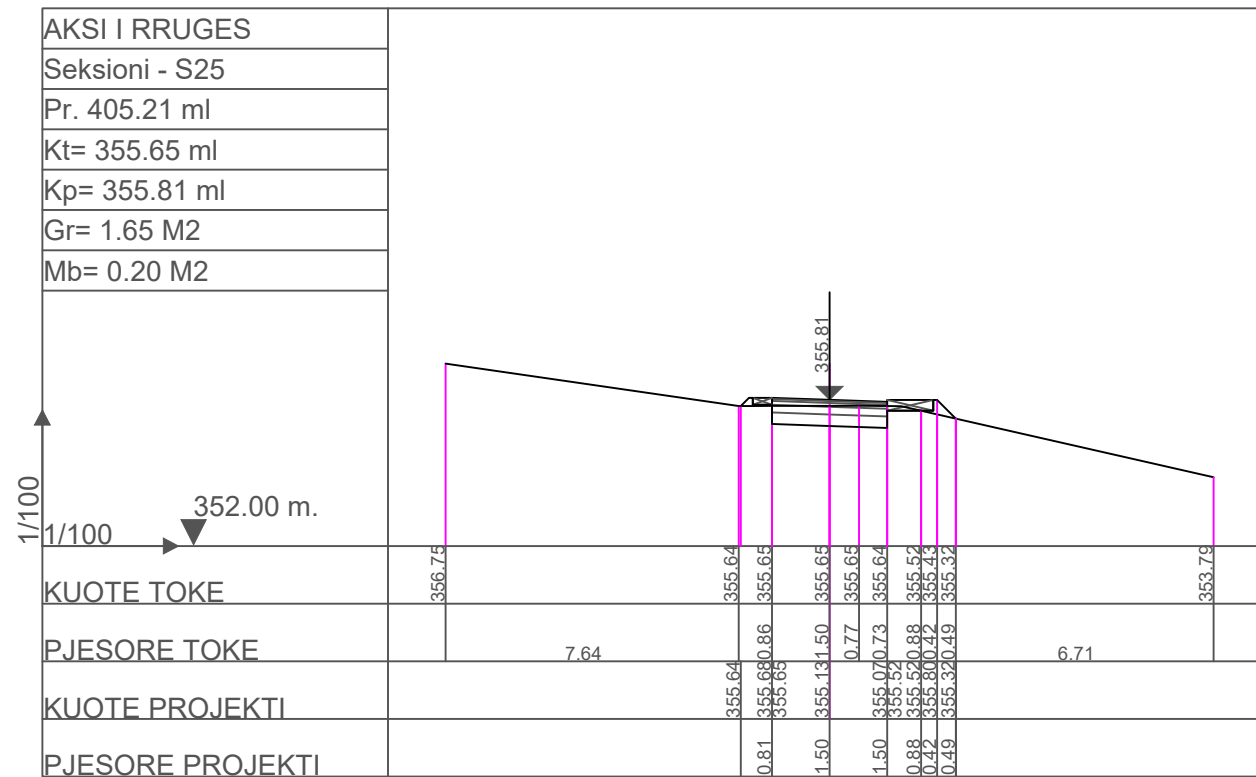

POROSITESI : BASHKIA MAT

OBJEKTI: "Ndertimi i rruges fshati Bater ,bashkia Mat"

Emertimi: Profili terthor



"Imperium Construction", shpk
 Adresa: njesi Bashkiake nr.9 Rruga "Shyqyri Peza"
 Pallati 21, Hyrja 1,Kati 2 ,Tirane

Drejtesues i projektit

Adm. Arber TOLA

Projektues

Inxh. Elton LLAPUSHI
 Inxh. Ilir Hodaj
 Ark. Rigert HYRA

Mek. Bujar MERAJ
 Elek. Altin ALLKAJ
 Top. Iv BEQARI

SHKALLA

1- 200

MAT 2022

FLETA

1 - 01

Format A3

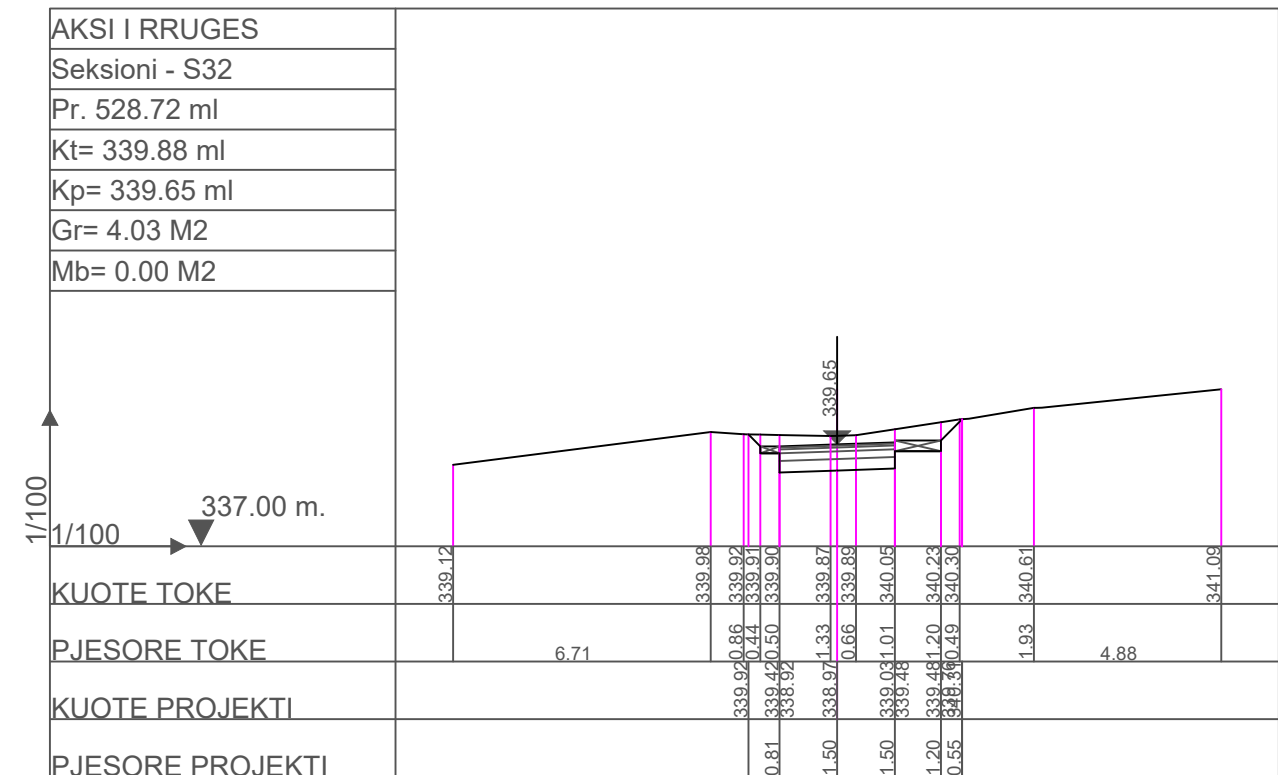
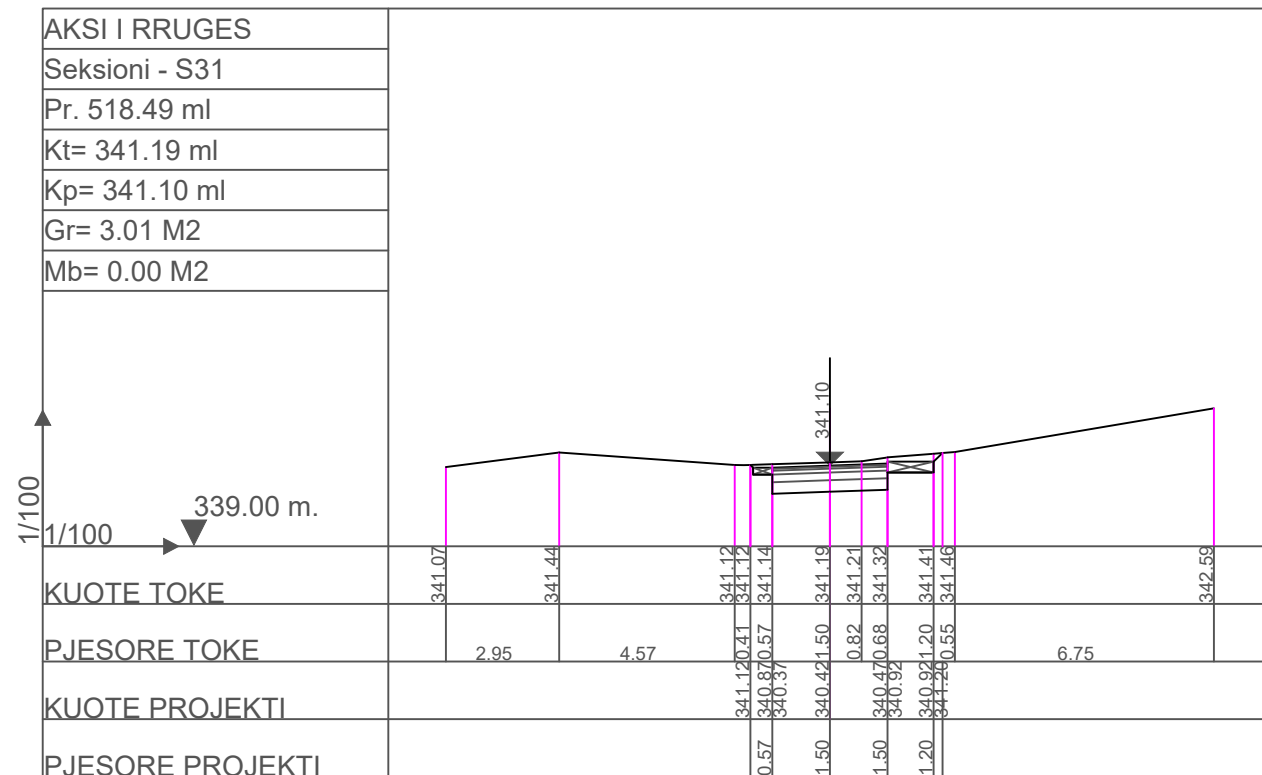
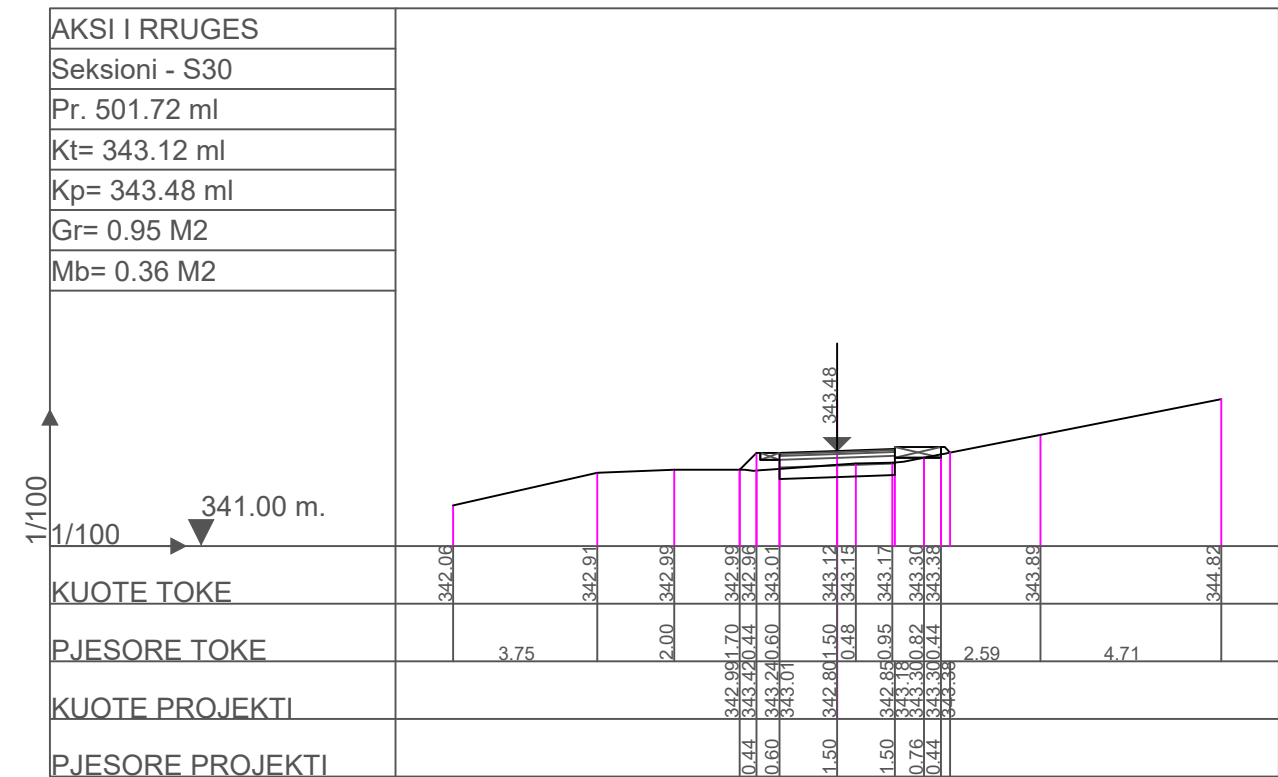
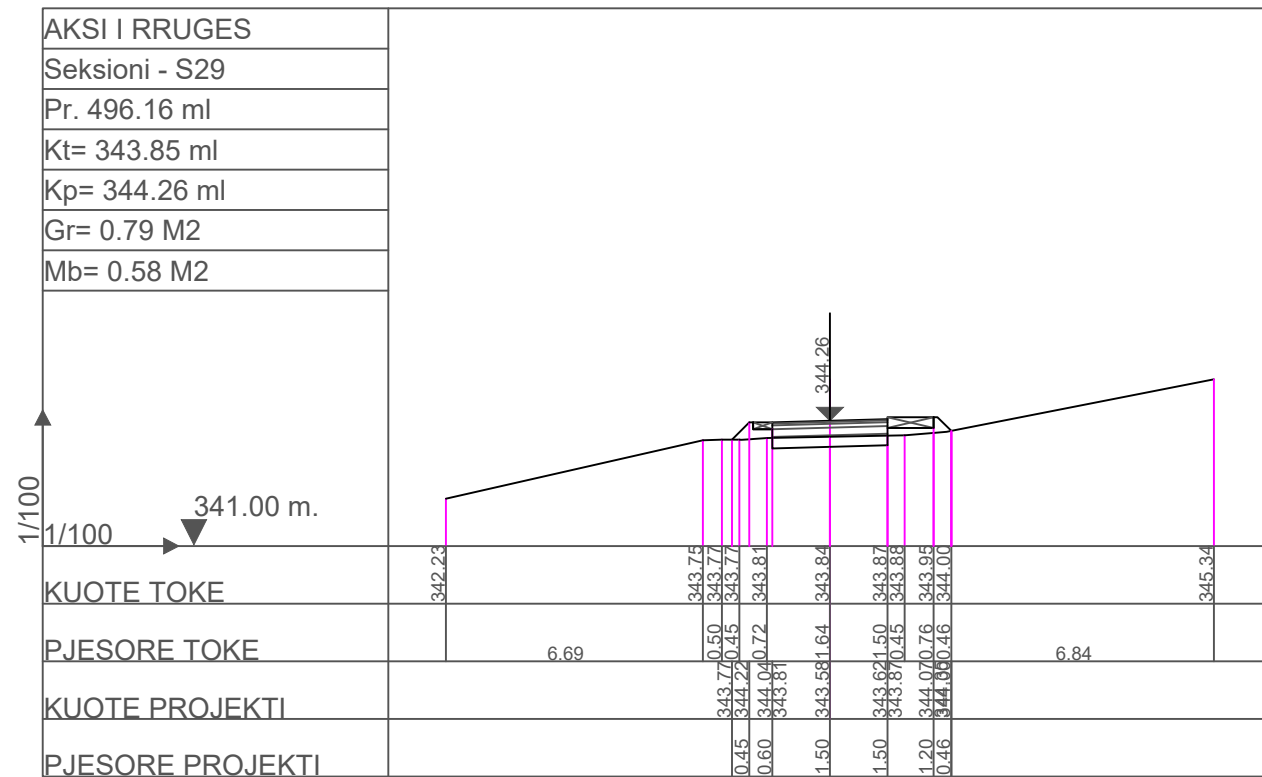

POROSITESI : BASHKIA MAT
 OBJEKTI: "Ndertimi i rruges fshati Bater ,bashkia Mat"

Emertimi: Profili terthor
"Imperium Construction", shpk
 Adresa: njesi Bashkiake nr.9 Rruga "Shyqyri Peza"
 Pallati 21, Hyrja 1,Kati 2 ,Tirane



Drejtues i projektit
 Adm. Arber TOLA

Projektues

Inxh. Elton LLAPUSHI	Mek. Bujar MERAJ
Inxh. Ilir Hodaj	Elek. Altin ALLKAJ
Ark. Rigert HYRA	Top. Iv BEQARI

SHKALLA	FLETA
1- 200	1 - 01
MAT 2022	Format A3

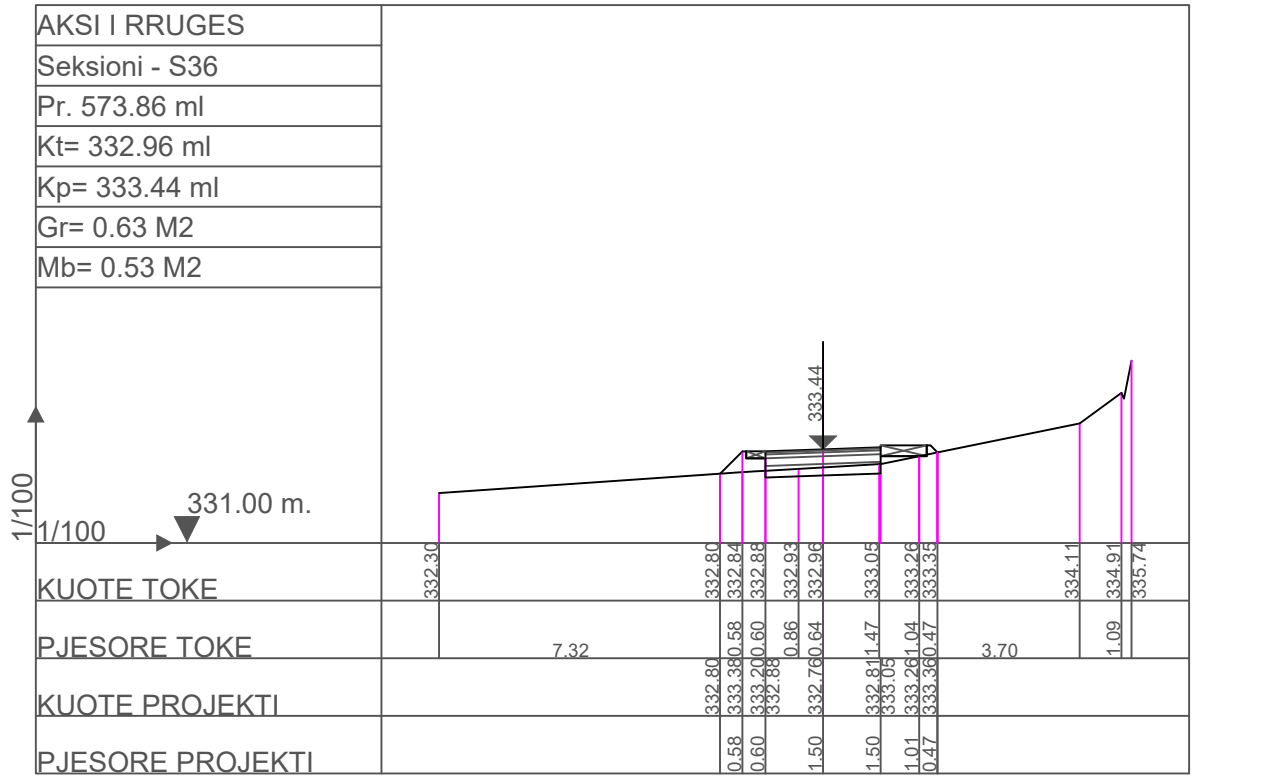
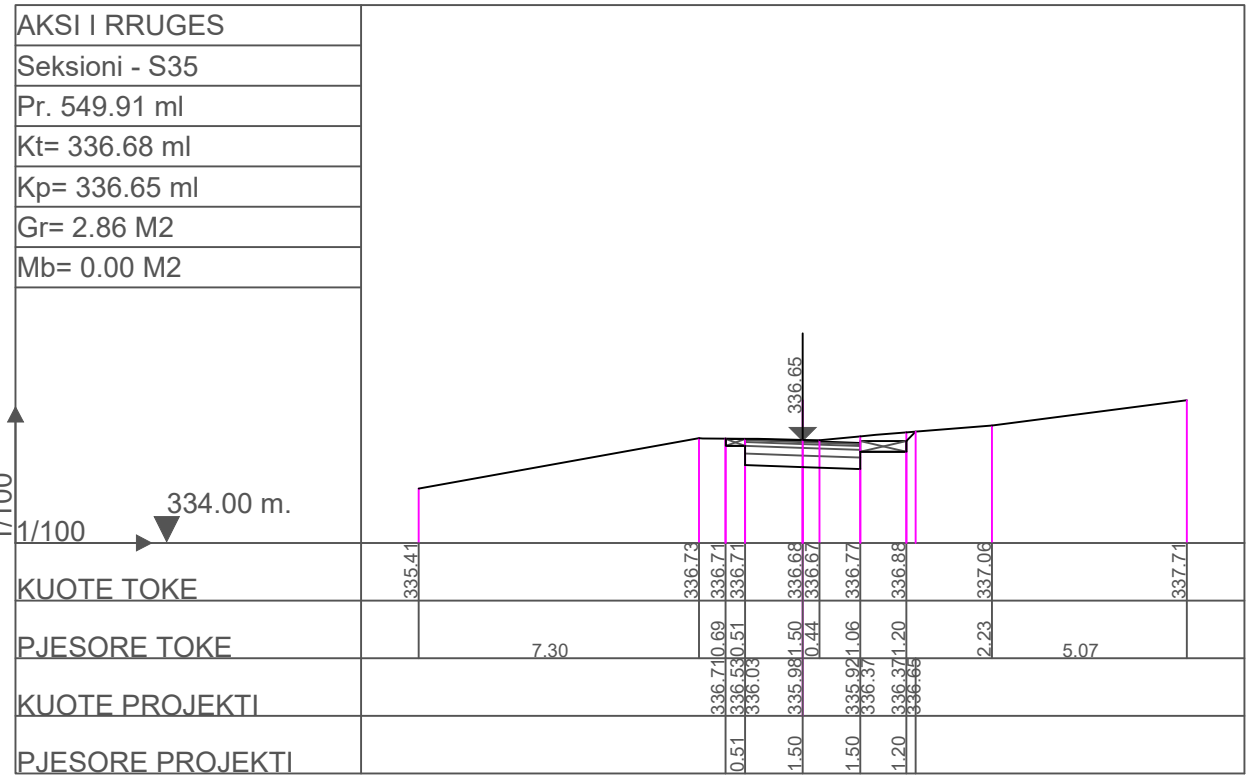
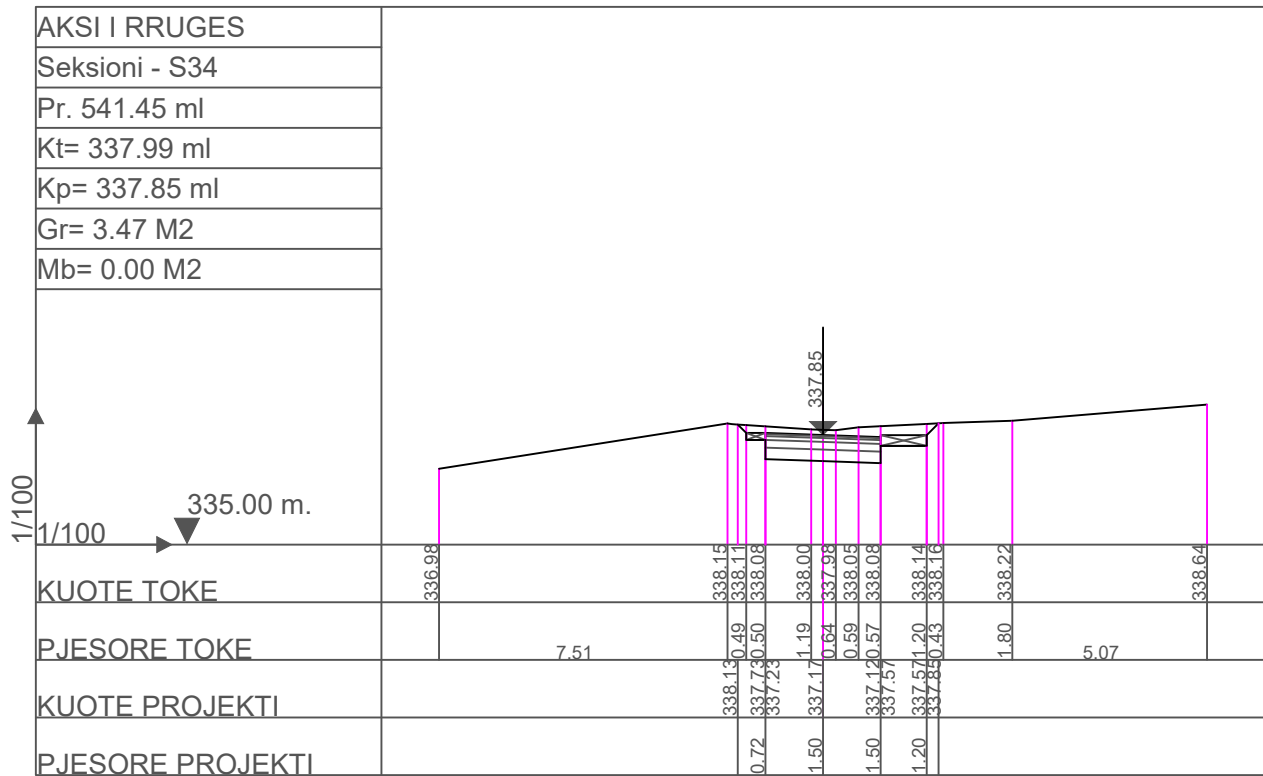
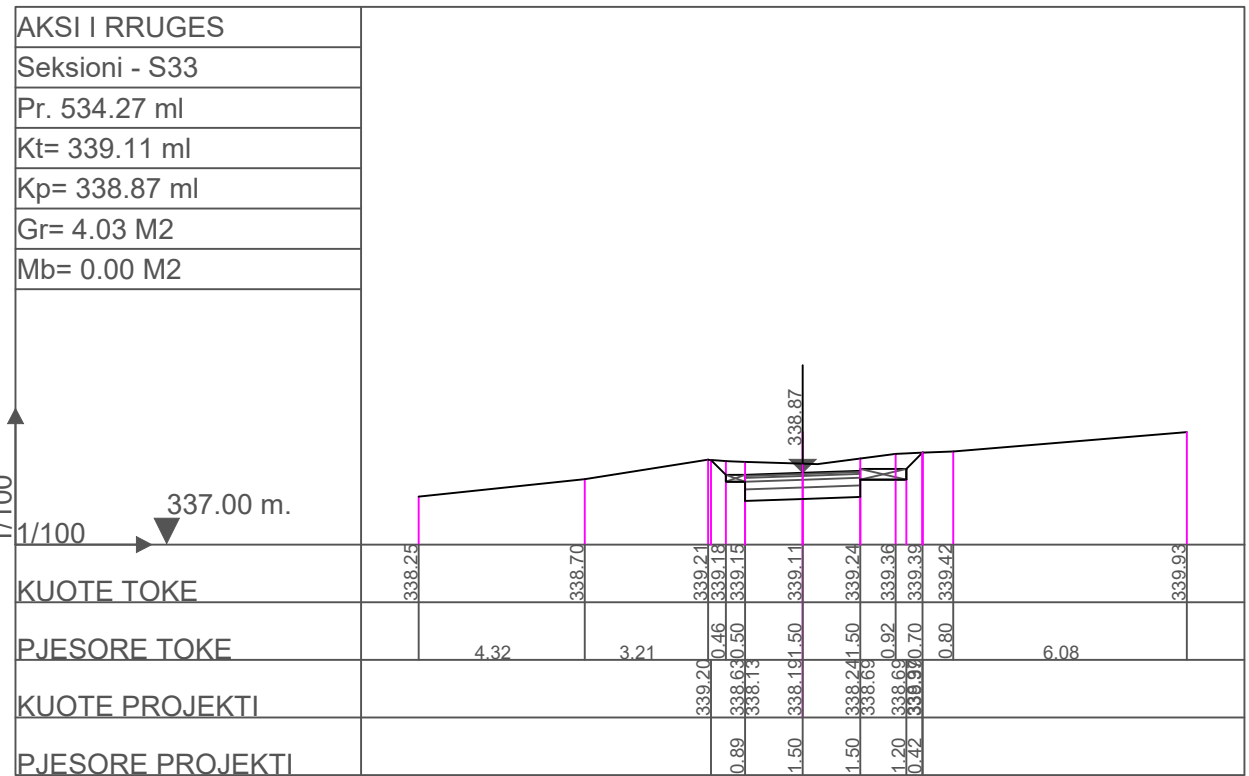

POROSITESI : BASHKIA MAT
 OBJEKTI: "Ndertimi i rruges fshati Bater ,bashkia Mat"

Emertimi: Profili terthor
"Imperium Construction", shpk
 Adresa: njesi Bashkiake nr.9 Rruga "Shyqyri Peza"
 Pallati 21, Hyrja 1,Kati 2 ,Tirane

Drejtes i projektit
 Adm. Arber TOLA

Projektues
 Inxh. Elton LLAPUSHI
 Inxh. Ilir Hodaj
 Ark. Rigert HYRA
 Mek. Bujar MERAJ
 Elek. Altin ALLKAJ
 Top. Iv BEQARI

SHKALLA	FLETA
1- 200	1 - 01
MAT 2022	Format A3

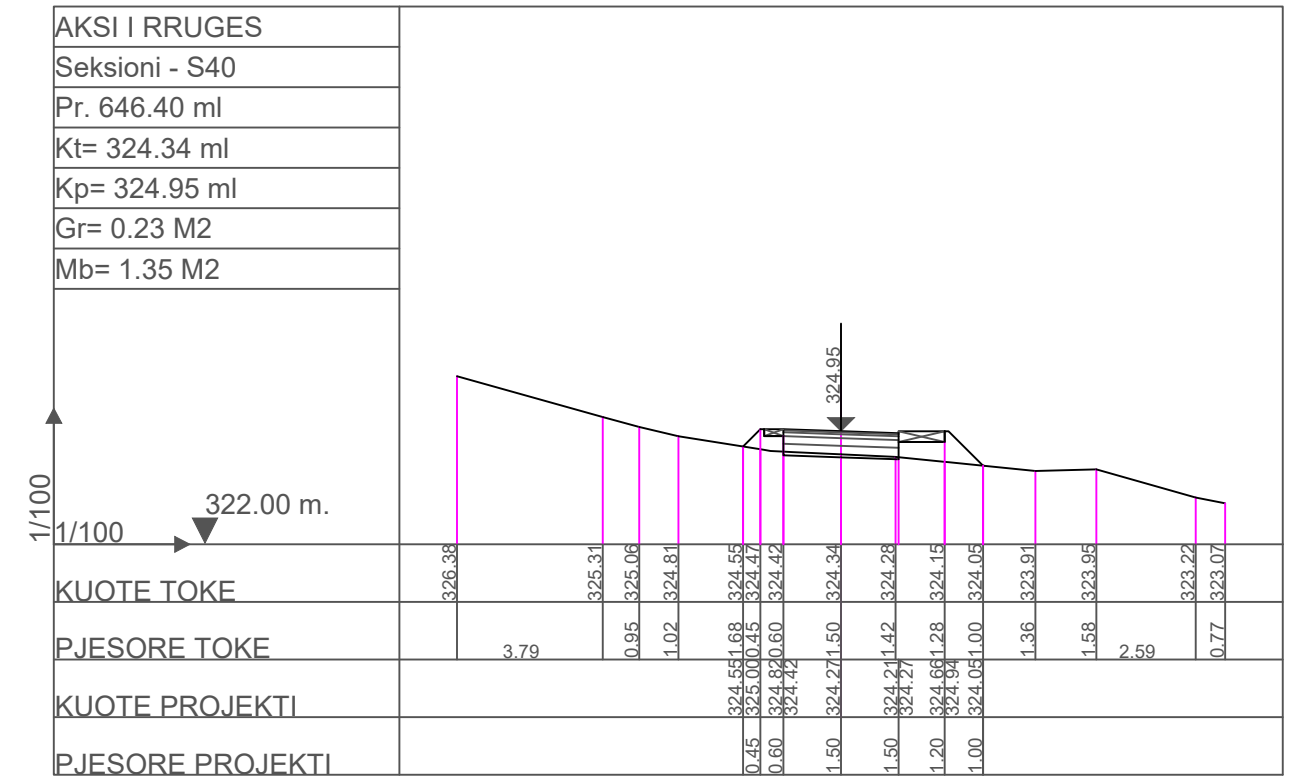
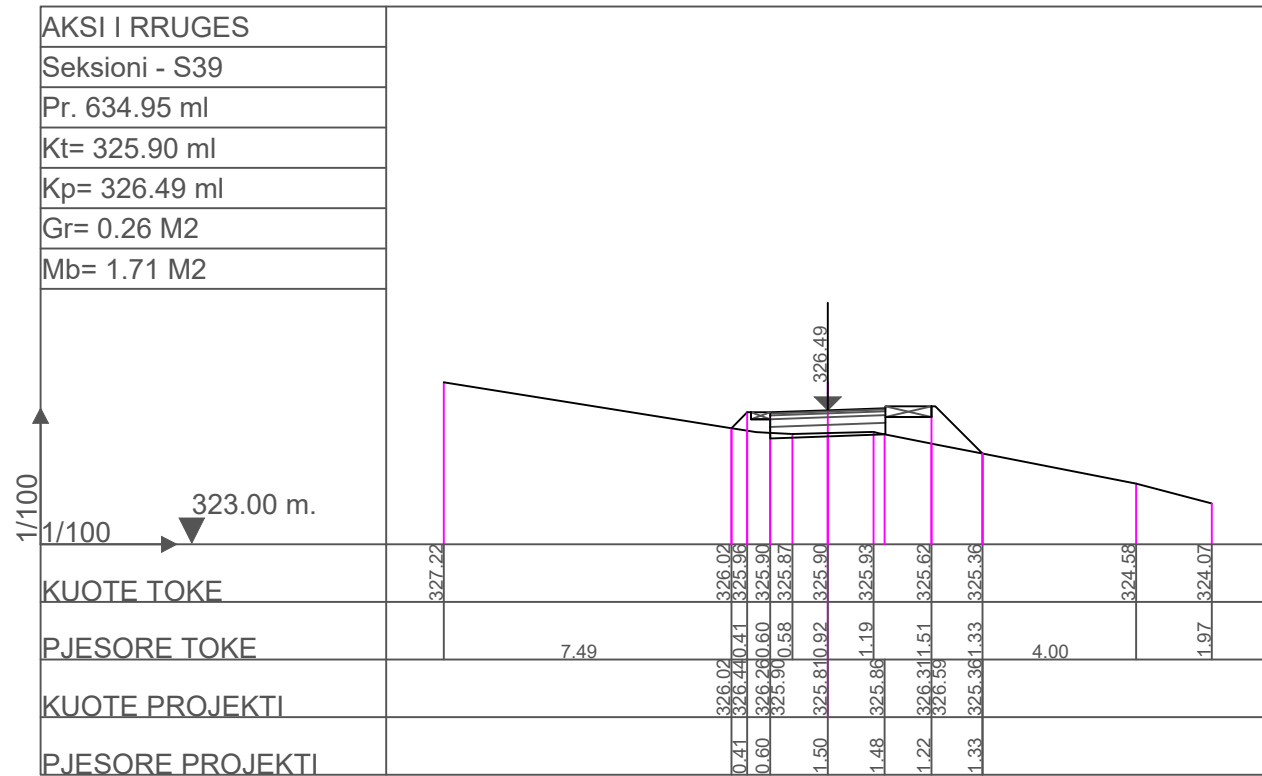
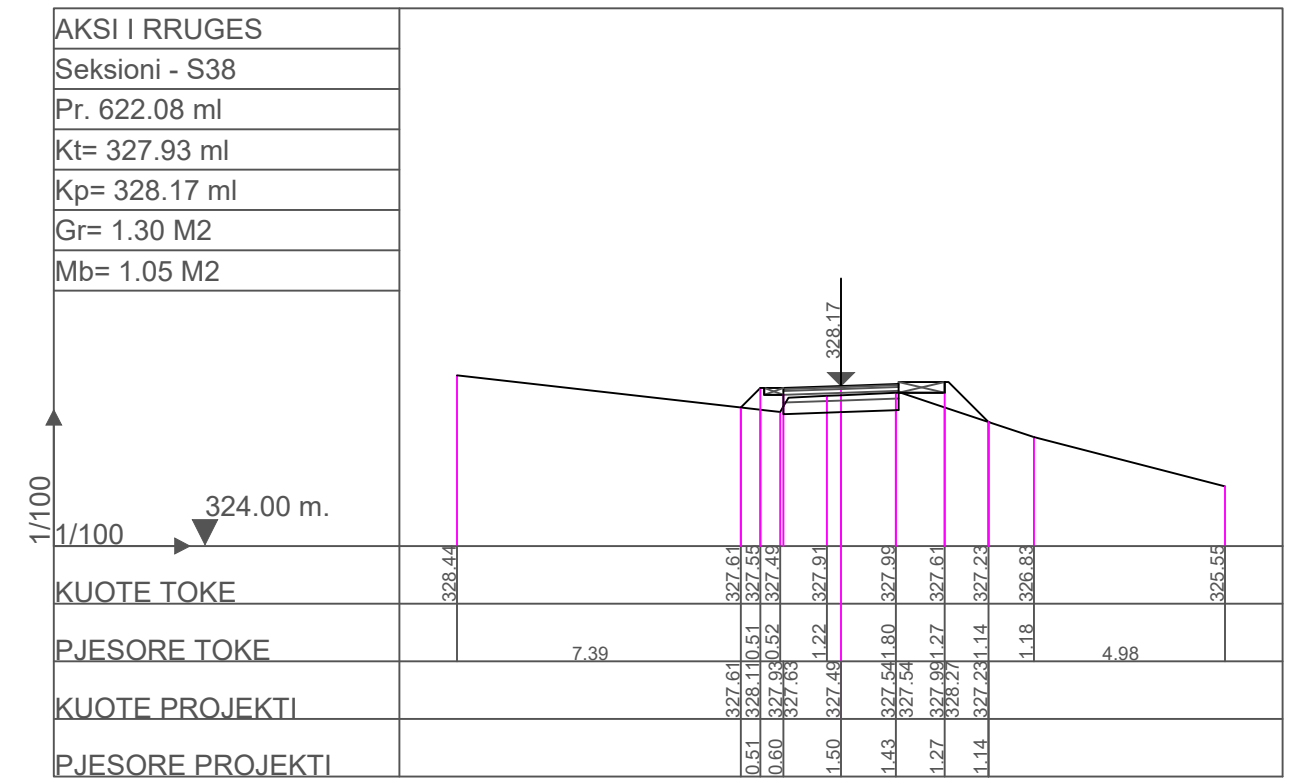
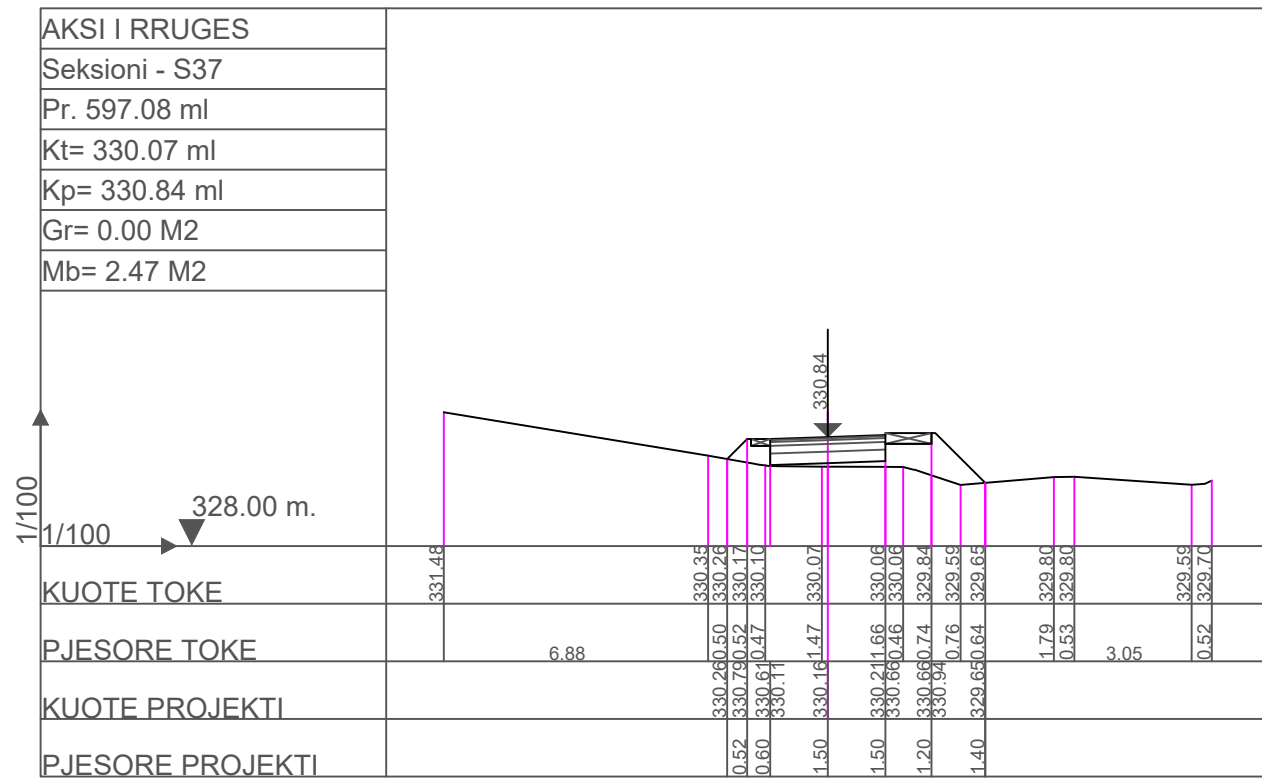

POROSITESI : BASHKIA MAT
 OBJEKTI: "Ndertimi i rruges fshati Bater ,bashkia Mat"

Emertimi: **Profili terthor**

"Imperium Construction", shpk
 Adresa: njesi Bashkiake nr.9 Rruga "Shyqyri Peza"
 Pallati 21, Hyrja 1,Kati 2 ,Tirane

Drejtesues i projektit
 Adm. Arber TOLA

Projektues

Inxh. Elton LLAPUSHI	Mek. Bujar MERAJ
Inxh. Ilir Hodaj	Elek. Altin ALLKAJ
Ark. Rigert HYRA	Top. Iv BEQARI

SHKALLA	FLETA
1- 200	1 - 01
MAT 2022	Format A3

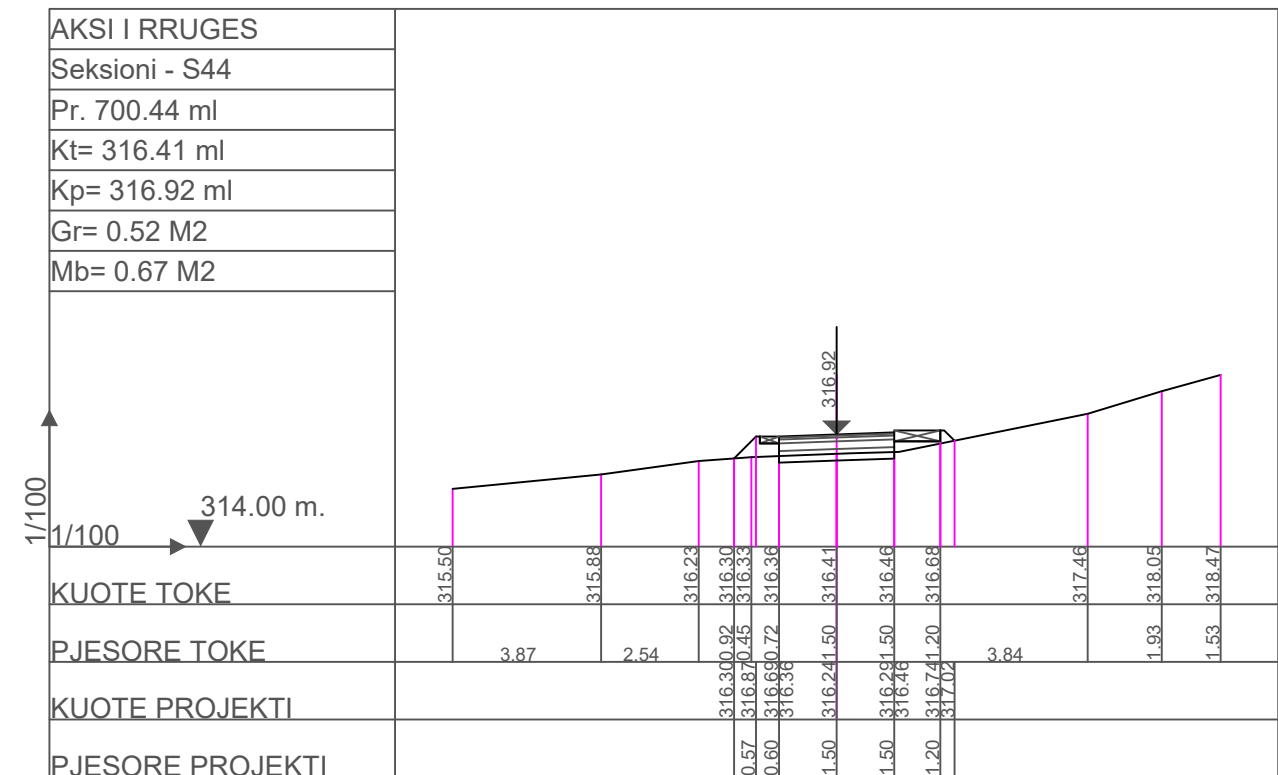
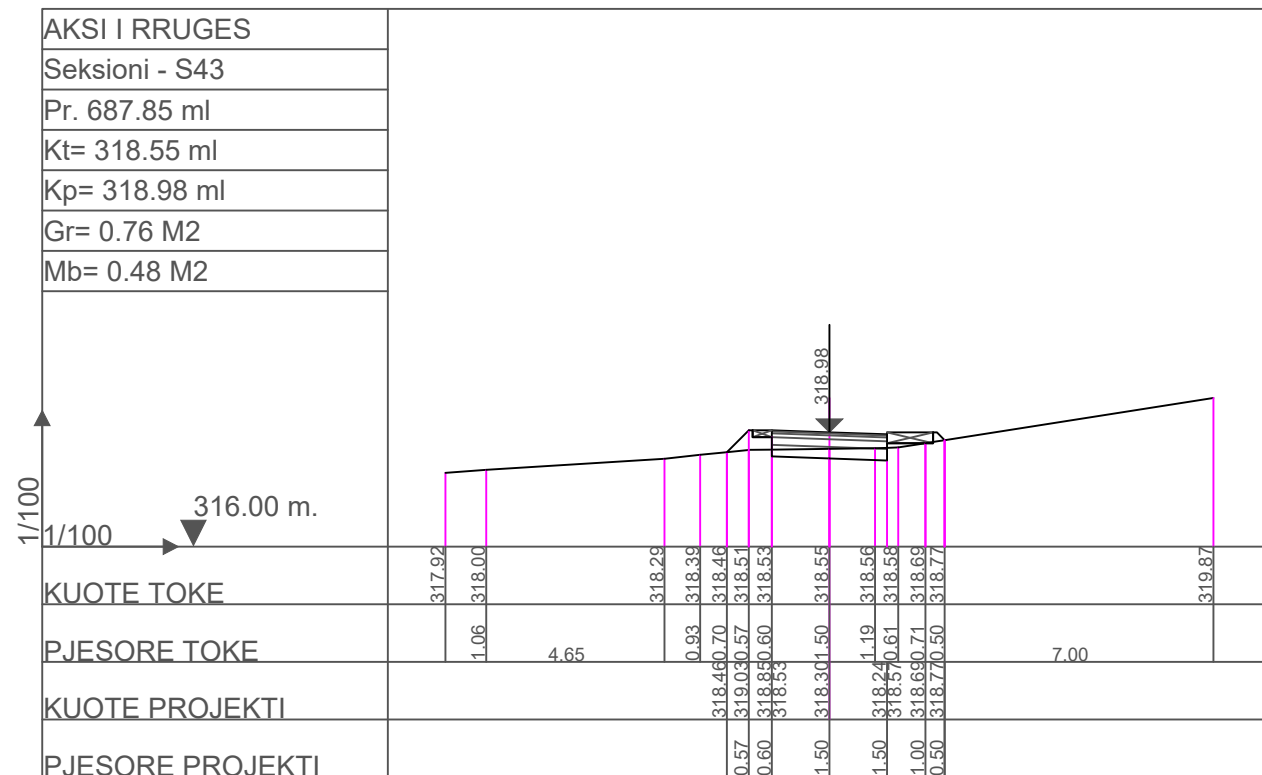
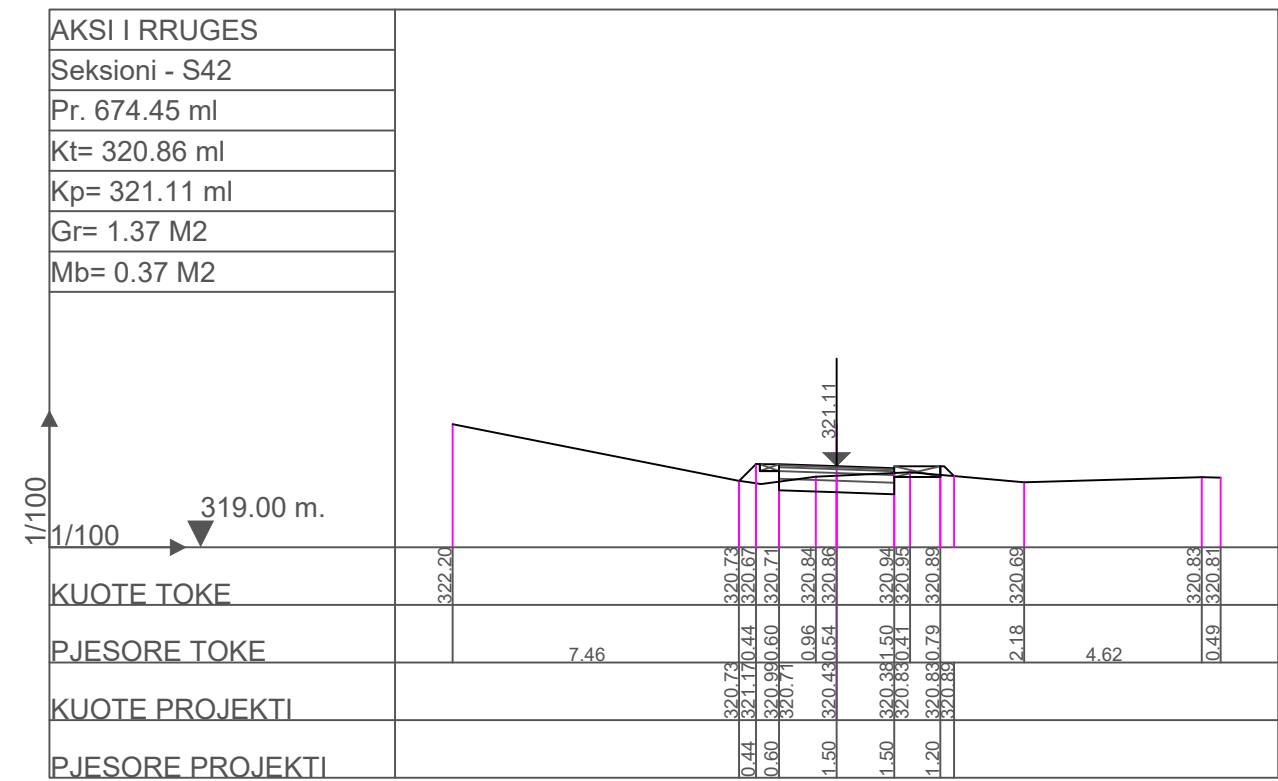
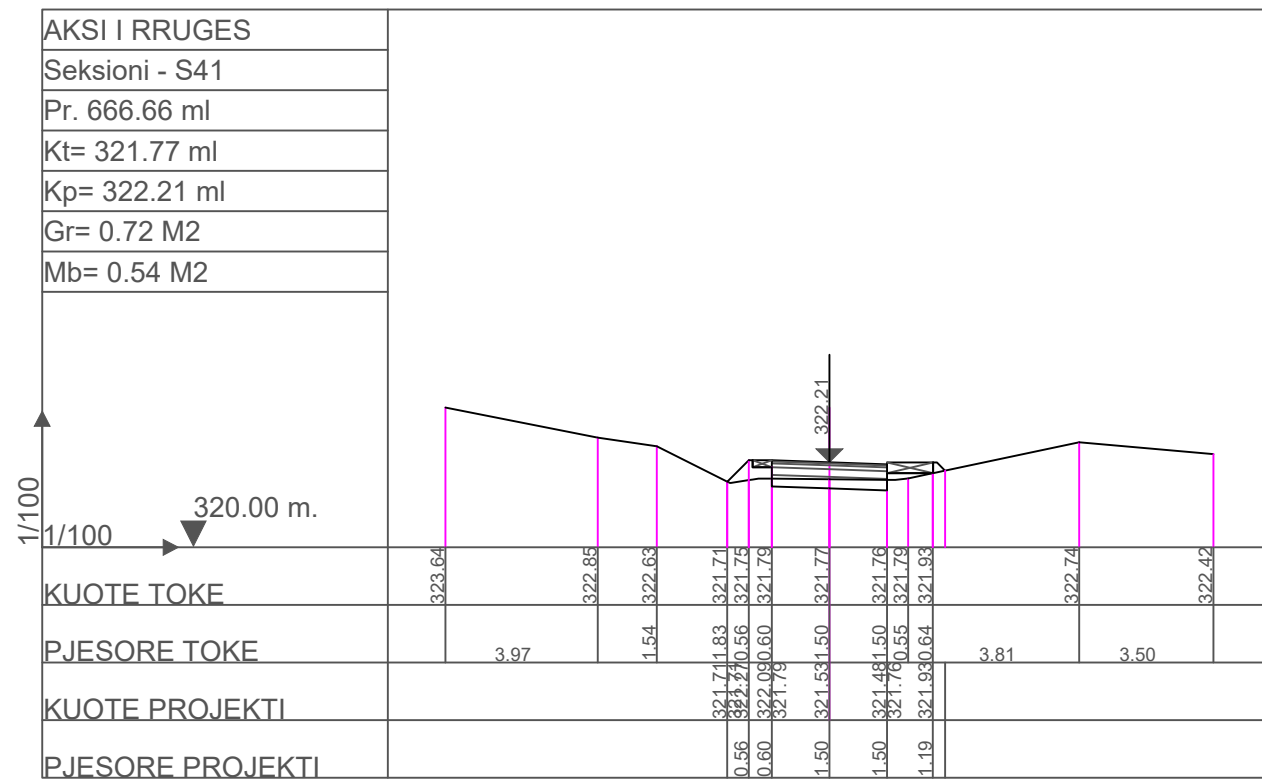

POROSITESI : BASHKIA MAT

OBJEKTI: "Ndertimi i rruges fshati Bater ,bashkia Mat"

Emertimi: Profili terthor



"Imperium Construction", shpk
Adresa: njesi Bashkiake nr.9 Rruga "Shyqyri Peza"
Pallati 21, Hyrja 1,Kati 2 ,Tirane

Drejtes i projektit

Adm. Arber TOLA

Projektues

Inxh. Elton LLAPUSHI	Mek. Bujar MERAJ
Inxh. Ilir Hodaj	Elek. Altin ALLKAJ
Ark. Rigert HYRA	Top. Iv BEQARI

SHKALLA

1- 200

MAT 2022

FLETA

1 - 01

Format A3

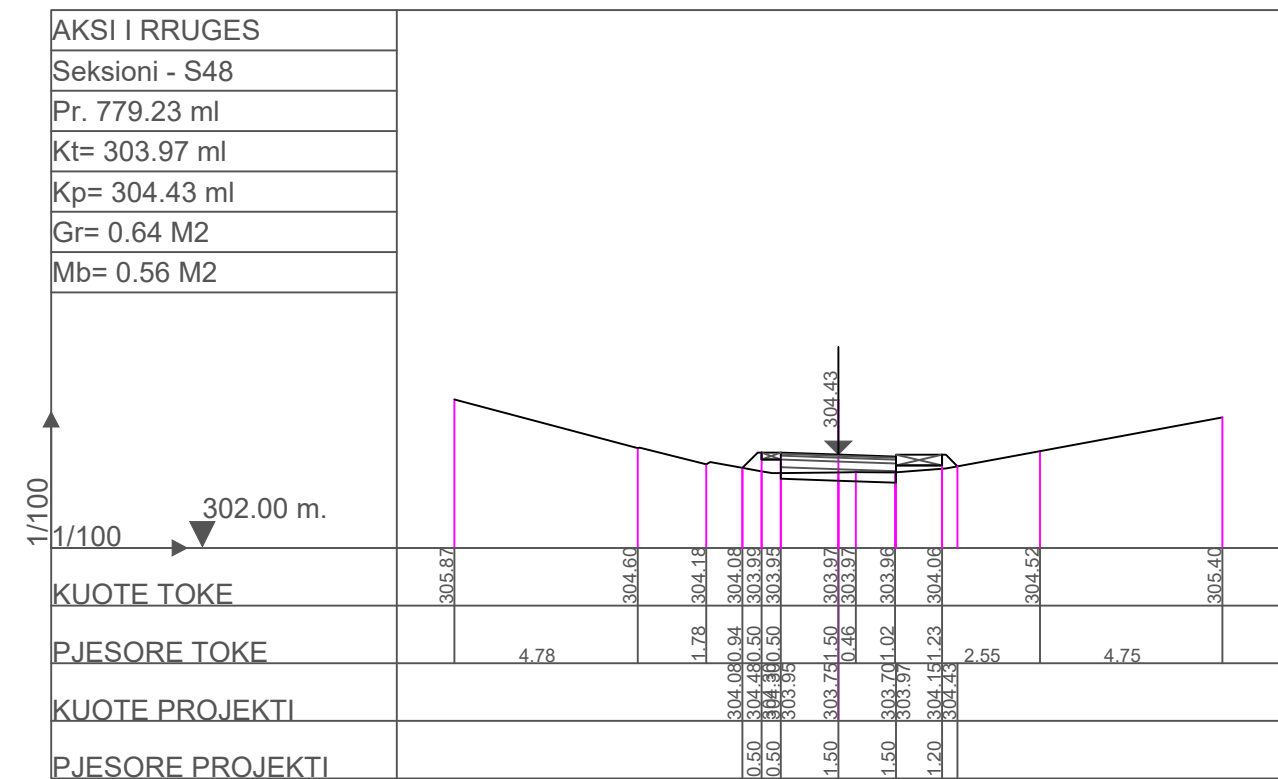
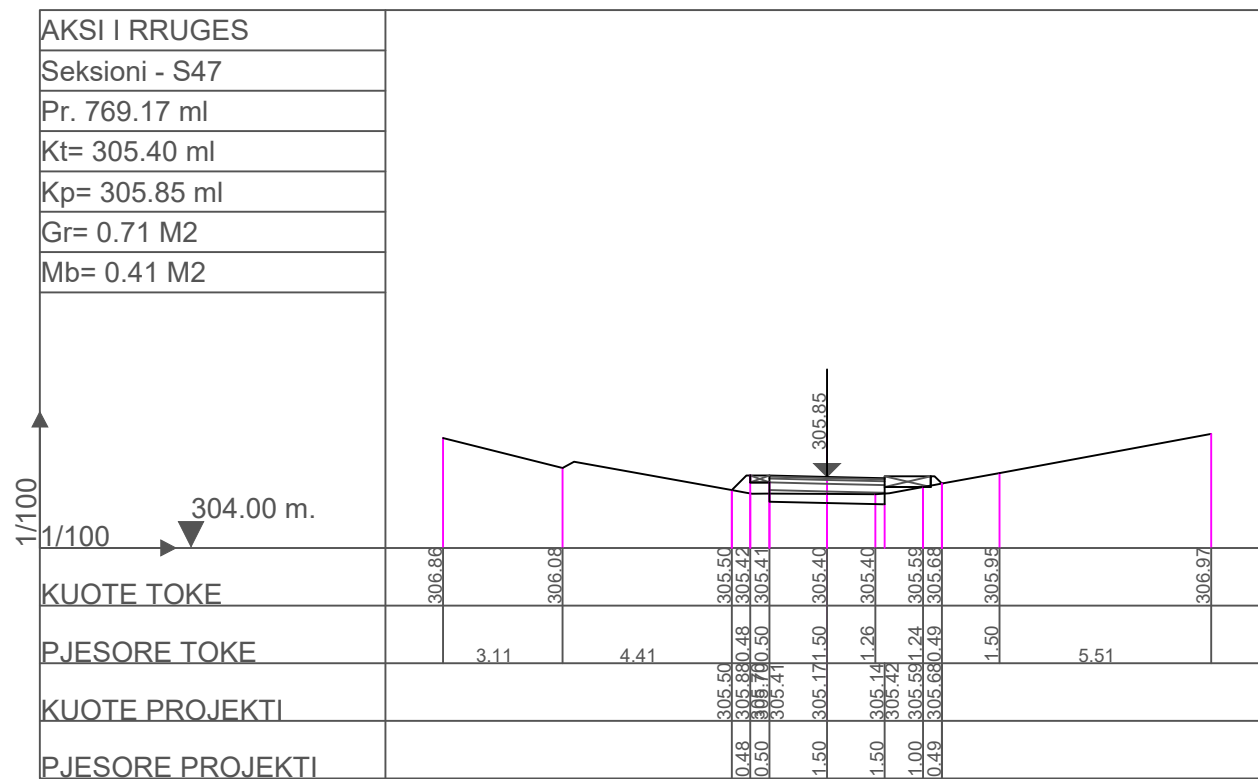
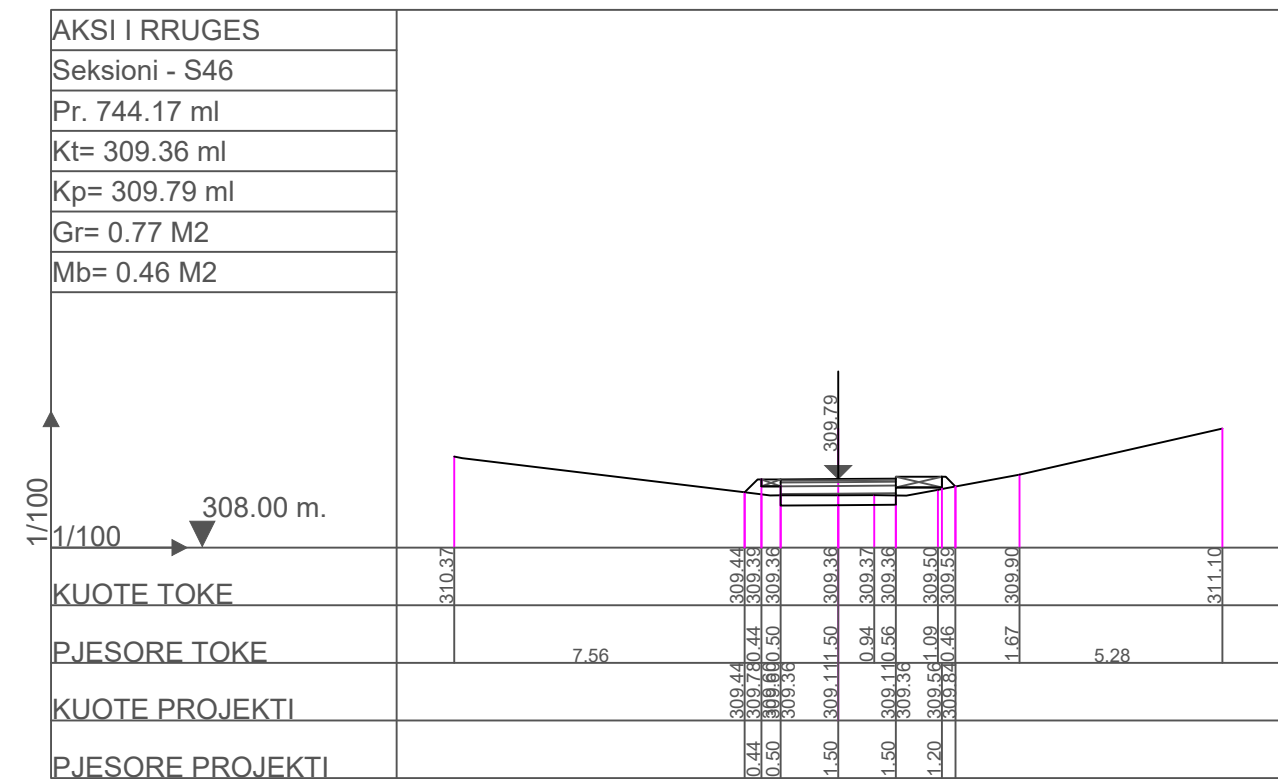
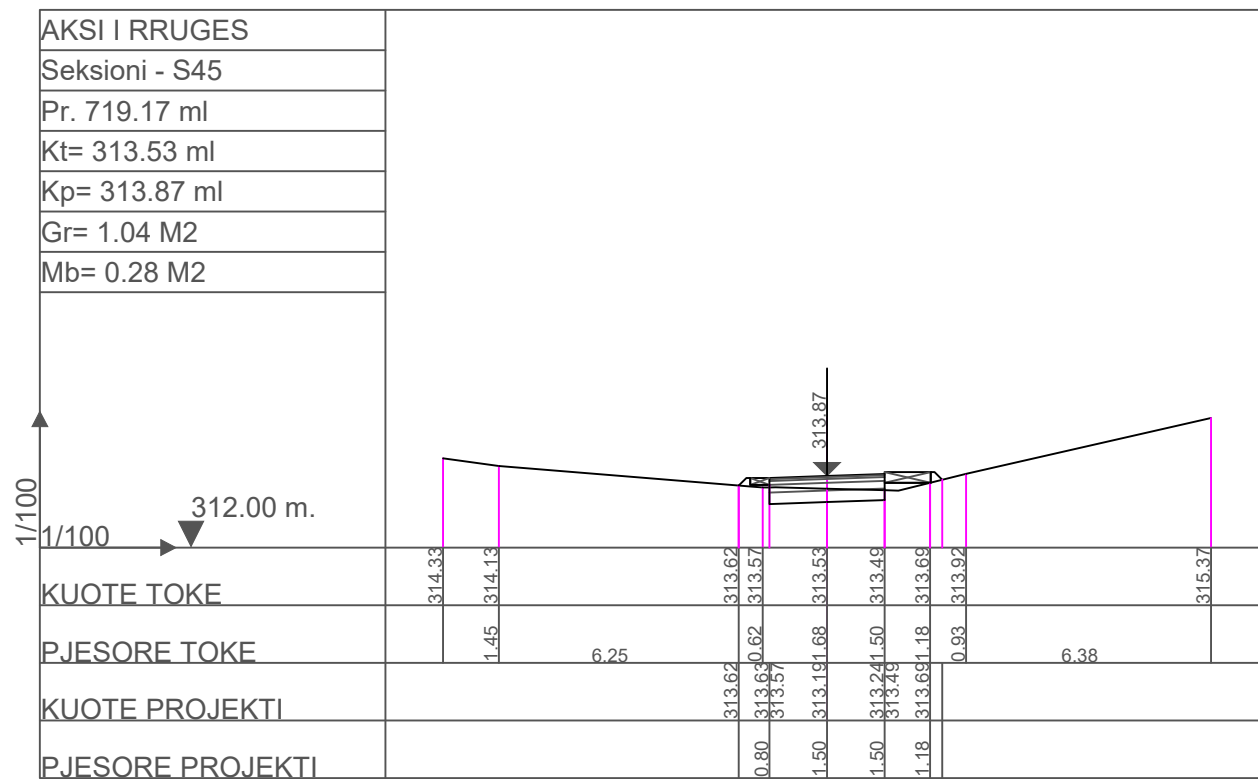

POROSITESI : BASHKIA MAT
 OBJEKTI: "Ndertimi i rruges fshati Bater ,bashkia Mat"

Emertimi: Profili terthor
"Imperium Construction", shpk
 Adresa: njesi Bashkiake nr.9 Rruga "Shyqyri Peza"
 Pallati 21, Hyrja 1,Kati 2 ,Tirane



Drejtues i projektit
 Adm. Arber TOLA

Projektues

Inxh. Elton LLAPUSHI	Mek. Bujar MERAJ
Inxh. Ilir Hodaj	Elek. Altin ALLKAJ
Ark. Rigert HYRA	Top. Iv BEQARI

SHKALLA	FLETA
1- 200	1 - 01
MAT 2022	Format A3

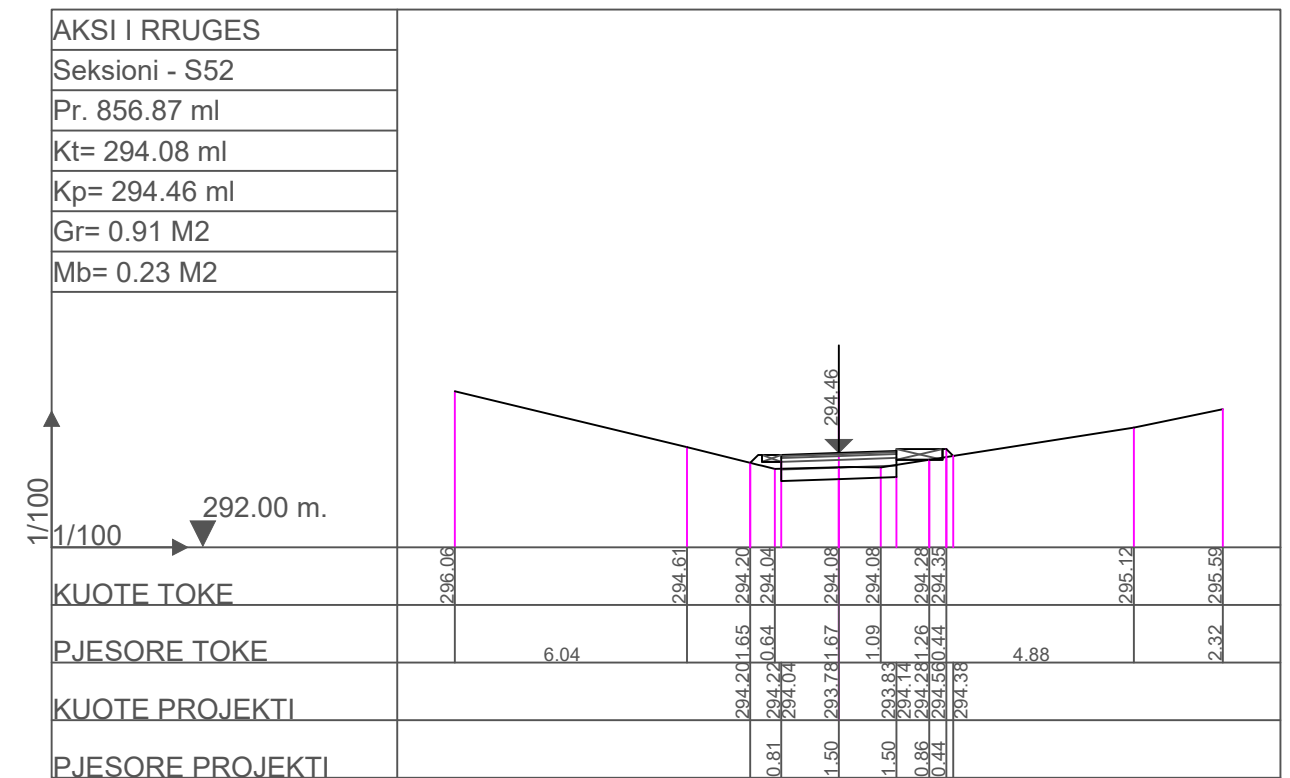
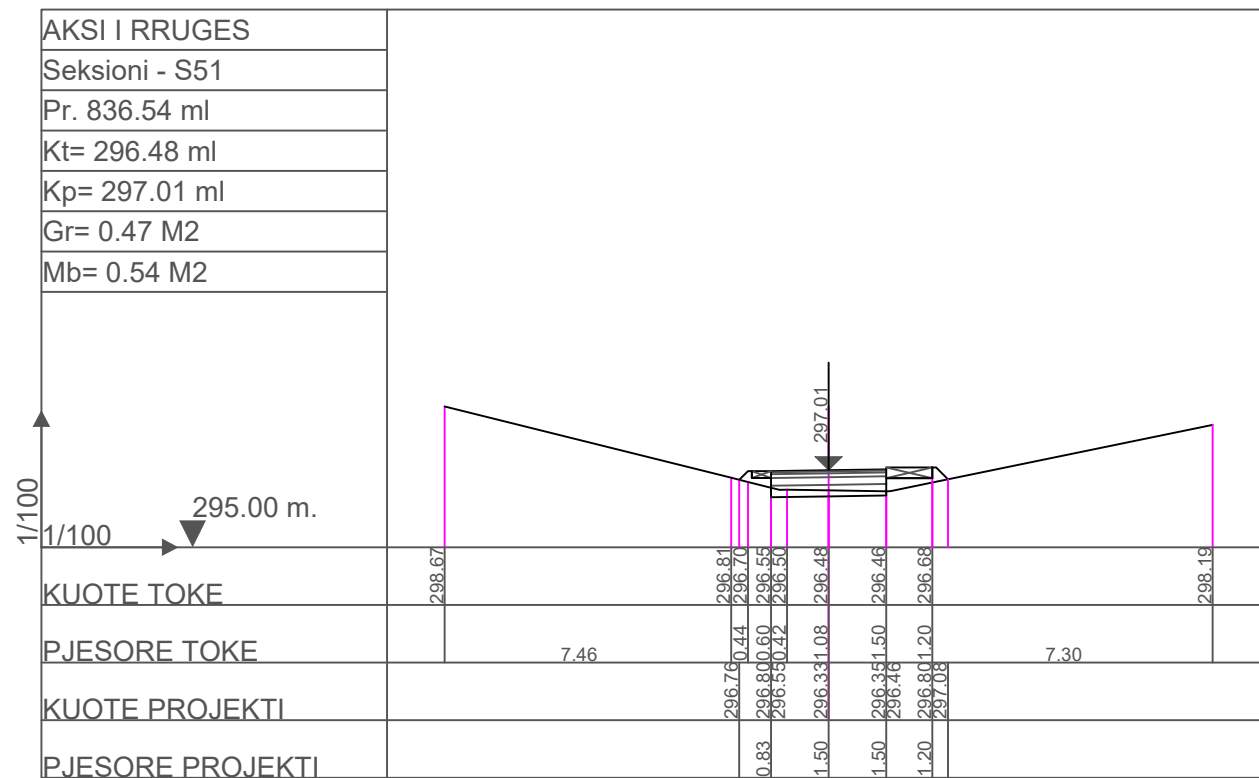
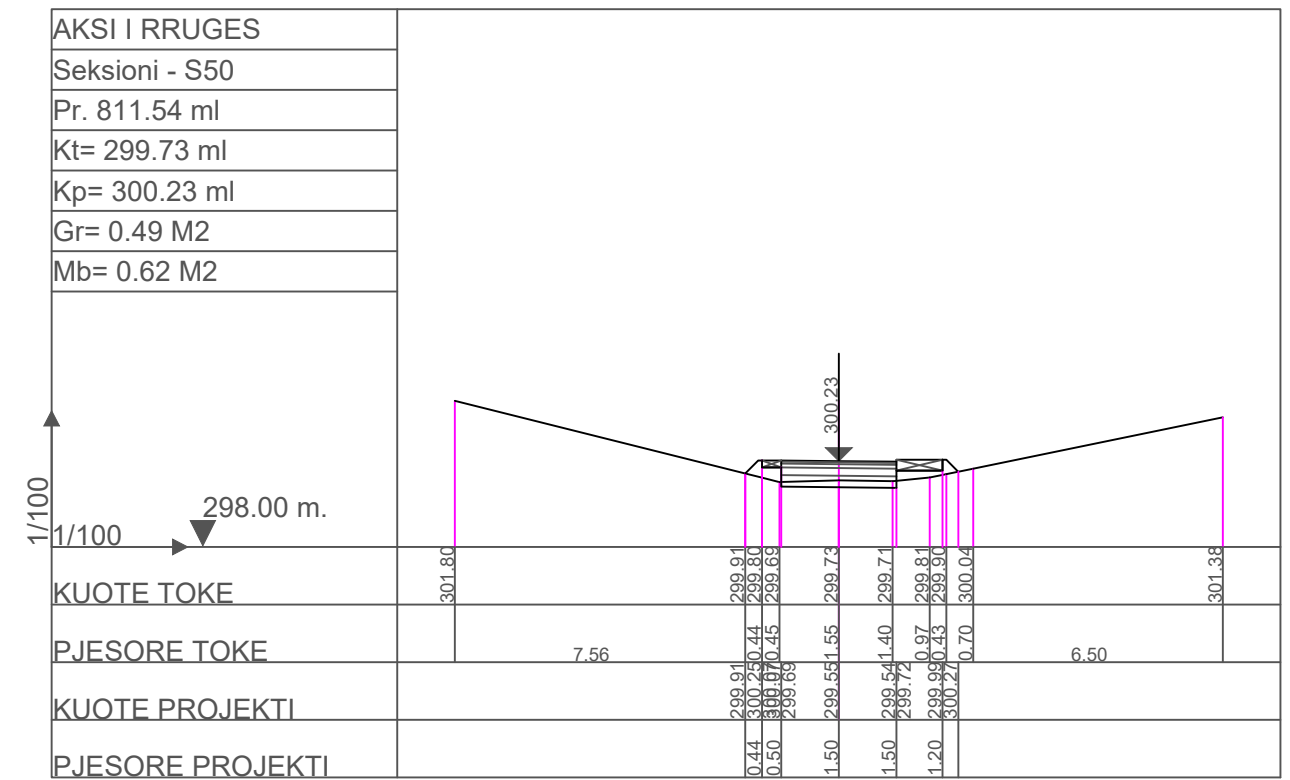
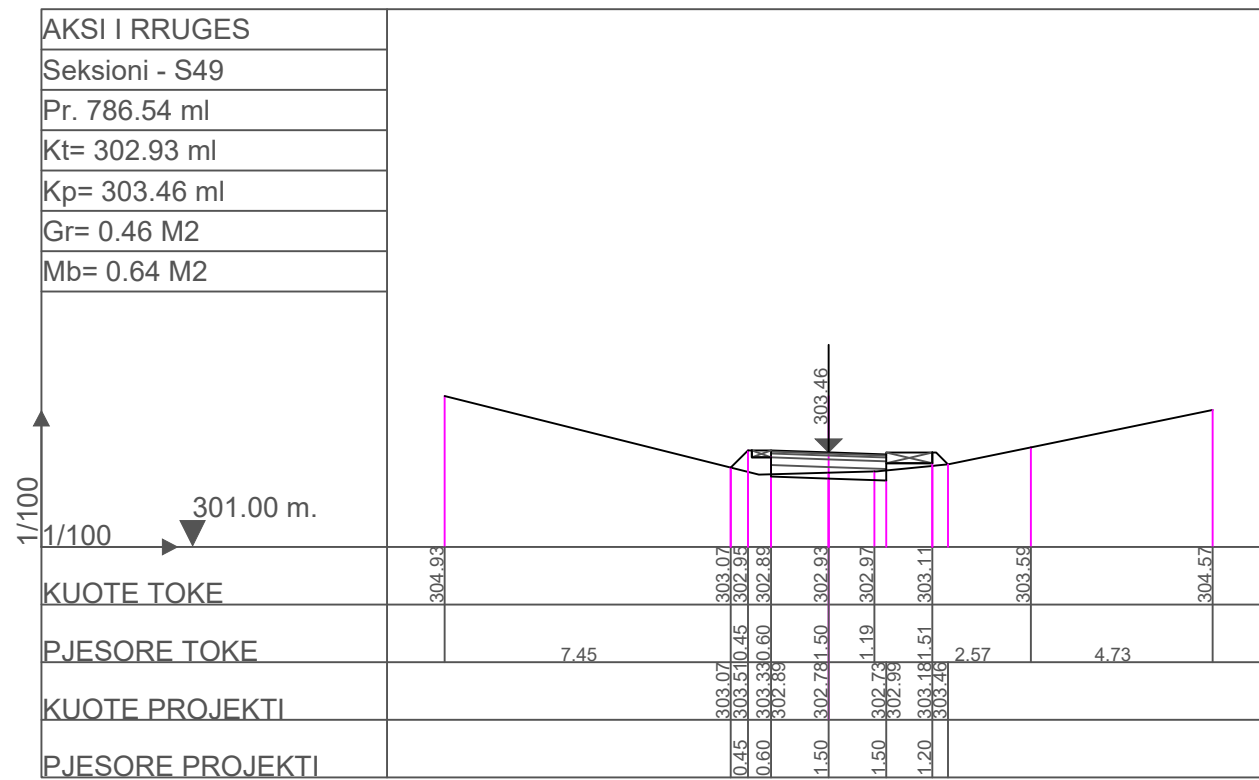

POROSITESI : BASHKIA MAT

OBJEKTI: "Ndertimi i rruges fshati Bater ,bashkia Mat"

Emertimi: Profili terthor



"Imperium Construction", shpk
 Adresa: njesi Bashkiake nr.9 Rruga "Shyqyri Peza"
 Pallati 21, Hyrja 1,Kati 2 ,Tirane

Drejtues i projektit

Adm. Arber TOLA

Projektues

Inxh. Elton LLAPUSHI	Mek. Bujar MERAJ
Inxh. Ilir Hodaj	Elek. Altin ALLKAJ
Ark. Rigert HYRA	Top. Iv BEQARI

SHKALLA

1- 200

MAT 2022

FLETA

1 - 01

Format A3

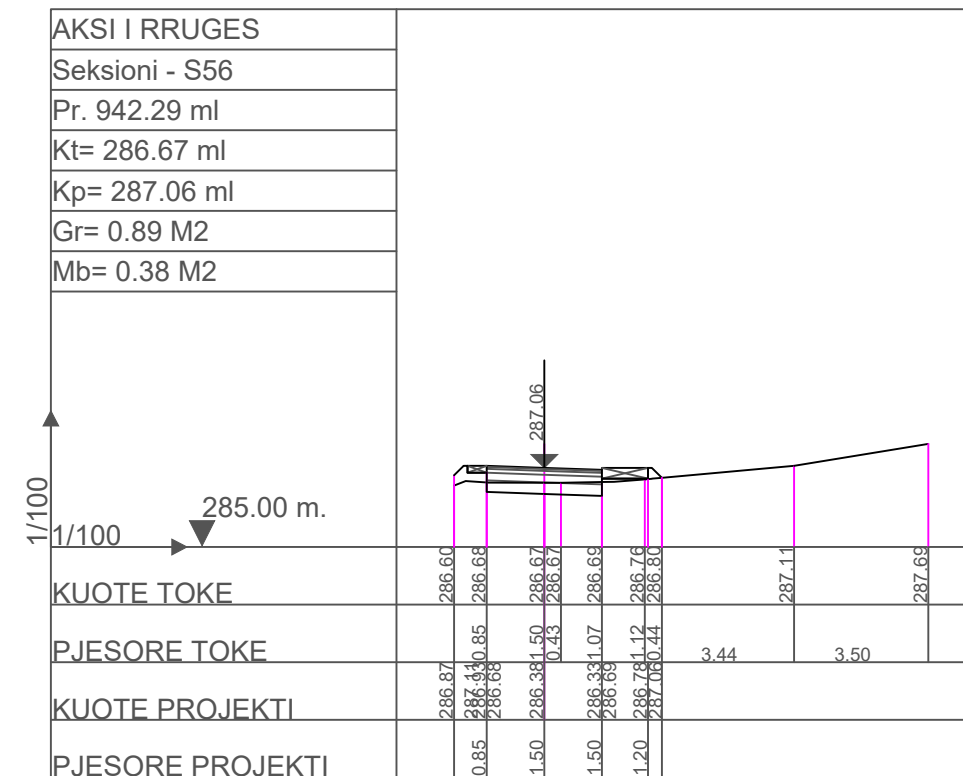
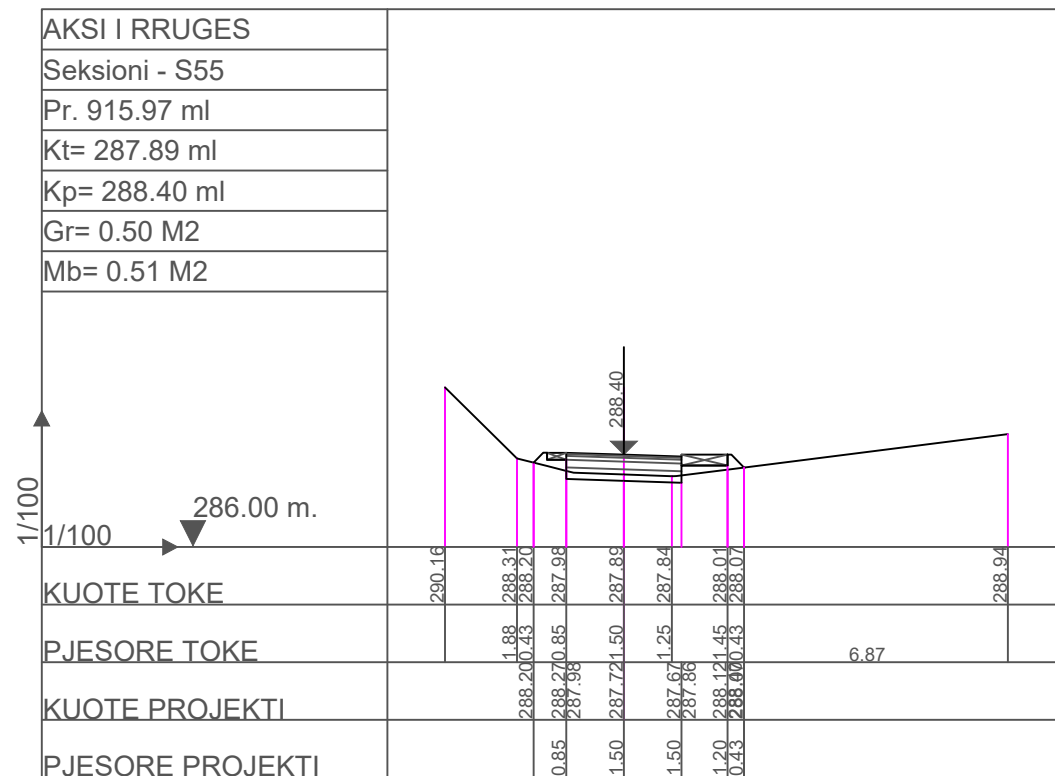
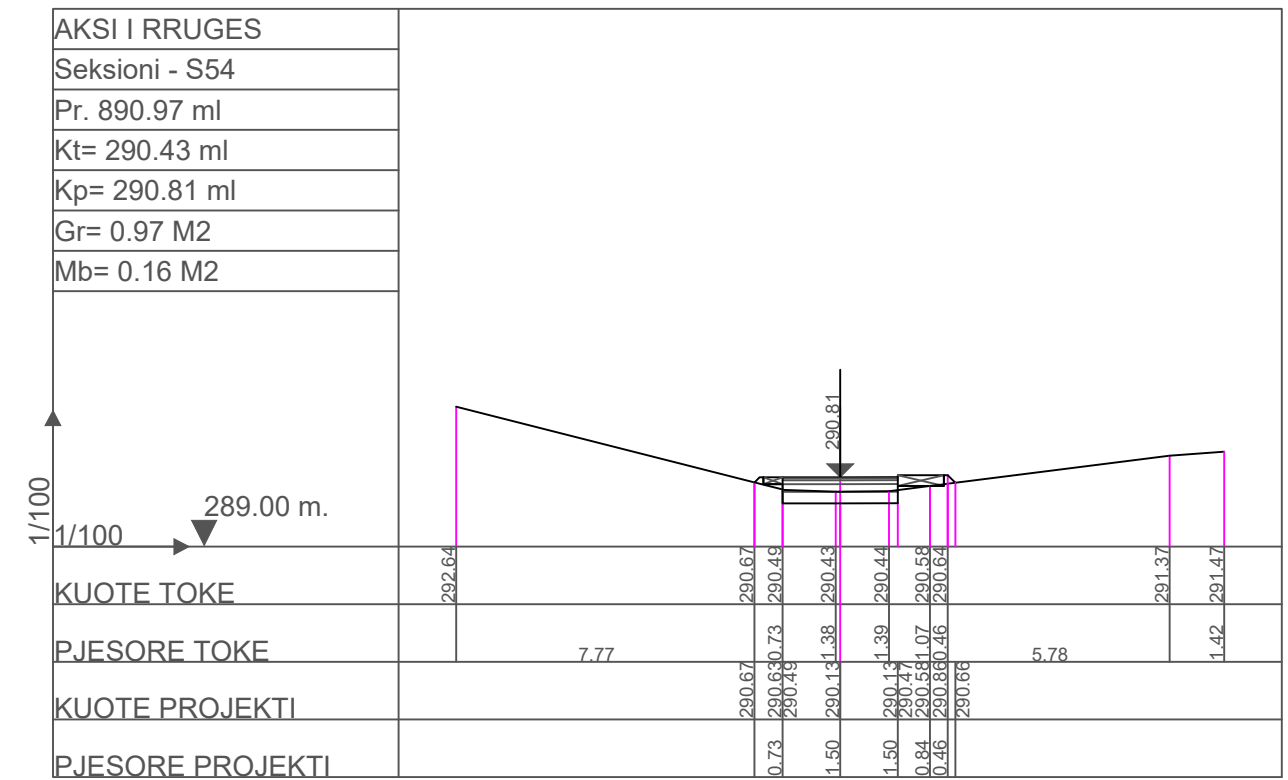
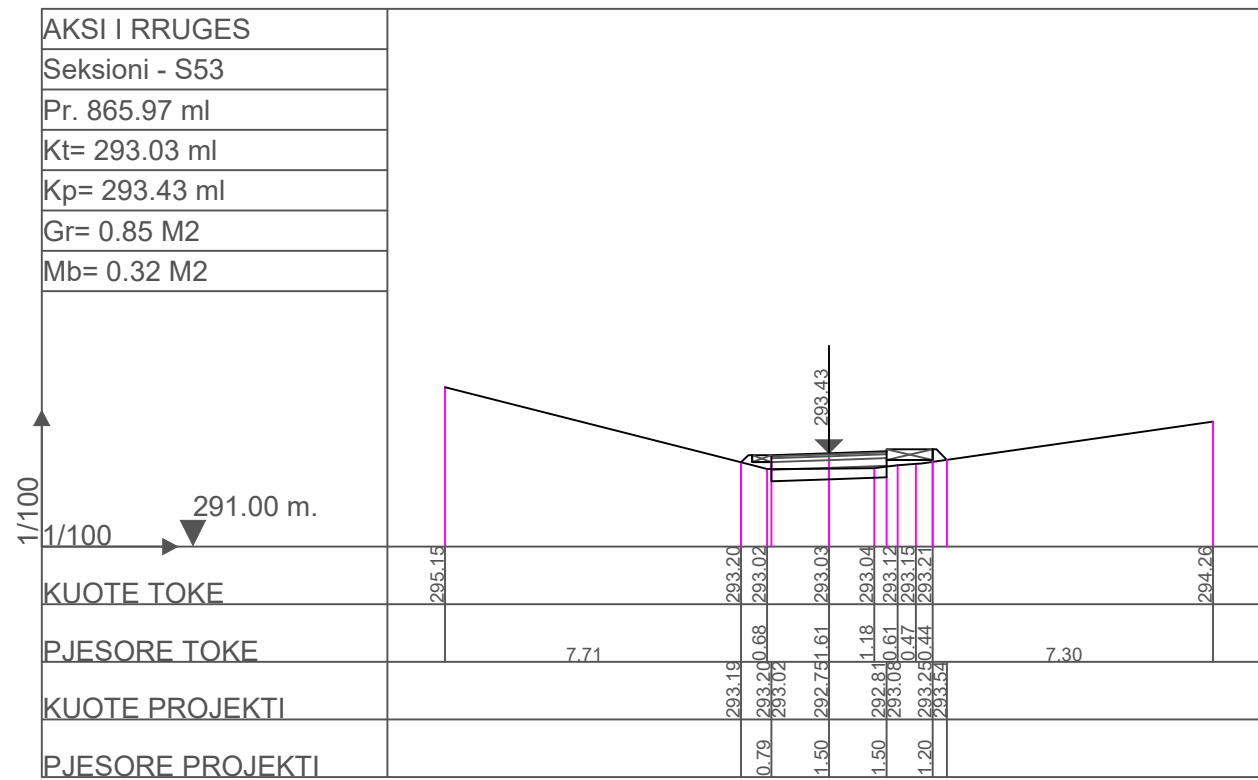

POROSITESI : BASHKIA MAT

OBJEKTI: "Ndertimi i rruges fshati Bater ,bashkia Mat"

Emertimi: Profili terthor



"Imperium Construction", shpk
 Adresa: njesi Bashkiake nr.9 Rruga "Shyqyri Peza"
 Pallati 21, Hyrja 1,Kati 2 ,Tirane

Drejtes i projektit

Adm. Arber TOLA

Projektues

Inxh. Elton LLAPUSHI
 Inxh. Ilir Hodaj
 Ark. Rigert HYRA

Mek. Bujar MERAJ
 Elek. Altin ALLKAJ
 Top. Iv BEQARI

SHKALLA

1- 200

MAT 2022

FLETA

1 - 01

Format A3

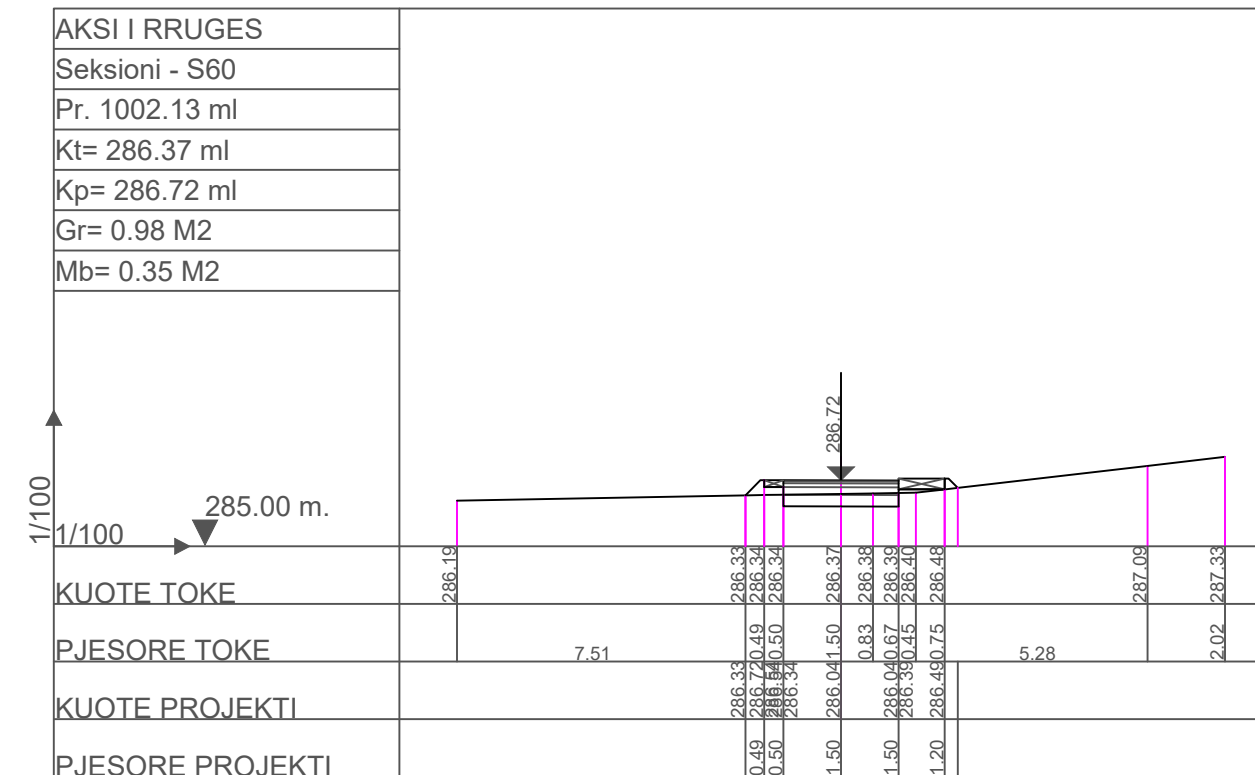
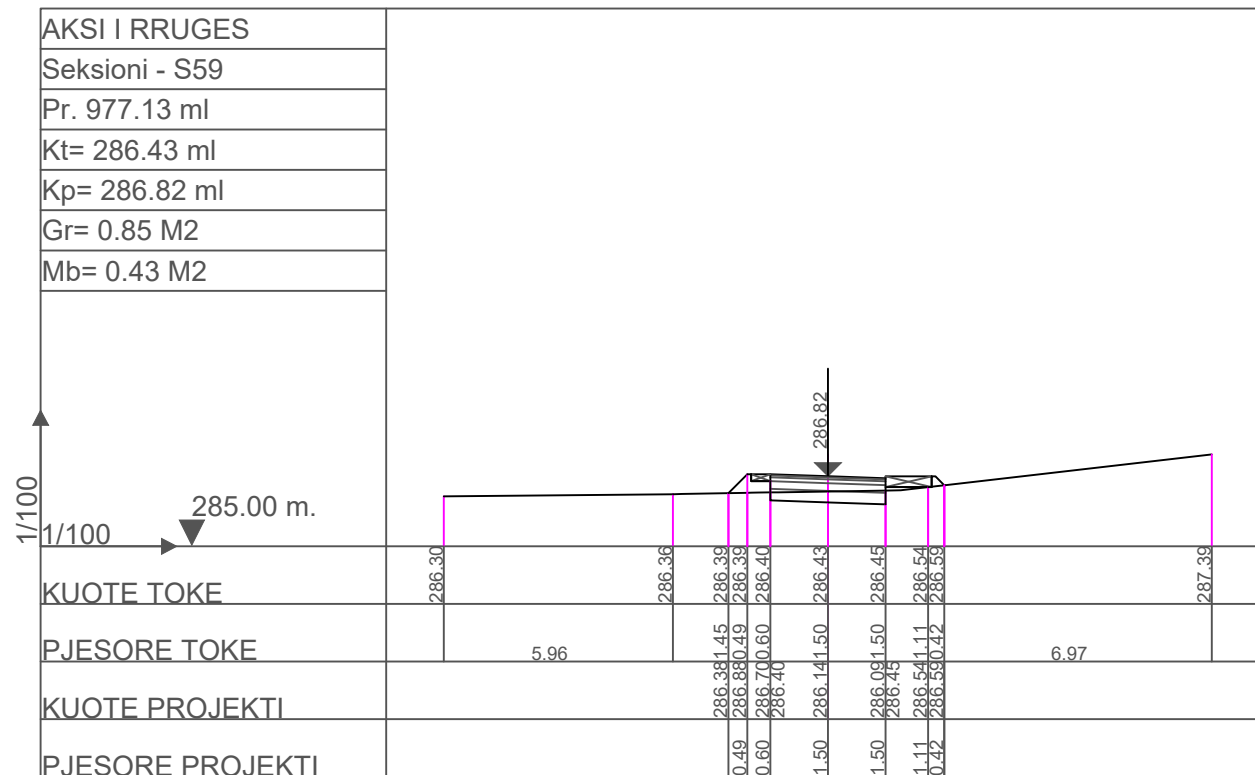
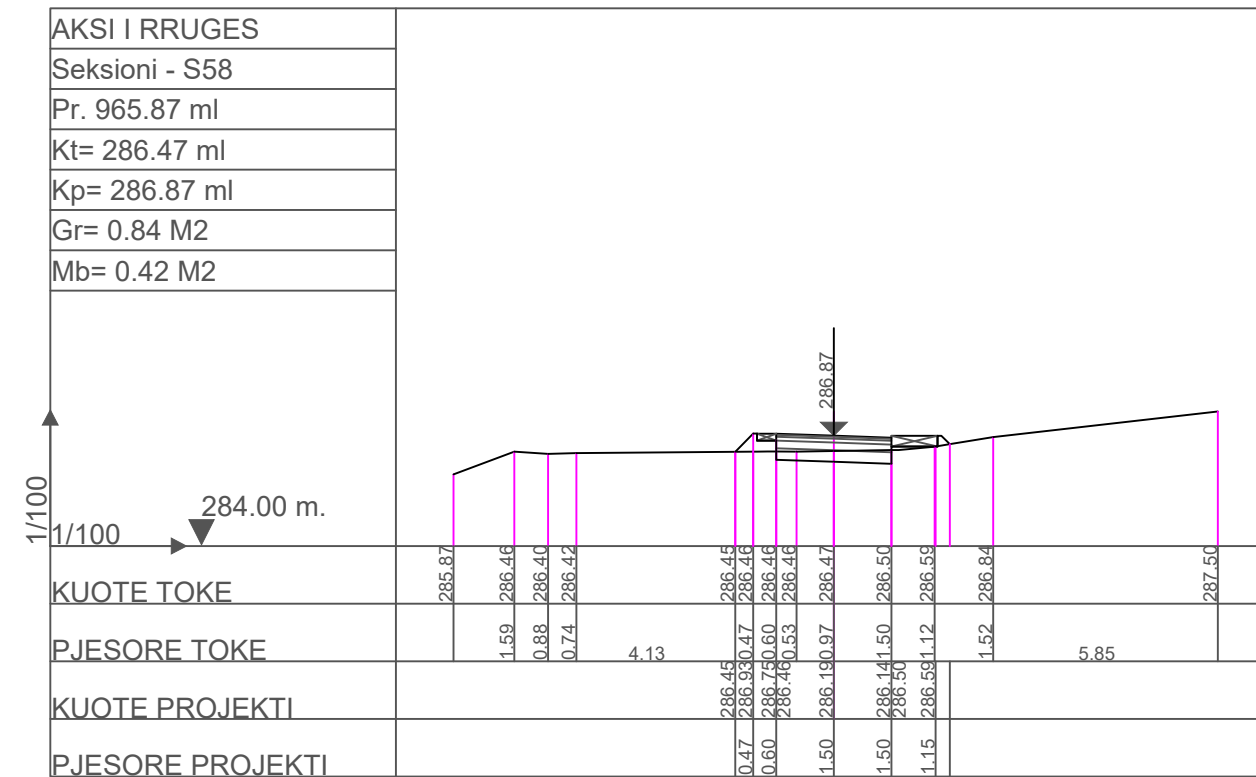
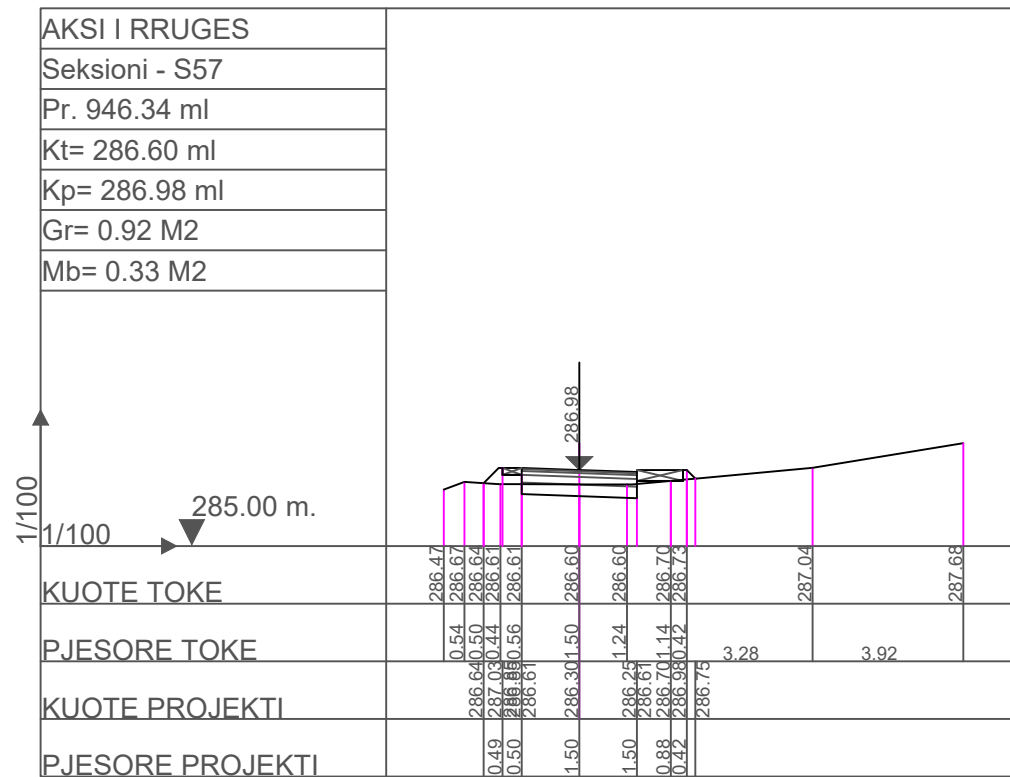

POROSITESI : BASHKIA MAT

OBJEKTI: "Ndertimi i rruges fshati Bater ,bashkia Mat"

Emertimi: Profili terthor



"Imperium Construction", shpk
Adresa: njesi Bashkiake nr.9 Rruga "Shyqyri Peza"
Pallati 21, Hyrja 1,Kati 2 ,Tirane

Drejtes i projektit

Adm. Arber TOLA

Projektues

Inxh. Elton LLAPUSHI
Inxh. Ilir Hodaj
Ark. Rigert HYRA

Mek. Bujar MERAJ
Elek. Altin ALLKAJ
Top. Iv BEQARI

SHKALLA

1- 200

MAT 2022

FLETA

1 - 01

Format A3

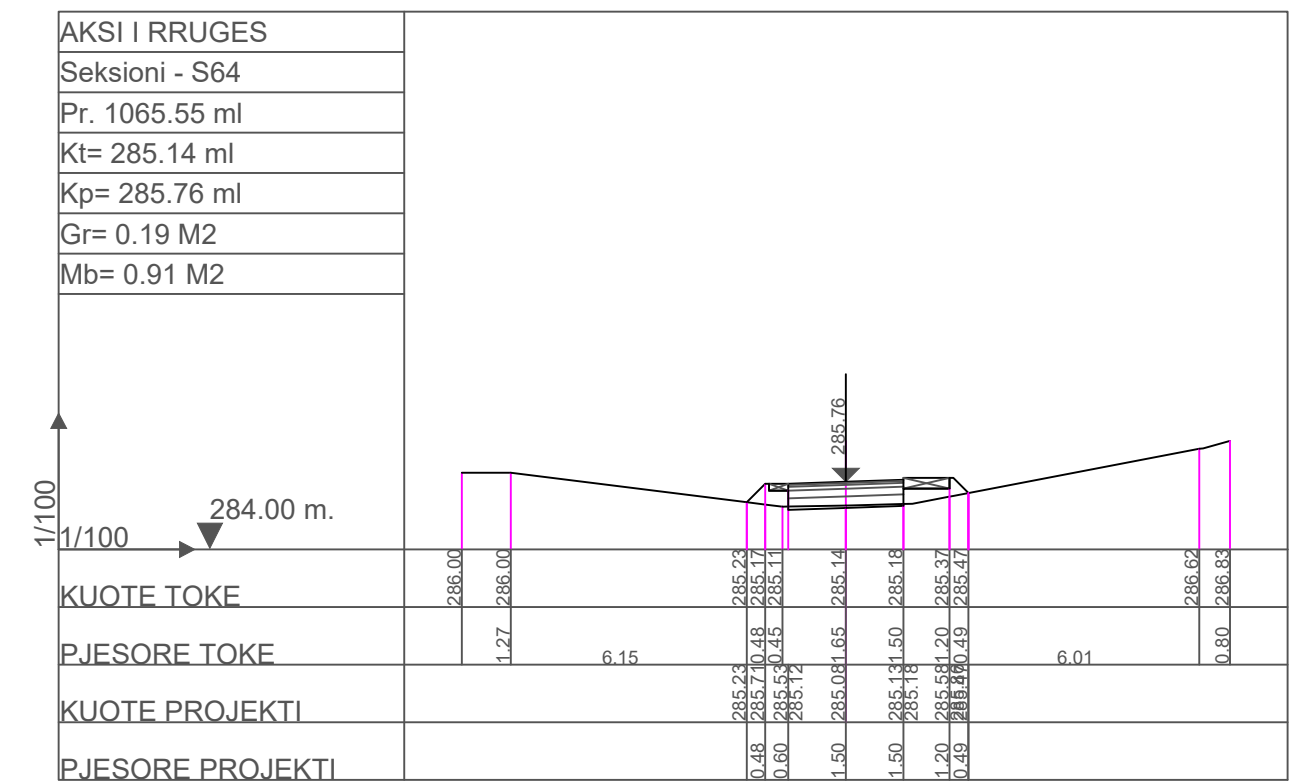
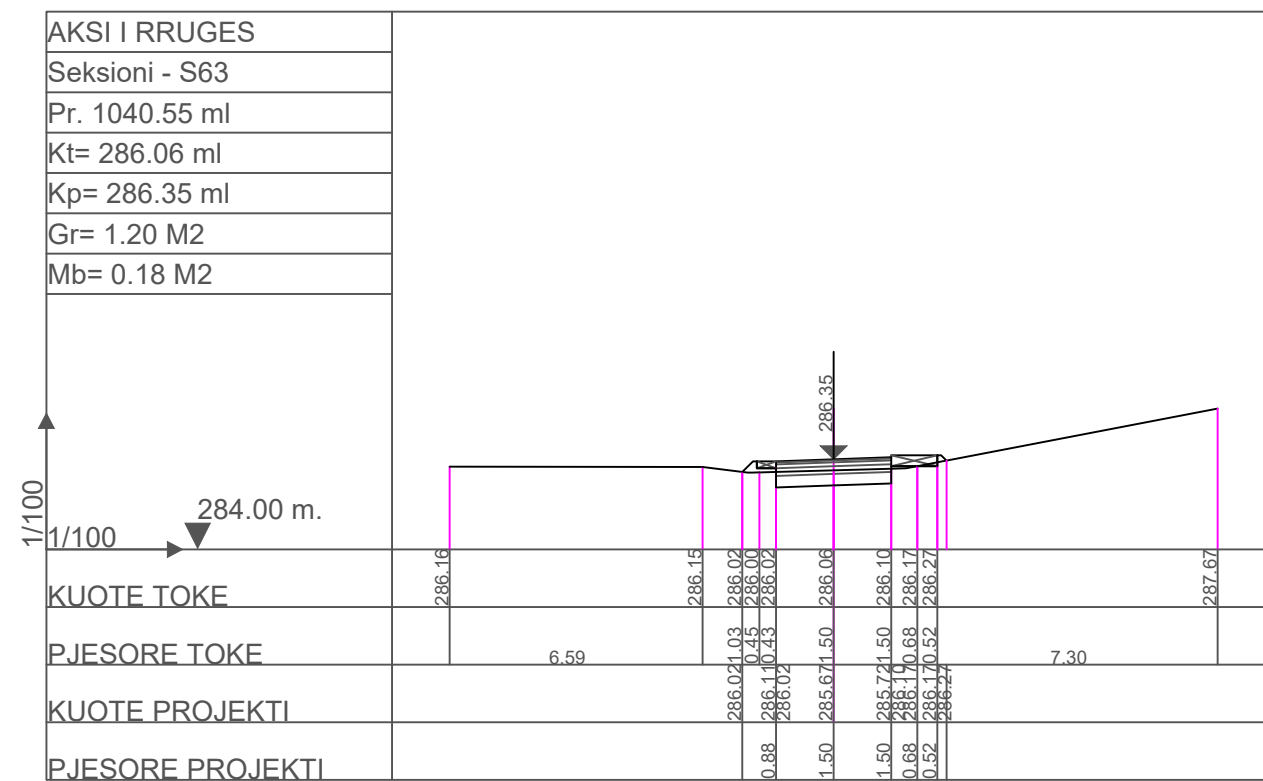
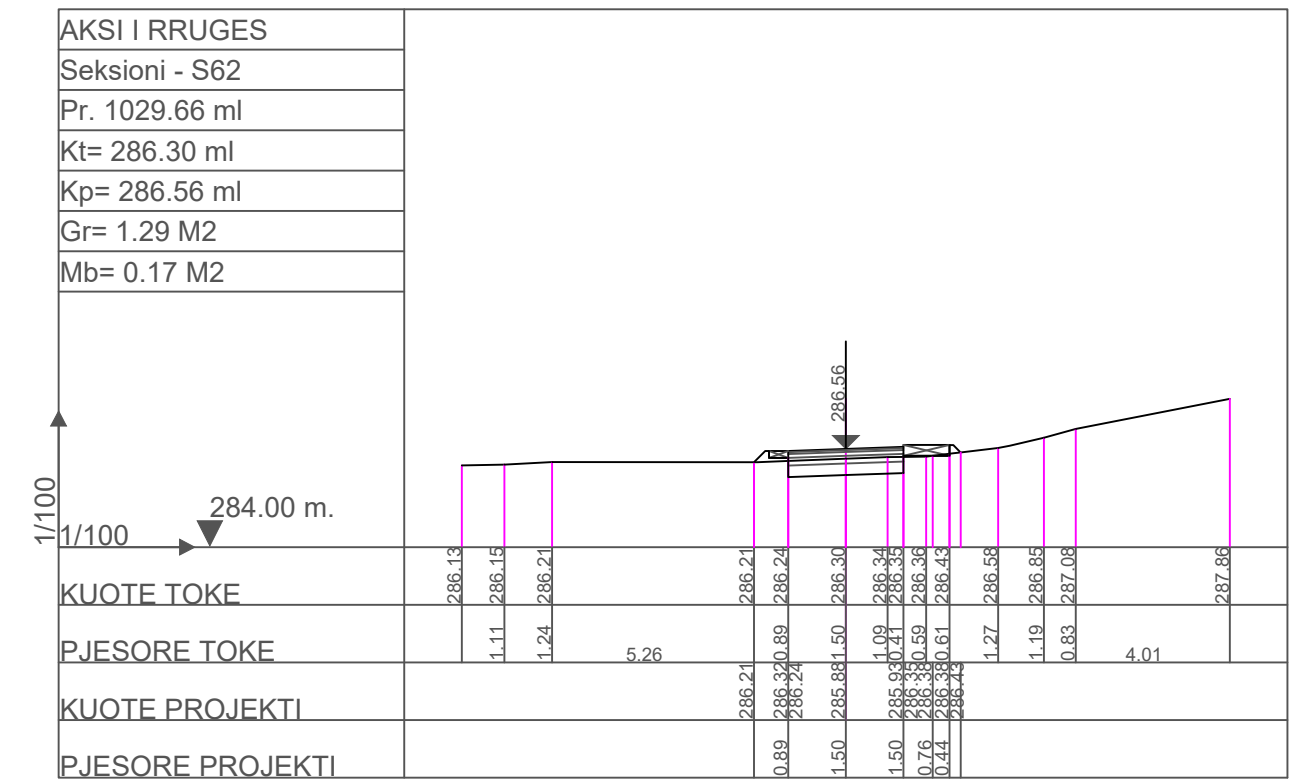
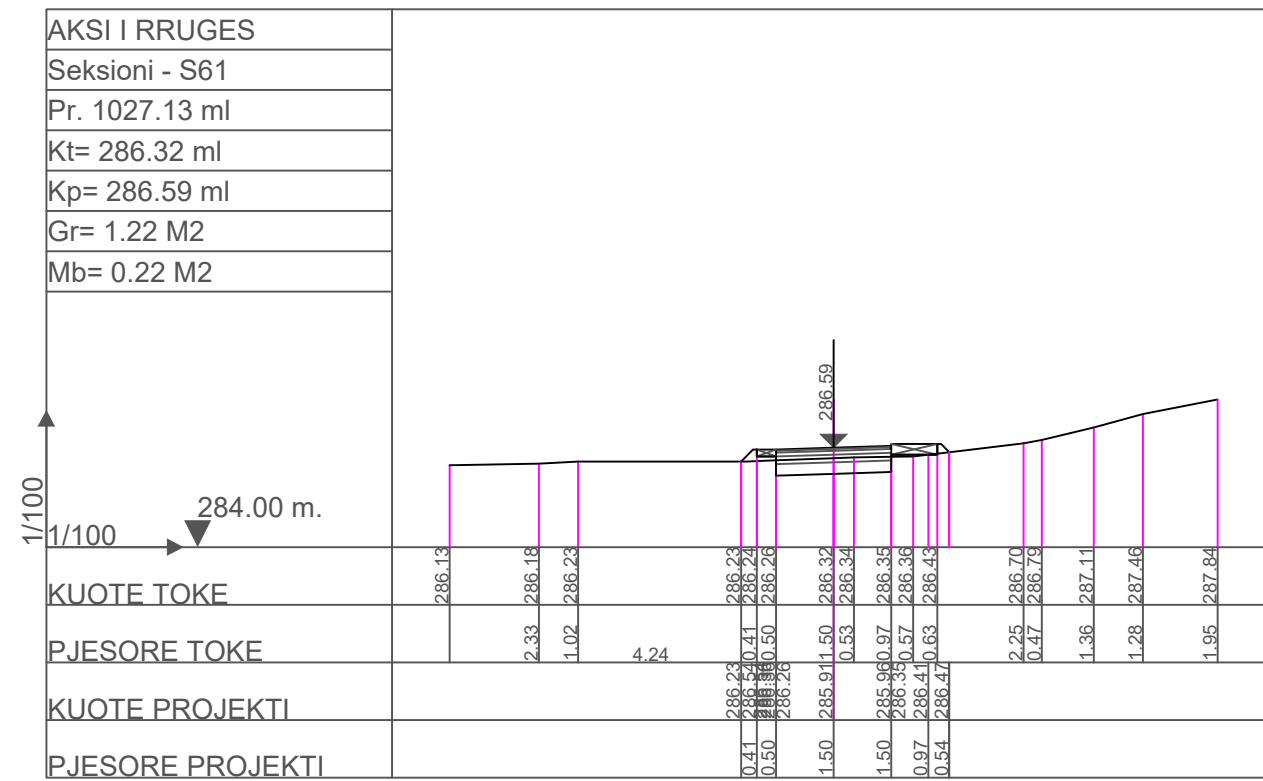

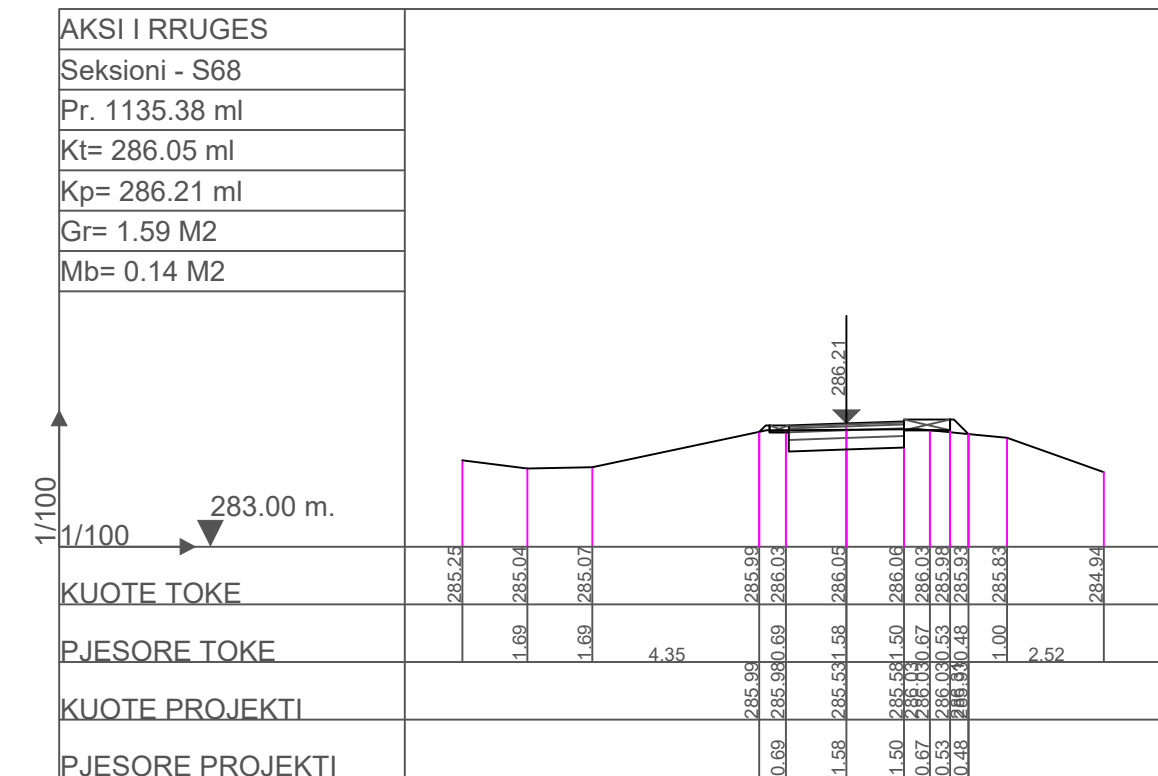
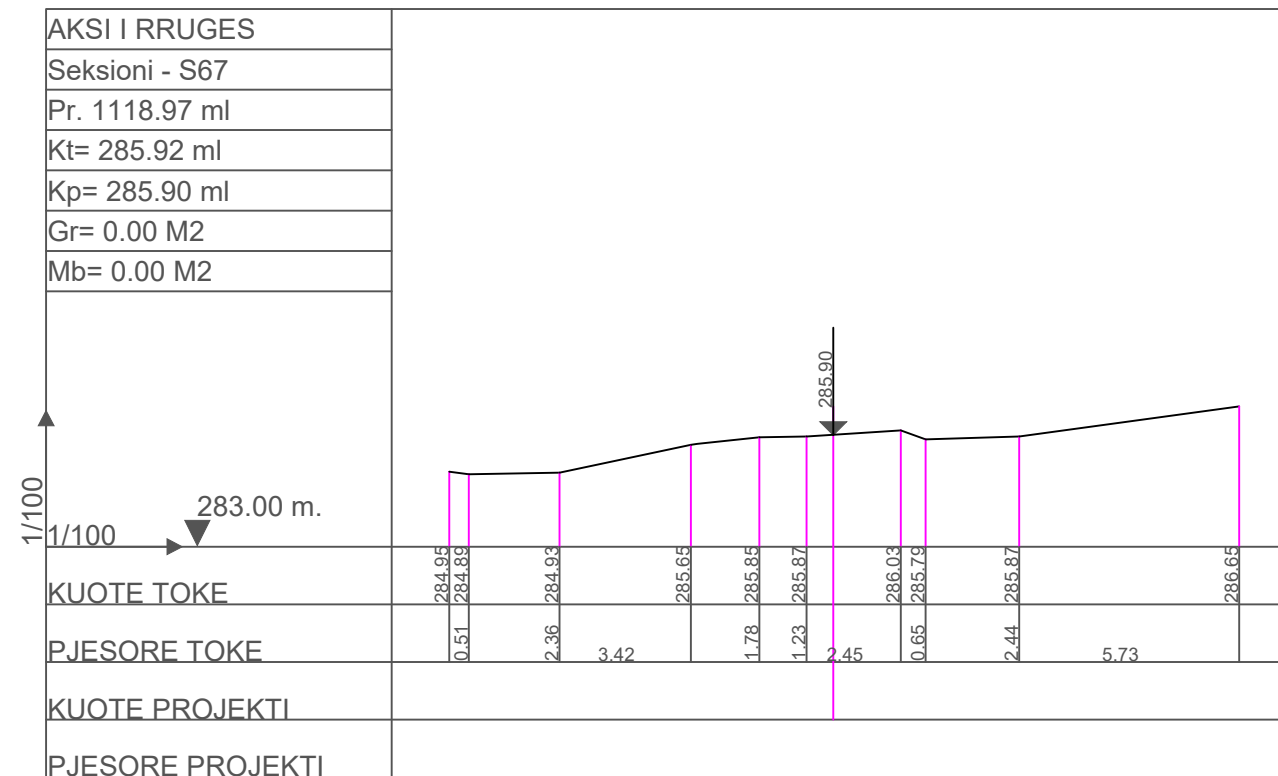
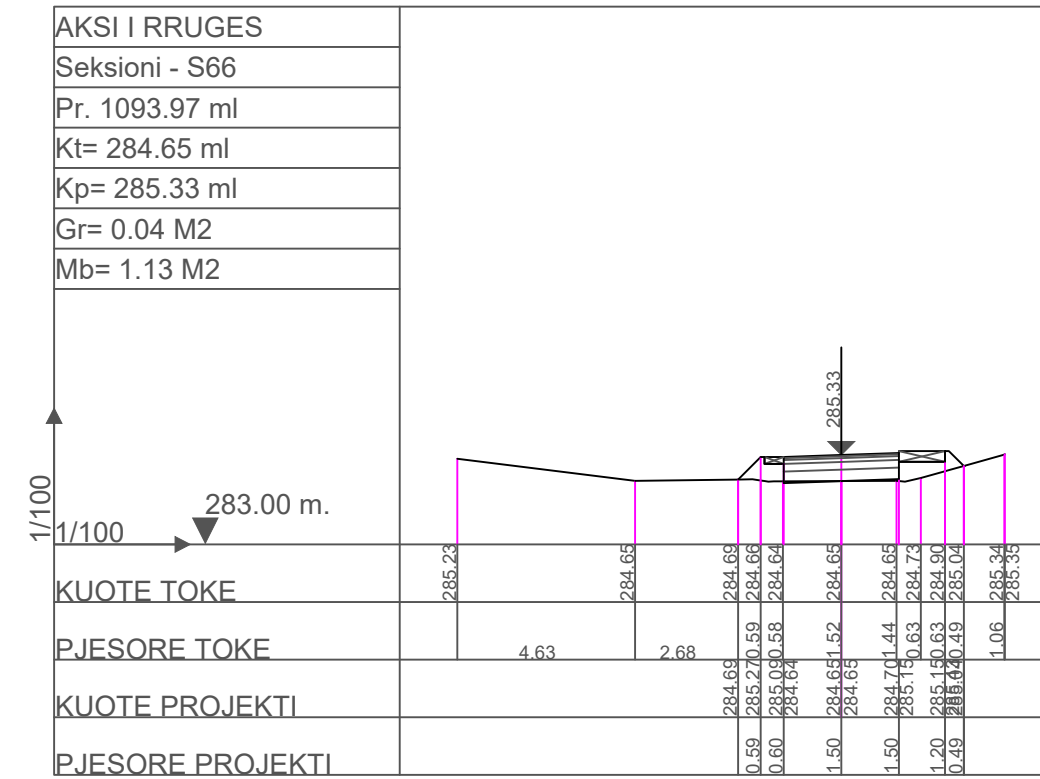
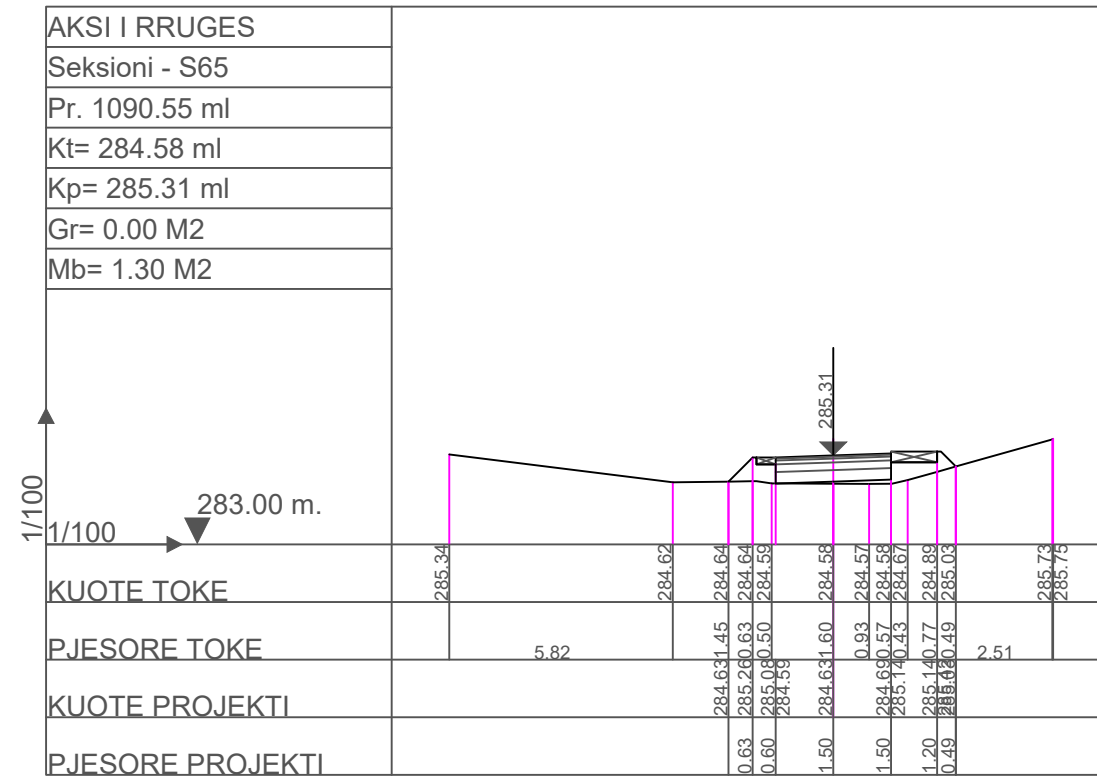

POROSITESI : BASHKIA MAT

OBJEKTI: "Ndertimi i rruges fshati Bater ,bashkia Mat"

Emertimi: **Profili terthor**



"Imperium Construction", shpk
 Adresa: njesi Bashkiake nr.9 Rruga "Shyqyri Peza"
 Pallati 21, Hyrja 1,Kati 2 ,Tirane

Drejtesues i projektit

Adm. Arber TOLA

Projektues

Inxh. Elton LLAPUSHI
 Inxh. Ilir Hodaj
 Ark. Rigert HYRA

Mek. Bujar MERAJ
 Elek. Altin ALLKAJ
 Top. Iv BEQARI

SHKALLA

1- 200

MAT 2022

FLETA

1 - 01

Format A3

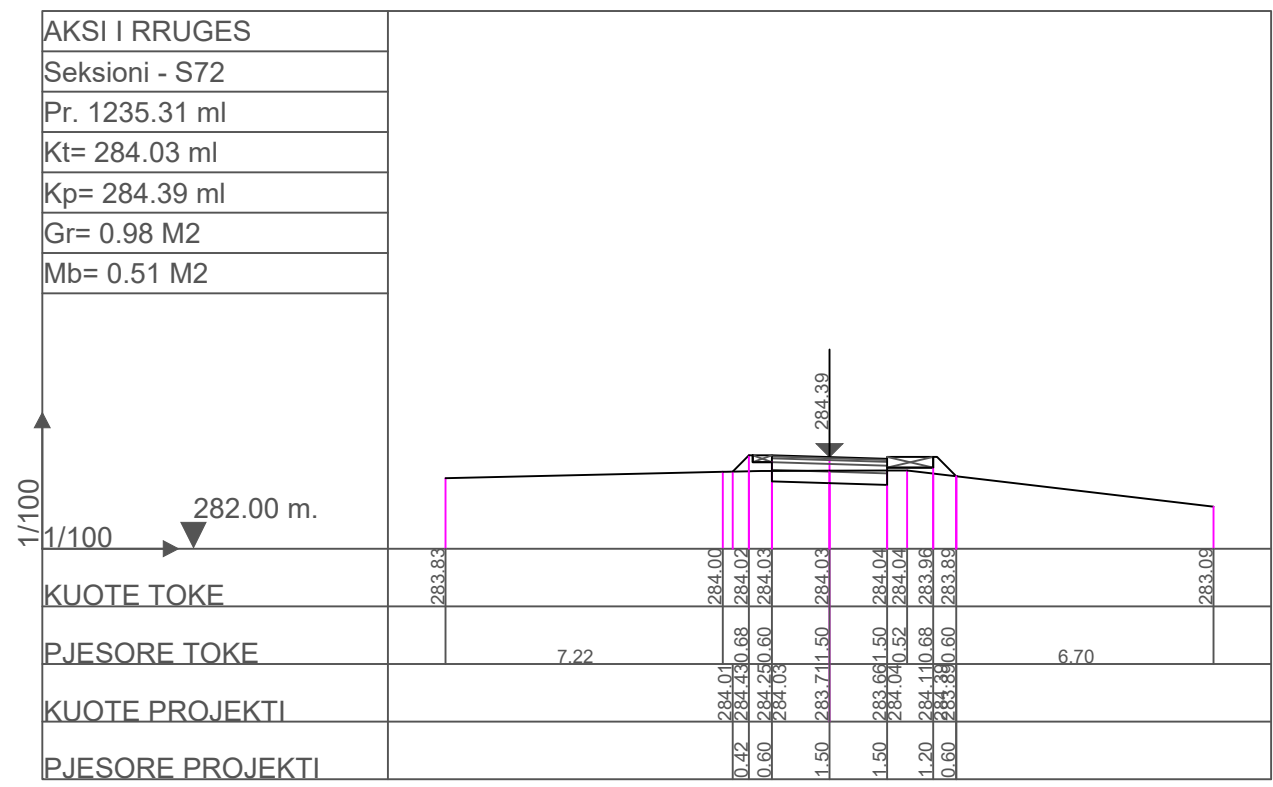
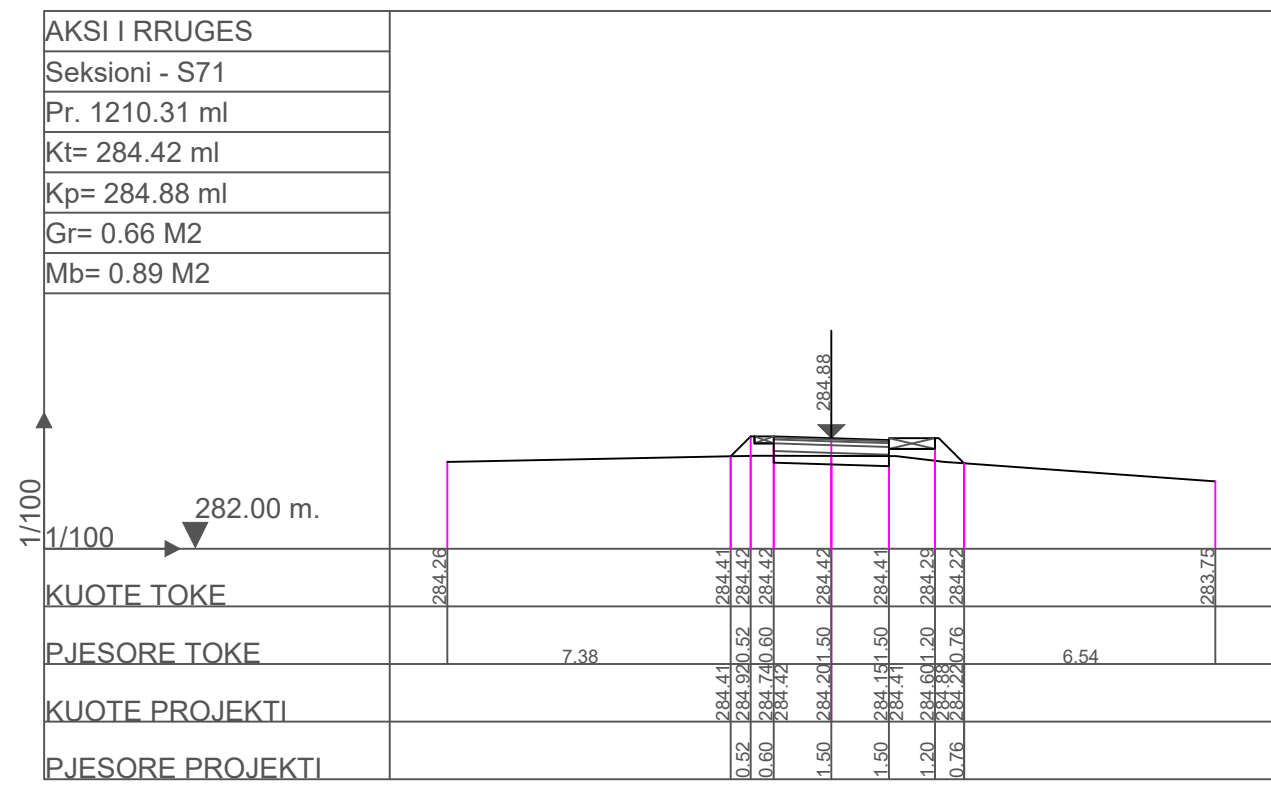
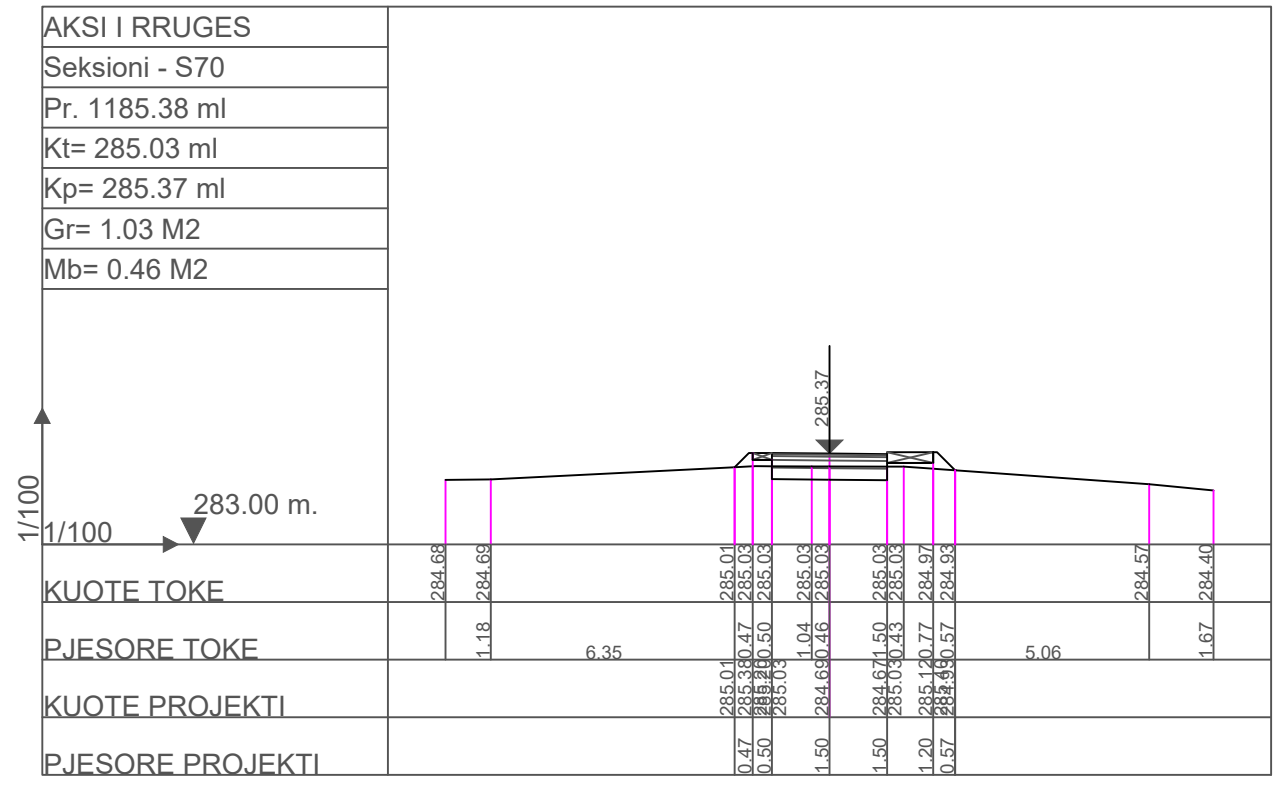
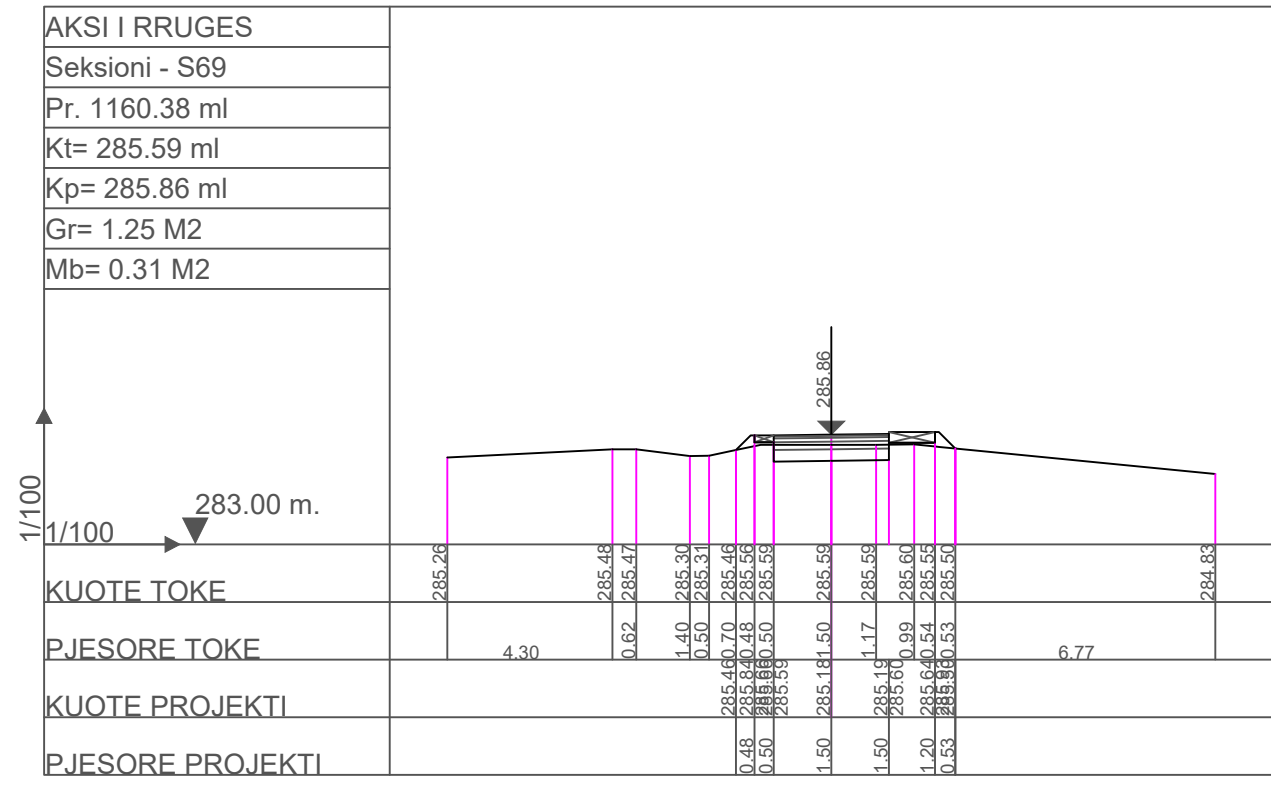

POROSITESI : BASHKIA MAT
 OBJEKTI: "Ndertimi i rruges fshati Bater ,bashkia Mat"

Emertimi: **Profili terthor**
 "Imperium Construction", shpk
 Adresa: njesi Bashkiake nr.9 Rruga "Shyqyri Peza"
 Pallati 21, Hyrja 1,Kati 2 ,Tirane

Drejtesues i projektit
 Adm. Arber TOLA

Projektues
 Inxh. Elton LLAPUSHI
 Inxh. Ilir Hodaj
 Ark. Rigert HYRA
 Mek. Bujar MERAJ
 Elek. Altin ALLKAJ
 Top. Iv BEQARI

SHKALLA	FLETA
1- 200	1 - 01
MAT 2022	Format A3

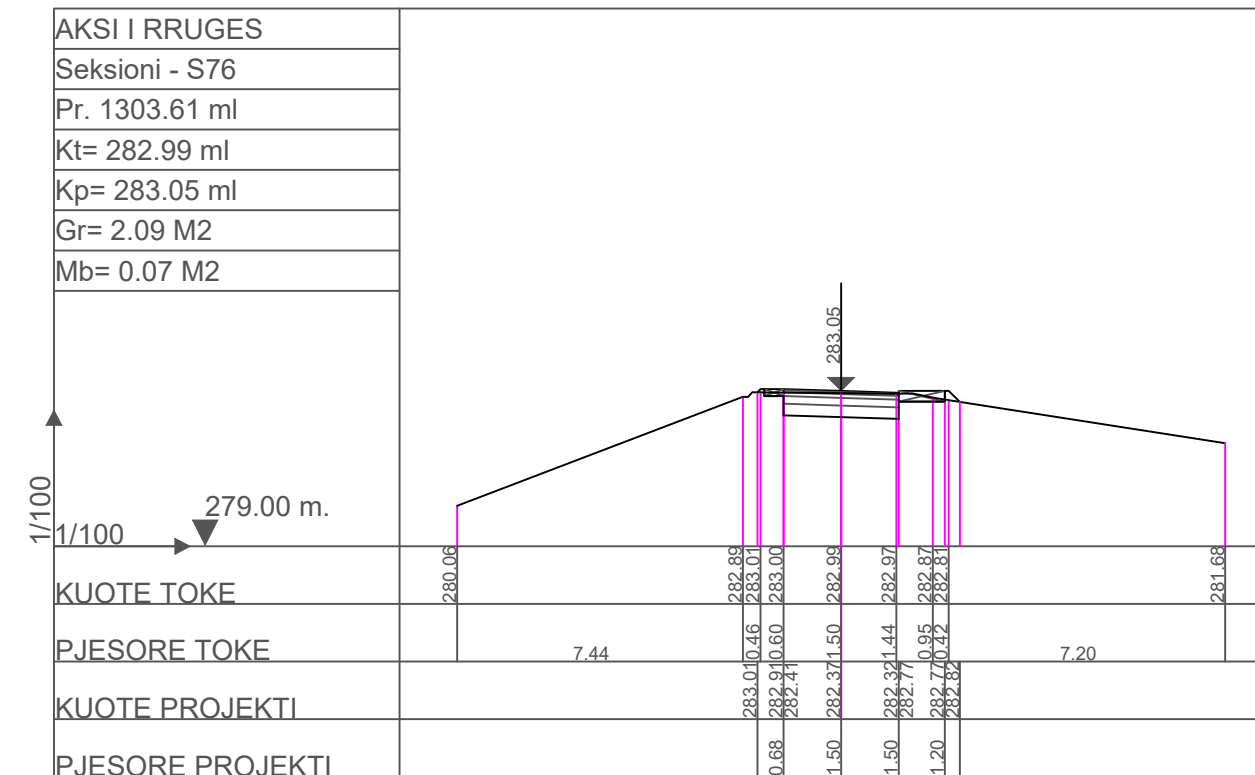
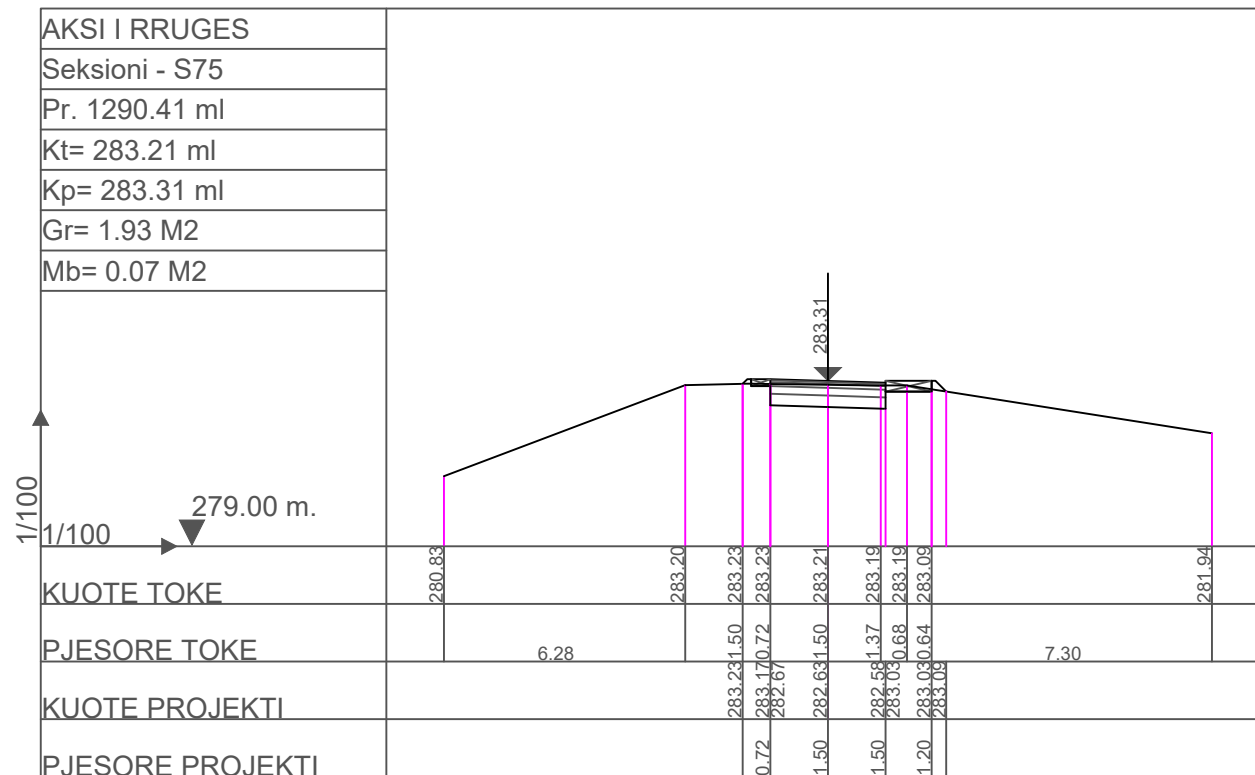
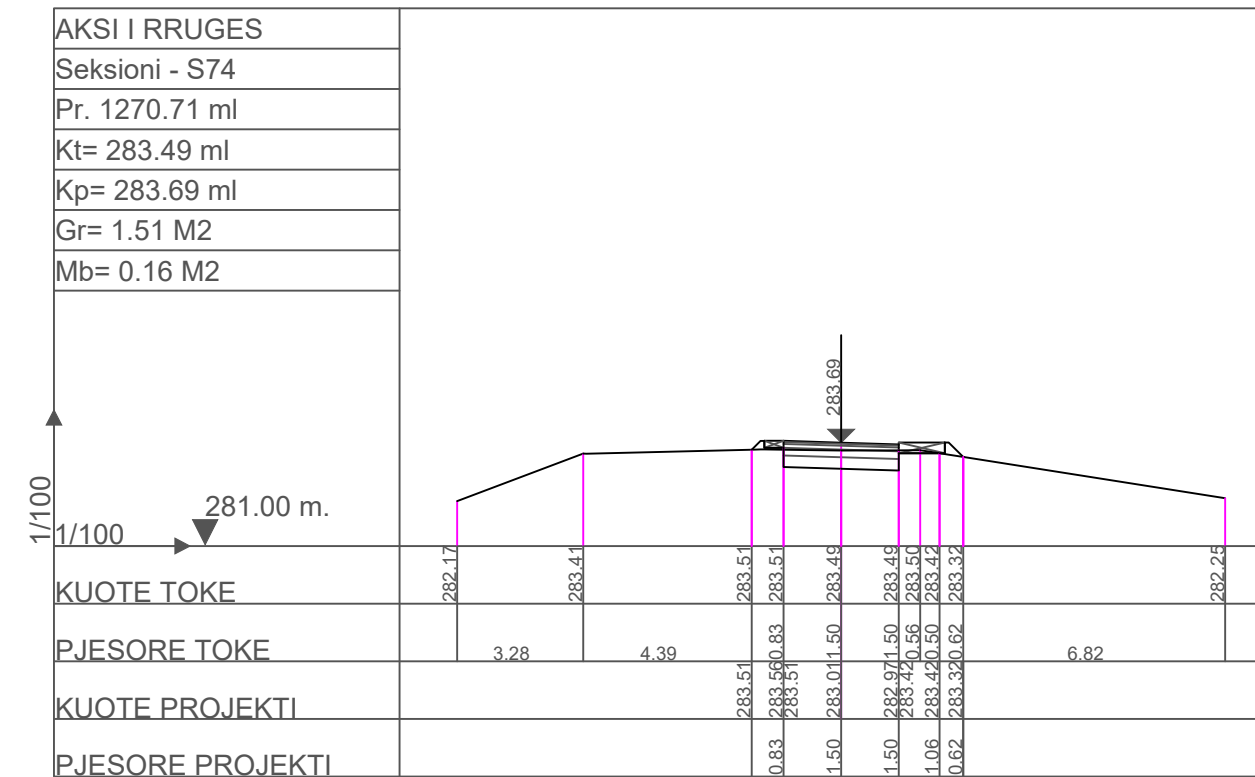
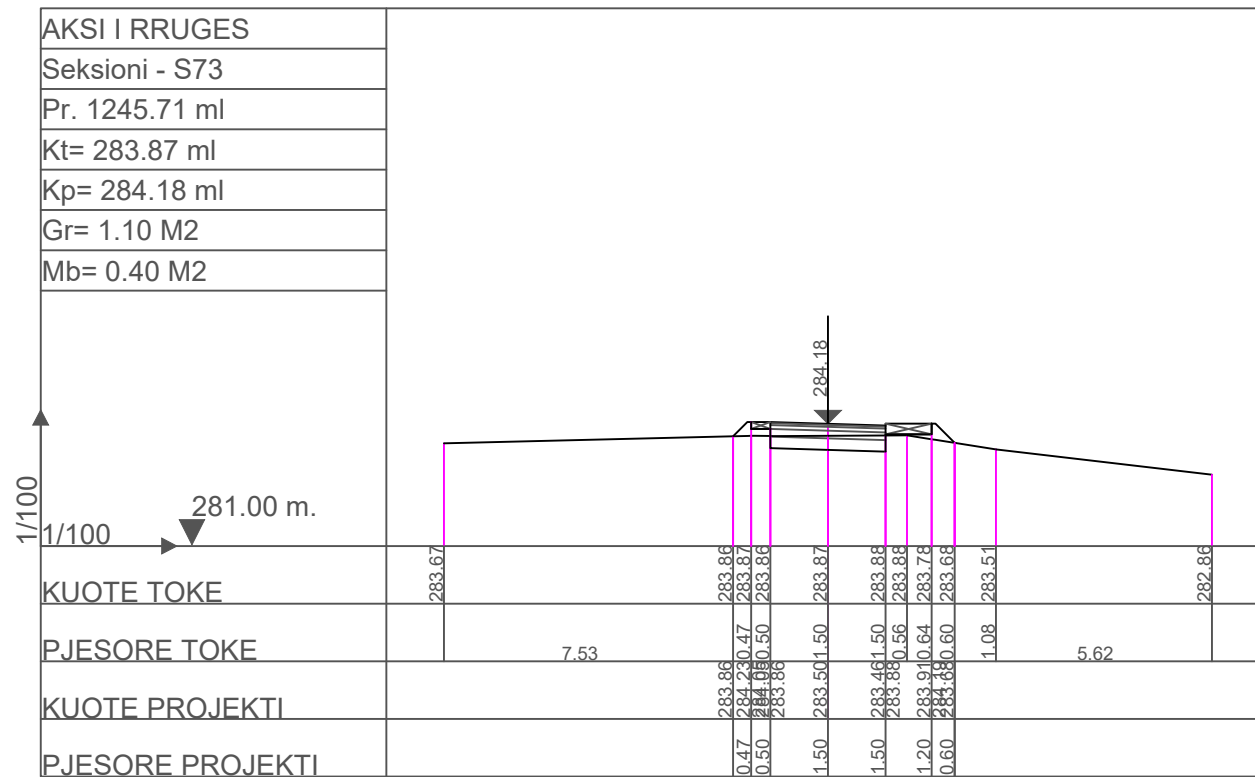

POROSITESI : BASHKIA MAT

OBJEKTI: "Ndertimi i rruges fshati Bater ,bashkia Mat"

Emertimi: Profili terthor



"Imperium Construction", shpk
Adresa: njesi Bashkiake nr.9 Rruga "Shyqyri Peza"
Pallati 21, Hyrja 1,Kati 2 ,Tirane

Drejtesues i projektit

Adm. Arber TOLA

Projektues

Inxh. Elton LLAPUSHI
Inxh. Ilir Hodaj
Ark. Rigert HYRA

Mek. Bujar MERAJ
Elek. Altin ALLKAJ
Top. Iv BEQARI

SHKALLA

1- 200

MAT 2022

FLETA

1 - 01

Format A3

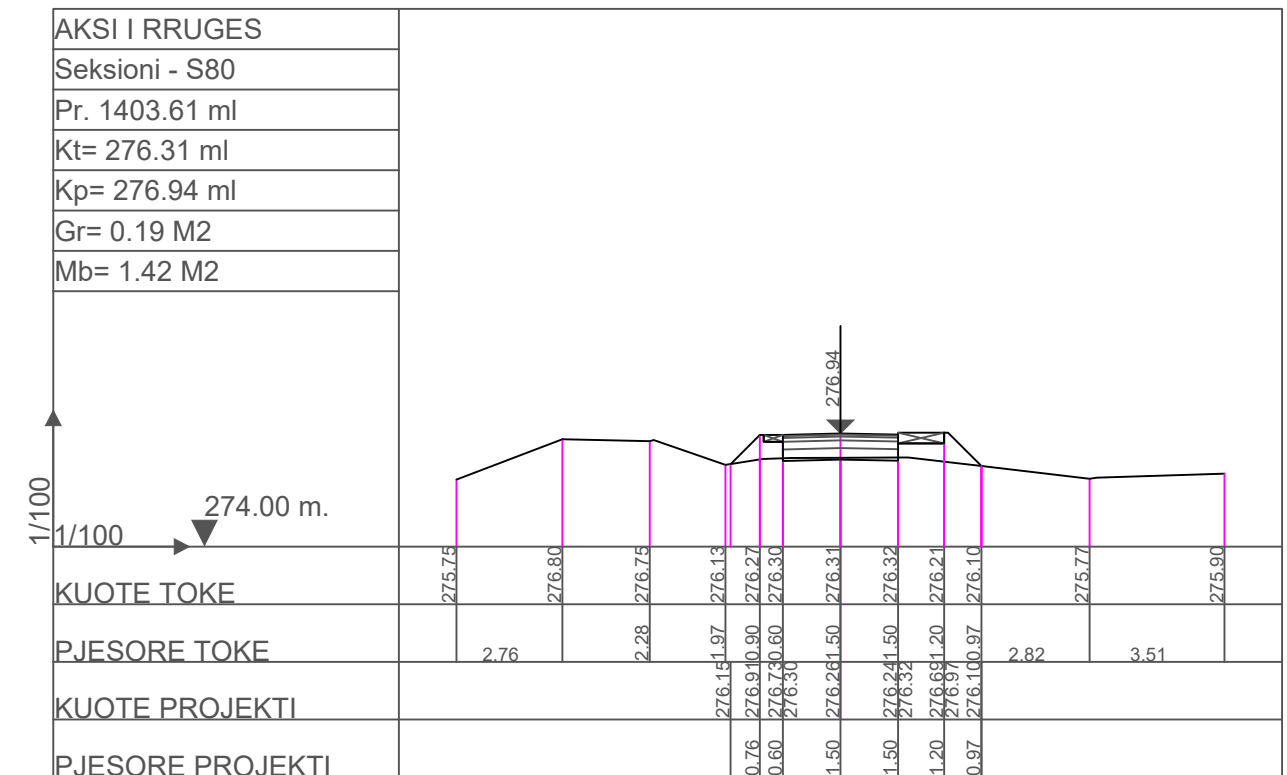
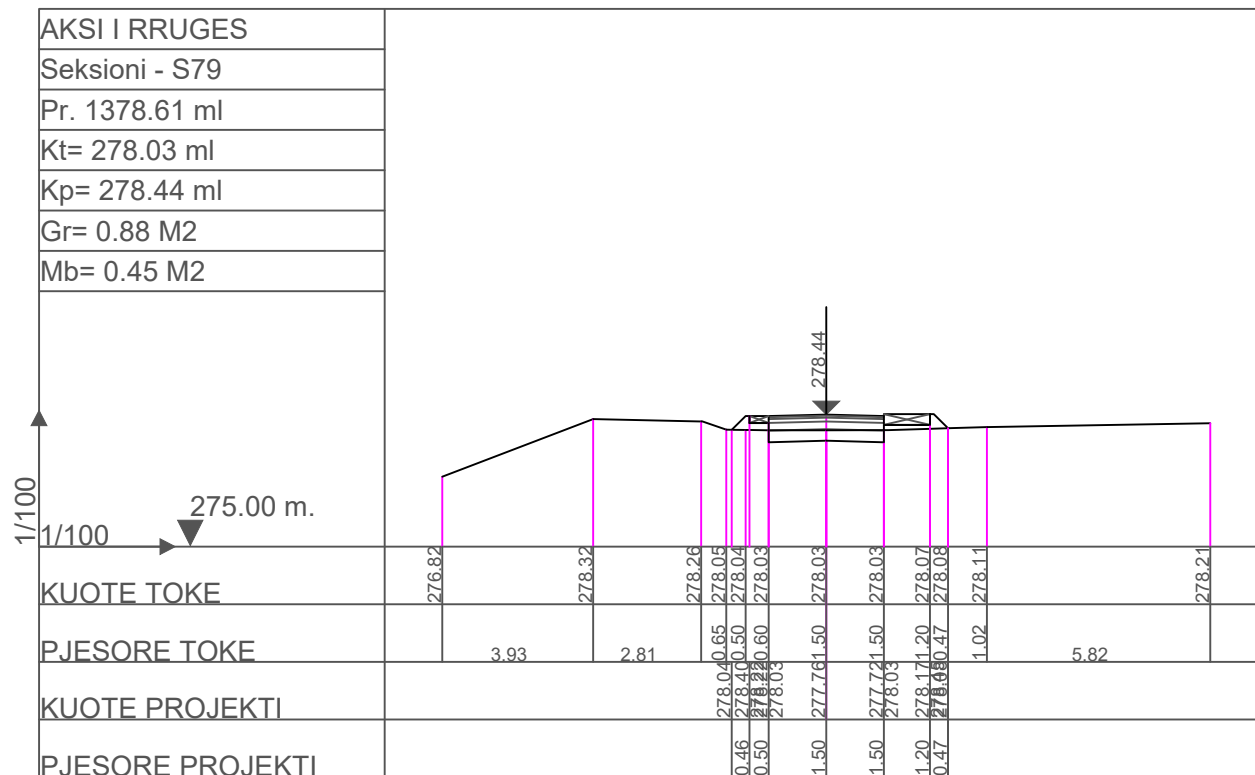
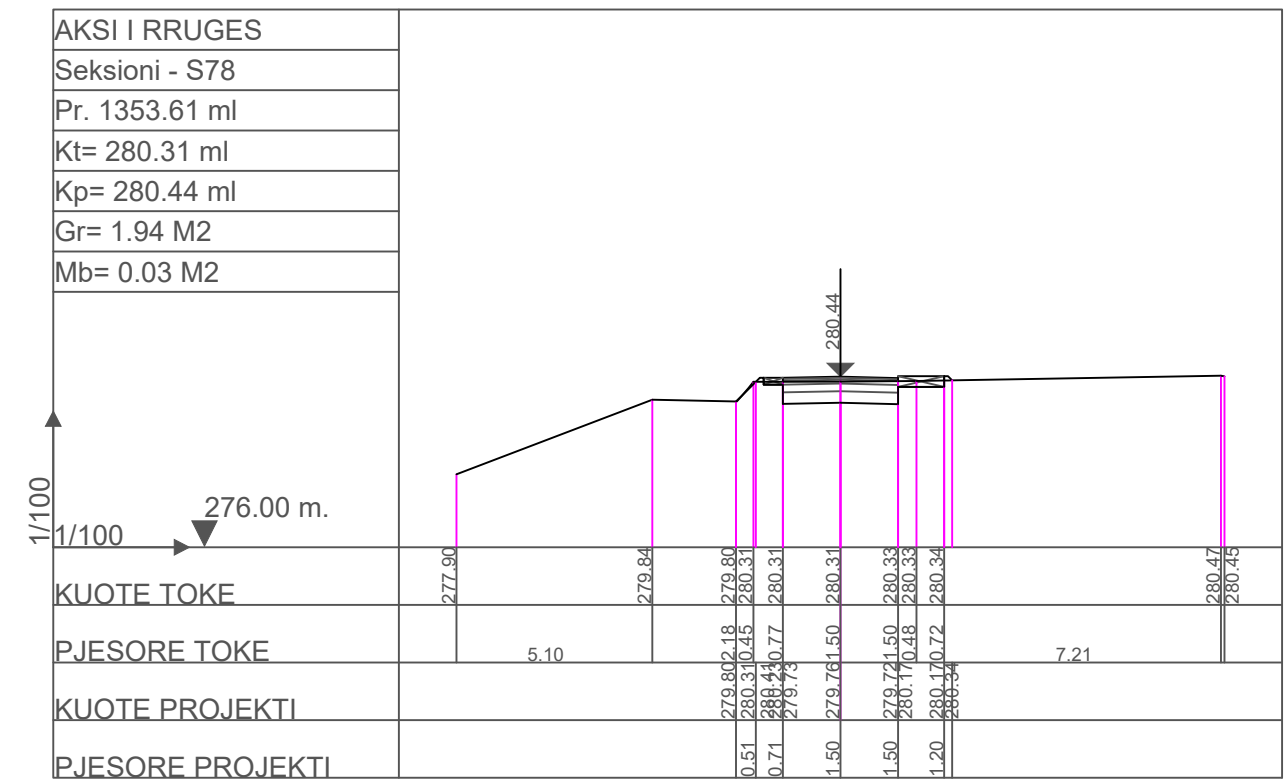
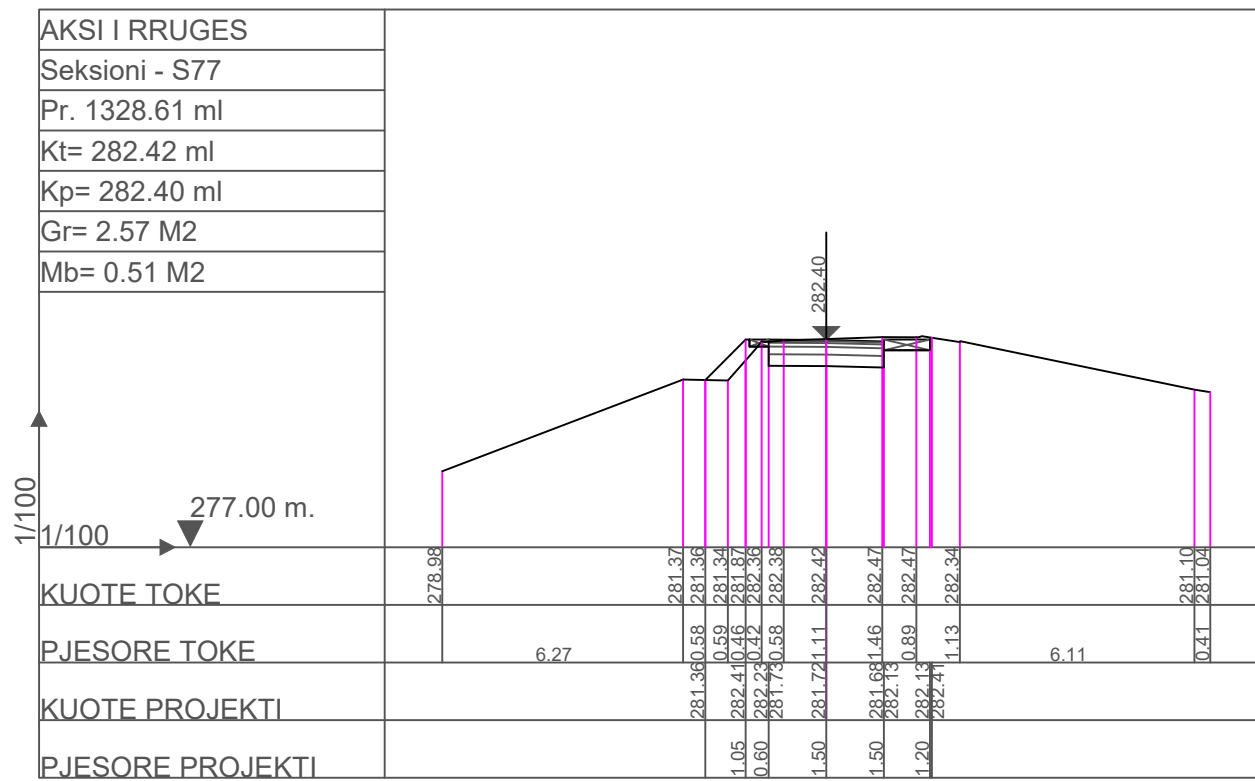

POROSITESI : BASHKIA MAT

OBJEKTI: "Ndertimi i rruges fshati Bater ,bashkia Mat"

Emertimi: Profili terthor



"Imperium Construction", shpk
Adresa: njesi Bashkiake nr.9 Rruga "Shyqyri Peza"
Pallati 21, Hyrja 1,Kati 2 ,Tirane

Drejtes i projektit

Adm. Arber TOLA

Projektues

Inxh. Elton LLAPUSHI
Inxh. Ilir Hodaj
Ark. Rigert HYRA

Mek. Bujar MERAJ
Elek. Altin ALLKAJ
Top. Iv BEQARI

SHKALLA

1- 200

MAT 2022

FLETA

1 - 01

Format A3

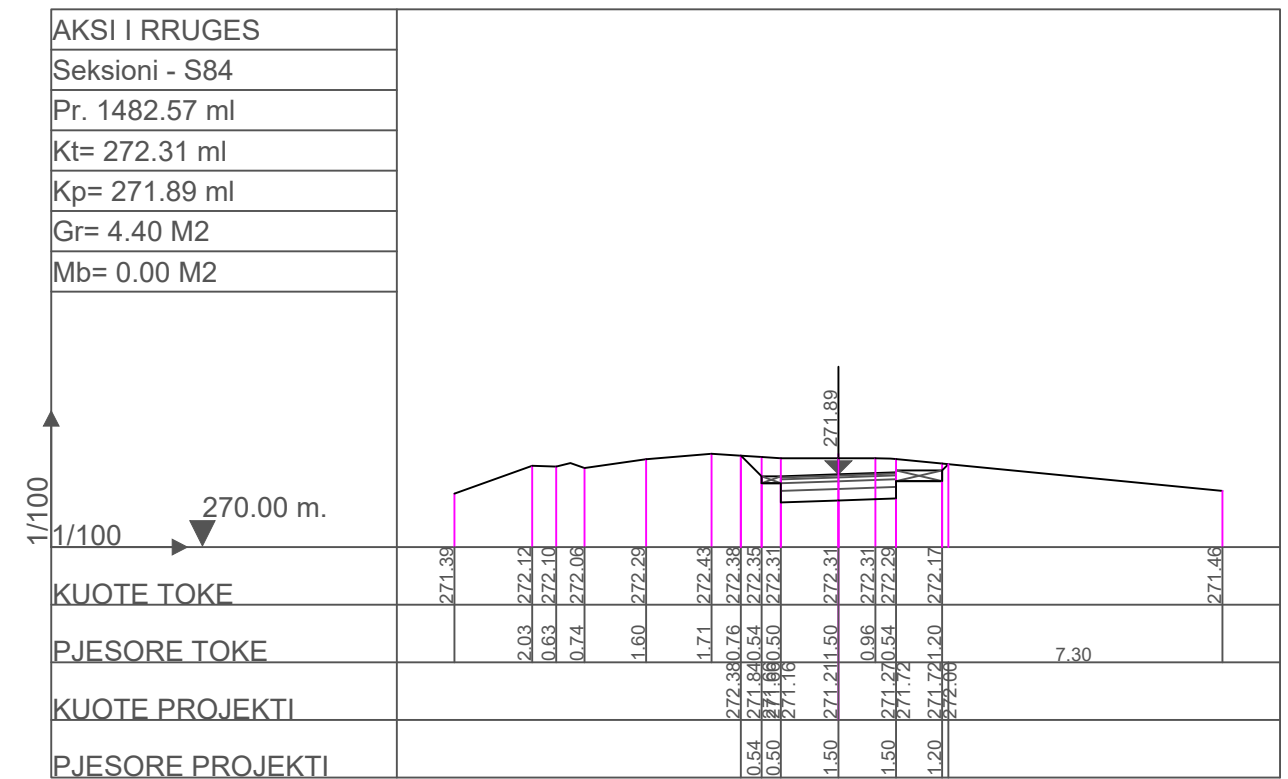
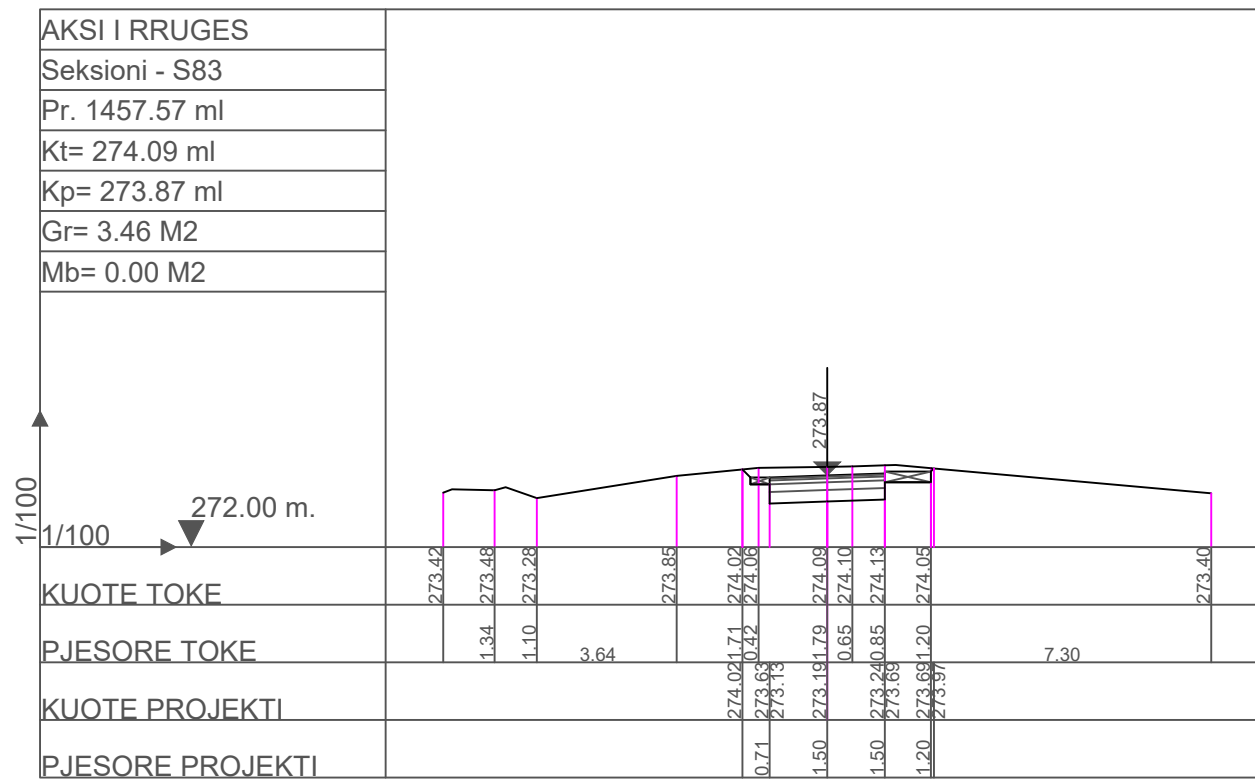
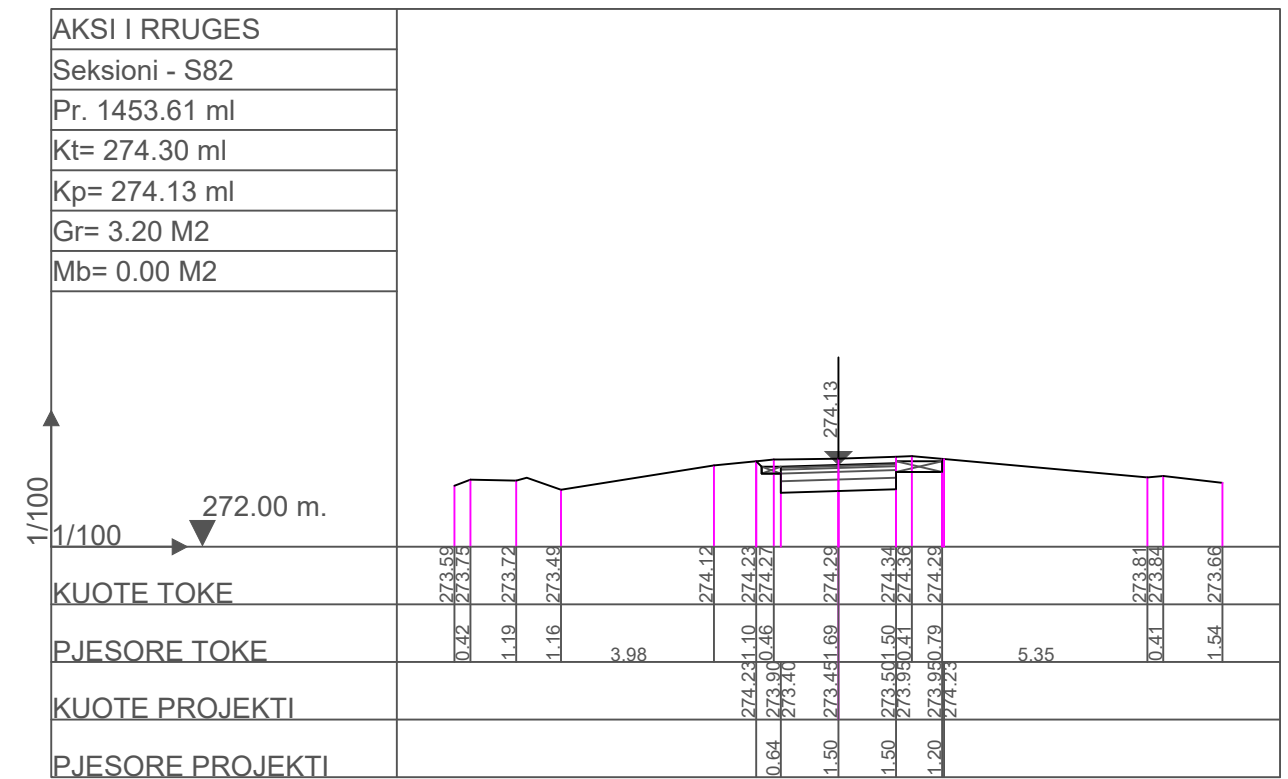
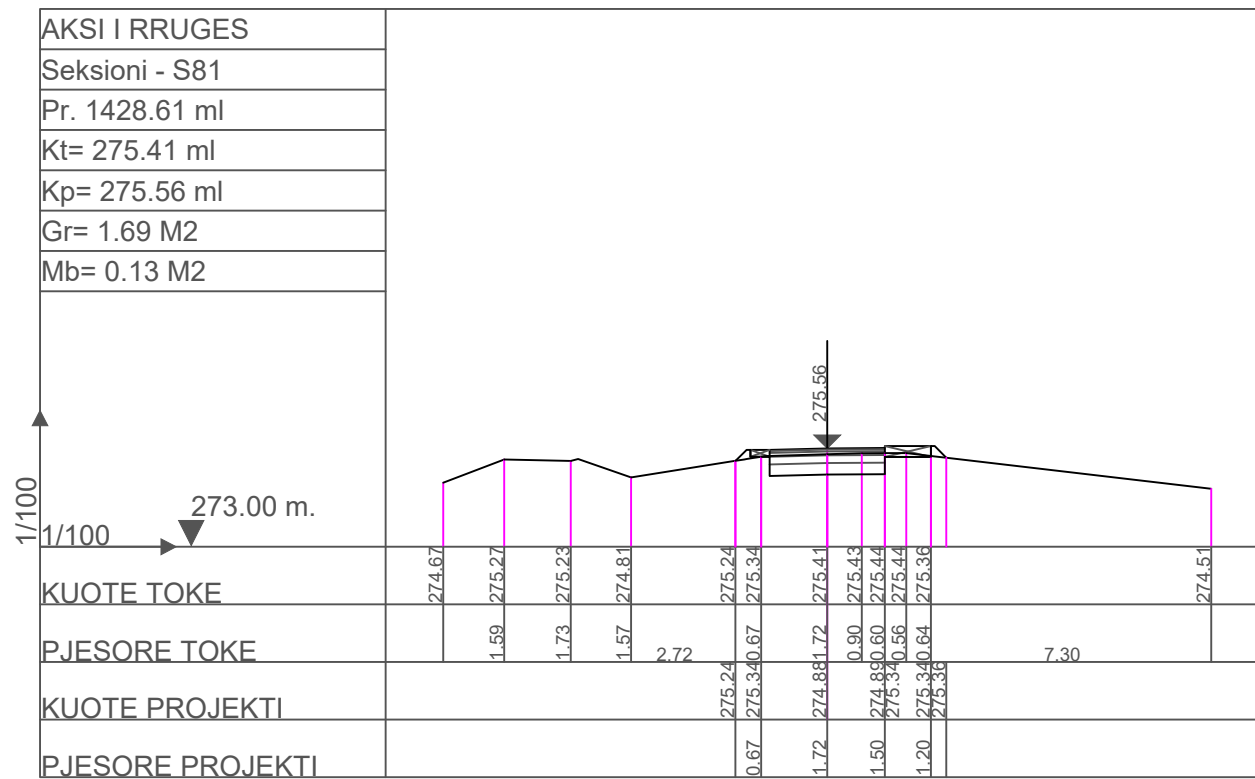

POROSITESI : BASHKIA MAT

OBJEKTI: "Ndertimi i rruges fshati Bater ,bashkia Mat"

Emertimi: Profili terthor



"Imperium Construction", shpk
 Adresa: njesi Bashkiake nr.9 Rruga "Shyqyri Peza"
 Pallati 21, Hyrja 1,Kati 2 ,Tirane

Drejtes i projektit

Adm. Arber TOLA

Projektues

Inxh. Elton LLAPUSHI	Mek. Bujar MERAJ
Inxh. Ilir Hodaj	Elek. Altin ALLKAJ
Ark. Rigert HYRA	Top. Iv BEQARI

SHKALLA

1- 200

MAT 2022

FLETA

1 - 01

Format A3

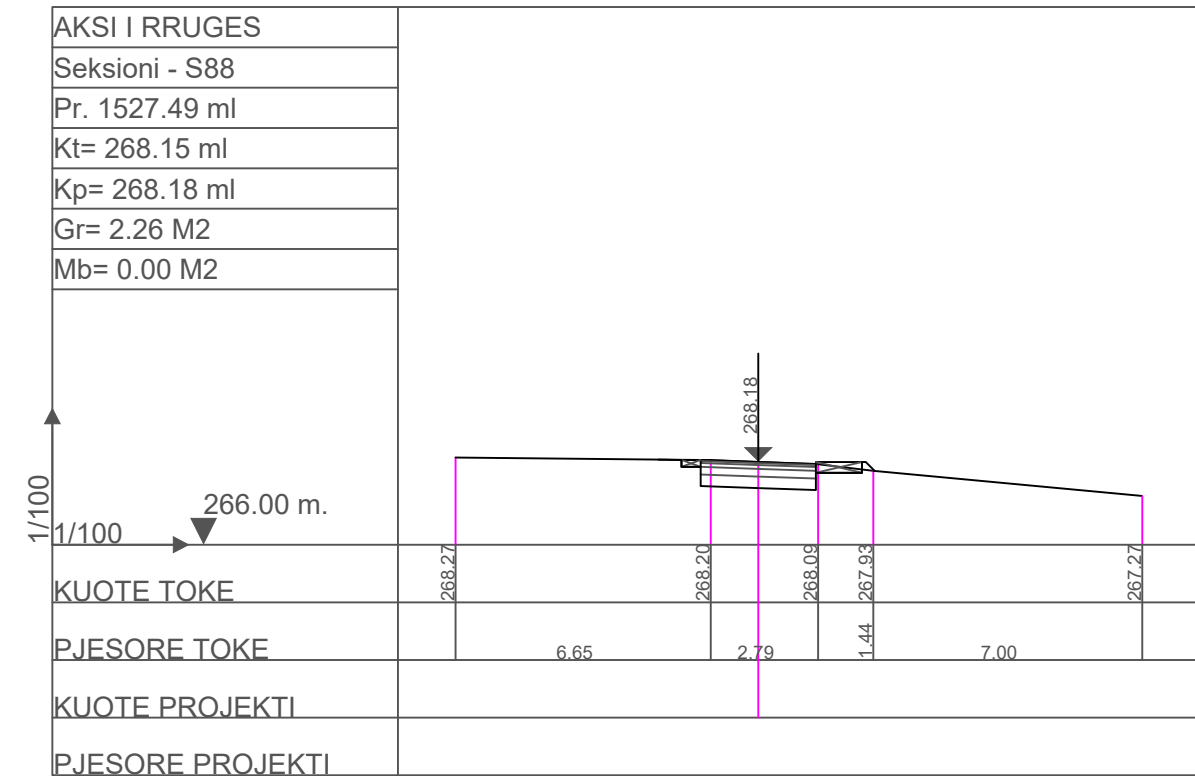
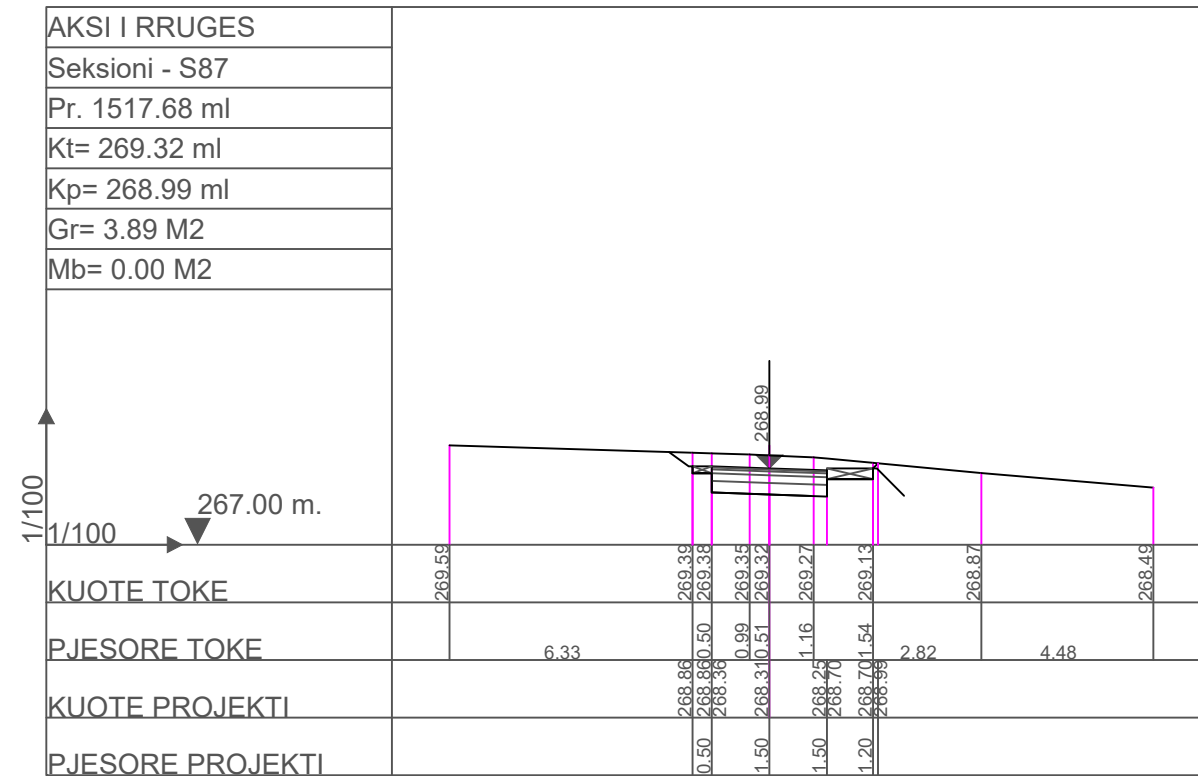
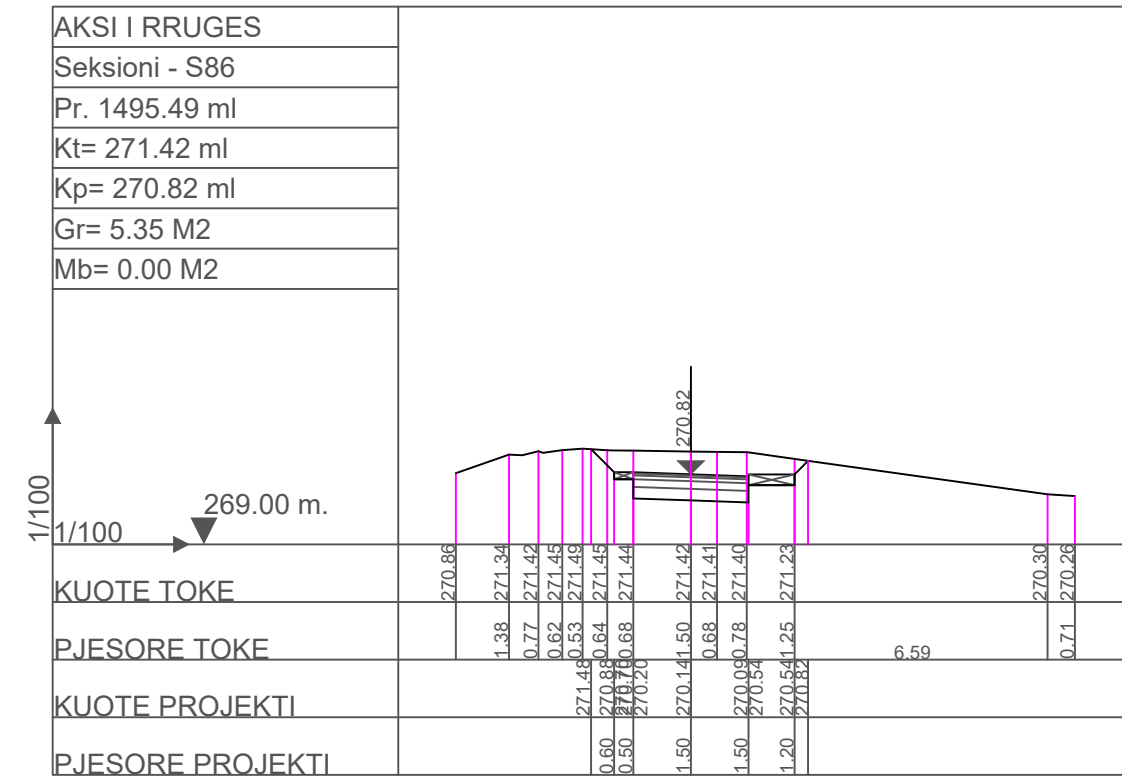
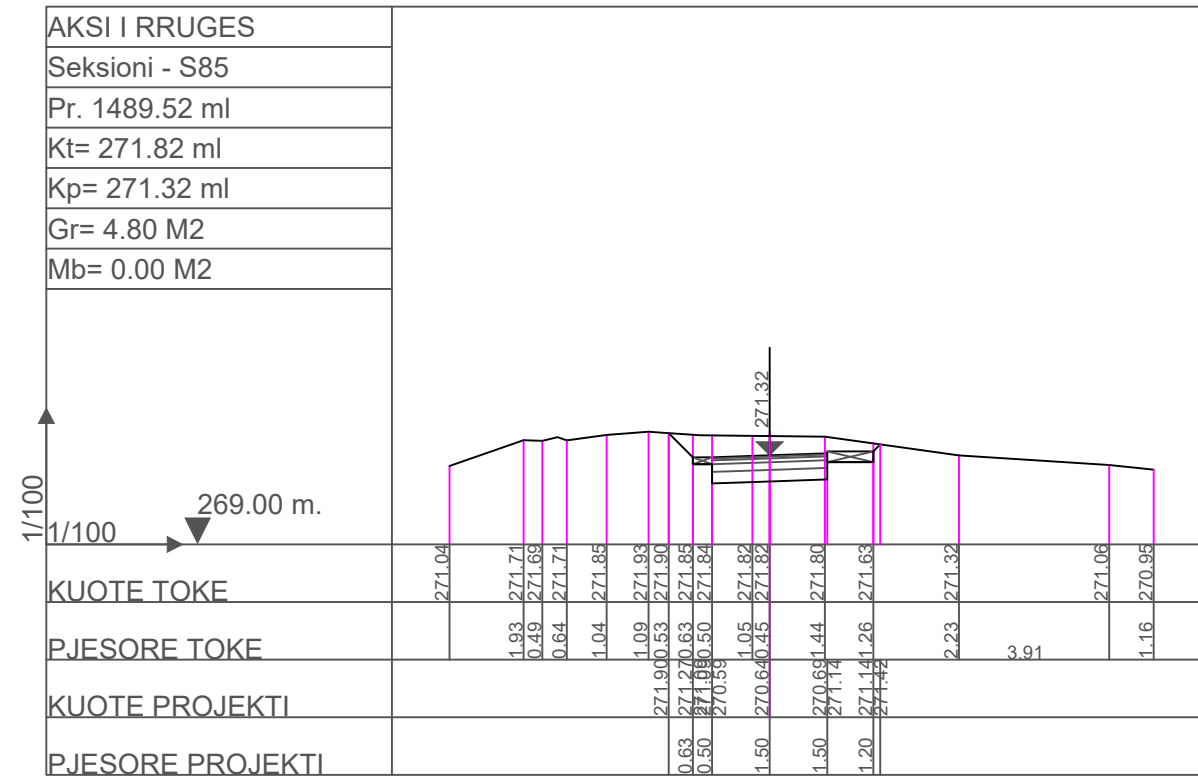

POROSITESI : BASHKIA MAT

OBJEKTI: "Ndertimi i rruges fshati Bater ,bashkia Mat"

Emertimi: Profili terthor



"Imperium Construction", shpk
 Adresa: njesi Bashkiake nr.9 Rruga "Shyqyri Peza"
 Pallati 21, Hyrja 1,Kati 2 ,Tirane

Drejtesues i projektit

Adm. Arber TOLA

Projektues

Inxh. Elton LLAPUSHI
 Inxh. Ilir Hodaj
 Ark. Rigert HYRA

Mek. Bujar MERAJ
 Elek. Altin ALLKAJ
 Top. Iv BEQARI

SHKALLA

1- 200

MAT 2022

FLETA

1 - 01

Format A3

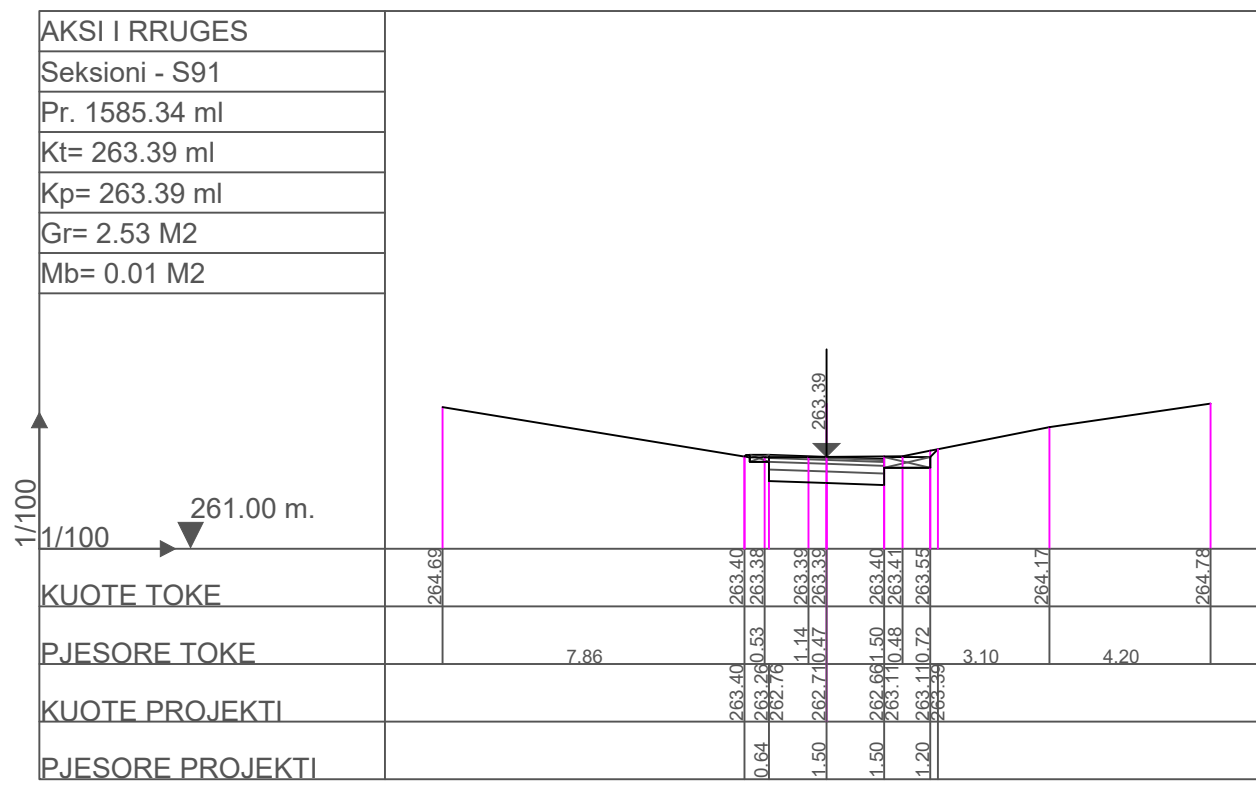
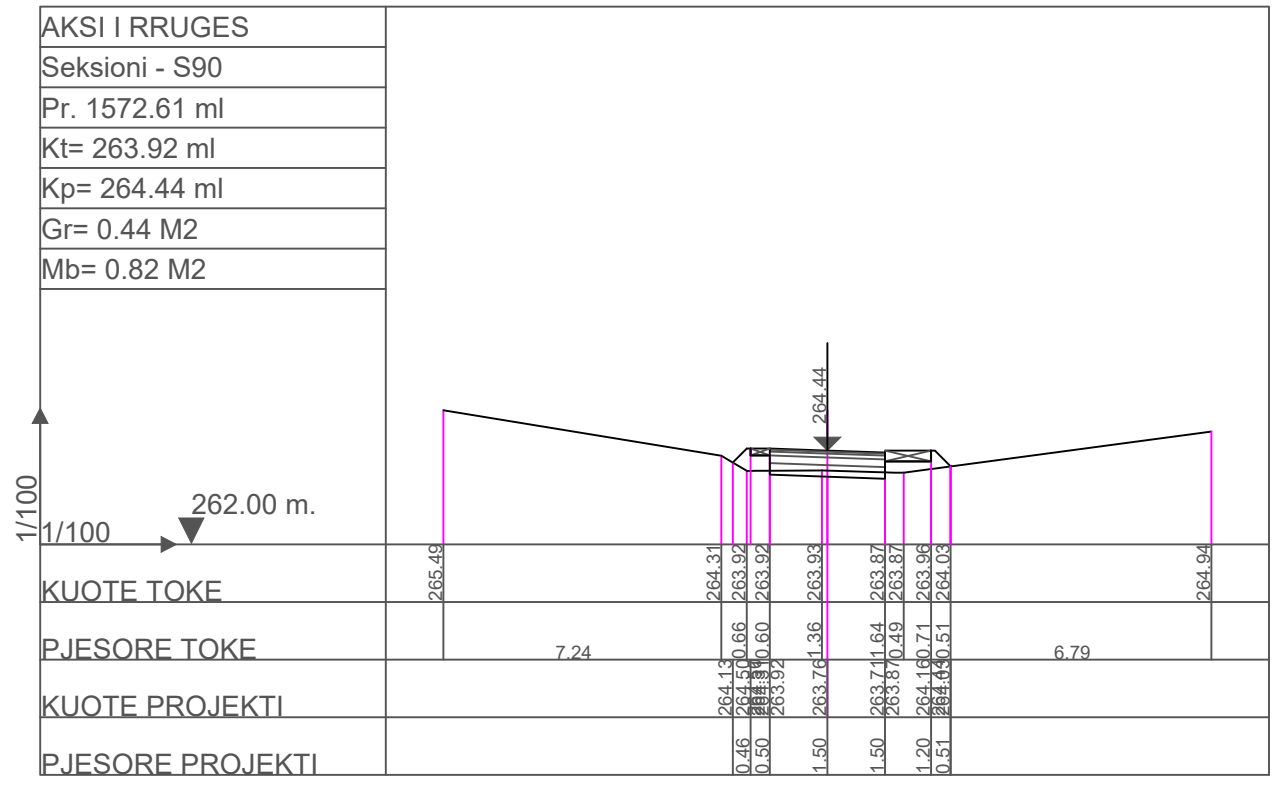
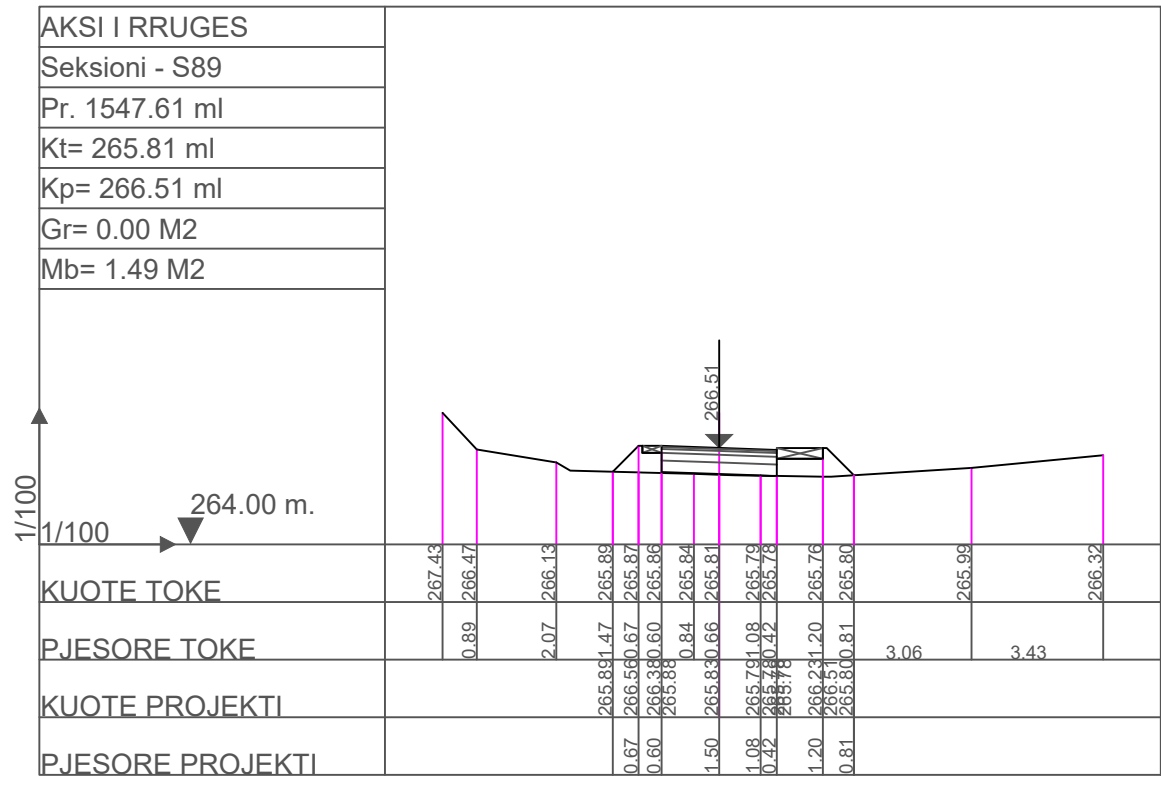

POROSITESI : BASHKIA MAT
 OBJEKTI: "Ndertimi i rruges fshati Bater ,bashkia Mat"

Emertimi: Profili terthor
 "Imperium Construction", shpk
 Adresa: njesi Bashkiake nr.9 Rruga "Shyqyri Peza"
 Pallati 21, Hyrja 1,Kati 2 ,Tirane

Drejtesues i projektit
 Adm. Arber TOLA

Projektues
 Inxh. Elton LLAPUSHI
 Inxh. Ilir Hodaj
 Ark. Rigert HYRA
 Mek. Bujar MERAJ
 Elek. Altin ALLKAJ
 Top. Iv BEQARI

SHKALLA	FLETA
1- 200	1 - 01
MAT 2022	Format A3



REPUBLIKA E SHQIPERISË
BASHKIA MAT

PROJEKT ZBATIMI

OBJEKTI:

Ndertimi i rruges fshati Bater, bashkia Mat
Planimetria e sinjalistikes



POROSITESI : BASHKIA MAT

OBJEKTI: "Ndertimi i rruges fshati Bater ,bashkia Mat"

Emertimi: Planimetria e sinjalistikes



"Imperium Construction", shpk
Adresa: njesi Bashkiake nr.9 Rruga "Shyqyri Peza"
Pallati 21, Hyrja 1,Kati 2 ,Tirane

Drejtues i projektit

Adm. Arber TOLA

Projektues

Inxh. Elton LLAPUSHI	Mek. Bujar MERAJ
Inxh. Ilir Hodaj	Elek. Altin ALLKAJ
Ark. Rigert HYRA	Top. Iv BEQARI

SHKALLA

1- 500

MAT 2022

FLETA

1 - 01

Format A3

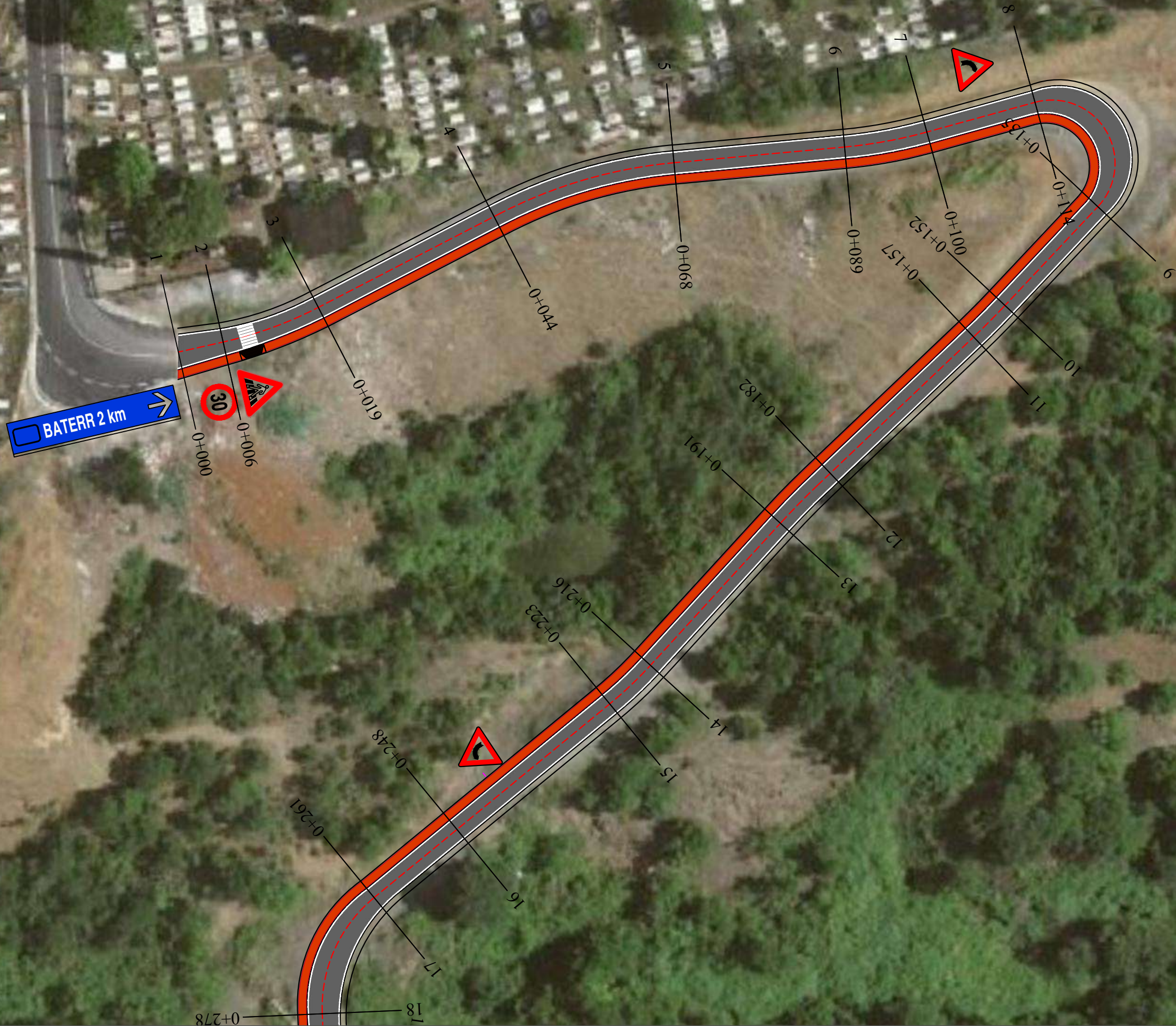

POROSITESI : BASHKIA MAT

OBJEKTI: "Ndertimi i rruges fshati Bater ,bashkia Mat"

Emertimi: Planimetria e sinjalistikes



"Imperium Construction", shpk
 Adresa: njesi Bashkiake nr.9 Rruga "Shyqyri Peza"
 Pallati 21, Hyrja 1,Kati 2 ,Tirane

Drejtues i projektit

Adm. Arber TOLA

Projektues

Inxh. Elton LLAPUSHI	Mek. Bujar MERAJ
Inxh. Ilir Hodaj	Elek. Altin ALLKAJ
Ark. Rigert HYRA	Top. Iv BEQARI

SHKALLA

1- 500

MAT 2022

FLETA

1 - 01

Format A3

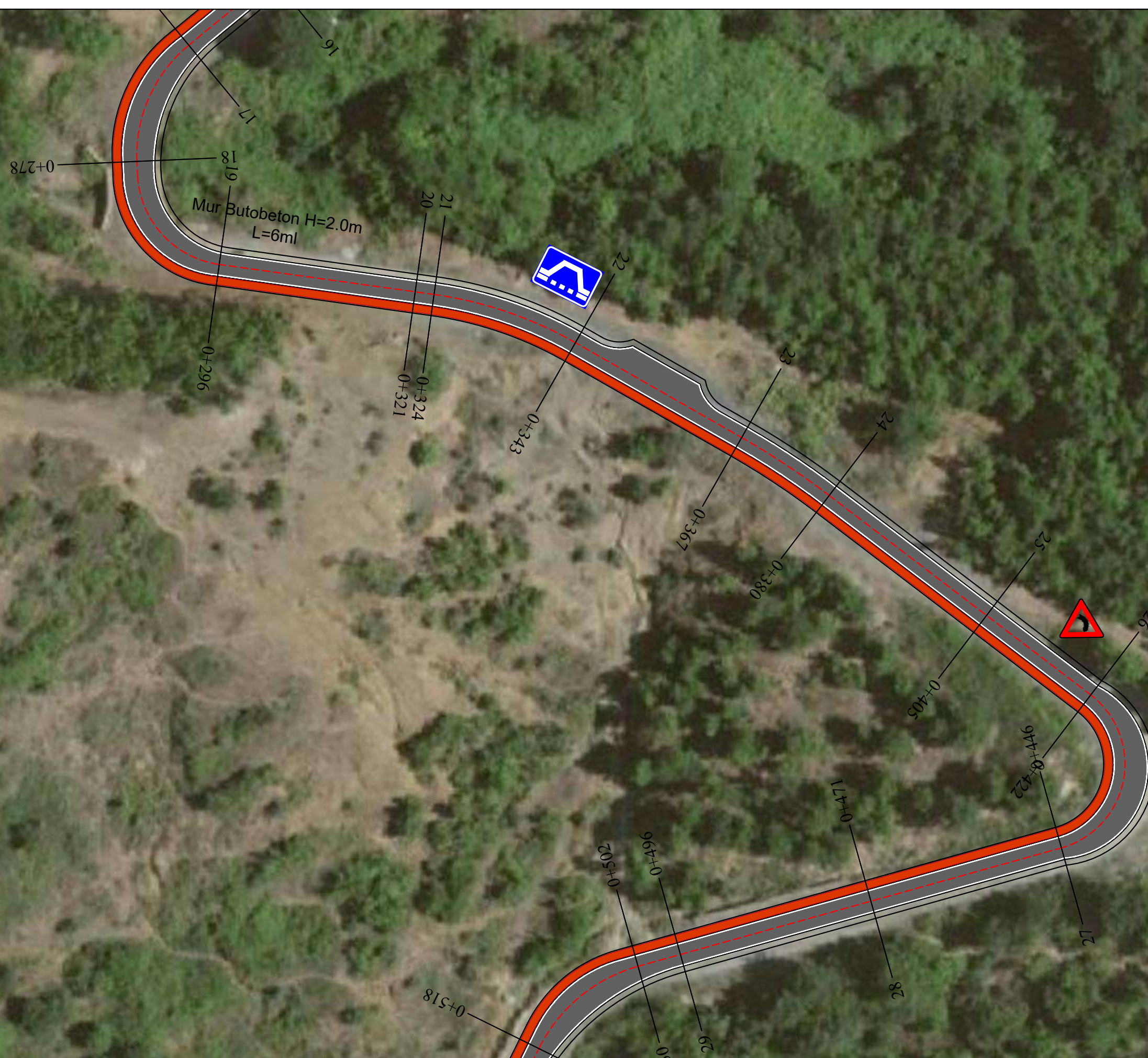

POROSITESI : BASHKIA MAT

OBJEKTI: "Ndertimi i rruges fshati Bater ,bashkia Mat"

Emertimi: Planimetria e sinjalistikes



"Imperium Construction", shpk
 Adresa: njesi Bashkiake nr.9 Rruga "Shyqyri Peza"
 Pallati 21, Hyrja 1,Kati 2 ,Tirane

Drejtues i projektit

Adm. Arber TOLA

Projektues

Inxh. Elton LLAPUSHI	Mek. Bujar MERAJ
Inxh. Ilir Hodaj	Elek. Altin ALLKAJ
Ark. Rigert HYRA	Top. Iv BEQARI

SHKALLA

1- 500

MAT 2022

FLETA

1 - 01

Format A3



POROSITESI : BASHKIA MAT

OBJEKTI: "Ndertimi i rruges fshati Bater ,bashkia Mat"

Emertimi: Planimetria e sinjalistikes



"Imperium Construction", shpk
 Adresa: njesi Bashkiake nr.9 Rruga "Shyqyri Peza"
 Pallati 21, Hyrja 1,Kati 2 ,Tirane

Drejtues i projektit

Adm. Arber TOLA

Projektues

Inxh. Elton LLAPUSHI	Mek. Bujar MERAJ
Inxh. Ilir Hodaj	Elek. Altin ALLKAJ
Ark. Rigert HYRA	Top. Iv BEQARI

SHKALLA

1- 500

MAT 2022

FLETA

1 - 01

Format A3



POROSITESI : BASHKIA MAT

OBJEKTI: "Ndertimi i rruges fshati Bater ,bashkia Mat"

Emertimi: Planimetria e sinjalistikes



"Imperium Construction", shpk
 Adresa: njesi Bashkiake nr.9 Rruga "Shyqyri Peza"
 Pallati 21, Hyrja 1,Kati 2 ,Tirane

Drejtues i projektit

Adm. Arber TOLA

Projektues

Inxh. Elton LLAPUSHI	Mek. Bujar MERAJ
Inxh. Ilir Hodaj	Elek. Altin ALLKAJ
Ark. Rigert HYRA	Top. Iv BEQARI

SHKALLA

1- 500

MAT 2022

FLETA

1 - 01

Format A3

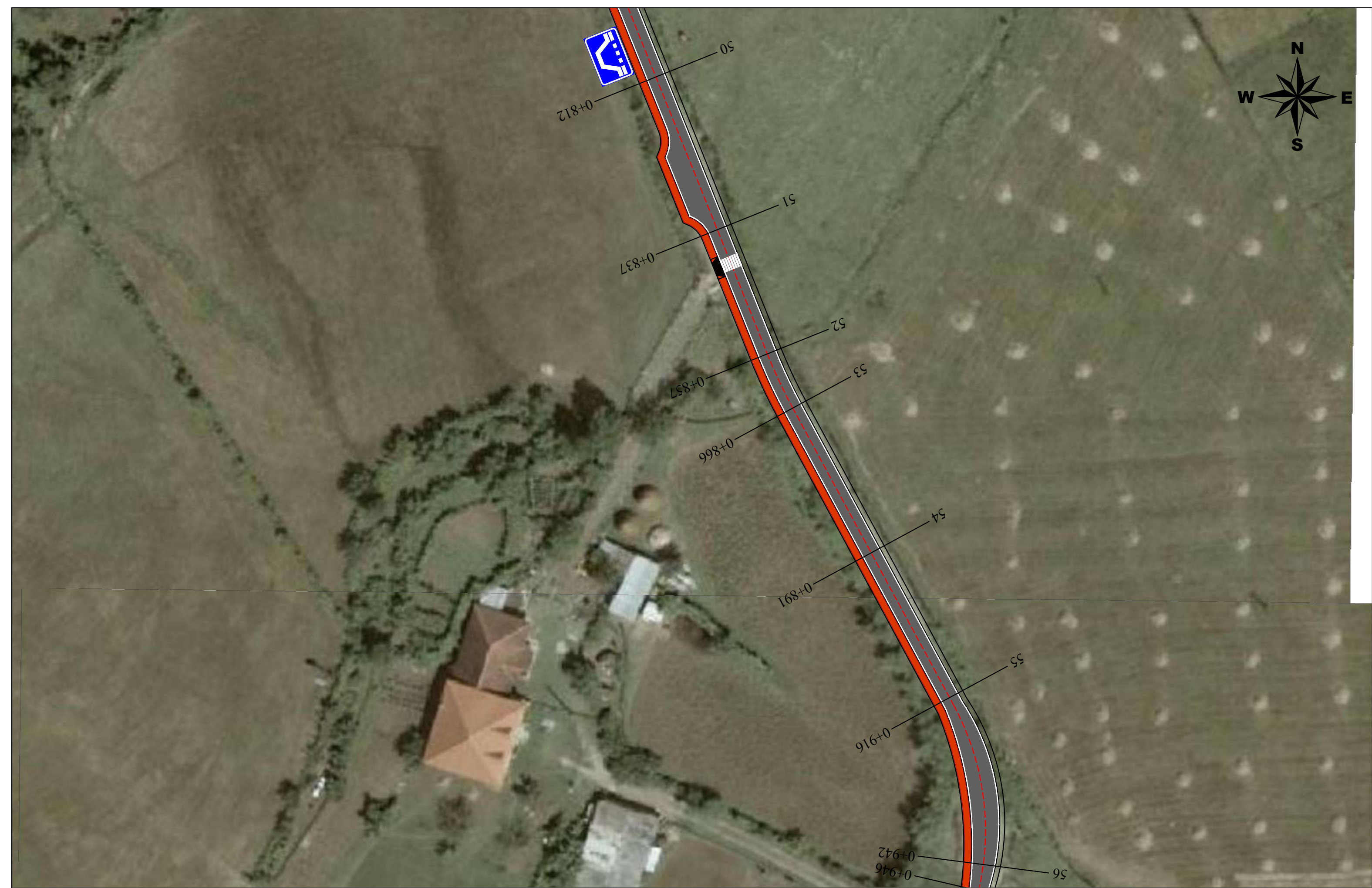

	POROSITESI : BASHKIA MAT
	OBJEKTI: "Ndertimi i rruges fshati Bater ,bashkia Mat"

Emertimi: Planimetria e sinjalistikes	
	"Imperium Construction", shpk
	Adresa: njesi Bashkiake nr.9 Rruga "Shyqyri Peza" Pallati 21, Hyrja 1,Kati 2 ,Tirane

Drejtues i projektit	
Adm. Arber TOLA	

Projektues			
Inxh. Elton LLAPUSHI	Mek. Bujar MERAJ		
Inxh. Ilir Hodaj	Elek. Altin ALLKAJ		
Ark. Rigert HYRA	Top. Iv BEQARI		

SHKALLA	FLETA
1- 500	1 - 01
MAT 2022	Format A3



POROSITESI : BASHKIA MAT

OBJEKTI: "Ndertimi i rruges fshati Bater ,bashkia Mat"

Emertimi: **Planimetria e sinjalistikes**



"Imperium Construction", shpk
 Adresa: njesi Bashkiake nr.9 Rruga "Shyqyri Peza"
 Pallati 21, Hyrja 1,Kati 2 ,Tirane

Drejtues i projektit

Adm. Arber TOLA

Projektues

Inxh. Elton LLAPUSHI	Mek. Bujar MERAJ
Inxh. Ilir Hodaj	Elek. Altin ALLKAJ
Ark. Rigert HYRA	Top. Iv BEQARI

SHKALLA

1- 500

MAT 2022

FLETA

1 - 01

Format A3

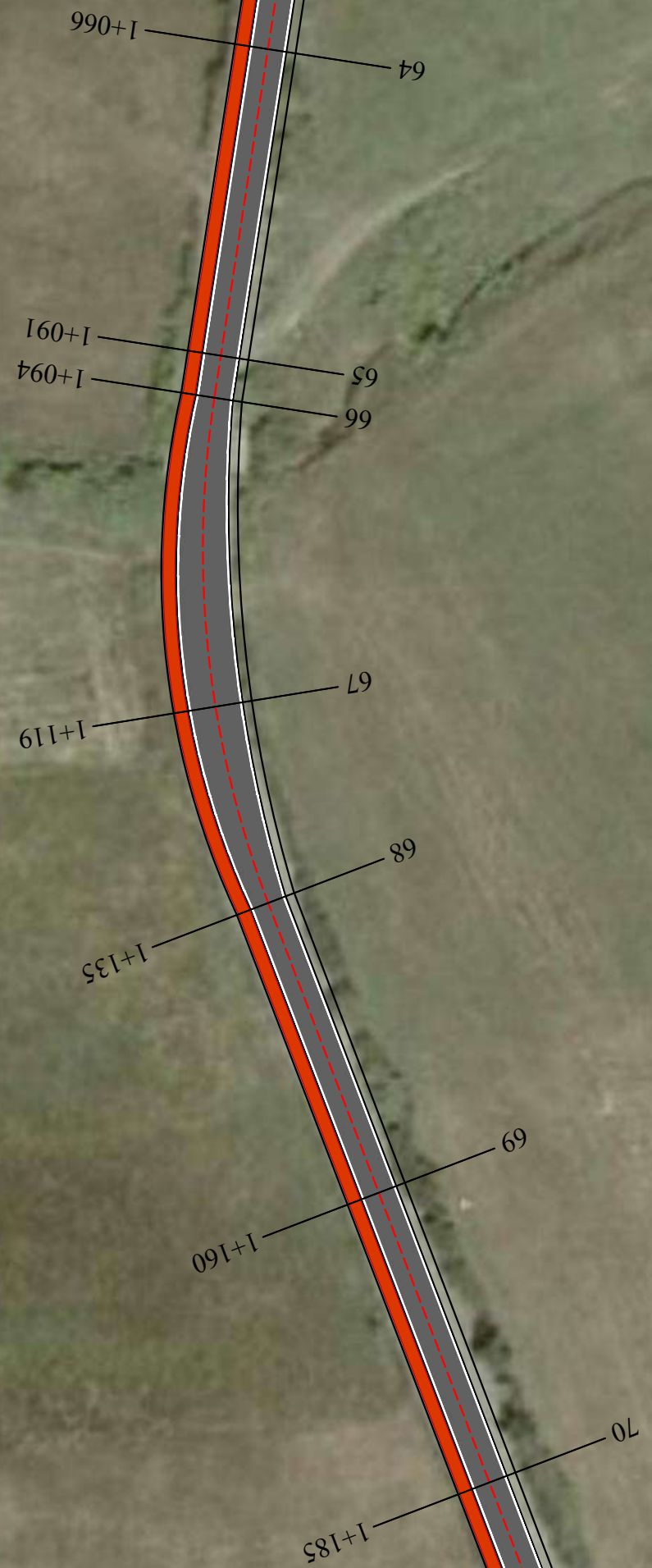

POROSITESI : BASHKIA MAT

OBJEKTI: "Ndertimi i rruges fshati Bater ,bashkia Mat"

Emertimi: Planimetria e sinjalistikes



"Imperium Construction", shpk
 Adresa: njesi Bashkiake nr.9 Rruga "Shyqyri Peza"
 Pallati 21, Hyrja 1,Kati 2 ,Tirane

Drejtues i projektit

Adm. Arber TOLA

Projektues

Inxh. Elton LLAPUSHI	Mek. Bujar MERAJ	
Inxh. Ilir Hodaj	Elek. Altin ALLKAJ	
Ark. Rigert HYRA	Top. Iv BEQARI	

SHKALLA

1- 500

MAT 2022

FLETA

1 - 01

Format A3

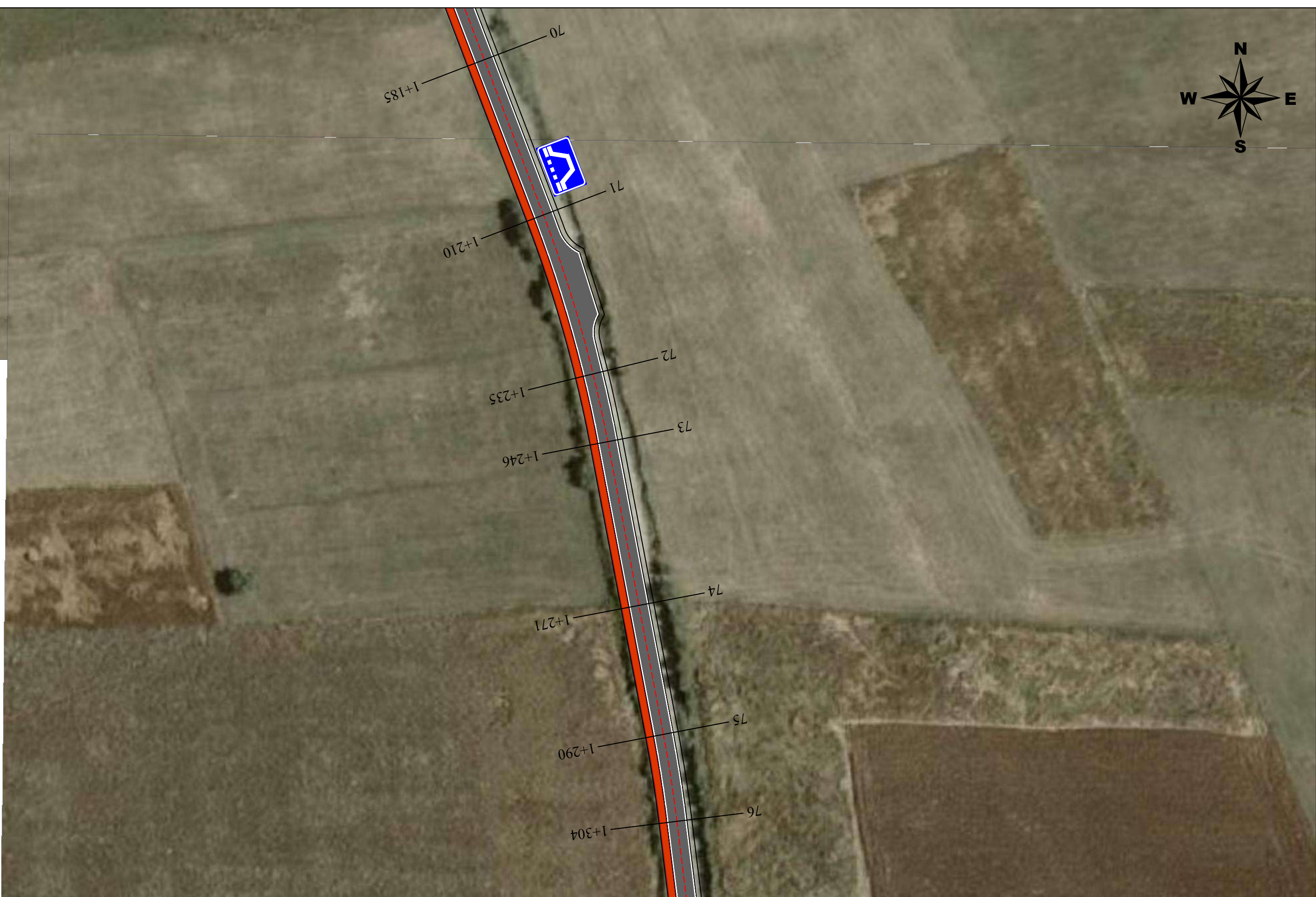

POROSITESI : BASHKIA MAT

OBJEKTI: "Ndertimi i rruges fshati Bater ,bashkia Mat"

Emertimi: Planimetria e sinjalistikes



"Imperium Construction", shpk
 Adresa: njesi Bashkiake nr.9 Rruga "Shyqyri Peza"
 Pallati 21, Hyrja 1,Kati 2 ,Tirane

Drejtues i projektit

Adm. Arber TOLA

Projektues

Inxh. Elton LLAPUSHI	Mek. Bujar MERAJ	
Inxh. Ilir Hodaj	Elek. Altin ALLKAJ	
Ark. Rigert HYRA	Top. Iv BEQARI	

SHKALLA

1- 500

MAT 2022

FLETA

1 - 01

Format A3

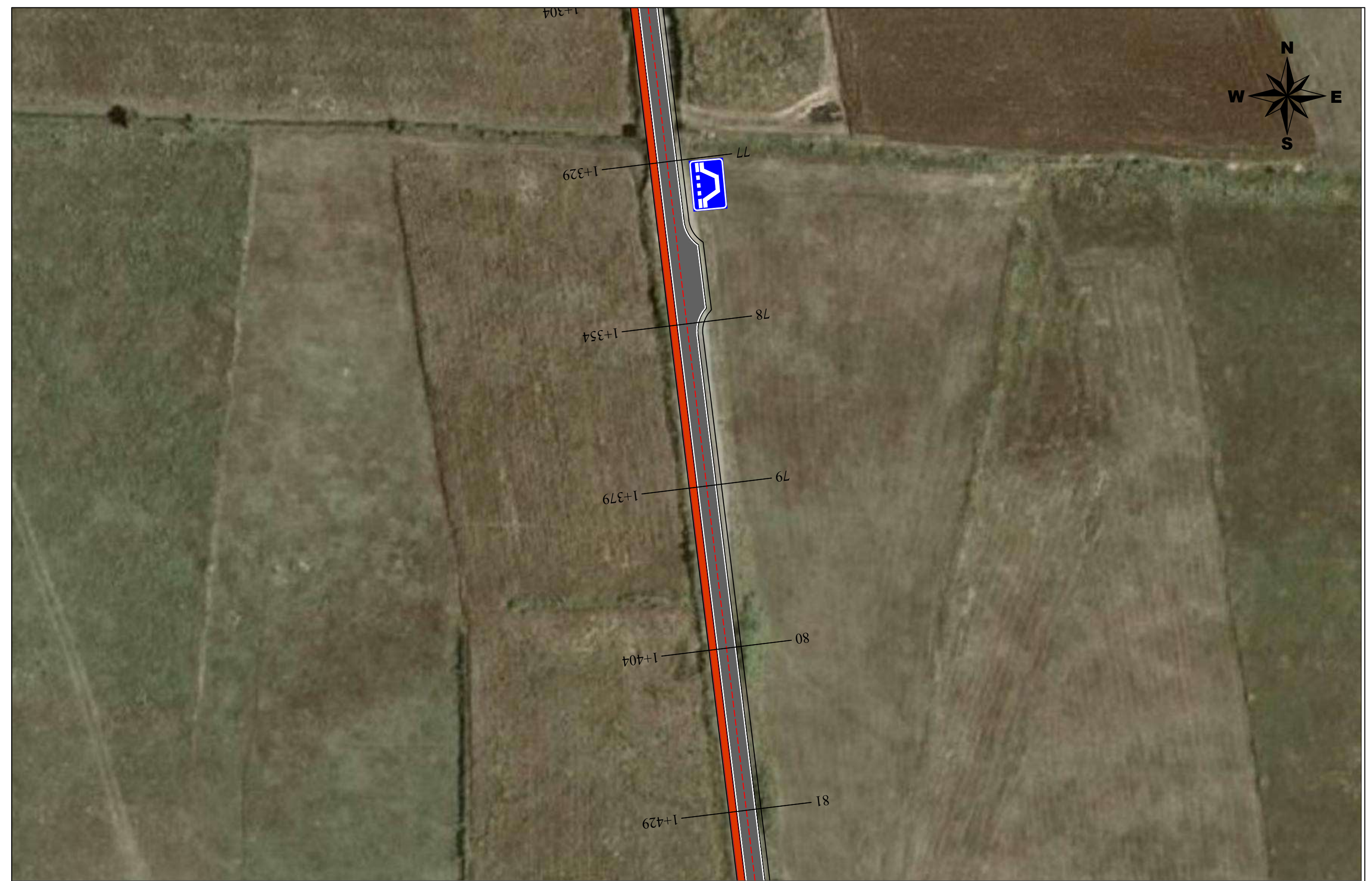

	POROSITESI : BASHKIA MAT
	OBJEKTI: "Ndertimi i rruges fshati Bater ,bashkia Mat"

Emertimi: Planimetria e sinjalistikes	
	"Imperium Construction", shpk
	Adresa: njesi Bashkiake nr.9 Rruga "Shyqyri Peza" Pallati 21, Hyrja 1,Kati 2 ,Tirane

Drejtues i projektit	
Adm. Arber TOLA	

Projektues			
Inxh. Elton LLAPUSHI	Mek. Bujar MERAJ		
Inxh. Ilir Hodaj	Elek. Altin ALLKAJ		
Ark. Rigert HYRA	Top. Iv BEQARI		

SHKALLA	FLETA
1- 500	1 - 01
MAT 2022	Format A3

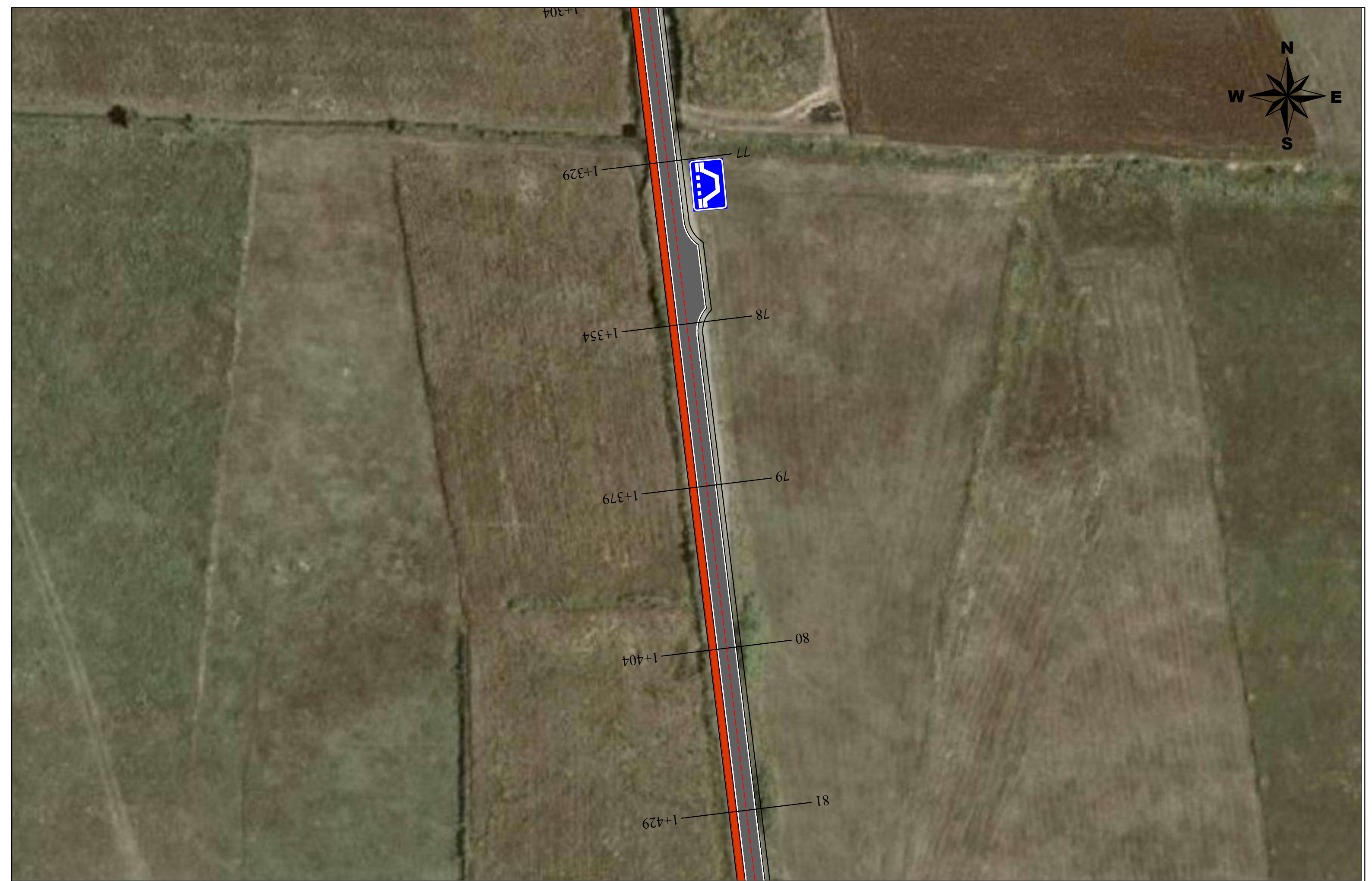

	POROSITESI : BASHKIA MAT
	OBJEKTI: "Ndertimi i rruges fshati Bater ,bashkia Mat"

Emertimi: Planimetria e sinjalistikes	
	"Imperium Construction", shpk
	Adresa: njesi Bashkiake nr.9 Rruga "Shyqyri Peza" Pallati 21, Hyrja 1,Kati 2 ,Tirane

Drejtues i projektit	
Adm. Arber TOLA	

Projektues			
Inxh. Elton LLAPUSHI	Mek. Bujar MERAJ		
Inxh. Ilir Hodaj	Elek. Altin ALLKAJ		
Ark. Rigert HYRA	Top. Iv BEQARI		

SHKALLA	FLETA
1- 500	1 - 01
MAT 2022	Format A3

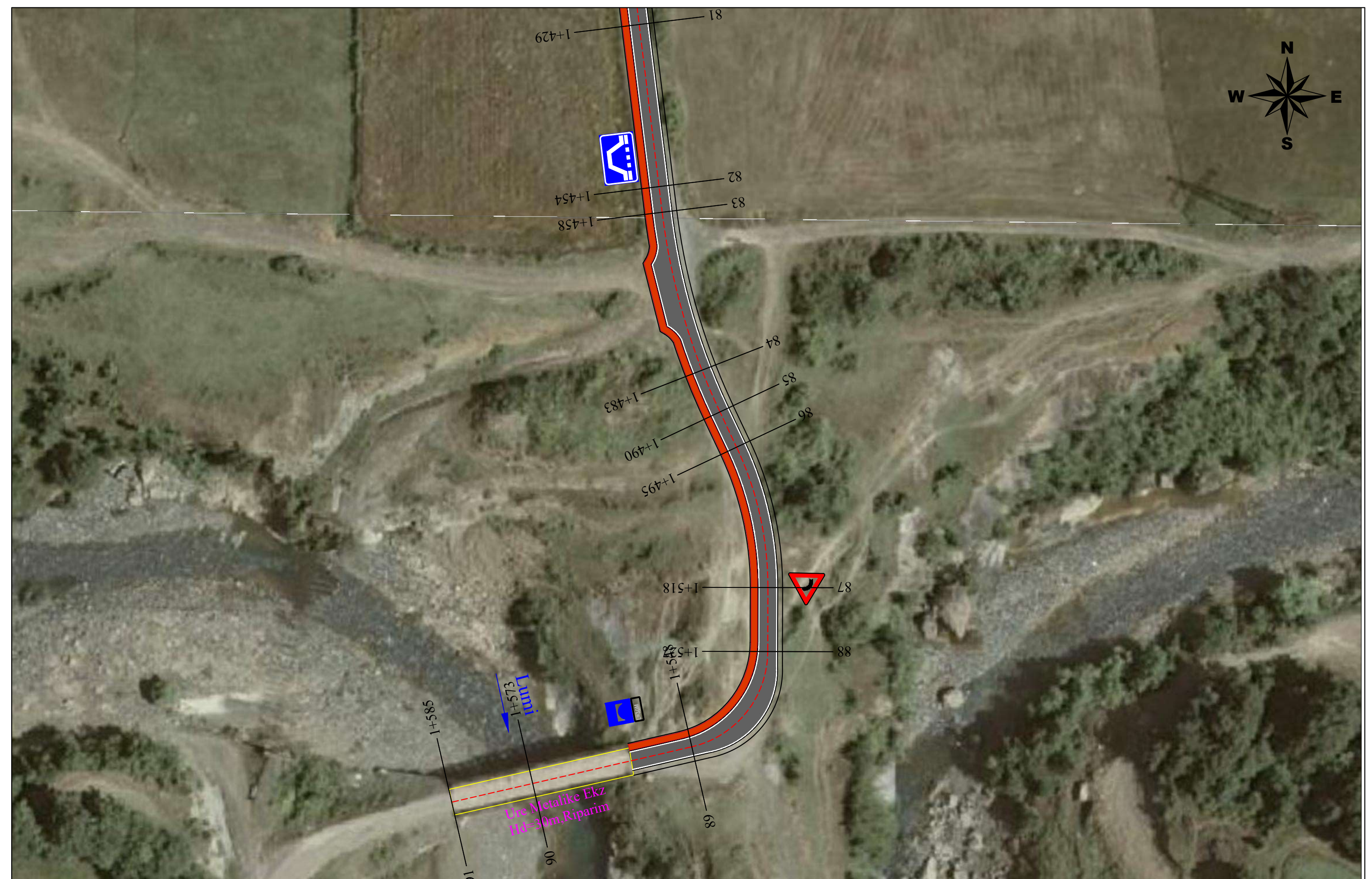

POROSITESI : BASHKIA MAT

OBJEKTI: "Ndertimi i rruges fshati Bater ,bashkia Mat"

Emertimi: Planimetria e sinjalistikes



"Imperium Construction", shpk
Adresa: njesi Bashkiake nr.9 Rruga "Shyqyri Peza"
Pallati 21, Hyrja 1,Kati 2 ,Tirane

Drejtues i projektit

Adm. Arber TOLA

Projektues

Inxh. Elton LLAPUSHI	Mek. Bujar MERAJ
Inxh. Ilir Hodaj	Elek. Altin ALLKAJ
Ark. Rigert HYRA	Top. Iv BEQARI

SHKALLA

1- 500

MAT 2022

FLETA

1 - 01

Format A3







REPUBLIKA E SHQIPERISË
BASHKIA MAT

PROJEKT ZBATIMI

OBJEKTI:

Ndertimi i rruges fshati Bater, bashkia Mat
Planimetria e ndricimit

LEGJENDA

-  Shtylle ndricimi
-  Pusete kontrolli
-  Tub Fleksibel elektriku
-  Tub fleksibel telefoni
-  Tub fleksibel me dy shtresa



POROSITESI : BASHKIA MAT

OBJEKTI: "Ndertimi i rruges fshati Bater ,bashkia Mat"

Emertimi: Planimetria e ndricimit



"Imperium Construction", shpk
Adresa: njesi Bashkiake nr.9 Rruga "Shyqyri Peza"
Pallati 21, Hyrja 1,Kati 2 ,Tirane

Drejtues i projektit

Adm. Arber TOLA

Projektues

Inxh. Elton LLAPUSHI	Mek. Bujar MERAJ
Inxh. Ilir Hodaj	Elek. Altin ALLKAJ
Ark. Rigert HYRA	Top. Iv BEQARI

SHKALLA

1- 500

MAT 2022

FLETA

1 - 01

Format A3

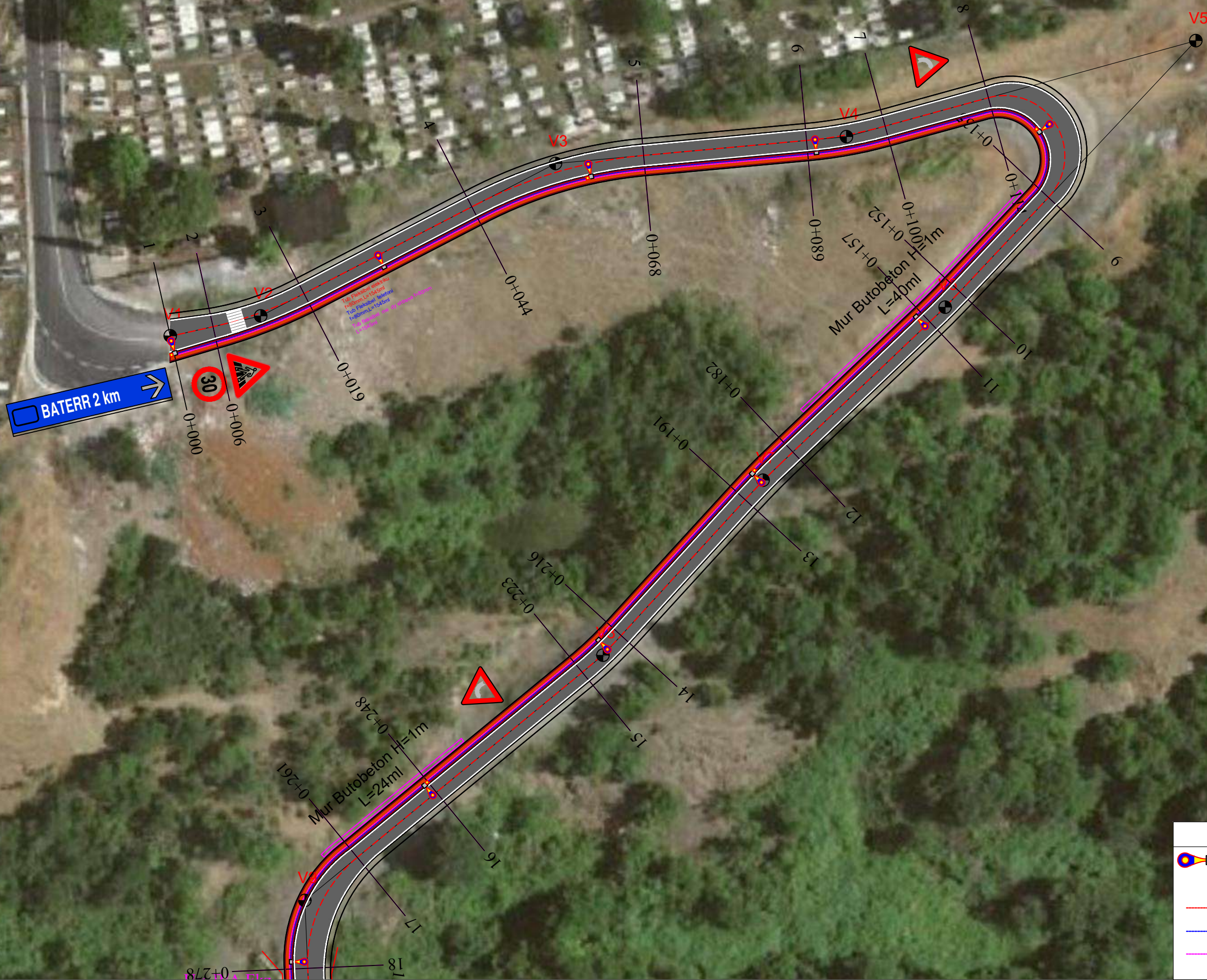

LEGJENDA	
	Shtylle ndricimi
	Pusete kontrolli
	Tub Fleksibel elektriku
	Tub fleksibel telefoni
	Tub fleksibel me dy shtresa

POROSITESI : BASHKIA MAT
 OBJEKTI: "Ndertimi i rruges fshati Bater ,bashkia Mat"

Emertimi: **Planimetria e ndricimit**

"Imperium Construction", shpk
 Adresa: njesi Bashkiake nr.9 Rruga "Shyqyri Peza"
 Pallati 21, Hyrja 1,Kati 2 ,Tirane

Drejtues i projektit
 Adm. Arber TOLA

Projektues	
Inxh. Elton LLAPUSHI	Mek. Bujar MERAJ
Inxh. Ilir Hodaj	Elek. Altin ALLKAJ
Ark. Rigert HYRA	Top. Iv BEQARI

SHKALLA	FLETA
1- 500	1 - 01
MAT 2022	Format A3

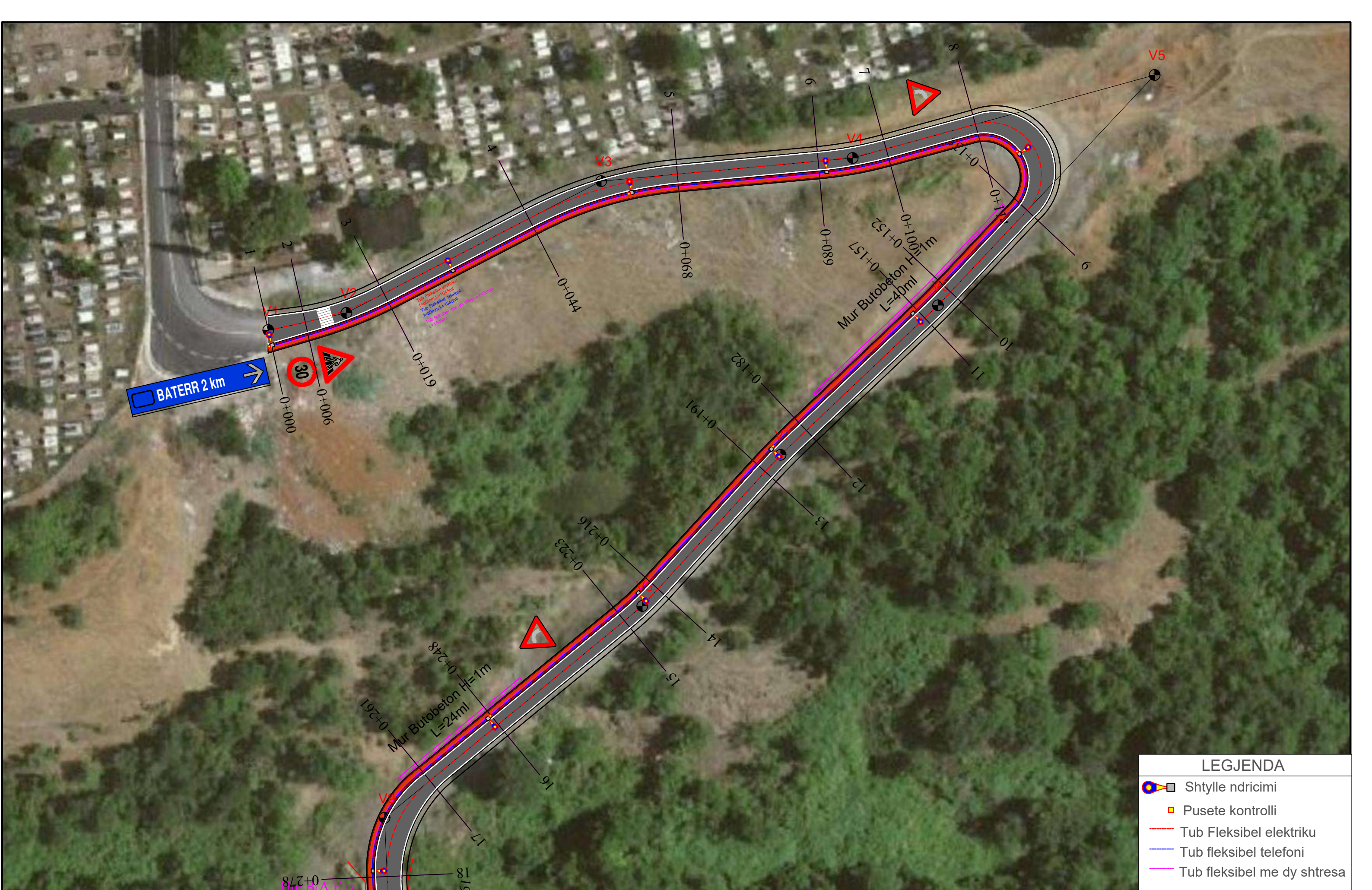

LEGJENDA	
	Shtylle ndricimi
	Pusete kontrolli
	Tub Fleksibel elektrik
	Tub fleksibel telefoni
	Tub fleksibel me dy shtresa

	POROSITESI : BASHKIA MAT OBJEKTI: "Ndertimi i rruges fshati Bater ,bashkia Mat"	Emertimi: Planimetria e ndricimit "Imperium Construction", shpk Adresa: njesi Bashkiake nr.9 Rruga "Shyqyri Peza" Pallati 21, Hyrja 1,Kati 2 ,Tirane	Drejtues i projektit Adm. Arber TOLA	Projektues Inxh. Elton LLAPUSHI Inxh. Ilir Hodaj Ark. Rigert HYRA	Mek. Bujar MERAJ Elek. Altin ALLKAJ Top. Iv BEQARI	SHKALLA 1- 500 MAT 2022	FLETA 1 - 01 Format A3
--	---	--	---	--	--	-------------------------------	------------------------------

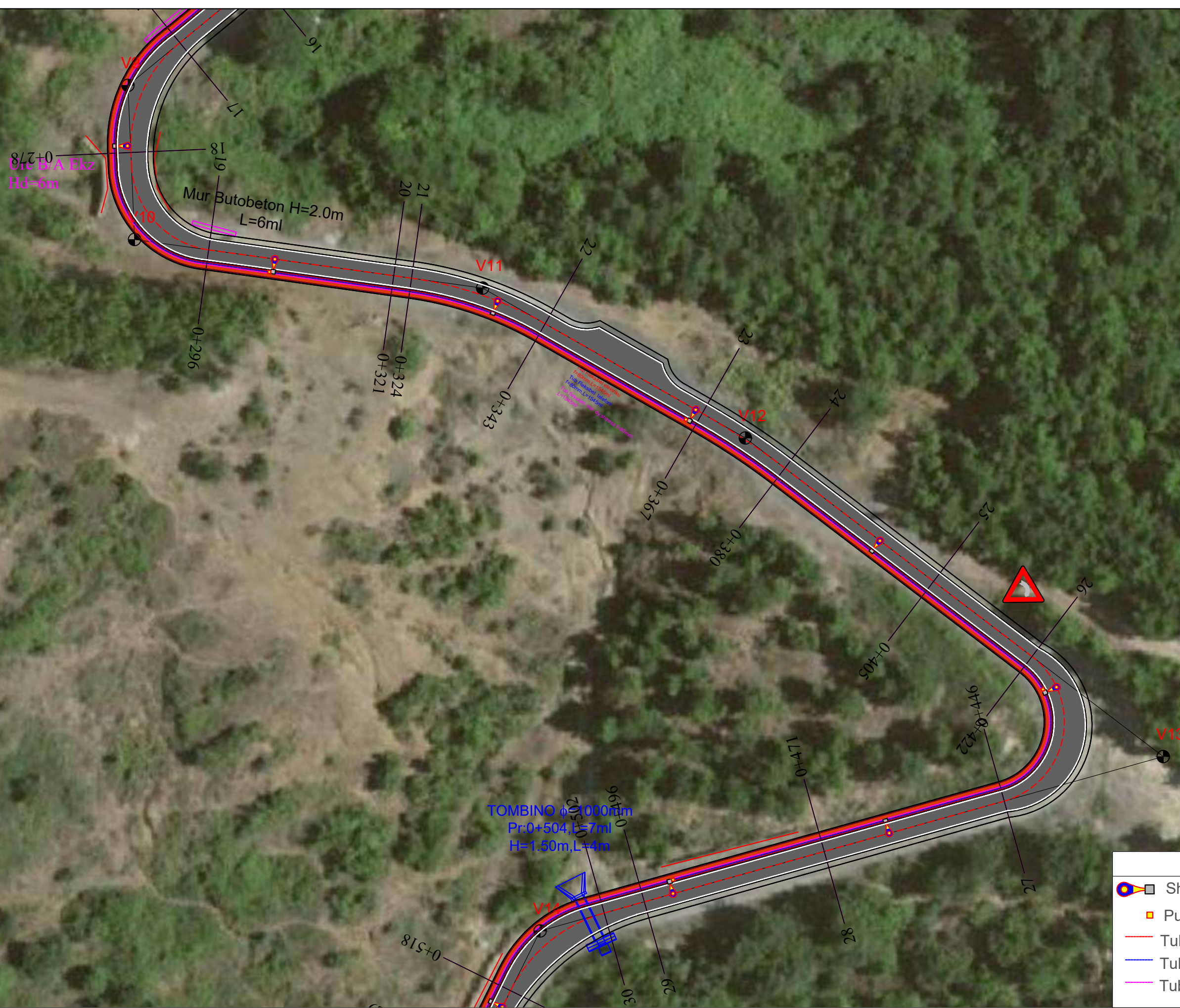

POROSITESI : BASHKIA MAT

OBJEKTI: "Ndertimi i rruges fshati Bater ,bashkia Mat"

Emertimi: **Planimetria e ndricimit**

“Imperium Construction”, shpk
 Adresa: njesi Bashkiake nr.9 Rruga "Shyqyri Peza"
 Pallati 21, Hyrja 1,Kati 2 ,Tirane

Drejtues i projektit

Adm. Arber TOLA

Projektues	
Inxh. Elton LLAPUSHI	Mek. Bujar MERAJ
Inxh. Ilir Hodaj	Elek. Altin ALLKAJ
Ark. Rigert HYRA	Top. Iv BEQARI

SHKALLA	FLETA
1- 500	1 - 01
MAT 2022	Format A3



LEGJENDA	
	Shtylle ndricimi
	Pusete kontrolli
	Tub Fleksibel elektriku
	Tub fleksibel telefoni
	Tub fleksibel me dy shtresa

POROSITESI : BASHKIA MAT
 OBJEKTI: "Ndertimi i rruges fshati Bater ,bashkia Mat"

Emertimi: **Planimetria e ndricimit**
 "Imperium Construction", shpk
 Adresa: njesi Bashkiake nr.9 Rruga "Shyqyri Peza"
 Pallati 21, Hyrja 1,Kati 2 ,Tirane



Drejtues i projektit
 Adm. Arber TOLA

Projektues	
Inxh. Elton LLAPUSHI	Mek. Bujar MERAJ
Inxh. Ilir Hodaj	Elek. Altin ALLKAJ
Ark. Rigert HYRA	Top. Iv BEQARI

SHKALLA	FLETA
1- 500	1 - 01
MAT 2022	Format A3



LEGJENDA	
	Shtylle ndricimi
	Pusete kontrolli
	Tub Fleksibel elektriku
	Tub fleksibel telefoni
	Tub fleksibel me dy shtresa

	POROSITESI : BASHKIA MAT
	OBJEKTI: "Ndertimi i rruges fshati Bater ,bashkia Mat"

Emertimi: Planimetria e ndricimit
"Imperium Construction", shpk Adresa: njesi Bashkiake nr.9 Rruga "Shyqyri Peza" Pallati 21, Hyrja 1,Kati 2 ,Tirane

Drejtues i projektit	Projektues		
Adm. Arber TOLA	Inxh. Elton LLAPUSHI	Mek. Bujar MERAJ	
	Inxh. Ilir Hodaj	Elek. Altin ALLKAJ	
	Ark. Rigert HYRA	Top. Iv BEQARI	

SHKALLA	FLETA
1- 500	1 - 01
MAT 2022	Format A3



LEGJENDA	
	Shtylle ndricimi
	Pusete kontrolli
	Tub Fleksibel elektriku
	Tub fleksibel telefoni
	Tub fleksibel me dy shtresa

V24
TOMBINO $\phi=1000\text{mm}$
 Pr:0+937,L=7ml
 H=1.50m,L=4m

	POROSITESI : BASHKIA MAT
	OBJEKTI: "Ndertimi i rruges fshati Bater ,bashkia Mat"

Emertimi: Planimetria e ndricimit
"Imperium Construction", shpk Adresa: njesi Bashkiake nr.9 Rruga "Shyqyri Peza" Pallati 21, Hyrja 1,Kati 2 ,Tirane

Drejtues i projektit
Adm. Arber TOLA

Projektues	
Inxh. Elton LLAPUSHI	Mek. Bujar MERAJ
Inxh. Ilir Hodaj	Elek. Altin ALLKAJ
Ark. Rigert HYRA	Top. Iv BEQARI

SHKALLA	FLETA
1- 500	1 - 01
MAT 2022	Format A3



LEGJENDA	
	Shtylle ndricimi
	Pusete kontrolli
	Tub Fleksibel elektriku
	Tub fleksibel telefoni
	Tub fleksibel me dy shtresa



POROSITESI : BASHKIA MAT

OBJEKTI: "Ndertimi i rruges fshati Bater ,bashkia Mat"

Emertimi: Planimetria e ndricimit



"Imperium Construction", shpk
 Adresa: njesi Bashkiake nr.9 Rruga "Shyqyri Peza"
 Pallati 21, Hyrja 1,Kati 2 ,Tirane

Drejtues i projektit

Adm. Arber TOLA

Projektues

Inxh. Elton LLAPUSHI	Mek. Bujar MERAJ
Inxh. Ilir Hodaj	Elek. Altin ALLKAJ
Ark. Rigert HYRA	Top. Iv BEQARI

SHKALLA

1- 500

MAT 2022

FLETA

1 - 01

Format A3

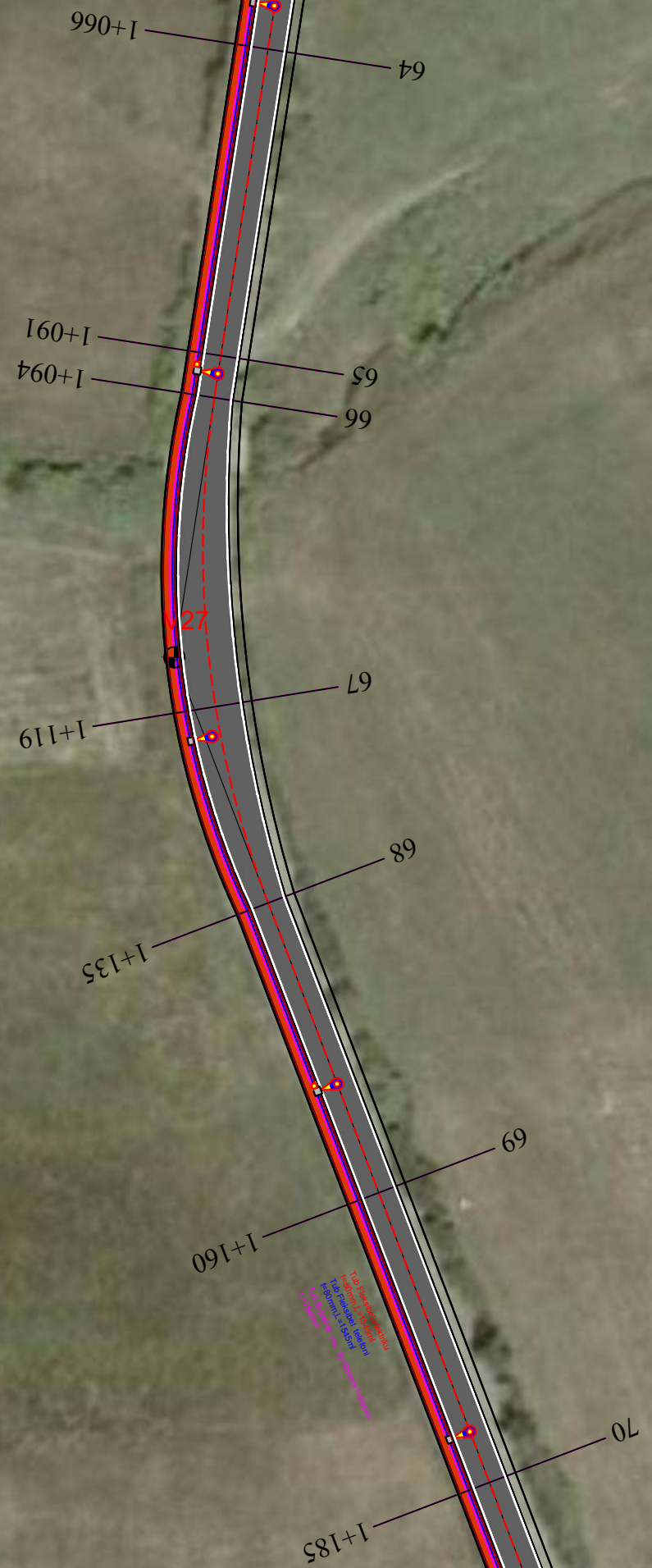

LEGJENDA	
	Shtylle ndricimi
	Pusete kontrolli
	Tub Fleksibel elektriku
	Tub fleksibel telefoni
	Tub fleksibel me dy shtresa

	POROSITESI : BASHKIA MAT
	OBJEKTI: "Ndertimi i rruges fshati Bater ,bashkia Mat"

Emertimi: Planimetria e ndricimit
"Imperium Construction", shpk Adresa: njesi Bashkiake nr.9 Rruga "Shyqyri Peza" Pallati 21, Hyrja 1,Kati 2 ,Tirane

Drejtues i projektit
Adm. Arber TOLA

Projektues	
Inxh. Elton LLAPUSHI	Mek. Bujar MERAJ
Inxh. Ilir Hodaj	Elek. Altin ALLKAJ
Ark. Rigert HYRA	Top. Iv BEQARI

SHKALLA	FLETA
1- 500	1 - 01
MAT 2022	Format A3



LEGJENDA	
	Shtylle ndricimi
	Pusete kontrolli
	Tub Fleksibel elektriku
	Tub fleksibel telefoni
	Tub fleksibel me dy shtresa



POROSITESI : BASHKIA MAT

OBJEKTI: "Ndertimi i rruges fshati Bater ,bashkia Mat"

Emertimi: Planimetria e ndricimit



"Imperium Construction", shpk
 Adresa: njesi Bashkiake nr.9 Rruga "Shyqyri Peza"
 Pallati 21, Hyrja 1,Kati 2 ,Tirane

Drejtues i projektit

Adm. Arber TOLA

Projektues

Inxh. Elton LLAPUSHI	Mek. Bujar MERAJ
Inxh. Ilir Hodaj	Elek. Altin ALLKAJ
Ark. Rigert HYRA	Top. Iv BEQARI

SHKALLA

1- 500

MAT 2022

FLETA

1 - 01

Format A3



TOMBINO $\phi=1000\text{mm}$
 Pr:1+321,L=7ml
 H=1.50m,L=4m

77
 1+329

78
 1+354

79
 1+379

80
 1+404

81
 1+429

LEGJENDA	
	Shtylle ndricimi
	Pusete kontrolli
	Tub Fleksibel elektriku
	Tub fleksibel telefoni
	Tub fleksibel me dy shtresa

POROSITESI : BASHKIA MAT

OBJEKTI: "Ndertimi i rruges fshati Bater ,bashkia Mat"

Emertimi: **Planimetria e ndricimit**

“Imperium Construction”, shpk
 Adresa: njesi Bashkiake nr.9 Rruga “Shyqyri Peza”
 Pallati 21, Hyrja 1,Kati 2 ,Tirane

Drejtues i projektit

Adm. Arber TOLA

Projektues	
Inxh. Elton LLAPUSHI	Mek. Bujar MERAJ
Inxh. Ilir Hodaj	Elek. Altin ALLKAJ
Ark. Rigert HYRA	Top. Iv BEQARI

SHKALLA	FLETA
1- 500	1 - 01
MAT 2022	Format A3

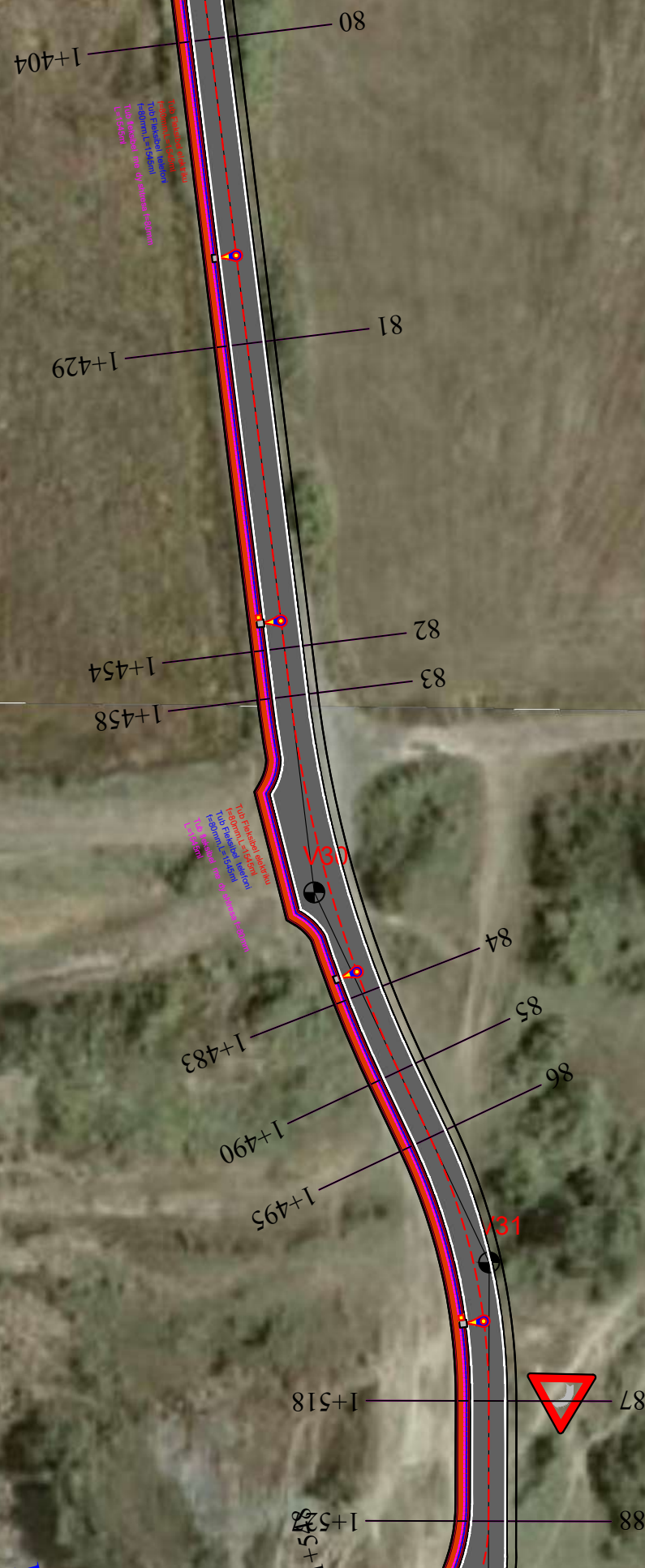

LEGJENDA	
	Shtylle ndricimi
	Pusete kontrolli
	Tub Fleksibel elektriku
	Tub fleksibel telefoni
	Tub fleksibel me dy shtresa

POROSITESI : BASHKIA MAT

OBJEKTI: "Ndertimi i rruges fshati Bater ,bashkia Mat"

Emertimi: **Planimetria e ndricimit**

“Imperium Construction”, shpk
 Adresa: njesi Bashkiake nr.9 Rruga "Shyqyri Peza"
 Pallati 21, Hyrja 1,Kati 2 ,Tirane

Drejtues i projektit

Adm. Arber TOLA

Projektues	
Inxh. Elton LLAPUSHI	Mek. Bujar MERAJ
Inxh. Ilir Hodaj	Elek. Altin ALLKAJ
Ark. Rigert HYRA	Top. Iv BEQARI

SHKALLA	FLETA
1- 500	1 - 01
MAT 2022	Format A3

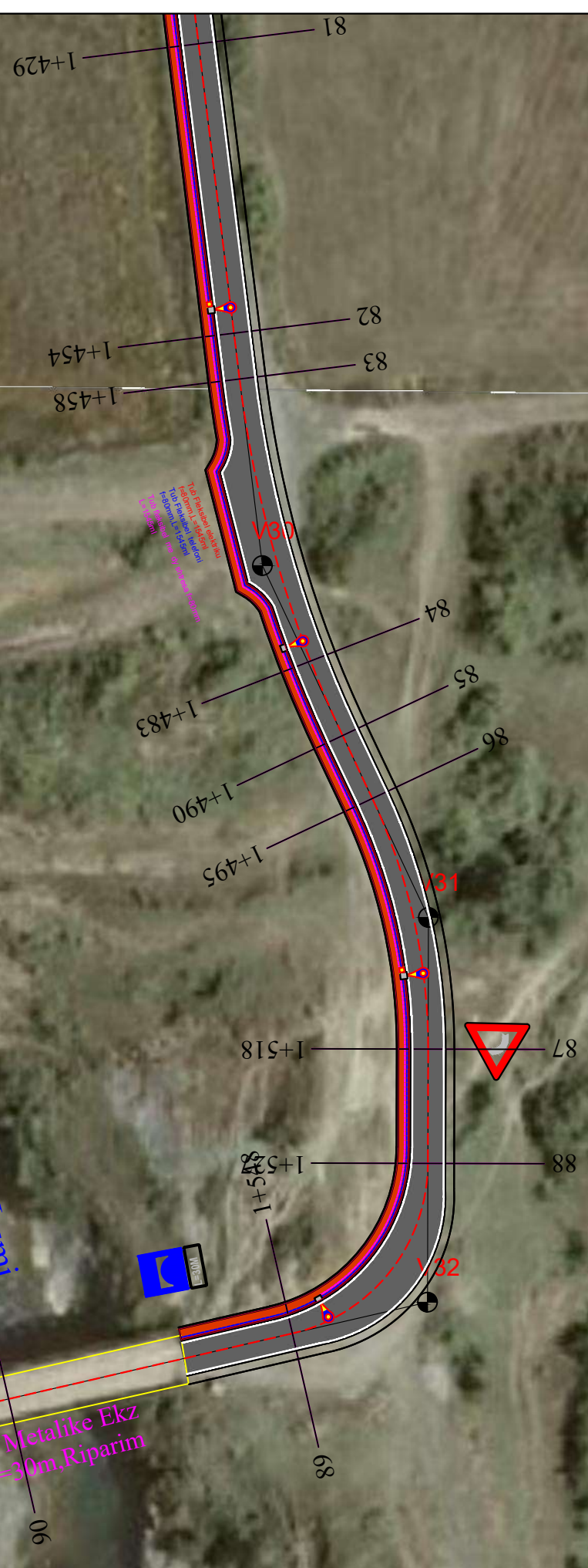

LEGJENDA	
	Shtylle ndricimi
	Pusete kontrolli
	Tub Fleksibel elektriku
	Tub fleksibel telefoni
	Tub fleksibel me dy shtresa



POROSITESI : BASHKIA MAT

OBJEKTI: "Ndertimi i rruges fshati Bater ,bashkia Mat"

Emertimi: Planimetria e ndricimit



"Imperium Construction", shpk
Adresa: njesi Bashkiake nr.9 Rruga "Shyqyri Peza"
Pallati 21, Hyrja 1,Kati 2 ,Tirane

Drejtues i projektit

Adm. Arber TOLA

Projektues

Inxh. Elton LLAPUSHI	Mek. Bujar MERAJ
Inxh. Ilir Hodaj	Elek. Altin ALLKAJ
Ark. Rigert HYRA	Top. Iv BEQARI

SHKALLA

1- 500

MAT 2022

FLETA

1 - 01

Format A3



REPUBLIKA E SHQIPERISË
BASHKIA MAT

PROJEKT ZBATIMI

OBJEKTI:

Ndertimi i rruges fshati Bater, bashkia Mat
Profili gjatesor i rruges

	POROSITESI : BASHKIA MAT	Emertimi: Kapaku	Drejtues i projektit	Projektues		SHKALLA	FLETA
	OBJEKTI: "Ndertimi i rruges fshati Bater ,bashkia Mat"	 "Imperium Construction", shpk Adresa: njesi Bashkiake nr.9 Rruga "Shyqyri Peza" Pallati 21, Hyrja 1,Kati 2 ,Tirane	Adm. Arber TOLA	Inxh. Elton LLAPUSHI	Mek. Bujar MERAJ	Sh H 1-1000	1 - 01
				Inxh. Ilir Hodaj	Elek. Altin ALLKAJ	Sh V 1-100	
				Ark. Rigert HYRA	Top. Iv BEQARI	MAT 2022	Format A3

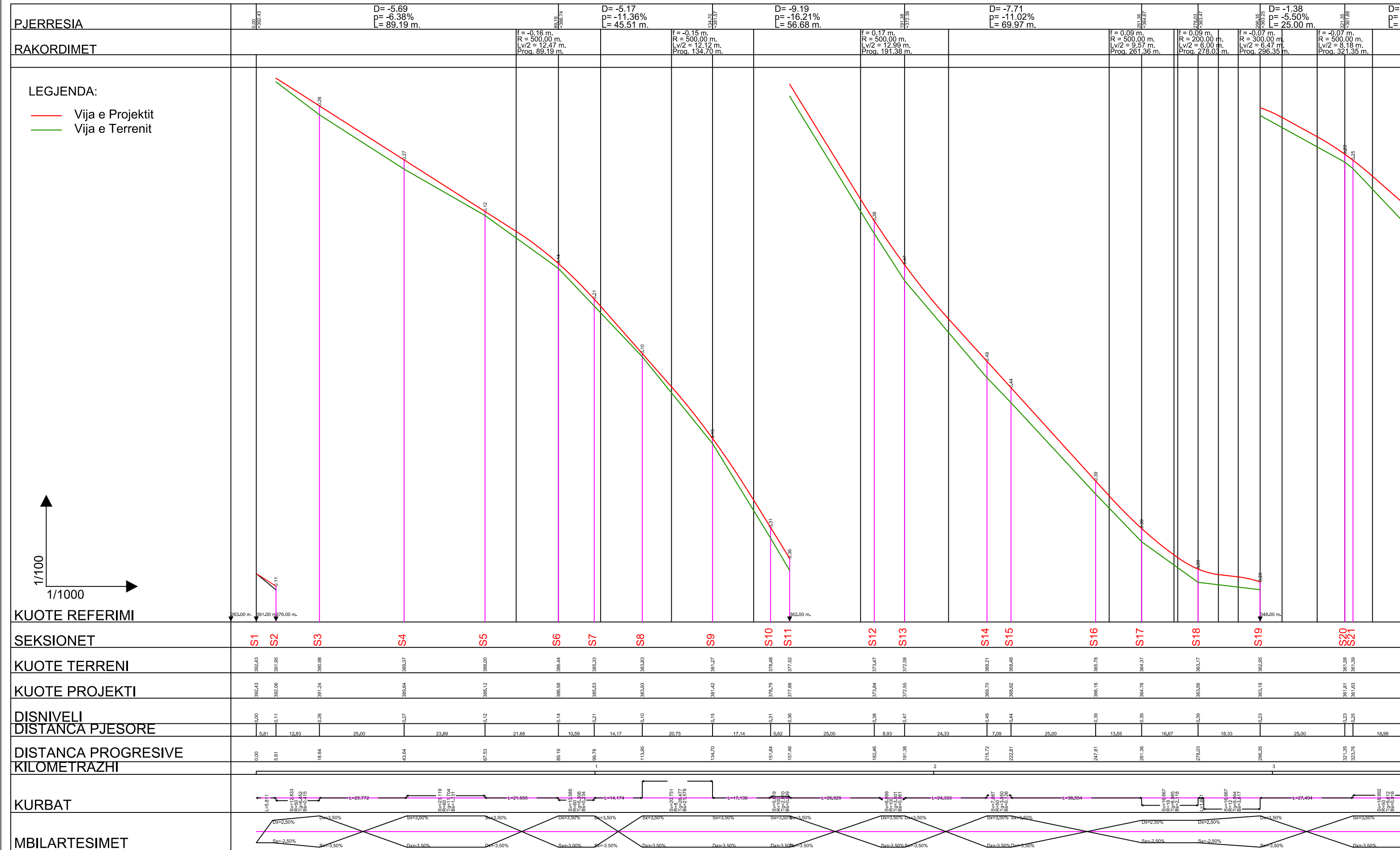

	POROSITESI : BASHKIA MAT OBJEKTI: "Ndertimi i rruges fshati Bater ,bashkia Mat"	Emertimi: Profili gjatesor "Imperium Construction", shpk Adresa: njesi Bashkiake nr.9 Rruga "Shyqyri Peza" Pallati 21, Hyrja 1,Kati 2 ,Tirane	Drejtues i projektit Adm. Arber TOLA	Projektues Inxh. Elton LLAPUSHI Inxh. Ilir Hodaj Ark. Rigert HYRA	Mek. Bujar MERAJ Elek. Altin ALLKAJ Top. Iv BEQARI	SHKALLA Sh H 1-1000 Sh V 1-100 MAT 2022	FLETA 1 - 01 Format A3
--	---	---	---	--	--	---	-------------------------------------

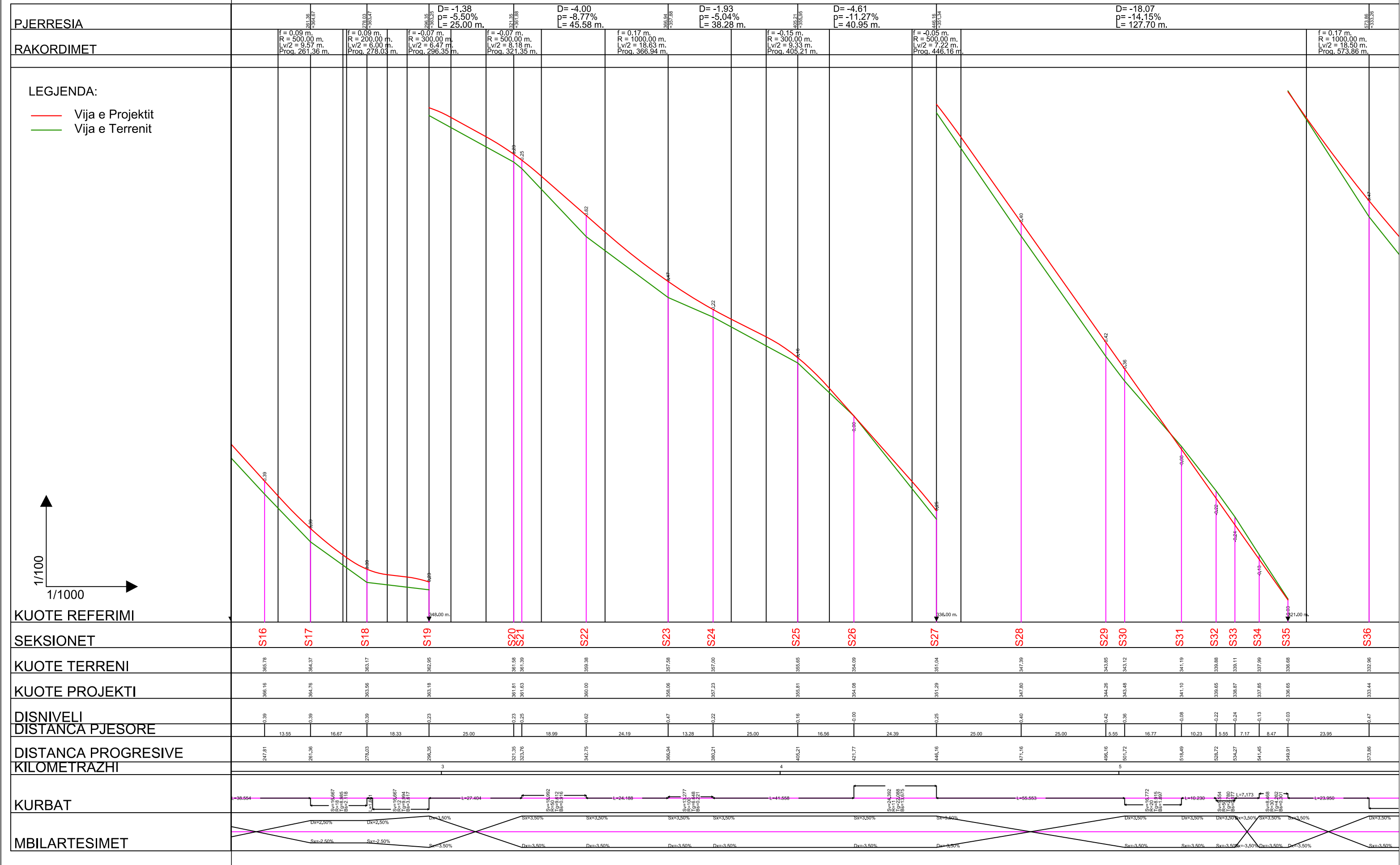

POROSITESI : BASHKIA MAT

OBJEKTI: "Ndertimi i rruges fshati Bater ,bashkia Mat"

Emertimi: Profili gjatesor

“Imperium Construction”, shpk

Adresa: njesi Bashkiake nr.9 Rruga “Shyqyri Peza”

Pallati 21, Hyrja 1,Kati 2 ,Tirane

Drejtues i projektit

Adm. Arber TOLA

Projektues

Inxh. Elton LLAPUSHI	Mek. Bujar MERAJ
Inxh. Ilir Hodaj	Elek. Altin ALLKAJ
Ark. Rigert HYRA	Top. Iv BEQARI

SHKALLA	FLETA
Sh H 1-1000	1 - 01
Sh V 1-100	
MAT 2022	Format A3

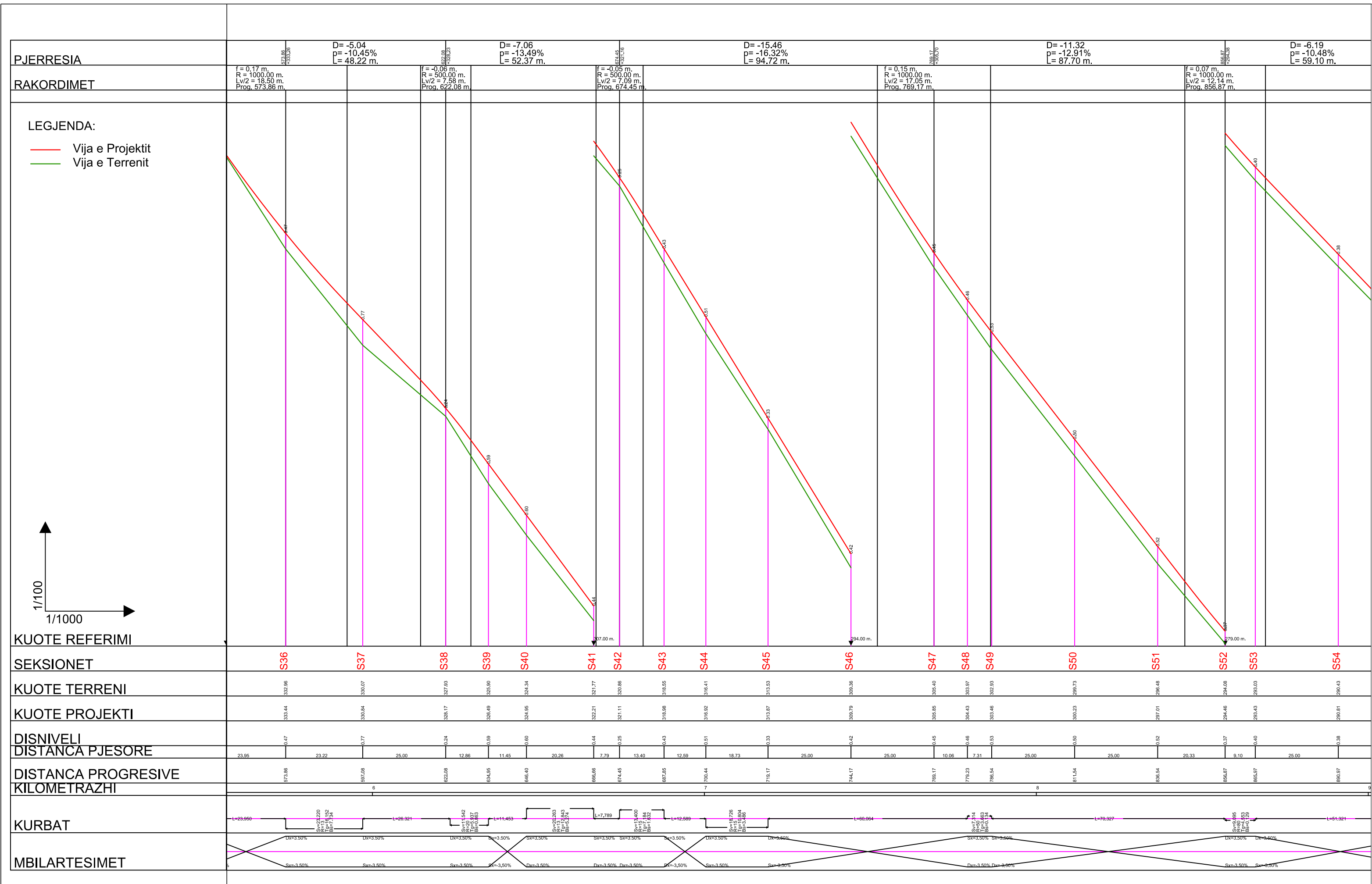

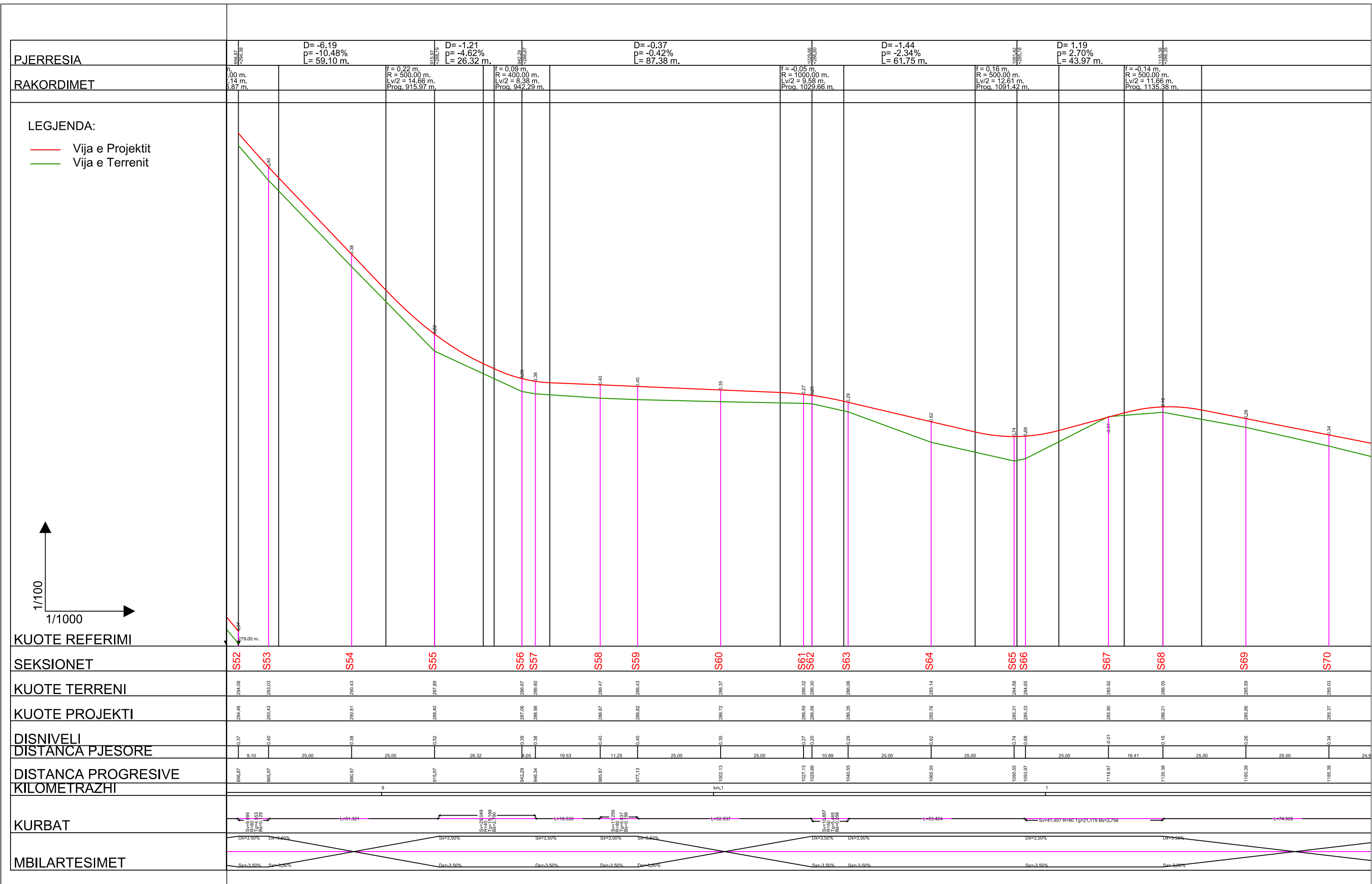

	POROSITESI : BASHKIA MAT	Emertimi: Profili gjatesor “Imperium Construction”, shpk Adresa: njesi Bashkiake nr.9 Rruga “Shyqyri Peza” Pallati 21, Hyrja 1,Kati 2 ,Tirane	Drejtues i projektit Adm. Arber TOLA	Projektues		SHKALLA Sh H 1-1000 Sh V 1-100 MAT 2022	FLETA 1 - 01 Format A3
	OBJEKTI: "Ndertimi i rruges fshati Bater ,bashkia Mat"			Inxh. Elton LLAPUSHI Inxh. Ilir Hodaj Ark. Rigert HYRA	Mek. Bujar MERAJ Elek. Altin ALLKAJ Top. Iv BEQARI		



	POROSITESI : BASHKIA MAT OBJEKTI: "Ndertimi i rruges fshati Bater ,bashkia Mat"	Emertimi: Profili gjatesor "Imperium Construction", shpk Adresa: njesi Bashkiake nr.9 Rruga "Shyqyri Peza" Pallati 21, Hyrja 1,Kati 2 ,Tirane	Drejtues i projektit Adm. Arber TOLA	Projektues Inxh. Elton LLAPUSHI Inxh. Ilir Hodaj Ark. Rigert HYRA	Mek. Bujar MERAJ Elek. Altin ALLKAJ Top. Iv BEQARI	SHKALLA Sh H 1-1000 Sh V 1-100 MAT 2022	FLETA 1 - 01 Format A3
--	---	---	---	--	--	---	-------------------------------------

PJERRESIA	D= -3.79 p= -1.96% L= 193.22 m.	D= -4.23 p= -8.45% L= 50.01 m.	D= -4.39 p= -5.54% L= 79.19 m.
RAKORDIMET	f= -0.16 m. R = 300.00 m. Lv/2 = 9.73 m. Prog. 1328.60 m.	f= 0.11 m. R = 1000.00 m. Lv/2 = 14.56 m. Prog. 1378.61 m.	f= -0.09 m. R = 1000.00 m. Lv/2 = 13.68 m. Prog. 1457.80 m.

LEGJENDA:
 Vija e Projektit
 Vija e Terrenit

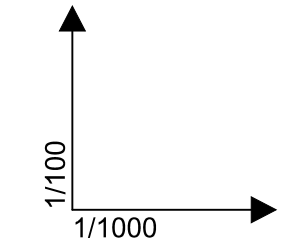

KUOTE REFERIMI

SEKSIONET	S69	S70	S71	S72	S73	S74	S75	S76	S77	S78	S79	S80	S81	S82	S83	S84
-----------	-----	-----	-----	-----	-----	-----	-----	-----	-----	-----	-----	-----	-----	-----	-----	-----

KUOTE TERRENI	285.59	285.03	284.42	284.03	283.87	283.49	283.21	282.99	282.42	280.31	278.03	276.31	275.41	274.30	274.09	272.31
---------------	--------	--------	--------	--------	--------	--------	--------	--------	--------	--------	--------	--------	--------	--------	--------	--------

KUOTE PROJEKTI	285.86	285.37	284.88	284.39	284.18	283.69	283.31	283.05	282.40	280.44	278.44	276.94	275.56	274.13	273.87	271.89
----------------	--------	--------	--------	--------	--------	--------	--------	--------	--------	--------	--------	--------	--------	--------	--------	--------

DISNIVELI	0.26	0.34	0.46	0.36	0.31	0.20	0.10	0.06	0.02	0.13	0.41	0.63	0.15	0.16	0.22	0.42
-----------	------	------	------	------	------	------	------	------	------	------	------	------	------	------	------	------

DISTANCA PJESORE	25.00	25.00	24.92	25.00	10.40	25.00	19.70	13.20	25.00	25.00	25.00	25.00	25.00	25.00	25.00	6.98
------------------	-------	-------	-------	-------	-------	-------	-------	-------	-------	-------	-------	-------	-------	-------	-------	------

DISTANCA PROGRESIVE	1160.38	1185.38	1210.31	1235.31	1245.71	1270.71	1290.41	1303.61	1328.61	1353.61	1378.61	1403.61	1428.61	1453.61	1457.57	1482.57
---------------------	---------	---------	---------	---------	---------	---------	---------	---------	---------	---------	---------	---------	---------	---------	---------	---------

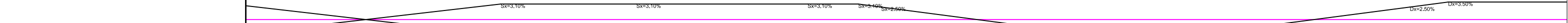
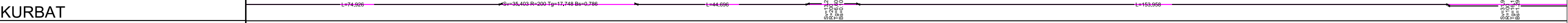
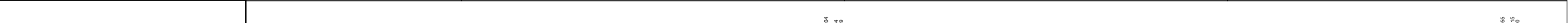

MBILARTESIMET																
---------------	--	--	--	--	--	--	--	--	--	--	--	--	--	--	--	--



POROSITESI : BASHKIA MAT
 OBJEKTI: "Ndertimi i rruges fshati Bater ,bashkia Mat"

Emertimi: Profili gjatesor
"Imperium Construction", shpk
 Adresa: njesi Bashkiake nr.9 Rruga "Shyqyri Peza"
 Pallati 21, Hyrja 1,Kati 2 ,Tirane

Drejtues i projektit
 Adm. Arber TOLA

Projektues	
Inxh. Elton LLAPUSHI	Mek. Bujar MERAJ
Inxh. Ilir Hodaj	Elek. Altin ALLKAJ
Ark. Rigert HYRA	Top. Iv BEQARI

SHKALLA	FLETA
Sh H 1-1000	1 - 01
Sh V 1-100	
MAT 2022	Format A3

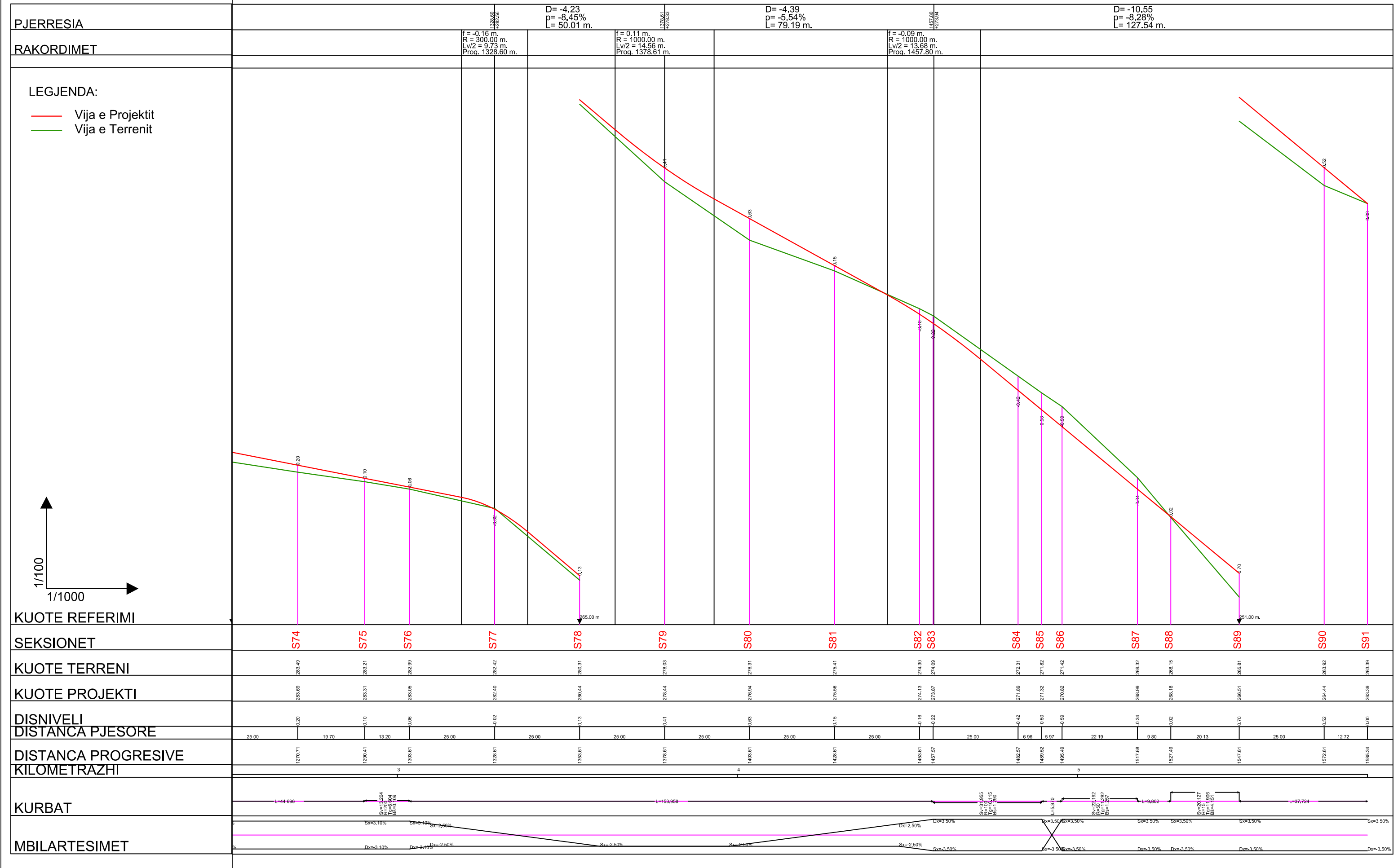

	POROSITESI : BASHKIA MAT OBJEKTI: "Ndertimi i rruges fshati Bater ,bashkia Mat"	Emertimi: Profili gjatesor “Imperium Construction”, shpk Adresa: njesi Bashkiake nr.9 Rruga “Shyqyri Peza” Pallati 21, Hyrja 1,Kati 2 ,Tirane	Drejtues i projektit Adm. Arber TOLA	Projektues Inxh. Elton LLAPUSHI Inxh. Ilir Hodaj Ark. Rigert HYRA	Mek. Bujar MERAJ Elek. Altin ALLKAJ Top. Iv BEQARI	SHKALLA Sh H 1-1000 Sh V 1-100 MAT 2022	FLETA 1 - 01 Format A3
--	---	---	---	--	--	---	-------------------------------------



REPUBLIKA E SHQIPERISË
BASHKIA MAT

PROJEKT ZBATIMI

OBJEKTI:

Ndertimi i rruges fshati Bater, bashkia Mat
Seksioni terthor tip



POROSITESI : BASHKIA MAT

OBJEKTI: "Ndertimi i rruges fshati Bater ,bashkia Mat"

Emertimi: Kapaku



“Imperium Construction”, shpk
Adresa: njesi Bashkiake nr.9 Rruga “Shyqyri Peza”
Pallati 21, Hyrja 1,Kati 2 ,Tirane

Drejtues i projektit

Adm. Arber TOLA

Projektues

Inxh. Elton LLAPUSHI

Inxh. Ilir Hodaj

Ark. Rigert HYRA

Mek. Bujar MERAJ

Elek. Altin ALLKAJ

Top. Iv BEQARI

SHKALLA

1- 500

MAT 2022

FLETA

1 - 01

Format A3

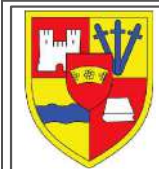
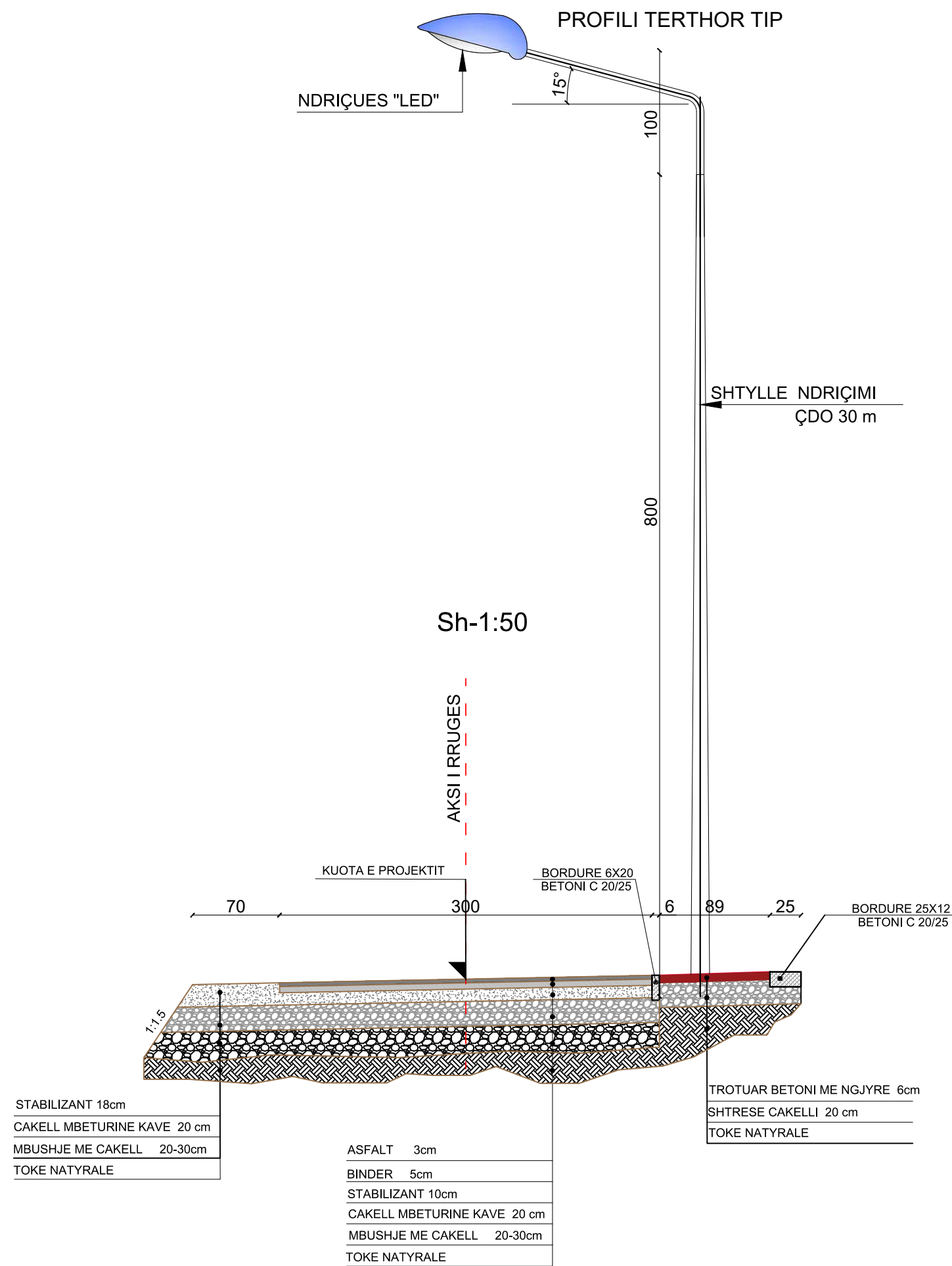

POROSITESI : BASHKIA MAT

OBJEKTI: "Ndertimi i rruges fshati Bater ,bashkia Mat"

Emertimi: **Profili terthor**

"Imperium Construction", shpk

Adresa: njesi Bashkiake nr.9 Rruga "Shyqyri Peza"
Pallati 21, Hyrja 1,Kati 2 ,Tirane



Drejtues i projektit

Adm. Arber TOLA

Projektues

Inxh. Elton LLAPUSHI

Inxh. Ilir Hodaj

Ark. Rigert HYRA

Mek. Bujar MERAJ

Elek. Altin ALLKAJ

Top. Iv BEQARI

SHKALLA

1- 50

MAT 2022

FLETA

1 - 01

Format A3



REPUBLIKA E SHQIPERISË
BASHKIA MAT

PROJEKT ZBATIMI

OBJEKTI:

Ndertimi i rruges fshati Bater, bashkia Mat
DETAJET E RRUGES



POROSITESI : BASHKIA MAT

OBJEKTI: "Ndertimi i rruges fshati Bater ,bashkia Mat"

Emertimi: KAPAKU



"Imperium Construction", shpk
Adresa: njesi Bashkiake nr.9 Rruga "Shyqyri Peza"
Pallati 21, Hyrja 1,Kati 2 ,Tirane

Drejtues i projektit

Adm. Arber TOLA

Projektues

Hidr. Elton LLAPUSHI	Mek. Bujar MERAJ
Inxh.Luan BETA	Elek. Altin ALLKAJ
Ark. Rigert HYRA	Top. Iv BEQARI

SHKALLA

1- 500

MAT 2022

FLETA

1 - 01

Format A3

Prerje e kapakut prej gize

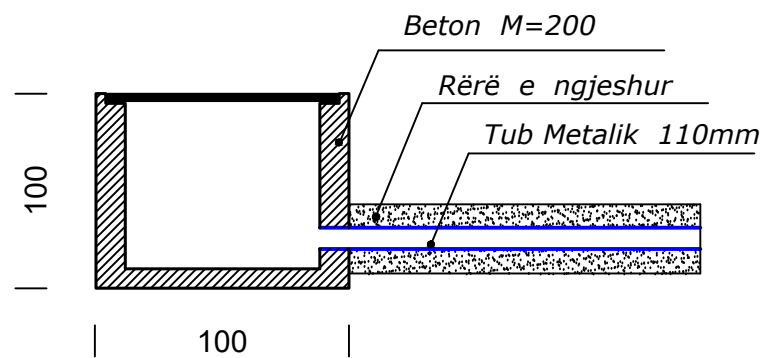

Prerje e vendosjes së pusitave

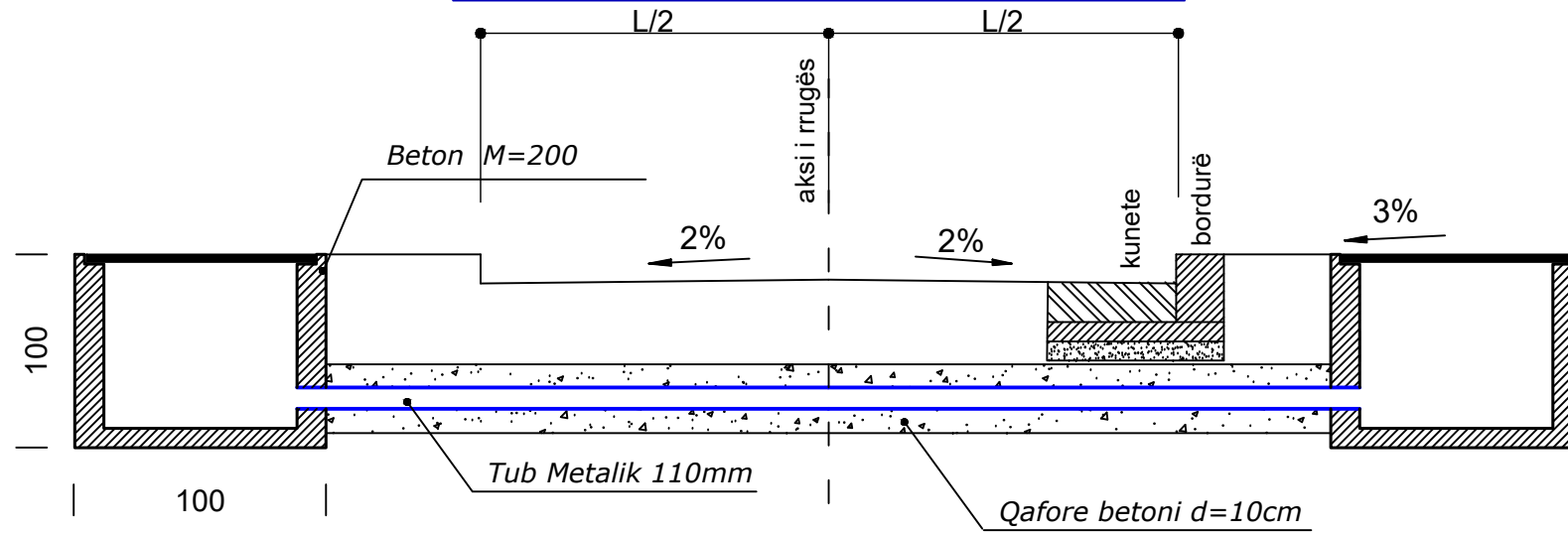

Kapaku i pusitës prej gize

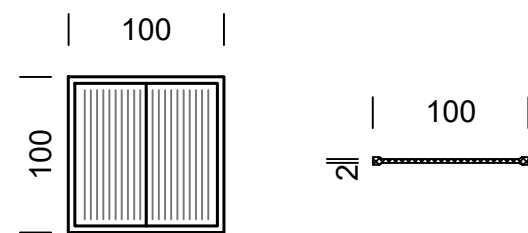

DETAJ I PUSITES 0.5X0.5m PER LINJAT E NDRICIMIT

Kapaku i pusitës prej plastike

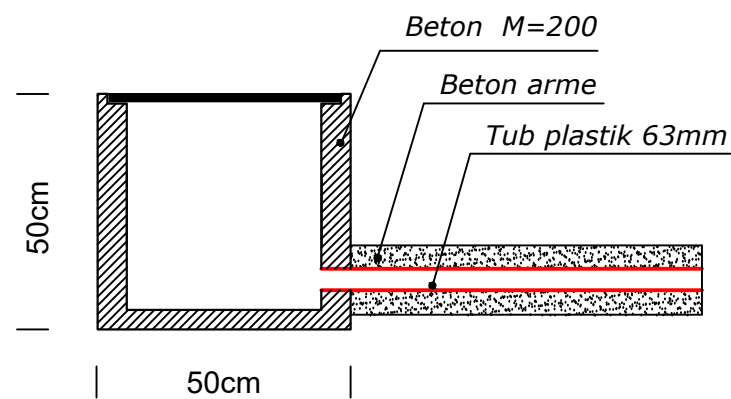

Prerje e vendosjes së pusitave

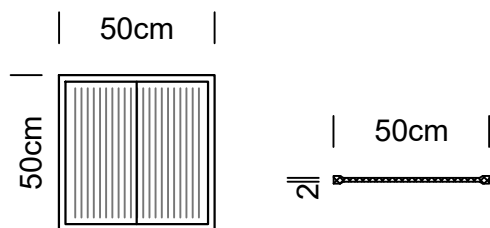
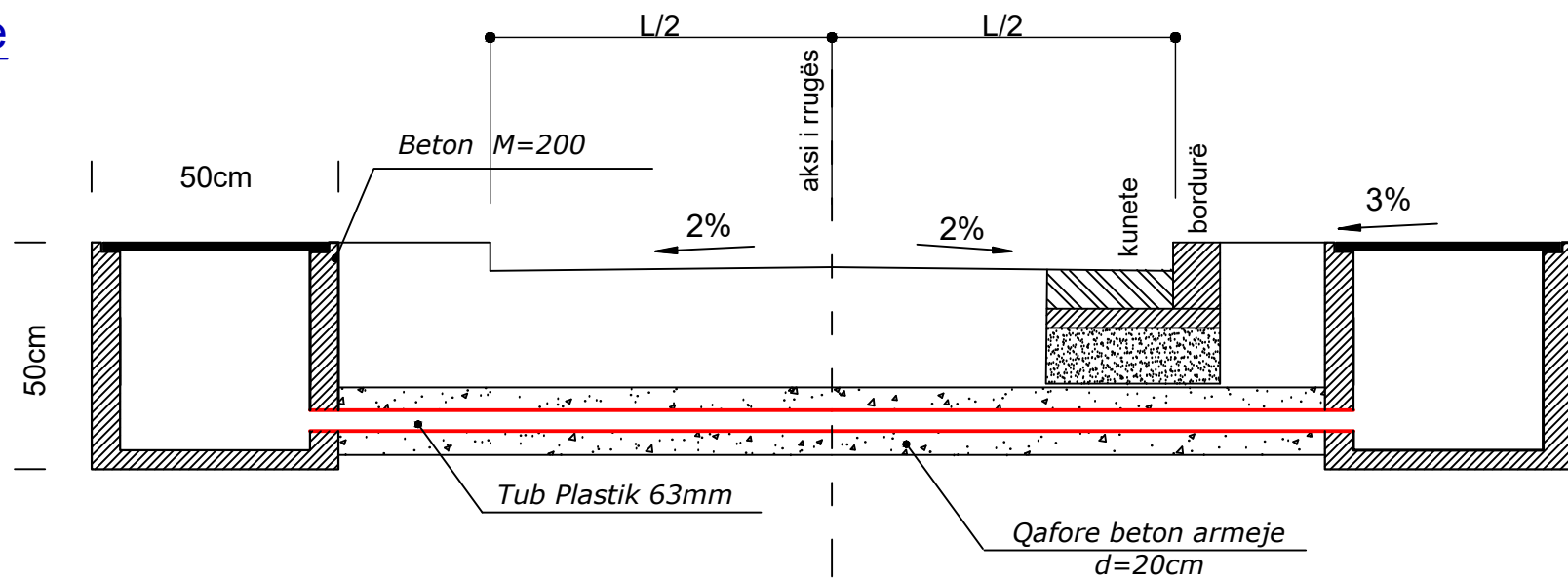

SHËNIME :

- Gjatë realizimit të intersektimeve kuota e vendosjes së pusitave mund të ndryshojë sipas rastit
- Tubi mund të vendoset me një pjerrësi të lehtë sipas nevojës , por gjithnjë thellësia minimale e vendosjes duhet te jete 50cm nga sip. e asfaltit.

Kapaku i pusitës prej plastike

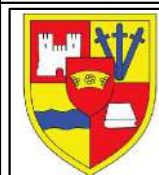

POROSITESI : BASHKIA MAT

OBJEKTI: "Ndertimi i rruges fshati BATER ,bashkia Mat"

Emertimi: Detaje elektrike

"Imperium Construction", shpk
Adresa: njesi Bashkiake nr.9 Rruga "Shyqyri Peza"
Pallati 21, Hyrja 1,Kati 2 ,Tirane



Drejtues i projektit

Adm. Arber TOLA

Projektues

Hidr. Elton LLAPUSHI	Mek. Bujar MERAJ
Inxh. Luan BETA	Elek. Altin ALLKAJ
Ark. Rigert HYRA	Top. Iv BEQARI

SHKALLA

1- 500

MAT 2022

FLETA

1 - 01

Format A3

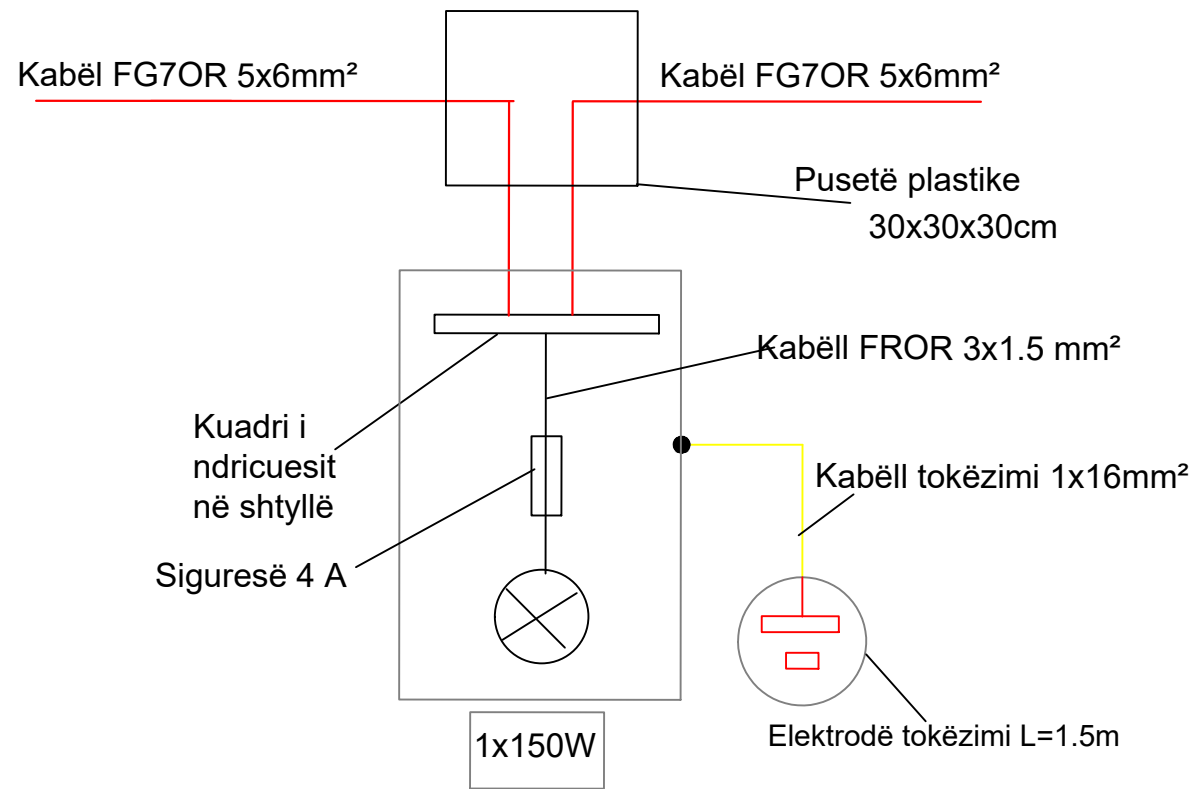

Hollësi e inkastrimit të kolonës së ndriçuesit me lartësi H=8.0m

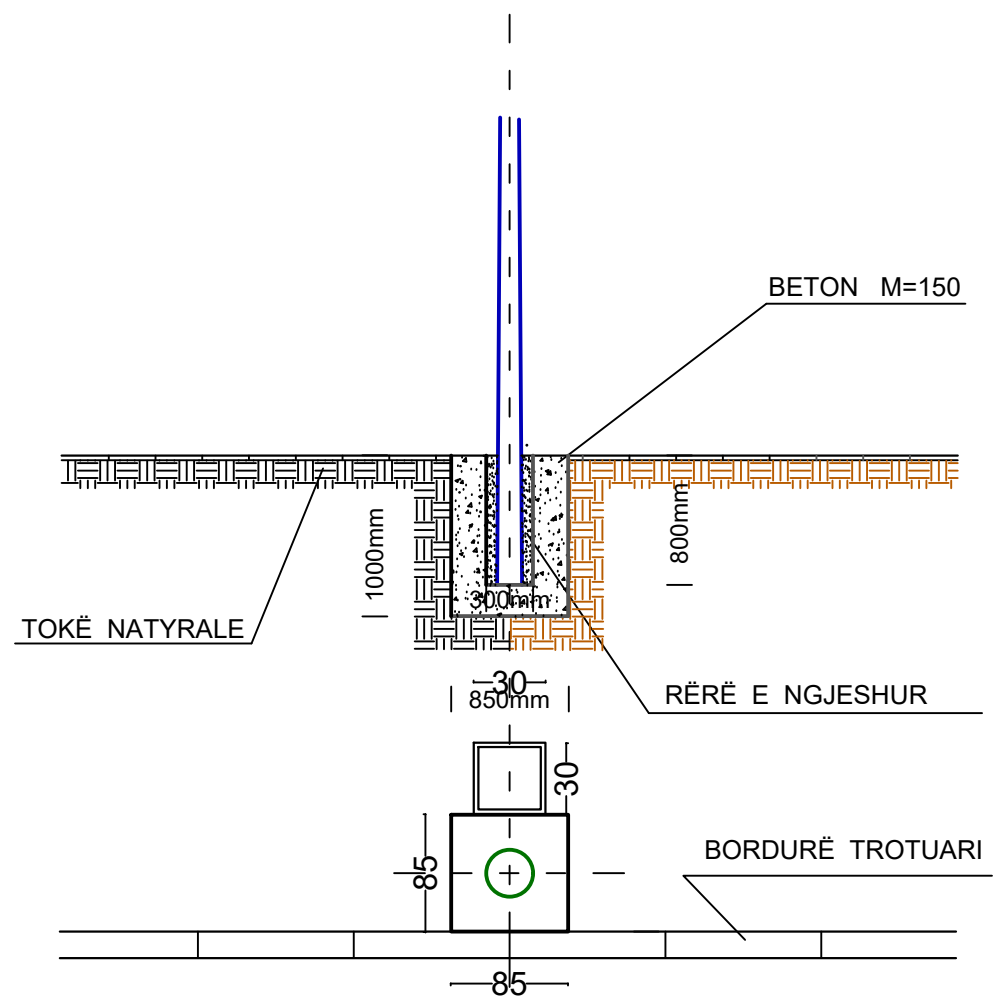

Konstruksioni morseterisë

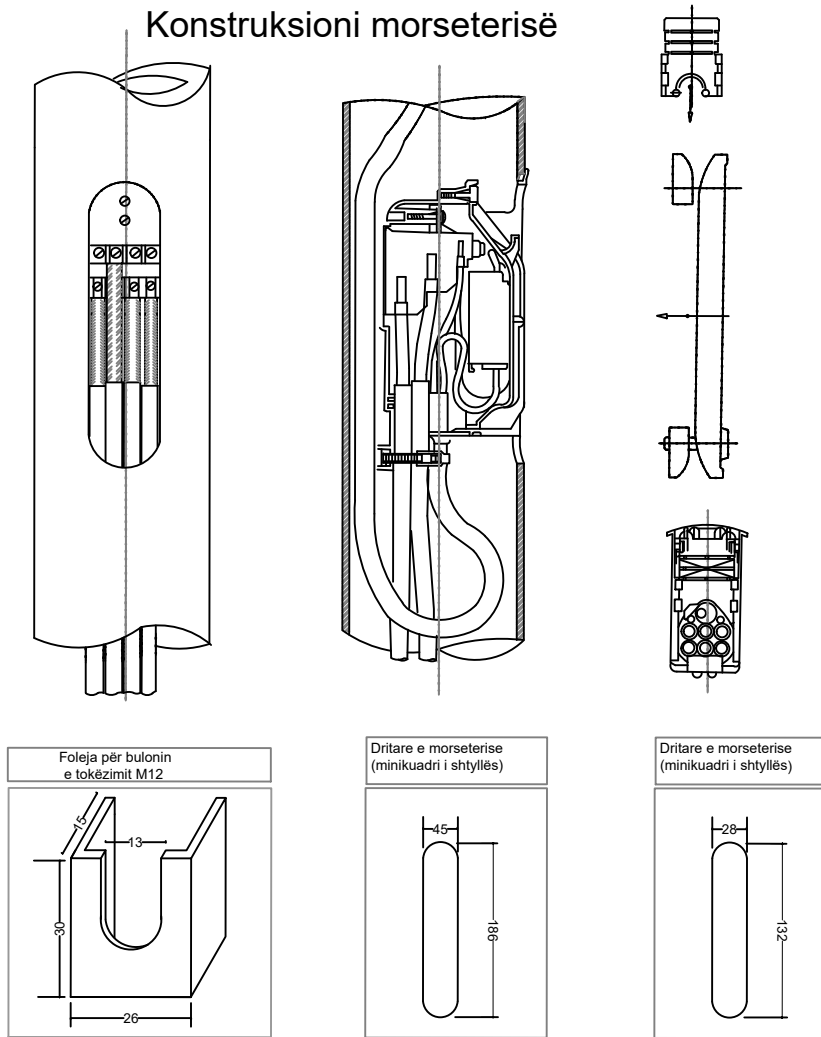

Detaj i tokëzimit të shtyllës së ndriçimit

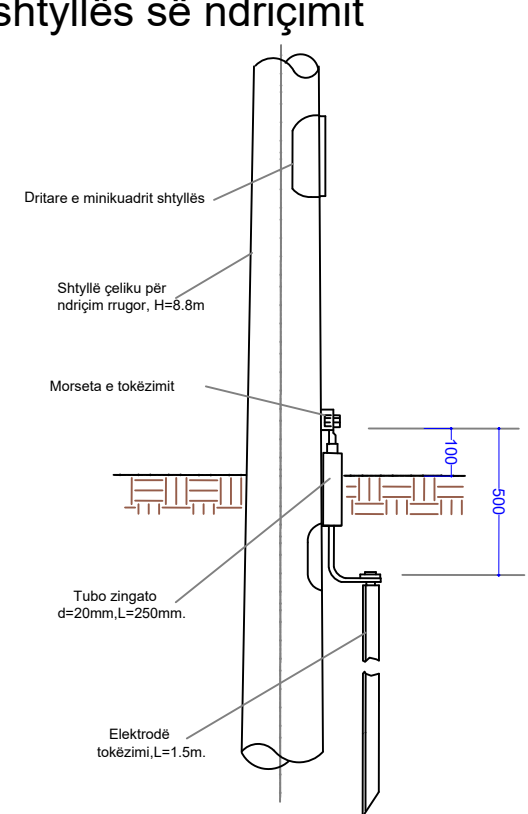

Hollësi e vendosjes së pusetës

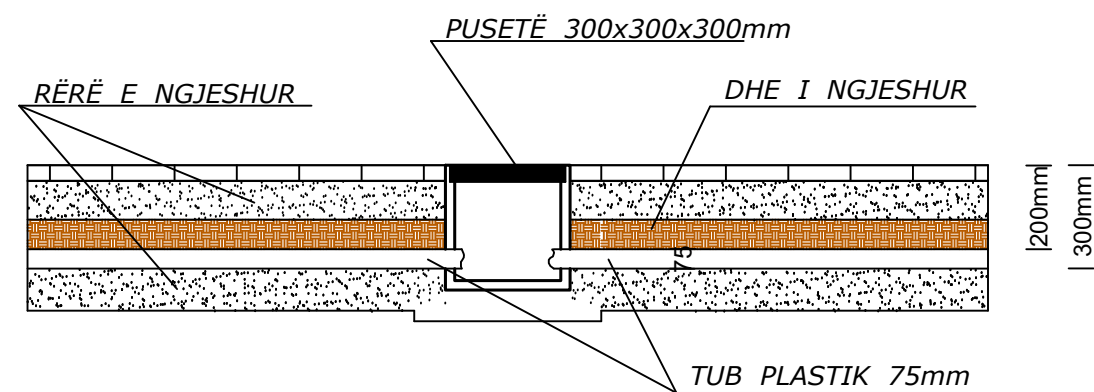

POROSITESI : BASHKIA MAT

OBJEKTI: "Ndertimi i rruges fshati Bater ,bashkia Mat"

Emertimi: Detaje elektrike

"Imperium Construction", shpk
 Adresa: njesi Bashkiake nr.9 Rruga "Shyqyri Peza"
 Pallati 21, Hyrja 1,Kati 2 ,Tirane



Drejtues i projektit

Adm. Arber TOLA

Projektues

Hidr. Elton LLAPUSHI	Mek. Bujar MERAJ
Inxh. Luan BETA	Elek. Altin ALLKAJ
Ark. Rigert HYRA	Top. Iv BEQARI

SHKALLA

1- 500

MAT 2022

FLETA

1 - 01

Format A3

Planimetria e instalimit të rrjetit kabllor të ndriçimit,

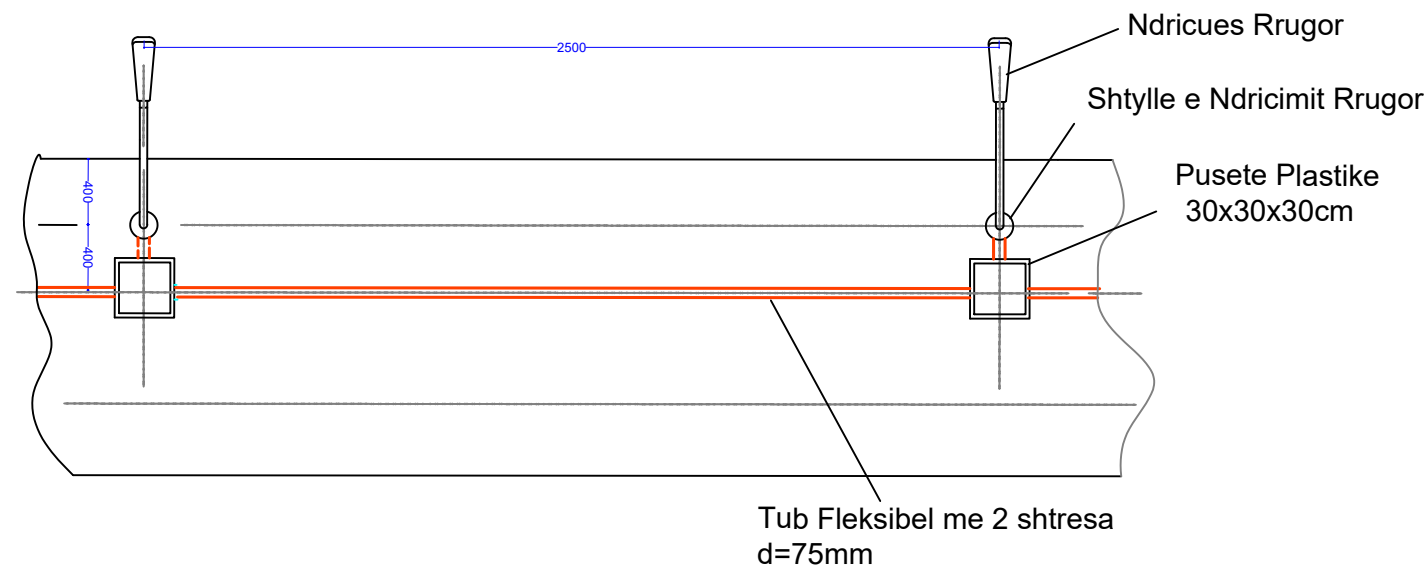

Detaj i montimit te pusetes dhe tokezimit te shtylles

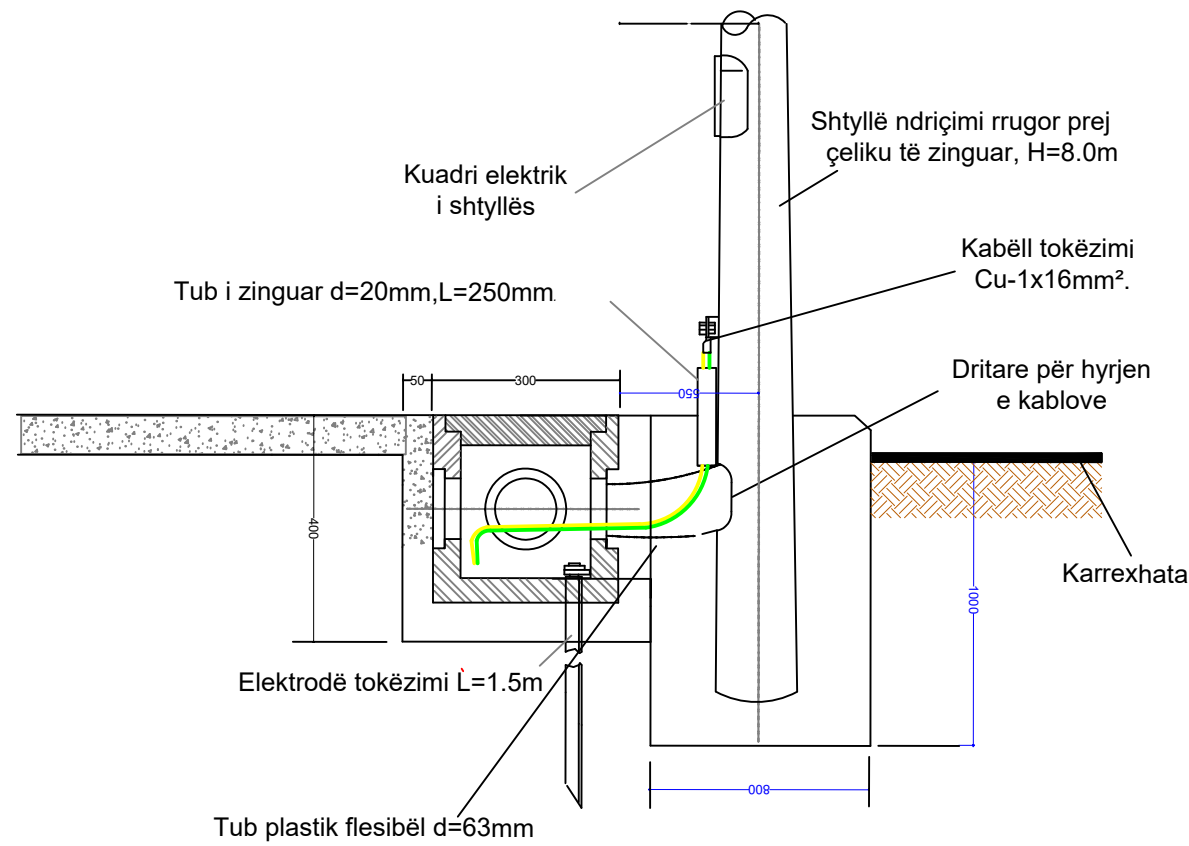

Shtrimi i kablove te TU ne TP.direkt ne toke

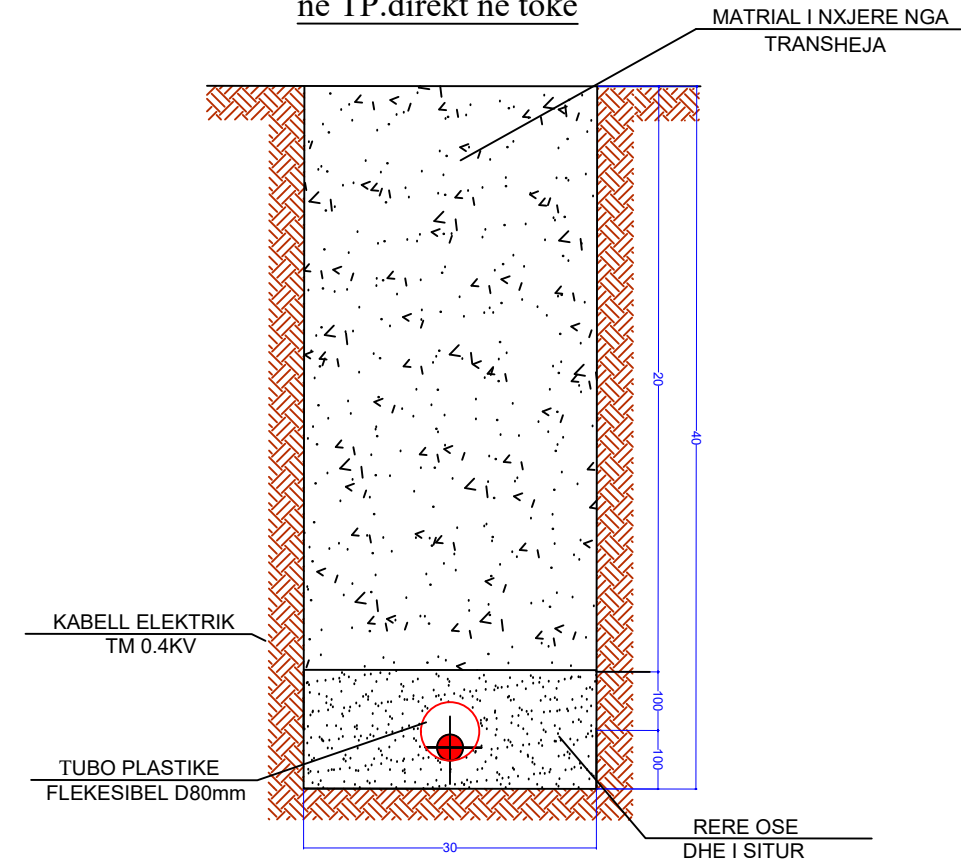

Shtrimi i kablove te TU ne trasversimin e rrugeve

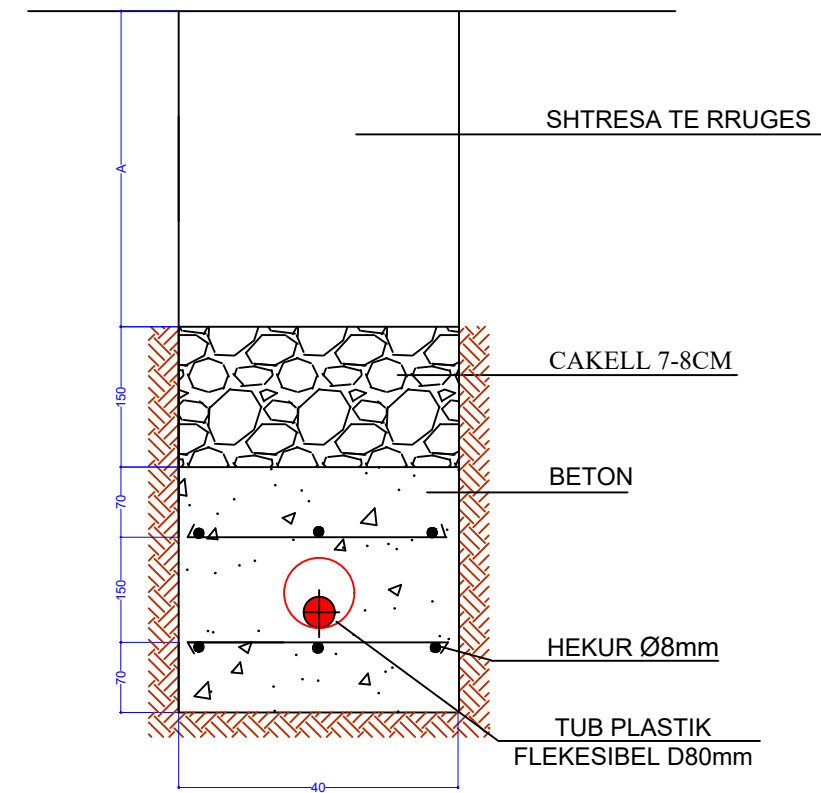

POROSITESI : BASHKIA MAT

OBJEKTI: "Ndertimi i rruges fshati Bater ,bashkia Mat"

Emertimi: Detaje elektrike



“Imperium Construction”, shpk
Adresa: njesi Bashkiake nr.9 Rruga "Shyqyri Peza"
Pallati 21, Hyrja 1,Kati 2 ,Tirane

Drejtes i projektit

Adm. Arber TOLA

Projektues

Hidr. Elton LLAPUSHI
Inxh.Luan BETA
Ark. Rigert HYRA

Mek. Bujar MERAJ
Elek. Altin ALLKAJ
Top. Iv BEQARI

SHKALLA

1- 500

MAT 2022

FLETA

1 - 01

Format A3

SHENJA LAJMERUESE WARNING SIGN

LAJMERIM PER NDERPRERJE NGA RRUGE DYTESORE, KTHESAT E KURBEZUARA,
FEMIJET, KEMBESORET DHE PER NDALJE/DHENIE RRUGE
WARNING SIGN INTERSECTION OF SECONDARY ROAD, WARNING SIGN CURVE,
WARNING SIGN PEDESTRAIN & CHILDREN'S, STOP & GIVE WAY SIGN

TREKENDESHI: E KUQE REFLEKTUESE
SFONDI: I ZI
SIMBOLI: E BARDHE REFLEKTUESE



TRIANGLE: RED REFLECTIVE
BACKGROUND: WHITE REFLECTIVE
SYMBOL: BLACK

SHENJA NDALUESE PROHIBIT SIGN

SHENJAT PER KUFIRIN E SHPEJTESISË DHE NDALIM PARAKALIMIN
SPEED LIMIT SIGN & OVERTAKE PROHIBIT

RRETHI: E KUQE REFLEKTUESE
SHENJA: E ZEZE REFLEKTUESE
CIRCLE: RED REFLECTIVE
SIGN: BLACK REFLECTIVE

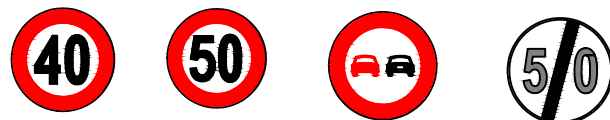

SHENJA DETYRUESE OBLIGATORY SIGN

ANET & SHIGJETAT: E BARDHE REFLEKTUESE
SFONDI: BLU REFLEKTUESE KL 2

EDGE & ARROW: WHITE REFLECTIVE
BACKGROUND: BLUE REFLECTIVE CL 2



SHENJA PLOTESUESE COMPLEMENTARY SIGN

SHENJA E KTHESES NE NJE DREJTIM & DY DREJTIME
CHEVRON SIGNS ONE DIRECTION & TWO DIRECTION

SHENJA : E BARDHE REFLEKTUESE
SFONDI: E ZEZE
SIGN : WHITE REFLECTIVE
BACKGROUND: BLACK



SHENJA INFORMUESE INFORMATION SIGN

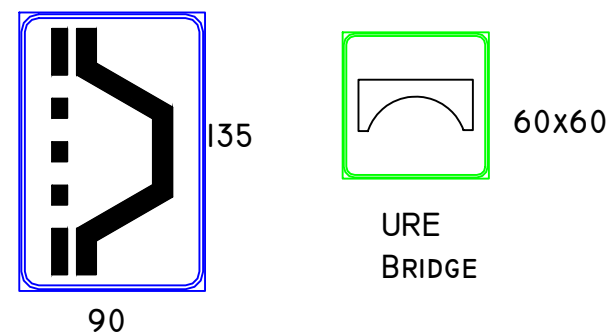

SHENIM: SHENJAT RRUGORE PER NGA FORMA, MADHESIA, NGJYRA REFLEKTIVITETI DUHET TE JENE SIPAS KODIT RRUGOR TE REPUBLIKES SE SHQIPERISE
MATERIALI PRAPAREFLEKTIV DUHET TE KETE JETEGJATESI 10VJET PER CLASIN 2 DHE 7 VJET PER CLASIN I
SIMBOLI BRENDA SHENJES RRUGORE DUHET TE JETE I REALIZUAR ME BOJE TE TRAJTUAR ME PJEKJE E CILA NUK HUMBET TREGUESIT PRAPAREFLEKTIV
SHENJA RRUGORE REALIZOHET ME LLAMARINE ÇELIKU E CILA LYHET ME BOJE OPAKE KUNDRANDRA KOROZIONITDHE TRAJTOHET ME PJEKJE.



POROSITESI : BASHKIA MAT

OBJEKTI: "Ndertimi i rruges fshati Bater ,bashkia Mat"

Emertimi: Detaje sinjalistike

"Imperium Construction", shpk
Adresa: njesi Bashkiake nr.9 Rruga "Shyqyri Peza"
Pallati 21, Hyrja 1,Kati 2 ,Tirane



Drejtues i projektit

Adm. Arber TOLA

Projektues

Inxh. Elton LLAPUSHI	Mek. Bujar MERAJ
Inxh. Ilir Hodaj	Elek. Altin ALLKAJ
Ark. Rigert HYRA	Top. Iv BEQARI

SHKALLA

1- 500

MAT 2022

FLETA

1 - 01

Format A3

DETAJE TE SINJALISTIKES

TIPET E VIZIMEVE TE RRUGES ROAD MARKING LINES TYPE

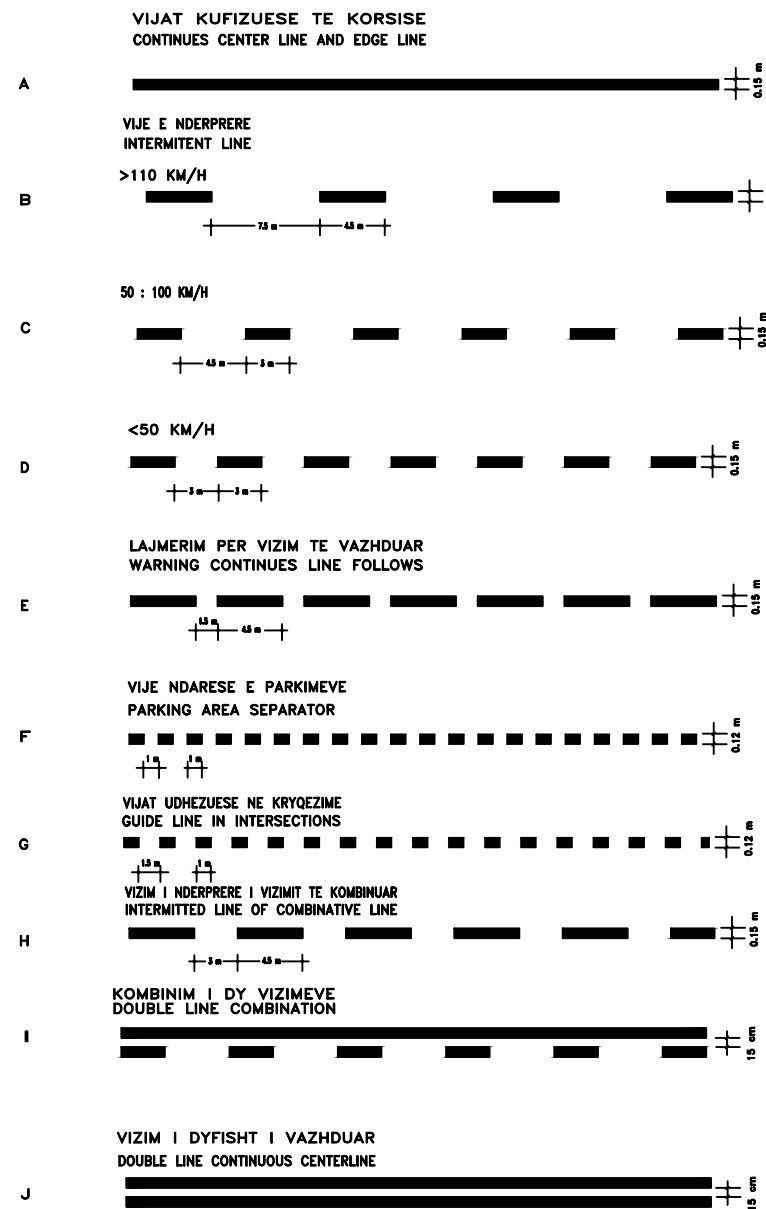

KALIMET E KEMBESOREVE PEDESTRIANS CROSSING

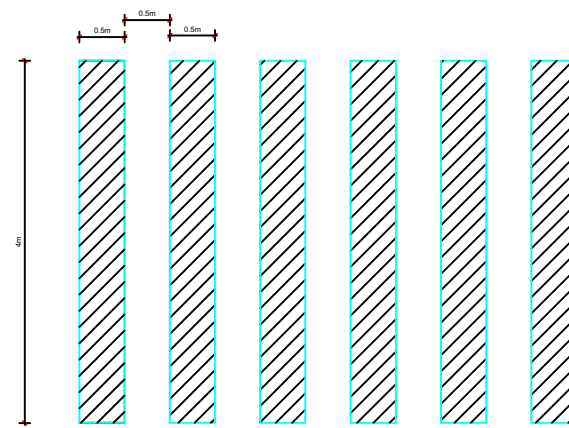

SHIGJETAT TREGUESE TE RRUGES ROAD MARKING ARROWS

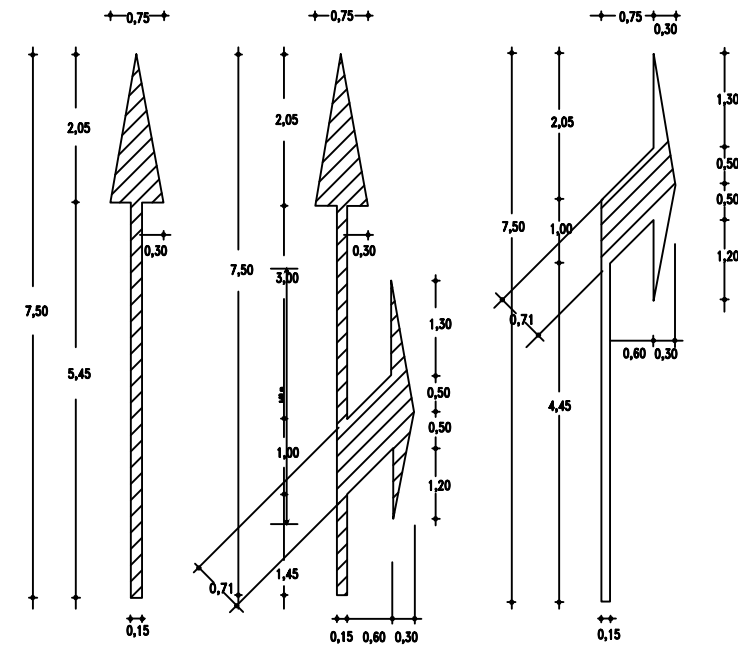

DHENIE PERPARESIE GIVE WAY ROAD SIGN

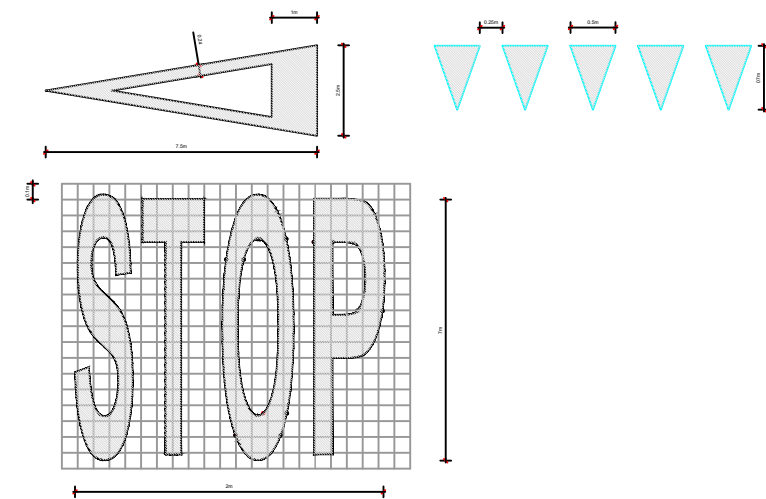

VIZIMI I RRUGES ROAD PAINTING

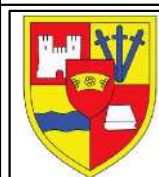
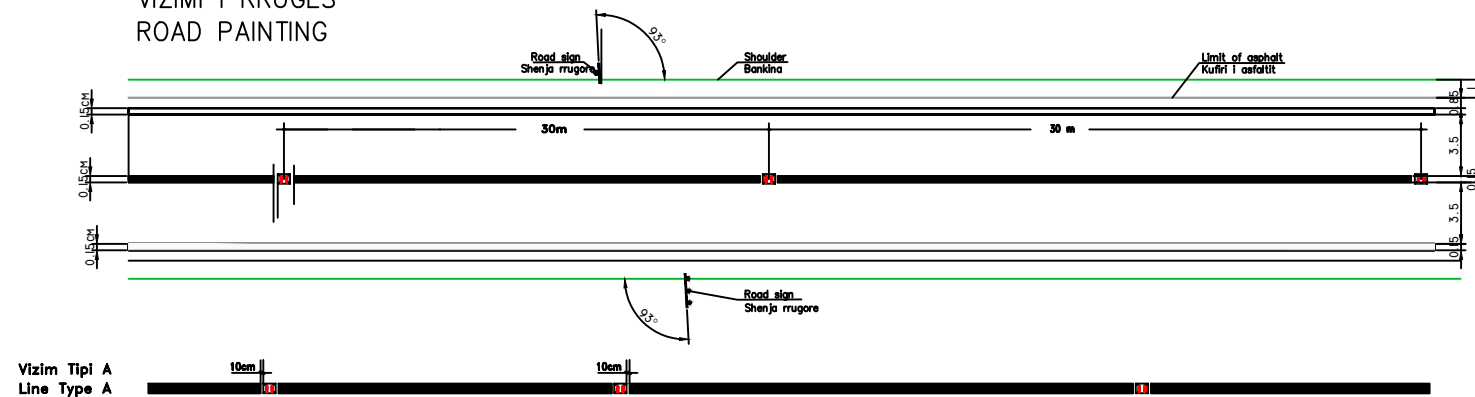

POROSITESI : BASHKIA MAT

OBJEKTI: "Ndertimi i rruges fshati Bater ,bashkia Mat"

Emertimi: Detaje sinjalistike

"Imperium Construction", shpk
Adresa: njesi Bashkiake nr.9 Rruga "Shyqyri Peza"
Pallati 21, Hyrja 1,Kati 2 ,Tirane



Drejtues i projektit

Adm. Arber TOLA

Projektues

Inxh. Elton LLAPUSHI
Inxh. Ilir Hodaj
Ark. Rigert HYRA

Mek. Bujar MERAJ
Elek. Altin ALLKAJ
Top. Iv BEQARI

SHKALLA

1- 500

MAT 2022

FLETA

1 - 01

Format A3

DETAJE TE SINJALISTIKES

VENDOSJA E SHENJES RRUGORE

PRERJA TERTHORE E TABELËS

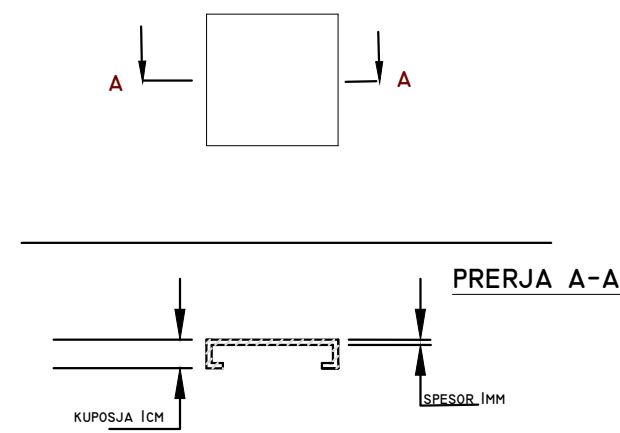
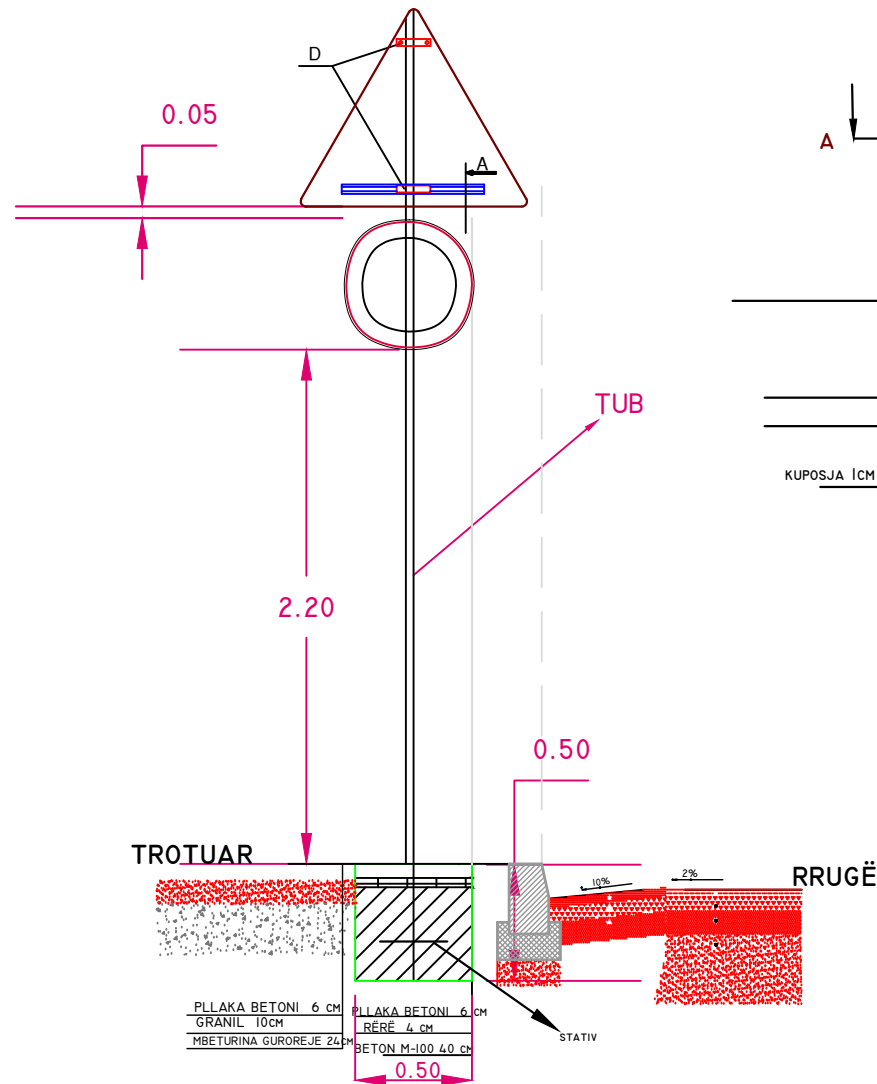
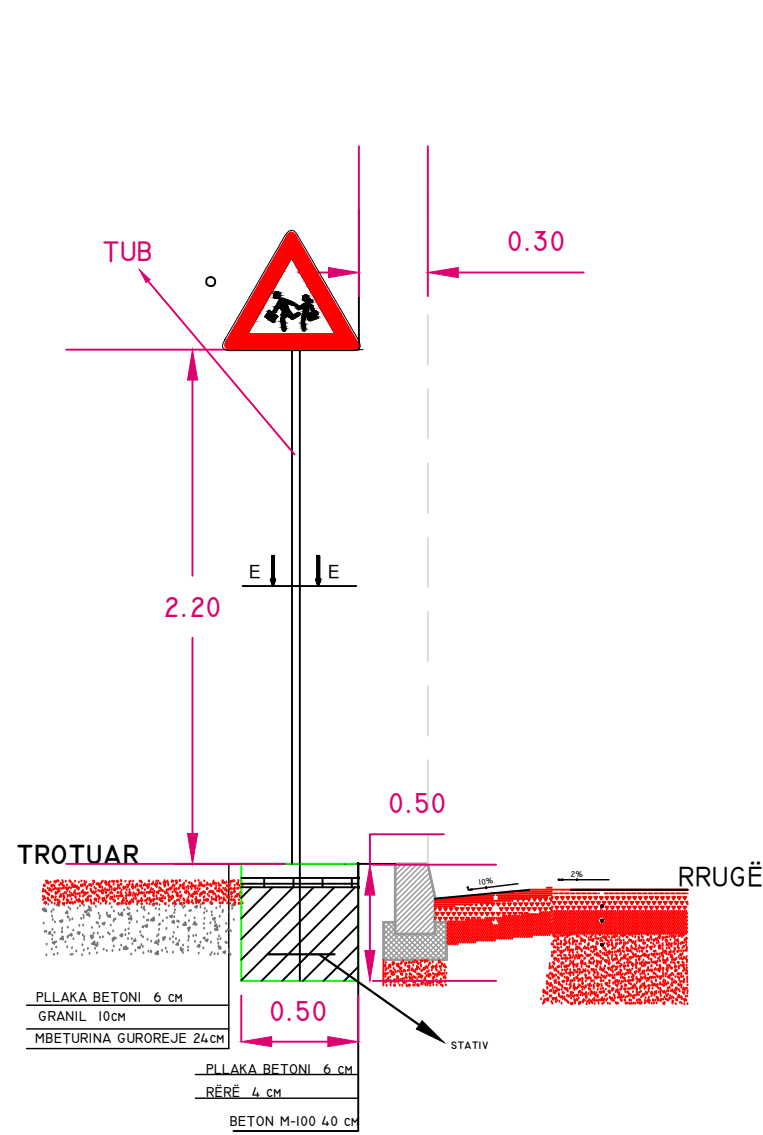

E - E

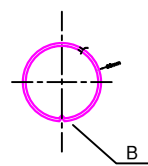

A - A

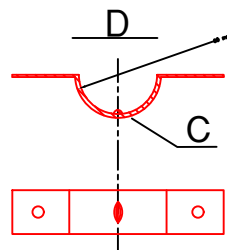
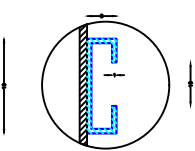

DETAJE Kurrizë artificiale h=5cm

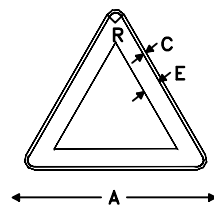
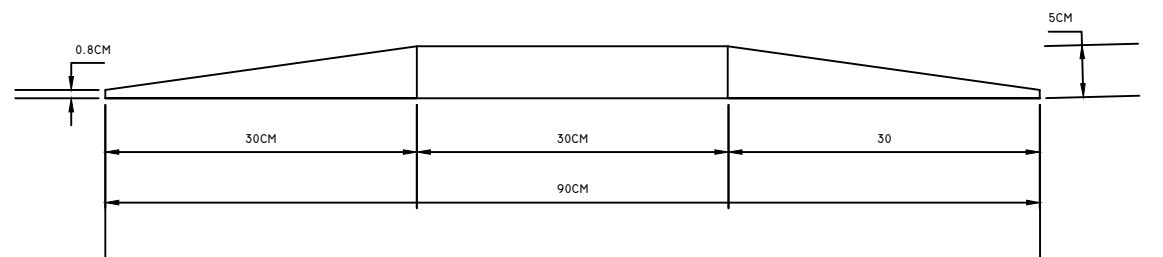

A	C	E	R
90	1.5	8	4.5

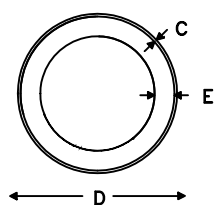

C	D	E
1	60	7.5

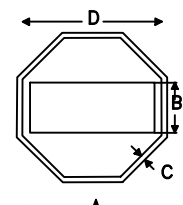

A	C	E	D
90	30	3	75
Dim vogel	60	20	2
			50

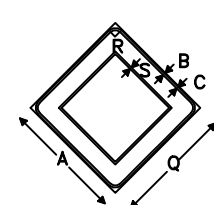

A	B	C	Q	R	S
60	0.5	1	40	3.5	11

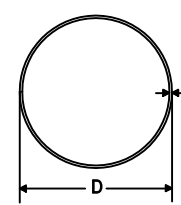

C	D
1	60
Dim vogel	0.8
	40



POROSITESI : BASHKIA MAT

OBJEKTI: "Ndertimi i rruges fshati Bater ,bashkia Mat"

Emertimi: Detaje sinjalistike



"Imperium Construction", shpk
Adresa: njesi Bashkiake nr.9 Rruga "Shyqyri Peza"
Pallati 21, Hyrja 1,Kati 2 ,Tirane

Drejtues i projektit

Adm. Arber TOLA

Projektues

Inxh. Elton LLAPUSHI
Inxh. Ilir Hodaj
Ark. Rigert HYRA

Mek. Bujar MERAJ
Elek. Altin ALLKAJ
Top. Iv BEQARI

SHKALLA

1- 500

MAT 2022

FLETA

1 - 01

Format A3

PLAN

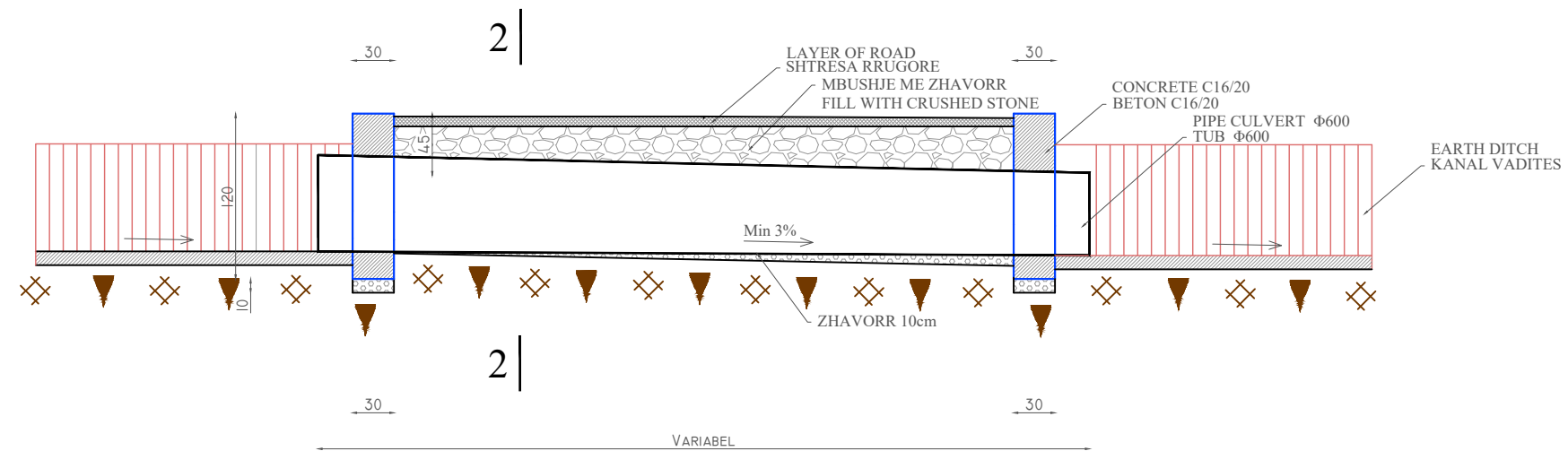
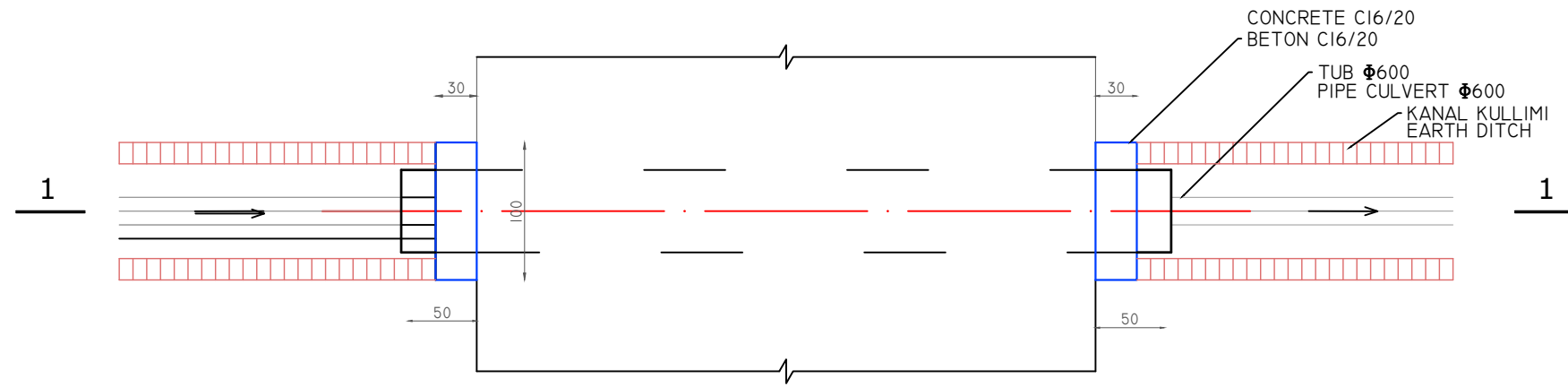

PRERJA 1-1

PRERJA 2-2

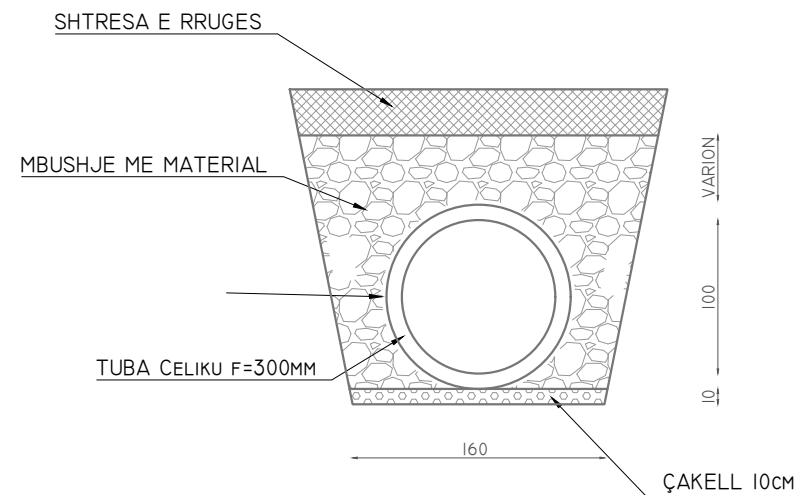

POROSITESI : BASHKIA MAT

OBJEKTI: "Ndertimi i rruge fshati Bater ,bashkia Mat"

Emertimi: DETAJE TOMBINO



"Imperium Construction", shpk
Adresa: njesi Bashkiake nr.9 Rruga "Shyqyri Peza"
Pallati 21, Hyrja 1,Kati 2 ,Tirane

Drejtues i projektit

Adm. Arber TOLA

Projektues

Hidr. Elton LLAPUSHI
Inxh.Luan BETA
Ark. Rigert HYRA

Mek. Bujar MERAJ
Elek. Altin ALLKAJ
Top. Iv BEQARI

SHKALLA

1- 500

MAT 2022

FLETA

1 - 01

Format A3

TOMBINO Ø600 B/A

PRERJE NE AKS E TOMBINOS

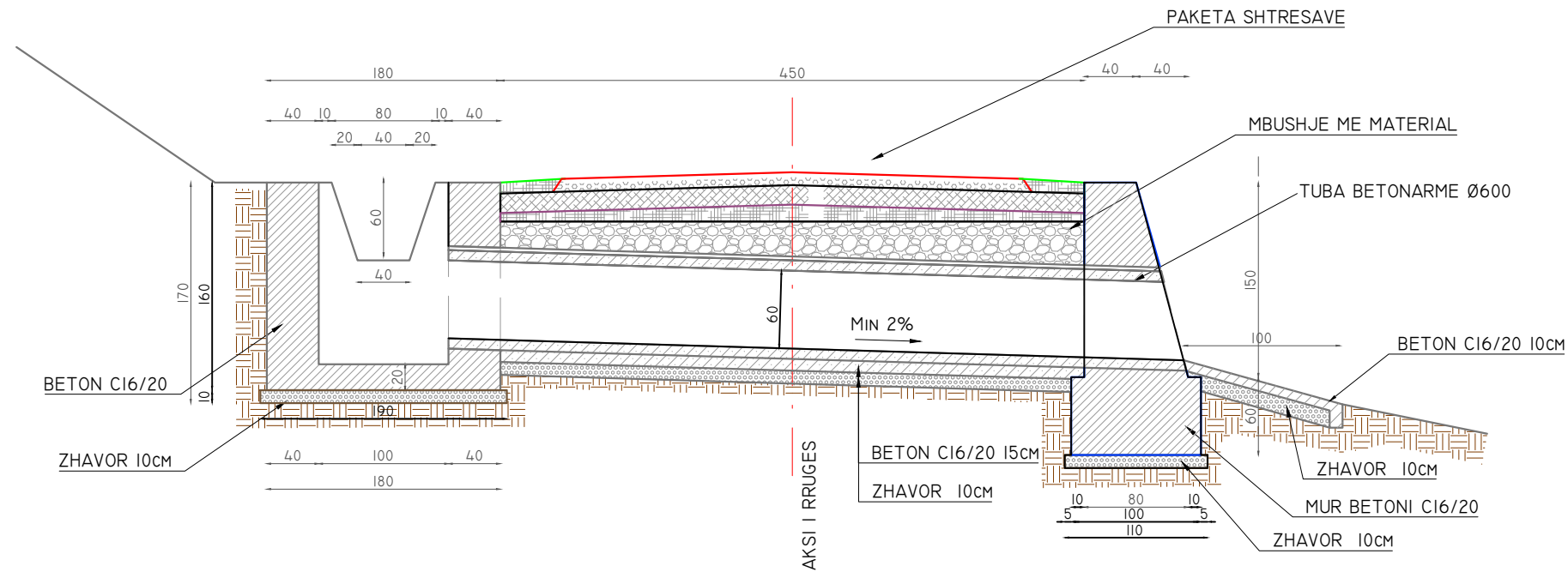

VOLUMET E PUNES

EMERTIMI		m ³
BETON C16/20	PUSETA	3.30
	PORTALI	3.60
	DHEMBI + SHTRESA	0.10
	TOTALI	7.0
SHTRESE ZHAVORRI		1.23

PRERJA 1-1

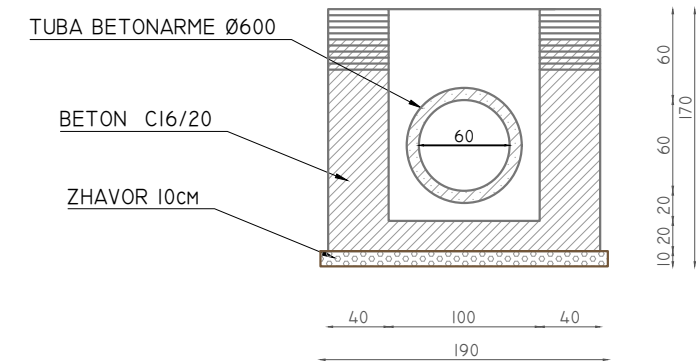

PLANIMETRIA

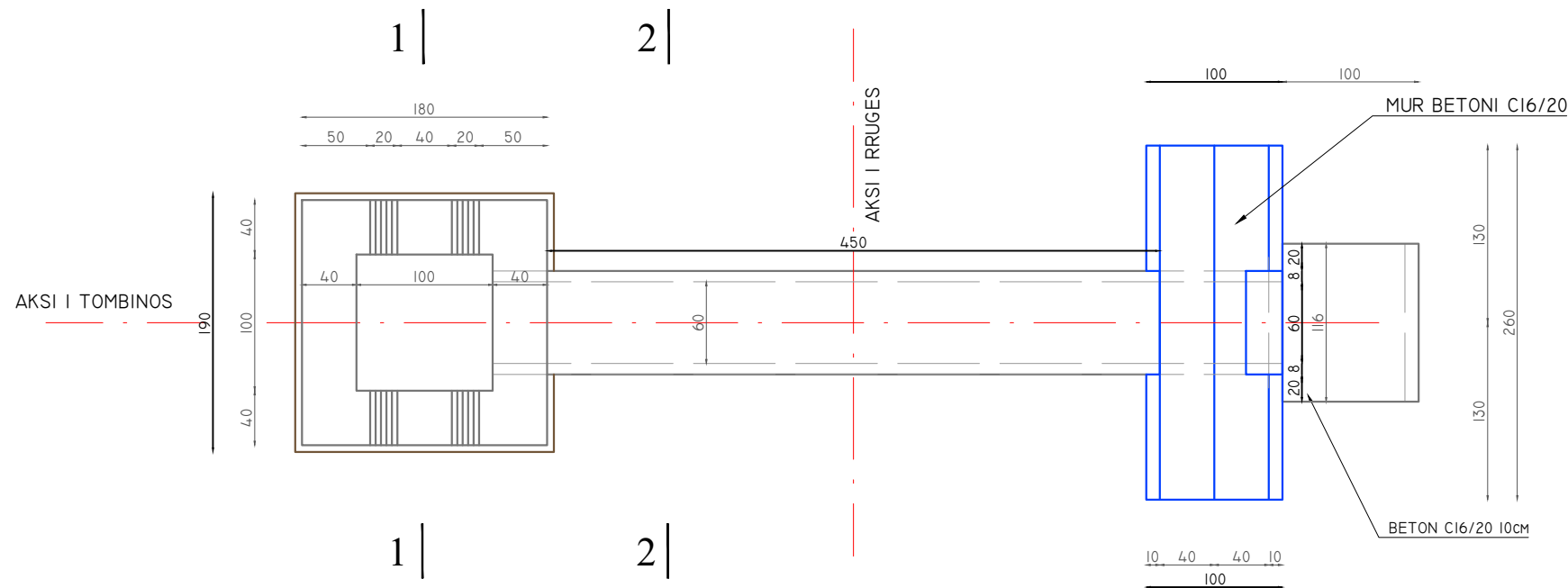

PRERJA 2-2

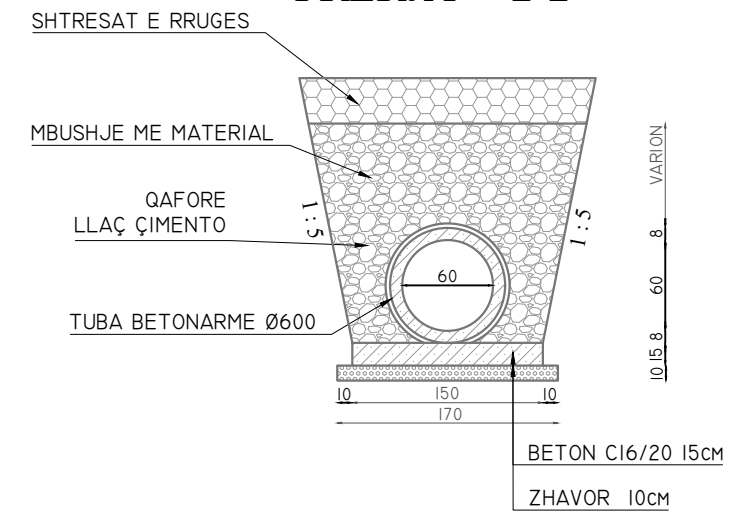

POROSITESI : BASHKIA MAT

OBJEKTI: "Ndertimi i rruge fshati Bater ,bashkia Mat"

Emertimi: DETAJE TOMBINO

"Imperium Construction", shpk
Adresa: njesi Bashkiake nr.9 Rruga "Shyqyri Peza"
Pallati 21, Hyrja 1,Kati 2 ,Tirane

Drejtues i projektit

Adm. Arber TOLA

Projektues

Hidr. Elton LLAPUSHI
Inxh.Luan BETA
Ark. Rigert HYRA

Mek. Bujar MERAJ
Elek. Altin ALLKAJ
Top. Iv BEQARI

SHKALLA FLETA

1- 500

1 - 01

MAT 2022 Format A3

TOMBINO Ø1000 B/A

PRERJE NE AKS E TOMBINOS

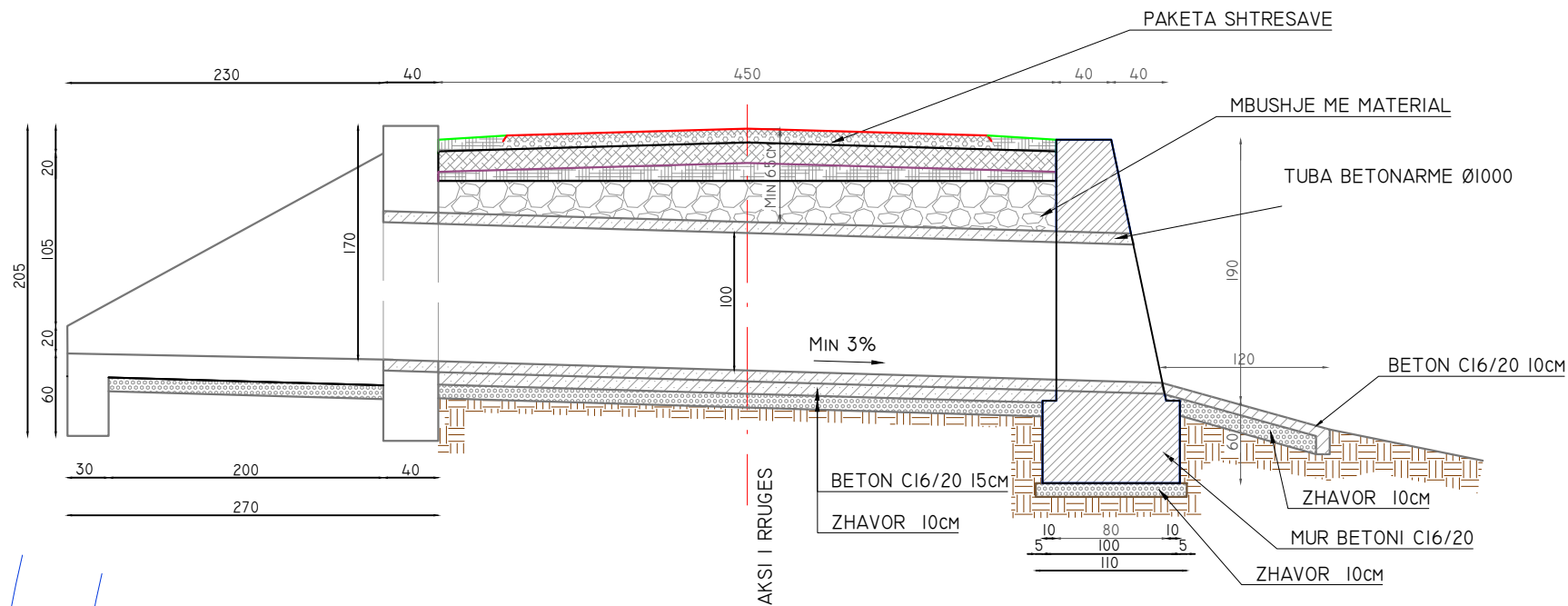

VOLUMET E PUNES

EMERTIMI		m³
BETON C16/20	PORTALI HYRJES	4.75
	PORTALI I DALJES	4.75
	DHEMBI + SHTRESA	2.0
	TOTALI	11.6
	SHTRESE ZHAVORRI	2.0

PAMJA BALLORE

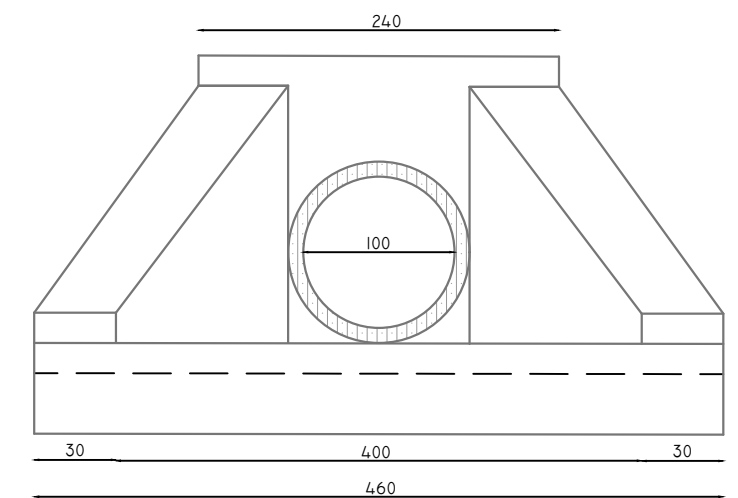

PLANIMETRIA

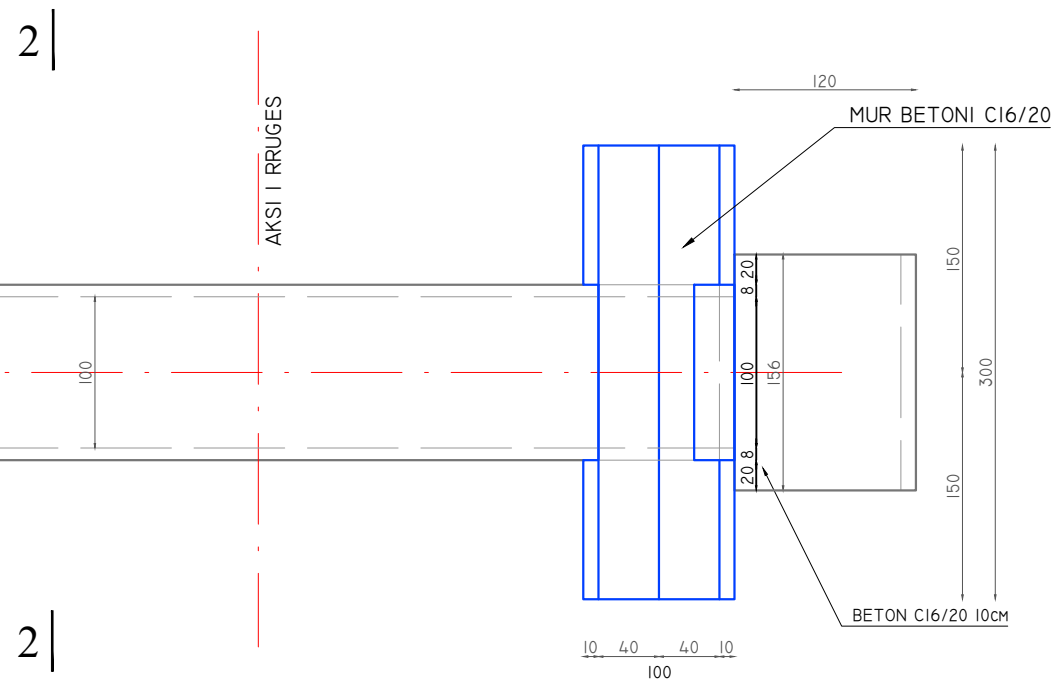

PRERJA 2-2

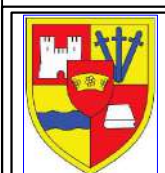
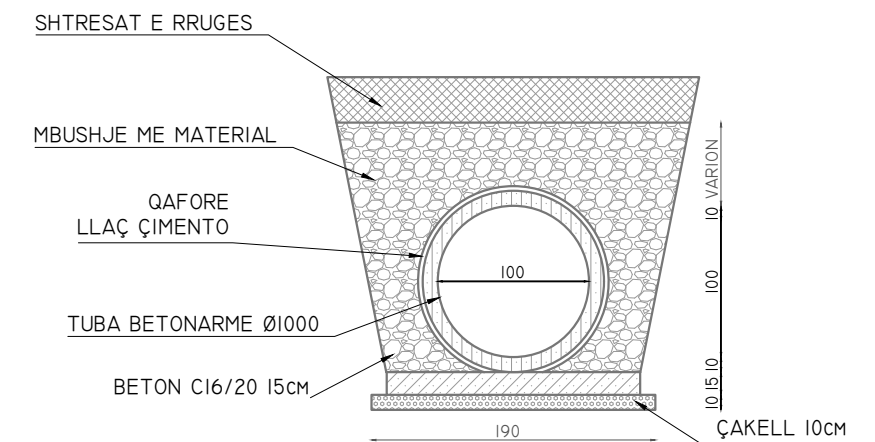

POROSITESI : BASHKIA MAT

OBJEKTI: "Ndertimi i rruge fshati Bater ,bashkia Mat"

Emertimi: DETAJE TOMBINO



"Imperium Construction", shpk
Adresa: njesi Bashkiake nr.9 Rruga "Shyqyri Peza"
Pallati 21, Hyrja 1,Kati 2 ,Tirane

Drejtues i projektit

Adm. Arber TOLA

Projektues

Hidr. Elton LLAPUSHI
Inxh.Luan BETA
Ark. Rigert HYRA

Mek. Bujar MERAJ
Elek. Altin ALLKAJ
Top. Iv BEQARI

SHKALLA

1- 500

MAT 2022

FLETA

1 - 01

Format A3

SHENJA LAJMERUESE

LAJMERIM PER NDERPRERJE NGA RRUGE DYTESORE, KTHESAT E KURBEZUARA, FEMIJET, KEMBESORET DHE PER NDALJE/DHENIE RRUGE

TREKENDESHI: E KUQE REFLEKTUESE
SFONDI: I ZI
SYMBOLI: E BARDHE REFLEKTUESE

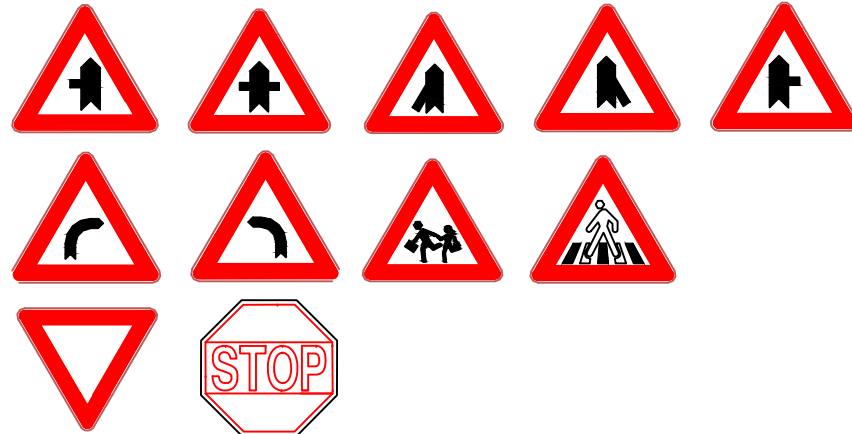

PERMASAT E SHENJAVE STANDARTE

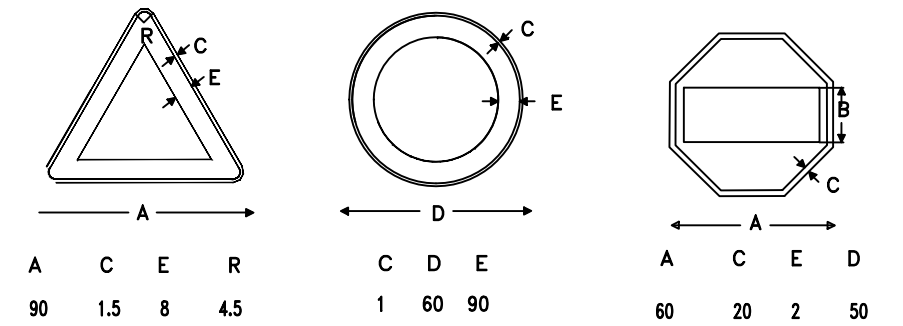

SHENJA NDALUESE

SHENJAT PER KUFIRIN E SHPEJTESISE DHE NDALIM PARAKALIMIN

RRETHI: E KUQE REFLEKTUESE
SHENJA: E ZEZE REFLEKTUESE

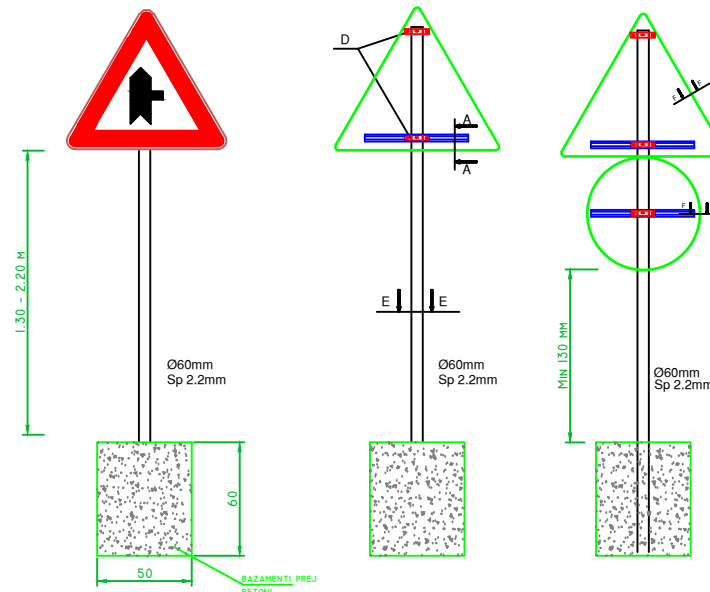
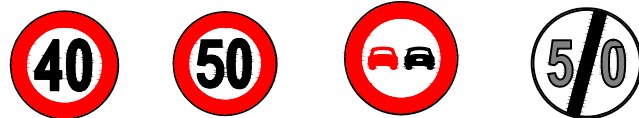

TIPET E VIZIMEVE TE RRUGES

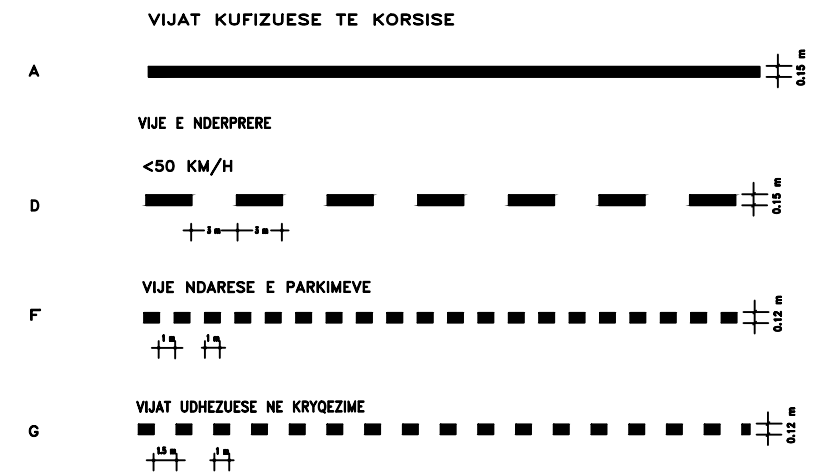

SHENJA INFORMUESE

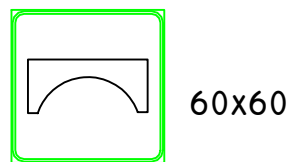

URE

Shenim: Shenjat rrugore per nga forma, madhesia, ngjyra reflektiviteti duhet te jene sipas Kodit Rrugor te Republikes se Shqiperise Materiali praparefektiv duhet te kete jetegjatesi 10vjet per Clasin 2 dhe 7 vjet per Clasin 1 Simboli brenda shenjes rrugore duhet te jete i realizuar me boje te trajtuar me pjekje e cila nuk humbet treguesit praparefektiv Shenja rrugore realizohet me llamarine çeliku e cila lyhet me boje opake kundrandra korozionit dhe trajtohet me pjekje.

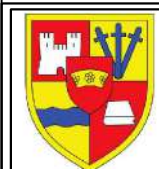
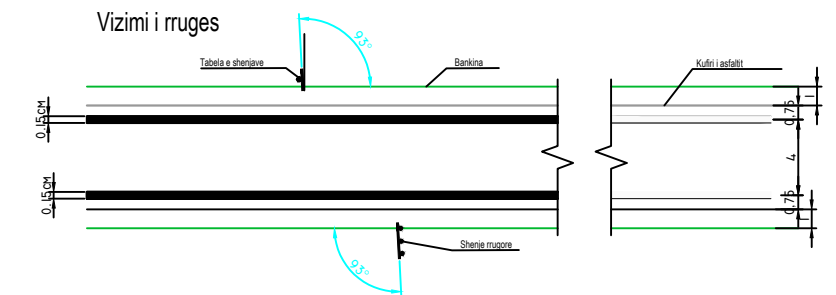
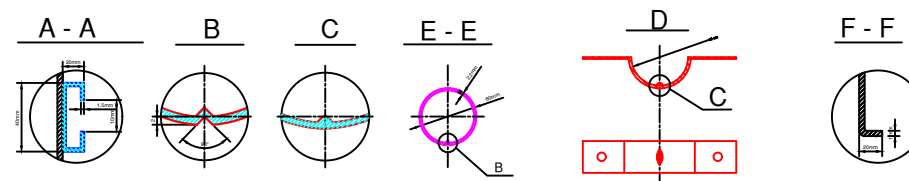

POROSITESI : BASHKIA MAT

OBJEKTI: "Ndertimi i rruges fshati Bater ,bashkia Mat"

Emertimi: Detaje sinjalistike

"Imperium Construction", shpk
Adresa: njesi Bashkiake nr.9 Rruga "Shyqyri Peza"
Pallati 21, Hyrja 1,Kati 2 ,Tirane



Drejtues i projektit

Adm. Arber TOLA

Projektues

Hidr. Elton LLAPUSHI
Inxh.Luan BETA
Ark. Rigert HYRA

Mek. Bujar MERAJ
Elek. Altin ALLKAJ
Top. Iv BEQARI

SHKALLA

1- 500

MAT 2022

FLETA

1 - 01

Format A3

VENDOSJA DHE MONTIMI I SHENJES RRUGORE

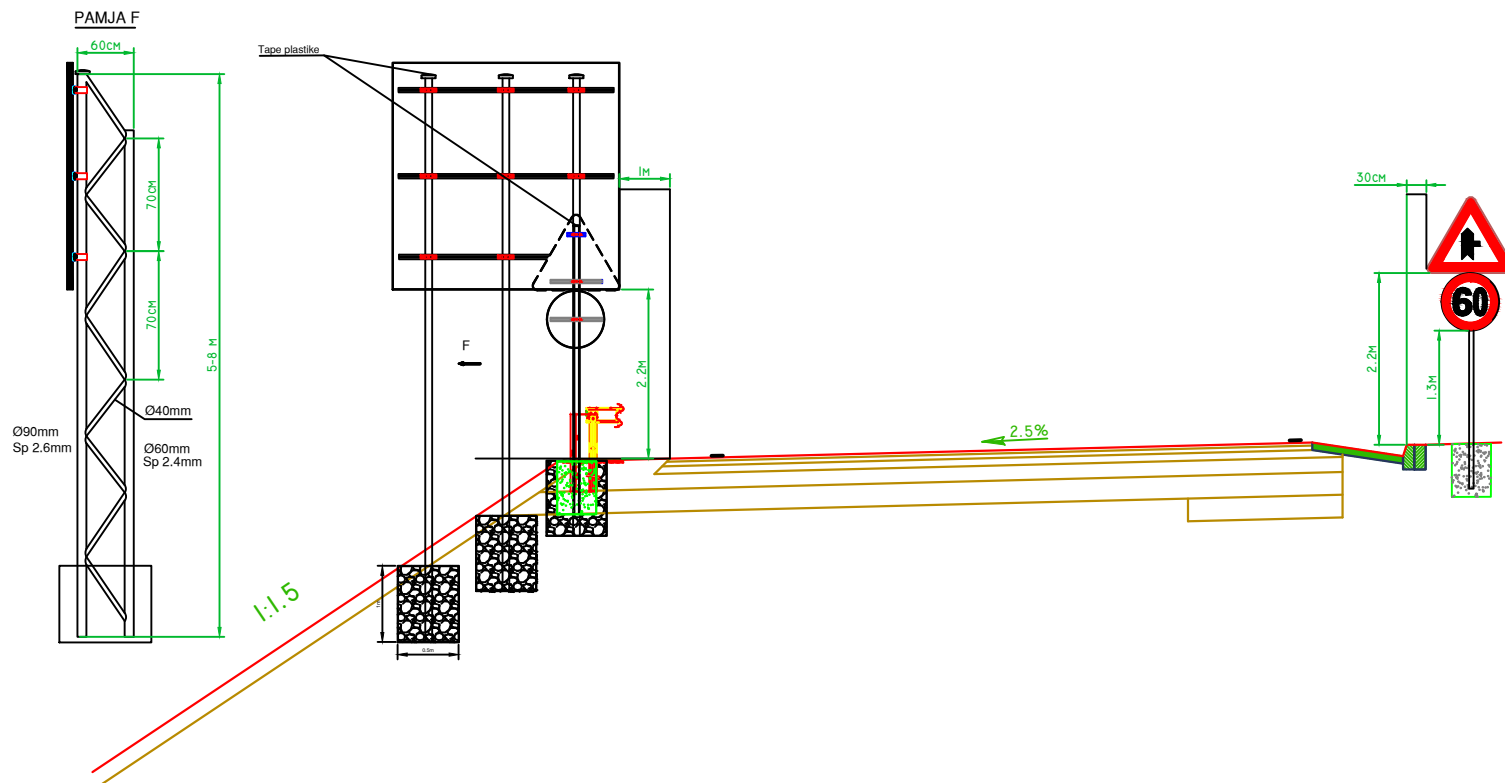

Shenim: Shenjat rrugore per nga forma, madhesia, ngjyra reflektiviteti duhet te jene sipas Kodit Rrugor te Republikes se Shqiperise Materiali praparefektiv duhet te kete jetegjatesi 10vjet per Clasin 2 dhe 7 vjet per Clasin 1 Simboli brenda shenjes rrugore duhet te jete i realizuar me boje te trajtuar me pjekje e cila nuk humbet treguesit praparefektiv Shenja rrugore realizohet me llamarine çeliku e cila lyhet me boje opake kundrandra korozionitdhe trajtohet me pjekje. Tubat, bullonat, fashetat dhe konstruksionet mbajtese te shenjes duhet te xingohen ne te nxehte.

Kthese e menjehershme

shenje e ishullit te trafikut

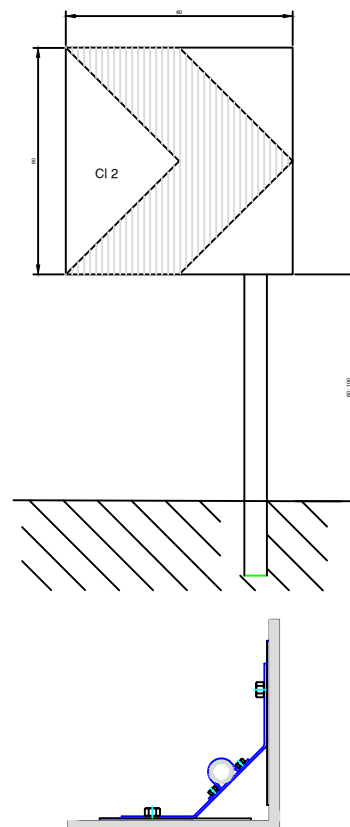
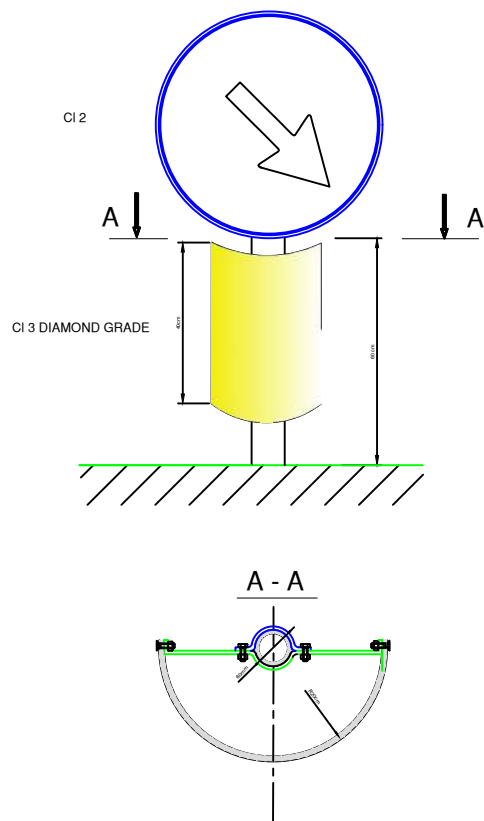

Distanca e chevrons signs

RREZJA E KTHESES	DISTANCA
100 - 200 m	20 m
200 - 400 m	30 m
> 400 m	50 m

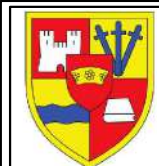
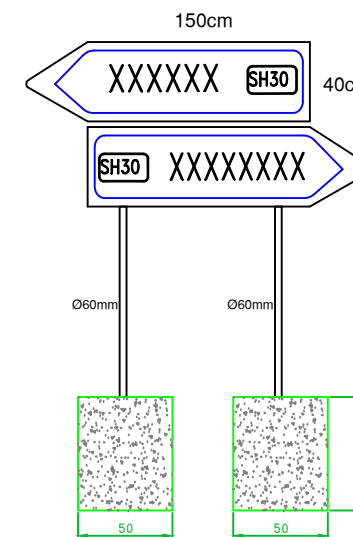
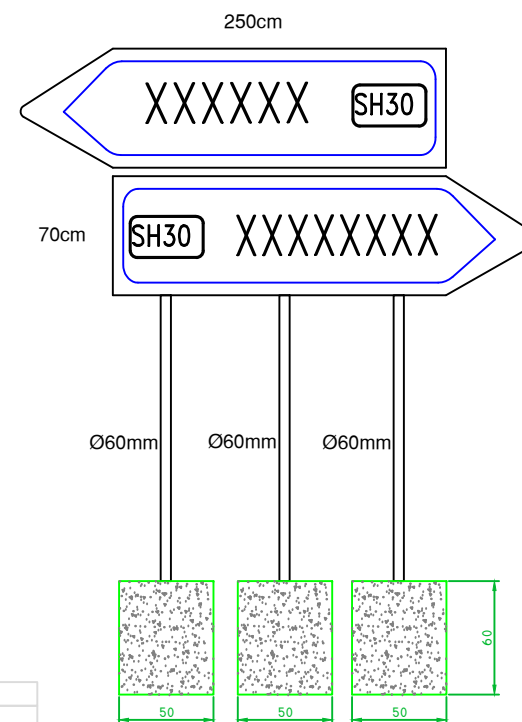

POROSITESI : BASHKIA MAT

OBJEKTI: "Ndertimi i rruges fshati Bater ,bashkia Mat"

Emertimi: Detaje sinjalistike



"Imperium Construction", shpk
Adresa: njesi Bashkiake nr.9 Rruga "Shyqyri Peza"
Pallati 21, Hyrja 1,Kati 2 ,Tirane

Drejtues i projektit

Adm. Arber TOLA

Projektues

Hidr. Elton LLAPUSHI
Inxh.Luan BETA
Ark. Rigert HYRA

Mek. Bujar MERAJ
Elek. Altin ALLKAJ
Top. Iv BEQARI

SHKALLA

1- 500

MAT 2022

FLETA

1 - 01

Format A3