

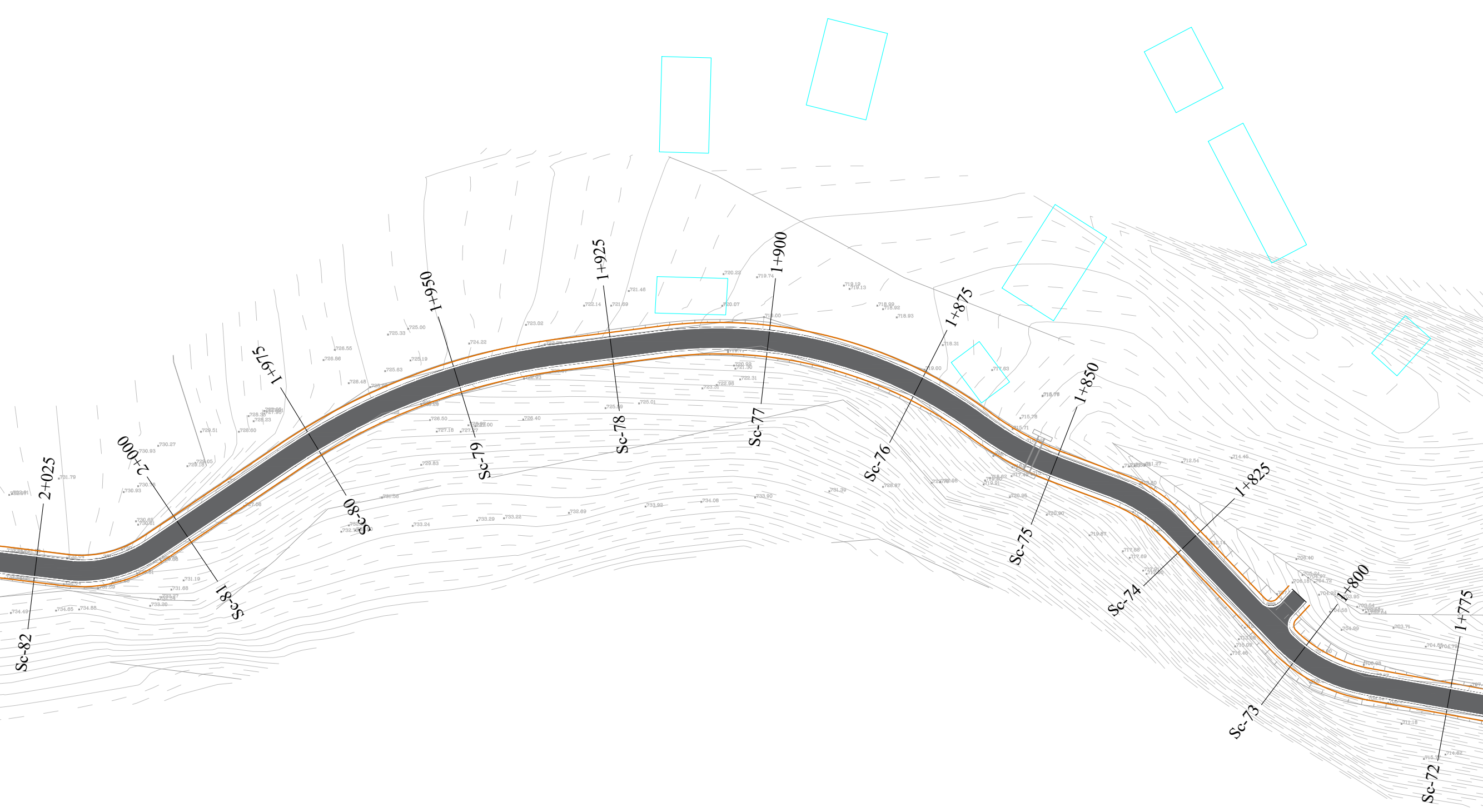

REPUBLIKA E SHQIPERISE
QARKU DIBER
BASHKIA BULQIZE

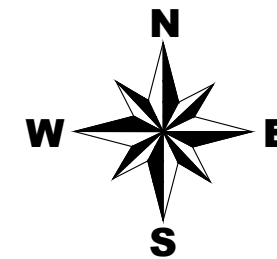

FOROSITESH:

BASHKIA BULQIZE

EMERTIMI I PROJEKTTIT :
**SISTEM-ASFALTIM I RRUGES BLLACE,
LOTI I, N.J.A. SHUPENZE,
BASHKIA BULQIZE**

FAZA E PROJEKTTIT :
PROJEKT ZBATIMI

EMERTIMI I FLETES :
PLANIMETRIA E RRUGES

SHKALLA 1:1000	NR. FLETES 08
-------------------	------------------

GRUPI I PROJEKTIMIT : **"ALBGOLDING 2E" sh.p.k**

Ing. Hajredin MURGU
Ark. Soela MERKO
Ark. Erion MURGU



"ALBGOLDING 2E" sh.p.k
CONTACT:
E-MAIL : albgolding2@gmail.com
Cel: +355 68 52 07 550
+355 68 20 85 763



REPUBLIKA E SHQIPERISE
QARKU DIBER
BASHKIA BULQIZE

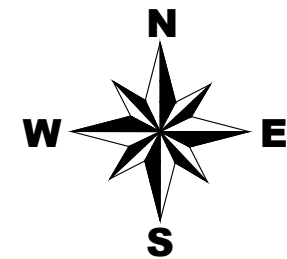

FOROSHTES:

BASHKIA BULQIZE

EMERTIMI I PROJEKTIT :

**SISTEM-ASFALTIM I RRUGES BLLACE,
LOTI I, N.J.A. SHUPENZE,
BASHKIA BULQIZE**

FAZA E PROJEKTIT :

PROJEKT ZBATIMI

EMERTIMI I FLETES :

PLANIMETRIA E RRUGES

SHKALLA 1:1000	NR. FLETES 09
-------------------	------------------

GRUPI I PROJEKTIMIT : **"ALBGOLDING 2E" sh.p.k**

Ing. Hajredin MURGU

Ark. Soela MERKO

Ark. Erion MURGU



"ALBGOLDING 2E" sh.p.k

CONTACT:
E-MAIL : albgolding2@gmail.com
Cel: +355 68 52 07 550
+355 68 20 85 763

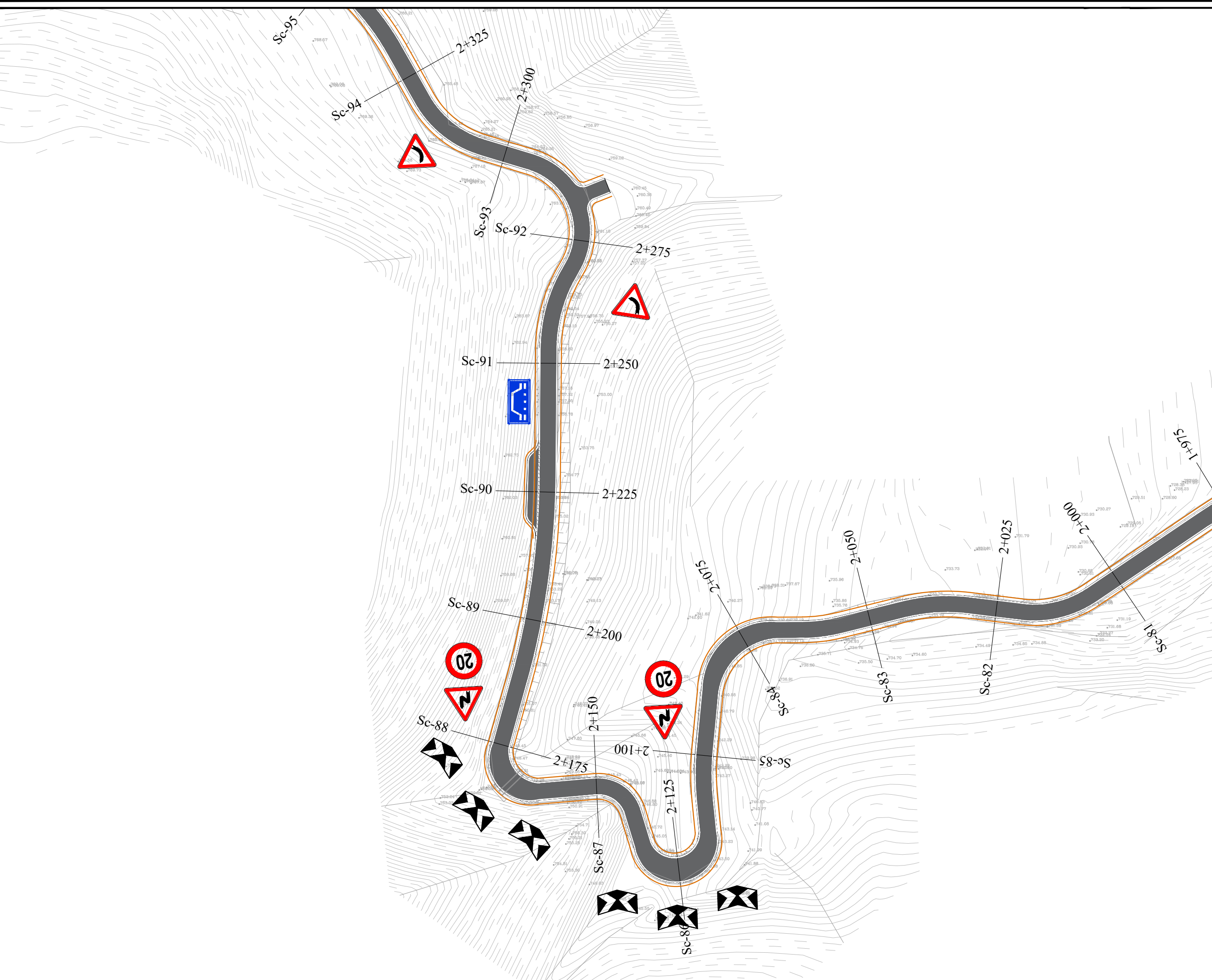



REPUBLIKA E SHQIPERISE
QARKU DIBER
BASHKIA BULQIZE

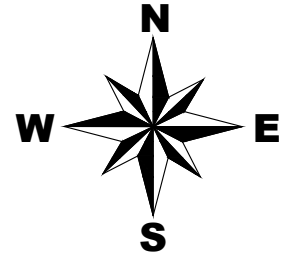

FOROSITESH:

BASHKIA BULQIZE

EMERTIMI I PROJEKTTIT :
**SISTEM-ASFALTIM I RRUGES BLLACE,
LOTI I, N.J.A. SHUPENZE,
BASHKIA BULQIZE**

FAZA E PROJEKTTIT :
PROJEKT ZBATIMI

EMERTIMI I FLETES :
PLANIMETRIA E RRUGES

SHKALLA 1:1000	NR. FLETES 10
-------------------	------------------

GRUPI I PROJEKTTIMIT : **"ALBGOLDING 2E" sh.p.k**

Ing. Hajredin MURGU
Ark. Soela MERKO
Ark. Erion MURGU

"ALBGOLDING 2E" sh.p.k

CONTACT:
E-MAIL : albgolding2@gmail.com
Cel: +355 68 52 07 550
+355 68 20 85 763

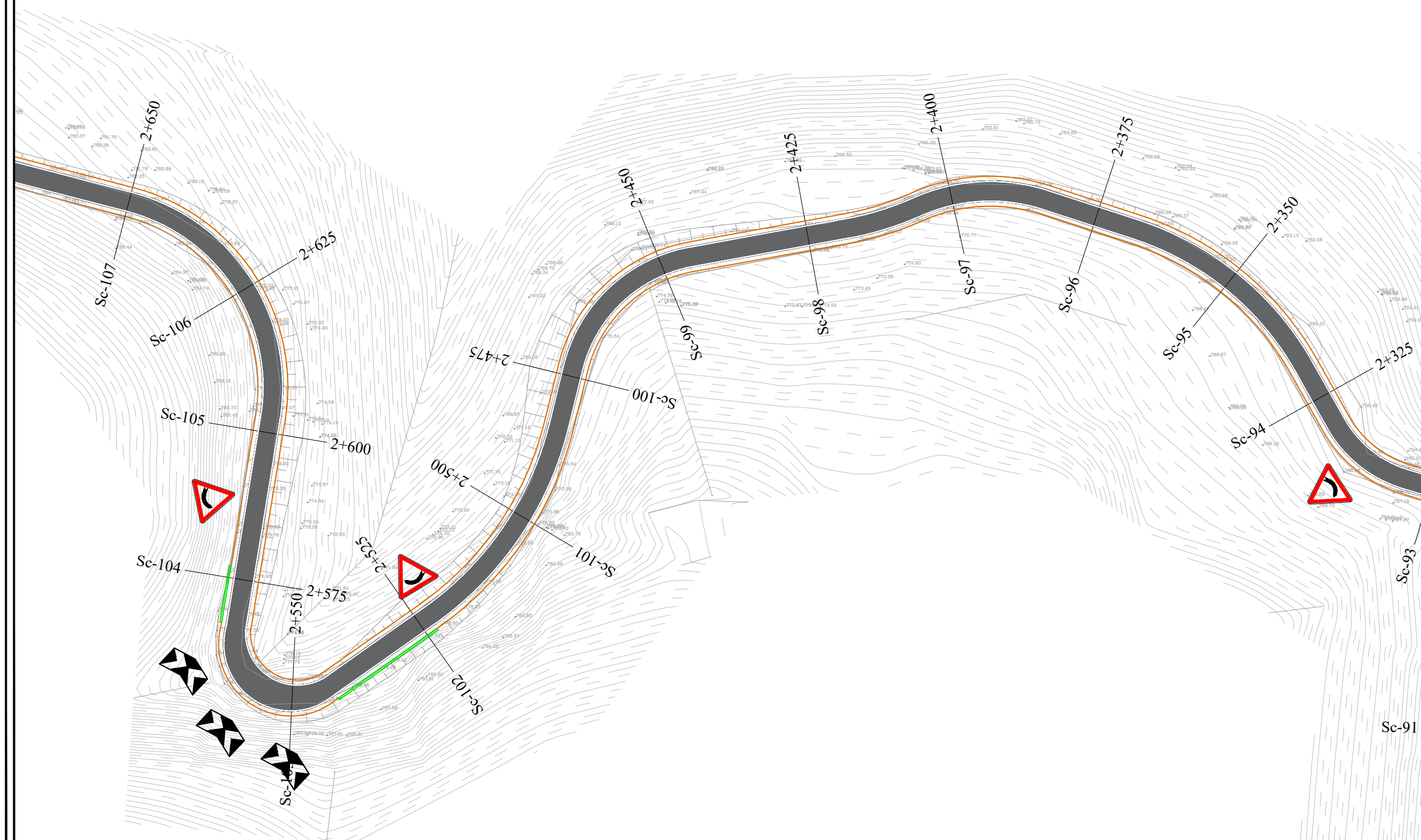

REPUBLIKA E SHQIPERISE
QARKU DIBER
BASHKIA BULQIZE

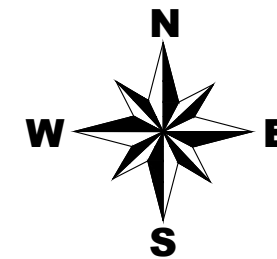

FOROSITESH:

BASHKIA BULQIZE

EMERTIMI I PROJEKTTIT :
**SISTEM-ASFALTIM I RRUGES BLLACE,
LOTI I, NJ.A. SHUPENZE,
BASHKIA BULQIZE**

FAZA E PROJEKTTIT :
PROJEKT ZBATIMI

EMERTIMI I FLETES :
PLANIMETRIA E RRUGES

SHKALLA 1:1000	NR. FLETES 11
-------------------	------------------

GRUPI I PROJEKTIMIT : **"ALBGOLDING 2E" sh.p.k**

Ing. Hajredin MURGU
Ark. Soela MERKO
Ark. Erion MURGU

"ALBGOLDING 2E" sh.p.k

CONTACT:
E-MAIL : albgolding2@gmail.com
Cel: +355 68 52 07 550
+355 68 20 85 763

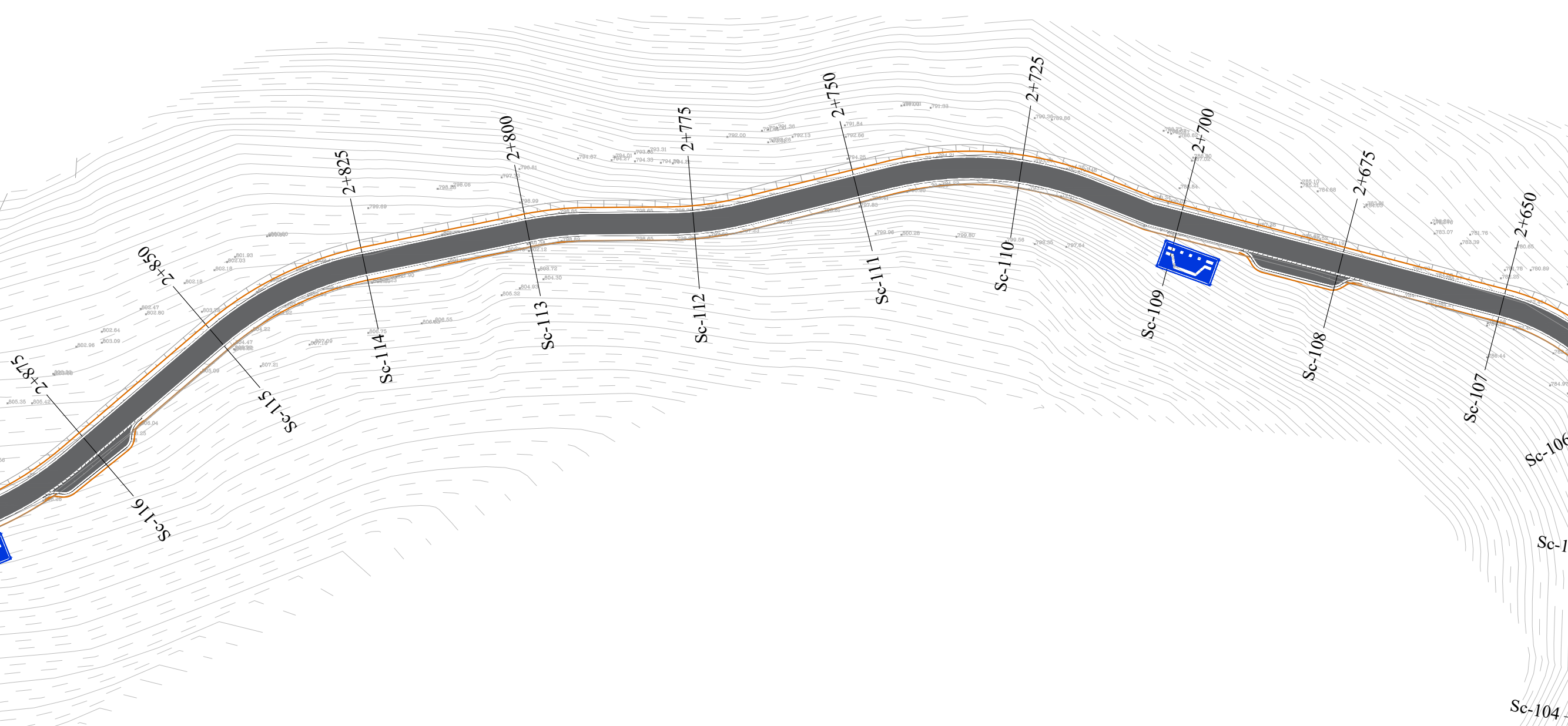



REPUBLIKA E SHQIPERISE
QARKU DIBER
BASHKIA BULQIZE

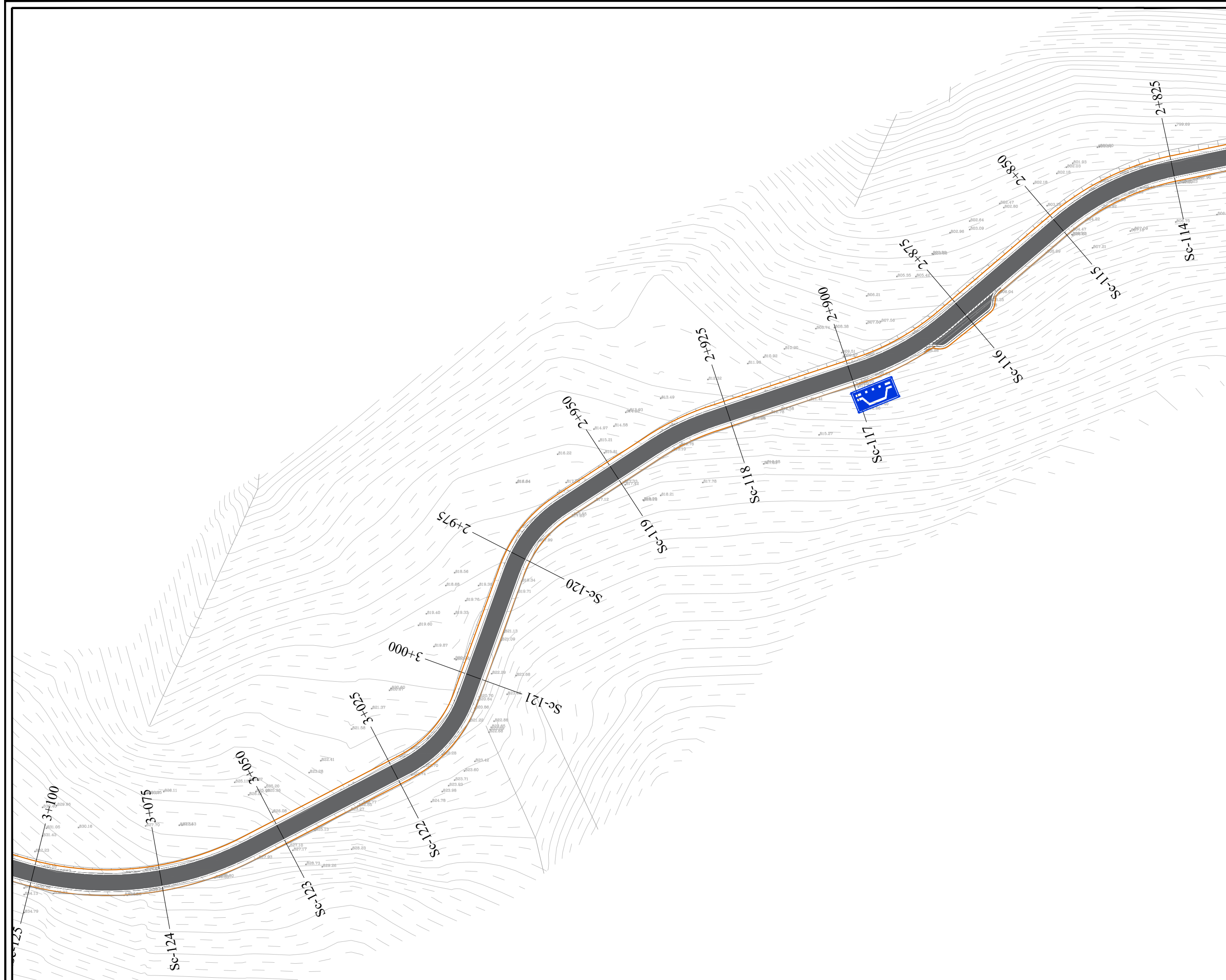
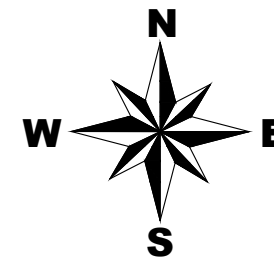

FOROSTITESH:

BASHKIA BULQIZE

EMERTIMI I PROJEKTTIT :

**SISTEM-ASFALTIM I RRUGES BLLACE,
LOTI I, N.J.A. SHUPENZE,
BASHKIA BULQIZE**

FAZA E PROJEKTTIT :

PROJEKT ZBATIMI

EMERTIMI I FLETES :

PLANIMETRIA E RRUGES

SHKALLA 1:1000	NR. FLETES 12
-------------------	------------------

GRUPI I PROJEKTTIMIT : **"ALBGOLDING 2E" sh.p.k**

Ing. Hajredin MURGU

Ark. Soela MERKO

Ark. Erion MURGU



"ALBGOLDING 2E" sh.p.k

CONTACT:
E-MAIL : albgolding2@gmail.com
Cel: +355 68 52 07 550
+355 68 20 85 763



REPUBLIKA E SHQIPERISE
QARKU DIBER
BASHKIA BULQIZE

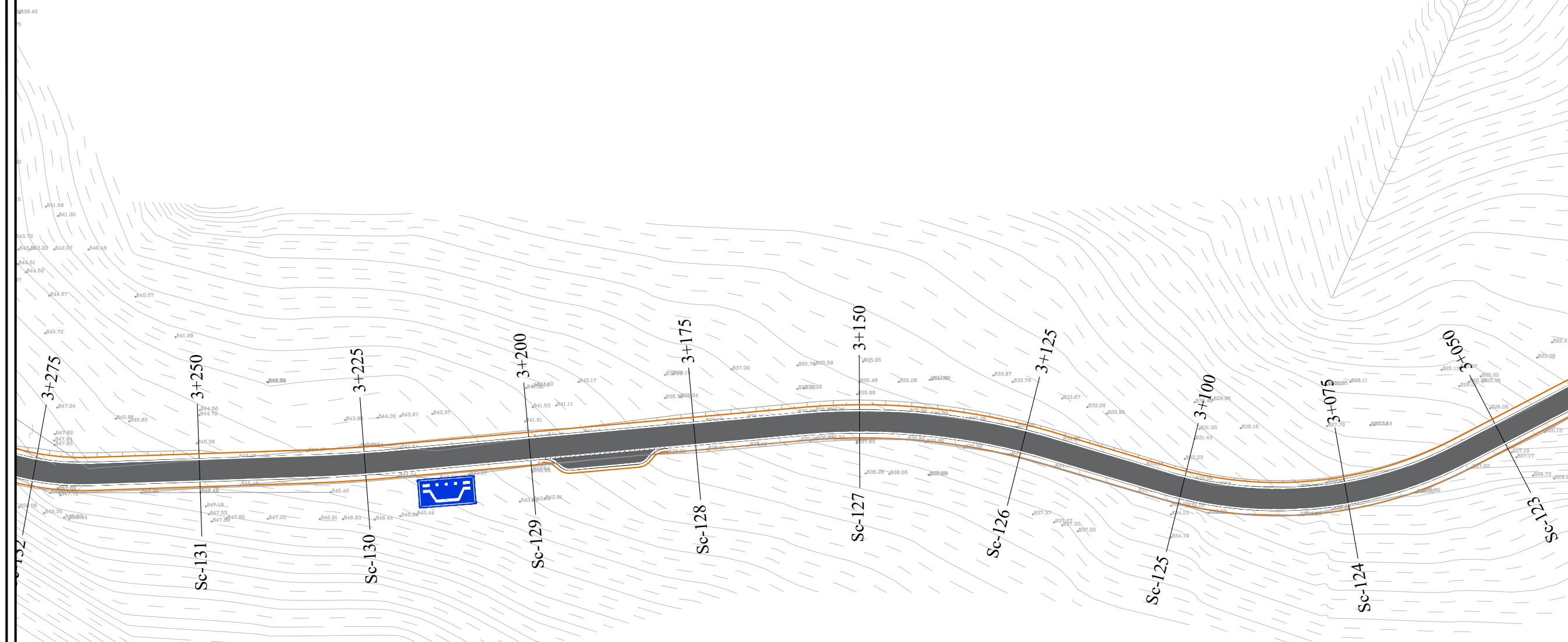
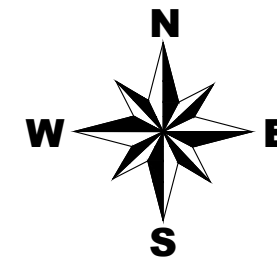

FOROSHTESH:

BASHKIA BULQIZE

EMERTIMI I PROJEKTTIT :

**SISTEM-ASFALTIM I RRUGES BLLACE,
LOTI I, N.J.A. SHUPENZE,
BASHKIA BULQIZE**

FAZA E PROJEKTTIT :

PROJEKT ZBATIMI

EMERTIMI I FLETES :

PLANIMETRIA E RRUGES

SHKALLA 1:1000	NR. FLETES 13
-------------------	------------------

GRUPI I PROJEKTIMIT : "ALBGOLDING 2E" sh.p.k

Ing. Hajredin MURGU

Ark. Soela MERKO

Ark. Erion MURGU



"ALBGOLDING 2E" sh.p.k

CONTACT:
E-MAIL : albgolding2@gmail.com
Cel: +355 68 52 07 550
+355 68 20 85 763



REPUBLIKA E SHQIPERISE
QARKU DIBER
BASHKIA BULQIZE

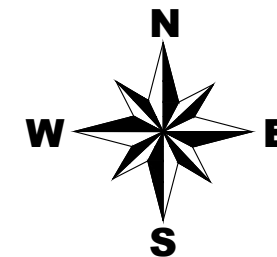

FOROSHTES:

BASHKIA BULQIZE

EMERTIMI I PROJEKTTIT :

**SISTEM-ASFALTIM I RRUGES BLLACE,
LOTI I, N.J.A. SHUPENZE,
BASHKIA BULQIZE**

FAZA E PROJEKTTIT :

PROJEKT ZBATIMI

EMERTIMI I FLETES :

PLANIMETRIA E RRUGES

SHKALLA	NR. FLETES
1:1000	14

GRUPI I PROJEKTIMIT : "ALBGOLDING 2E" sh.p.k

Ing. Hajredin MURGU

Ark. Soela MERKO

Ark. Erion MURGU



"ALBGOLDING 2E" sh.p.k

CONTACT:
E-MAIL : albgolding2@gmail.com
Cel: +355 68 52 07 550
+355 68 20 85 763

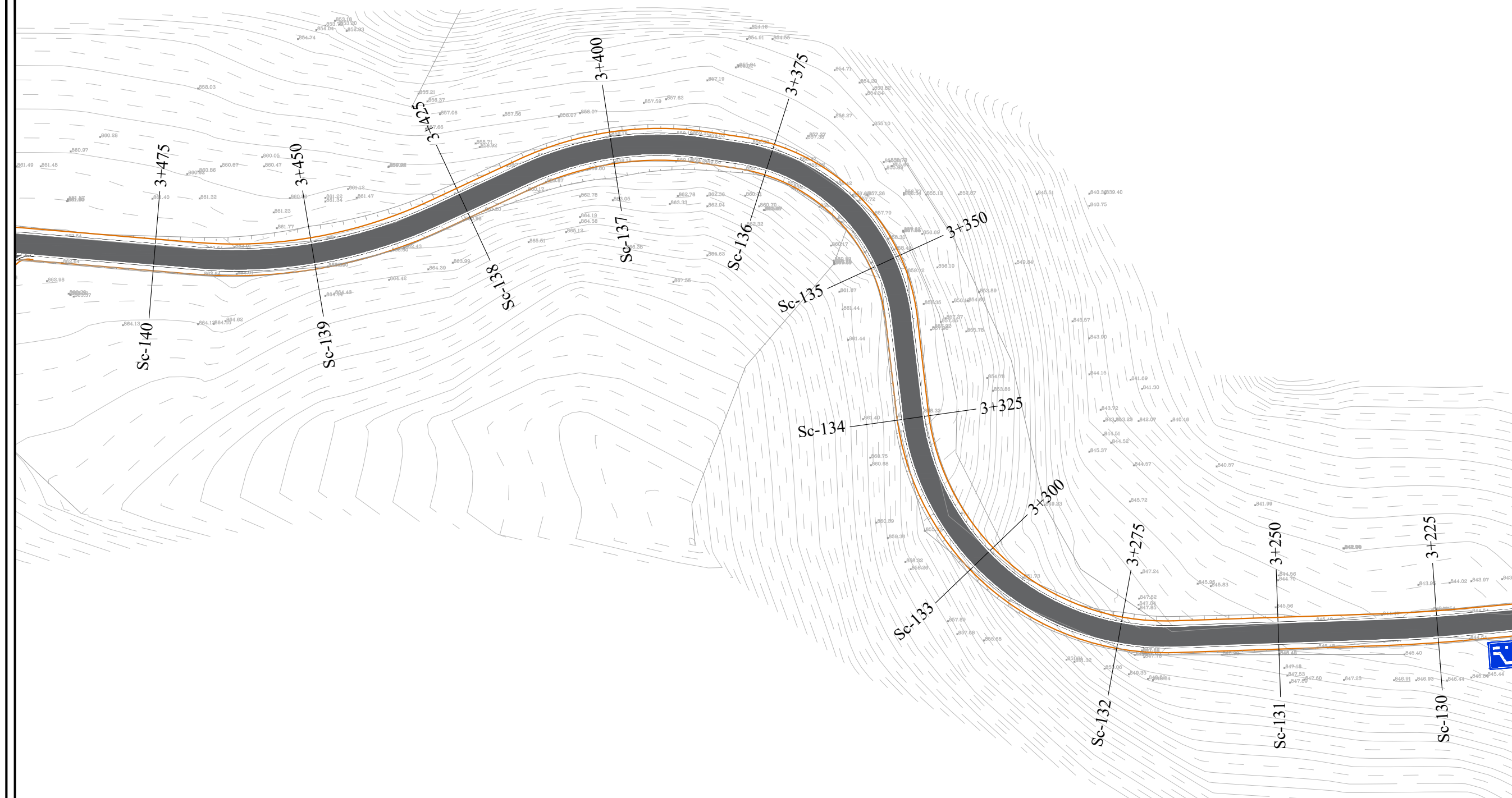



REPUBLIKA E SHQIPERISE
QARKU DIBER
BASHKIA BULQIZE

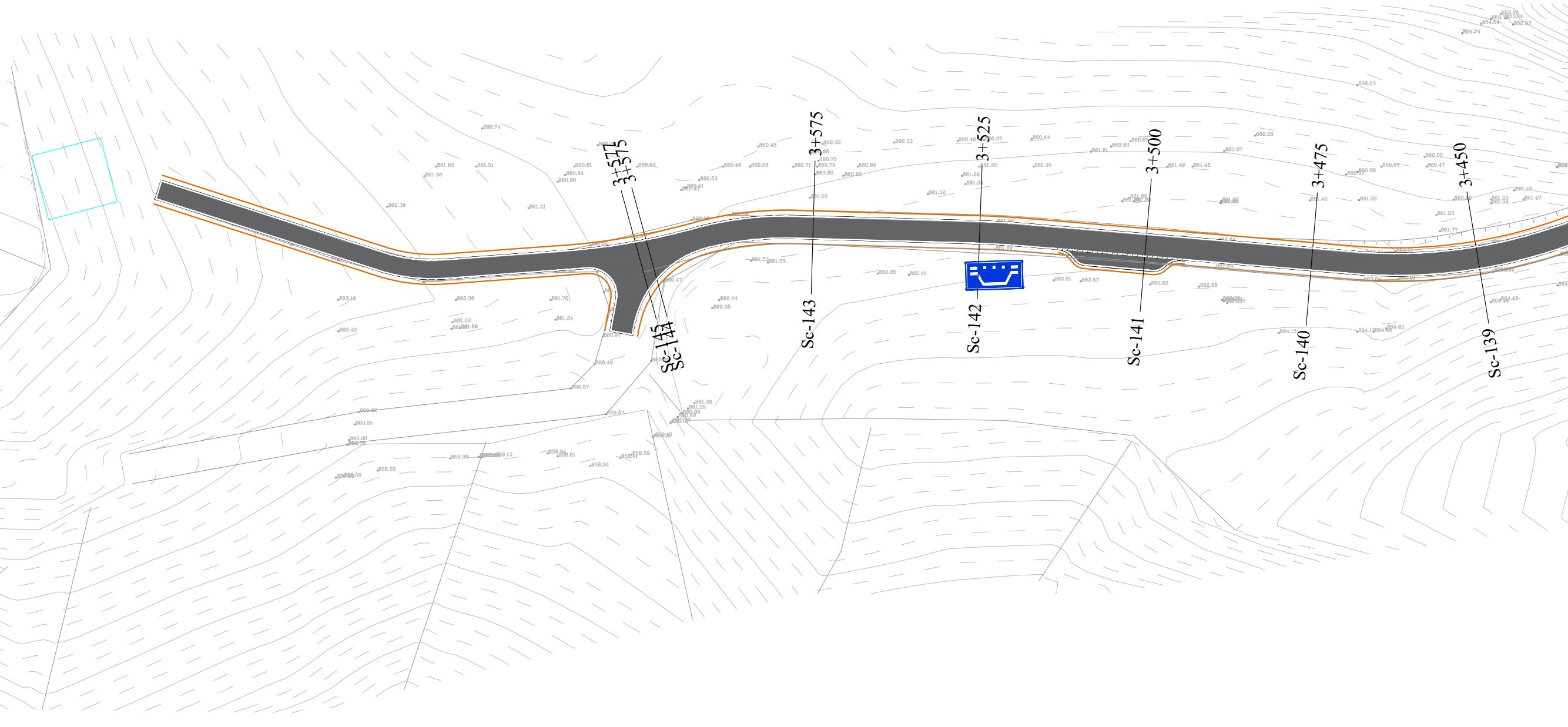
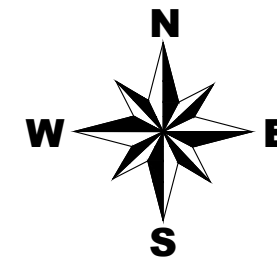

FOROSITESH:

BASHKIA BULQIZE

EMERTIMI I PROJEKTTIT :

**SISTEM-ASFALTIM I RRUGES BLLACE,
LOTI I, N.J.A. SHUPENZE,
BASHKIA BULQIZE**

FAZA E PROJEKTTIT :

PROJEKT ZBATIMI

EMERTIMI I FLETES :

PLANIMETRIA E RRUGES

SHKALLA 1:1000	NR. FLETES 15
-------------------	------------------

GRUPI I PROJEKTIMIT :

"ALBGOLDING 2E" sh.p.k

Ing. Hajredin MURGU

Ark. Soela MERKO

Ark. Erion MURGU



"ALBGOLDING 2E" sh.p.k

CONTACT:
E-MAIL : albgolding2@gmail.com
Cel: +355 68 52 07 550
+355 68 20 85 763



REPUBLIKA E SHQIPERISE
QARKU DIBER
BASHKIA BULQIZE

PROJEKT ZBATIMI

OBJEKTI:
SISTEM-ASFALTIM I RRUGES BLLACE, LOTI I,
NJ.A. SHUPENZE, BASHKIA BULQIZE

PROFILI TERTHOR TIP

FOROSITESH:

BASHKIA BULQIZE

EMERTIMI I PROJEKTTIT :

**SISTEM-ASFALTIM I RRUGES BLLACE,
LOTI I, NJ.A. SHUPENZE,
BASHKIA BULQIZE**

FAZA E PROJEKTTIT :

PROJEKT ZBATIMI

EMERTIMI I FLETES :

KAPAKU

SHKALLA
1:1000

NR. FLETES

GRUPI I PROJEKTIMIT :

"ALBGOLDING 2E" sh.p.k

Ing. Hajredin MURGU

Ark. Soela MERKO

Ark. Erion MURGU



"ALBGOLDING 2E" sh.p.k

CONTACT:

E-MAIL : albgolding2e@gmail.com

Cel: +355 68 52 07 550

+355 68 20 85 763



PROFIL TERTHOR TIP I SHK. 1:50

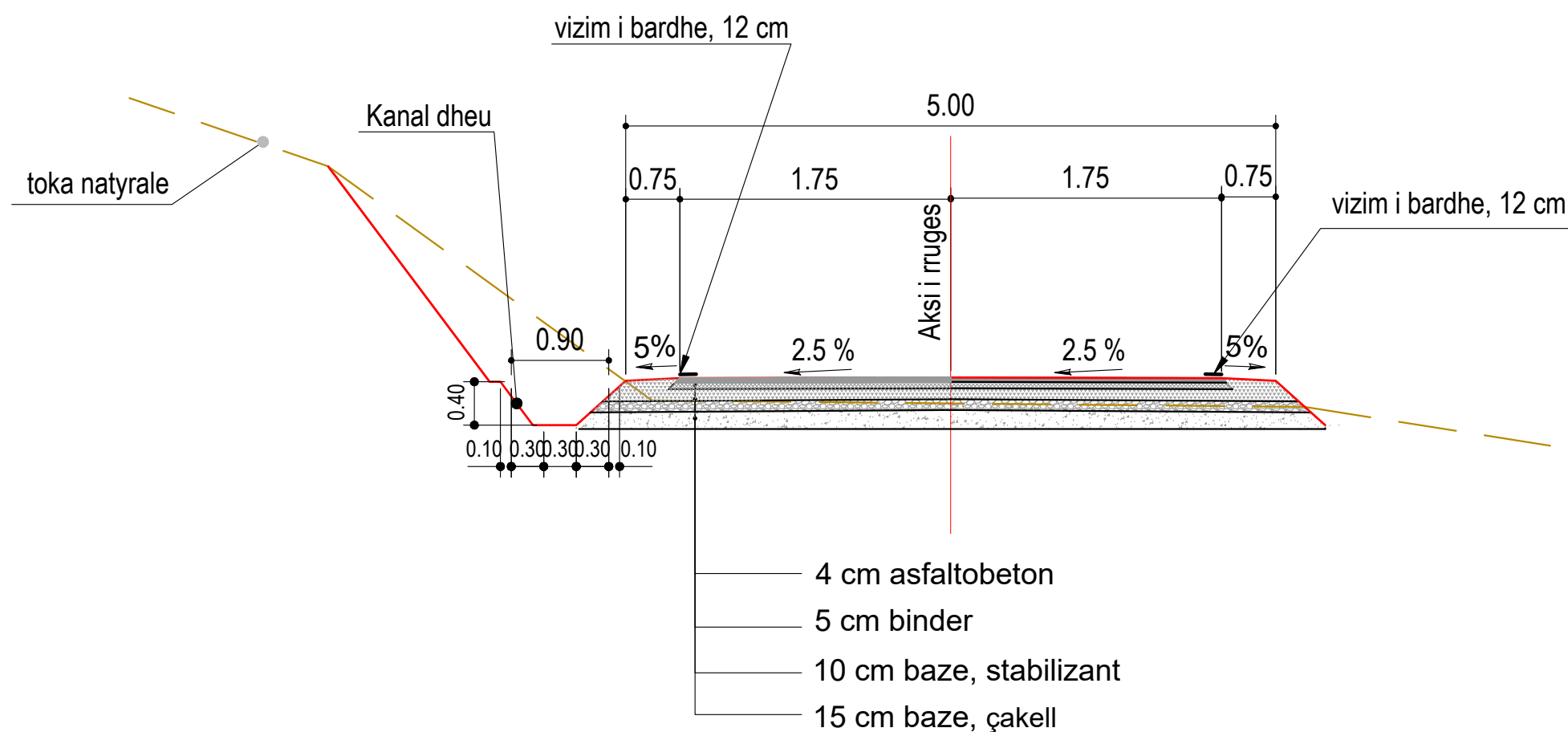

FOROSITESH:

BASHKIA BULQIZE

EMERTIMI I PROJEKTTIT :

**SISTEM-ASFALTIM I RRUGES BLLACE,
LOTI I, N.J.A. SHUPENZE,
BASHKIA BULQIZE**

FAZA E PROJEKTTIT :

PROJEKT ZBATIMI

EMERTIMI I FLETES :

PROFILI TERTHOR TIP

SHKALLA	NR. FLETES
1:50	01

GRUPI I PROJEKTTIMIT : **"ALBGOLDING 2E" sh.p.k**

Ing. Hajredin MURGU

Ark. Soela MERKO

Ark. Erion MURGU



"ALBGOLDING 2E" sh.p.k

CONTACT:
E-MAIL : albgolding2@gmail.com
Cel: +355 68 52 07 550
+355 68 20 85 763



PROFIL TERTHOR TIP 2 SHK. 1:50

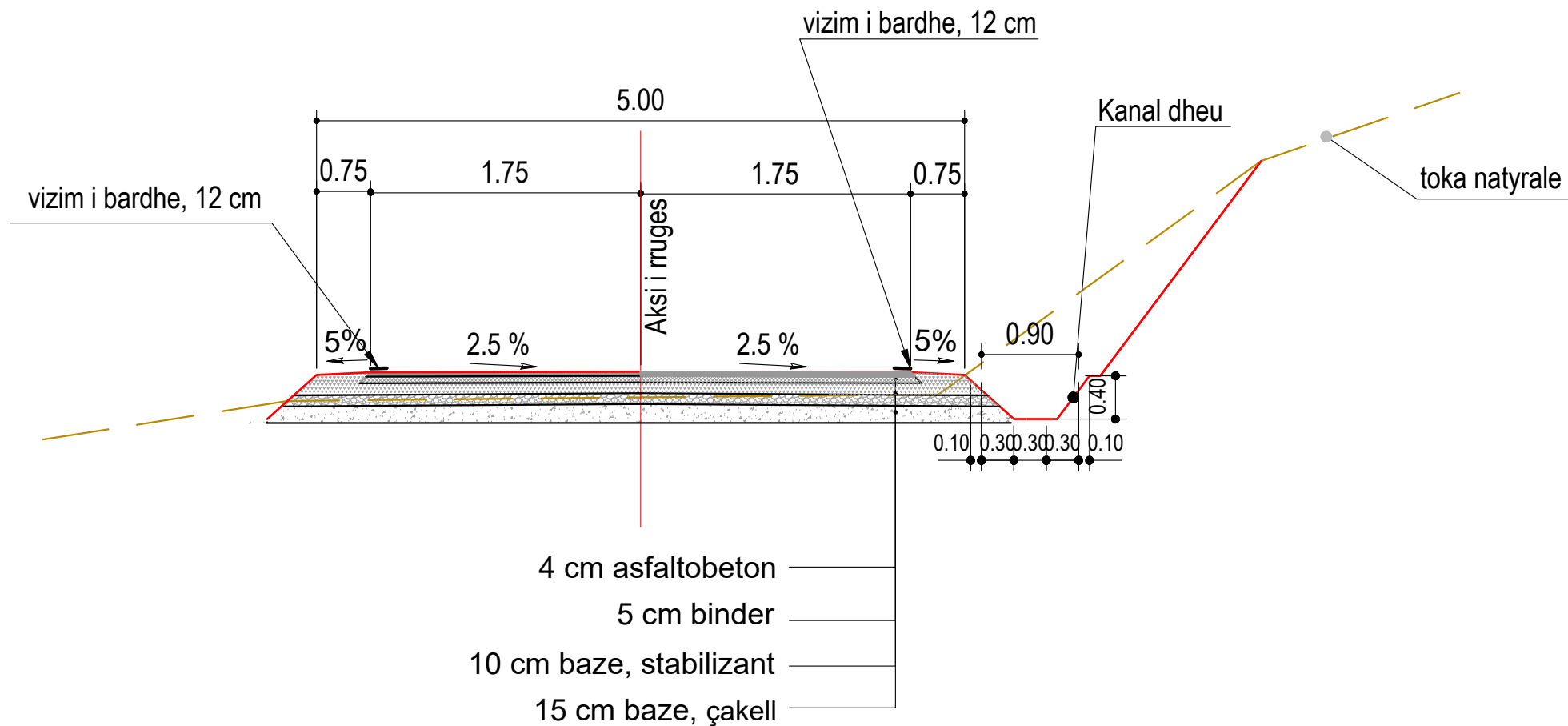

FOROSITESH:

BASHKIA BULQIZE

EMERTIMI I PROJEKTIT :

**SISTEM-ASFALTIM I RRUGES BLLACE,
LOTI I, N.J.A. SHUPENZE,
BASHKIA BULQIZE**

FAZA E PROJEKTIT :

PROJEKT ZBATIMI

EMERTIMI I FLETES :

PROFILI TERTHOR TIP

SHKALLA	NR. FLETES
1:50	02

GRUPI I PROJEKTIMIT : **"ALBGOLDING 2E" sh.p.k**

Ing. Hajredin MURGU

Ark. Soela MERKO

Ark. Erion MURGU



"ALBGOLDING 2E" sh.p.k

CONTACT:
E-MAIL : albgolding2@gmail.com
Cel: +355 68 52 07 550
+355 68 20 85 763



PROFIL TERTHOR TIP 3 SHK. 1:50

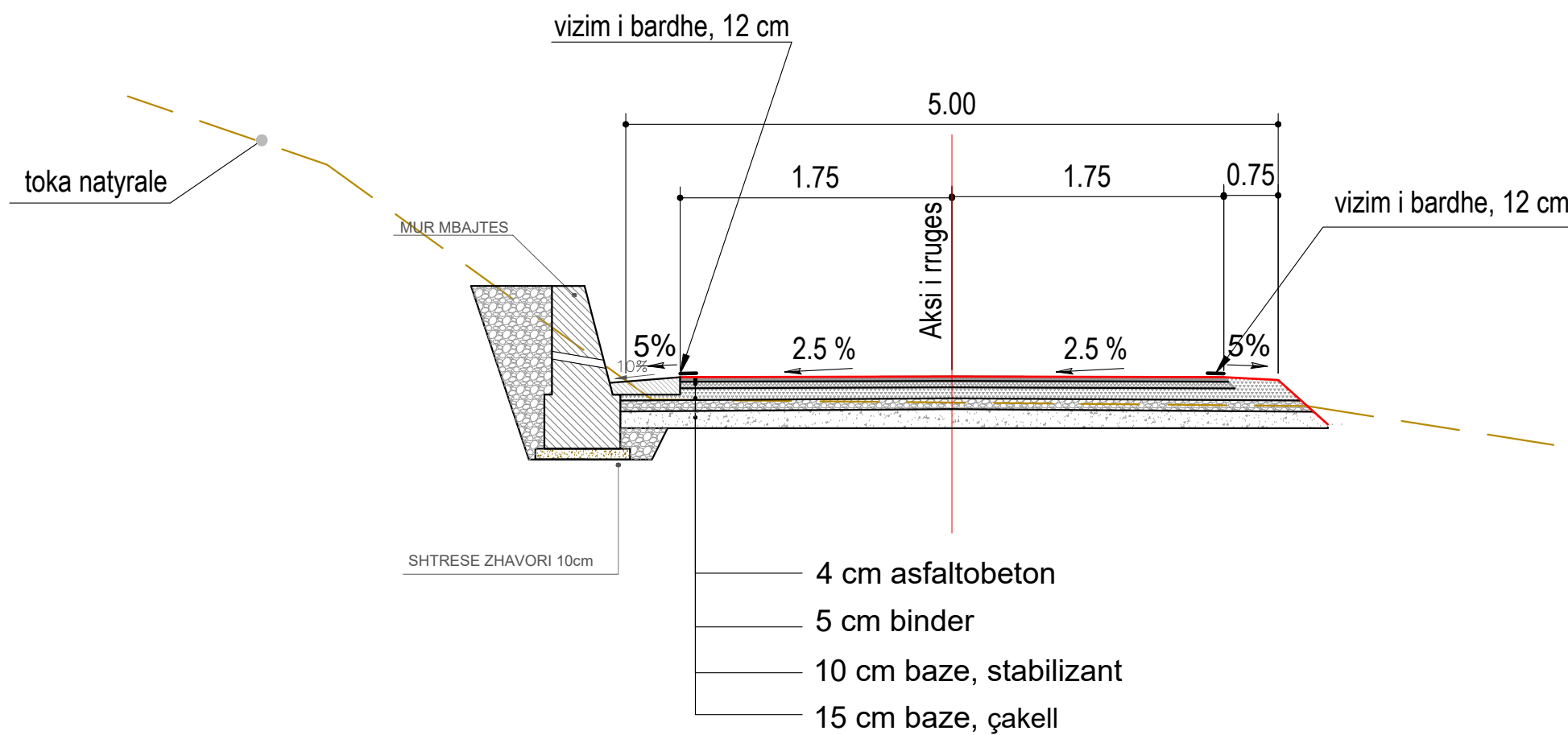

FOROSITESH:

BASHKIA BULQIZE

EMERTIMI I PROJEKTTIT :

**SISTEM-ASFALTIM I RRUGES BLLACE,
LOTI I, N.J.A. SHUPENZE,
BASHKIA BULQIZE**

FAZA E PROJEKTTIT :

PROJEKT ZBATIMI

EMERTIMI I FLETES :

PROFILI TERTHOR TIP

SHKALLA 1:50	NR. FLETES 03
-----------------	------------------

GRUPI I PROJEKTIMIT : **"ALBGOLDING 2E" sh.p.k**

Ing. Hajredin MURGU

Ark. Soela MERKO

Ark. Erion MURGU



"ALBGOLDING 2E" sh.p.k

CONTACT:
E-MAIL : albgolding2@gmail.com
Cel: +355 68 52 07 550
+355 68 20 85 763



REPUBLIKA E SHQIPERISE
QARKU DIBER
BASHKIA BULQIZE

PROJEKT ZBATIMI

OBJEKTI:
SISTEM-ASFALTIM I RRUGES BLLACE, LOTI I,
NJ.A. SHUPENZE, BASHKIA BULQIZE

PROFILI GJATESOR

FOROSITESH:

BASHKIA BULQIZE

EMERTIMI I PROJEKTTIT :

**SISTEM-ASFALTIM I RRUGES BLLACE,
LOTI I, NJ.A. SHUPENZE,
BASHKIA BULQIZE**

FAZA E PROJEKTTIT :

PROJEKT ZBATIMI

EMERTIMI I FLETES :

KAPAKU

SHKALLA
1:200

NR. FLETES

GRUPI I PROJEKTIMIT :

"ALBGOLDING 2E" sh.p.k

Ing. Hajredin MURGU

Ark. Soela MERKO

Ark. Erion MURGU



"ALBGOLDING 2E" sh.p.k

CONTACT:

E-MAIL : albgolding2@gmail.com

Cel: +355 68 52 07 550

+355 68 20 85 763



REPUBLIKA E SHQIPERISE
QARKU DIBER
BASHKIA BULQIZE

PJERRESIA	D= -1.37 p= -5.48% L= 25.00 m.	D= 2.07 p= 2.77% L= 75.00 m.	D= 0.59 p= 1.17% L= 50.00 m.	D= 3.13 p= 12.51% L= 25.00 m.	D= 4.15 p= 8.30% L= 50.00 m.	D= 3.05 p= 6.10% L= 50.00 m.	D= 0.67 p= 2.68% L= 25.00 m.	D= 0.18 p= 0.55% L= 33.2
RAKORDIMET	f= 0.21 m. R= 250.00 m. Lv/2= 10.31 m. Prog. 25.00 m.	f= -0.02 m. R= 500.00 m. Lv/2= 3.98 m. Prog. 100.00 m.	f= 0.24 m. R= 150.00 m. Lv/2= 8.50 m. Prog. 150.00 m.	f= -0.11 m. R= 500.00 m. Lv/2= 10.52 m. Prog. 175.00 m.	f= -0.03 m. R= 500.00 m. Lv/2= 5.49 m. Prog. 225.00 m.	f= -0.04 m. R= 300.00 m. Lv/2= 5.14 m. Prog. 275.00 m.	f= -0.03 m. R= 500.00 m. Lv/2= 5.34 m. Prog. 300.00 m.	

LEGJENDA:
 Vija e Projektit Asfalti
 Vija e Terrenit

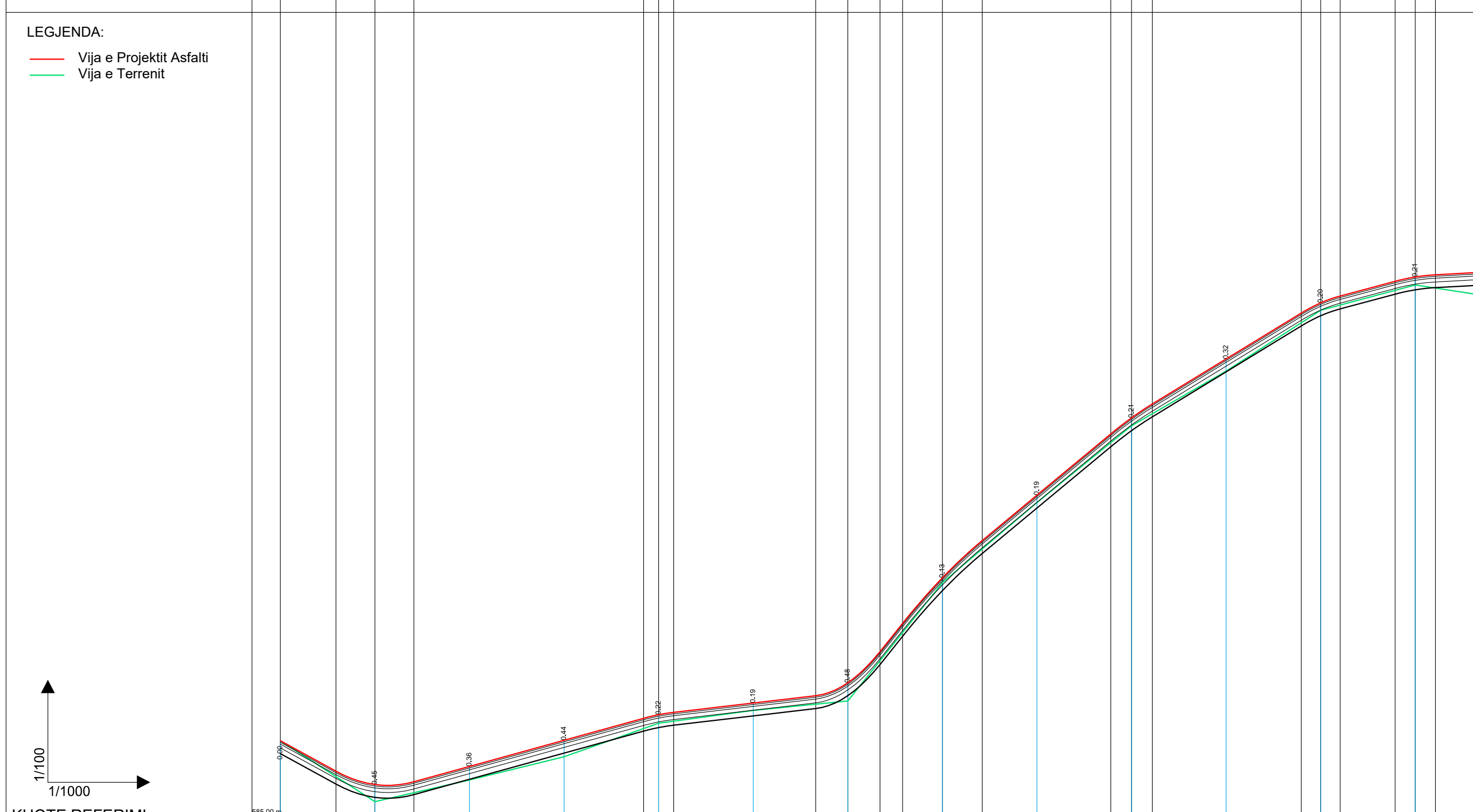

SEKSIONET	S1	S2	S3	S4	S5	S6	S7	S8	S9	S10	S11	S12	S13	
KUOTE TERRENI	597.12	596.51	596.08	596.69	597.58	597.92	598.17	591.30	593.42	595.45	596.89	598.50	598.17	
KUOTE PROJEKTI	597.12	596.96	596.44	597.13	597.81	598.12	598.65	591.42	593.61	595.66	597.21	598.69	598.38	
DISNIVELI	0.00	0.45	0.36	0.44	0.22	0.19	0.48	0.13	0.19	0.21	0.32	0.20	0.21	
DISTANCA PJESORE	25.00	25.00	25.00	25.00	25.00	25.00	25.00	25.00	25.00	25.00	25.00	25.00	25.00	
DISTANCA PROGRESIVE KILOMETRAZHI	0.00	25.00	50.00	75.00	100.00	125.00	150.00	175.00	200.00	225.00	250.00	275.00	300.00	
KURBAT	L=7.566 Sv=19.116 Sx=3.50% Dx=2.50%	L=16.763 Sv=18.253 Sx=3.50% Dx=3.50%	L=34.142 Sv=20.839 Sx=3.50% Dx=3.50%	L=14.733 Sv=16.698 Sx=3.50% Dx=3.50%	L=43.895 Sv=27.67 Sx=3.50% Dx=3.50%	L=16.002 Sv=17.67 Sx=3.50% Dx=3.50%	L=22.377 Sv=20.43 Sx=3.50% Dx=3.50%	L=15.809 Sv=34.421 Sx=3.50% Dx=3.50%	L=17.519 Sv=2.019 Sx=3.50% Dx=3.50%					
MBILARTESIMET														

FOROSITESH:
BASHKIA BULQIZE
 EMERTIMI I PROJEKTTIT :
SISTEM-ASFALTIM I RRUGES BLLACE,
LOTI I, NJ.A. SHUPENZE,
BASHKIA BULQIZE
 FAZA E PROJEKTTIT :
PROJEKT ZBATIMI
 EMERTIMI I FLETES :
PROFILI GJATESOR

SHKALLA H-1:1000 V-1:100	NR. FLETES 01
-----------------------------	------------------

GRUPI I PROJEKTTIMIT : **"ALBGOLDING 2E" sh.p.k**

Ing. Hajredin MURGU
 Ark. Soela MERKO
 Ark. Erion MURGU

"ALBGOLDING 2E" sh.p.k
 CONTACT:
 E-MAIL : albgolding2@gmail.com
 Cel: +355 68 52 07 550
 +355 68 20 85 763



REPUBLIKA E SHQIPERISE
QARKU DIBER
BASHKIA BULQIZE

PJERRESIA	D= 0.18 p= 0.55% L= 33.20 m.	D= 6.80 p= 8.63% L= 78.78 m.	D= 3.76 p= 9.90% L= 38.02 m.	D= 6.27 p= 12.55% L= 50.00 m.	D= 2.13 p= 8.51% L= 25.00 m.	D= 3.07 p= 12.28% L= 25.00 m.	D= 1.17 p= 4.69% L= 25.00 m.	D= 0.11 p= 0.22% L= 50.00 m.
RAKORDIMET	f= 0.16 m. R= 200.00 m. L/2= 8.08 m. Prog. 333.20 m.	f= 0.01 m. R= 500.00 m. L/2= 5.17 m. Prog. 411.98 m.	f= 0.04 m. R= 500.00 m. L/2= 6.63 m. Prog. 450.00 m.	f= -0.06 m. R= 300.00 m. L/2= 5.06 m. Prog. 500.00 m.	f= 0.05 m. R= 300.00 m. L/2= 5.86 m. Prog. 525.00 m.	f= -0.18 m. R= 250.00 m. L/2= 9.48 m. Prog. 550.00 m.	f= -0.07 m. R= 300.00 m. L/2= 6.71 m. Prog. 575.00 m.	f= 0.09 m. R= 200.00 m. L/2= 5.08 m. Prog. 625.00 m.

LEGJENDA:
— Vija e Projektit Asfalti
— Vija e Terrenit

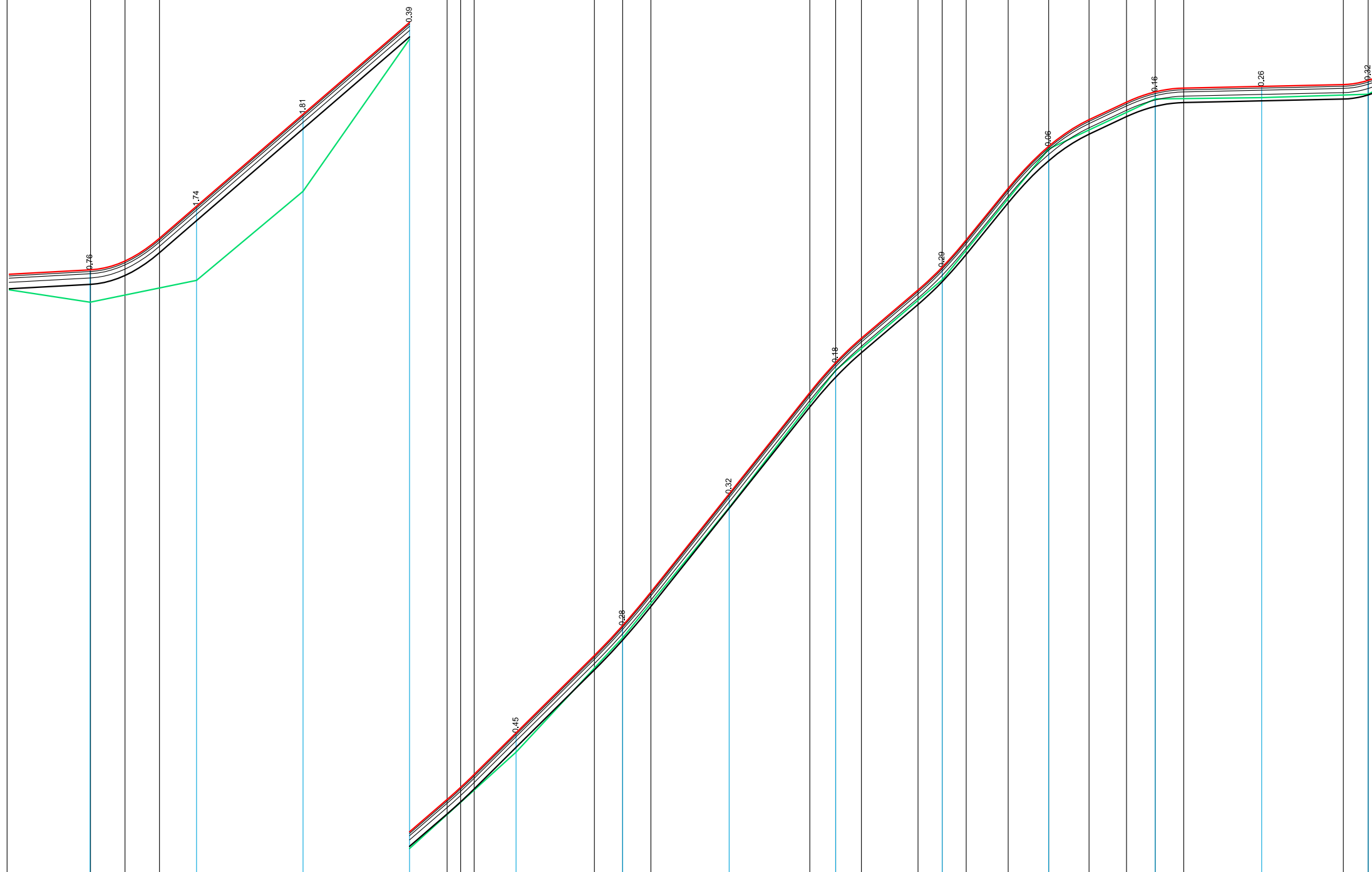

1/100
1/1000

KUOTE REFERIMI	604.00 m.																
SEKSIONET	S14	S15	S16	S17	S18	S19	S20	S21	S22	S23	S24	S25	S26				
KUOTE TERRENI	598.79	599.30	601.39	604.96	607.22	609.91	612.96	616.18	618.31	621.38	622.56	622.59	622.67				
KUOTE PROJEKTI	599.54	601.04	603.20	605.35	607.68	610.19	613.29	616.36	618.61	621.44	622.72	622.85	622.99				
DISNIVELI	0.76	1.74	1.81	0.39	0.45	0.28	0.32	0.18	0.29	0.06	0.16	0.26	0.32				
DISTANCA PJESORE	25.00	25.00	25.00	25.00	25.00	25.00	25.00	25.00	25.00	25.00	25.00	25.00	25.00				
DISTANCA PROGRESIVE	325.00	350.00	375.00	400.00	425.00	450.00	475.00	500.00	525.00	550.00	575.00	600.00	625.00				
KILOMETRAZHI				4				5				6					
KURBAT	s=2.019	L=38.926	Sv=62.991 R=40 Tg=40.160 Bs=16.681		L=47.210	Sv=48.590 R=100 Tg=24.785 Bs=3.026		L=64.265		Sv=21.034 R=100 Tg=11.885 Bs=1.385	L=19.248		Sv=10.467 R=100 Tg=5.930 Bs=0.680				
MBILARTESIMET	Dx=3.50% Sx=3.50%	Dx=3.50% Sx=3.50%	Dx=3.50% Sx=3.50%	Dx=3.50% Sx=3.50%	Dx=3.50% Sx=3.50%	Dx=3.50% Sx=3.50%	Dx=3.50% Sx=3.50%	Dx=3.50% Sx=3.50%	Dx=3.50% Sx=3.50%	Dx=3.50% Sx=3.50%	Dx=3.50% Sx=3.50%	Dx=3.50% Sx=3.50%	Dx=3.50% Sx=3.50%				

FOROSITESH:
BASHKIA BULQIZE

EMERTIMI I PROJEKTTIT:
**SISTEM-ASFALTIM I RRUGES BLLACE,
LOTI I, N.J.A. SHUPENZE,
BASHKIA BULQIZE**

FAZA E PROJEKTTIT:
PROJEKT ZBATIMI

EMERTIMI I FLETES:
PROFILI GJATESOR

SHKALLA H-1:1000 V-1:100	NR. FLETES 02
-----------------------------	------------------

GRUPI I PROJEKTTIMIT : **"ALBGOLDING 2E" sh.p.k**

Ing. Hajredin MURGU
Ark. Soela MERKO
Ark. Erion MURGU

"ALBGOLDING 2E" sh.p.k
CONTACT:
E-MAIL : albgolding2@gmail.com
Cel: +355 68 52 07 550
+355 68 20 85 763



REPUBLIKA E SHQIPERISE
QARKU DIBER
BASHKIA BULQIZE

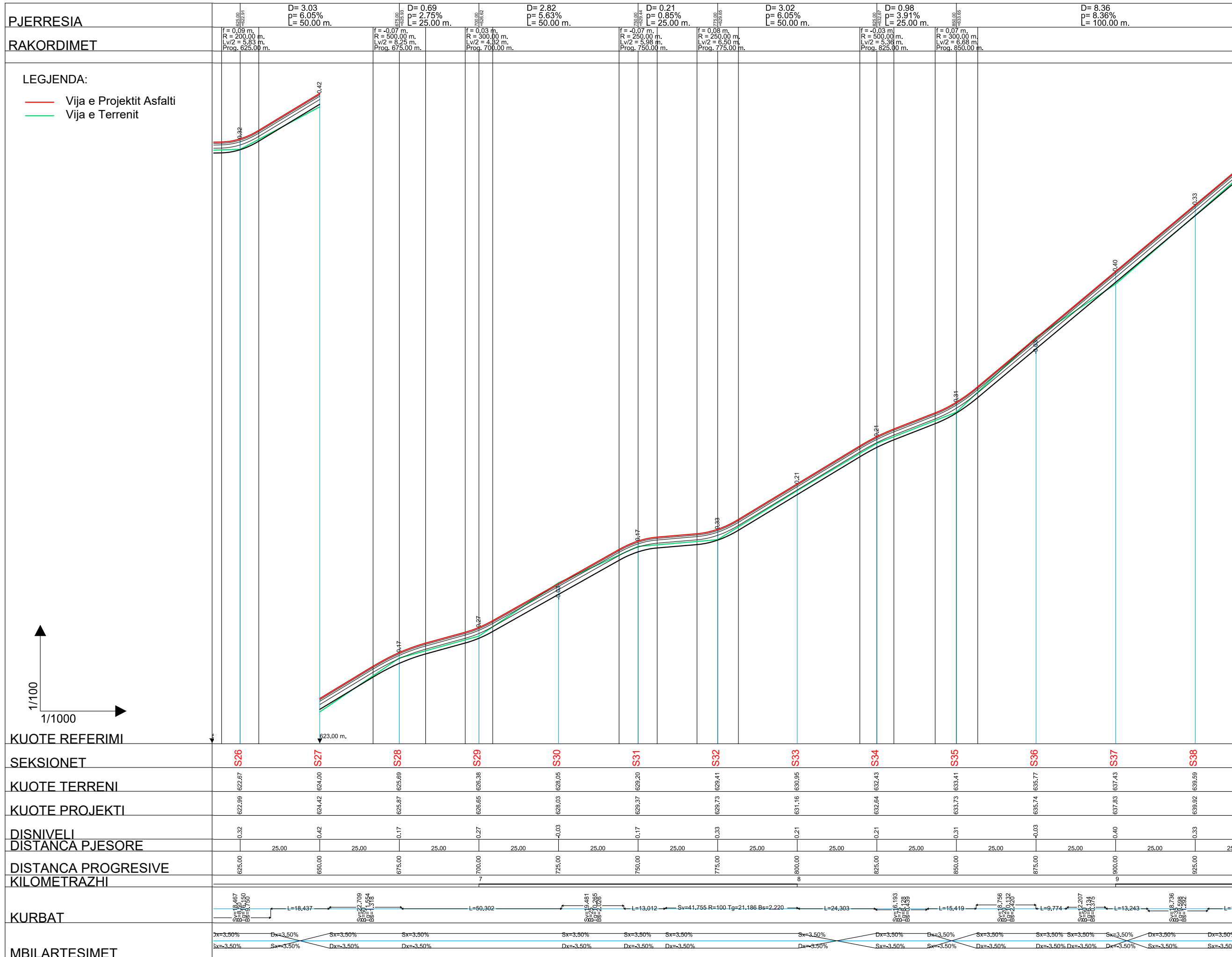

LEGJENDA:
— Vija e Projektit Asfalti
— Vija e Terrenit

1/1000
 1/1000

FOROSHTESI:
BASHKIA BULQIZE
 EMERTIMI I PROJEKTTIT :
**SISTEM-ASFALTIM I RRUGES BLLACE,
 LOTI I, N.J.A. SHUPENZE,
 BASHKIA BULQIZE**
 FAZA E PROJEKTTIT :
PROJEKT ZBATIMI
 EMERTIMI I FLETES :
PROFILI GJATESOR

SHKALLA H-1:1000 V-1:100	NR. FLETES 03
-----------------------------	------------------

GRUPI I PROJEKTTIMIT : **"ALBGOLDING 2E" sh.p.k**

Ing. Hajredin MURGU
 Ark. Soela MERKO
 Ark. Erion MURGU

"ALBGOLDING 2E" sh.p.k
 CONTACT:
 E-MAIL : albgolding2@gmail.com
 Cel: +355 68 52 07 550
 +355 68 20 85 763



REPUBLIKA E SHQIPERISE
QARKU DIBER
BASHKIA BULQIZE

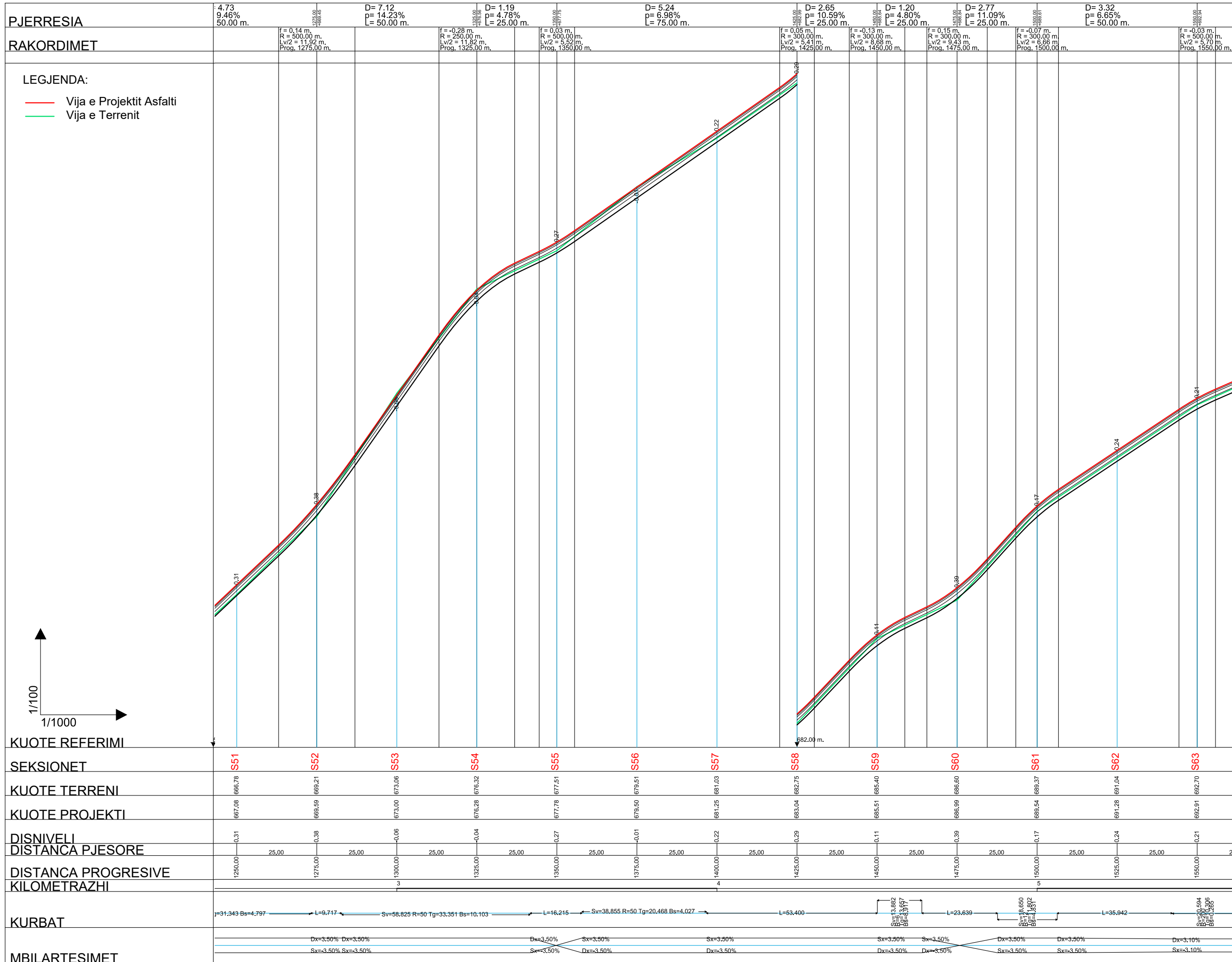

LEGJENDA:
— Vija e Projektit Asfalti
— Vija e Terrenit

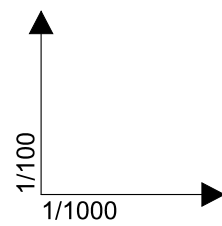

BASHKIA BULQIZE

EMERTIMI I PROJEKTTIT :
**SISTEM-ASFALTIM I RRUGES BLLACE,
 LOTI I, N.J.A. SHUPENZE,
 BASHKIA BULQIZE**

FAZA E PROJEKTTIT :
PROJEKT ZBATIMI

EMERTIMI I FLETES :
PROFILI GJATESOR

SHKALLA H-1:1000 V-1:100	NR. FLETES 05
-----------------------------	------------------

GRUPI I PROJEKTTIMIT : **"ALBGOLDING 2E" sh.p.k**

Ing. Hajredin MURGU
 Ark. Soela MERKO
 Ark. Erion MURGU

"ALBGOLDING 2E" sh.p.k
 CONTACT:
 E-MAIL : albgolding2@gmail.com
 Cel: +355 68 52 07 550
 +355 68 20 85 763



REPUBLIKA E SHQIPERISE
QARKU DIBER
BASHKIA BULQIZE

PJERRESIA	D= 2.19 p= 4.37% L= 50.00 m.	D= 4.26 p= 9.65% L= 44.20 m.	D= 4.54 p= 5.62% L= 80.80 m.	D= 3.97 p= 7.94% L= 50.00 m.	D= 0.52 p= 2.07% L= 25.00 m.	D= 2.21 p= 8.83% L= 25.00 m.	D= 4.74 p= 18.97% L= 25.00 m.	D= 3.82 p= 15.28% L= 25.00 m.
------------------	------------------------------------	------------------------------------	------------------------------------	------------------------------------	------------------------------------	------------------------------------	-------------------------------------	-------------------------------------

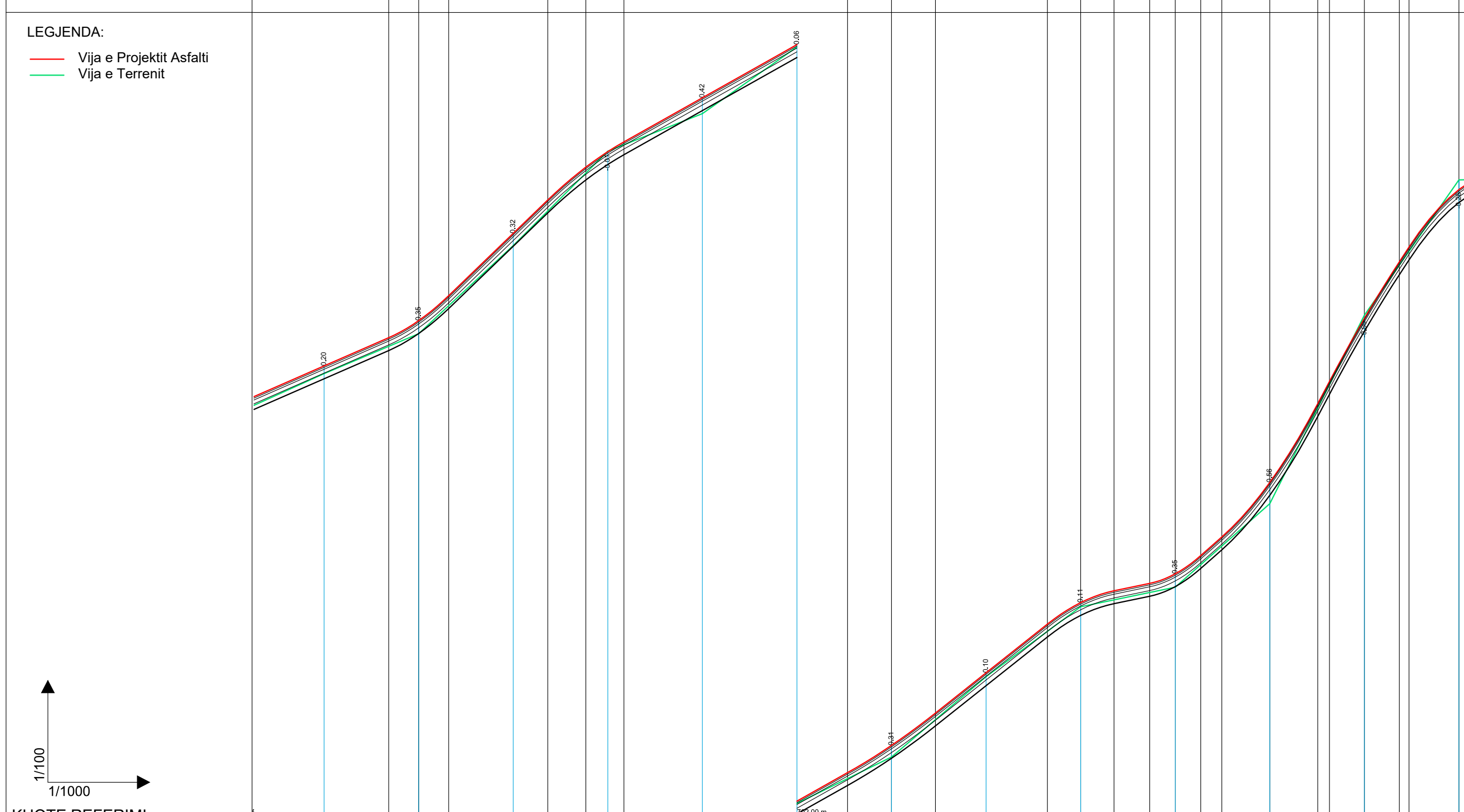

KUOTE REFERIMI	202.00 m															
SEKSIONET	S64	S65	S66	S67	S68	S69	S70	S71	S72	S73	S74	S75	S76			
KUOTE TERRENI	693.83	694.88	697.21	699.71	700.70	702.46	703.69	705.82	707.66	708.18	710.39	715.37	718.95			
KUOTE PROJEKTI	694.03	695.23	697.54	699.70	701.12	702.53	704.00	705.92	707.77	708.54	710.95	715.29	718.89			
DISNIVELI	0.20	0.35	0.32	-0.01	0.42	0.06	0.31	0.10	0.11	0.35	0.56	-0.09	-0.26			
DISTANCA PJESORE	25.00	25.00	25.00	25.00	25.00	25.00	25.00	25.00	25.00	25.00	25.00	25.00	25.00			
DISTANCA PROGRESIVE	1575.00	1600.00	1625.00	1650.00	1675.00	1700.00	1725.00	1750.00	1775.00	1800.00	1825.00	1850.00	1875.00			
KILOMETRAZHI	6	6	6	6	6	7	7	7	7	8	8	8	8			
KURBAT	L=56,626	Sv=17,460 R=34,920 L=1,391	L=18,835	Sv=34,642 R=35 Tg=18,889 Bs=4,772 L=10,206	Sv=22,093 R=34,920 L=1,420	L=72,686	Sv=15,706 R=34,920 L=1,166	L=24,289	Sv=11,274 R=34,920 L=739	L=9,679	Sv=3,967 R=34,920 L=1,082	L=0,400	Sv=53			
MBILARTESIMET	Dx=3.10% Sx=3.10%	Dx=3.50% Sx=3.50%	Dx=3.50% Sx=3.50%	Dx=3.50% Sx=3.50%	Dx=3.50% Sx=3.50%	Dx=3.50% Sx=3.50%	Dx=3.50% Sx=3.50%	Dx=3.50% Sx=3.50%	Dx=3.50% Sx=3.50%	Dx=3.50% Sx=3.50%	Dx=3.50% Sx=3.50%	Dx=3.50% Sx=3.50%	Dx=3.60% Sx=3.60%			

BASHKIA BULQIZE

EMERTIMI I PROJEKTTIT :
**SISTEM-ASFALTIM I RRUGES BLLACE,
LOTI I, N.J.A. SHUPENZE,
BASHKIA BULQIZE**

FAZA E PROJEKTTIT :
PROJEKT ZBATIMI

EMERTIMI I FLETES :
PROFILI GJATESOR

SHKALLA H-1:1000 V-1:100	NR. FLETES 06
-----------------------------	------------------

GRUPI I PROJEKTTIMIT : **"ALBGOLDING 2E" sh.p.k**

Ing. Hajredin MURGU
Ark. Soela MERKO
Ark. Erion MURGU

"ALBGOLDING 2E" sh.p.k
CONTACT:
E-MAIL : albgolding2@gmail.com
Cel: +355 68 52 07 550
+355 68 20 85 763

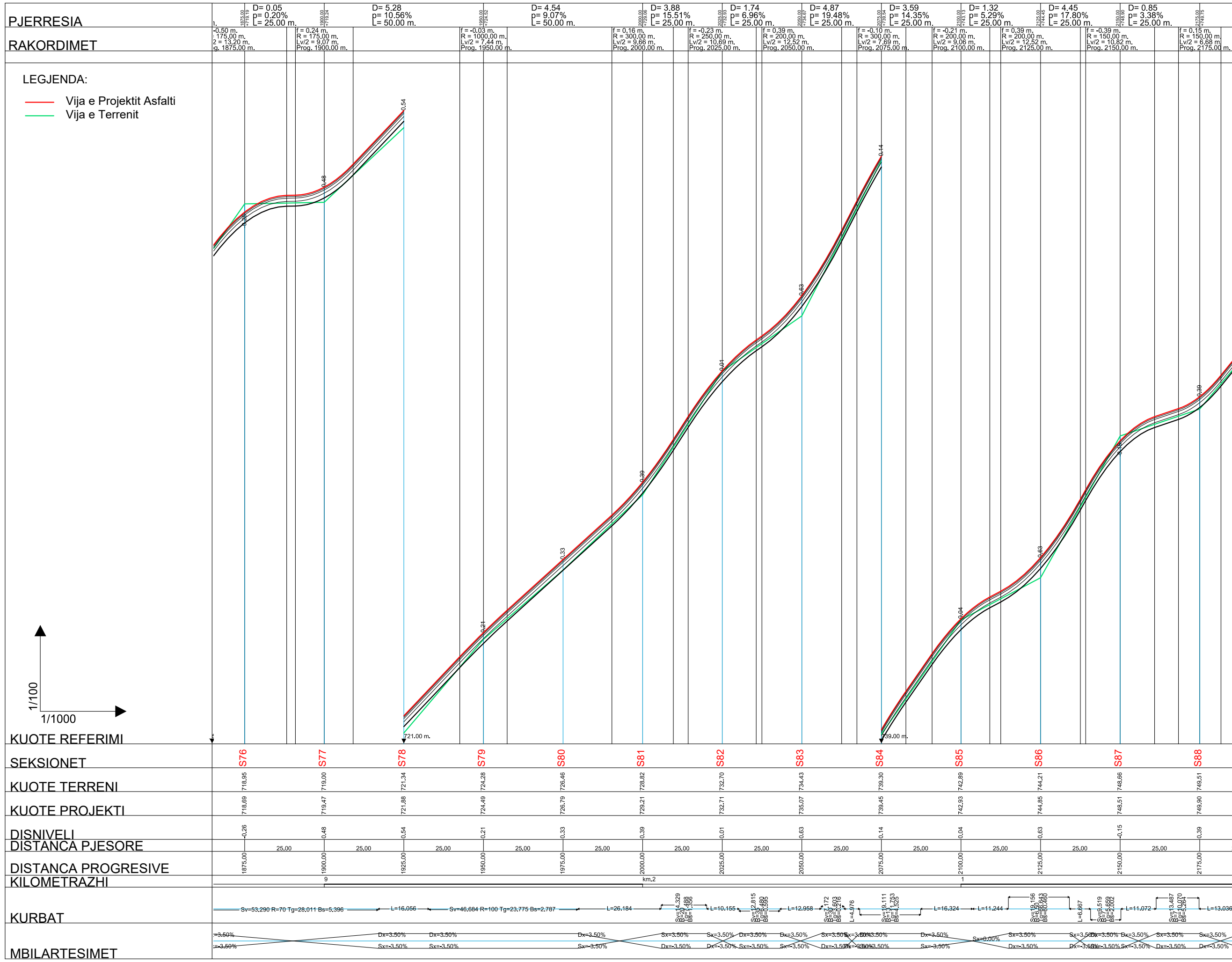

FOROSITESH:

BASHKIA BULQIZE

EMERTIMI I PROJEKTTIT :

**SISTEM-ASFALTIM I RRUGES BLLACE,
LOTI I, NJ.A. SHUPENZE,
BASHKIA BULQIZE**

FAZA E PROJEKTTIT :

PROJEKT ZBATIMI

EMERTIMI I FLETES :

PROFILI GJATESOR

SHKALLA H-1:1000 V-1:100	NR. FLETES 07
GRUPI I PROJEKTTIMIT :	"ALBGOLDING 2E" sh.p.k

Ing. Hajredin MURGU

Ark. Soela MERKO

Ark. Erion MURGU

"ALBGOLDING 2E" sh.p.k

CONTACT:
E-MAIL : albgolding2e@gmail.com
Cel: +355 68 52 07 550
+355 68 20 85 763



REPUBLIKA E SHQIPERISE
QARKU DIBER
BASHKIA BULQIZE

PJERRESIA	2175.00 746.90	D= 6.14 p= 12.28% L= 50.00 m.	2225.00 756.65	D= 5.38 p= 10.77% L= 50.00 m.	2275.00 761.04	D= 3.93 p= 15.70% L= 25.00 m.	2300.00 764.96	D= 2.13 p= 4.26% L= 50.00 m.	2350.00 767.09	D= 0.41 p= 0.82% L= 50.28 m.	2400.00 768.27	D= 5.33 p= 10.72% L= 49.72 m.	2450.00 772.84	D= 3.09 p= 6.18% L= 50.00 m.	2475.00 774.30
RAKORDIMET	f = 0.39 m. R = 500.00 m. Lv/2 = 6.68 m. Prog. 2175.00 m.	f = -0.01 m. R = 500.00 m. Lv/2 = 5.78 m. Prog. 2225.00 m.	f = 0.09 m. R = 300.00 m. Lv/2 = 7.40 m. Prog. 2275.00 m.	f = -0.33 m. R = 200.00 m. Lv/2 = 11.44 m. Prog. 2300.00 m.	f = -0.07 m. R = 500.00 m. Lv/2 = 8.60 m. Prog. 2350.00 m.	f = 0.61 m. R = 500.00 m. Lv/2 = 24.73 m. Prog. 2400.00 m.	f = -0.13 m. R = 500.00 m. Lv/2 = 11.35 m. Prog. 2450.00 m.	f = 0.32 m. R = 500.00 m. Lv/2 = 11.35 m. Prog. 2475.00 m.							

LEGJENDA:
— Vija e Projektit Asfalti
— Vija e Terrenit

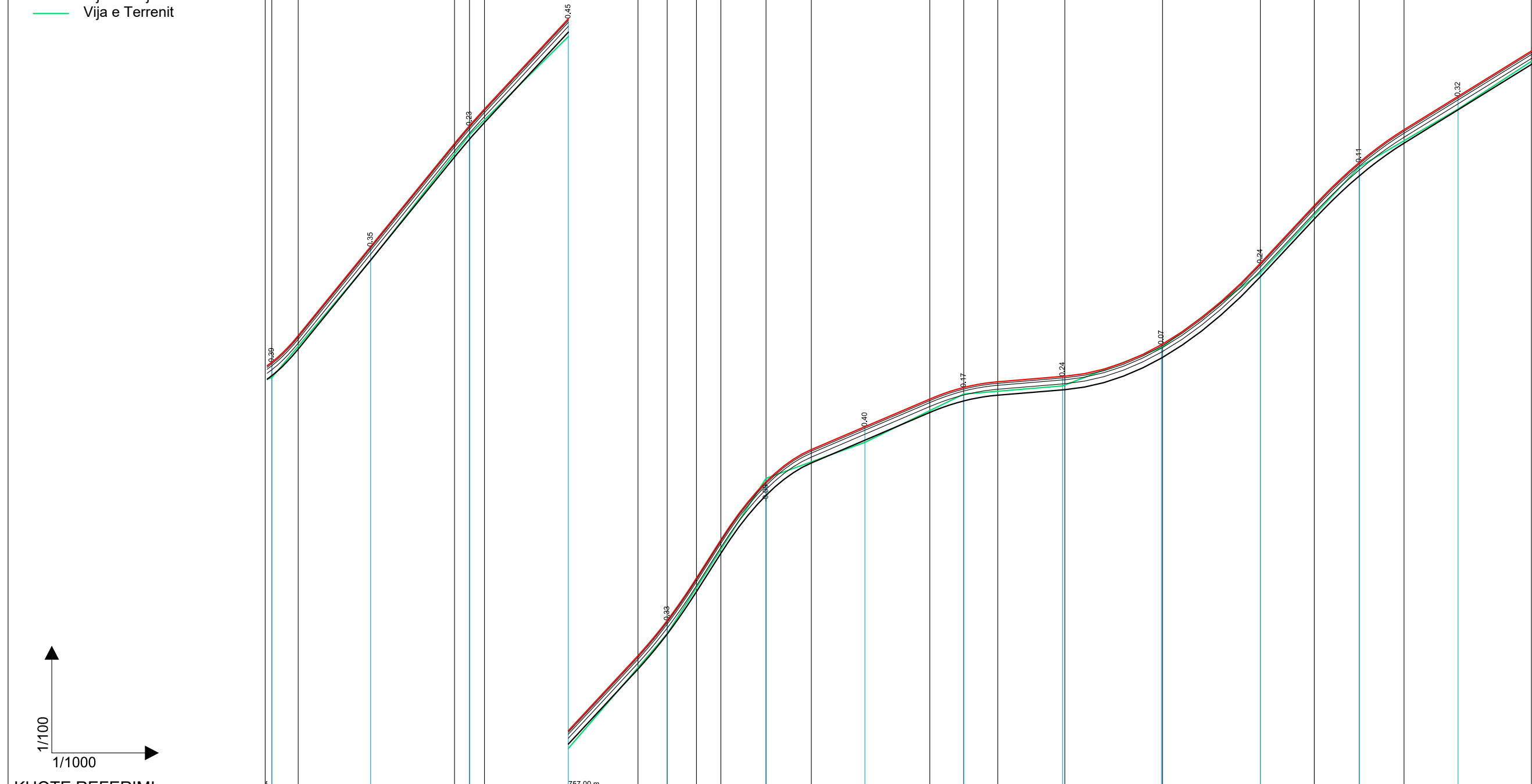

KUOTE REFERIMI	746.90	746.51	752.47	752.47	756.65	758.13	761.04	764.96	765.87	767.09	767.30	768.27	770.16	772.84	774.30
SEKSIONET	S88	S89	S90	S91	S92	S93	S94	S95	S96	S97	S98	S99	S100		
KUOTE TERRENI	746.90	746.51	752.47	752.47	756.65	758.13	761.04	764.96	765.87	767.09	767.30	768.27	770.16	772.84	774.30
KUOTE PROJEKTI	746.90	746.51	752.47	752.47	756.65	758.13	761.04	764.96	765.87	767.09	767.30	768.27	770.16	772.84	774.30
DISNIVELI	0.39	0.35	0.23	0.45	0.33	0.09	0.40	0.17	0.24	0.07	0.24	0.11	0.32		
DISTANCA PJESORE	25.00	25.00	25.00	25.00	25.00	25.00	25.00	25.00	25.00	25.00	25.00	25.00	25.00	25.00	25.00
DISTANCA PROGRESIVE	2175.00	2200.00	2225.00	2250.00	2275.00	2300.00	2325.00	2350.00	2375.00	2400.00	2425.00	2450.00	2475.00		
KILOMETRAZHI															
KURBAT	L=13.036 Sv=39.740 R=150 Tg=19.987 Bs=1.326	L=25.289 Sv=35.329 R=150 Tg=19.987 Bs=1.326	L=11.118 Sv=35.329 R=150 Tg=19.987 Bs=1.326	L=15.121 Sv=35.329 R=150 Tg=19.987 Bs=1.326	L=9.976 Sv=35.329 R=150 Tg=19.987 Bs=1.326	L=10.760 Sv=37.161 R=50 Tg=19.486 Bs=3.663	L=16.024 Sv=35.329 R=150 Tg=19.987 Bs=1.326	L=11.716 Sv=35.329 R=150 Tg=19.987 Bs=1.326	L=26.568 Sv=35.329 R=150 Tg=19.987 Bs=1.326	L=9.966 Sv=39.442 R=150 Tg=19.987 Bs=1.326					
MBILARTESIMET	Sx=3.50% Dx=3.30%	Sx=3.30% Dx=3.30%	Sx=3.30% Dx=3.30%	Sx=3.50% Dx=3.50%	Sx=3.50% Dx=3.50%	Sx=3.50% Dx=3.50%	Sx=3.50% Dx=3.50%	Sx=3.50% Dx=3.50%	Sx=3.50% Dx=3.50%	Sx=3.50% Dx=3.50%	Sx=3.50% Dx=3.50%	Sx=3.50% Dx=3.50%	Sx=3.50% Dx=3.50%	Sx=3.50% Dx=3.50%	Sx=3.50% Dx=3.50%

BASHKIA BULQIZE

EMERTIMI I PROJEKTTIT :
**SISTEM-ASFALTIM I RRUGES BLLACE,
 LOTI I, N.J.A. SHUPENZE,
 BASHKIA BULQIZE**

FAZA E PROJEKTTIT :
PROJEKT ZBATIMI

EMERTIMI I FLETES :
PROFILI GJATESOR

SHKALLA H-1:1000 V-1:100	NR. FLETES 08
-----------------------------	------------------

GRUPI I PROJEKTTIMIT : **"ALBGOLDING 2E" sh.p.k**

Ing. Hajredin MURGU
 Ark. Soela MERKO
 Ark. Erion MURGU

"ALBGOLDING 2E" sh.p.k
 CONTACT:
 E-MAIL : albgolding2@gmail.com
 Cel: +355 68 52 07 550
 +355 68 20 85 763

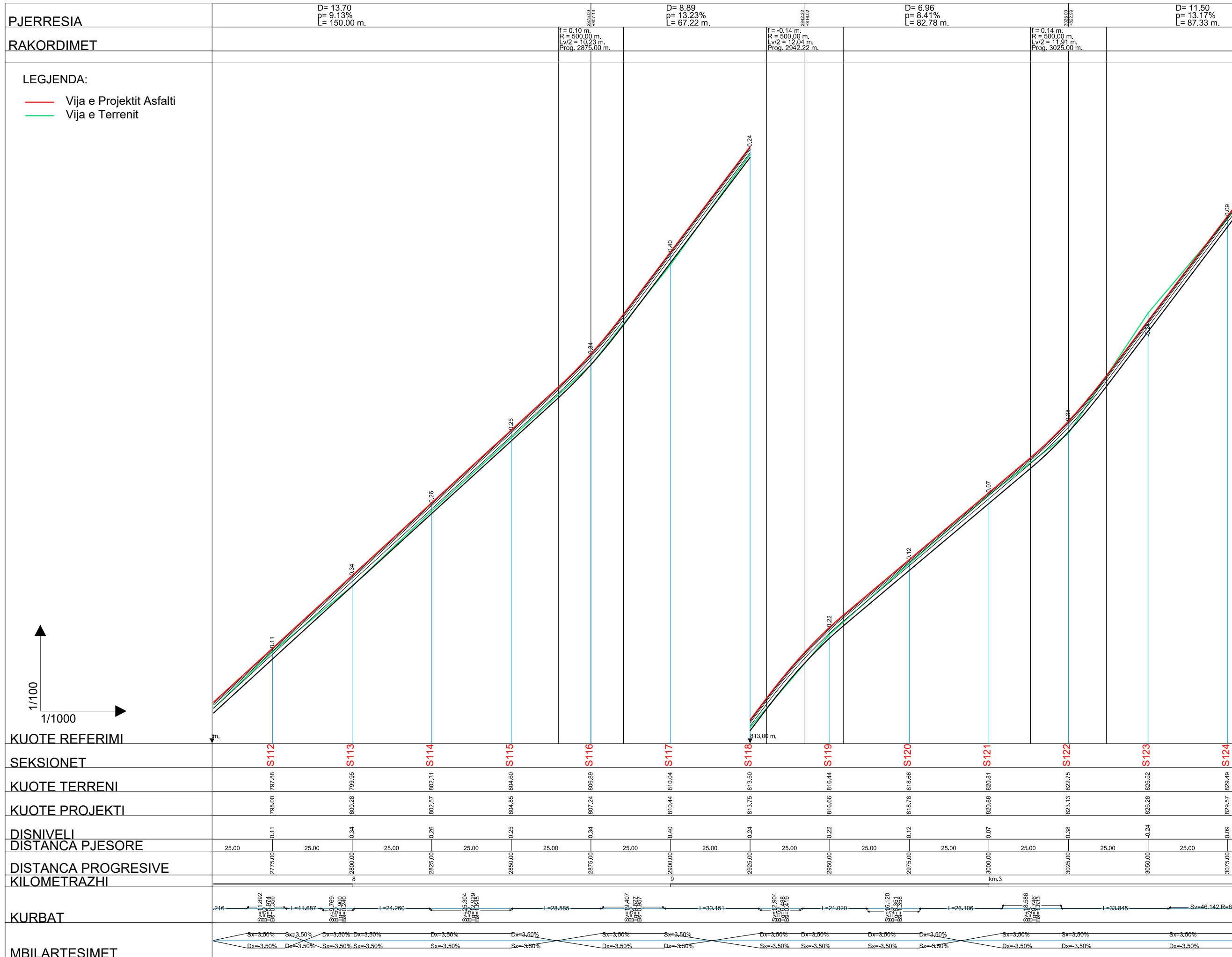

PJERRESIA	D= 13.70 p= 9.13% L= 150.00 m.	D= 8.89 p= 13.23% L= 67.22 m.	D= 6.96 p= 8.41% L= 82.78 m.	D= 11.50 p= 13.17% L= 87.33 m.									
RAKORDIMET	f= 0.10 m. R= 500.00 m. Lv/2 = 10.23 m. Prog. 2875.00 m.	f= -0.14 m. R= 500.00 m. Lv/2 = 12.04 m. Prog. 2942.22 m.	f= 0.14 m. R= 500.00 m. Lv/2 = 11.31 m. Prog. 3025.00 m.										
LEGJENDA:	<p>— Vija e Projektit Asfalti</p> <p>— Vija e Terrenit</p>												
KUOTE REFERIMI	m.												
SEKSIONET	S112	S113	S114	S115	S116	S117	S118	S119	S120	S121	S122	S123	S124
KUOTE TERRENI	797.88	799.95	802.31	804.80	806.89	810.04	813.50	816.44	818.66	820.88	822.75	826.52	828.49
KUOTE PROJEKTI	798.00	800.28	802.57	804.85	807.24	810.44	813.75	816.66	818.78	820.88	823.13	826.28	828.57
DISNIVELI	0.11	0.34	0.26	0.25	0.34	0.40	0.24	0.22	0.12	0.07	0.38	-0.24	0.09
DISTANCA PJESORE	25.00	25.00	25.00	25.00	25.00	25.00	25.00	25.00	25.00	25.00	25.00	25.00	25.00
DISTANCA PROGRESIVE	2775.00	2800.00	2825.00	2850.00	2875.00	2900.00	2925.00	2950.00	2975.00	3000.00	3025.00	3050.00	3075.00
KILOMETRAZHI	km,3												
KURBAT	<p>Sv=11.892 R=11.892 L=11.687</p> <p>Sv=7.769 R=7.769 L=24.260</p> <p>Sv=15.304 R=15.304 L=28.686</p> <p>Sv=19.407 R=19.407 L=30.151</p> <p>Sv=12.904 R=12.904 L=21.020</p> <p>Sv=16.120 R=16.120 L=26.106</p> <p>Sv=18.596 R=18.596 L=33.845</p> <p>Sv=46.142 R=60.142</p>												
MBILARTESIMET	<p>Sx=3.50% Sx=3.50% Dx=3.50% Dx=3.50%</p> <p>Sx=3.50% Sx=3.50% Dx=3.50% Dx=3.50%</p> <p>Sx=3.50% Sx=3.50% Dx=3.50% Dx=3.50%</p> <p>Sx=3.50% Sx=3.50% Dx=3.50% Dx=3.50%</p> <p>Sx=3.50% Sx=3.50% Dx=3.50% Dx=3.50%</p> <p>Sx=3.50% Sx=3.50% Dx=3.50% Dx=3.50%</p> <p>Sx=3.50% Sx=3.50% Dx=3.50% Dx=3.50%</p> <p>Sx=3.50% Sx=3.50% Dx=3.50% Dx=3.50%</p> <p>Sx=3.50% Sx=3.50% Dx=3.50% Dx=3.50%</p> <p>Sx=3.50% Sx=3.50% Dx=3.50% Dx=3.50%</p> <p>Sx=3.50% Sx=3.50% Dx=3.50% Dx=3.50%</p> <p>Sx=3.50% Sx=3.50% Dx=3.50% Dx=3.50%</p> <p>Sx=3.50% Sx=3.50% Dx=3.50% Dx=3.50%</p>												

FOROSHTESI:

BASHKIA BULQIZE

EMERTIMI I PROJEKTTIT :

**SISTEM-ASFALTIM I RRUGES BLLACE,
LOTI I, N.J.A. SHUPENZE,
BASHKIA BULQIZE**

FAZA E PROJEKTTIT :

PROJEKT ZBATIMI

EMERTIMI I FLETES :

PROFILI GJATESOR

SHKALLA H-1:1000 V-1:100	NR. FLETES 10
-----------------------------	------------------

GRUPI I PROJEKTTIMIT : "ALBGOLDING 2E" sh.p.k

Ing. Hajredin MURGU
Ark. Soela MERKO
Ark. Erion MURGU

"ALBGOLDING 2E" sh.p.k

CONTACT:
E-MAIL : albgolding2@gmail.com
Cel: +355 68 52 07 550
+355 68 20 85 763

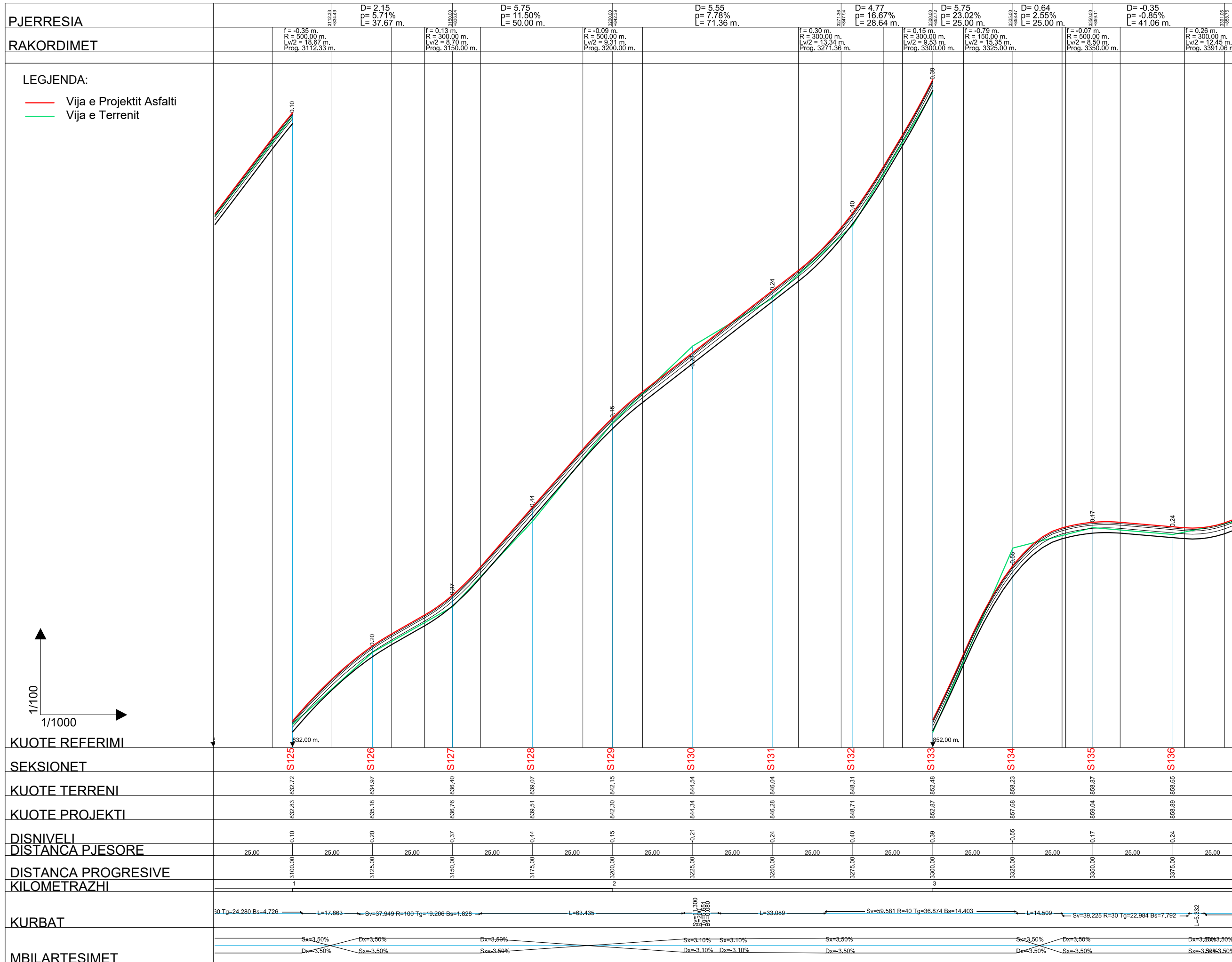

BASHKIA BULQIZE

EMERTIMI I PROJEKTTIT :
**SISTEM-ASFALTIM I RRUGES BLLACE,
 LOTI I, N.J.A. SHUPENZE,
 BASHKIA BULQIZE**

FAZA E PROJEKTTIT :
PROJEKT ZBATIMI

EMERTIMI I FLETES :
PROFILI GJATESOR

SHKALLA H-1:1000 V-1:100	NR. FLETES 11
-----------------------------	------------------

GRUPI I PROJEKTTIMIT : **"ALBGOLDING 2E" sh.p.k**

Ing. Hajredin MURGU
 Ark. Soela MERKO
 Ark. Erion MURGU

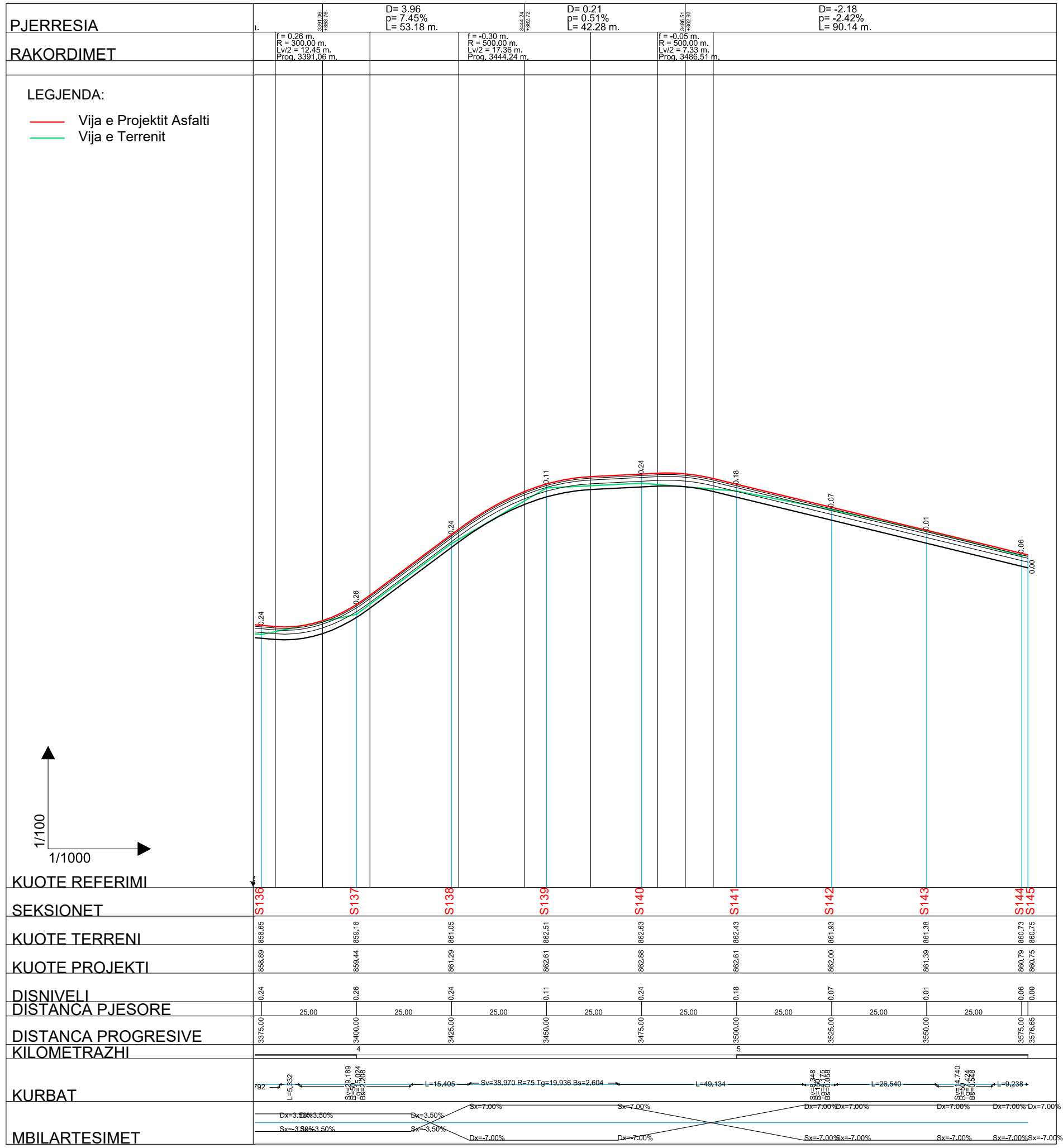

REPUBLICA E SHQIPERISE
QARKU DIBER
BASHKIA BULQIZE

FOROSTITESH:
BASHKIA BULQIZE

EMERTIMI I PROJEKTTIT :
**SISTEM-ASFALTIM I RRUGES BLLACE,
LOTI I, N.J.A. SHUPENZE,
BASHKIA BULQIZE**

FAZA E PROJEKTTIT :
PROJEKT ZBATIMI

EMERTIMI I FLETES :
PROFILI GJATESOR

SHKALLA H-1:1000 V-1:100	NR. FLETES 12
-----------------------------	------------------

GRUPI I PROJEKTIMIT : **"ALBGOLDING 2E" sh.p.k**

Ing. Hajredin MURGU
Ark. Soela MERKO
Ark. Erion MURGU





REPUBLIKA E SHQIPERISE
QARKU DIBER
BASHKIA BULQIZE

PROJEKT ZBATIMI

OBJEKTI:
SISTEM-ASFALTIM I RRUGES BLLACE, LOTI I,
N.J.A. SHUPENZE, BASHKIA BULQIZE

PROFILAT TERTHORE

FOROSITESH:

BASHKIA BULQIZE

EMERTIMI I PROJEKTTIT :

**SISTEM-ASFALTIM I RRUGES BLLACE,
LOTI I, N.J.A. SHUPENZE,
BASHKIA BULQIZE**

FAZA E PROJEKTTIT :

PROJEKT ZBATIMI

EMERTIMI I FLETES :

KAPAKU

SHKALLA
1:200

NR. FLETES

GRUPI I PROJEKTIMIT :

"ALBGOLDING 2E" sh.p.k

Ing. Hajredin MURGU

Ark. Soela MERKO

Ark. Erion MURGU



"ALBGOLDING 2E" sh.p.k

CONTACT:

E-MAIL : albgolding2@gmail.com

Cel: +355 68 52 07 550

+355 68 20 85 763



Profil Terthor
Seksioni - S1
Pr. 0.00 ml
Kuate Terreni= 587.12 ml
Kuate Projekti= 587.12 ml
Germim= 1.65 m2
Mbushje= 0.01 m2

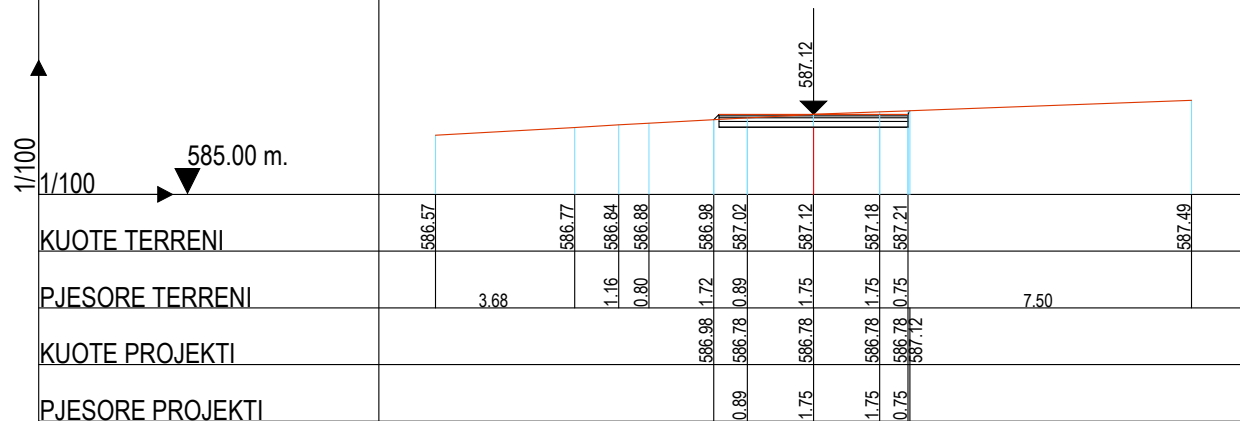

Profil Terthor
Seksioni - S2
Pr. 25.00 ml
Kuate Terreni= 585.51 ml
Kuate Projekti= 585.96 ml
Germim= 0.03 m2
Mbushje= 0.65 m2

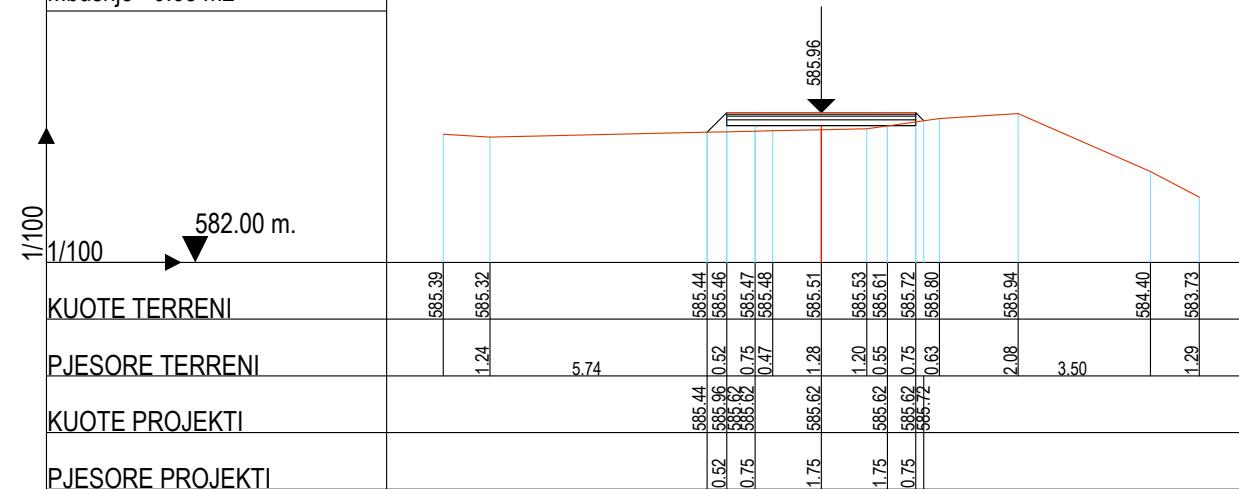

Profil Terthor
Seksioni - S3
Pr. 50.00 ml
Kuate Terreni= 586.08 ml
Kuate Projekti= 586.44 ml
Germim= 0.00 m2
Mbushje= 0.19 m2

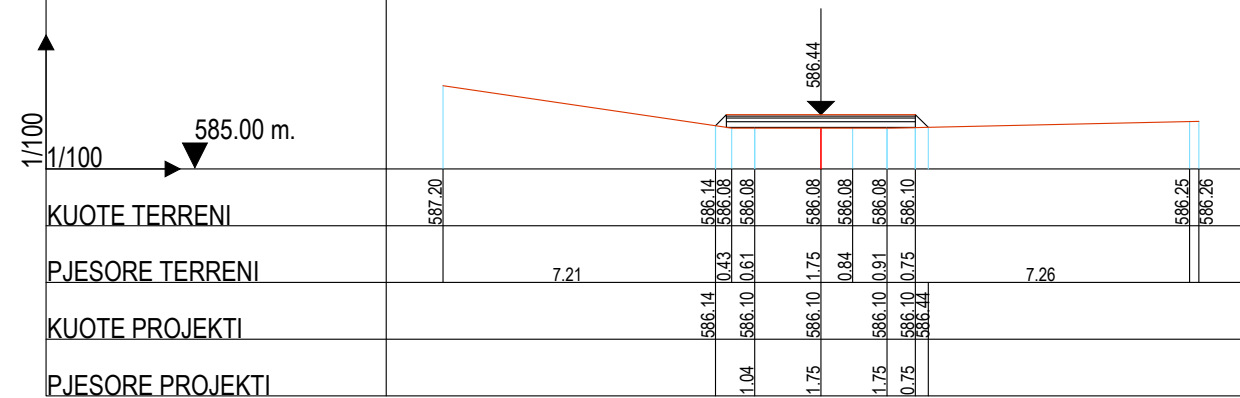

Profil Terthor
Seksioni - S4
Pr. 75.00 ml
Kuate Terreni= 586.69 ml
Kuate Projekti= 587.13 ml
Germim= 0.00 m2
Mbushje= 0.67 m2

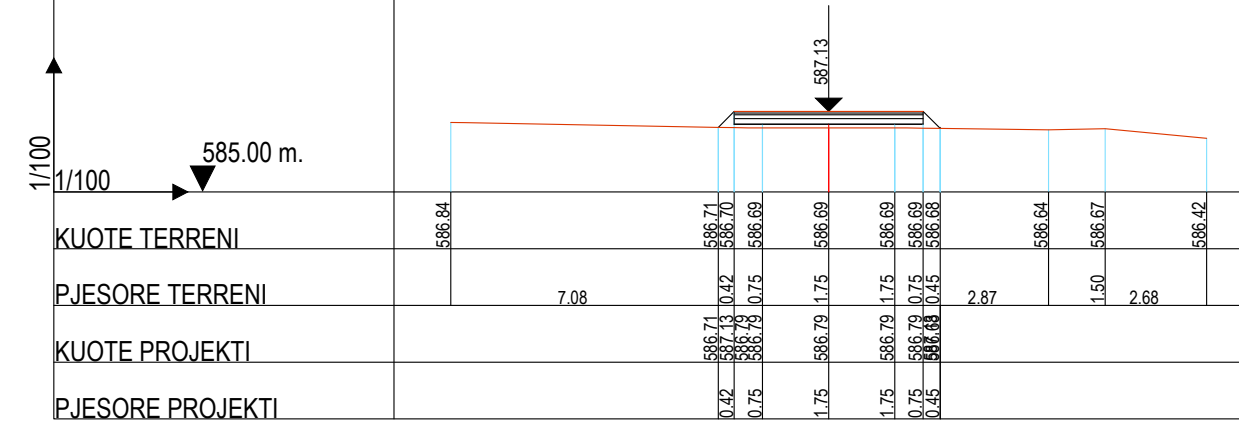

FOROSITESH:

BASHKIA BULQIZE

EMERTIMI I PROJEKTTIT :

**SISTEM-ASFALTIM I RRUGES BLLACE,
LOTI I, N.J.A. SHUPENZE,
BASHKIA BULQIZE**

FAZA E PROJEKTTIT :

PROJEKT ZBATIMI

EMERTIMI I FLETES :

PROFILAT TERTHORE

SHKALLA 1:200	NR. FLETES 01
------------------	------------------

GRUPI I PROJEKTTIMIT : **"ALBGOLDING 2E" sh.p.k**

Ing. Hajredin MURGU

Ark. Soela MERKO

Ark. Erion MURGU



"ALBGOLDING 2E" sh.p.k

CONTACT:
E-MAIL : albgolding2@gmail.com
Cel: +355 68 52 07 550
+355 68 20 85 763

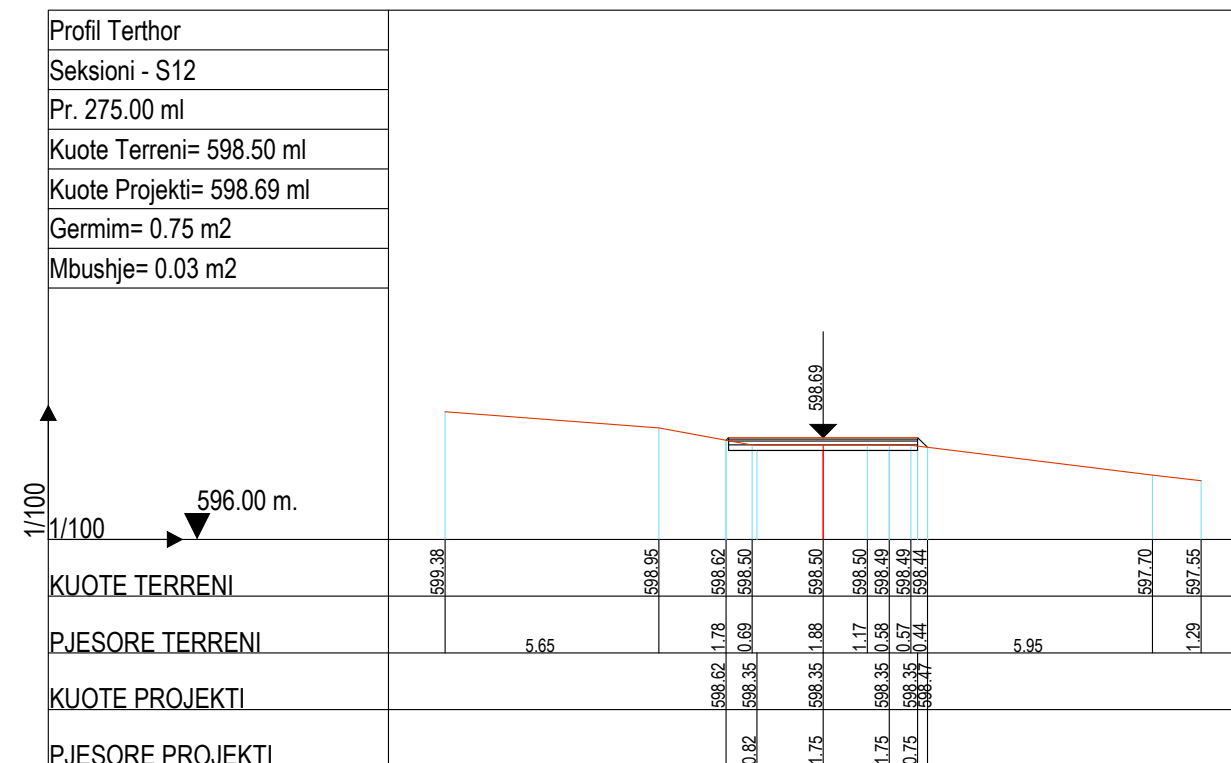
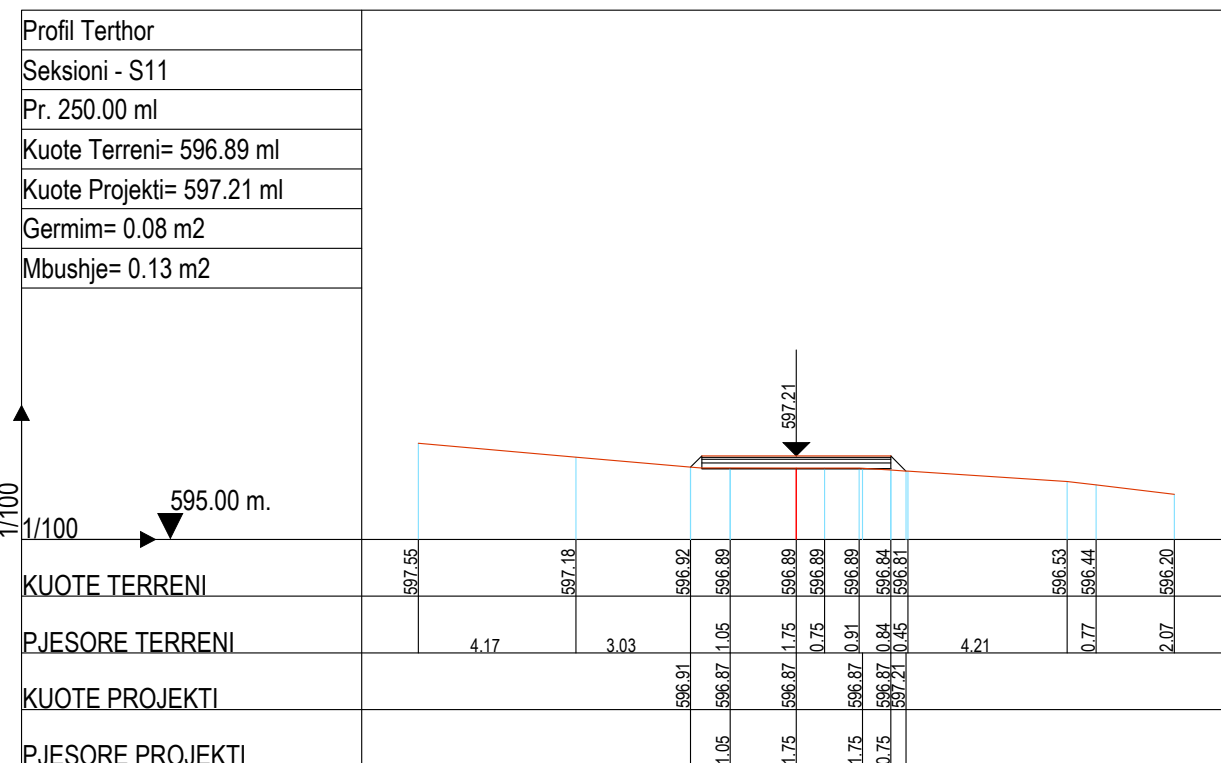
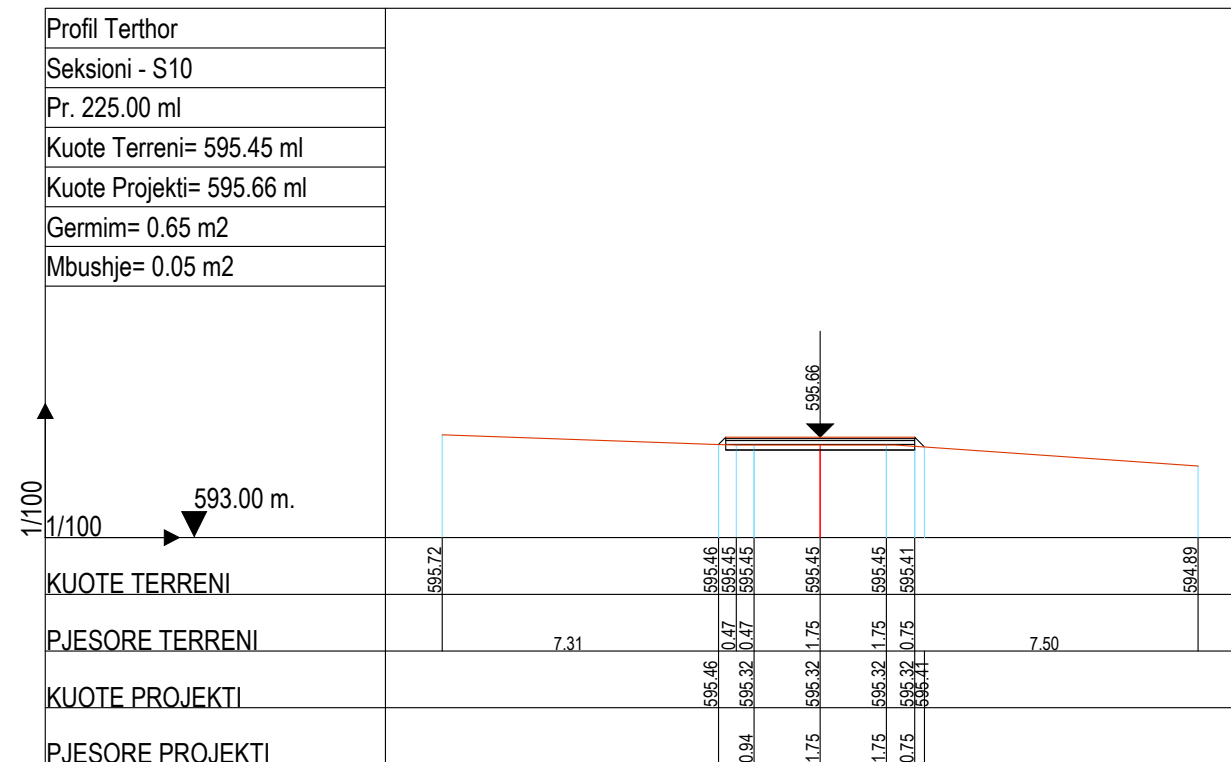
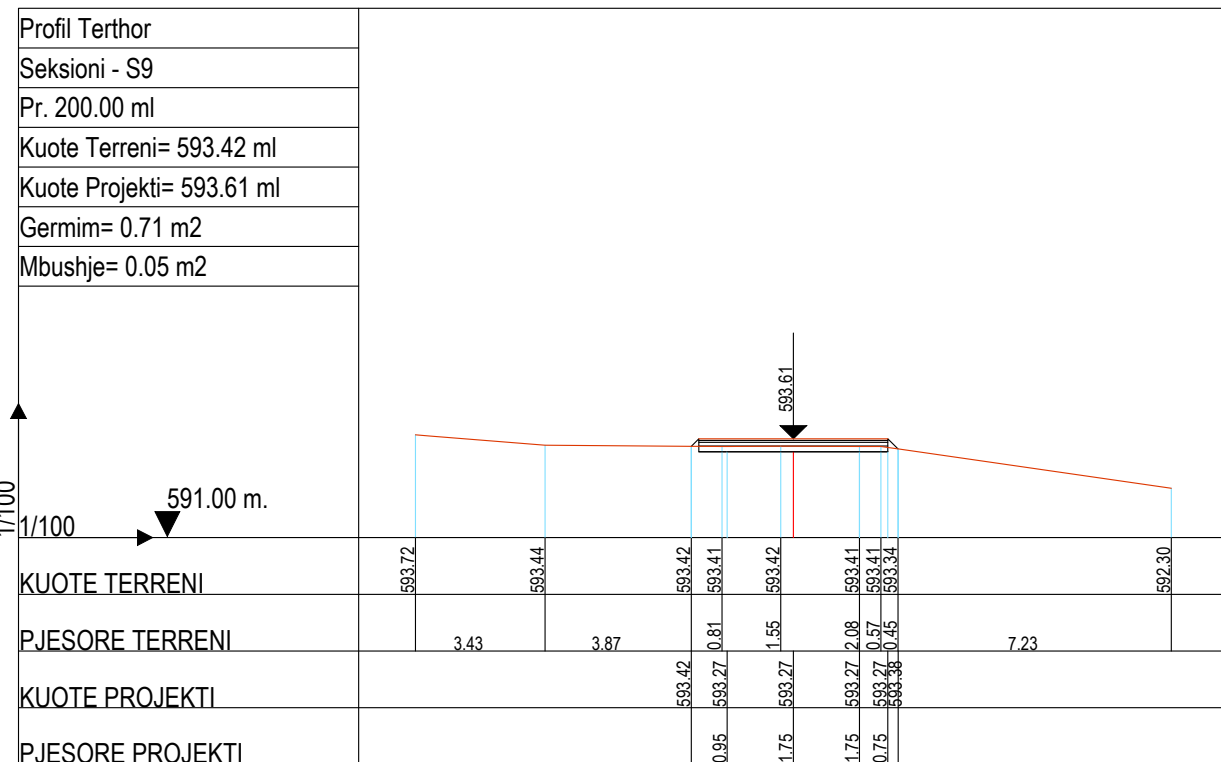

FOROSHTESI:

BASHKIA BULQIZE

EMERTIMI I PROJEKTTIT :

**SISTEM-ASFALTIM I RRUGES BLLACE,
LOTI I, N.J.A. SHUPENZE,
BASHKIA BULQIZE**

FAZA E PROJEKTTIT :

PROJEKT ZBATIMI

EMERTIMI I FLETES :

PROFILAT TERTHORE

SHKALLA 1:200	NR. FLETES 03
------------------	------------------

GRUPI I PROJEKTTIMIT : **"ALBGOLDING 2E" sh.p.k**

Ing. Hajredin MURGU

Ark. Soela MERKO

Ark. Erion MURGU



"ALBGOLDING 2E" sh.p.k

CONTACT:
E-MAIL : albgolding2@gmail.com
Cel: +355 68 52 07 550
+355 68 20 85 763

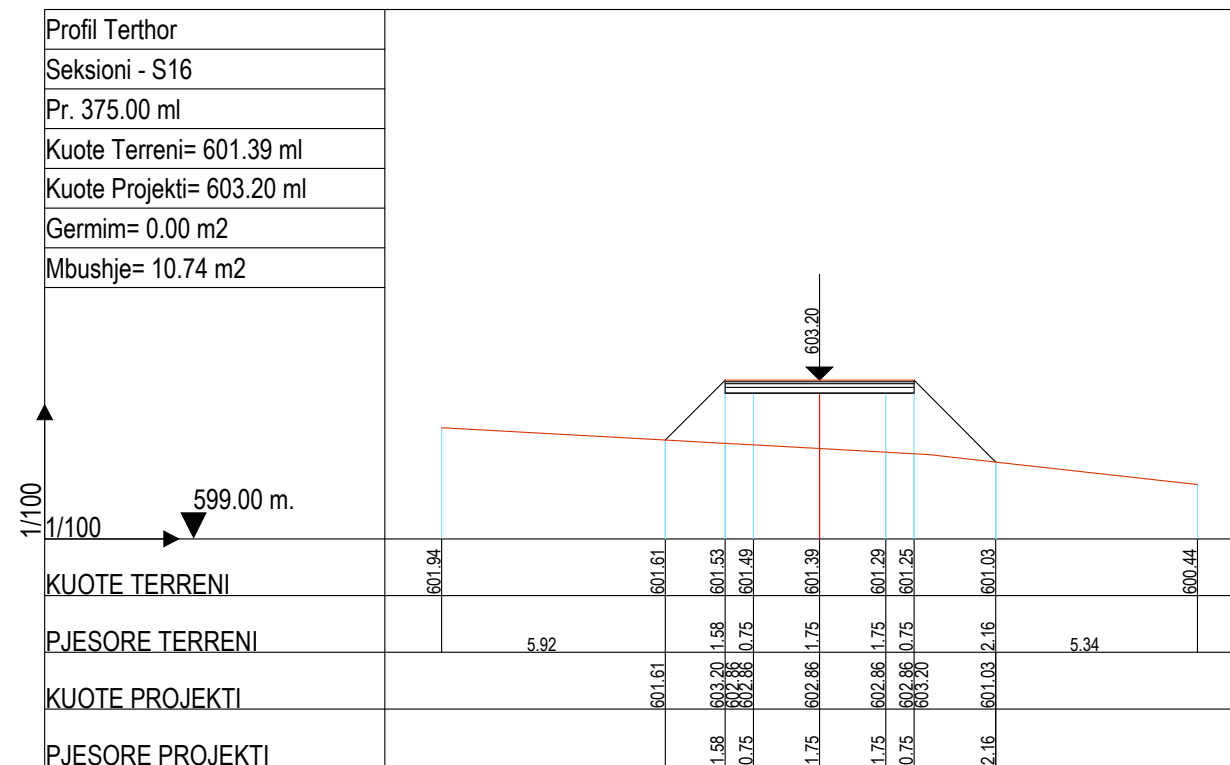
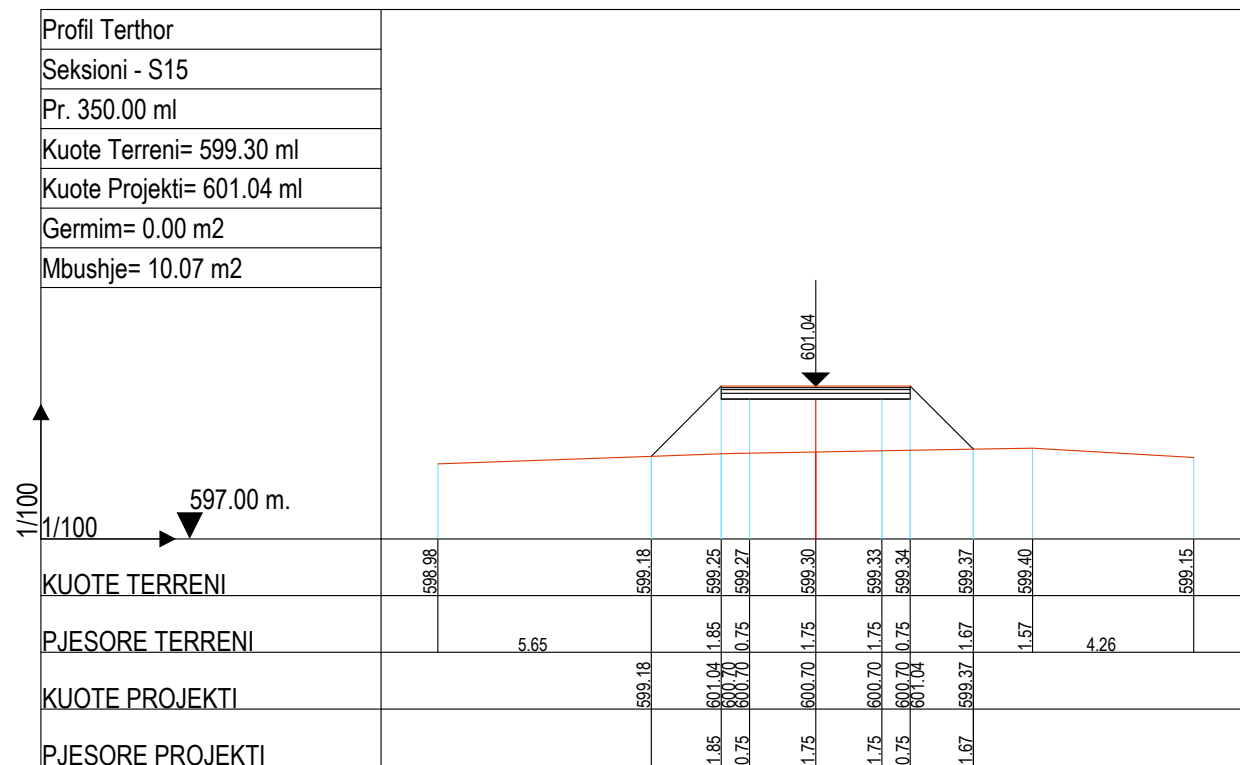
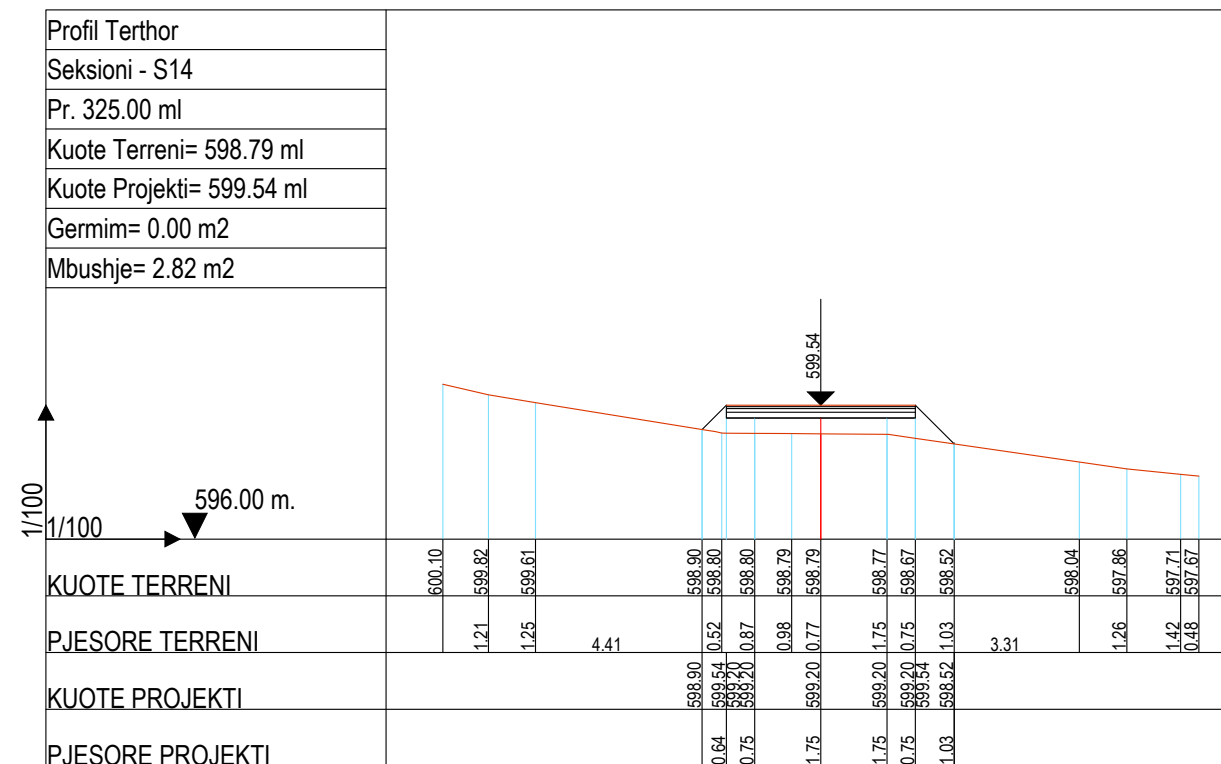
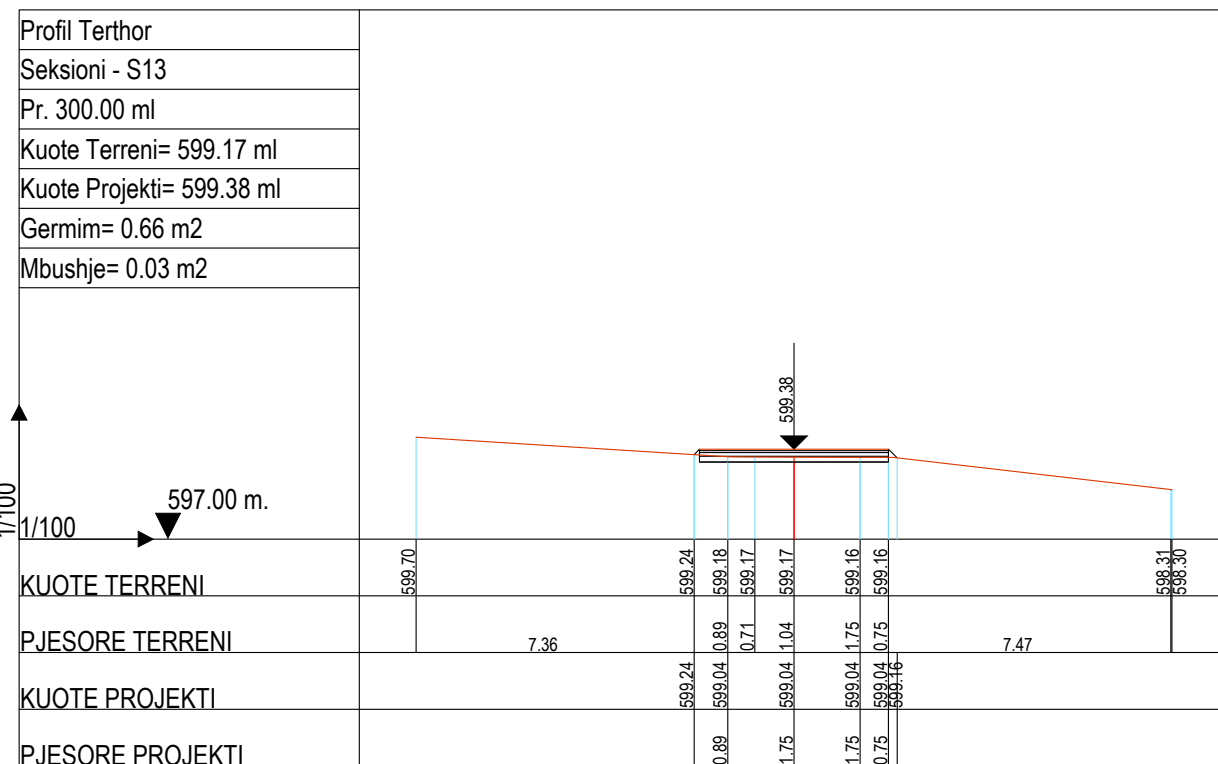

FOROSHTESI:

BASHKIA BULQIZE

EMERTIMI I PROJEKTTIT :

**SISTEM-ASFALTIM I RRUGES BLLACE,
LOTI I, NJ.A. SHUPENZE,
BASHKIA BULQIZE**

FAZA E PROJEKTTIT :

PROJEKT ZBATIMI

EMERTIMI I FLETES :

PROFILAT TERTHORE

SHKALLA 1:200	NR. FLETES 04
------------------	------------------

GRUPI I PROJEKTIMIT : **"ALBGOLDING 2E" sh.p.k**

Ing. Hajredin MURGU

Ark. Soela MERKO

Ark. Erion MURGU



"ALBGOLDING 2E" sh.p.k

CONTACT:
E-MAIL : albgolding2@gmail.com
Cel: +355 68 52 07 550
+355 68 20 85 763



Profil Terthor
Seksioni - S17
Pr. 400.00 ml
Kuate Terreni= 604.96 ml
Kuate Projekti= 605.35 ml
Germim= 0.21 m2
Mbushje= 0.70 m2

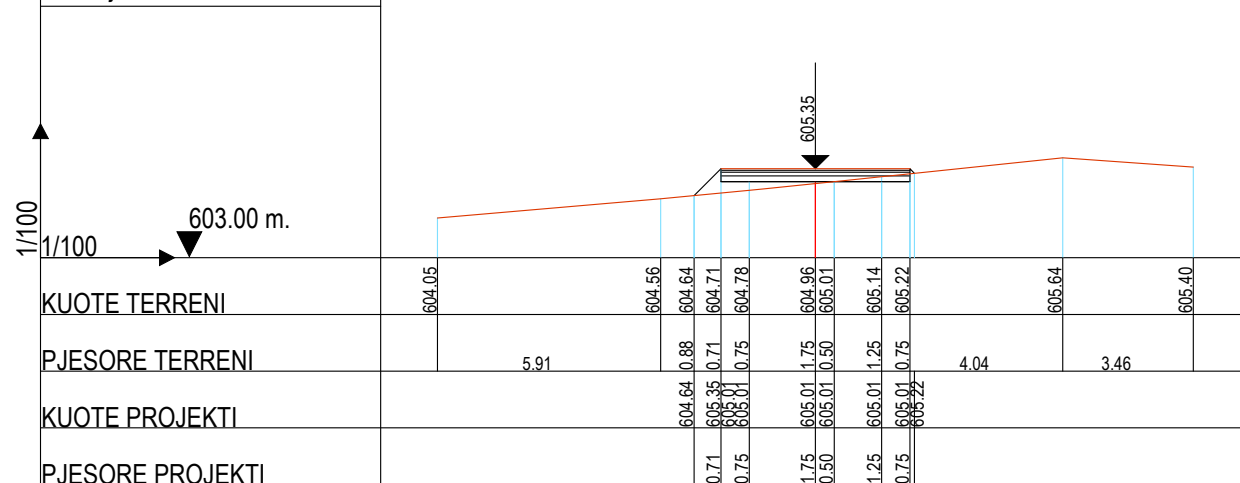

Profil Terthor
Seksioni - S18
Pr. 425.00 ml
Kuate Terreni= 607.22 ml
Kuate Projekti= 607.68 ml
Germim= 0.21 m2
Mbushje= 1.97 m2

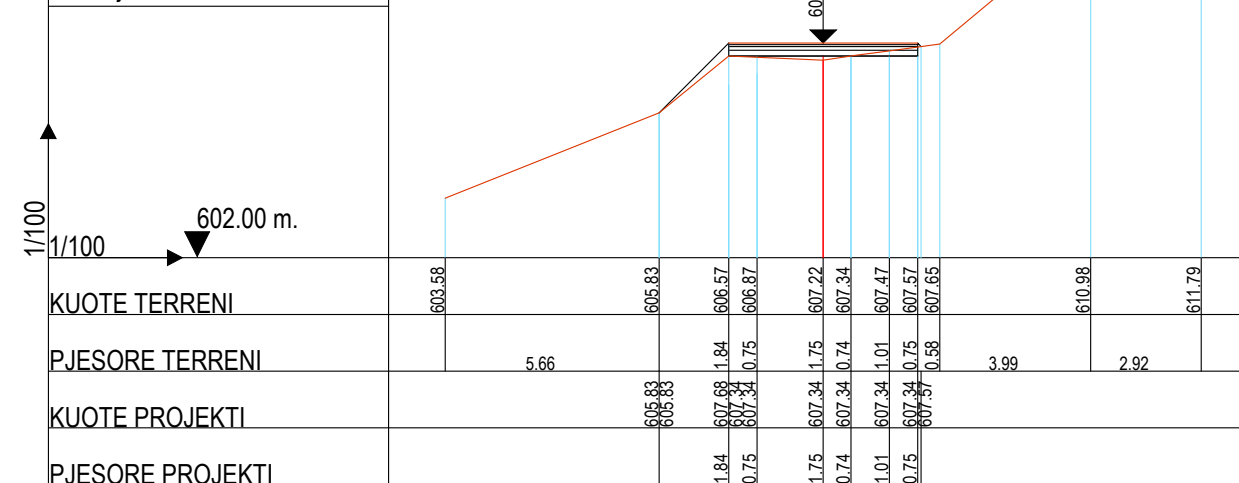

Profil Terthor
Seksioni - S19
Pr. 450.00 ml
Kuate Terreni= 609.91 ml
Kuate Projekti= 610.19 ml
Germim= 1.92 m2
Mbushje= 1.33 m2

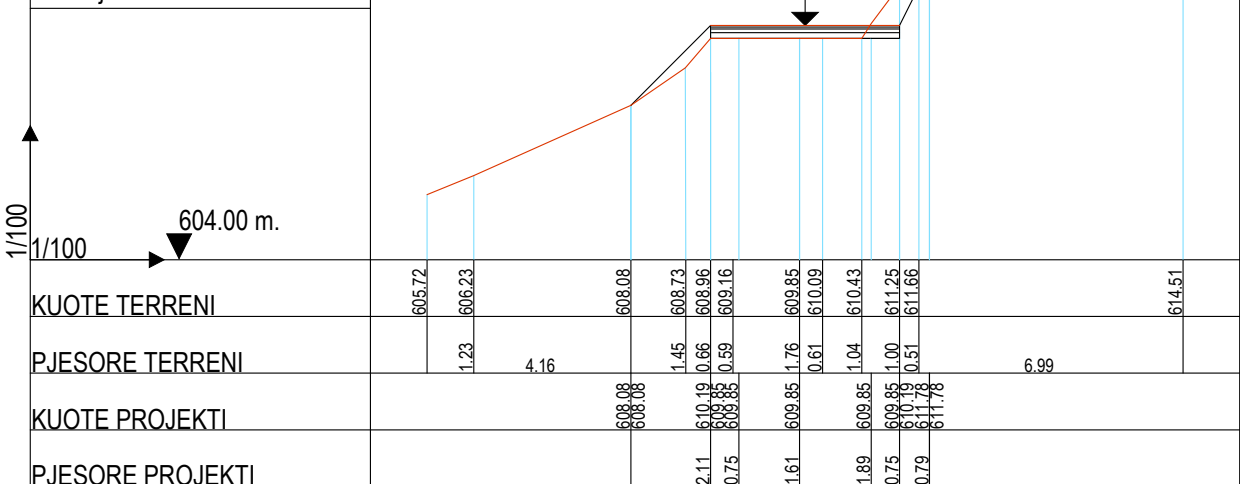

Profil Terthor
Seksioni - S20
Pr. 475.00 ml
Kuate Terreni= 612.96 ml
Kuate Projekti= 613.29 ml
Germim= 2.45 m2
Mbushje= 2.16 m2

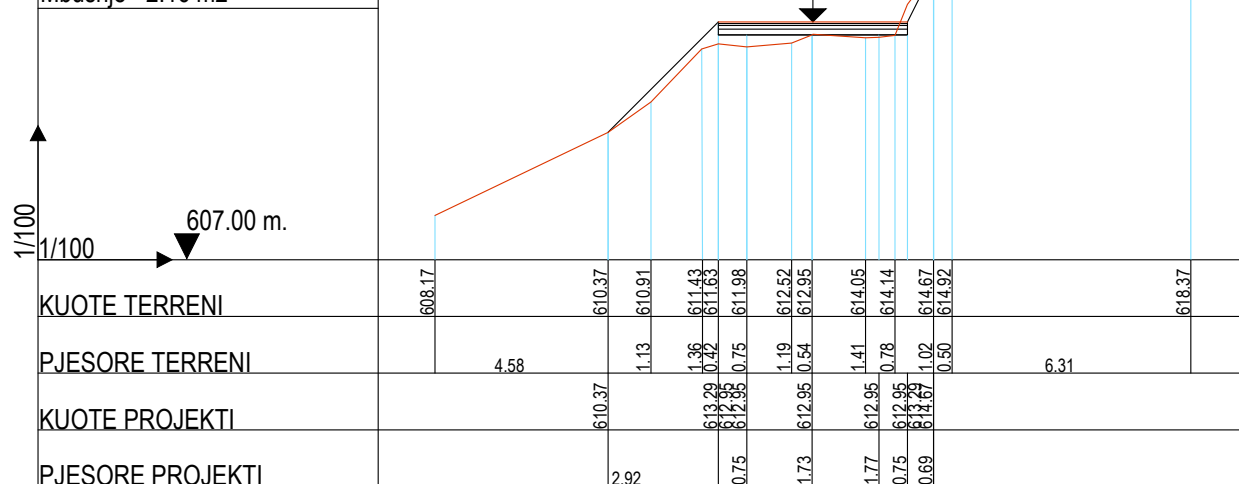

FOROSTITESH:

BASHKIA BULQIZE

EMERTIMI I PROJEKTTIT :

**SISTEM-ASFALTIM I RRUGES BLLACE,
LOTI I, N.J.A. SHUPENZE,
BASHKIA BULQIZE**

FAZA E PROJEKTTIT :

PROJEKT ZBATIMI

EMERTIMI I FLETES :

PROFILAT TERTHORE

SHKALLA 1:200	NR. FLETES 05
------------------	------------------

GRUPI I PROJEKTTIMIT : **"ALBGOLDING 2E" sh.p.k**

Ing. Hajredin MURGU

Ark. Soela MERKO

Ark. Erion MURGU



"ALBGOLDING 2E" sh.p.k

CONTACT:
E-MAIL : albgolding2@gmail.com
Cel: +355 68 52 07 550
+355 68 20 85 763

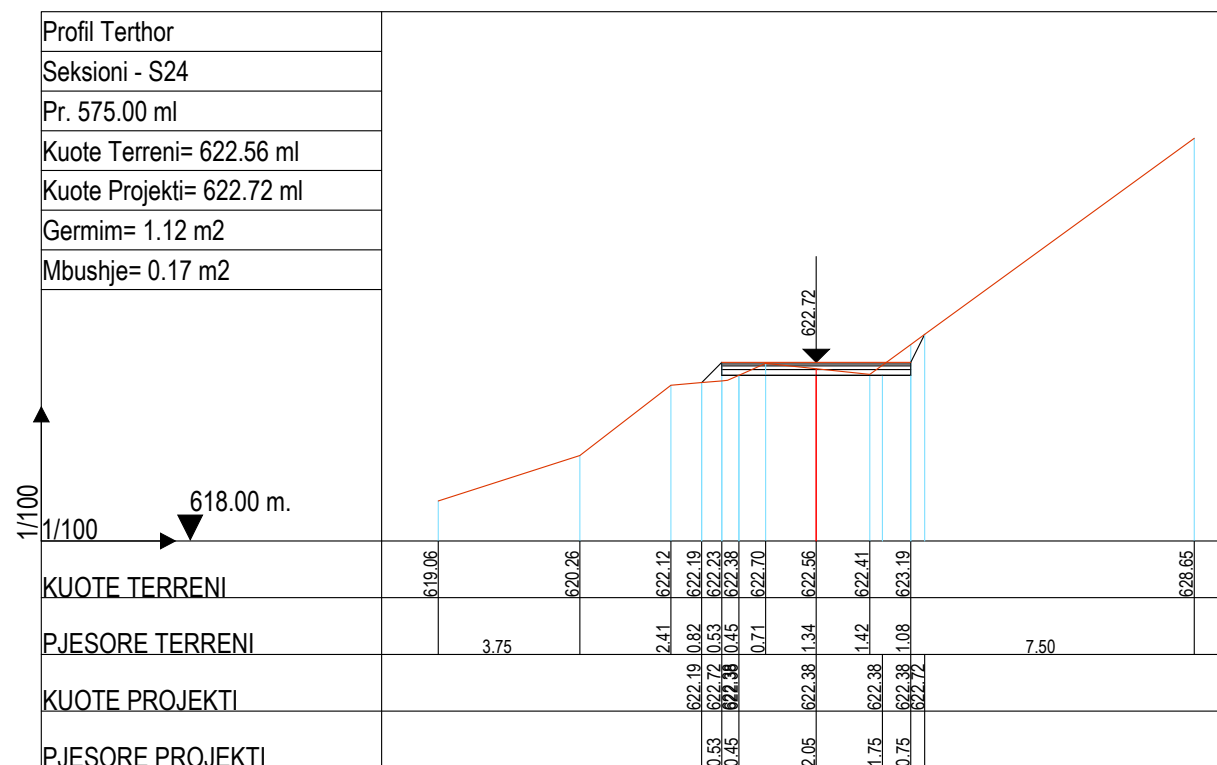
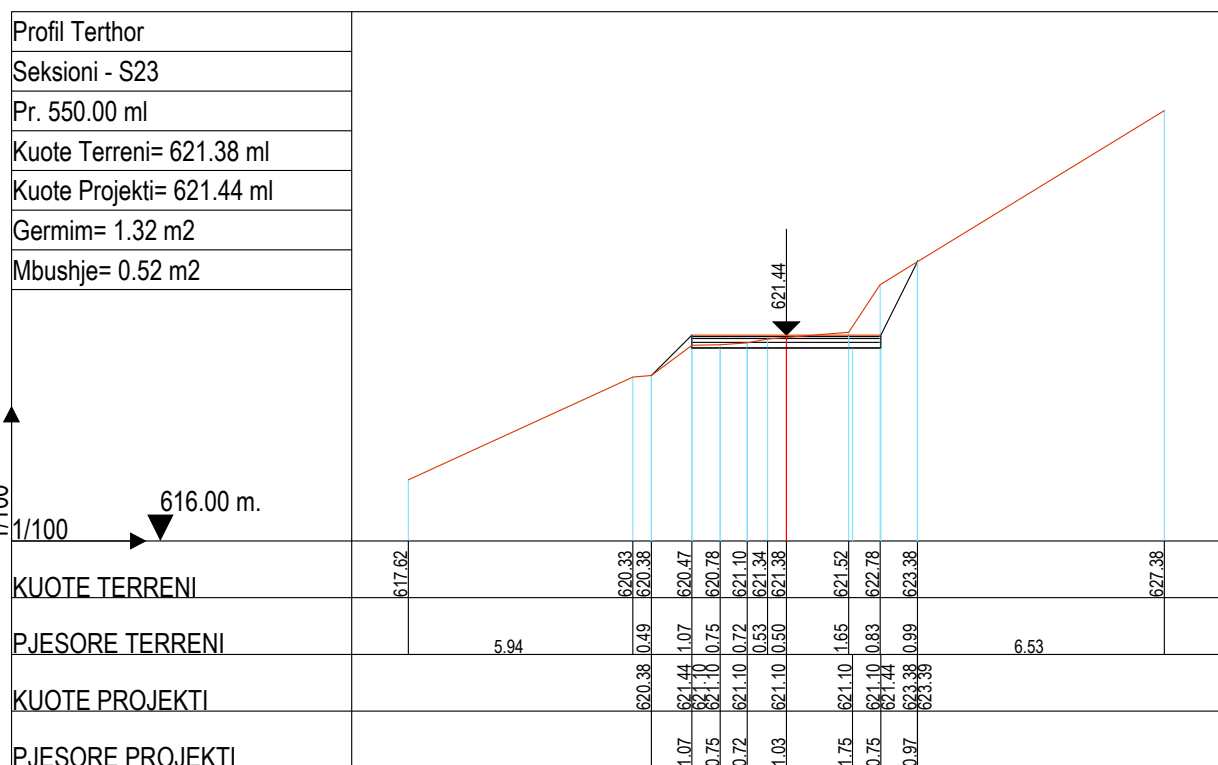
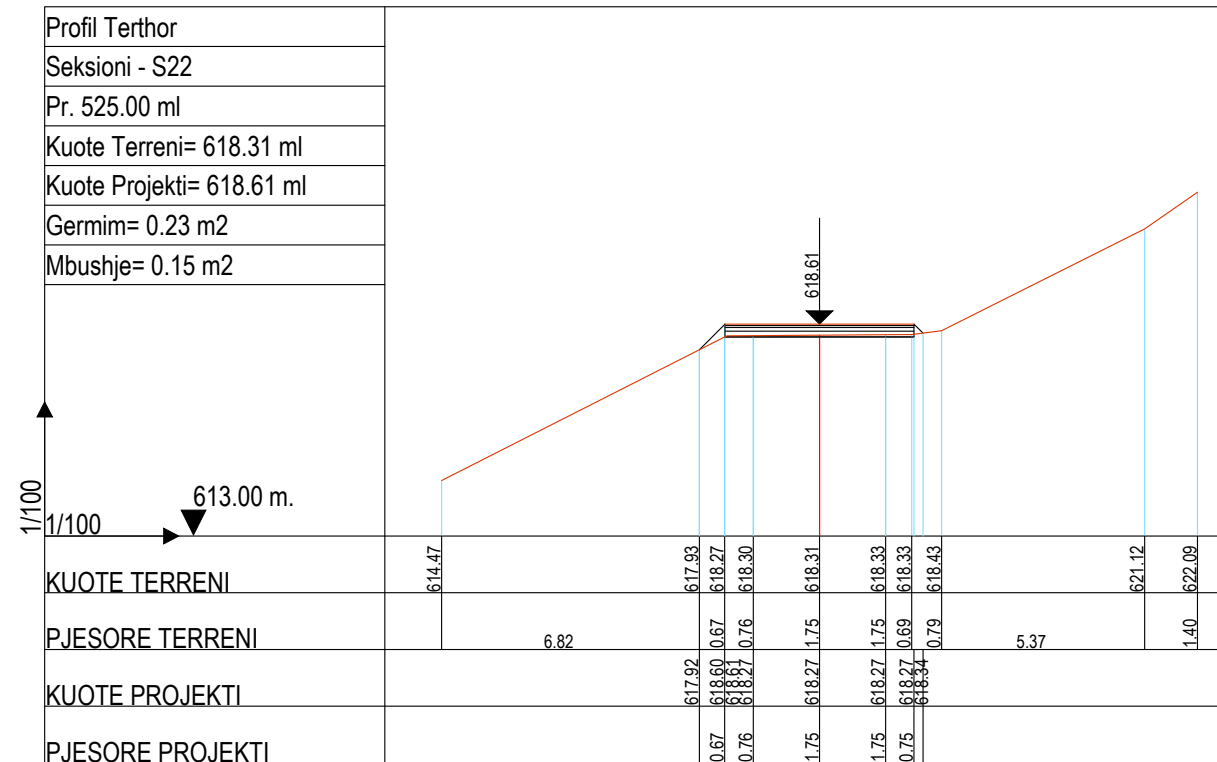
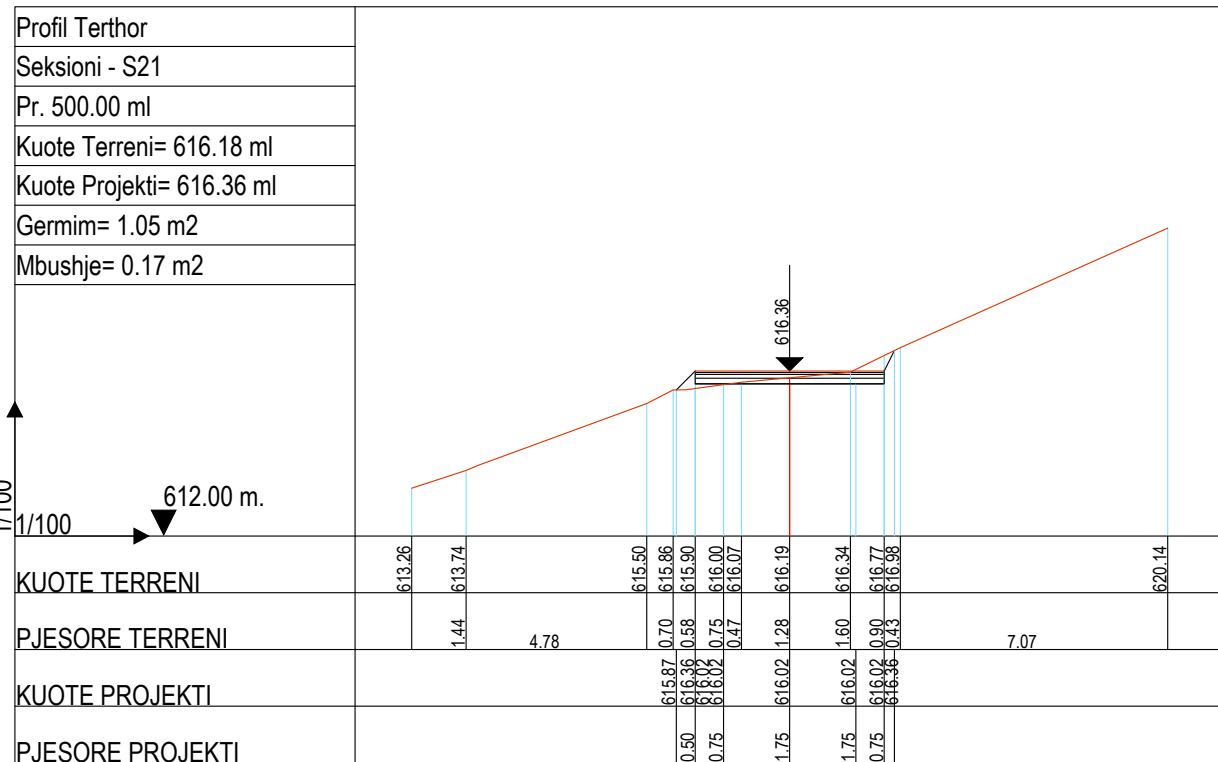

BASHKIA BULQIZE

EMERTIMI I PROJEKTTIT :
**SISTEM-ASFALTIM I RRUGES BLLACE,
LOTI I, N.J.A. SHUPENZE,
BASHKIA BULQIZE**

FAZA E PROJEKTTIT :
PROJEKT ZBATIMI

EMERTIMI I FLETES :
PROFILAT TERTHORE

SHKALLA 1:200	NR. FLETES 06
------------------	------------------

GRUPI I PROJEKTTIMIT : **"ALBGOLDING 2E" sh.p.k**

Ing. Hajredin MURGU
Ark. Soela MERKO
Ark. Erion MURGU

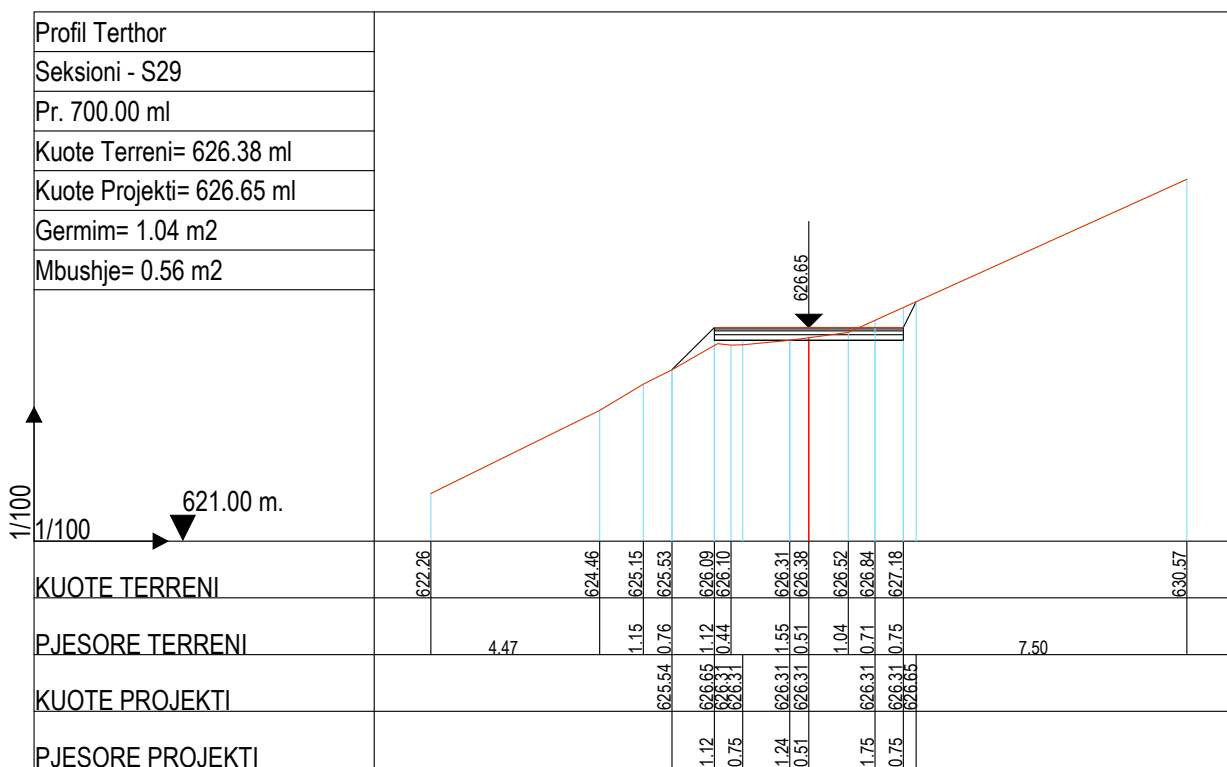
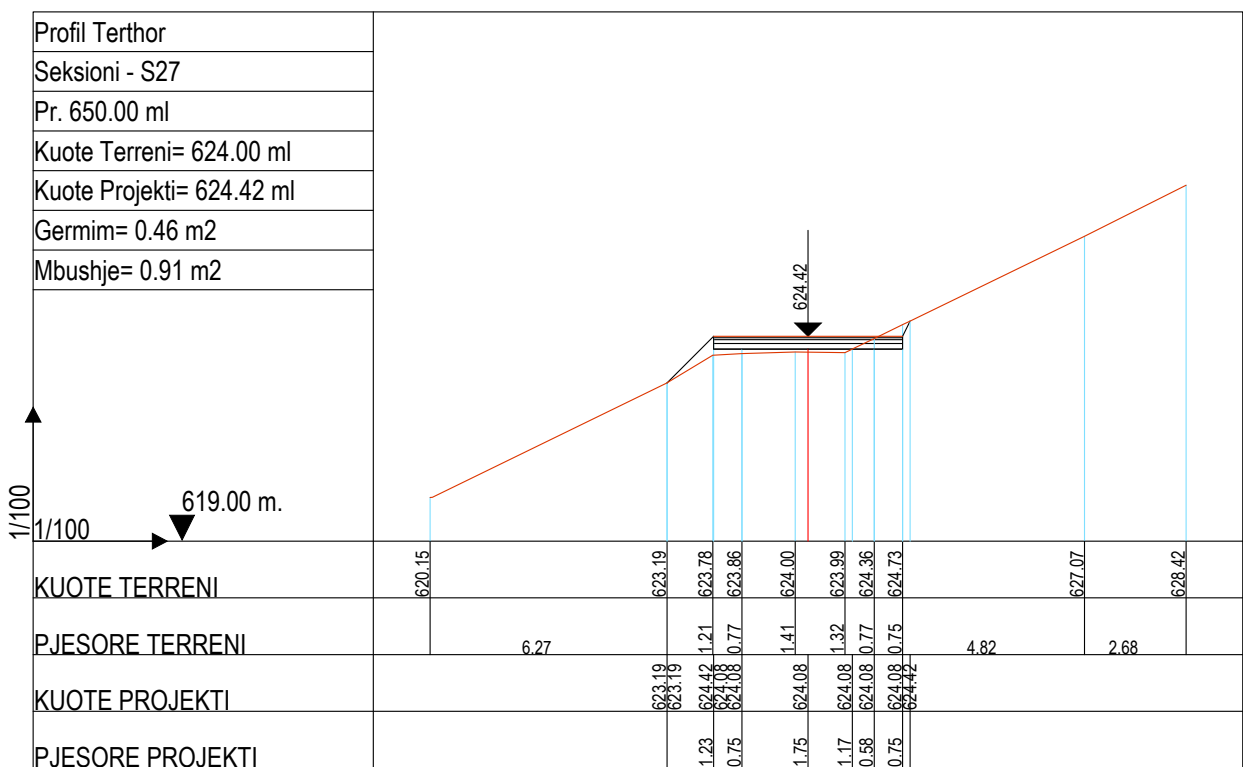
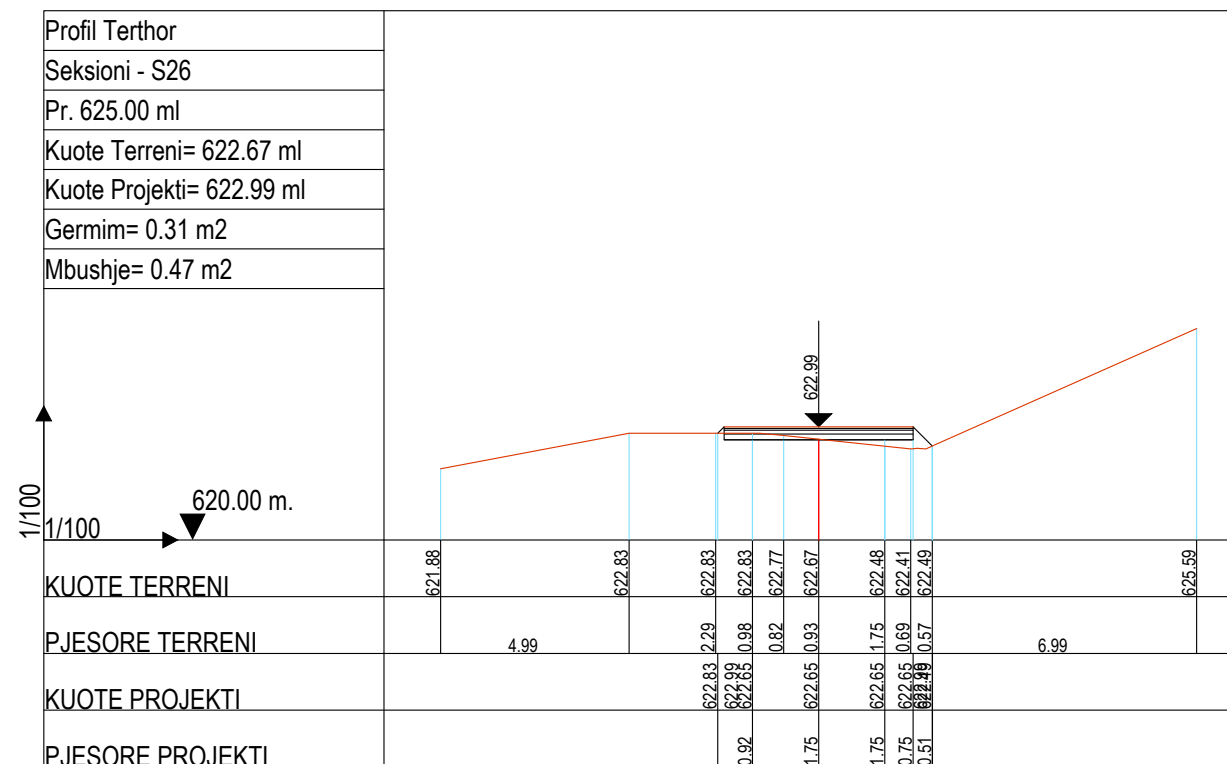
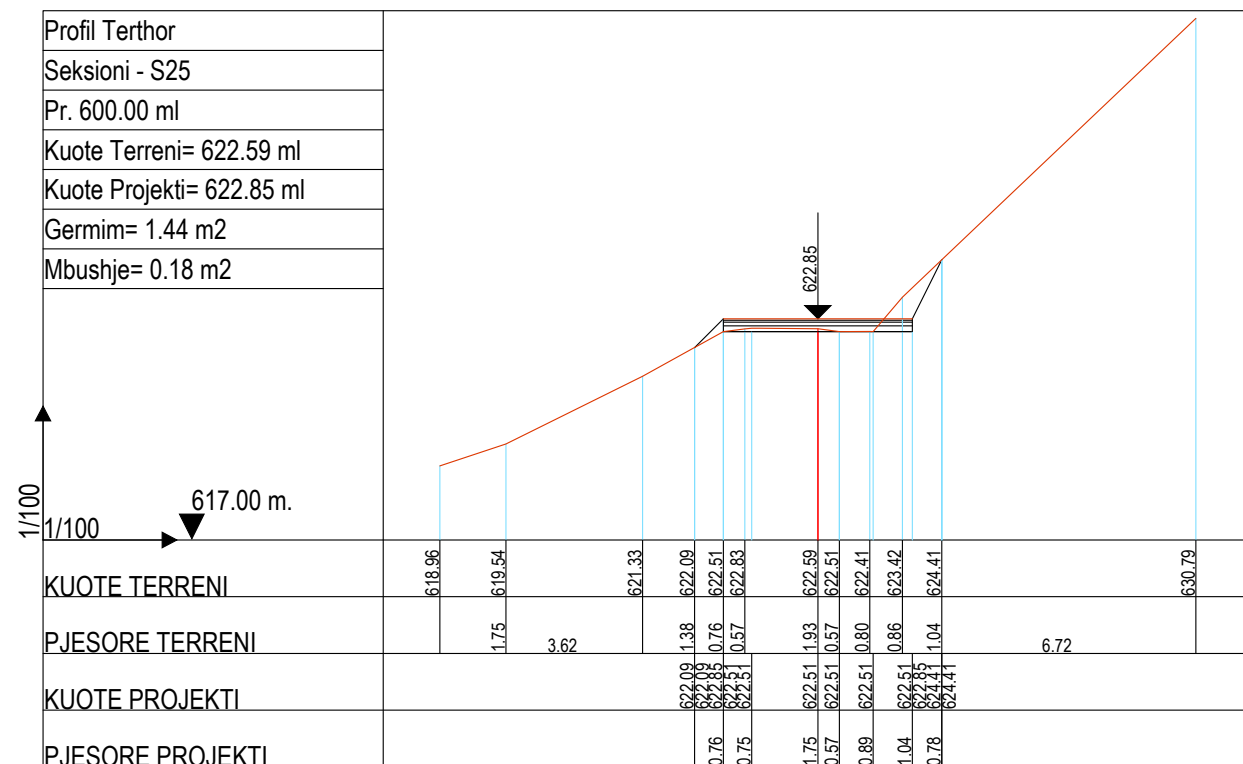

BASHKIA BULQIZE

EMERTIMI I PROJEKTTIT :
**SISTEM-ASFALTIM I RRUGES BLLACE,
LOTI I, N.J.A. SHUPENZE,
BASHKIA BULQIZE**

FAZA E PROJEKTTIT :
PROJEKT ZBATIMI

EMERTIMI I FLETES :
PROFILAT TERTHORE

SHKALLA 1:200	NR. FLETES 07
------------------	------------------

GRUPI I PROJEKTTIMIT : **"ALBGOLDING 2E" sh.p.k**

Ing. Hajredin MURGU
Ark. Soela MERKO
Ark. Erion MURGU

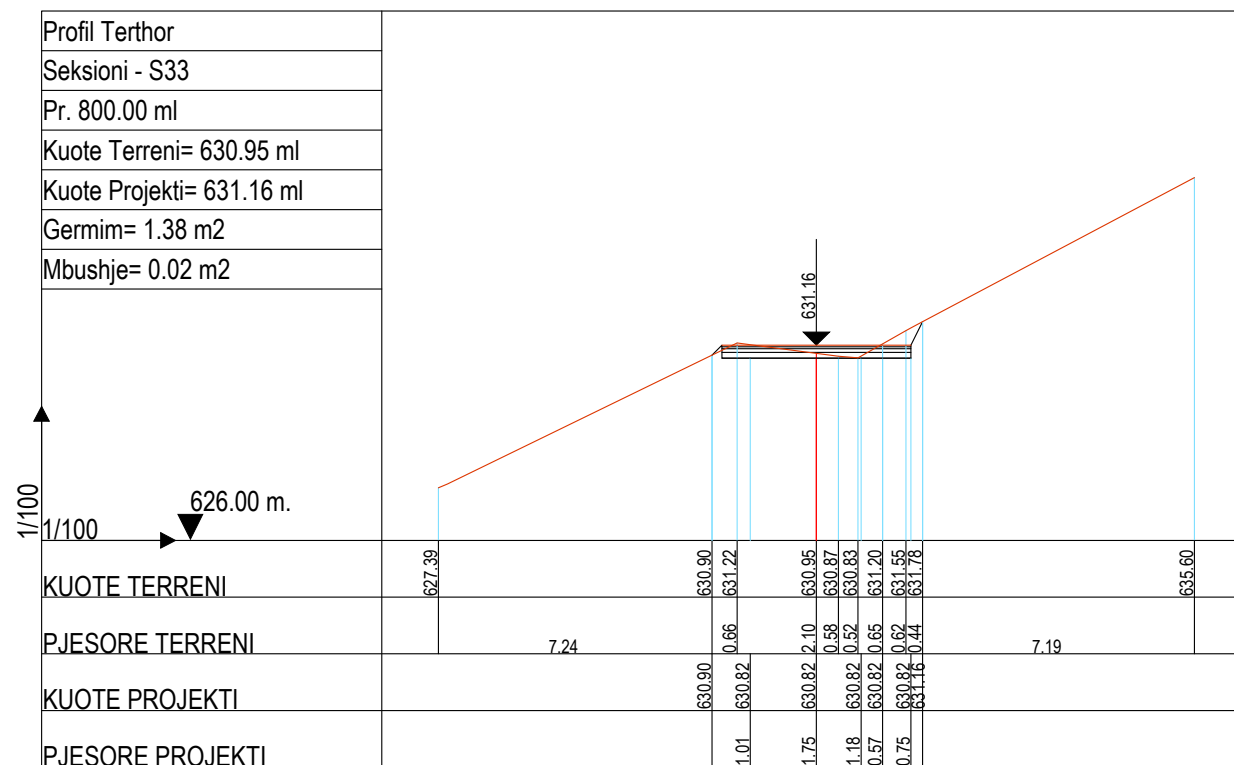
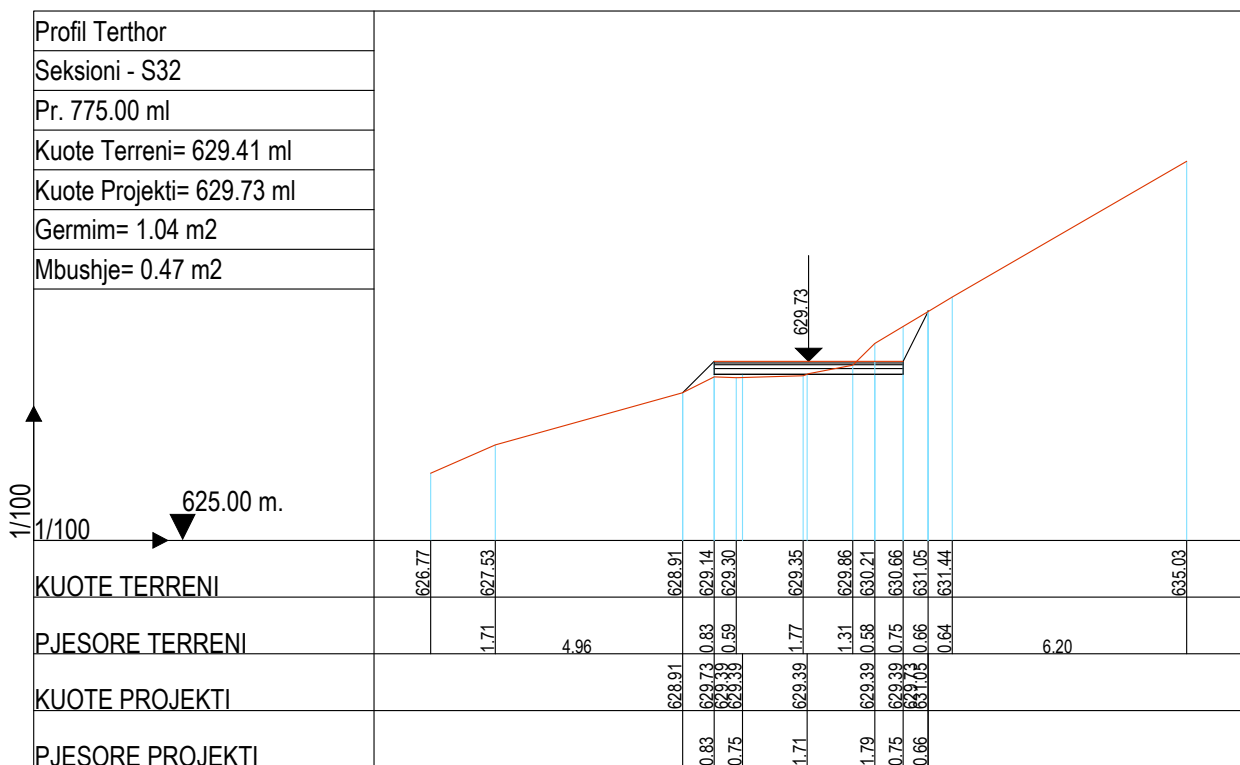
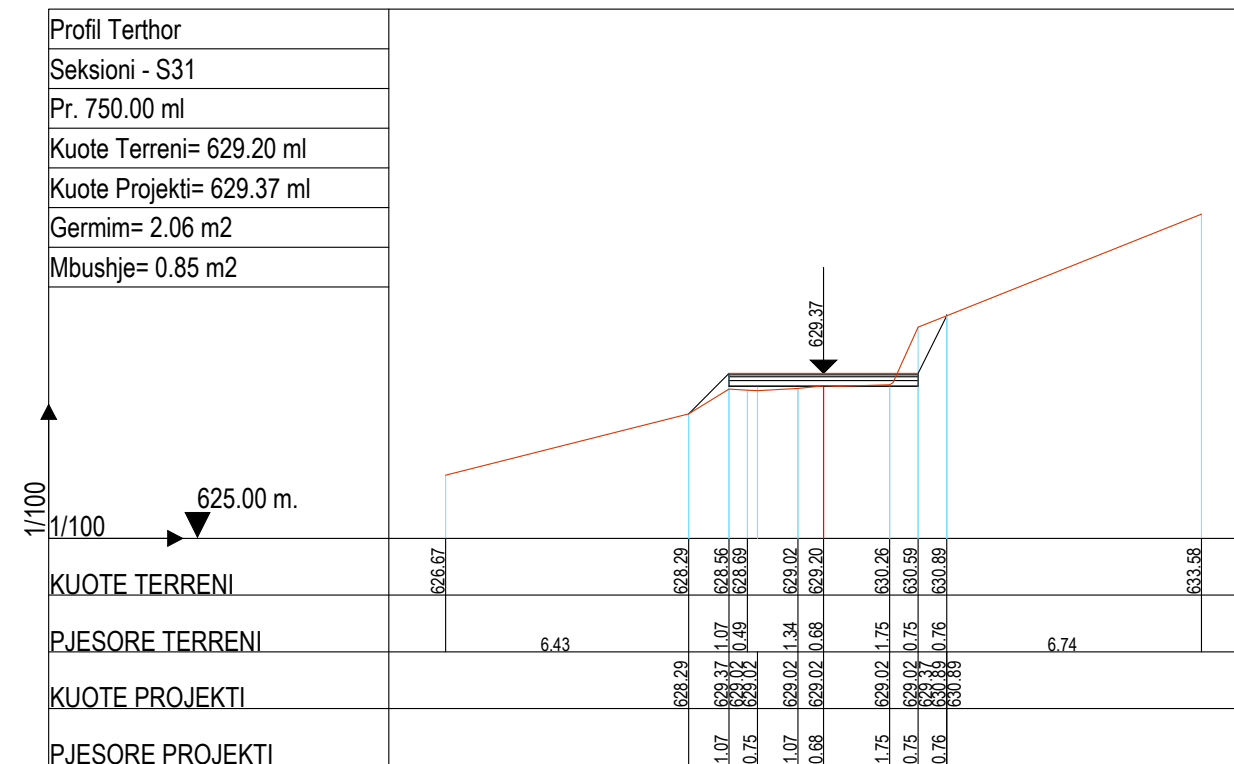
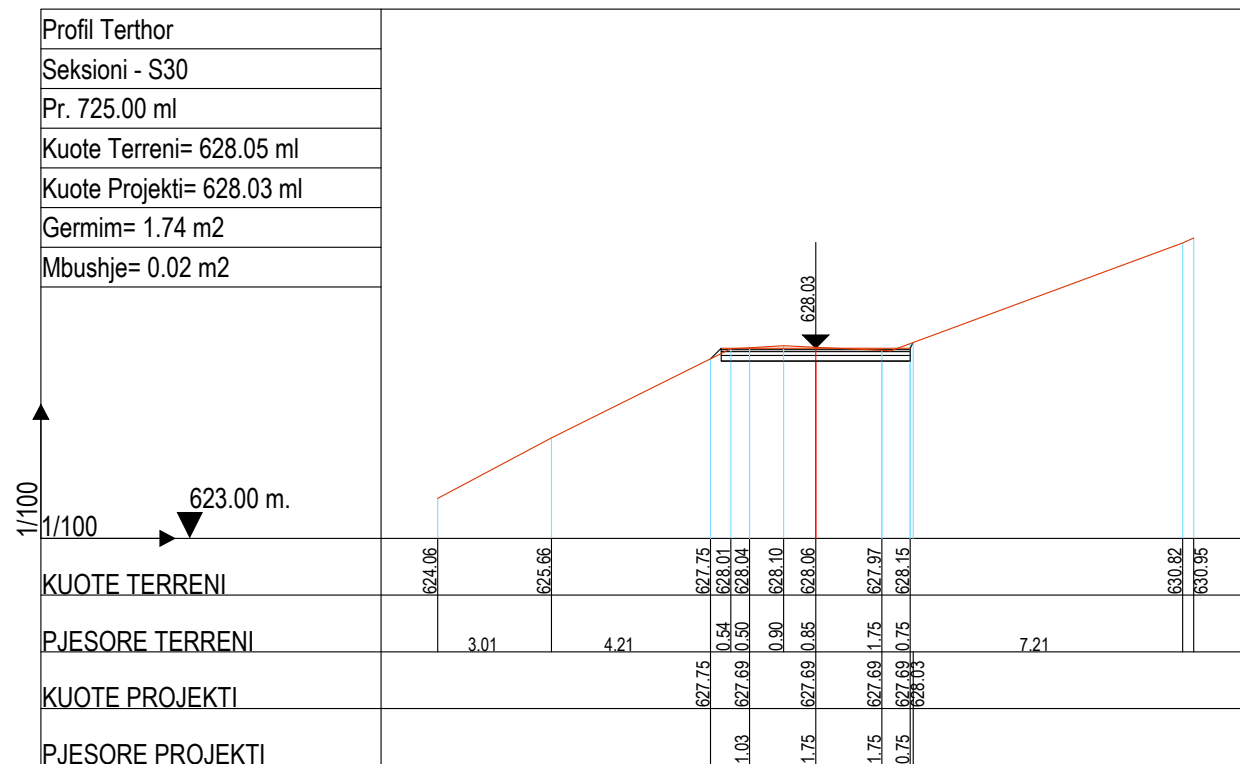

BASHKIA BULQIZE

EMERTIMI I PROJEKTTIT :
**SISTEM-ASFALTIM I RRUGES BLLACE,
LOTI I, N.J.A. SHUPENZE,
BASHKIA BULQIZE**

FAZA E PROJEKTTIT :
PROJEKT ZBATIMI

EMERTIMI I FLETES :
PROFILAT TERTHORE

SHKALLA 1:200	NR. FLETES 08
------------------	------------------

GRUPI I PROJEKTTIMIT : **"ALBGOLDING 2E" sh.p.k**

Ing. Hajredin MURGU
Ark. Soela MERKO
Ark. Erion MURGU

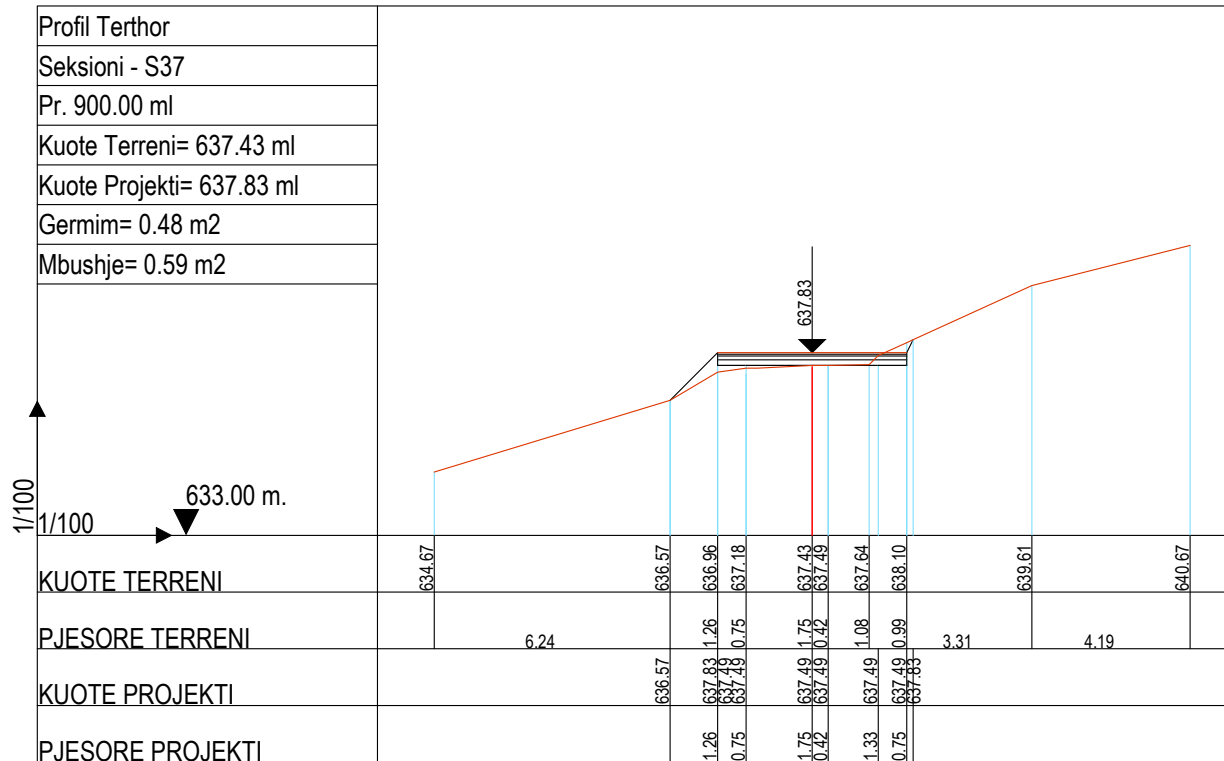
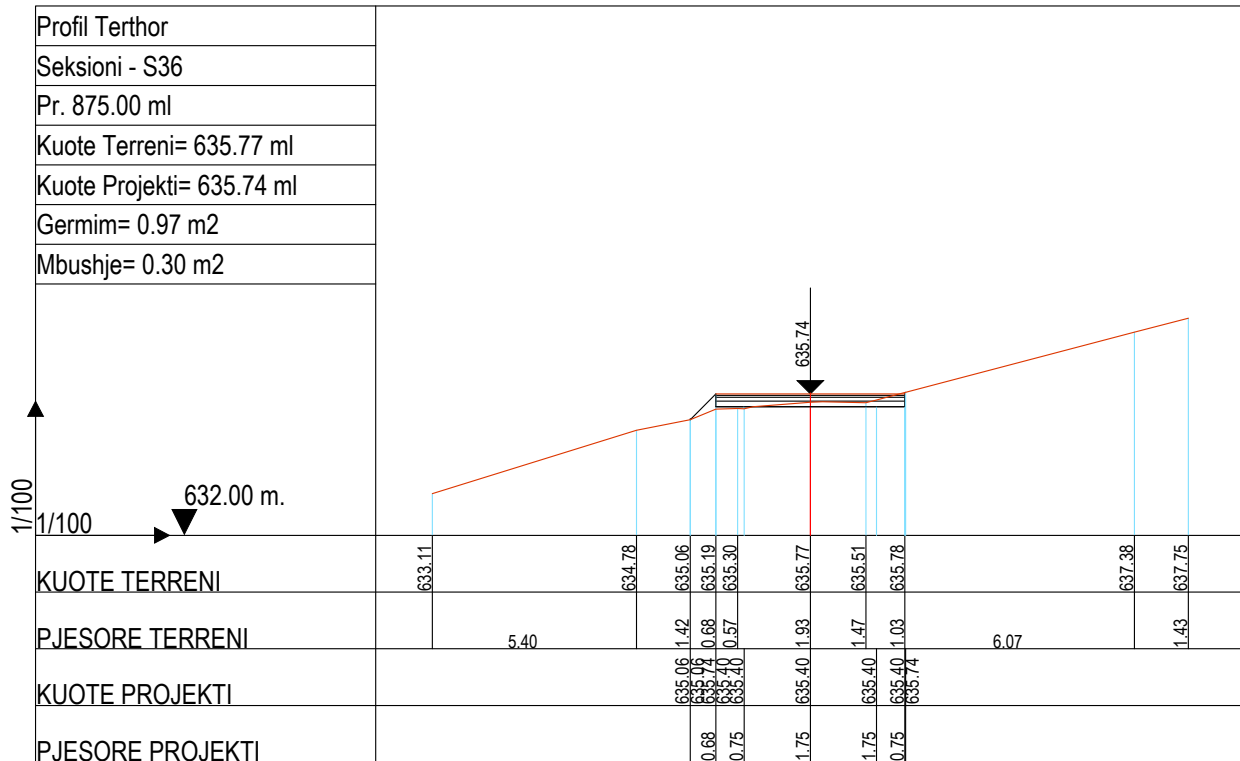
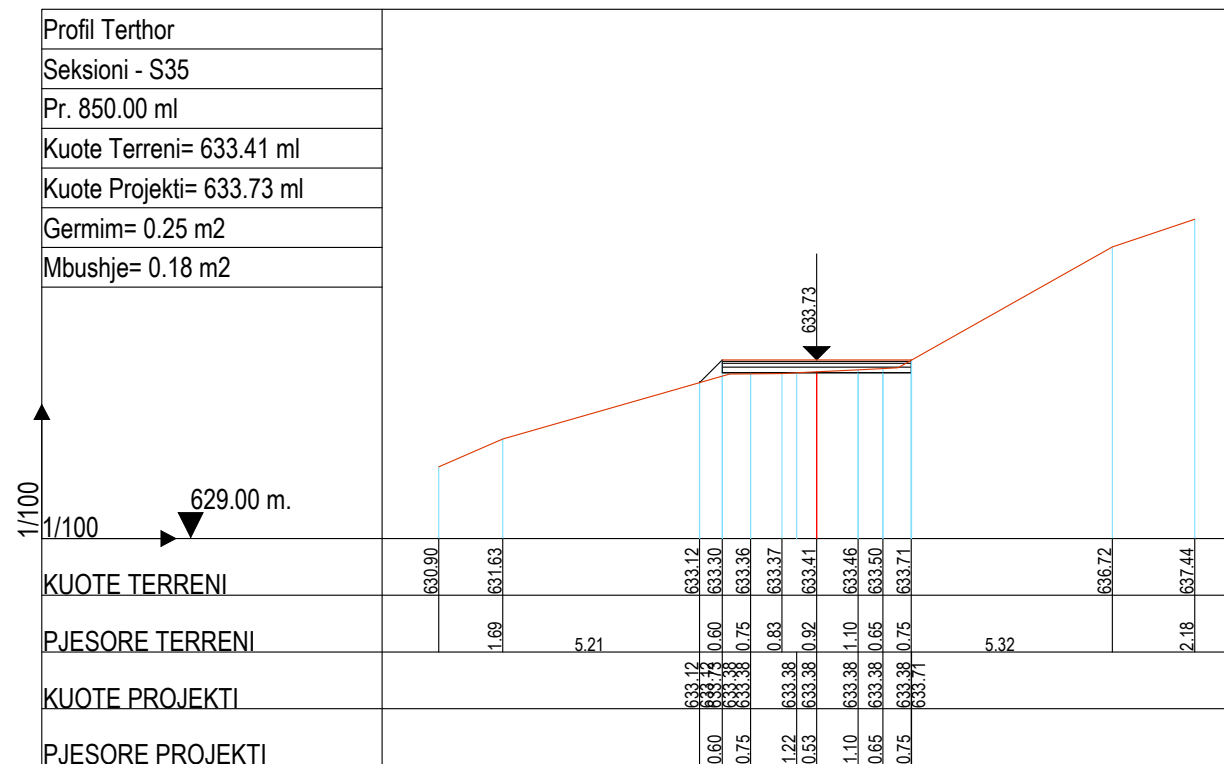
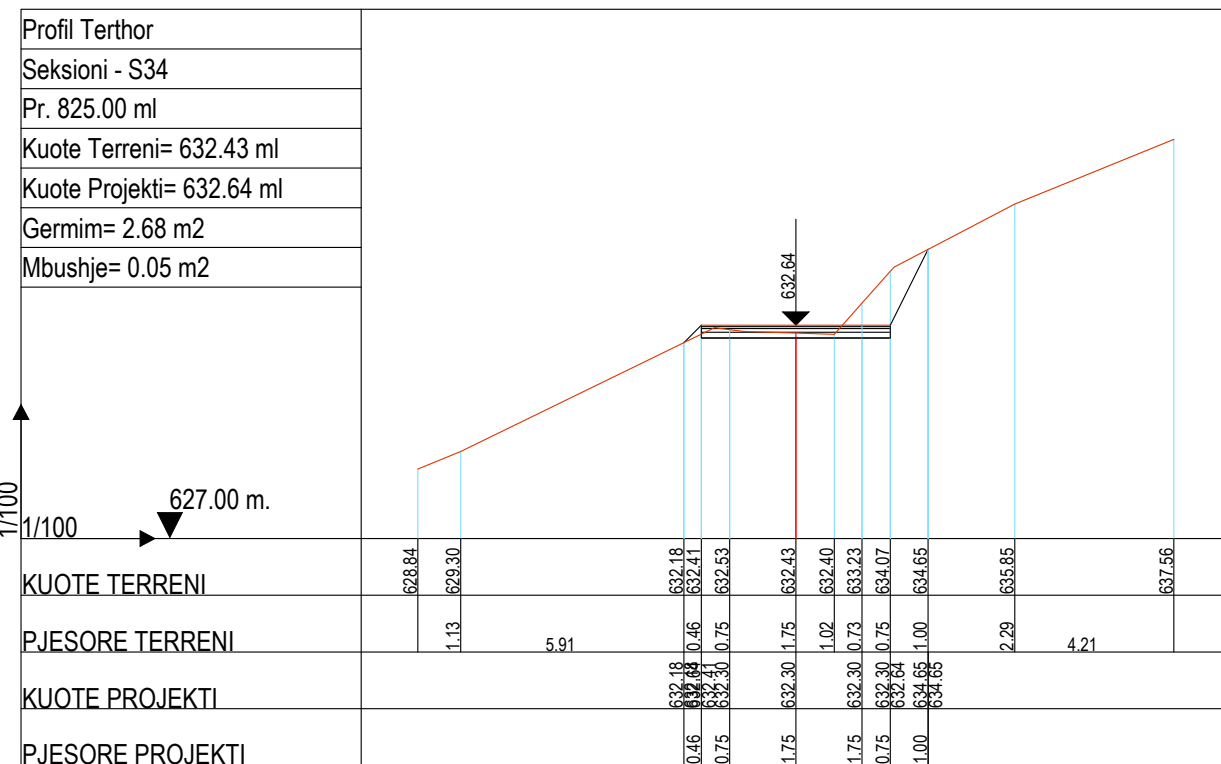

FOROSITESH:

BASHKIA BULQIZE

EMERTIMI I PROJEKTTIT :

**SISTEM-ASFALTIM I RRUGES BLLACE,
LOTI I, N.J.A. SHUPENZE,
BASHKIA BULQIZE**

FAZA E PROJEKTTIT :

PROJEKT ZBATIMI

EMERTIMI I FLETES :

PROFILAT TERTHORE

SHKALLA 1:200	NR. FLETES 09
------------------	------------------

GRUPI I PROJEKTIMIT : **"ALBGOLDING 2E" sh.p.k**

Ing. Hajredin MURGU

Ark. Soela MERKO

Ark. Erion MURGU



"ALBGOLDING 2E" sh.p.k

CONTACT:
E-MAIL : albgolding2@gmail.com
Cel: +355 68 52 07 550
+355 68 20 85 763

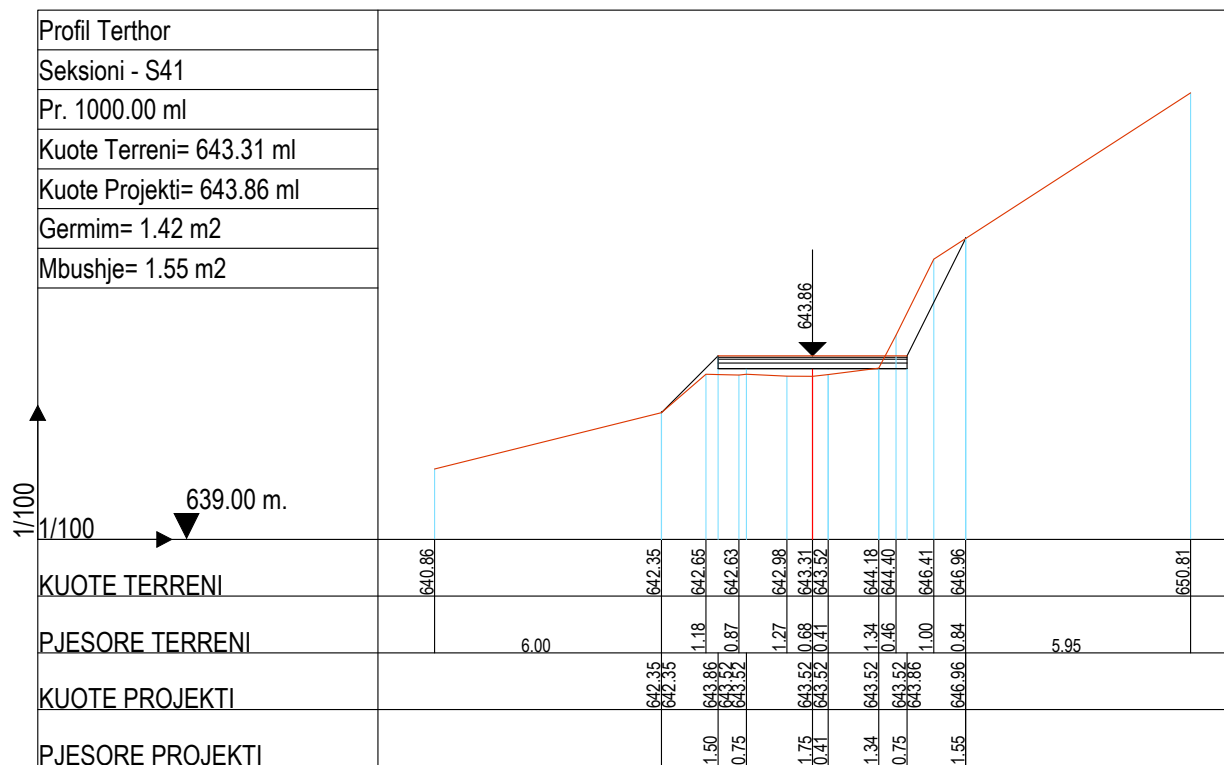
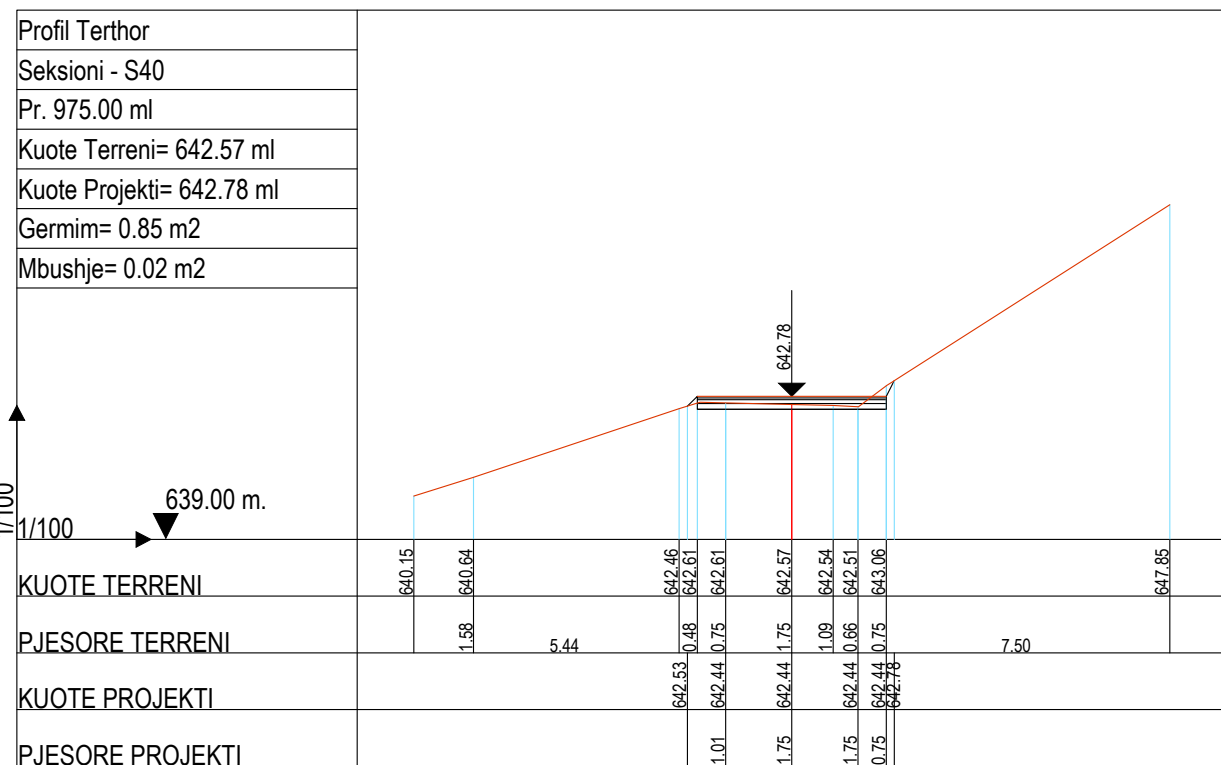
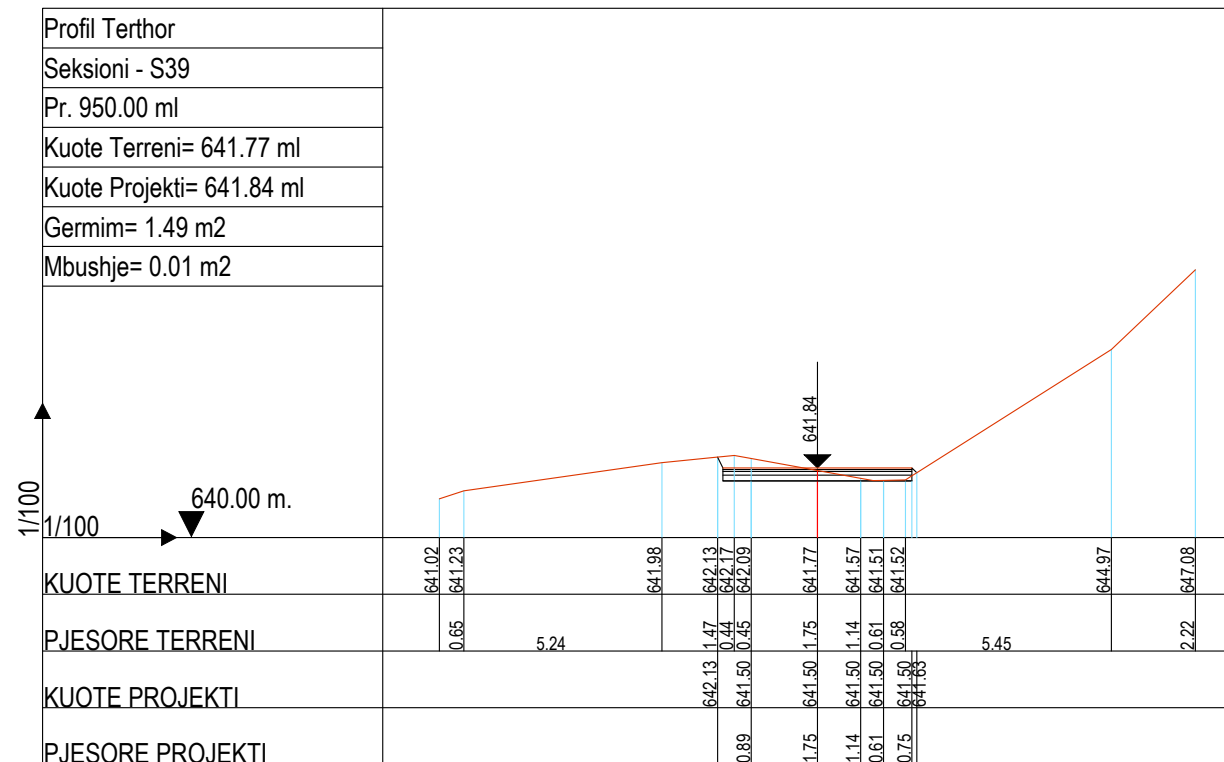
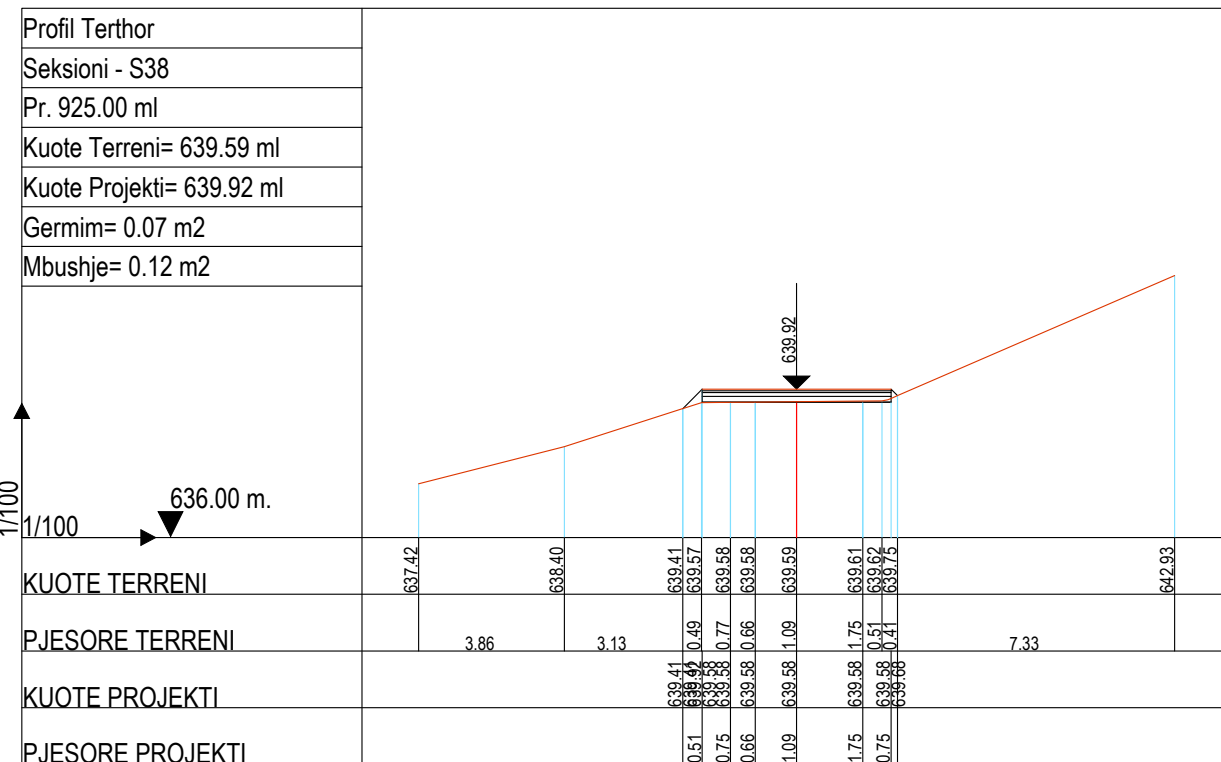

FOROSHTESI:

BASHKIA BULQIZE

EMERTIMI I PROJEKTTIT :

**SISTEM-ASFALTIM I RRUGES BLLACE,
LOTI I, N.J.A. SHUPENZE,
BASHKIA BULQIZE**

FAZA E PROJEKTTIT :

PROJEKT ZBATIMI

EMERTIMI I FLETES :

PROFILAT TERTHORE

SHKALLA 1:200	NR. FLETES 10
------------------	------------------

GRUPI I PROJEKTTIMIT : **"ALBGOLDING 2E" sh.p.k**

Ing. Hajredin MURGU

Ark. Soela MERKO

Ark. Erion MURGU



"ALBGOLDING 2E" sh.p.k

CONTACT:
E-MAIL : albgolding2@gmail.com
Cel: +355 68 52 07 550
+355 68 20 85 763

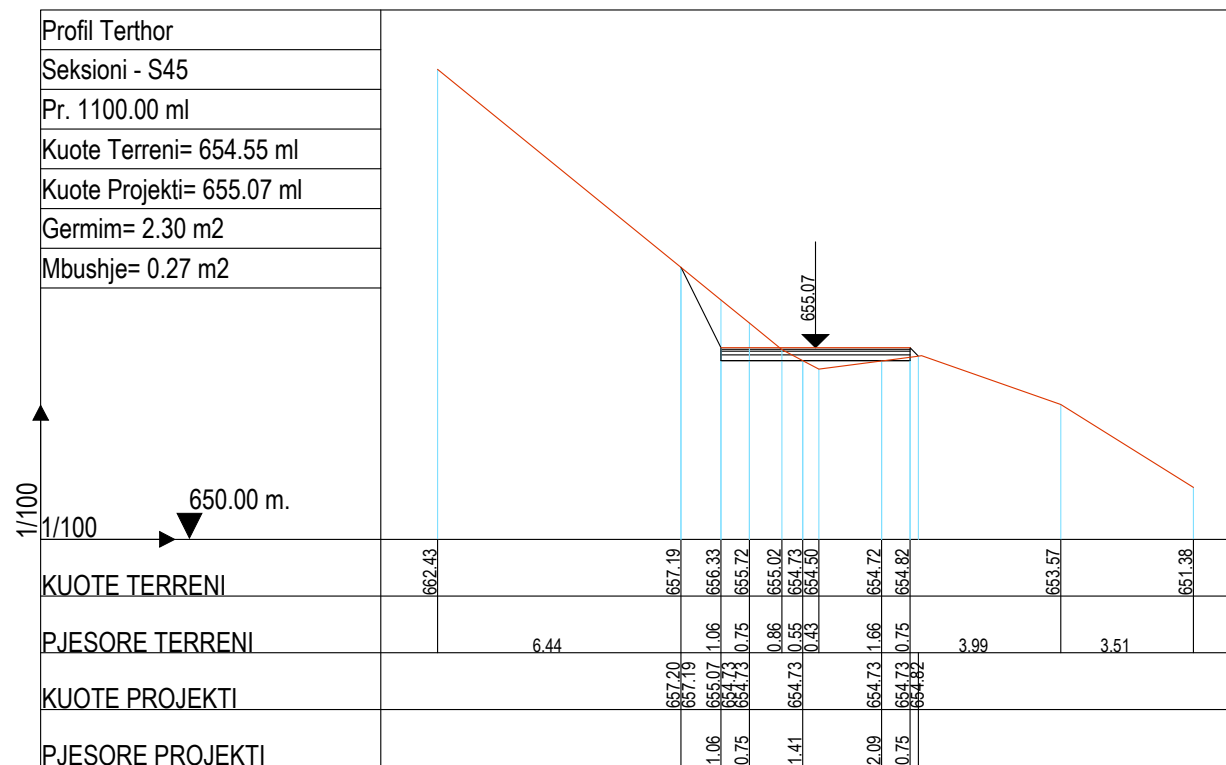
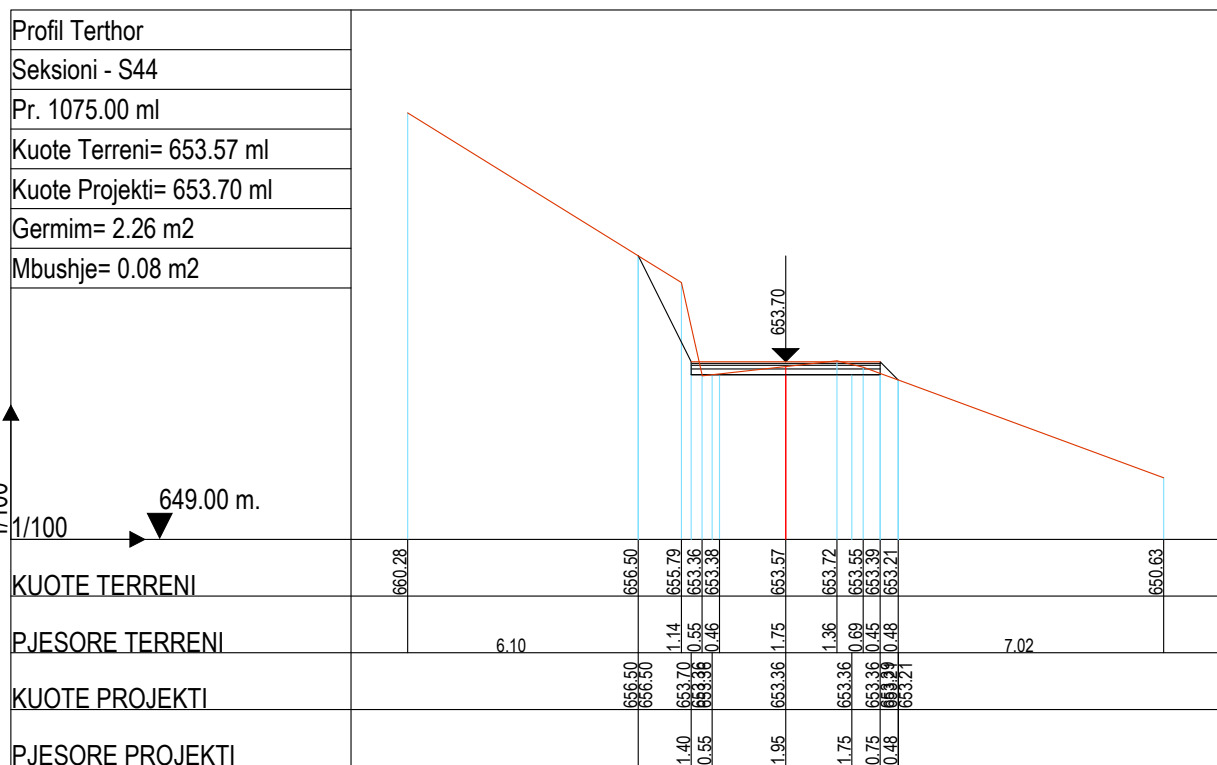
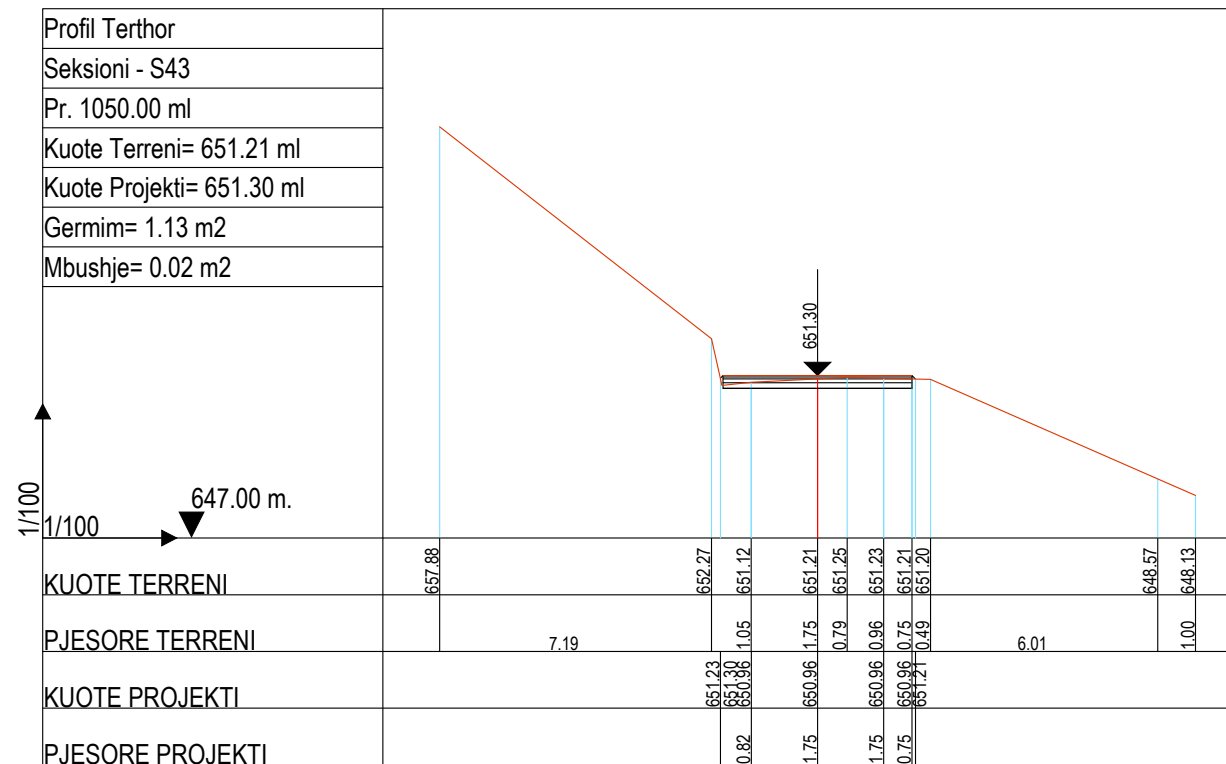
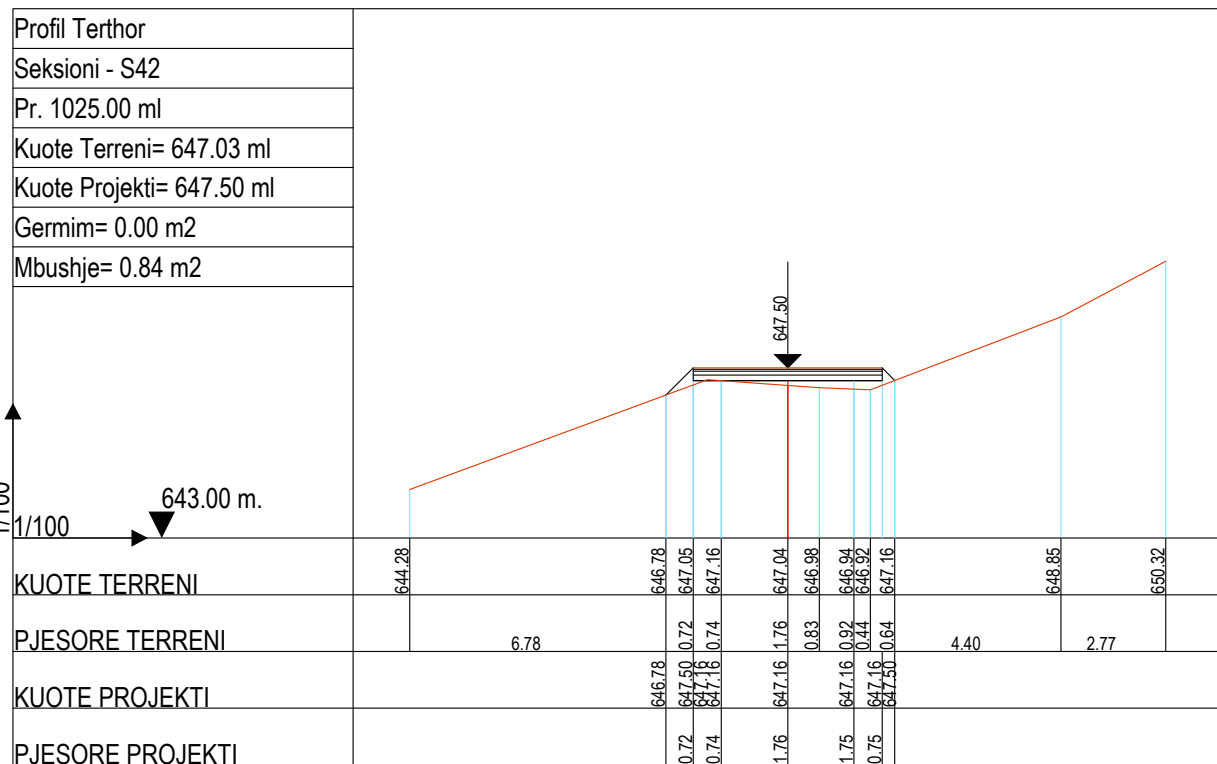

FOROSTITESH:

BASHKIA BULQIZE

EMERTIMI I PROJEKTTIT :
**SISTEM-ASFALTIM I RRUGES BLLACE,
LOTI I, N.J.A. SHUPENZE,
BASHKIA BULQIZE**

FAZA E PROJEKTTIT :
PROJEKT ZBATIMI

EMERTIMI I FLETES :
PROFILAT TERTHORE

SHKALLA 1:200	NR. FLETES 11
------------------	------------------

GRUPI I PROJEKTTIMIT : **"ALBGOLDING 2E" sh.p.k**

Ing. Hajredin MURGU
Ark. Soela MERKO
Ark. Erion MURGU

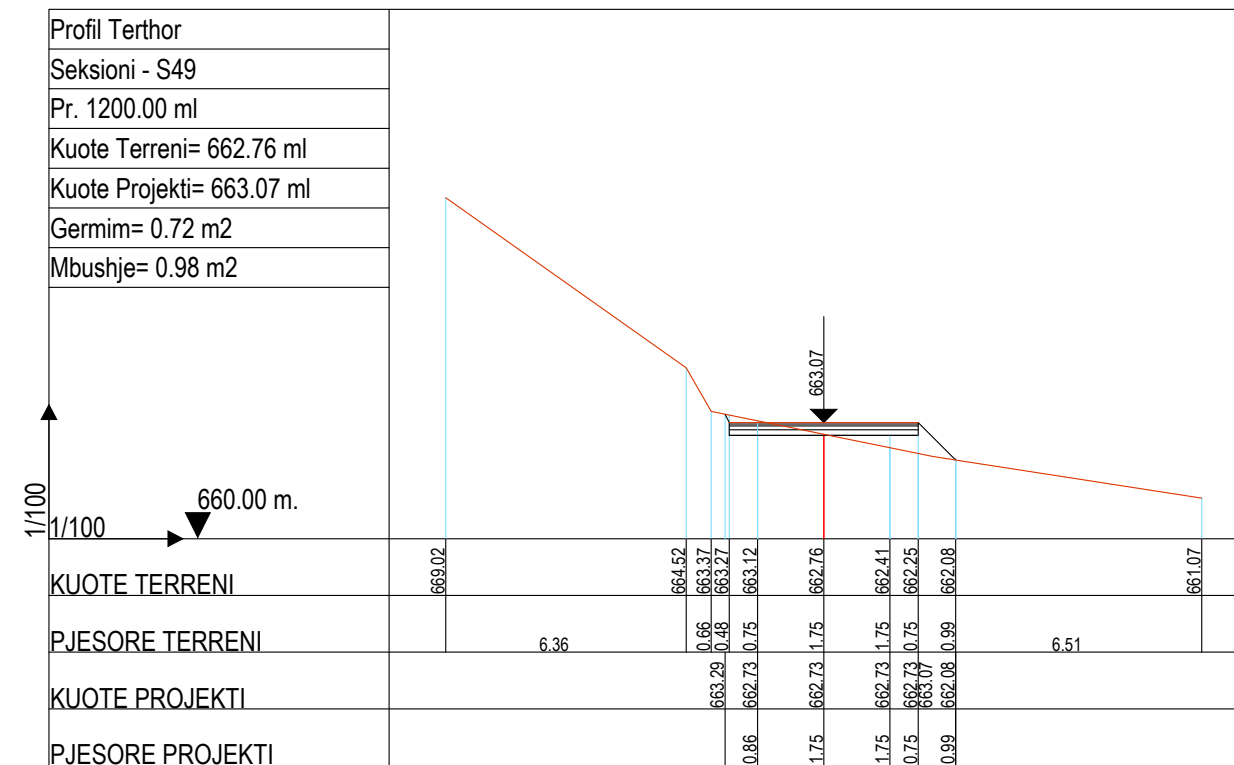
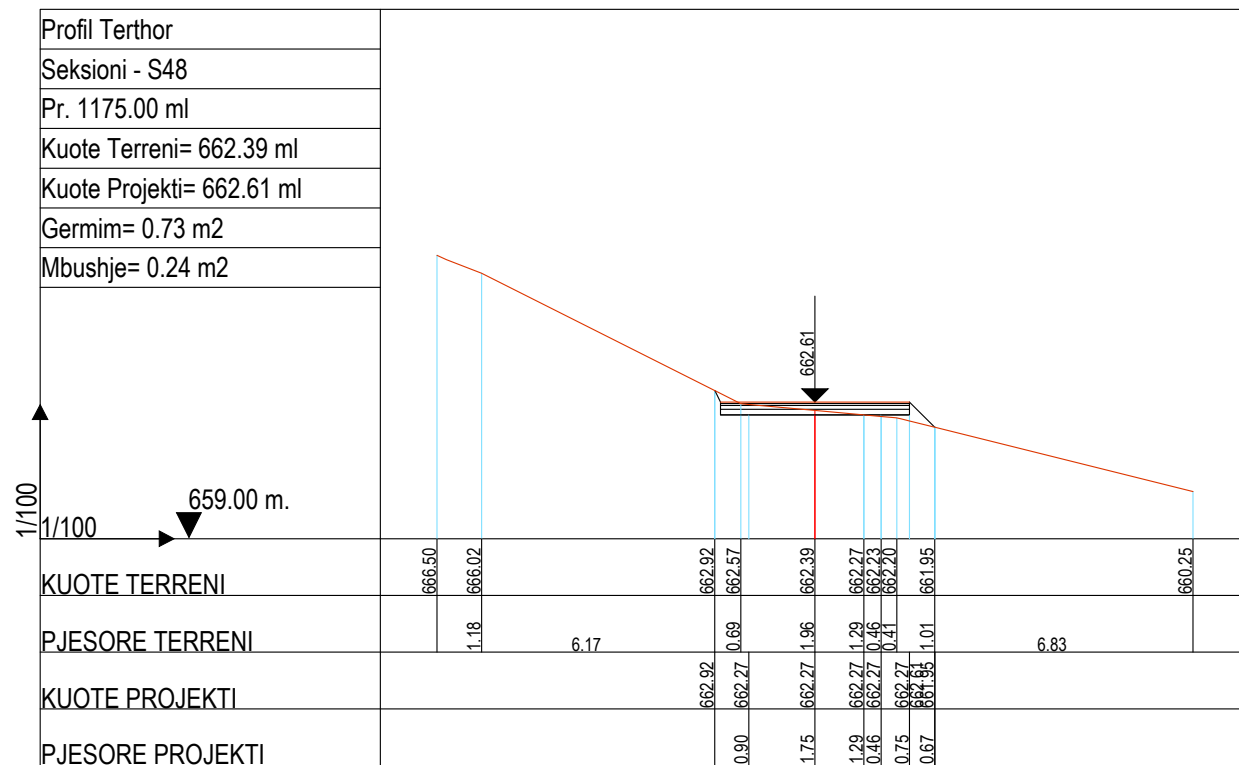
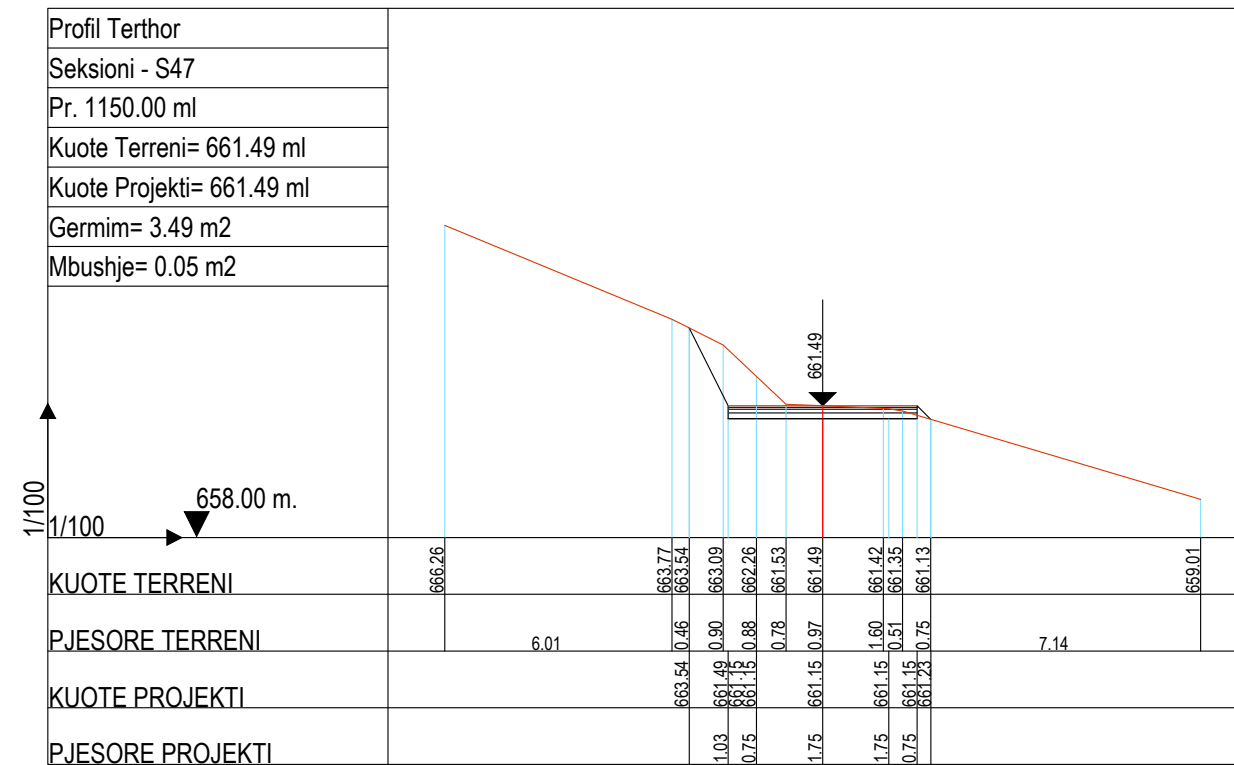
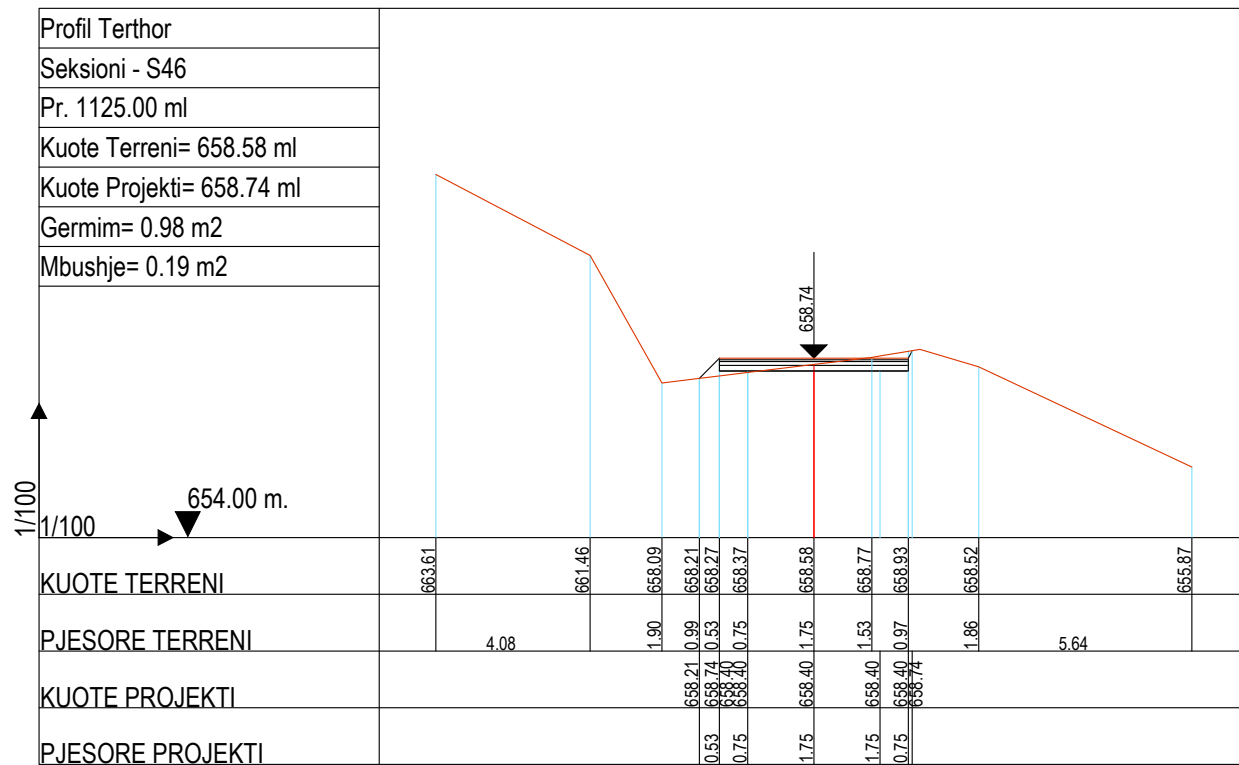

FOROSITESH:

BASHKIA BULQIZE

EMERTIMI I PROJEKTTIT :

**SISTEM-ASFALTIM I RRUGES BLLACE,
LOTI I, N.J.A. SHUPENZE,
BASHKIA BULQIZE**

FAZA E PROJEKTTIT :

PROJEKT ZBATIMI

EMERTIMI I FLETES :

PROFILAT TERTHORE

SHKALLA 1:200	NR. FLETES 12
------------------	------------------

GRUPI I PROJEKTIMIT : **"ALBGOLDING 2E" sh.p.k**

Ing. Hajredin MURGU

Ark. Soela MERKO

Ark. Erion MURGU



"ALBGOLDING 2E" sh.p.k

CONTACT:
E-MAIL : albgolding2@gmail.com
Cel: +355 68 52 07 550
+355 68 20 85 763

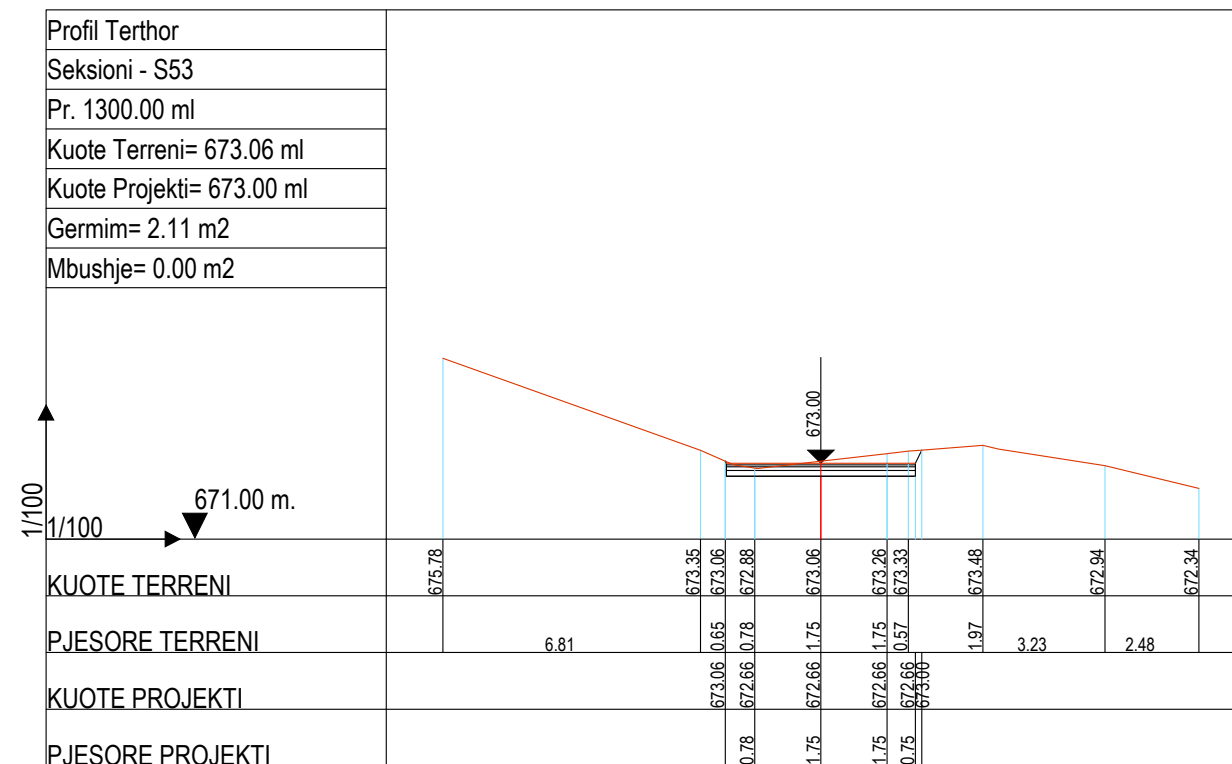
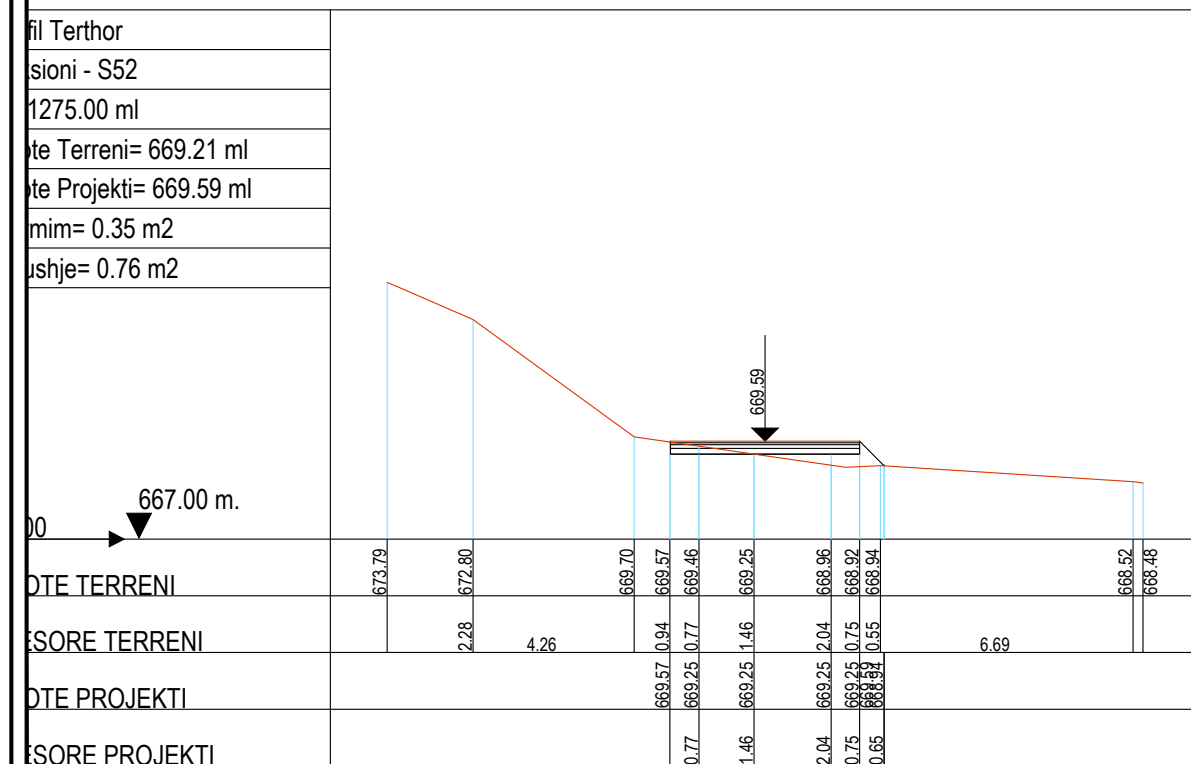
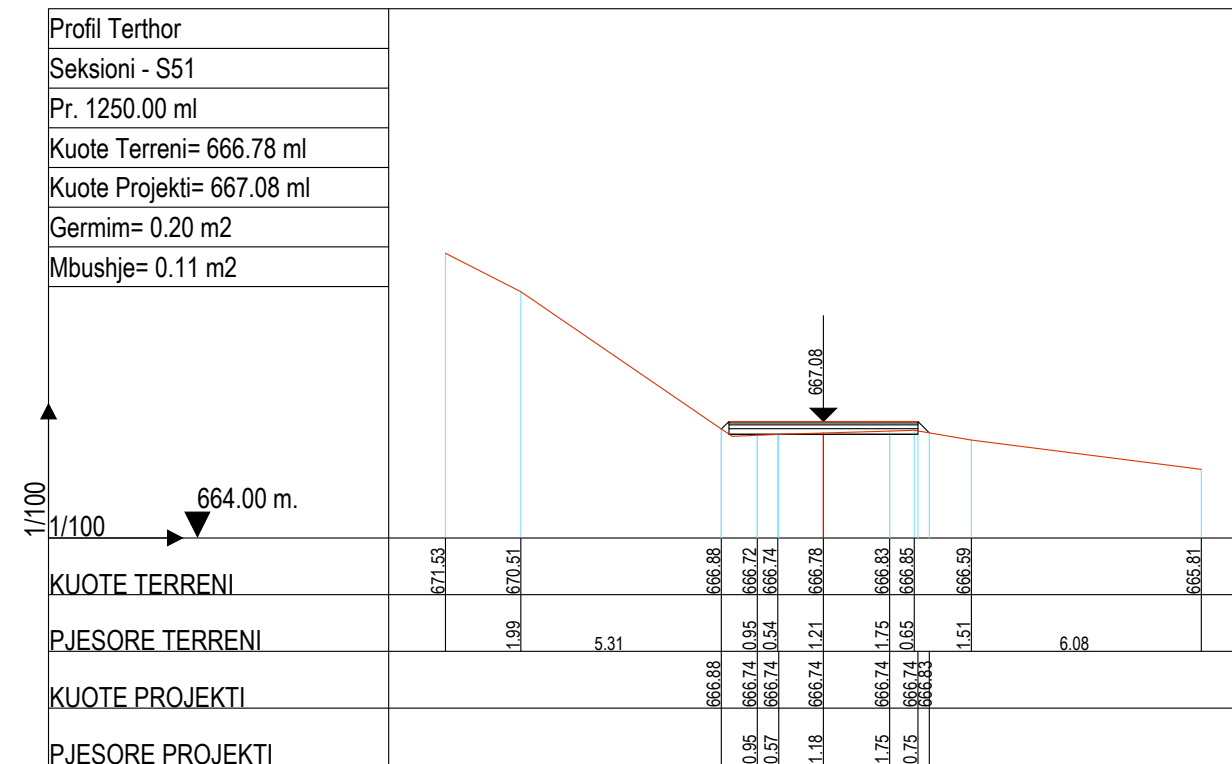
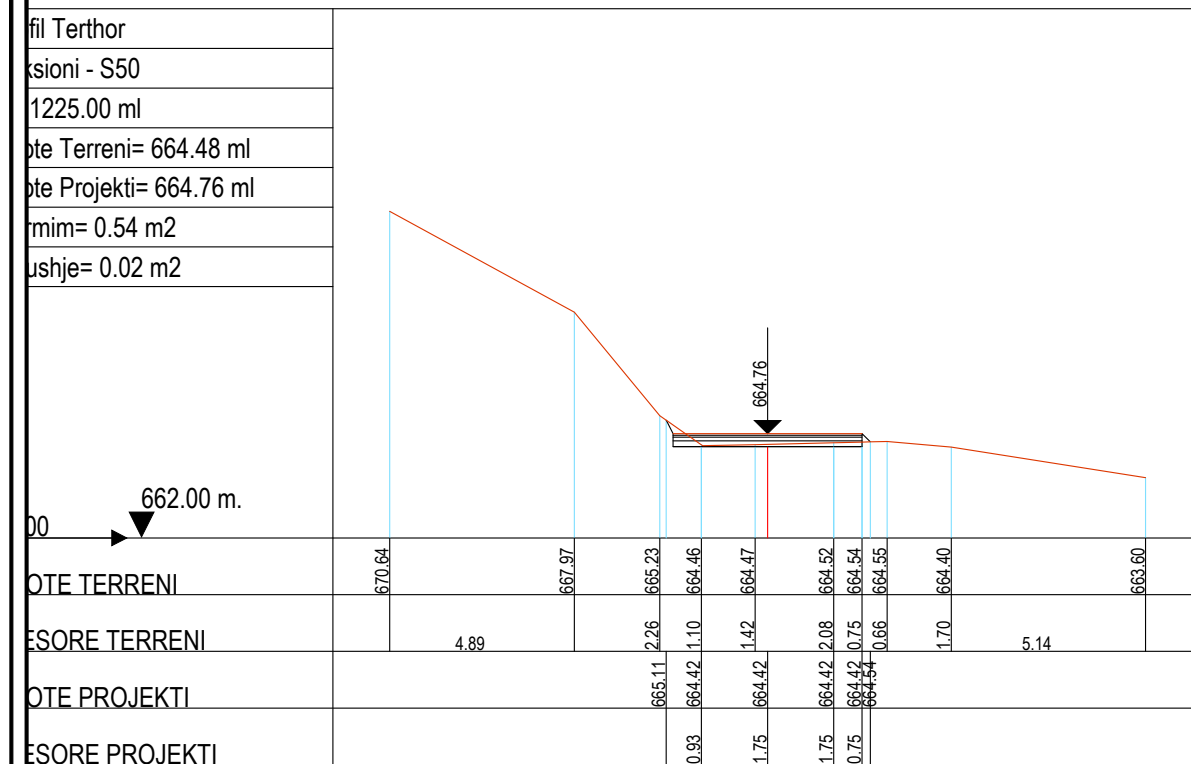

FOROSTESI:

BASHKIA BULQIZE

EMERTIMI I PROJEKTTIT :

**SISTEM-ASFALTIM I RRUGES BLLACE,
LOTI I, N.J.A. SHUPENZE,
BASHKIA BULQIZE**

FAZA E PROJEKTTIT :

PROJEKT ZBATIMI

EMERTIMI I FLETES :

PROFILAT TERTHORE

SHKALLA 1:200	NR. FLETES 13
------------------	------------------

GRUPI I PROJEKTTIMIT : **"ALBGOLDING 2E" sh.p.k**

Ing. Hajredin MURGU

Ark. Soela MERKO

Ark. Erion MURGU



"ALBGOLDING 2E" sh.p.k

CONTACT:
E-MAIL : albgolding2@gmail.com
Cel: +355 68 52 07 550
+355 68 20 85 763

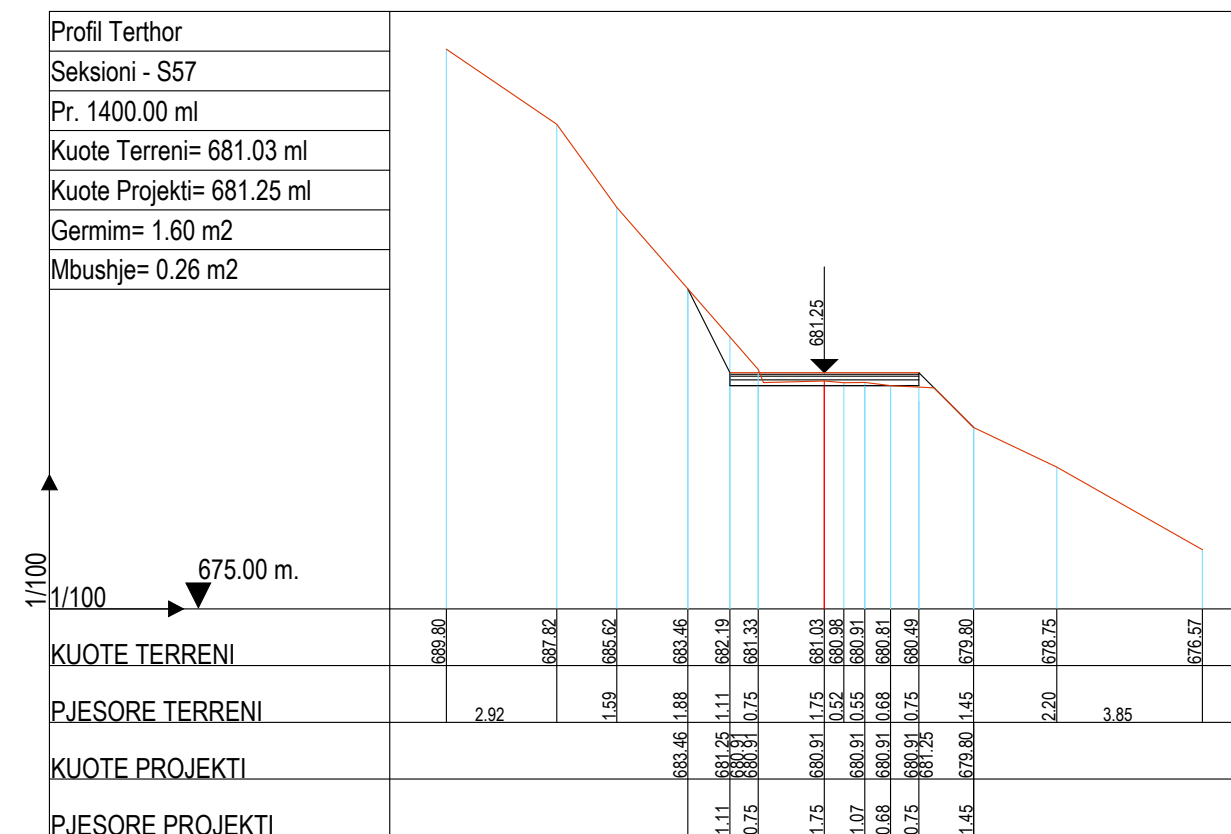
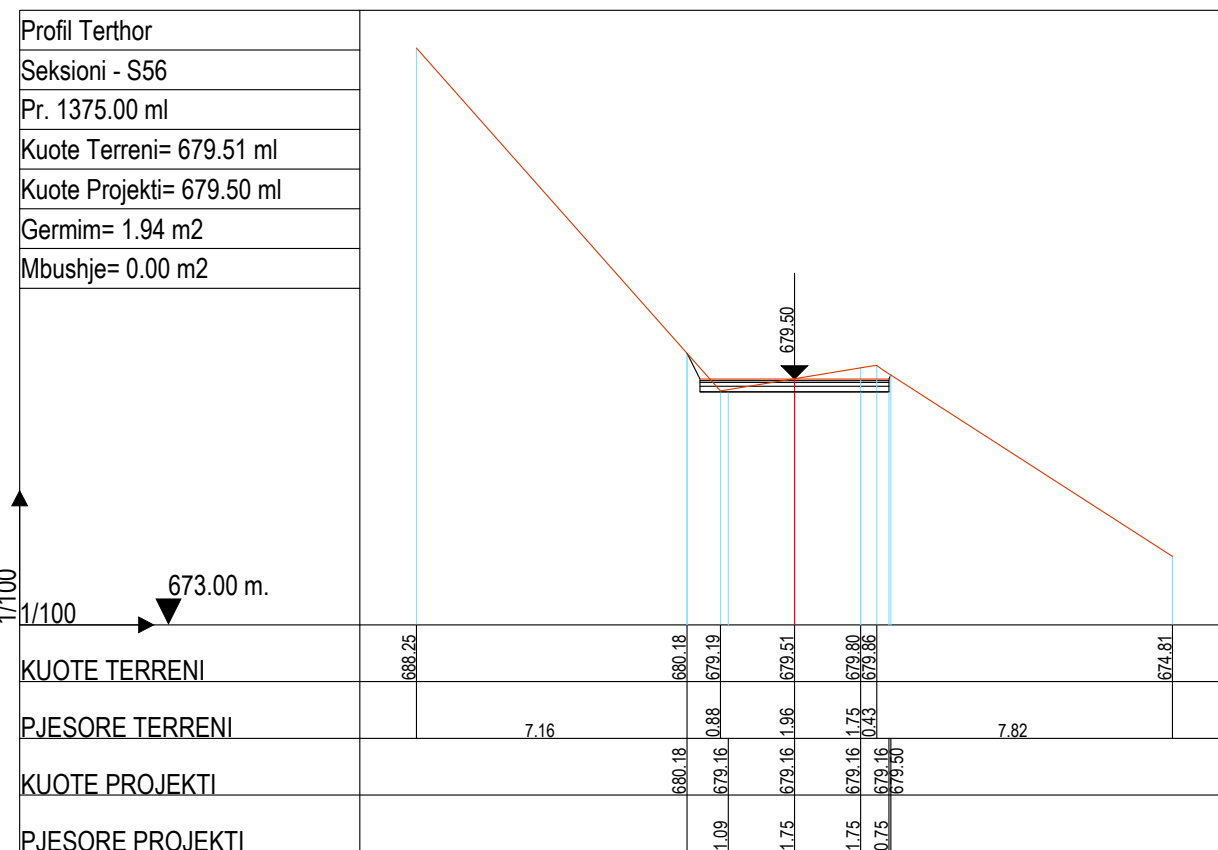
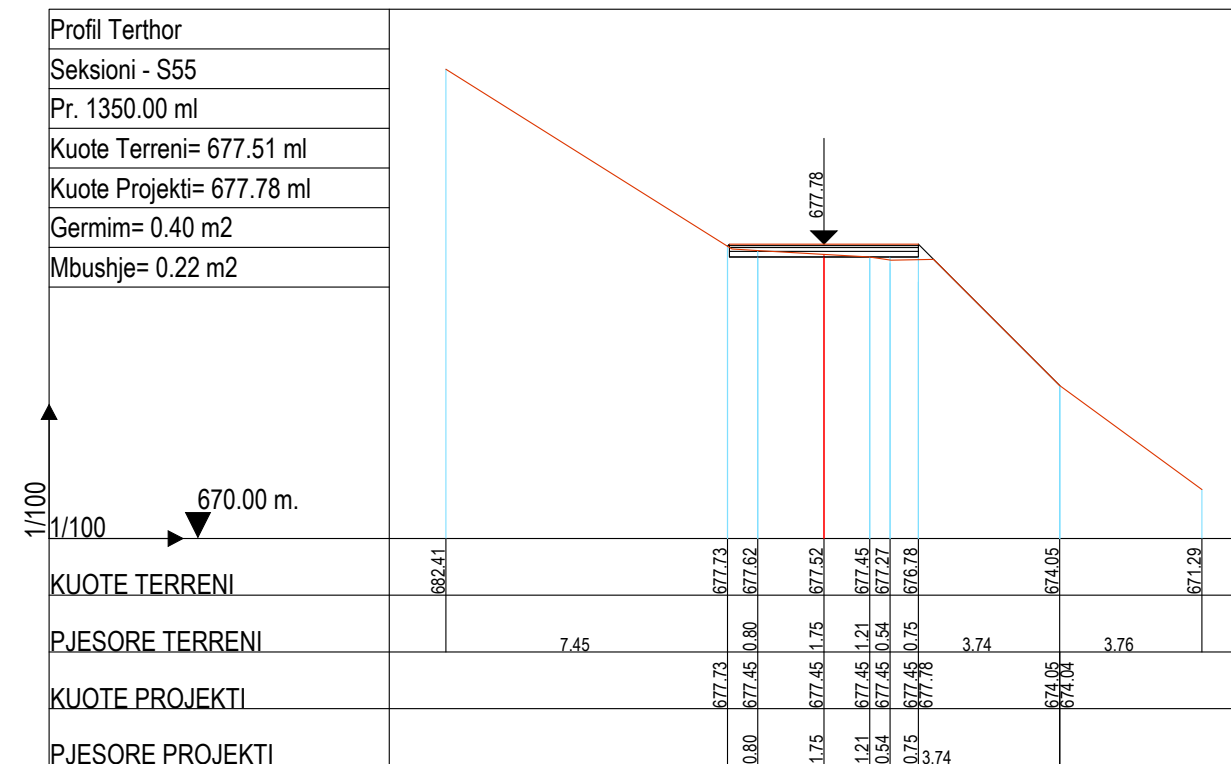
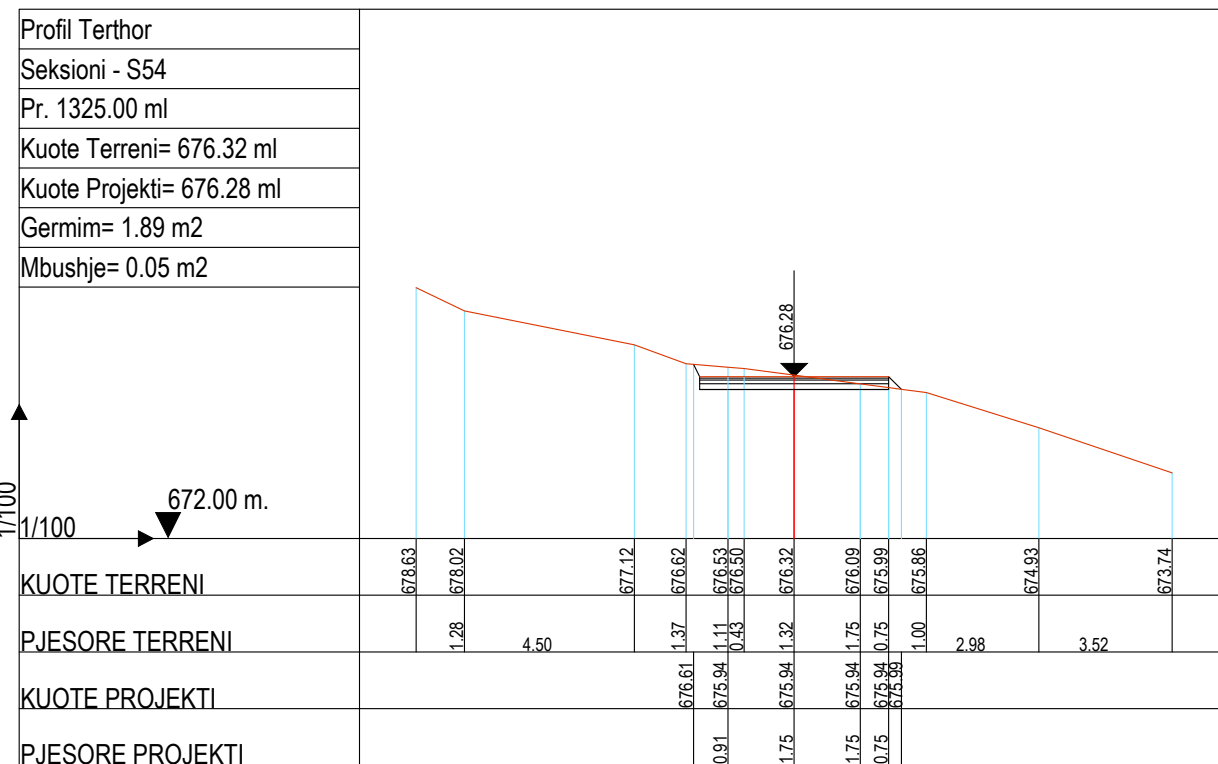

FOROSTESI:

BASHKIA BULQIZE

EMERTIMI I PROJEKTTIT :

**SISTEM-ASFALTIM I RRUGES BLLACE,
LOTI I, N.J.A. SHUPENZE,
BASHKIA BULQIZE**

FAZA E PROJEKTTIT :

PROJEKT ZBATIMI

EMERTIMI I FLETES :

PROFILAT TERTHORE

SHKALLA 1:200	NR. FLETES 14
------------------	------------------

GRUPI I PROJEKTIMIT : **"ALBGOLDING 2E" sh.p.k**

Ing. Hajredin MURGU

Ark. Soela MERKO

Ark. Erion MURGU



"ALBGOLDING 2E" sh.p.k

CONTACT:
E-MAIL : albgolding2@gmail.com
Cel: +355 68 52 07 550
+355 68 20 85 763

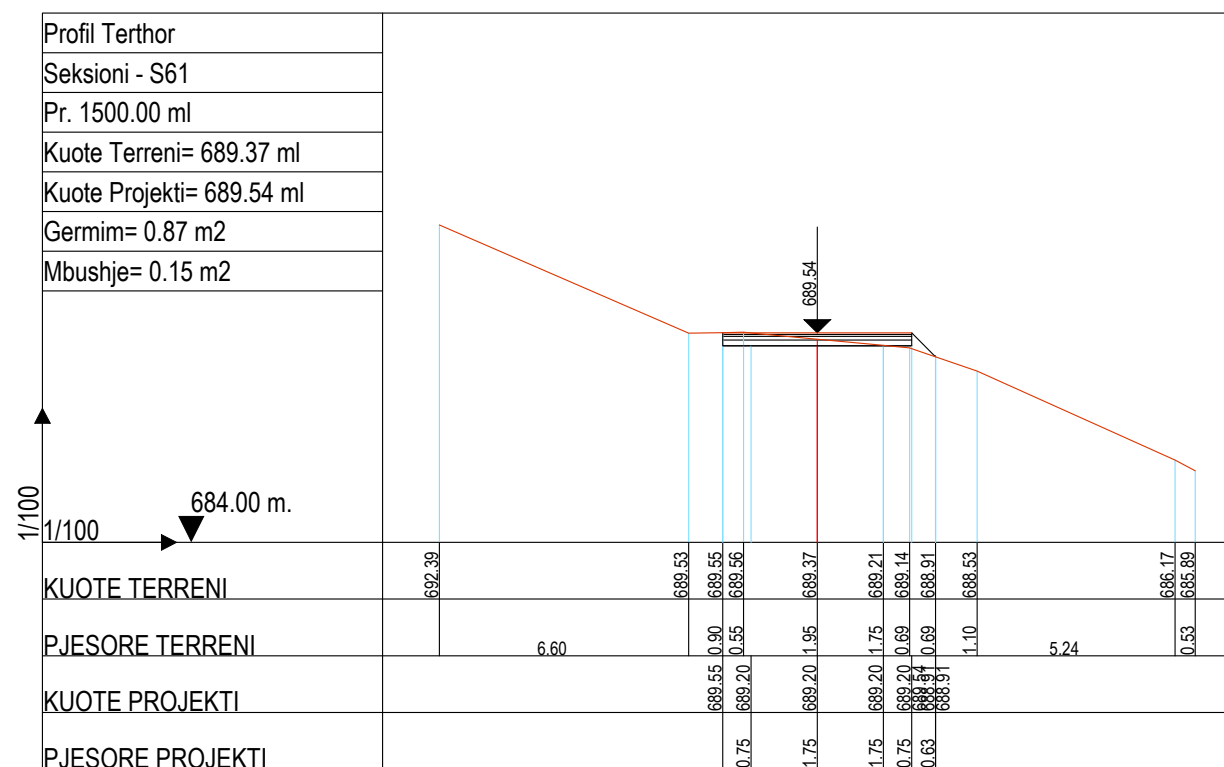
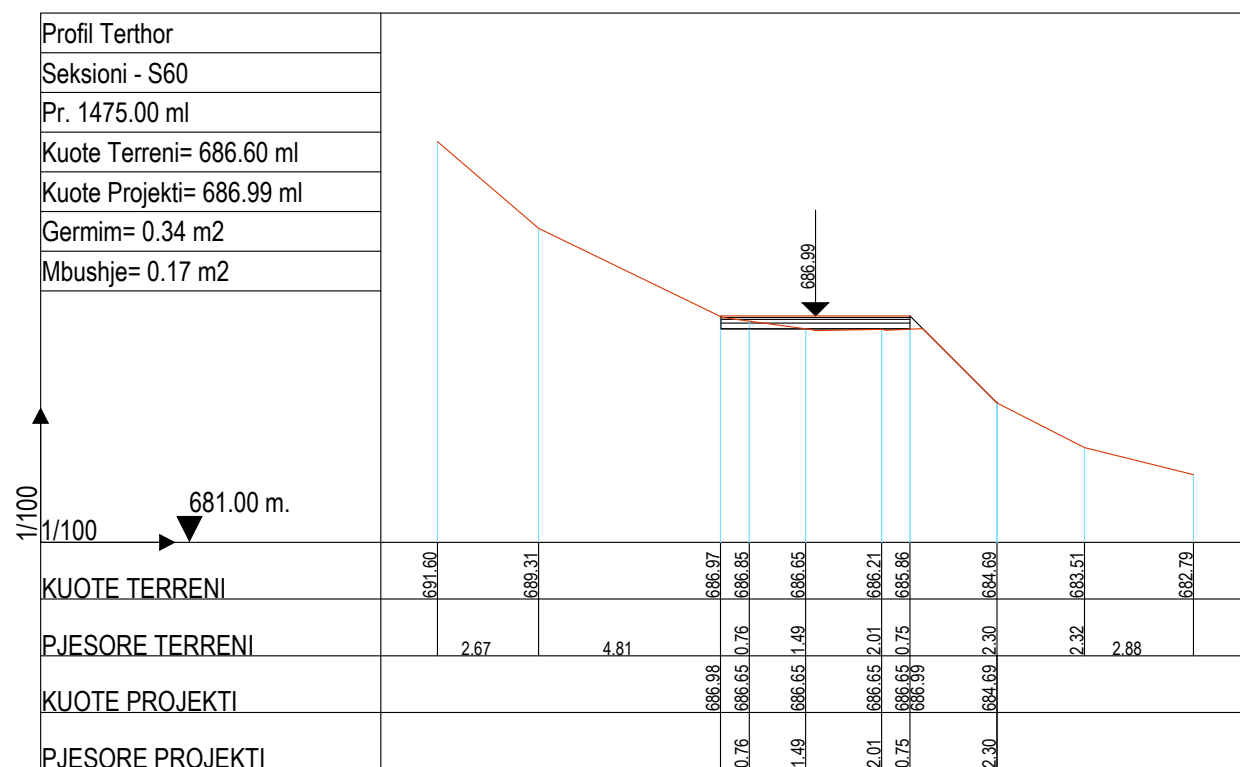
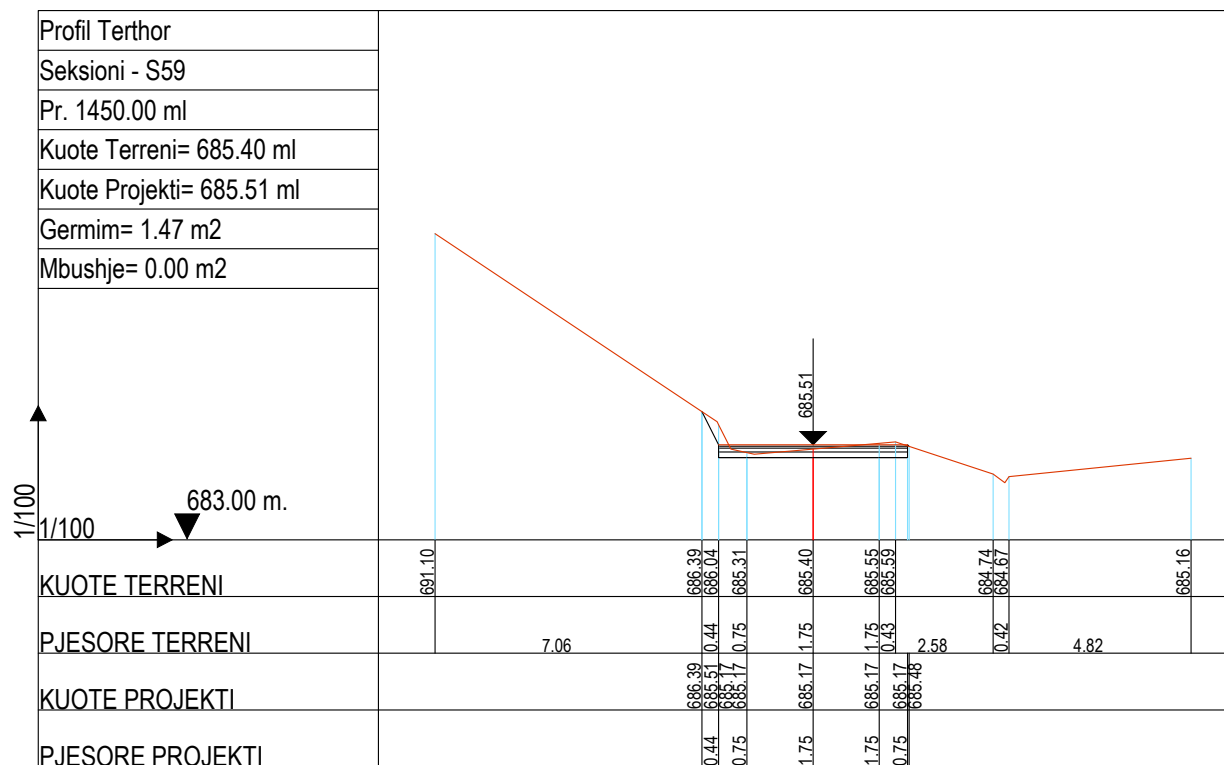
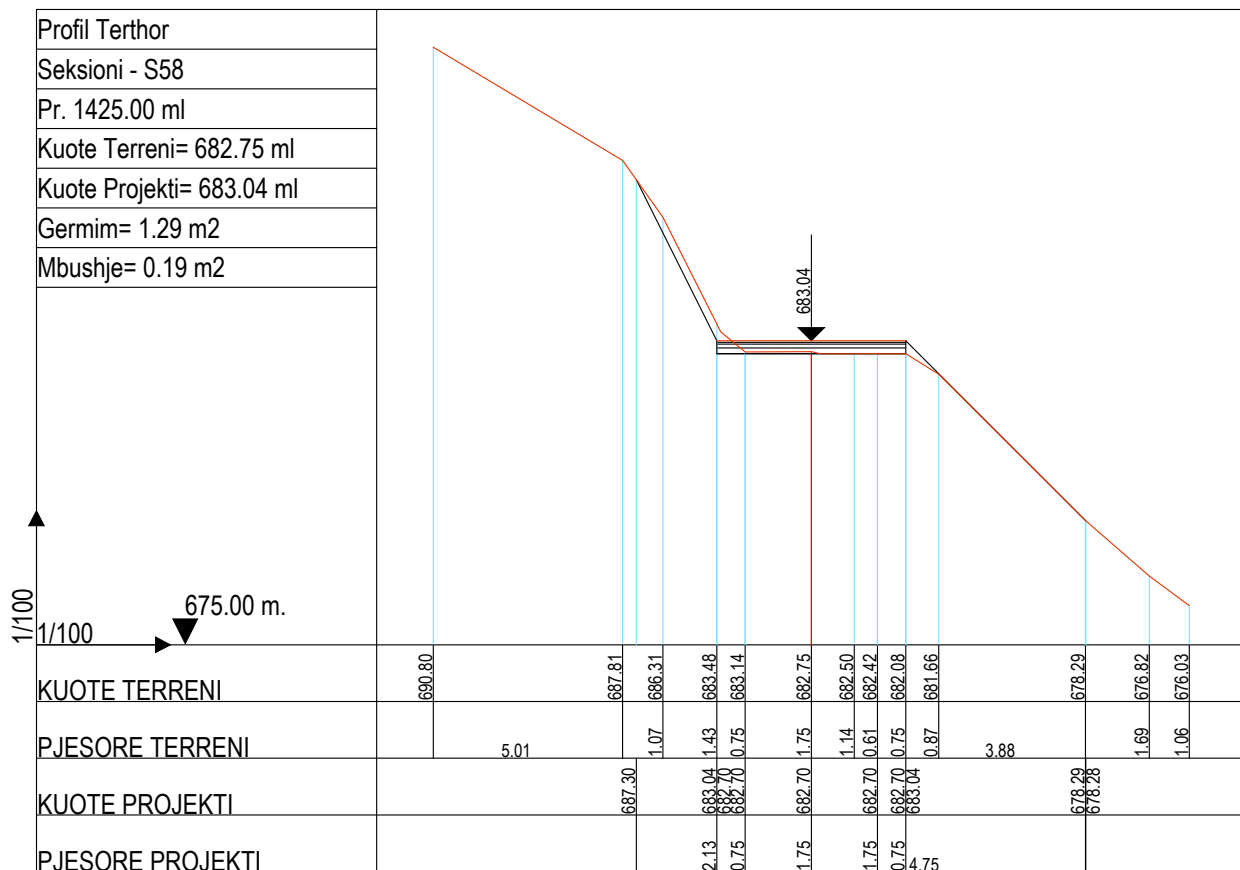

FOROSITESH:

BASHKIA BULQIZE

EMERTIMI I PROJEKTTIT :

**SISTEM-ASFALTIM I RRUGES BLLACE,
LOTI I, NJ.A. SHUPENZE,
BASHKIA BULQIZE**

FAZA E PROJEKTTIT :

PROJEKT ZBATIMI

EMERTIMI I FLETES :

PROFILAT TERTHORE

SHKALLA 1:200	NR. FLETES 15
------------------	------------------

GRUPI I PROJEKTIMIT : **"ALBGOLDING 2E" sh.p.k**

Ing. Hajredin MURGU

Ark. Soela MERKO

Ark. Erion MURGU



"ALBGOLDING 2E" sh.p.k

CONTACT:
E-MAIL : albgolding2e@gmail.com
Cel: +355 68 52 07 550
+355 68 20 85 763

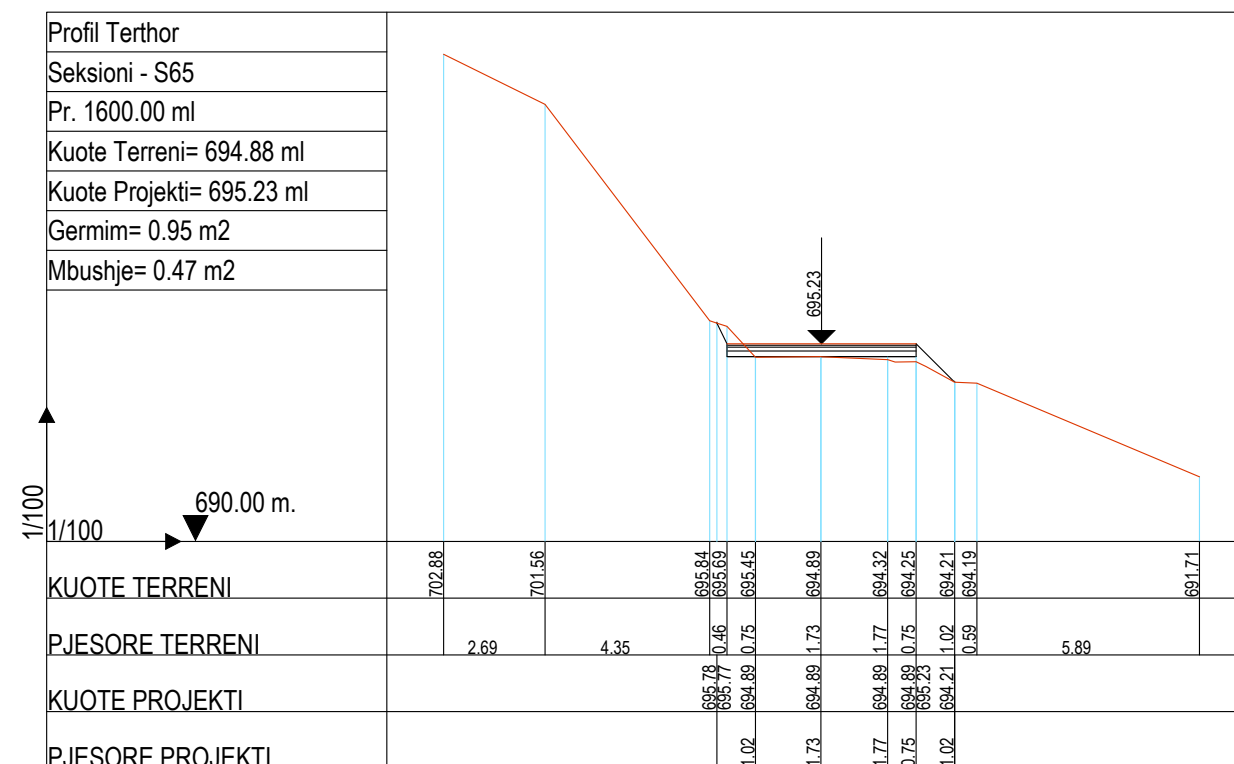
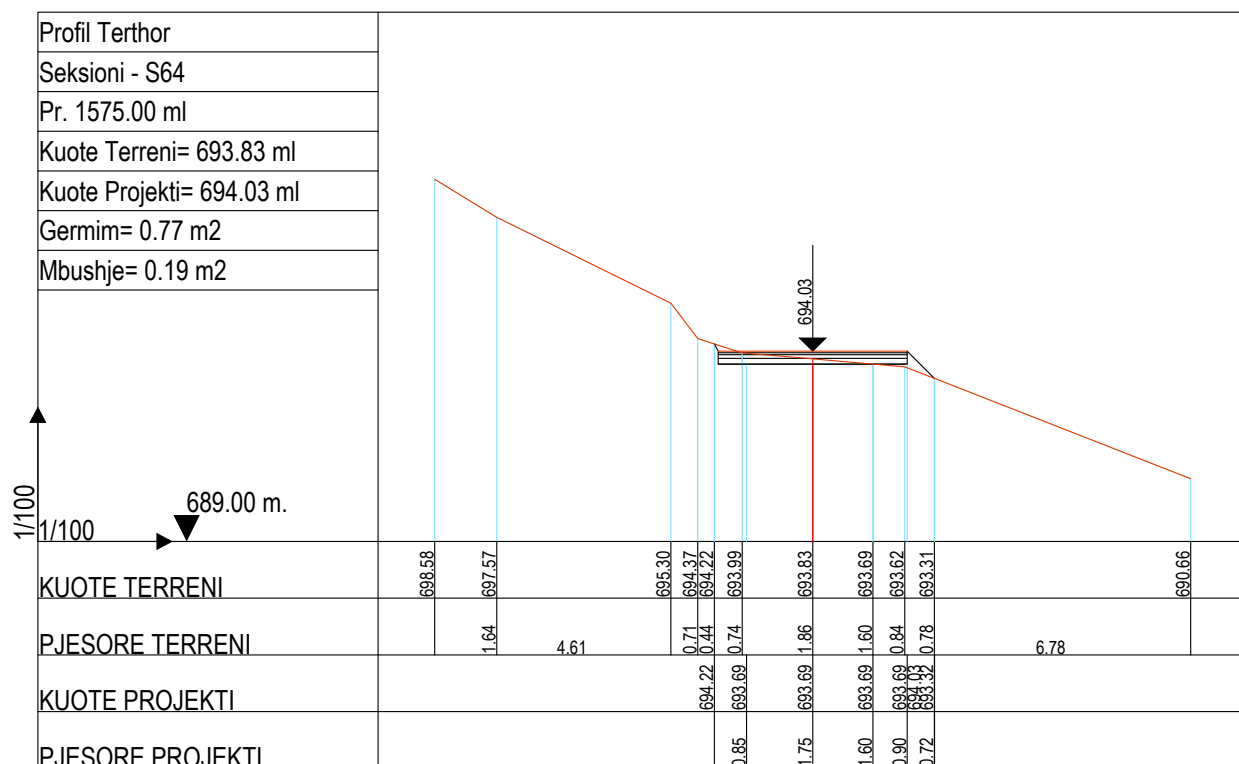
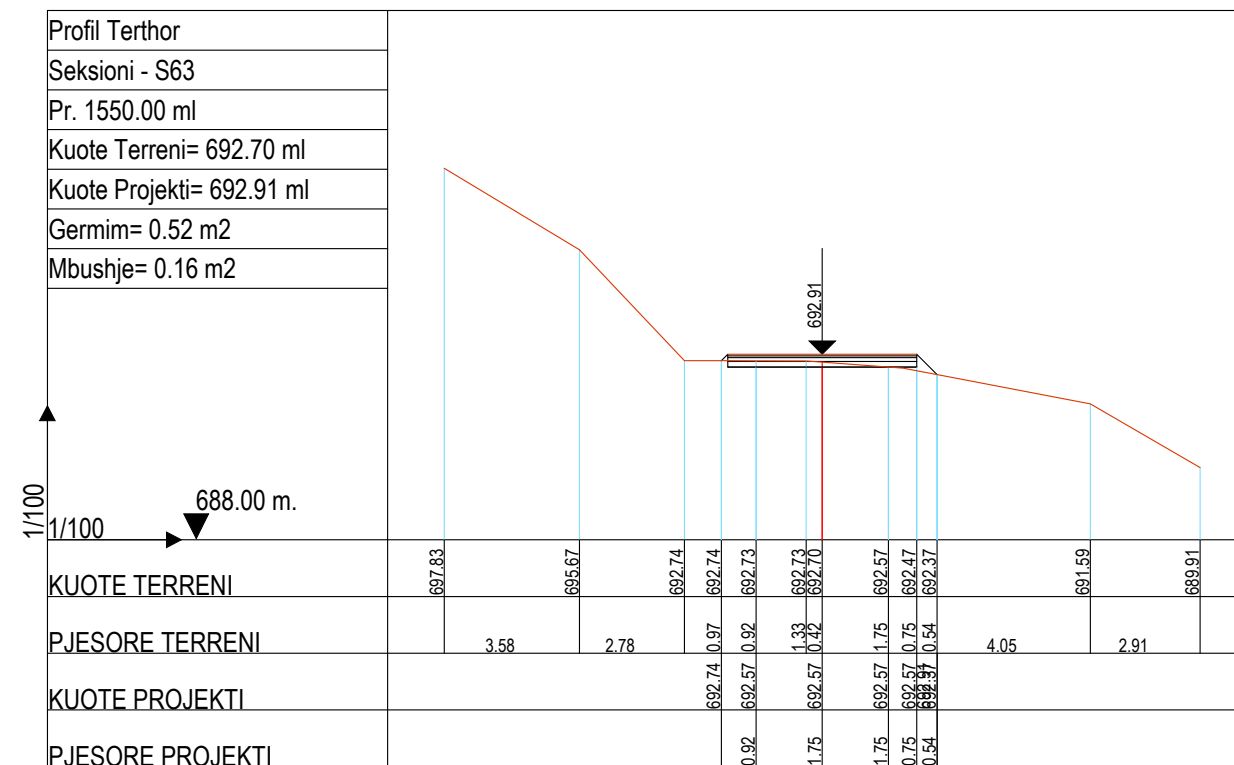
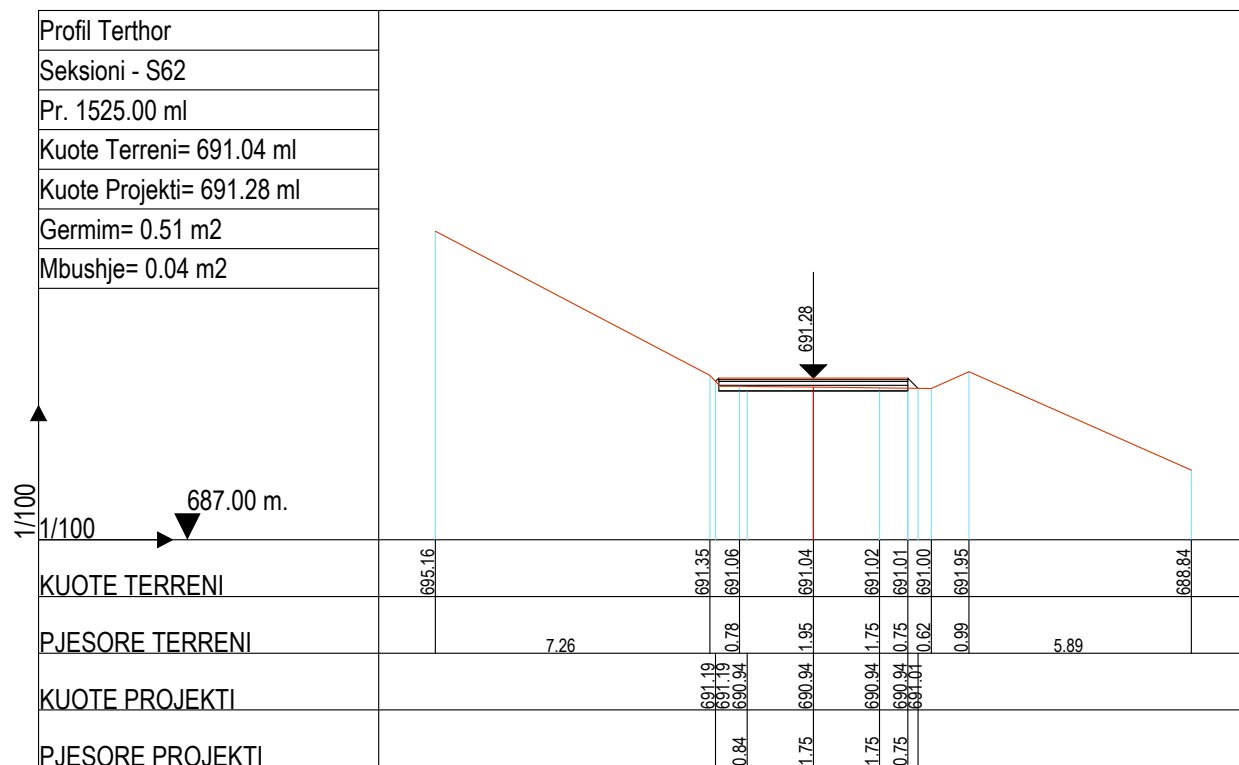

FOROSHTESI:

BASHKIA BULQIZE

EMERTIMI I PROJEKTTIT :

**SISTEM-ASFALTIM I RRUGES BLLACE,
LOTI I, N.J.A. SHUPENZE,
BASHKIA BULQIZE**

FAZA E PROJEKTTIT :

PROJEKT ZBATIMI

EMERTIMI I FLETES :

PROFILAT TERTHORE

SHKALLA 1:200	NR. FLETES 16
------------------	------------------

GRUPI I PROJEKTTIMIT : **"ALBGOLDING 2E" sh.p.k**

Ing. Hajredin MURGU

Ark. Soela MERKO

Ark. Erion MURGU



"ALBGOLDING 2E" sh.p.k

CONTACT:
E-MAIL : albgolding2@gmail.com
Cel: +355 68 52 07 550
+355 68 20 85 763

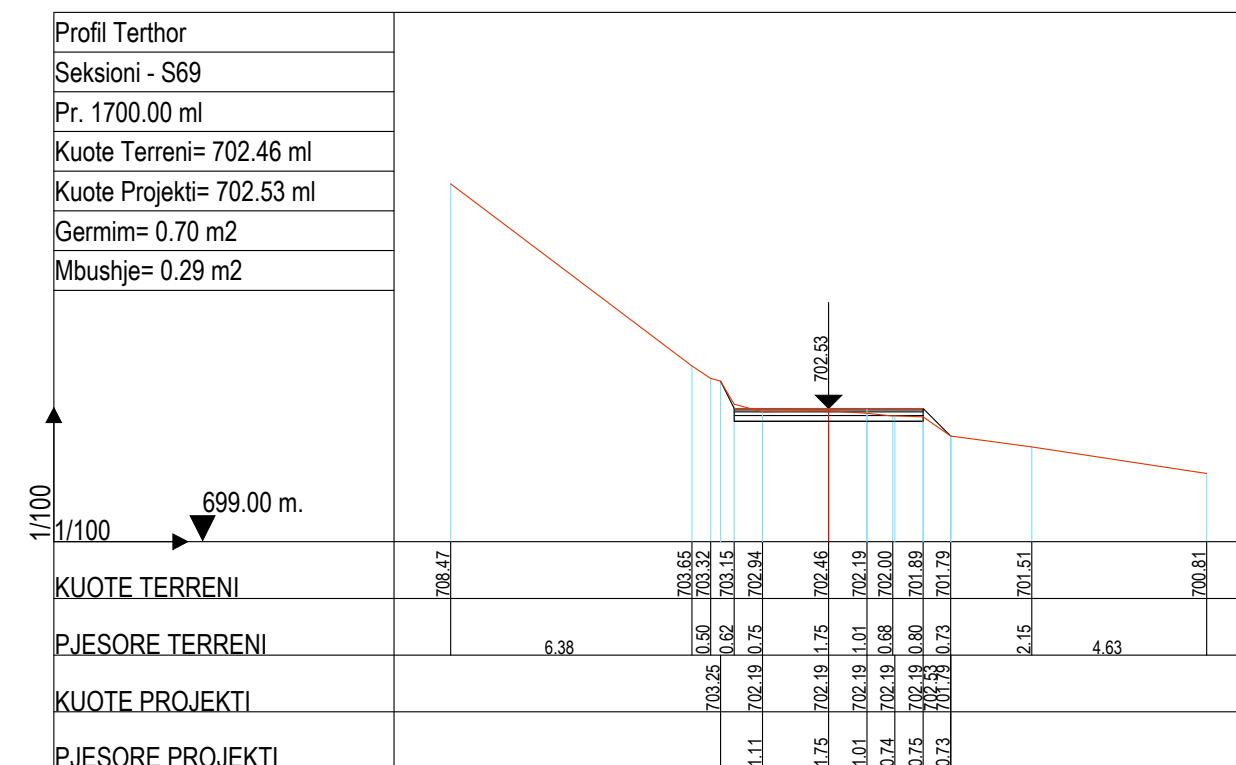
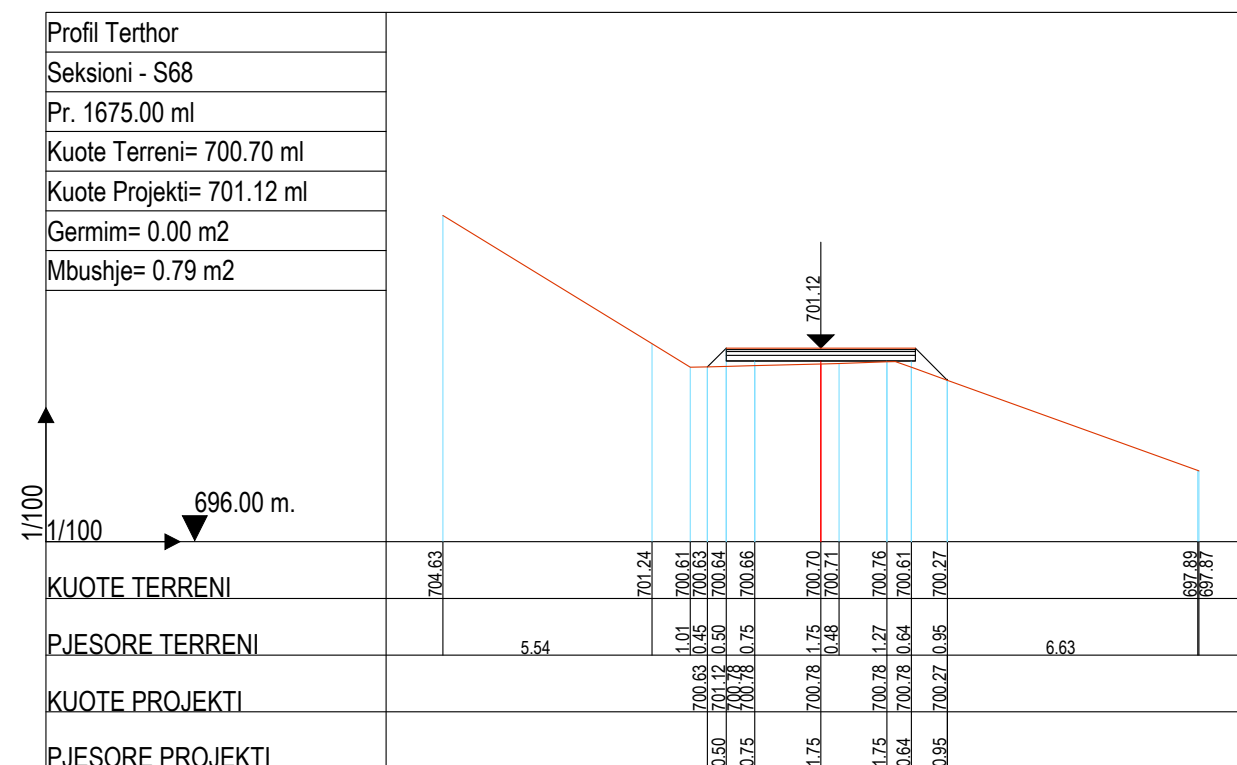
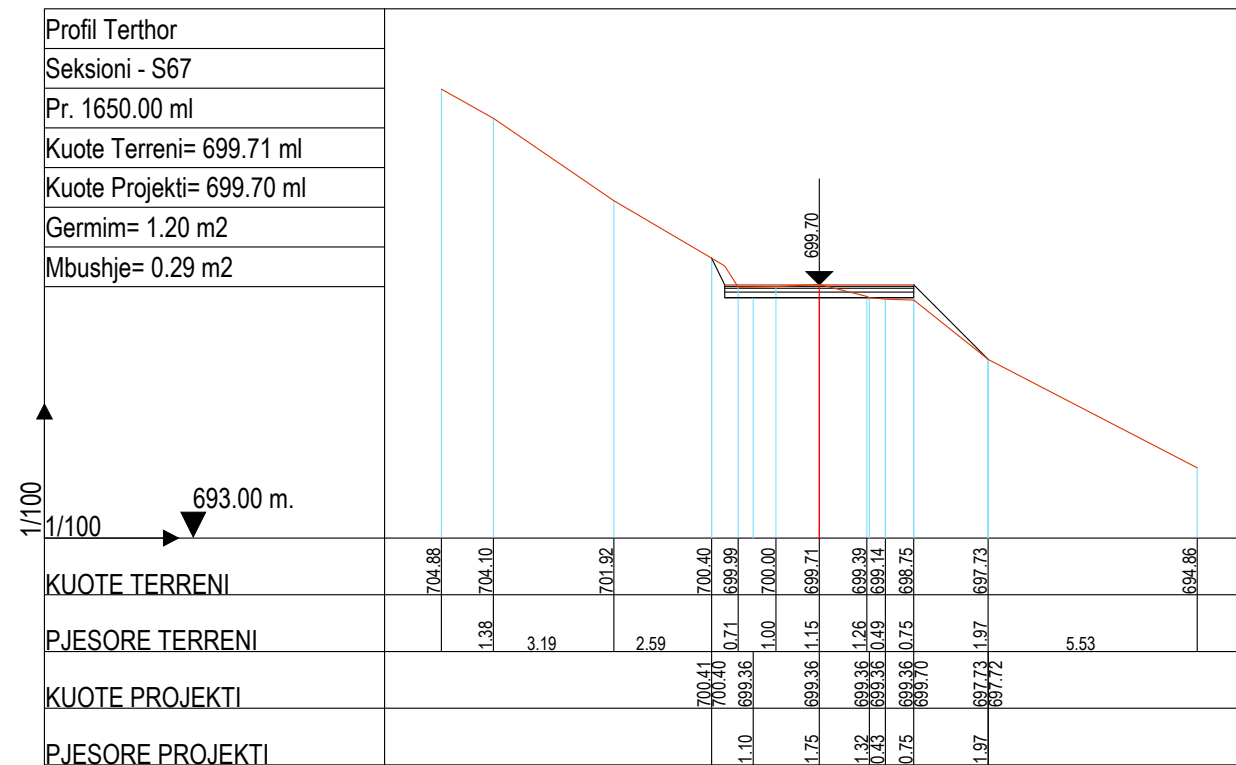
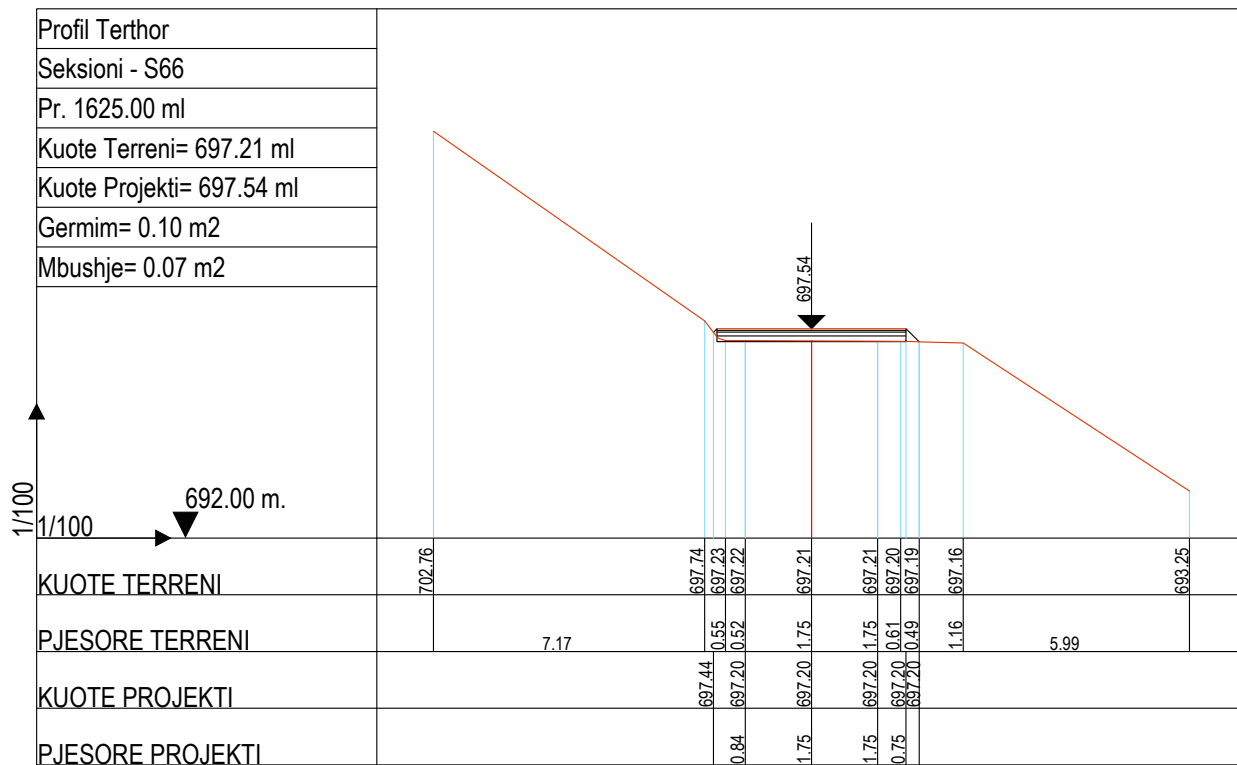

BASHKIA BULQIZE

EMERTIMI I PROJEKTTIT :
**SISTEM-ASFALTIM I RRUGES BLLACE,
LOTI I, N.J.A. SHUPENZE,
BASHKIA BULQIZE**

FAZA E PROJEKTTIT :
PROJEKT ZBATIMI

EMERTIMI I FLETES :
PROFILAT TERTHORE

SHKALLA 1:200	NR. FLETES 17
------------------	------------------

GRUPI I PROJEKTTIMIT : **"ALBGOLDING 2E" sh.p.k**

Ing. Hajredin MURGU
Ark. Soela MERKO
Ark. Erion MURGU

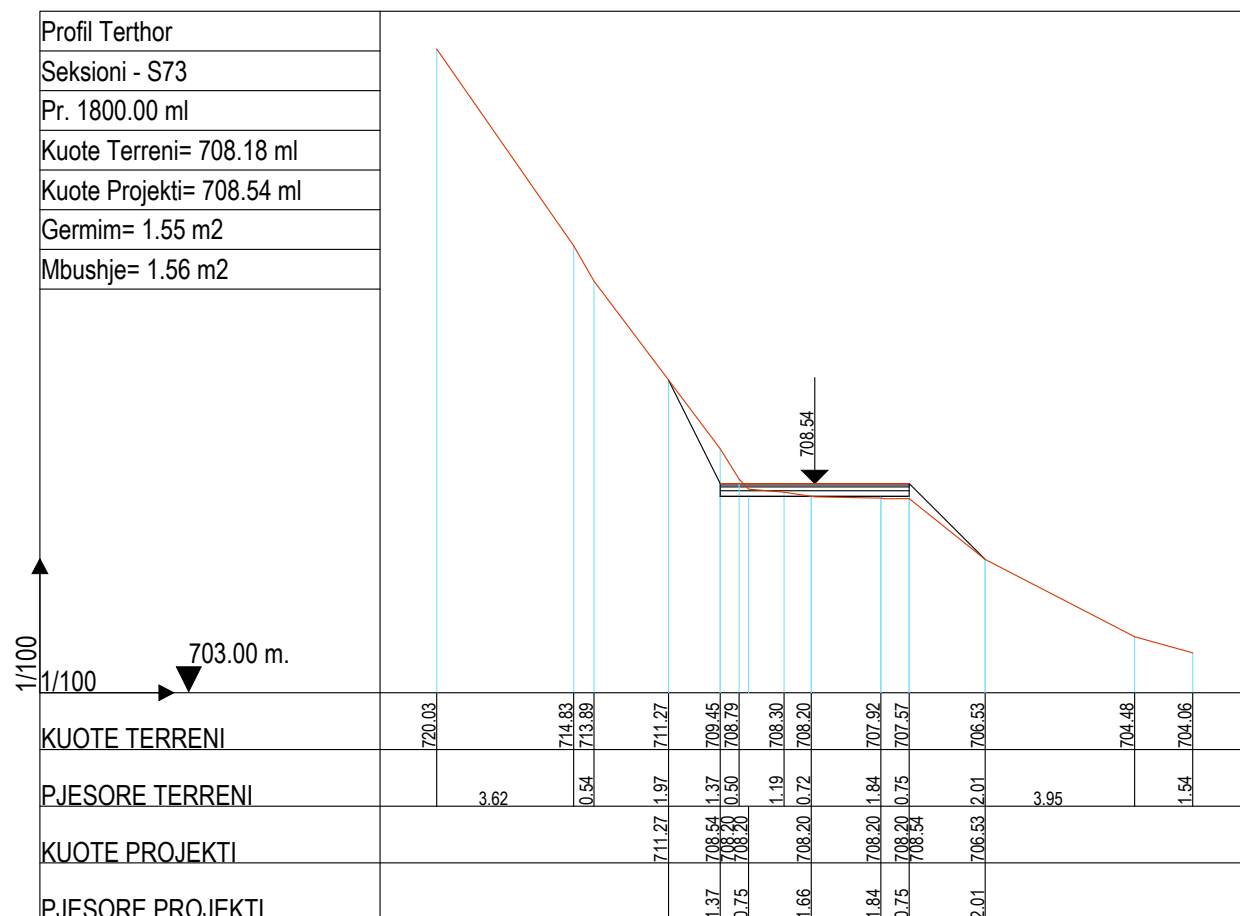
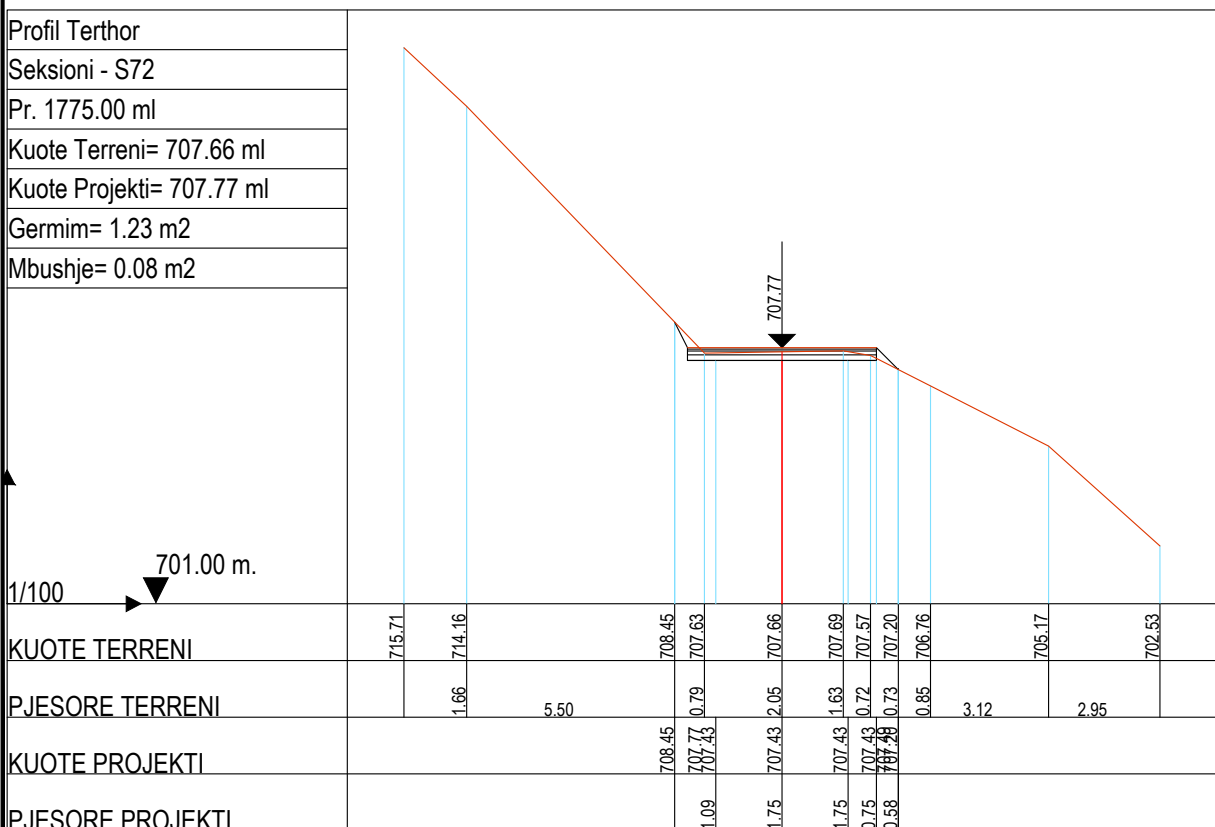
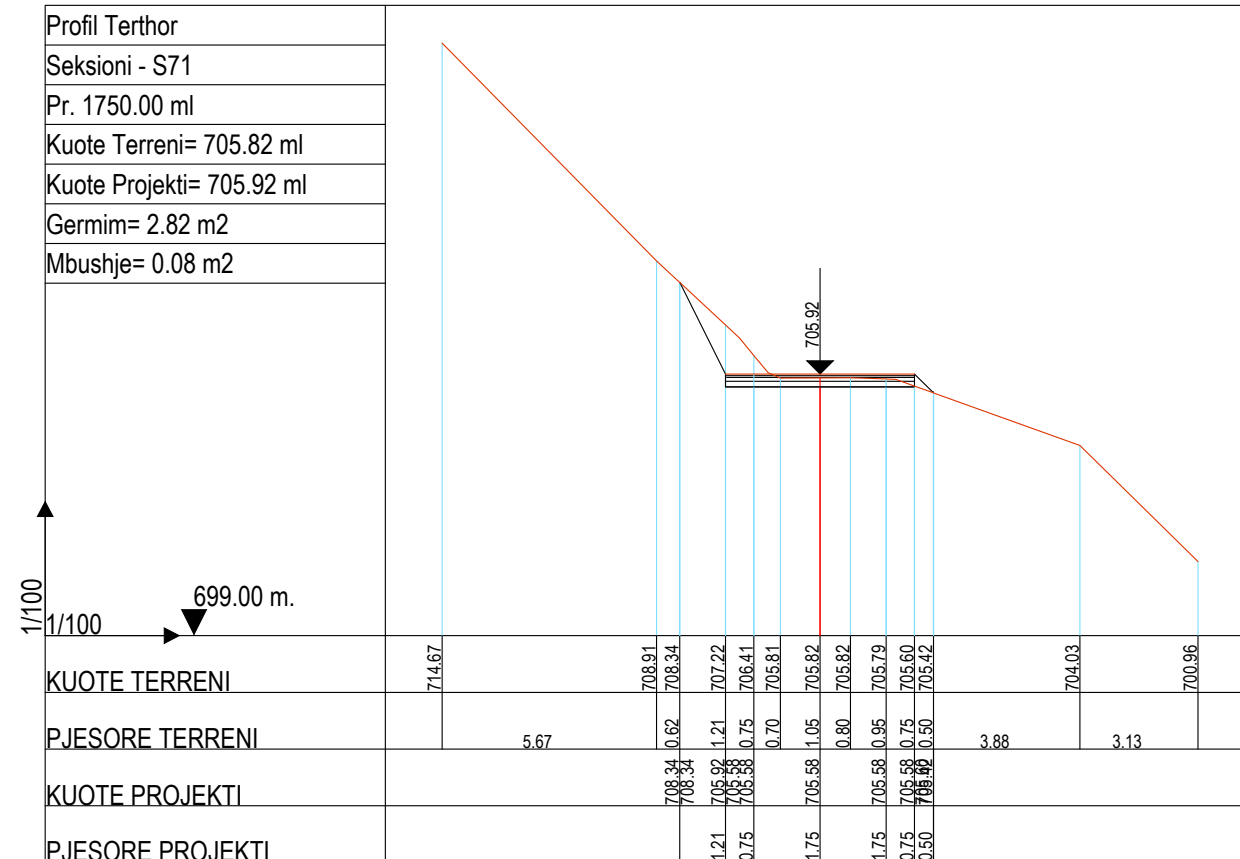
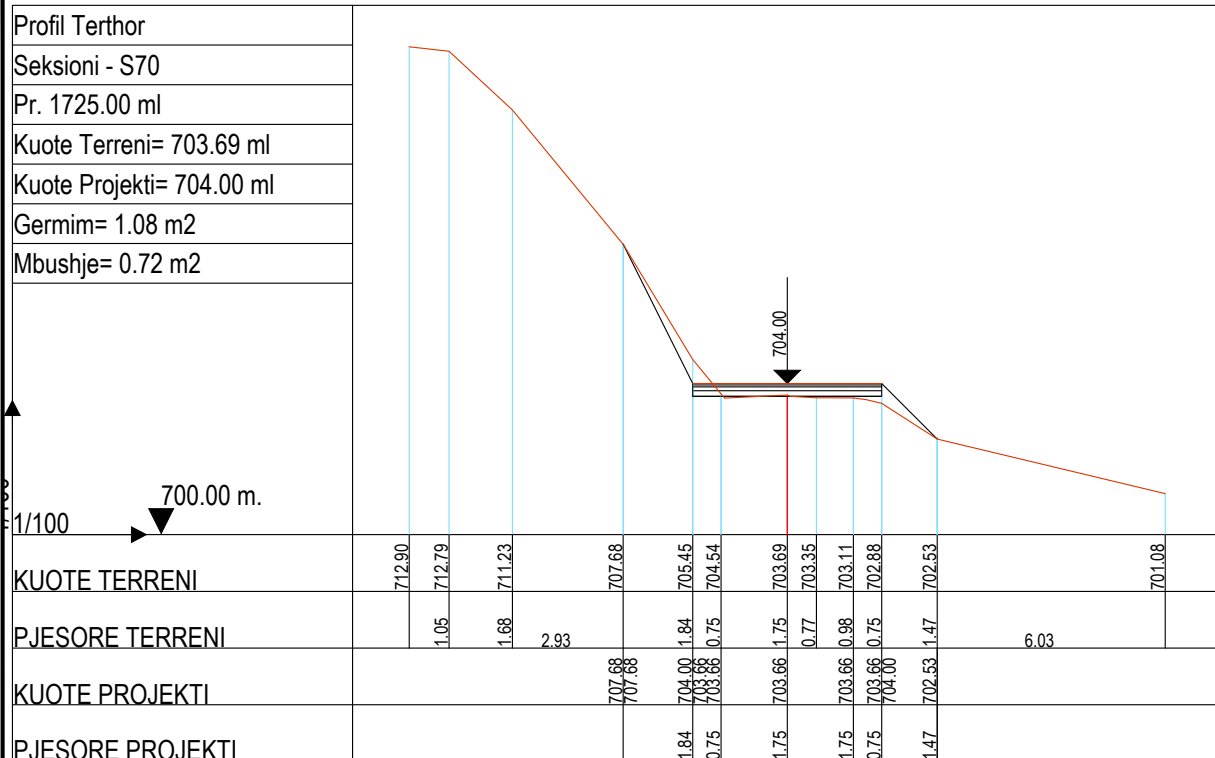

FOROSHTESI:

BASHKIA BULQIZE

EMERTIMI I PROJEKTTIT :

**SISTEM-ASFALTIM I RRUGES BLLACE,
LOTI I, N.J.A. SHUPENZE,
BASHKIA BULQIZE**

FAZA E PROJEKTTIT :

PROJEKT ZBATIMI

EMERTIMI I FLETES :

PROFILAT TERTHORE

SHKALLA 1:200	NR. FLETES 18
------------------	------------------

GRUPI I PROJEKTTIMIT : **"ALBGOLDING 2E" sh.p.k**

Ing. Hajredin MURGU

Ark. Soela MERKO

Ark. Erion MURGU



"ALBGOLDING 2E" sh.p.k

CONTACT:
E-MAIL : albgolding2@gmail.com
Cel: +355 68 52 07 550
+355 68 20 85 763

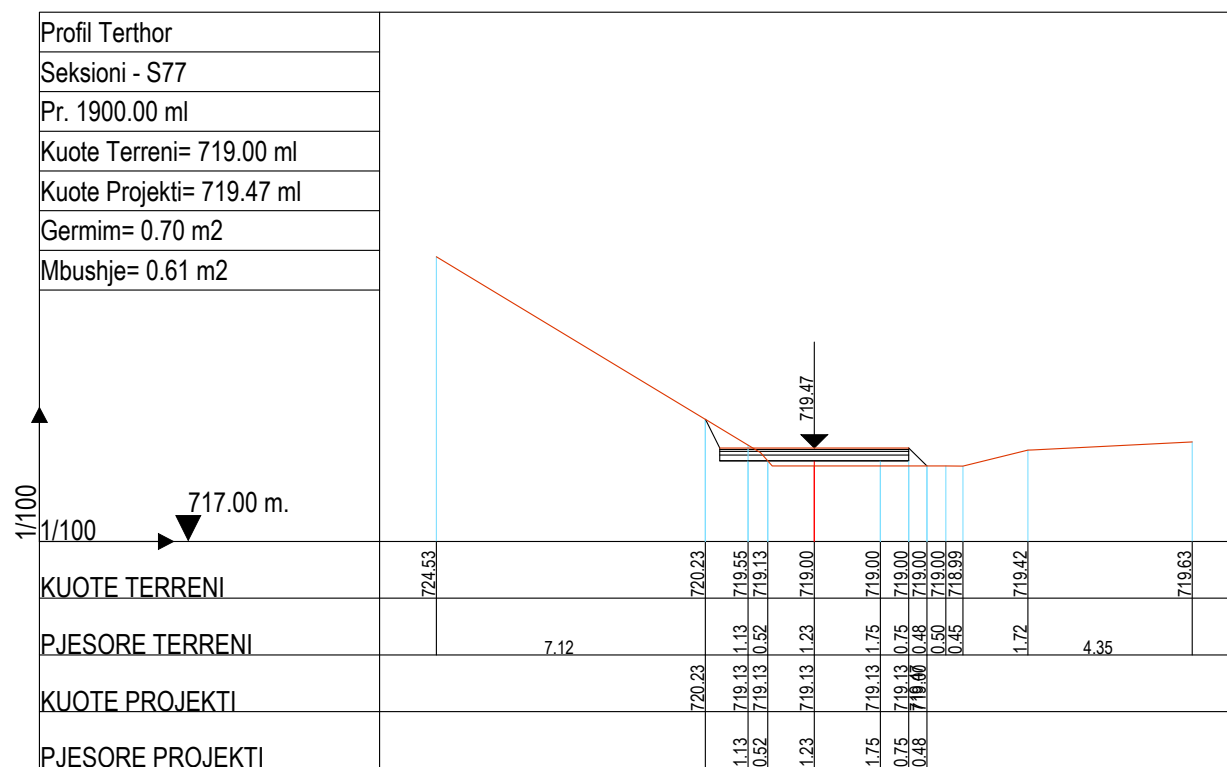
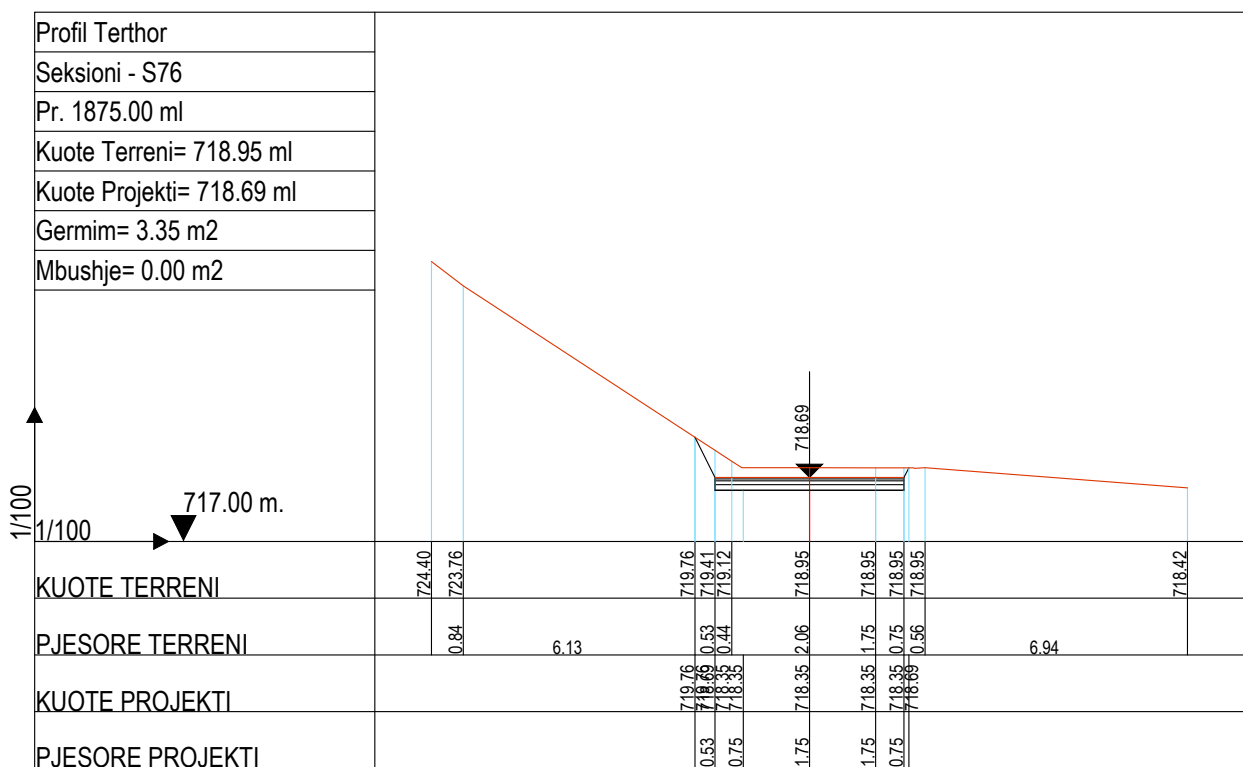
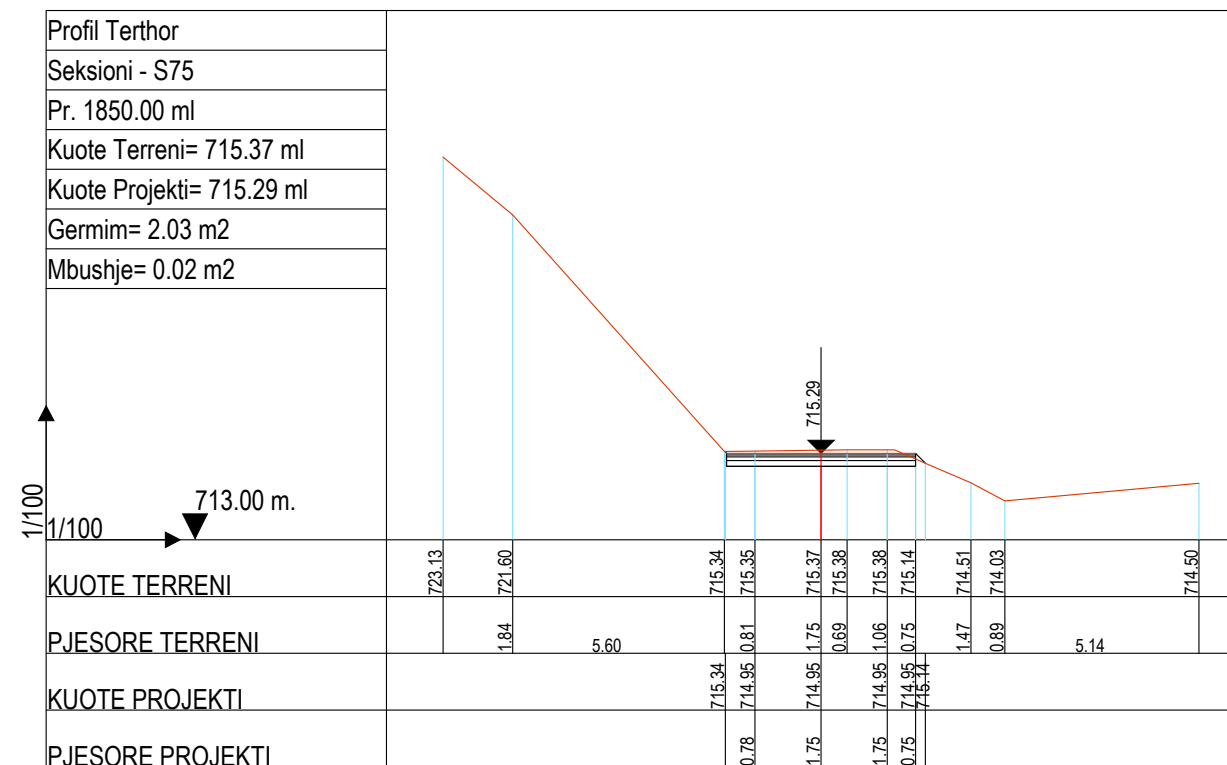
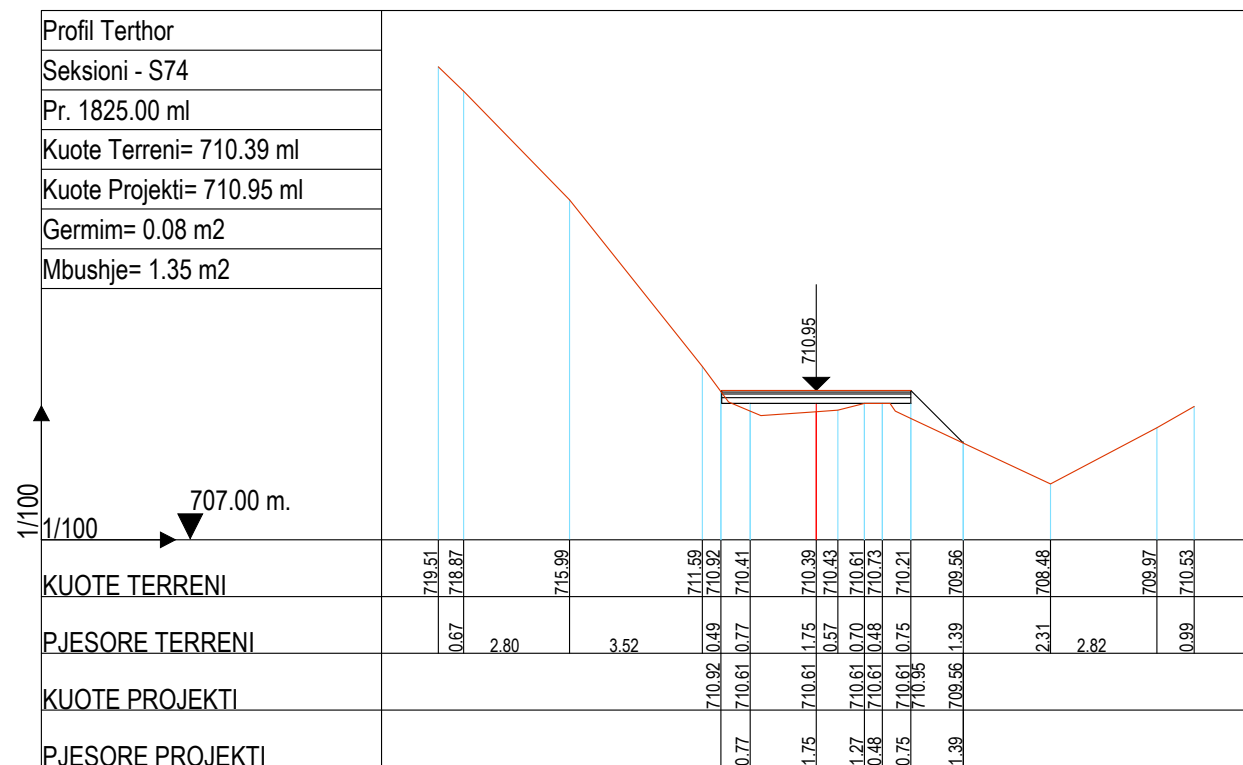

FOROSITESH:

BASHKIA BULQIZE

EMERTIMI I PROJEKTTIT :

**SISTEM-ASFALTIM I RRUGES BLLACE,
LOTI I, N.J.A. SHUPENZE,
BASHKIA BULQIZE**

FAZA E PROJEKTTIT :

PROJEKT ZBATIMI

EMERTIMI I FLETES :

PROFILAT TERTHORE

SHKALLA 1:200	NR. FLETES 19
------------------	------------------

GRUPI I PROJEKTIMIT : **"ALBGOLDING 2E" sh.p.k**

Ing. Hajredin MURGU

Ark. Soela MERKO

Ark. Erion MURGU



"ALBGOLDING 2E" sh.p.k

CONTACT:
E-MAIL : albgolding2@gmail.com
Cel: +355 68 52 07 550
+355 68 20 85 763

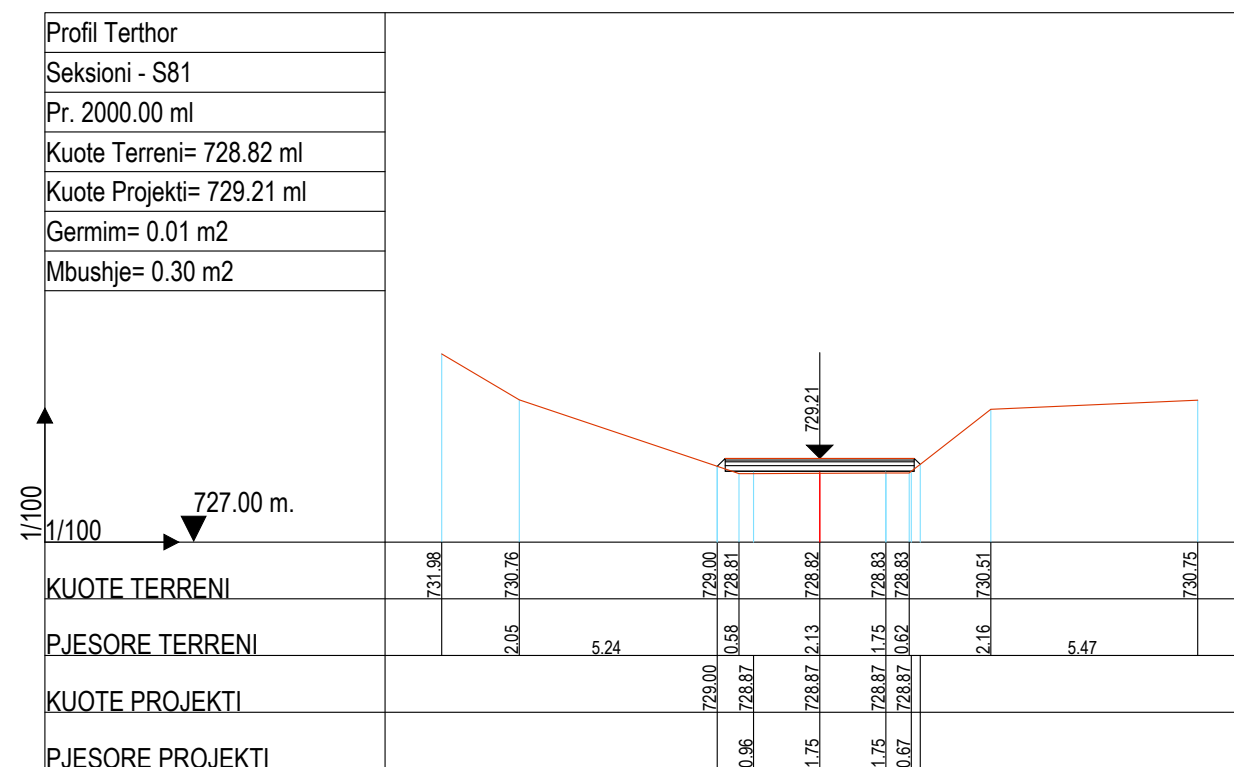
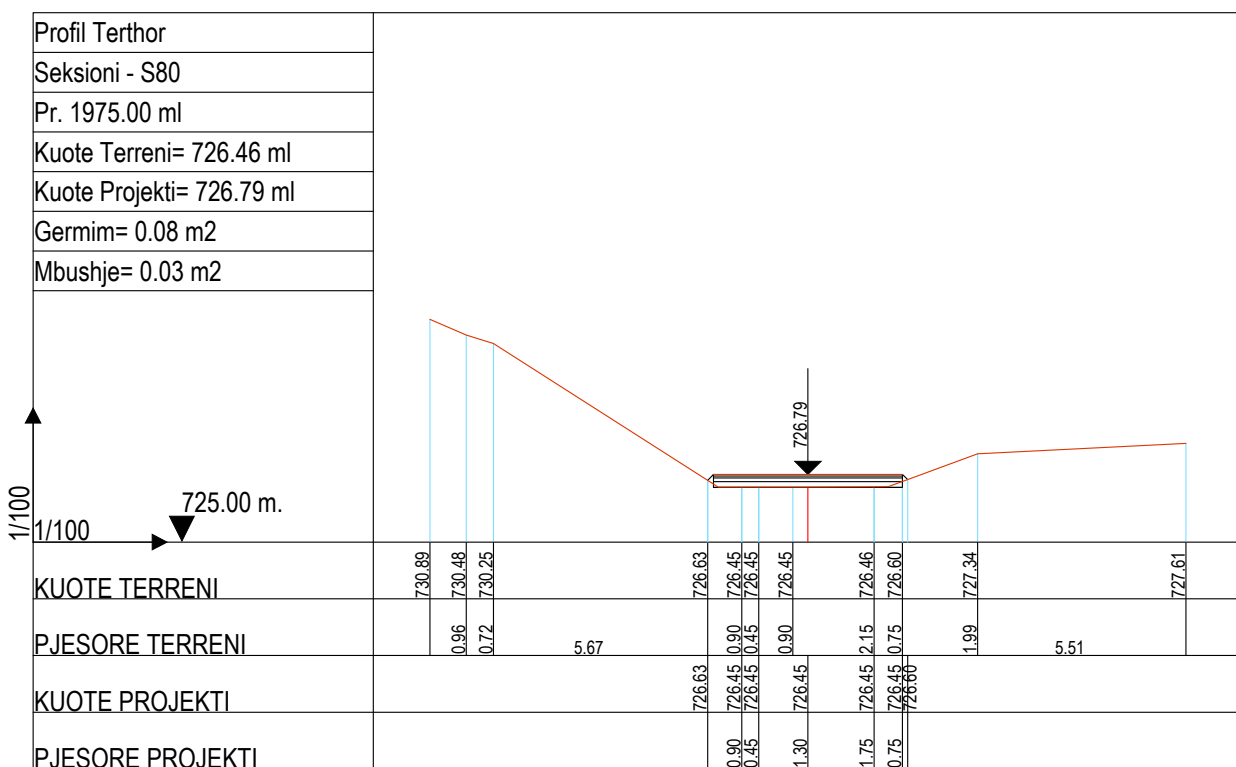
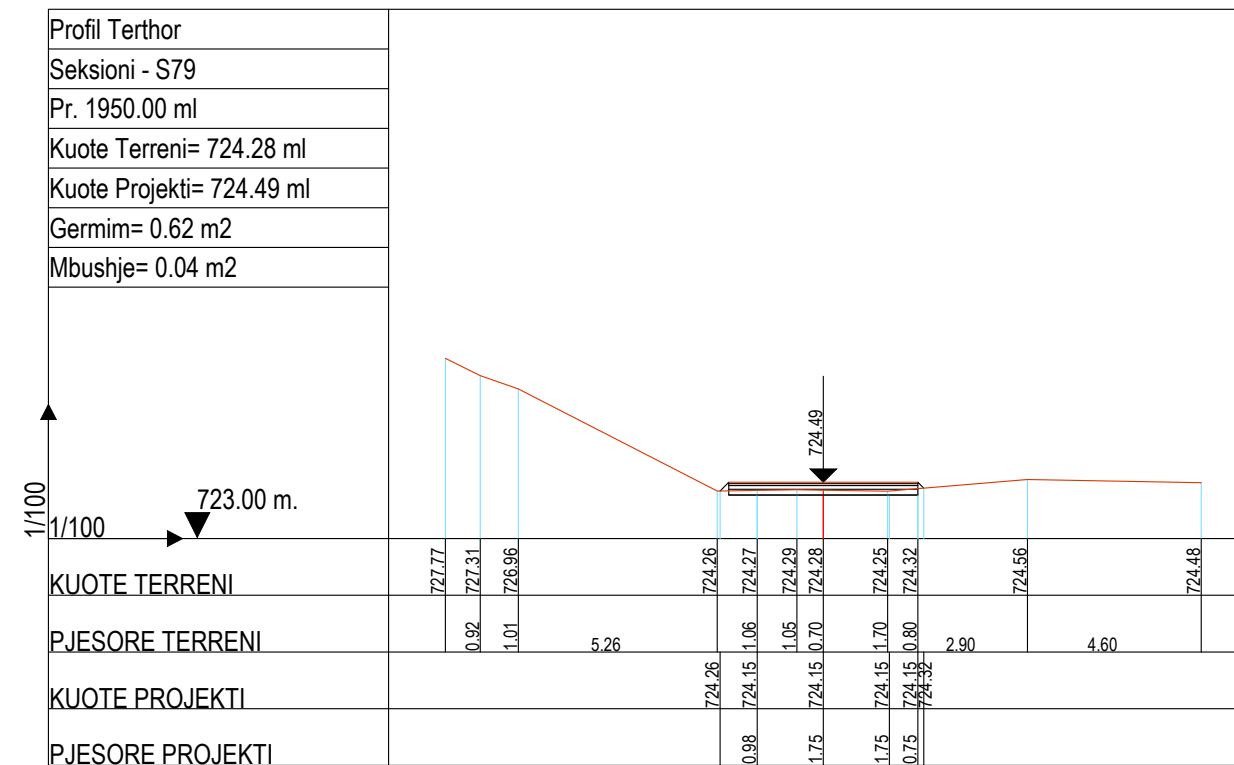
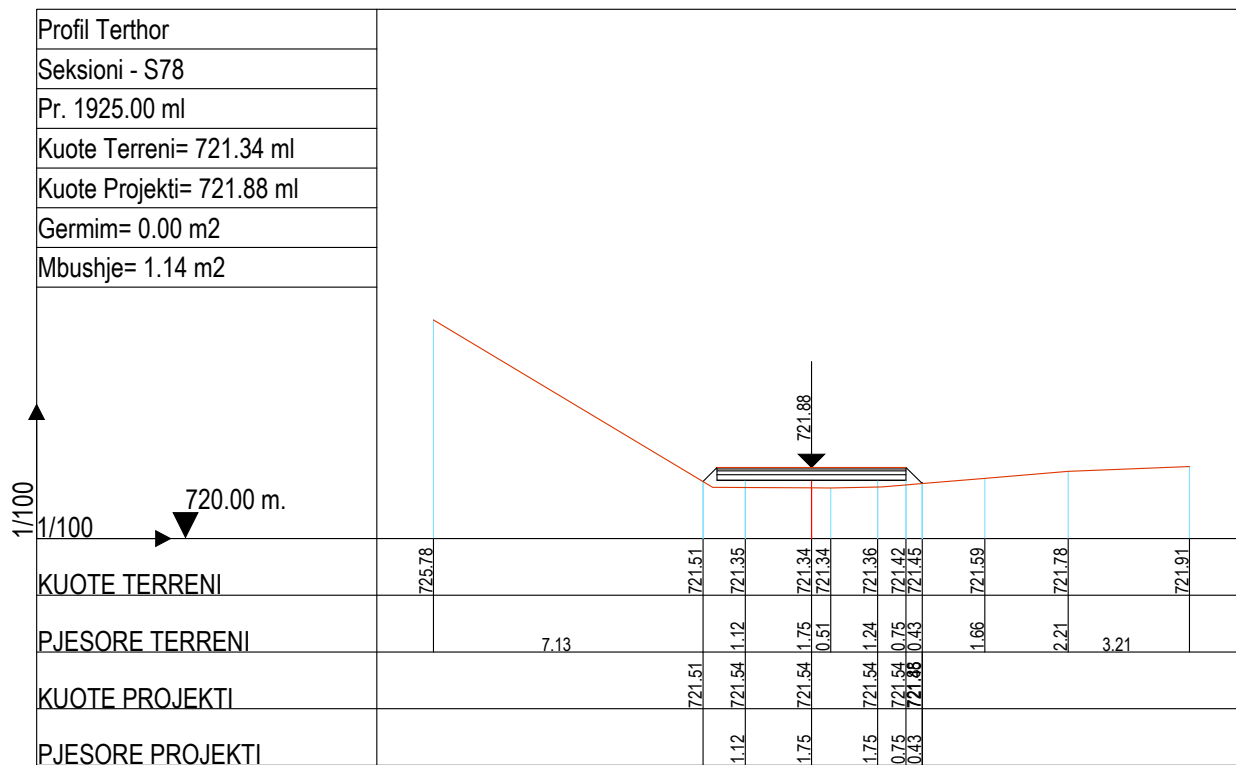

FOROSTESI:

BASHKIA BULQIZE

EMERTIMI I PROJEKTTIT :

**SISTEM-ASFALTIM I RRUGES BLLACE,
LOTI I, N.J.A. SHUPENZE,
BASHKIA BULQIZE**

FAZA E PROJEKTTIT :

PROJEKT ZBATIMI

EMERTIMI I FLETES :

PROFILAT TERTHORE

SHKALLA 1:200	NR. FLETES 20
------------------	------------------

GRUPI I PROJEKTIMIT : **"ALBGOLDING 2E" sh.p.k**

Ing. Hajredin MURGU

Ark. Soela MERKO

Ark. Erion MURGU



"ALBGOLDING 2E" sh.p.k

CONTACT:
E-MAIL : albgolding2@gmail.com
Cel: +355 68 52 07 550
+355 68 20 85 763

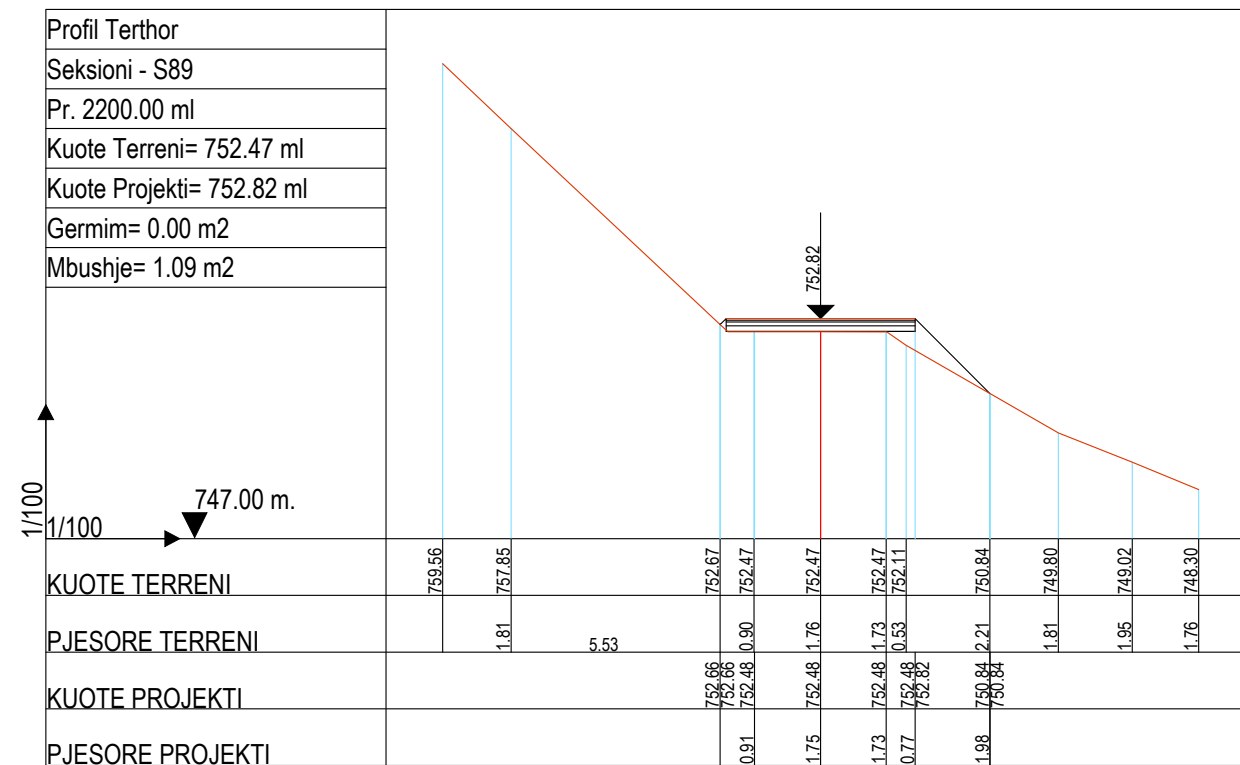
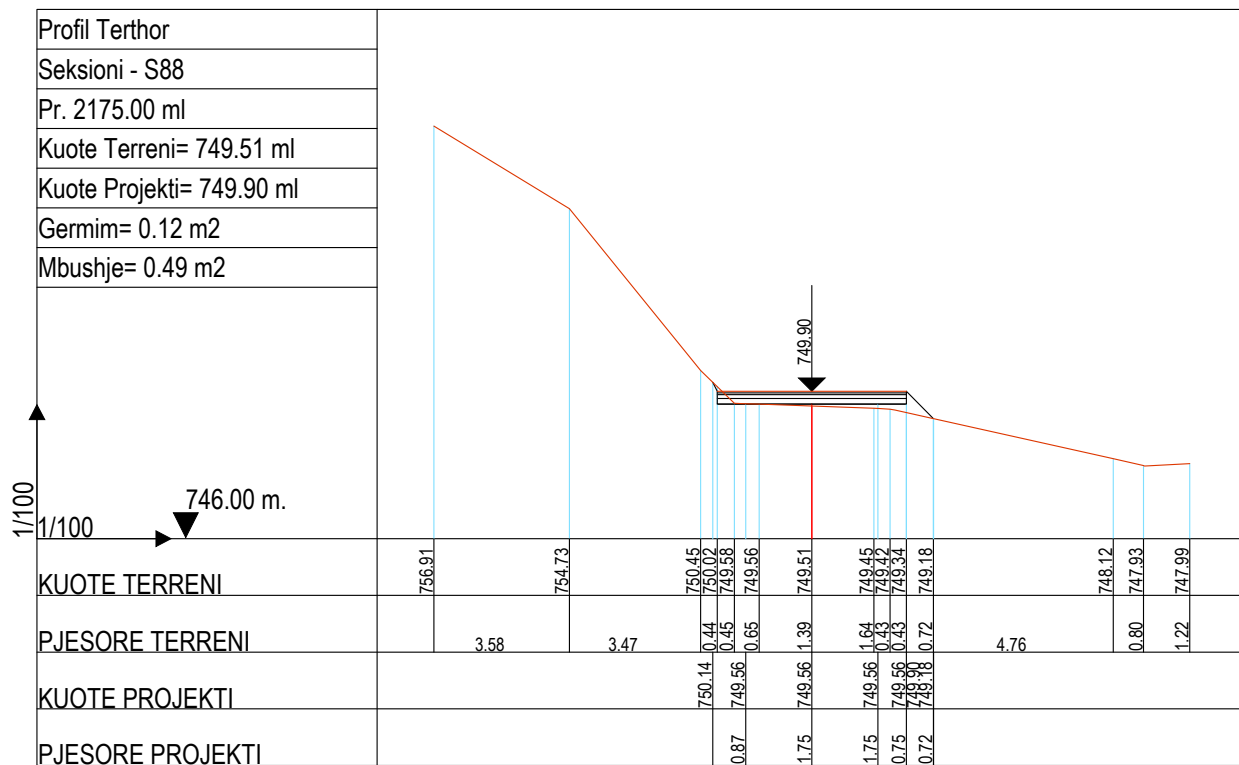
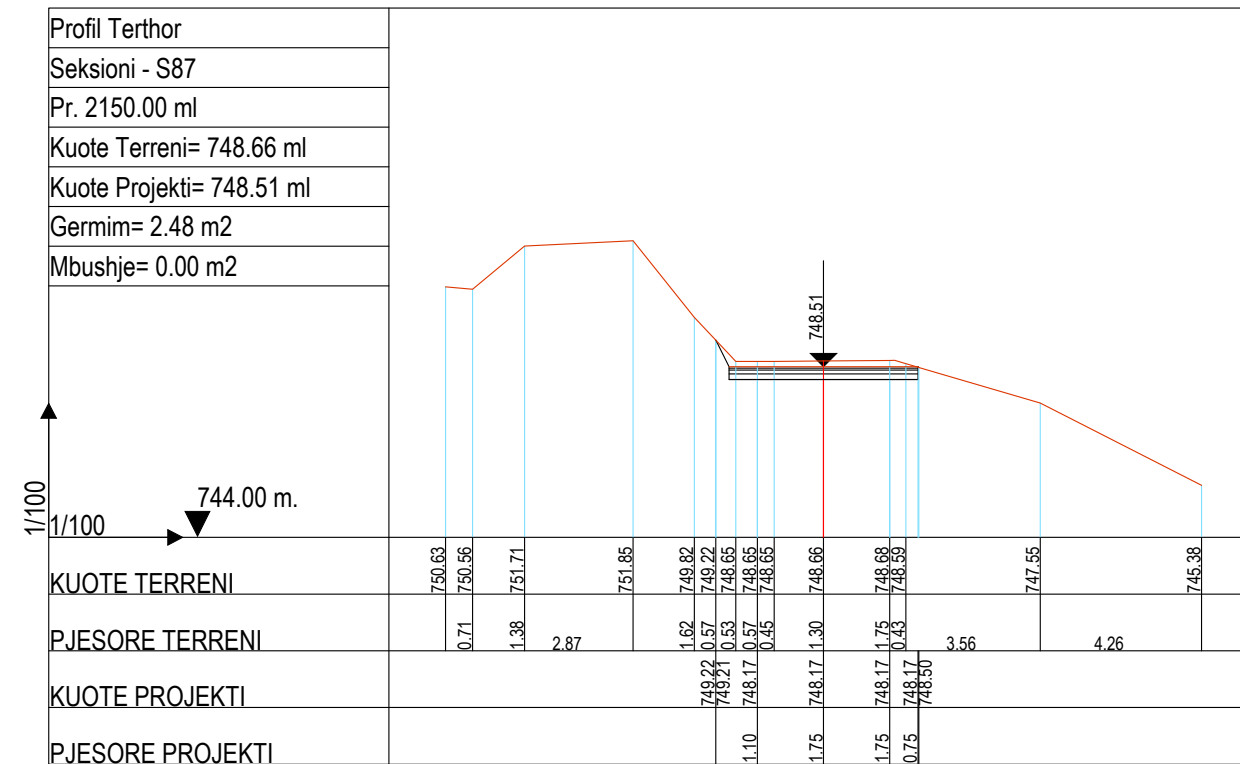
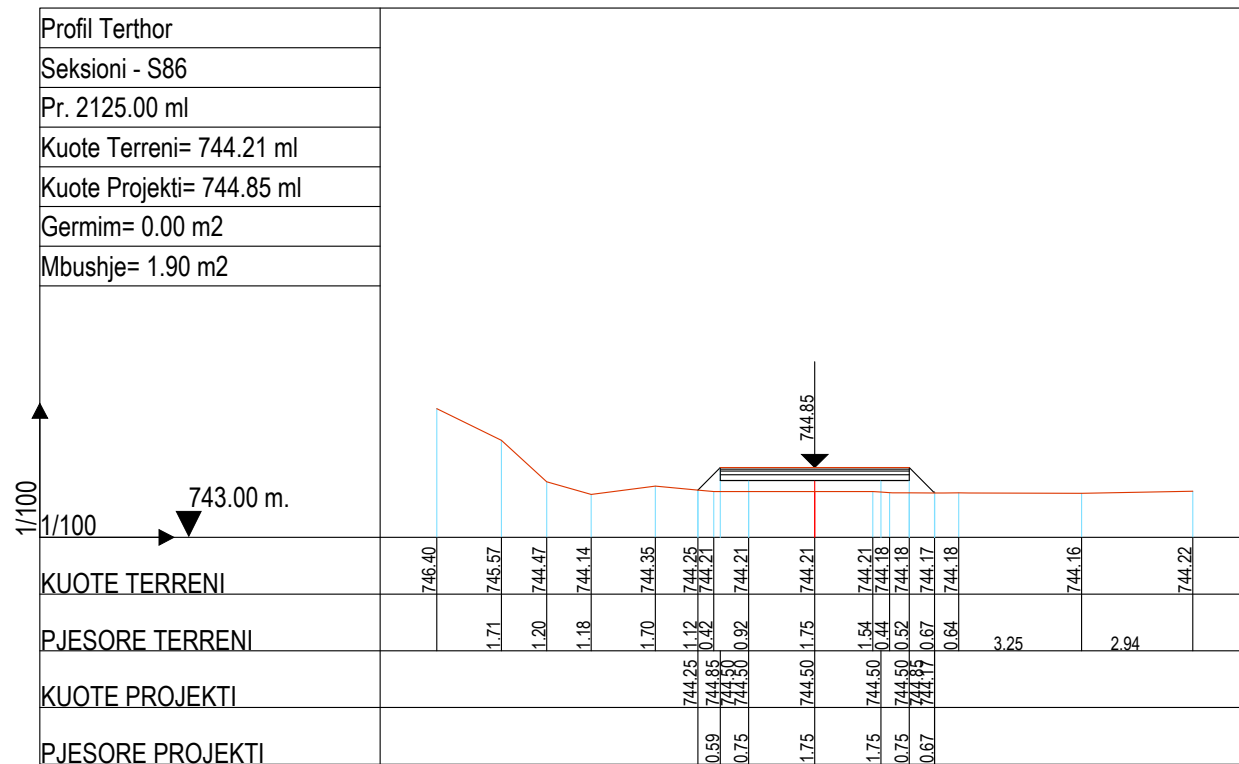

FORORITESH:

BASHKIA BULQIZE

EMERTIMI I PROJEKTTIT :
**SISTEM-ASFALTIM I RRUGES BLLACE,
LOTI I, N.J.A. SHUPENZE,
BASHKIA BULQIZE**

FAZA E PROJEKTTIT :
PROJEKT ZBATIMI

EMERTIMI I FLETES :
PROFILAT TERTHORE

SHKALLA 1:200	NR. FLETES 21
------------------	------------------

GRUPI I PROJEKTTIMIT : **"ALBGOLDING 2E" sh.p.k**

Ing. Hajredin MURGU
Ark. Soela MERKO
Ark. Erion MURGU

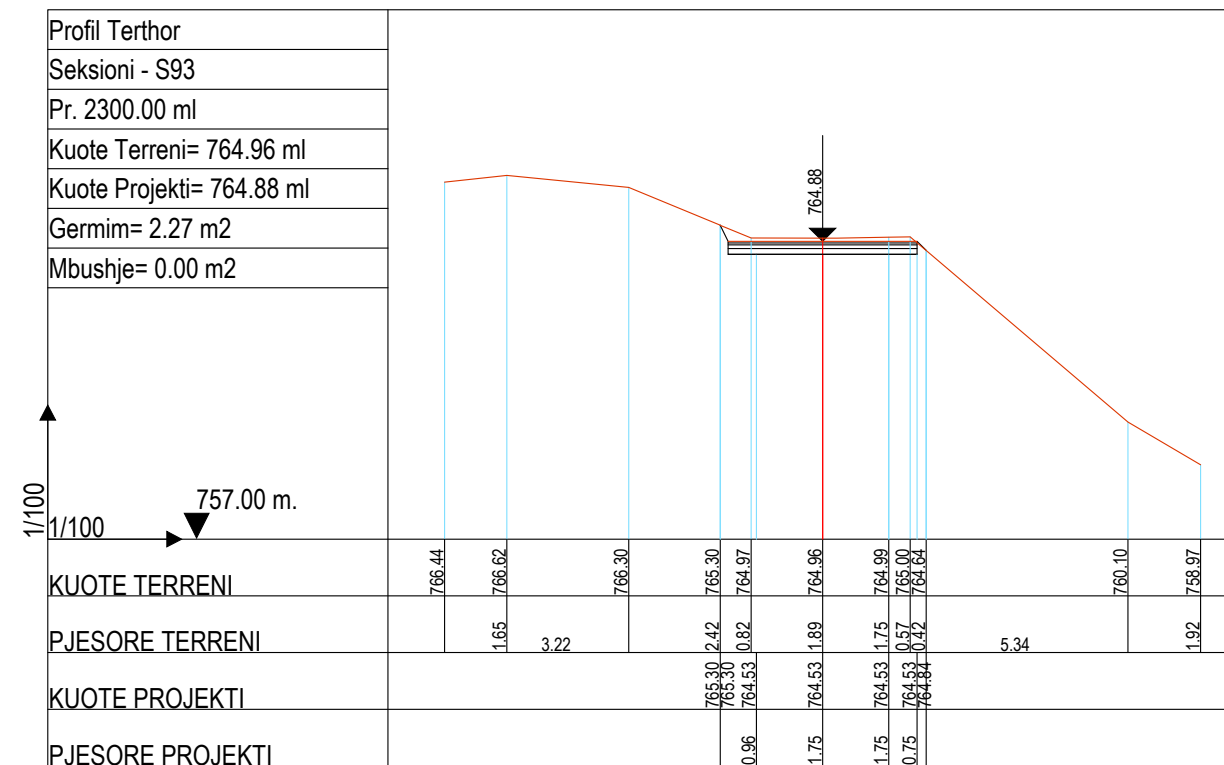
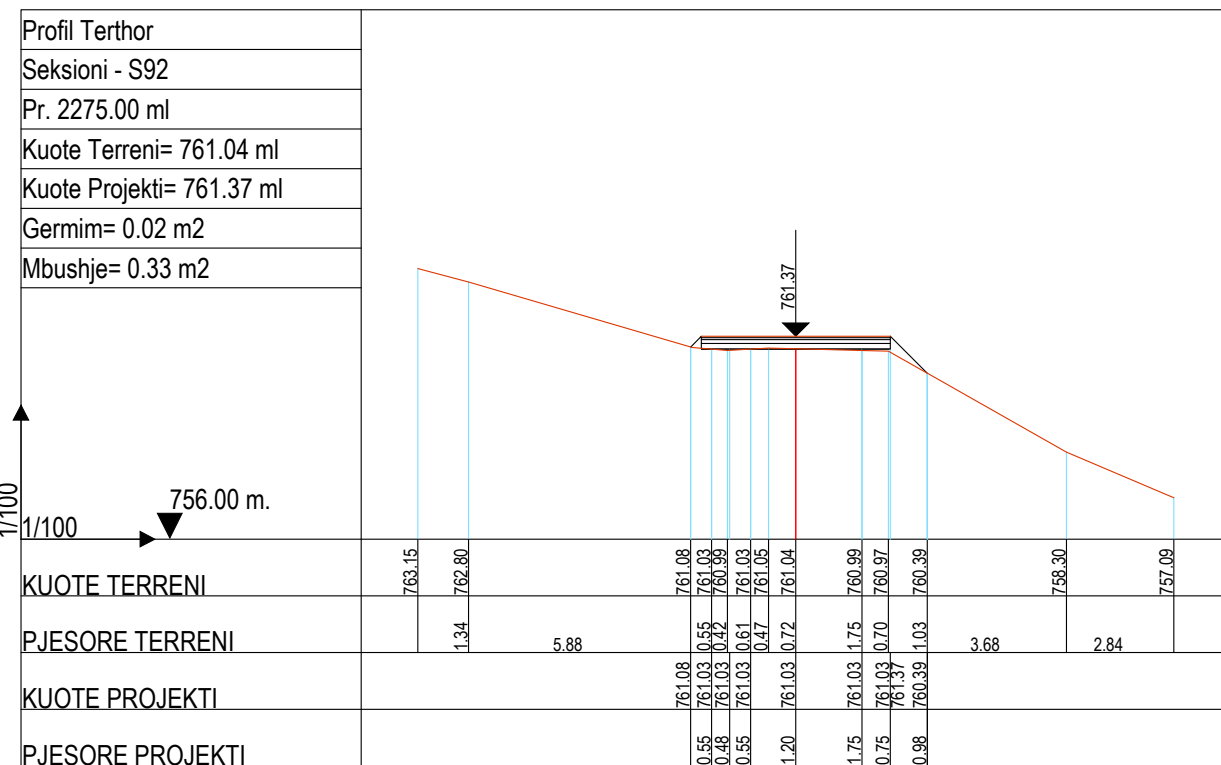
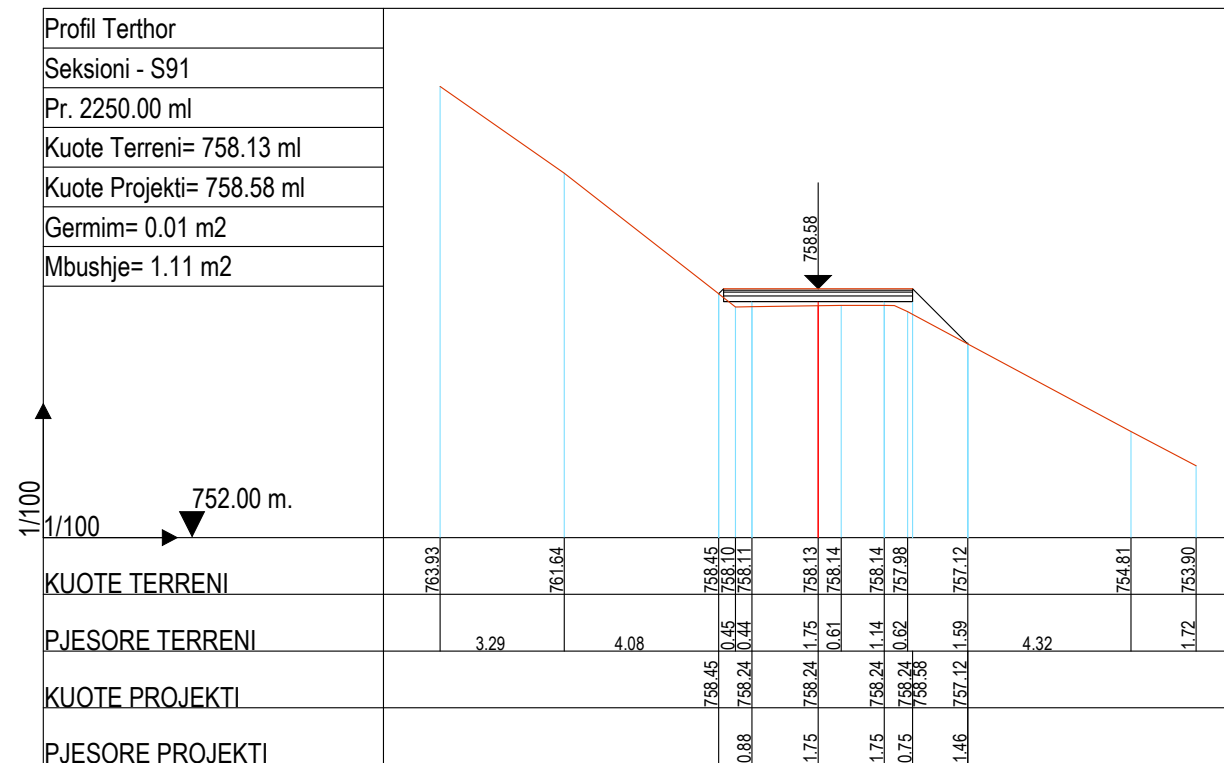
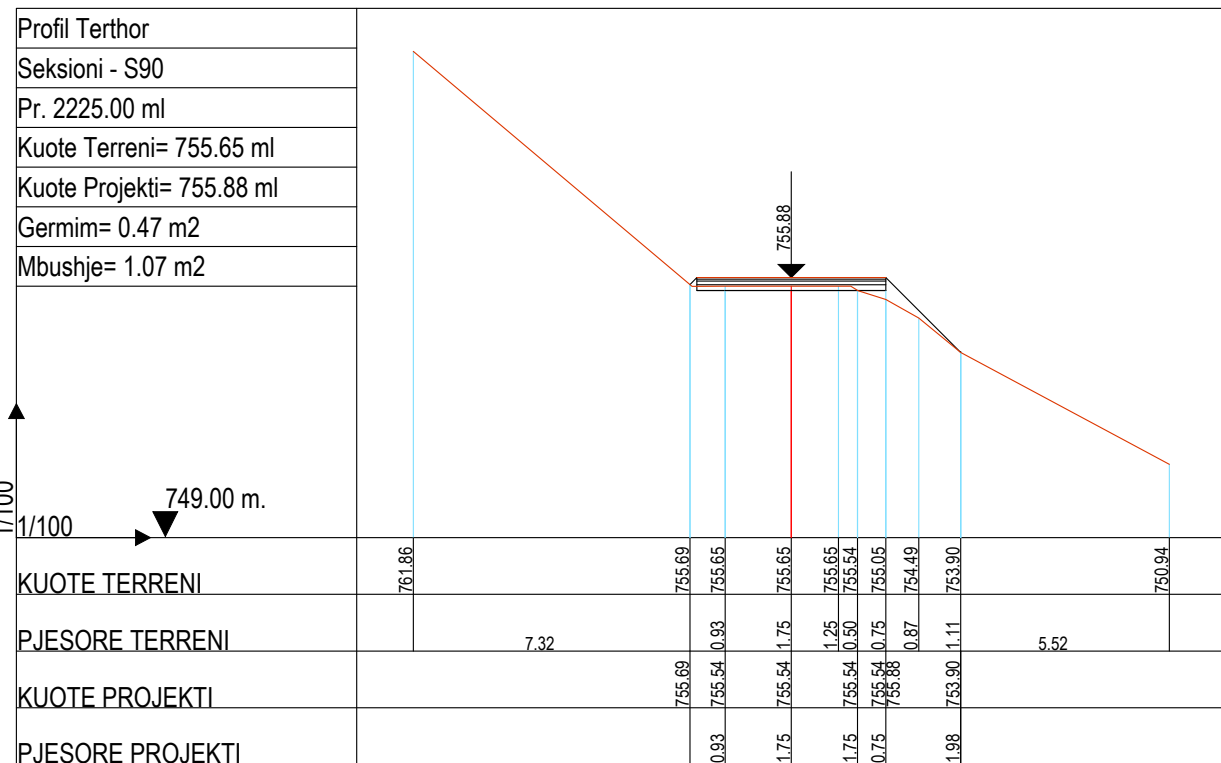

FOROSITESH:

BASHKIA BULQIZE

EMERTIMI I PROJEKTTIT :

**SISTEM-ASFALTIM I RRUGES BLLACE,
LOTI I, N.J.A. SHUPENZE,
BASHKIA BULQIZE**

FAZA E PROJEKTTIT :

PROJEKT ZBATIMI

EMERTIMI I FLETES :

PROFILAT TERTHORE

SHKALLA 1:200	NR. FLETES 22
------------------	------------------

GRUPI I PROJEKTTIMIT : **"ALBGOLDING 2E" sh.p.k**

Ing. Hajredin MURGU
Ark. Soela MERKO
Ark. Erion MURGU



"ALBGOLDING 2E" sh.p.k

CONTACT:
E-MAIL : albgolding2@gmail.com
Cel: +355 68 52 07 550
+355 68 20 85 763

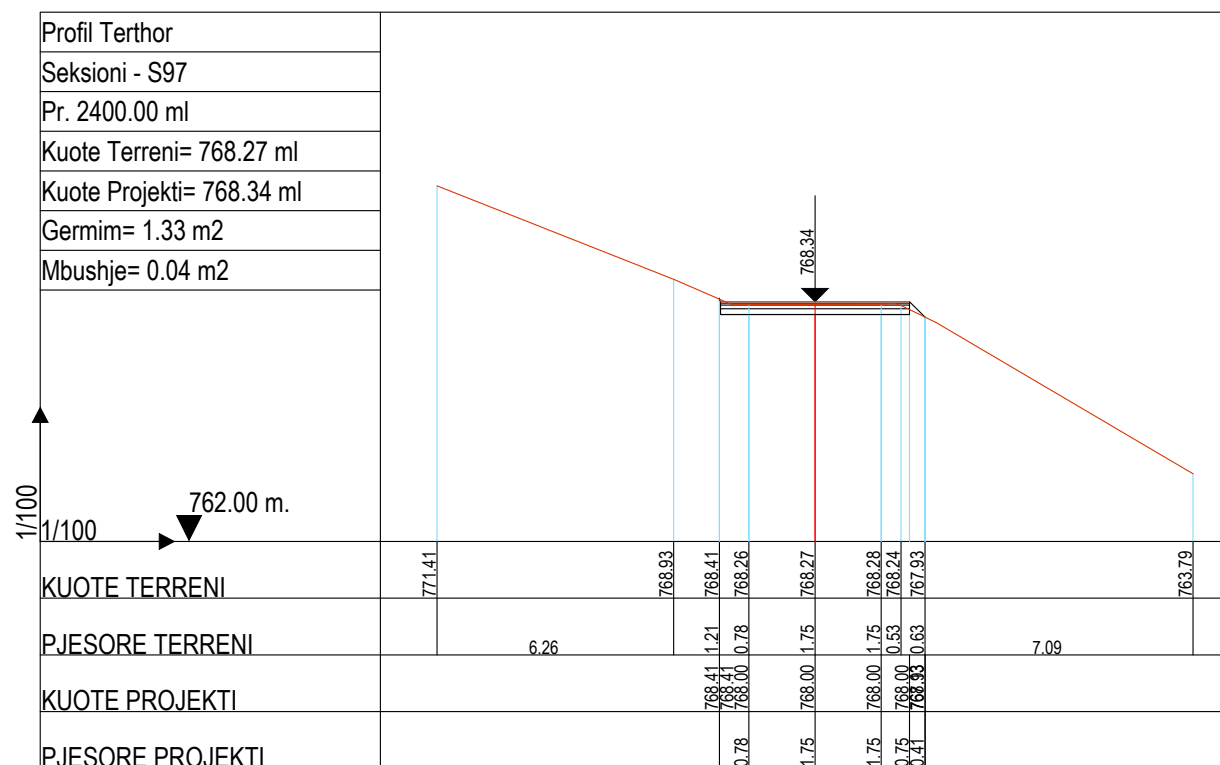
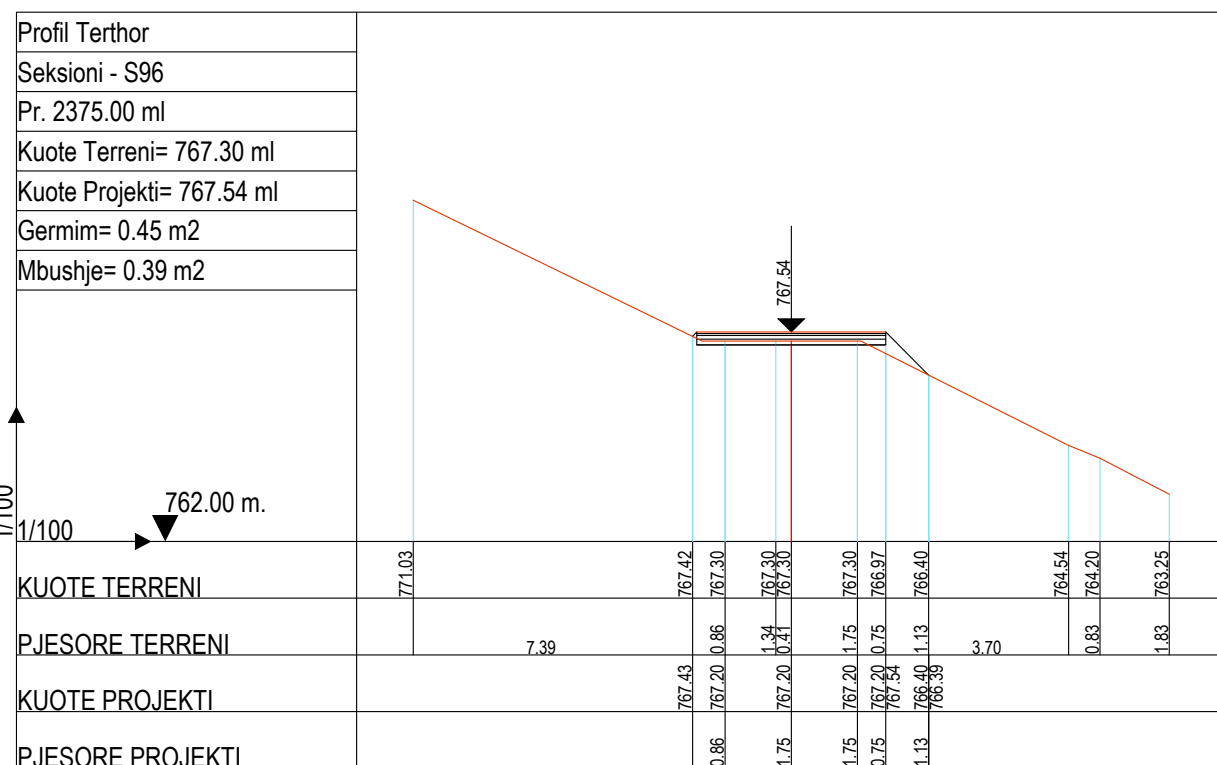
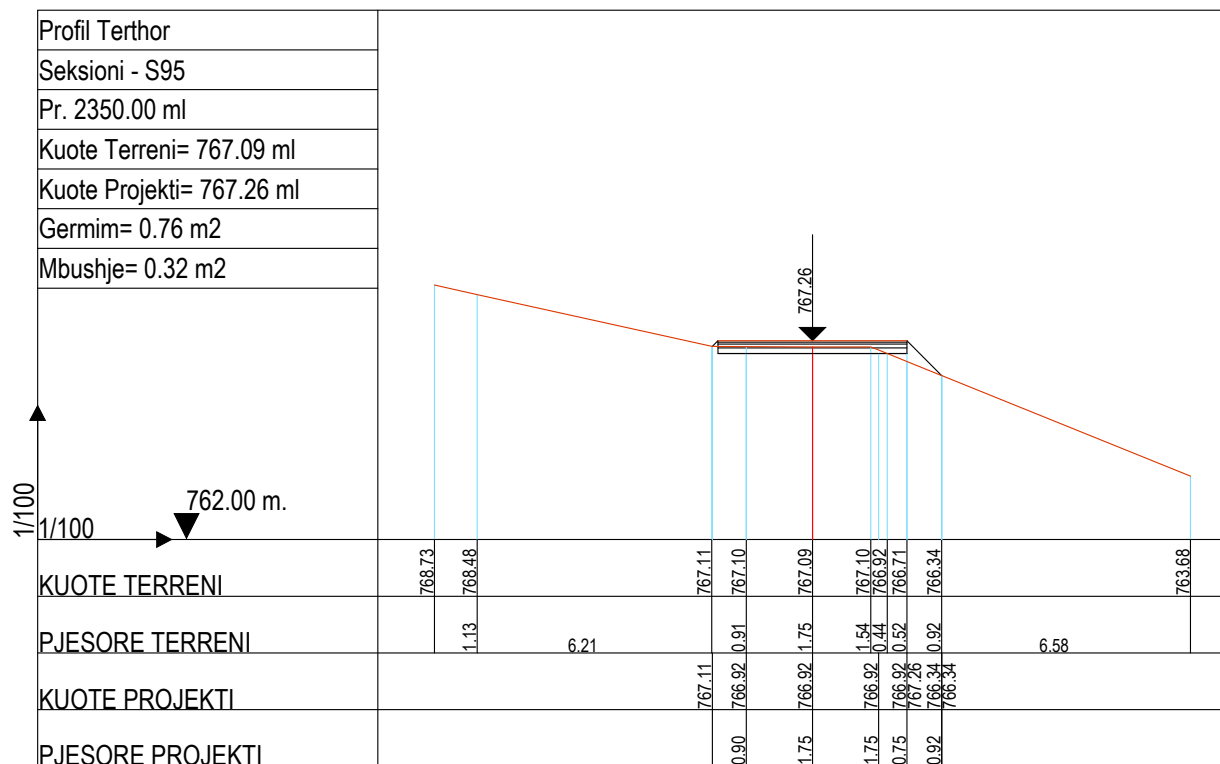
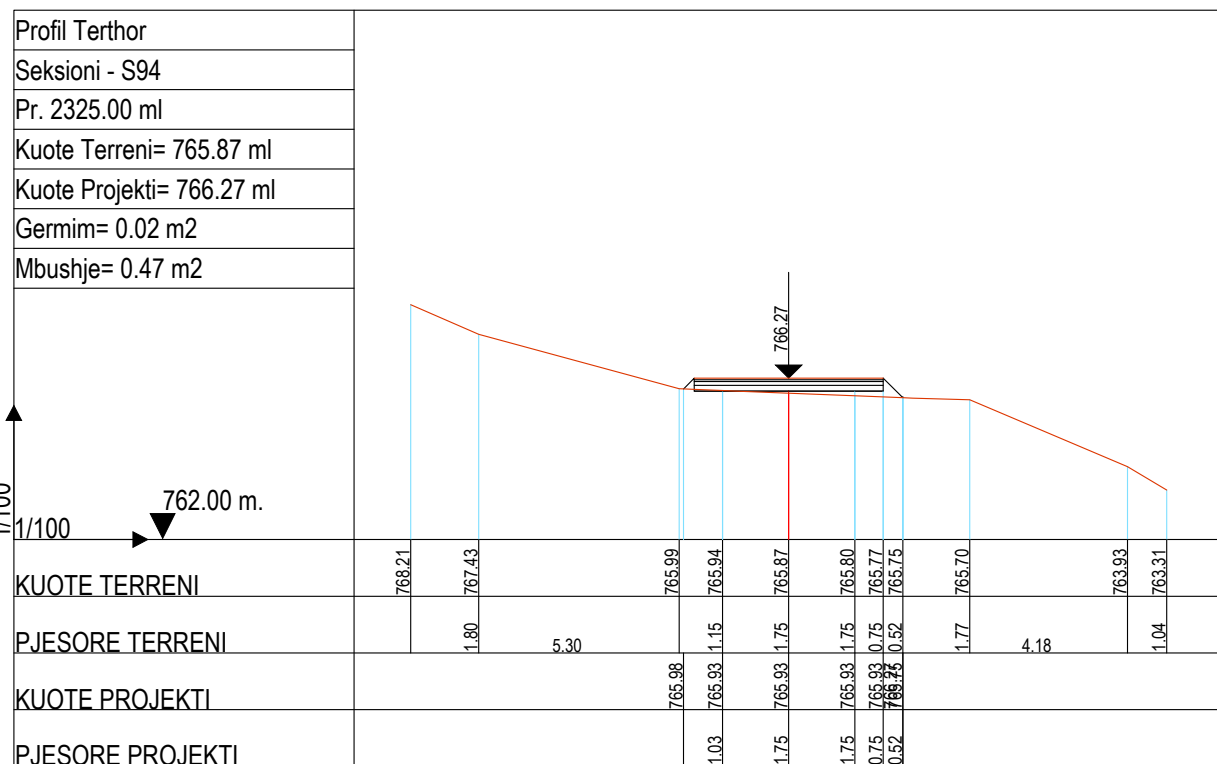

POROSTESI:

BASHKIA BULQIZE

EMERTIMI I PROJEKTTIT :

**SISTEM-ASFALTIM I RRUGES BLLACE,
LOTI I, N.J.A. SHUPENZE,
BASHKIA BULQIZE**

FAZA E PROJEKTTIT :

PROJEKT ZBATIMI

EMERTIMI I FLETES :

PROFILAT TERTHORE

SHKALLA 1:200	NR. FLETES 23
------------------	------------------

GRUPI I PROJEKTIMIT : **"ALBGOLDING 2E" sh.p.k**

Ing. Hajredin MURGU

Ark. Soela MERKO

Ark. Erion MURGU



"ALBGOLDING 2E" sh.p.k

CONTACT:
E-MAIL : albgolding2@gmail.com
Cel: +355 68 52 07 550
+355 68 20 85 763

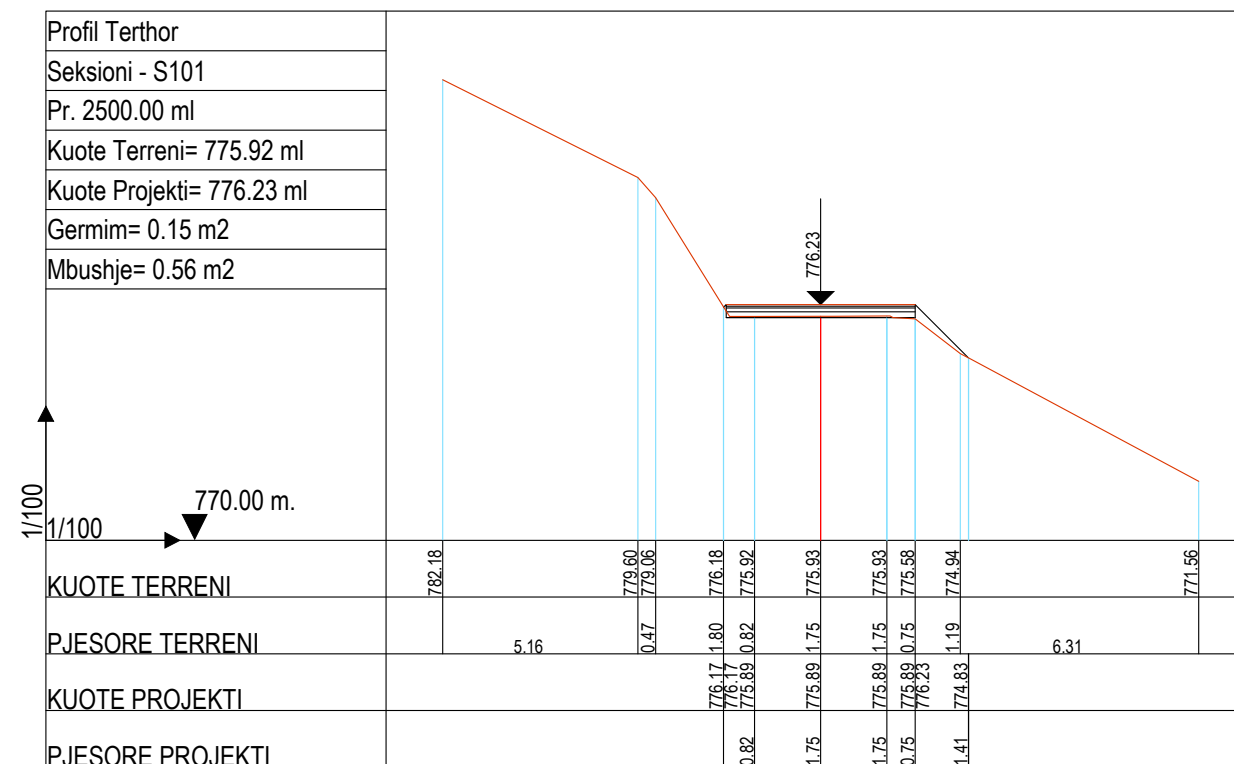
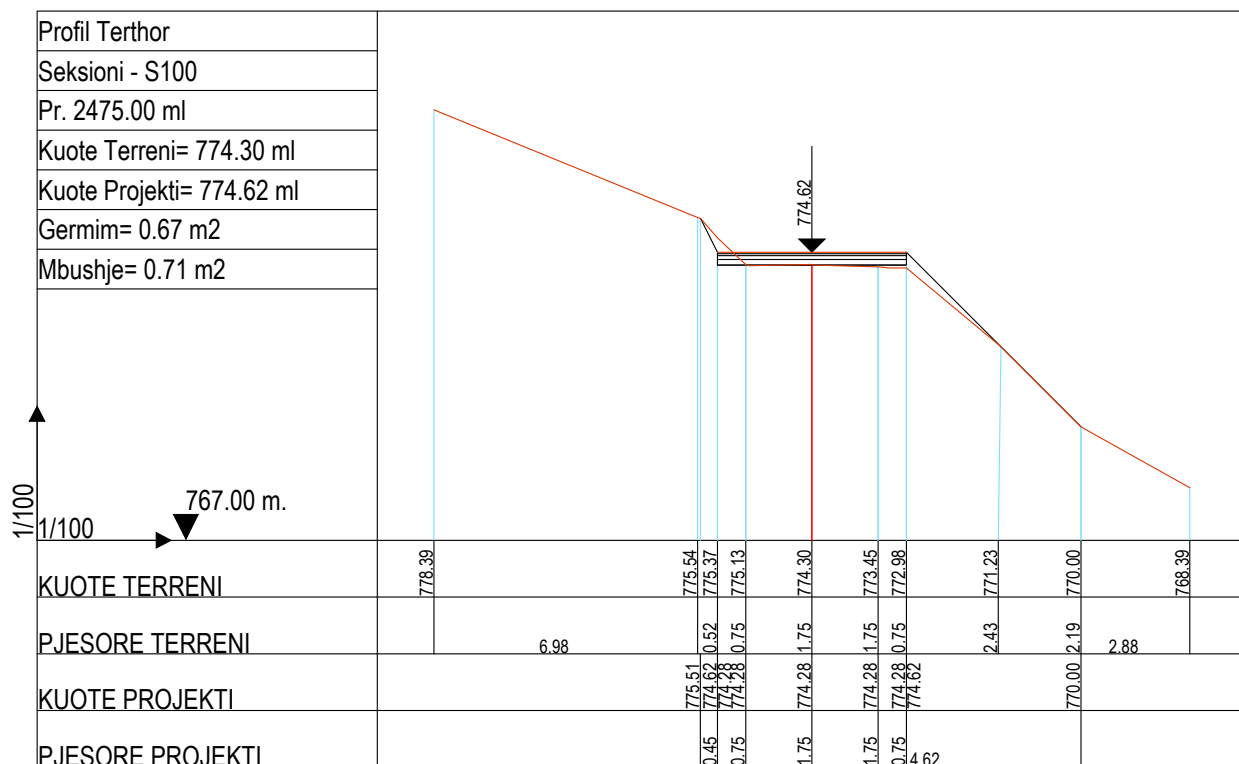
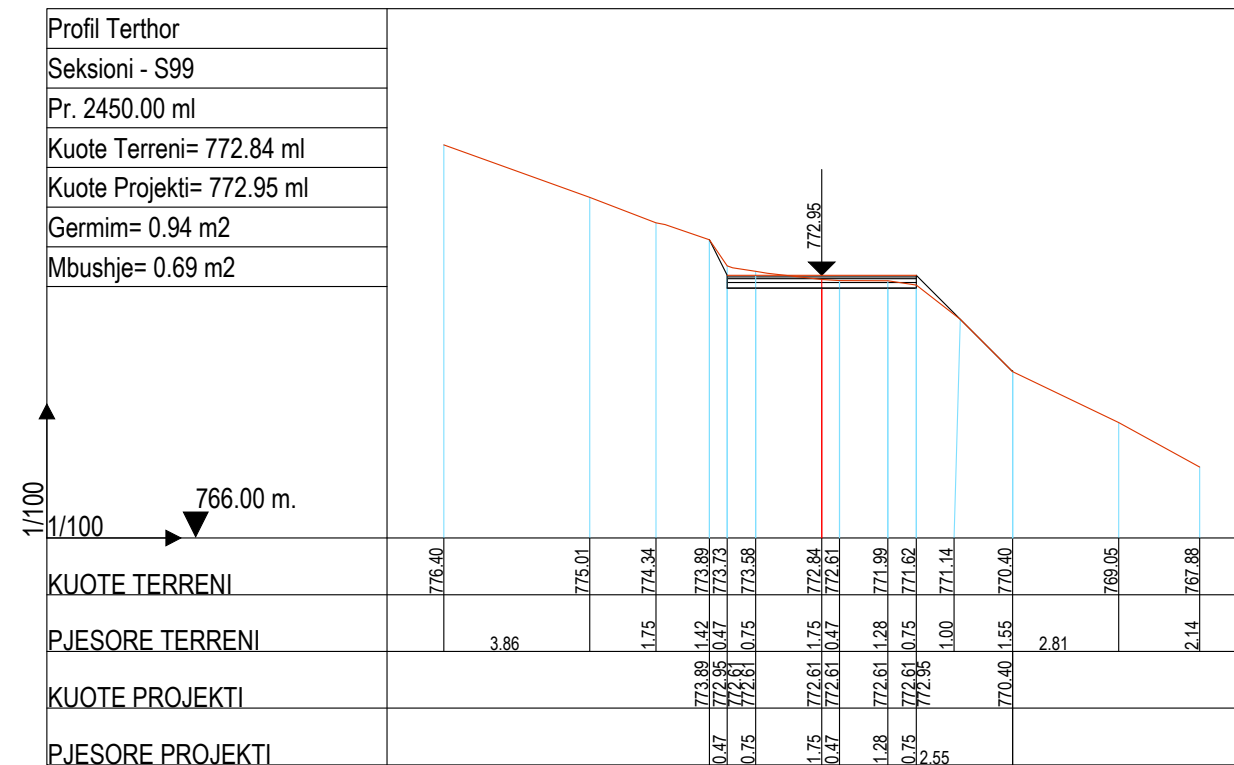
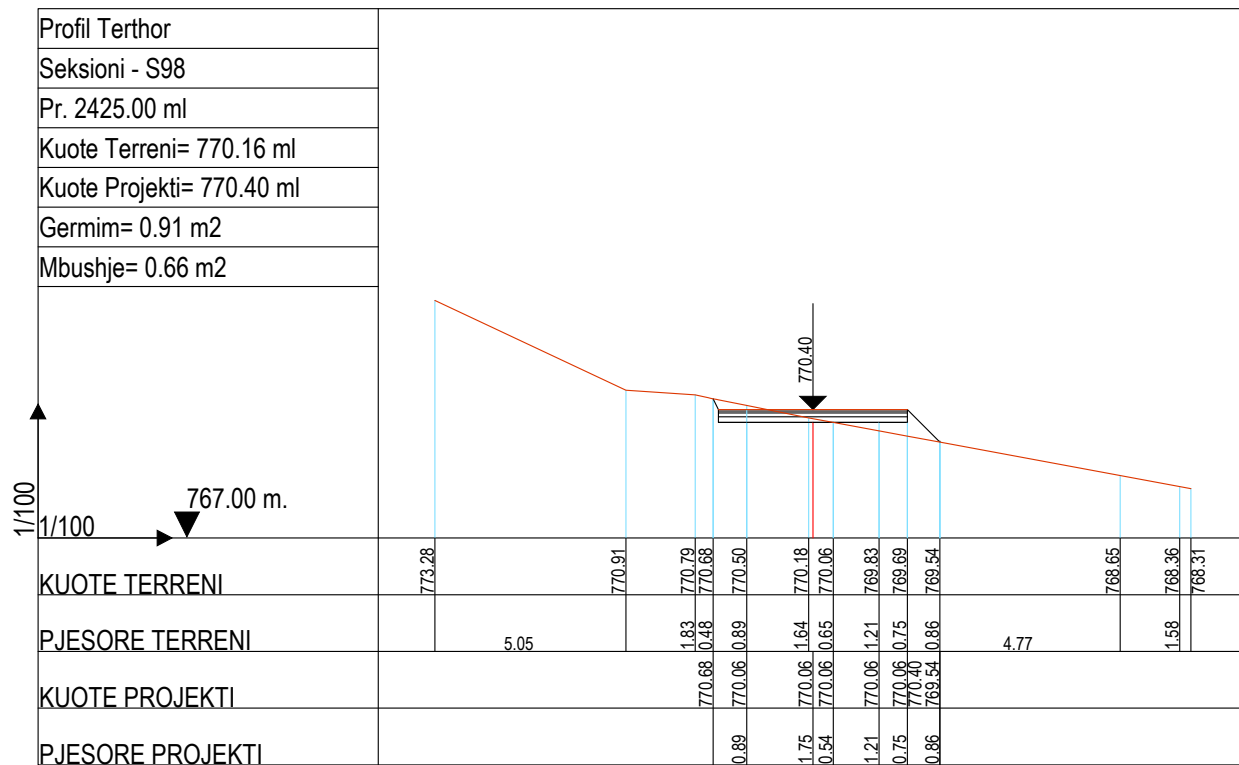

FOROSITESH:

BASHKIA BULQIZE

EMERTIMI I PROJEKTTIT :

**SISTEM-ASFALTIM I RRUGES BLLACE,
LOTI I, N.J.A. SHUPENZE,
BASHKIA BULQIZE**

FAZA E PROJEKTTIT :

PROJEKT ZBATIMI

EMERTIMI I FLETES :

PROFILAT TERTHORE

SHKALLA 1:200	NR. FLETES 24
------------------	------------------

GRUPI I PROJEKTIMIT : **"ALBGOLDING 2E" sh.p.k**

Ing. Hajredin MURGU

Ark. Soela MERKO

Ark. Erion MURGU



"ALBGOLDING 2E" sh.p.k

CONTACT:
E-MAIL : albgolding2@gmail.com
Cel: +355 68 52 07 550
+355 68 20 85 763

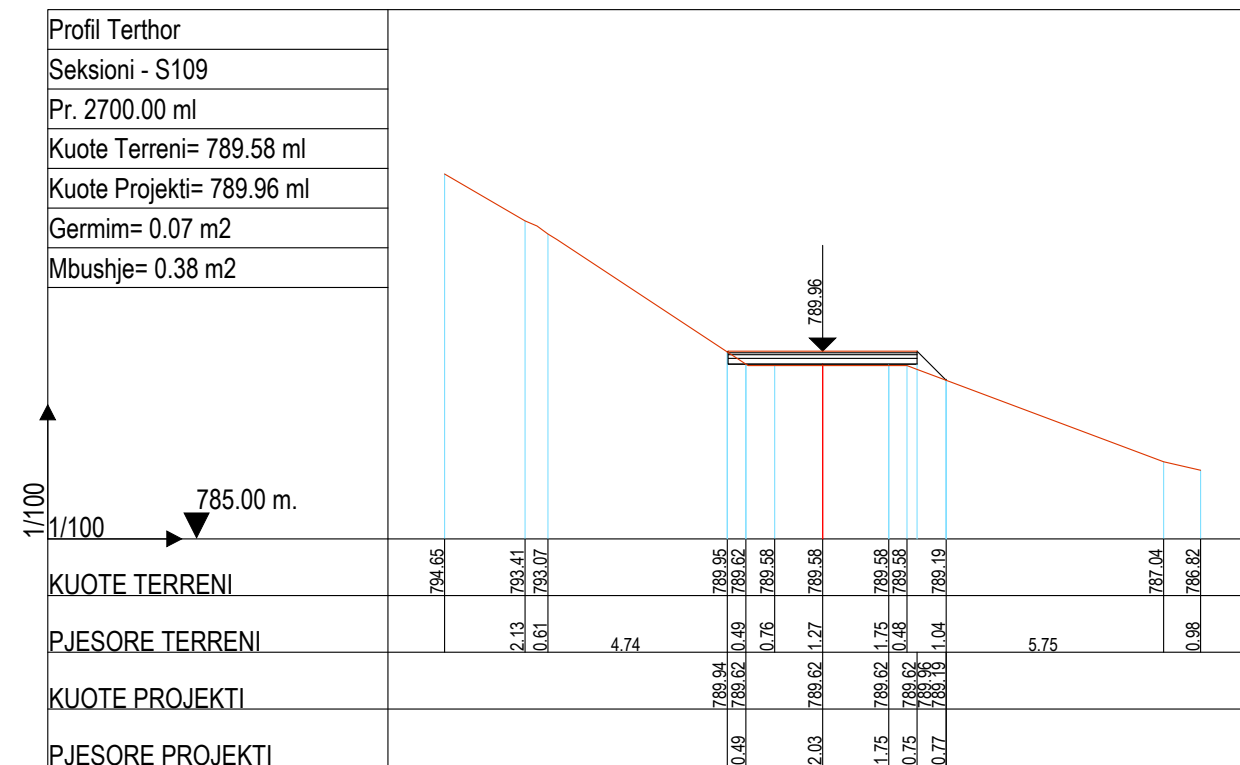
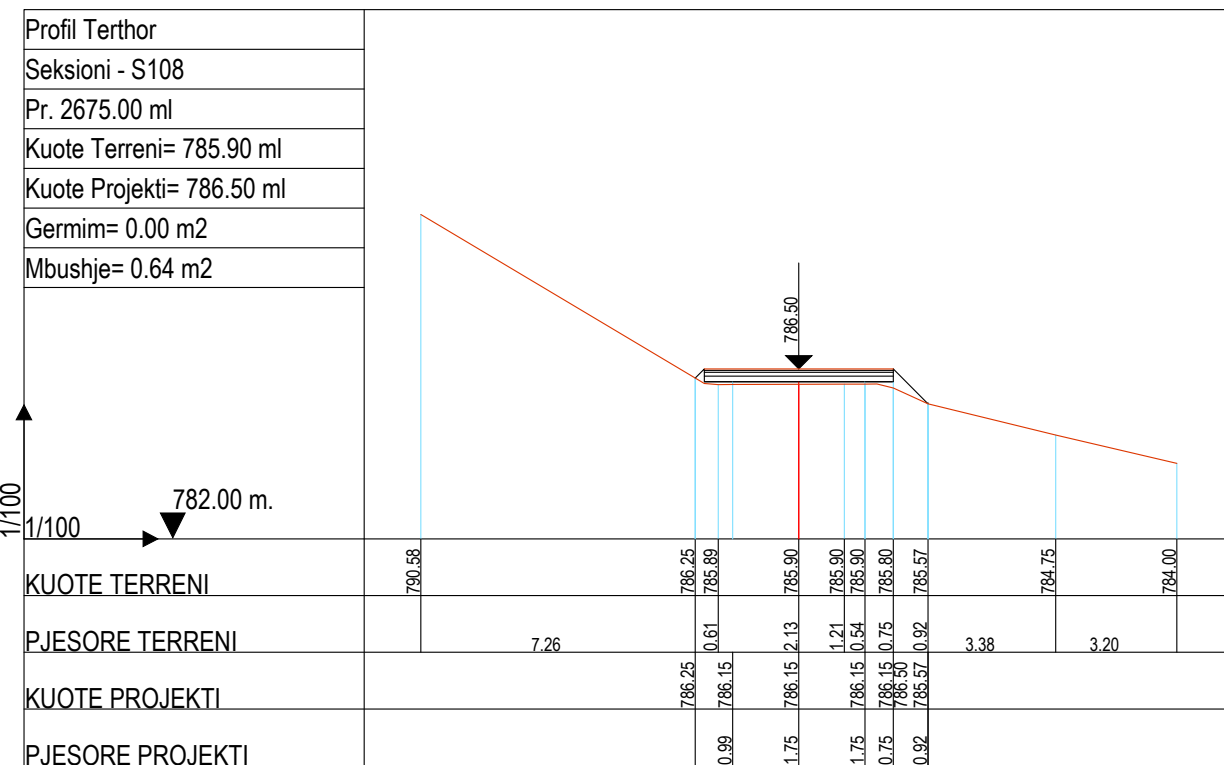
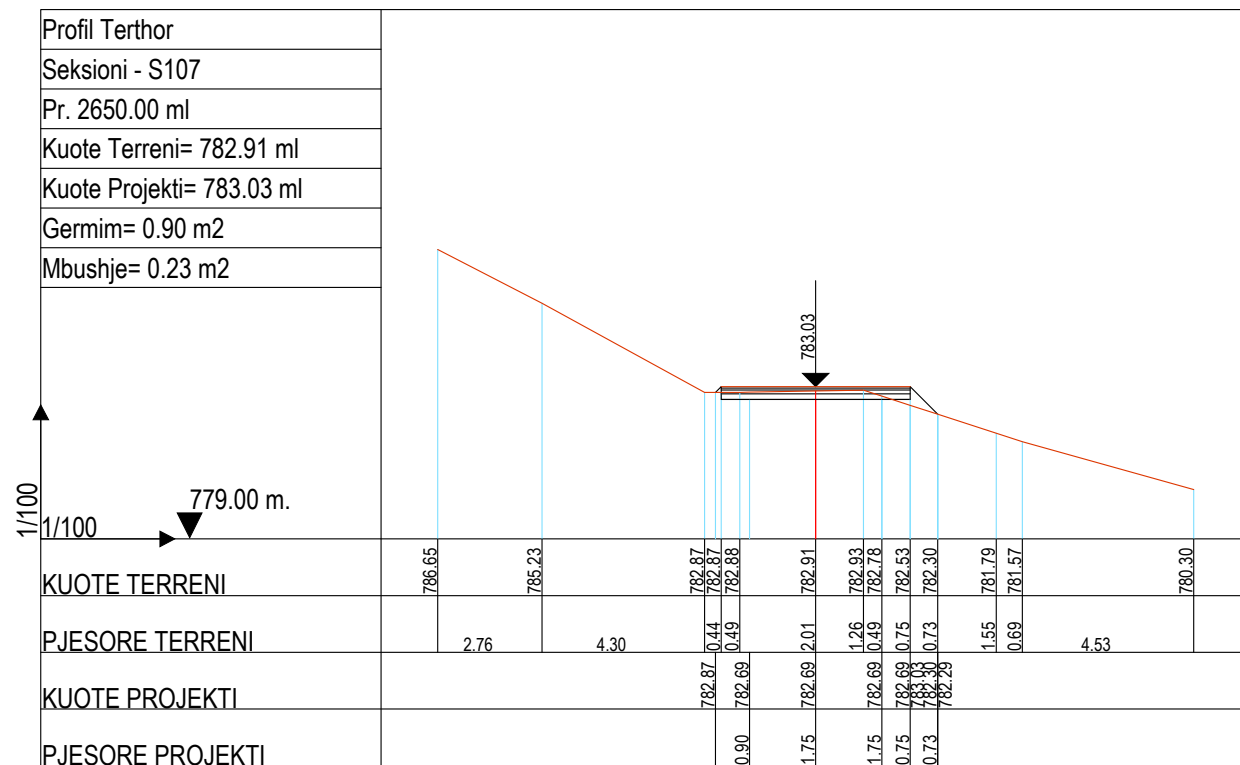
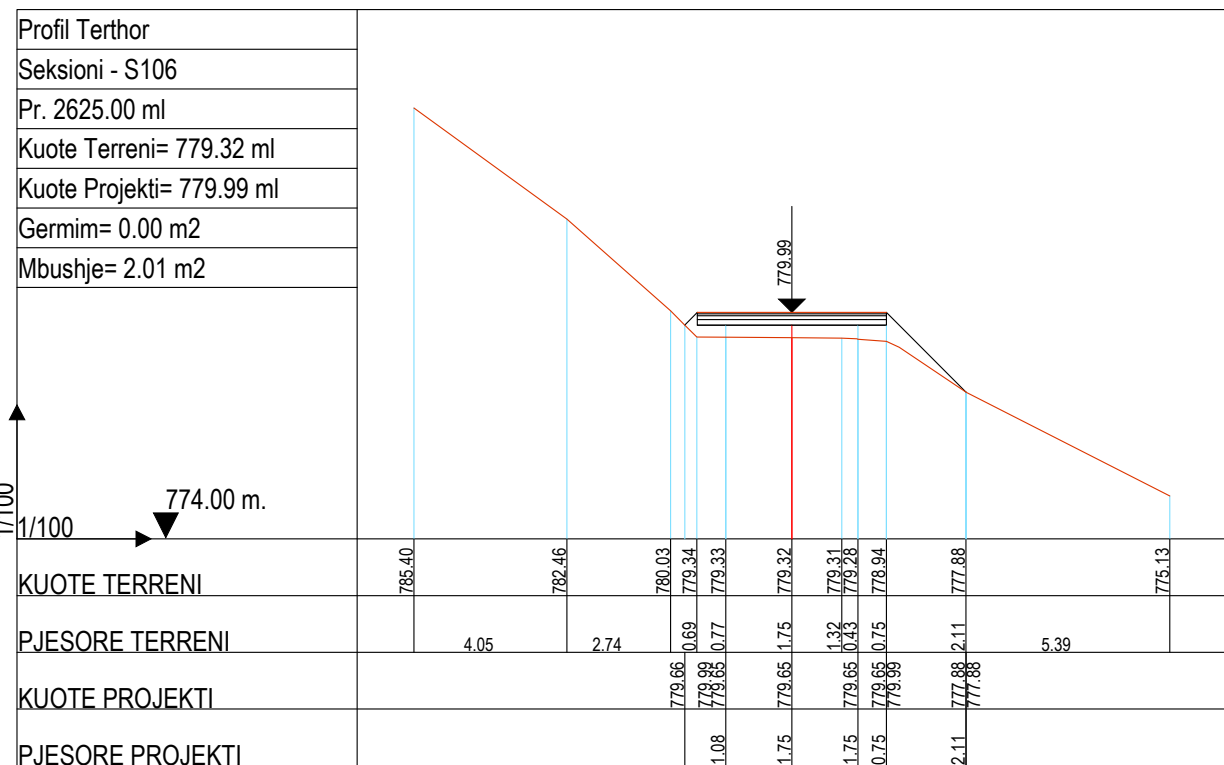

FOROSTITESH:

BASHKIA BULQIZE

EMERTIMI I PROJEKTTIT :
**SISTEM-ASFALTIM I RRUGES BLLACE,
LOTI I, NJ.A. SHUPENZE,
BASHKIA BULQIZE**

FAZA E PROJEKTTIT :
PROJEKT ZBATIMI

EMERTIMI I FLETES :
PROFILAT TERTHORE

SHKALLA 1:200	NR. FLETES 26
------------------	------------------

GRUPI I PROJEKTTIMIT : **"ALBGOLDING 2E" sh.p.k**

Ing. Hajredin MURGU
Ark. Soela MERKO
Ark. Erion MURGU

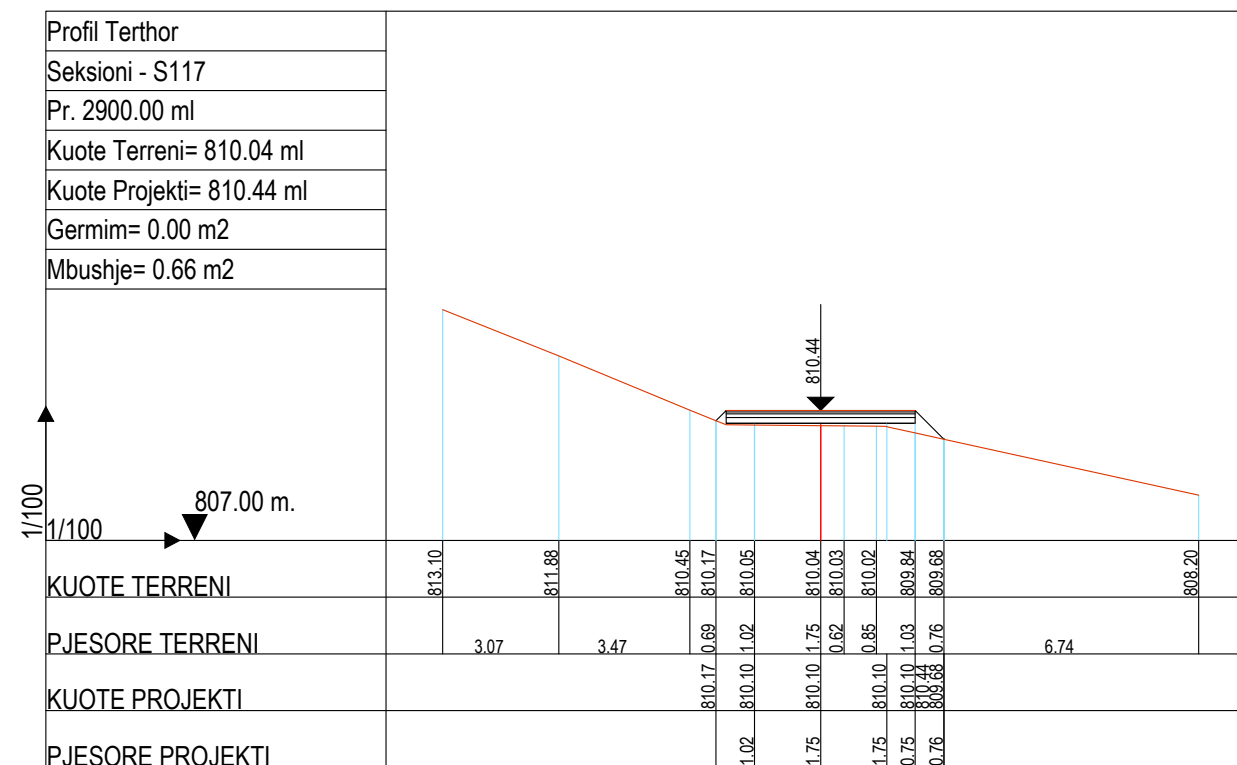
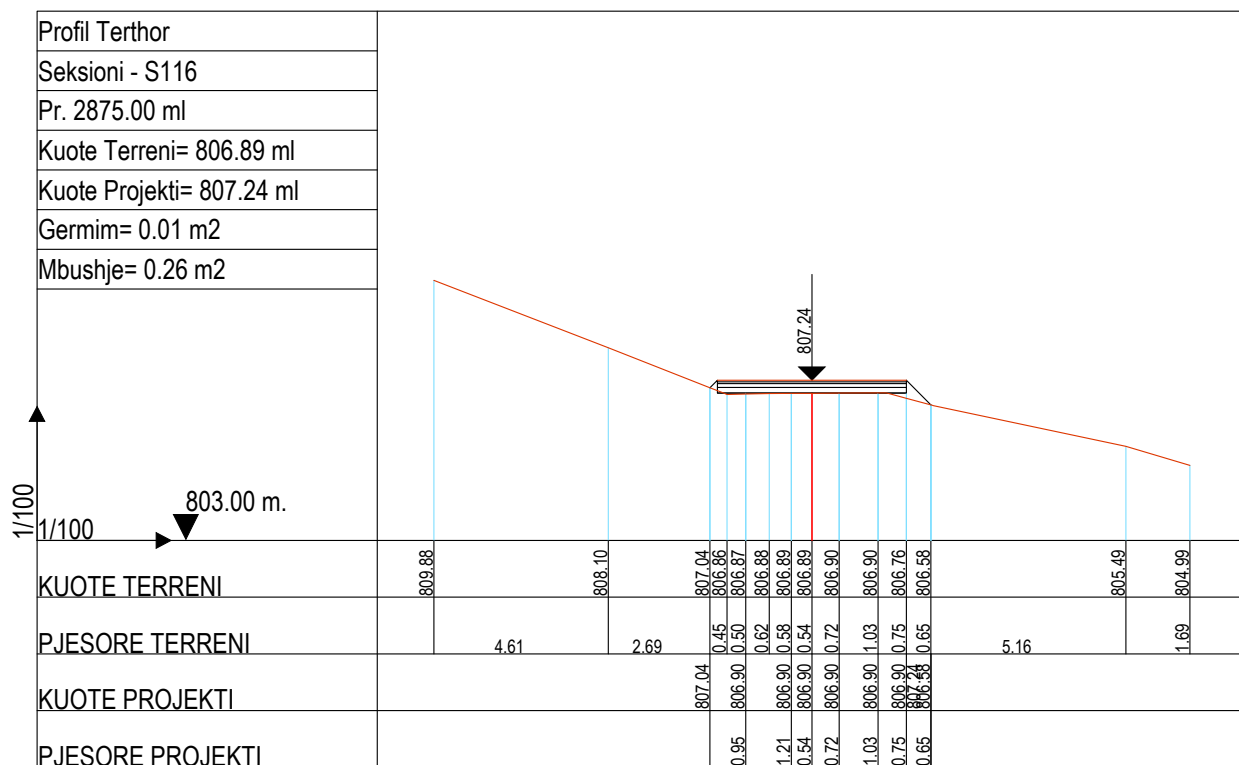
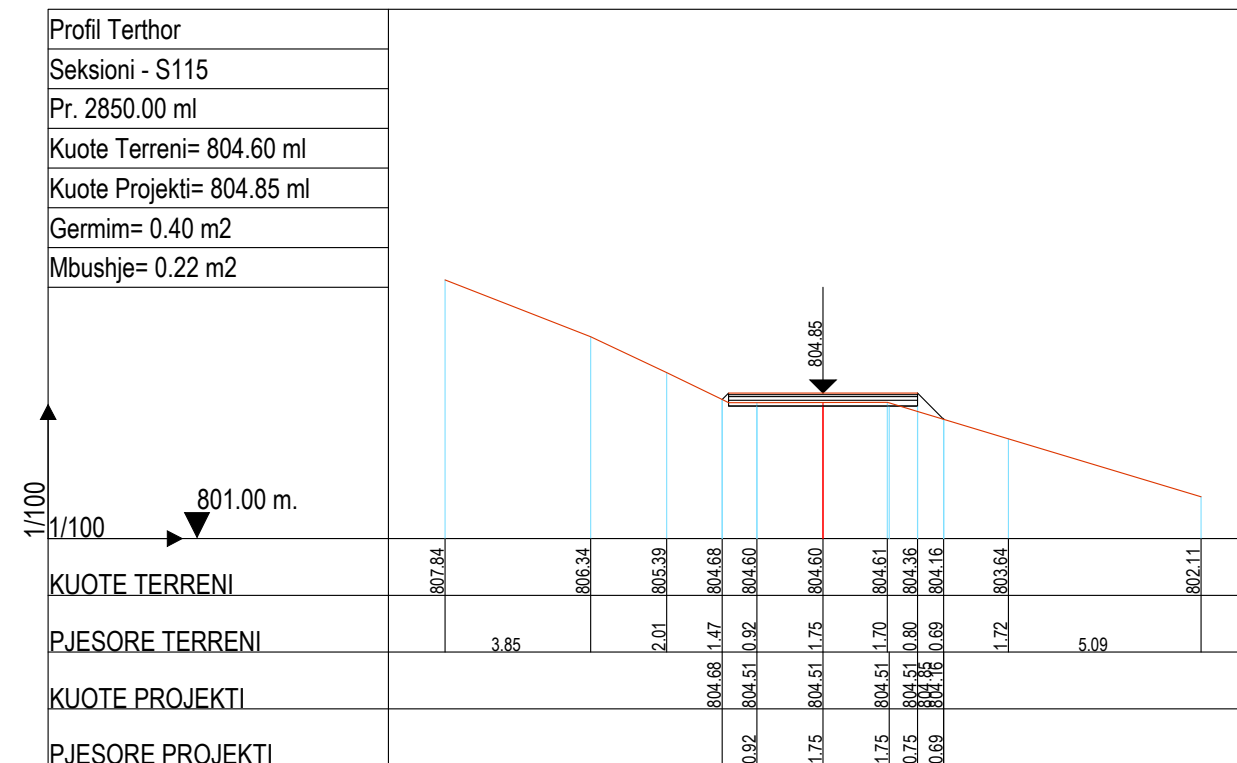
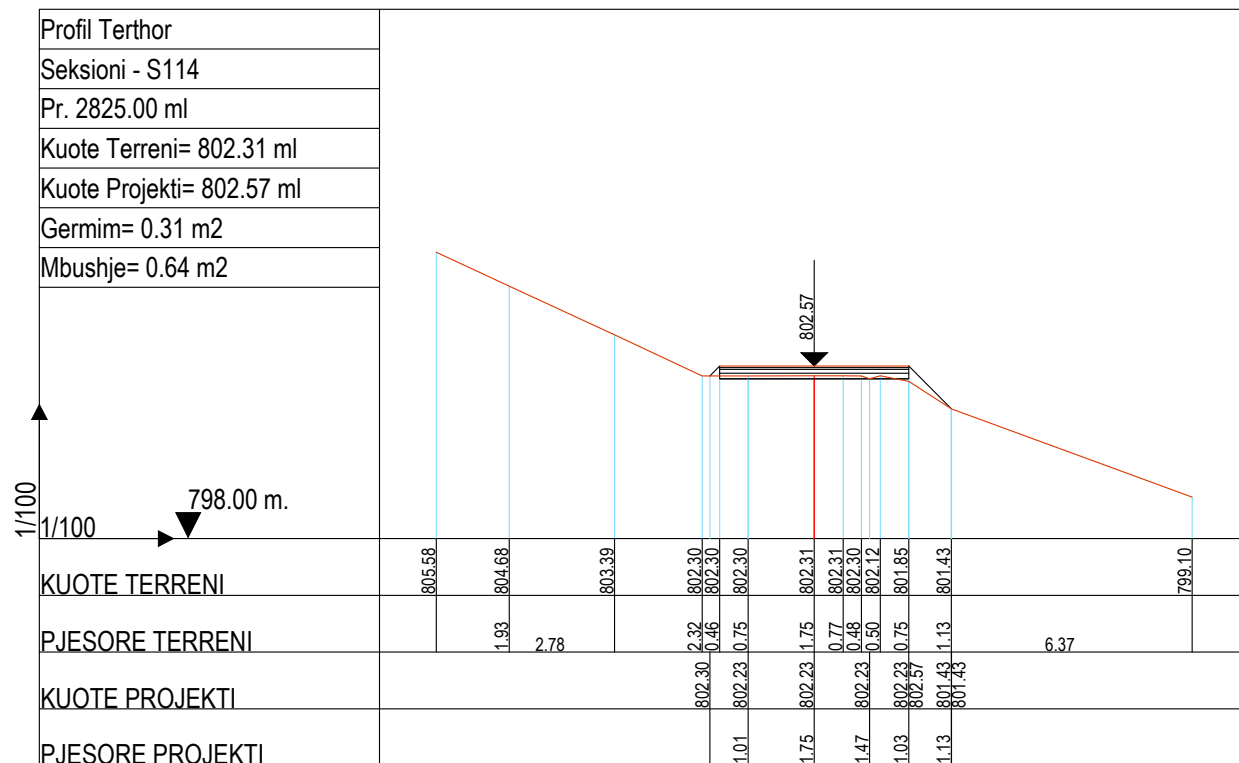

FOROSTITESH:

BASHKIA BULQIZE

EMERTIMI I PROJEKTTIT :

**SISTEM-ASFALTIM I RRUGES BLLACE,
LOTI I, N.J.A. SHUPENZE,
BASHKIA BULQIZE**

FAZA E PROJEKTTIT :

PROJEKT ZBATIMI

EMERTIMI I FLETES :

PROFILAT TERTHORE

SHKALLA 1:200	NR. FLETES 28
------------------	------------------

GRUPI I PROJEKTTIMIT : **"ALBGOLDING 2E" sh.p.k**

Ing. Hajredin MURGU

Ark. Soela MERKO

Ark. Erion MURGU



"ALBGOLDING 2E" sh.p.k

CONTACT:
E-MAIL : albgolding2@gmail.com
Cel: +355 68 52 07 550
+355 68 20 85 763

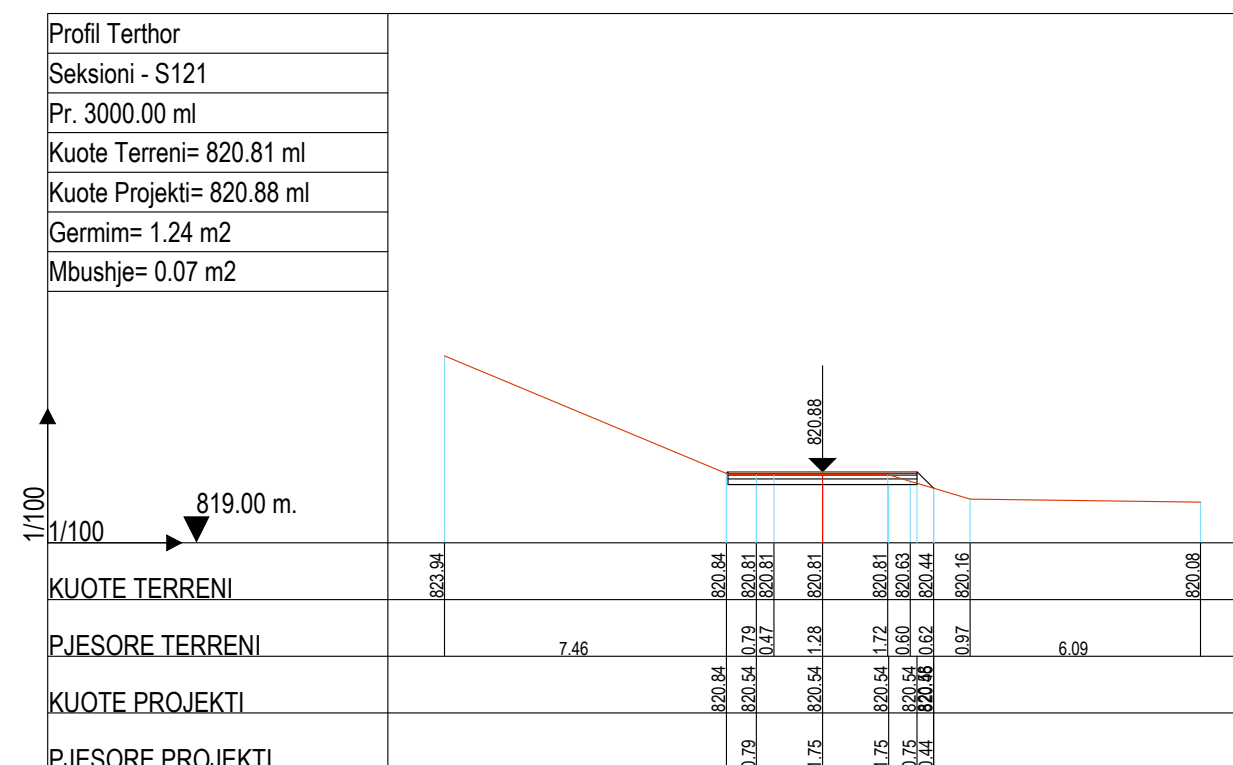
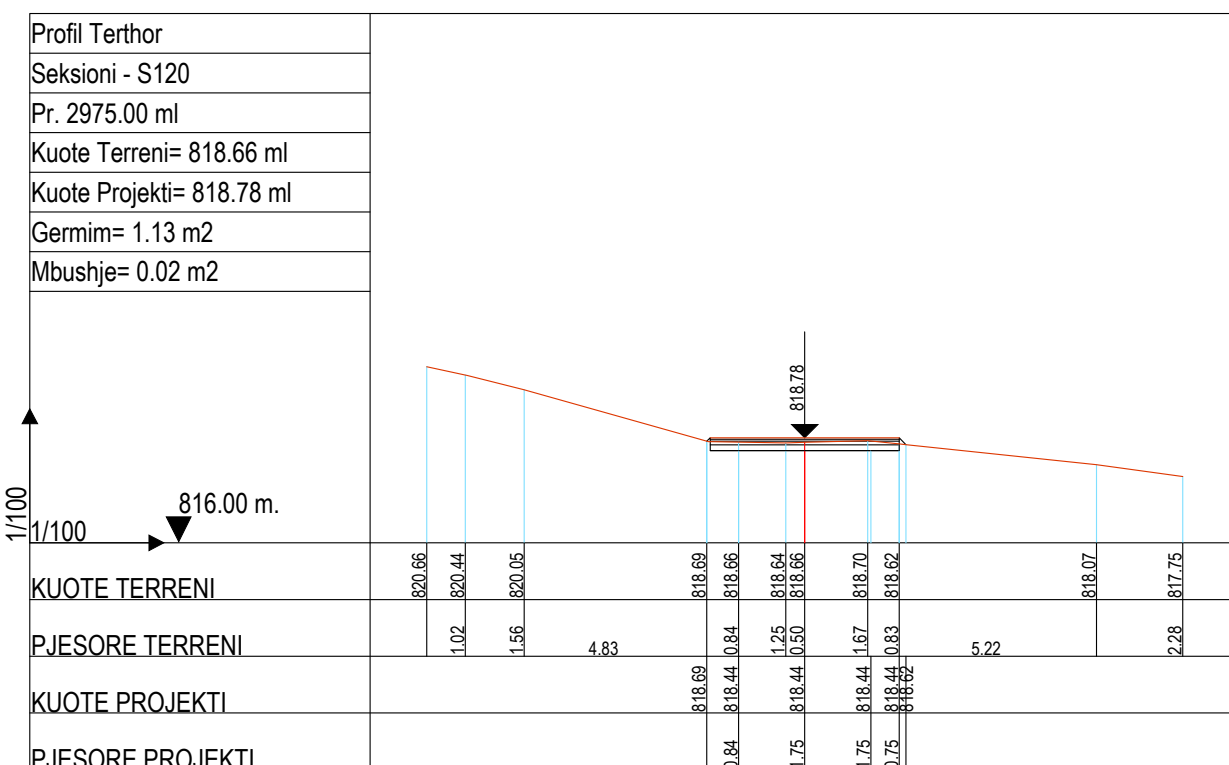
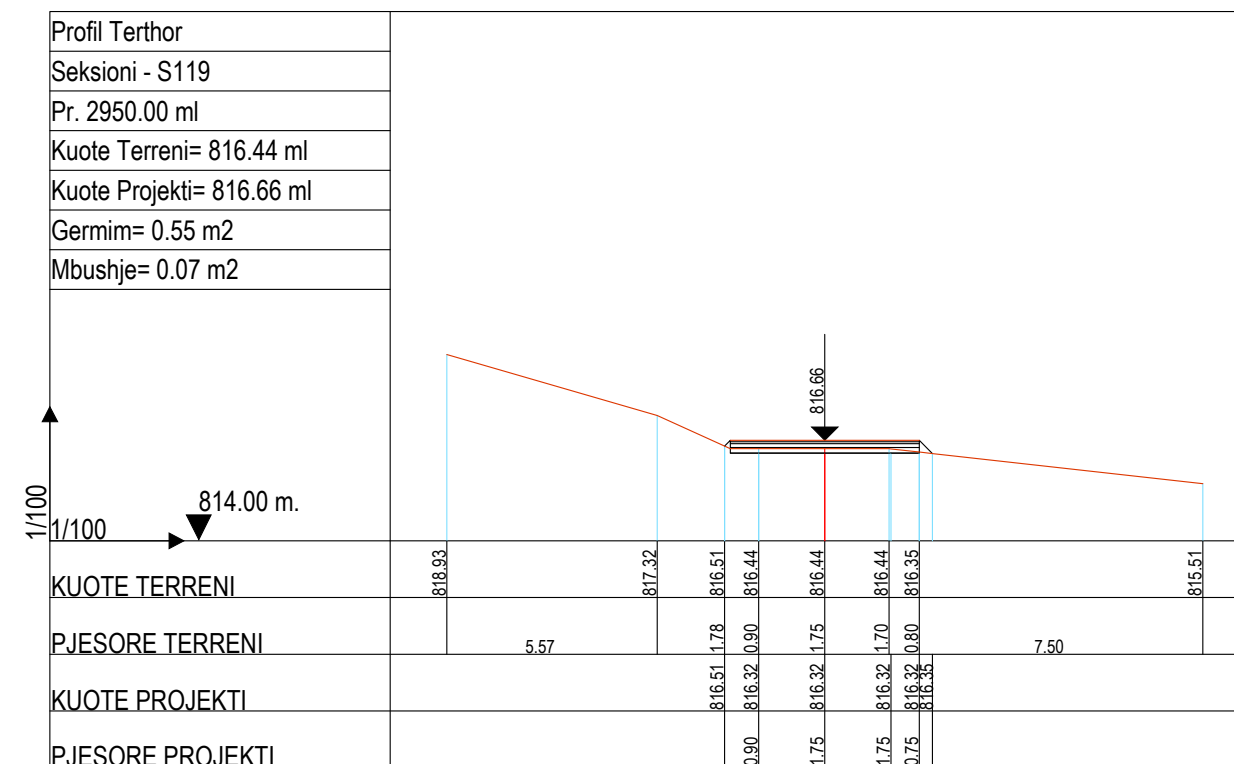
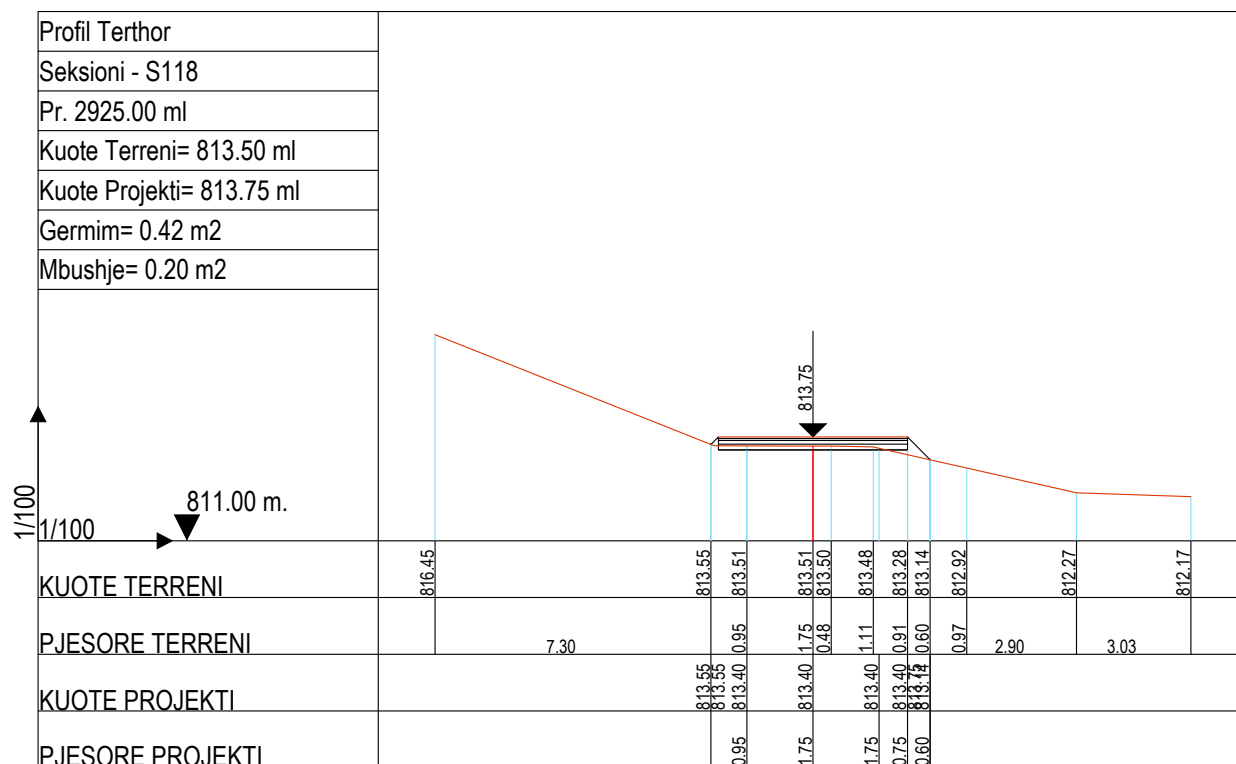

FOROSITESH:

BASHKIA BULQIZE

EMERTIMI I PROJEKTTIT :

**SISTEM-ASFALTIM I RRUGES BLLACE,
LOTI I, N.J.A. SHUPENZE,
BASHKIA BULQIZE**

FAZA E PROJEKTTIT :

PROJEKT ZBATIMI

EMERTIMI I FLETES :

PROFILAT TERTHORE

SHKALLA 1:200	NR. FLETES 29
------------------	------------------

GRUPI I PROJEKTTIMIT : "ALBGOLDING 2E" sh.p.k

Ing. Hajredin MURGU

Ark. Soela MERKO

Ark. Erion MURGU



"ALBGOLDING 2E" sh.p.k

CONTACT:
E-MAIL : albgolding2@gmail.com
Cel: +355 68 52 07 550
+355 68 20 85 763

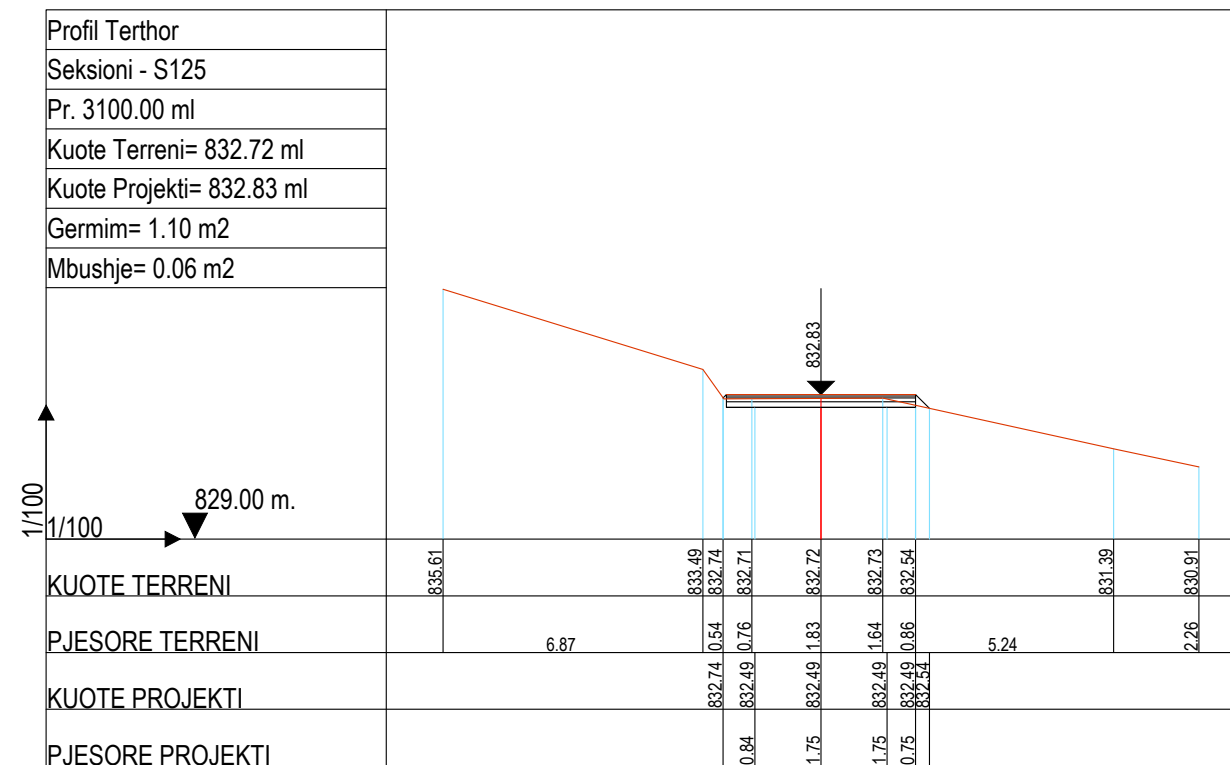
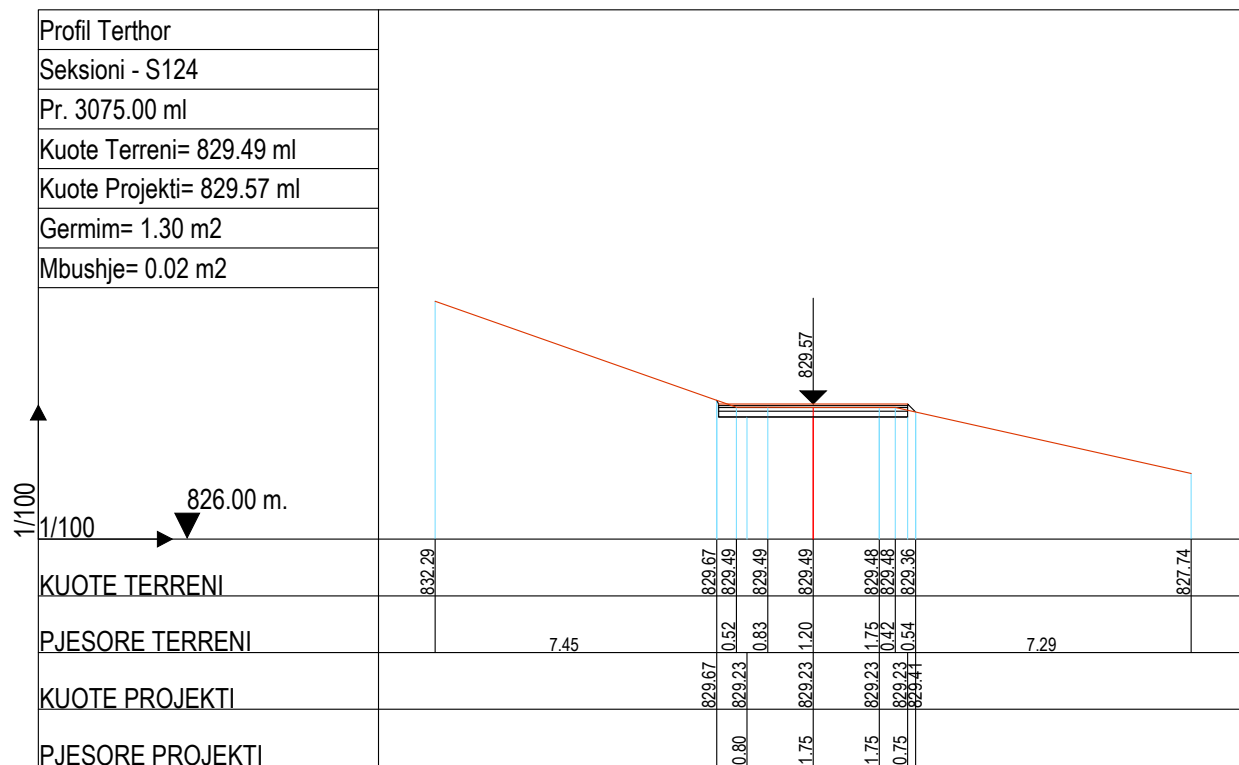
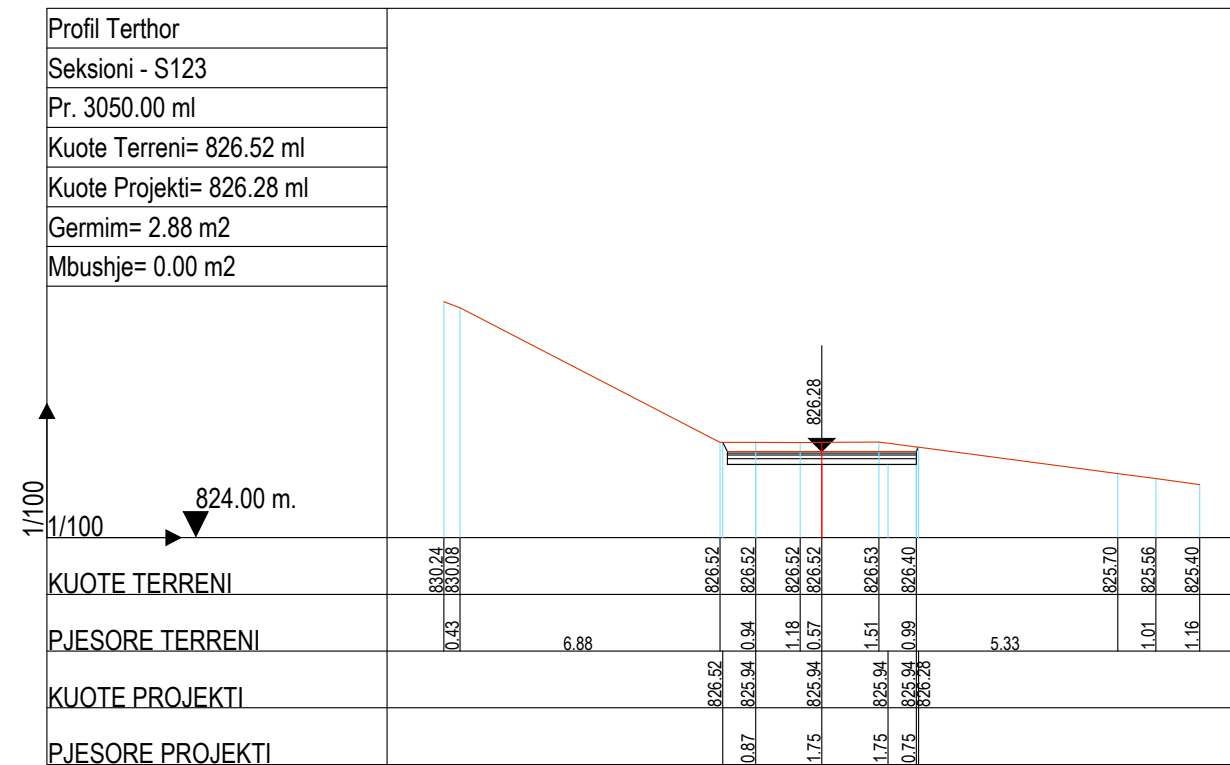
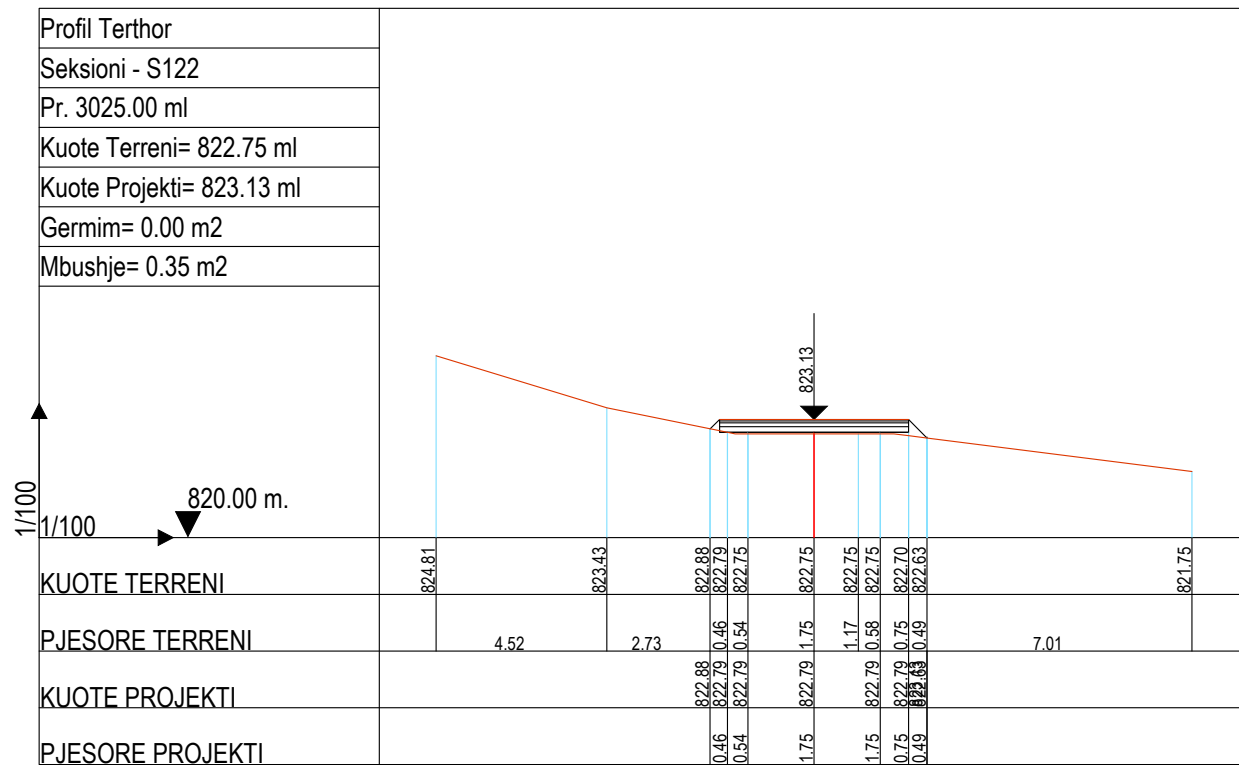

FOROSTESI:

BASHKIA BULQIZE

EMERTIMI I PROJEKTTIT :

**SISTEM-ASFALTIM I RRUGES BLLACE,
LOTI I, N.J.A. SHUPENZE,
BASHKIA BULQIZE**

FAZA E PROJEKTTIT :

PROJEKT ZBATIMI

EMERTIMI I FLETES :

PROFILAT TERTHORE

SHKALLA 1:200	NR. FLETES 30
------------------	------------------

GRUPI I PROJEKTTIMIT : **"ALBGOLDING 2E" sh.p.k**

Ing. Hajredin MURGU

Ark. Soela MERKO

Ark. Erion MURGU



"ALBGOLDING 2E" sh.p.k

CONTACT:
E-MAIL : albgolding2@gmail.com
Cel: +355 68 52 07 550
+355 68 20 85 763

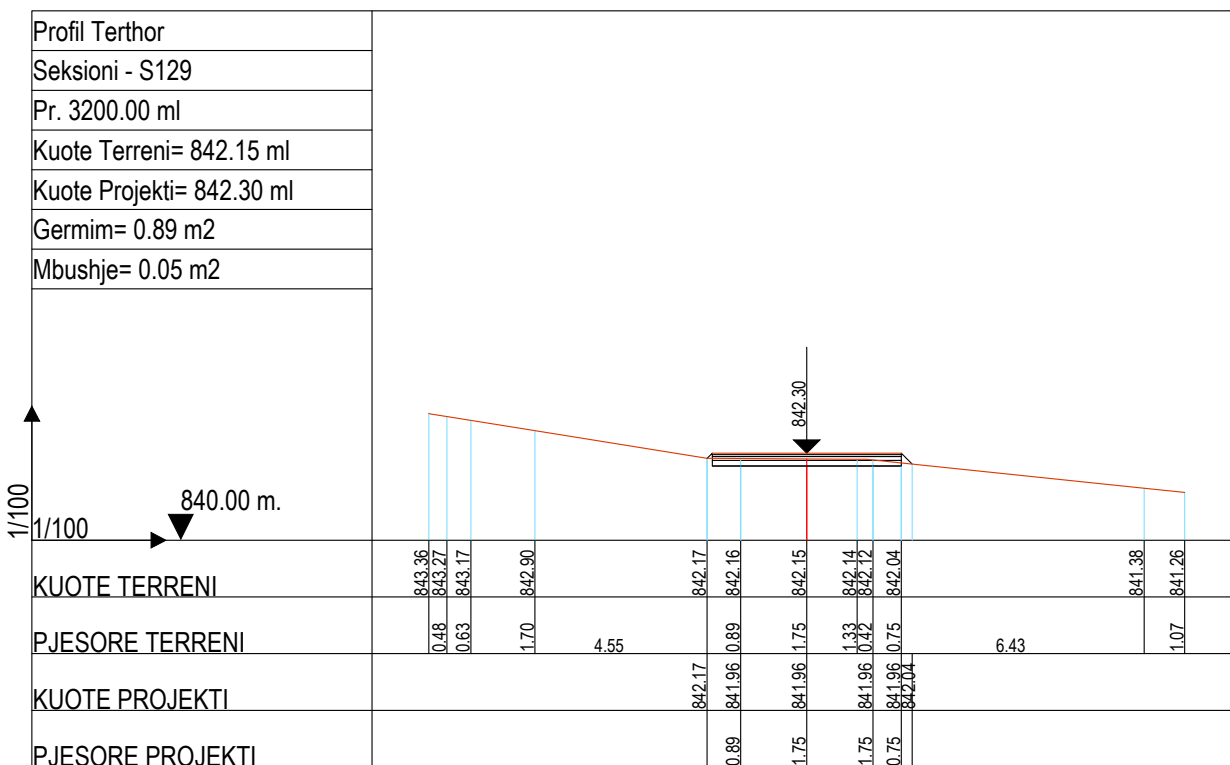
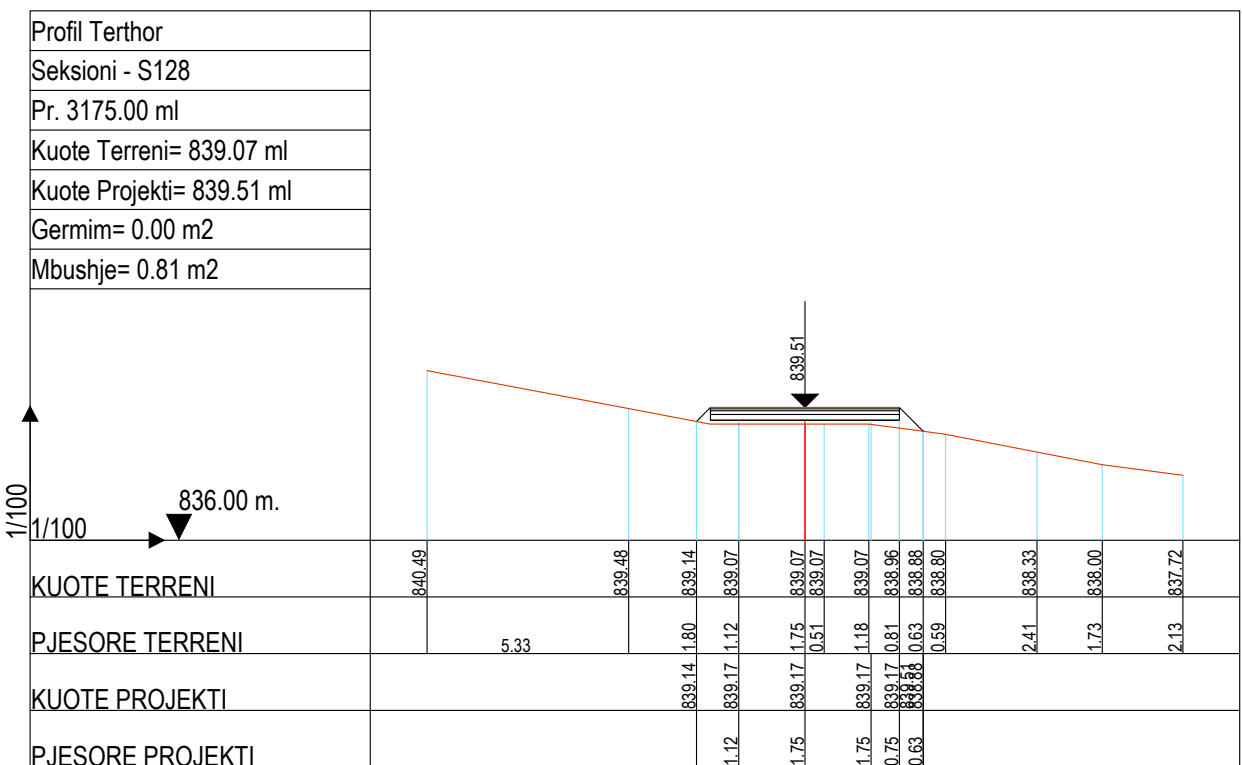
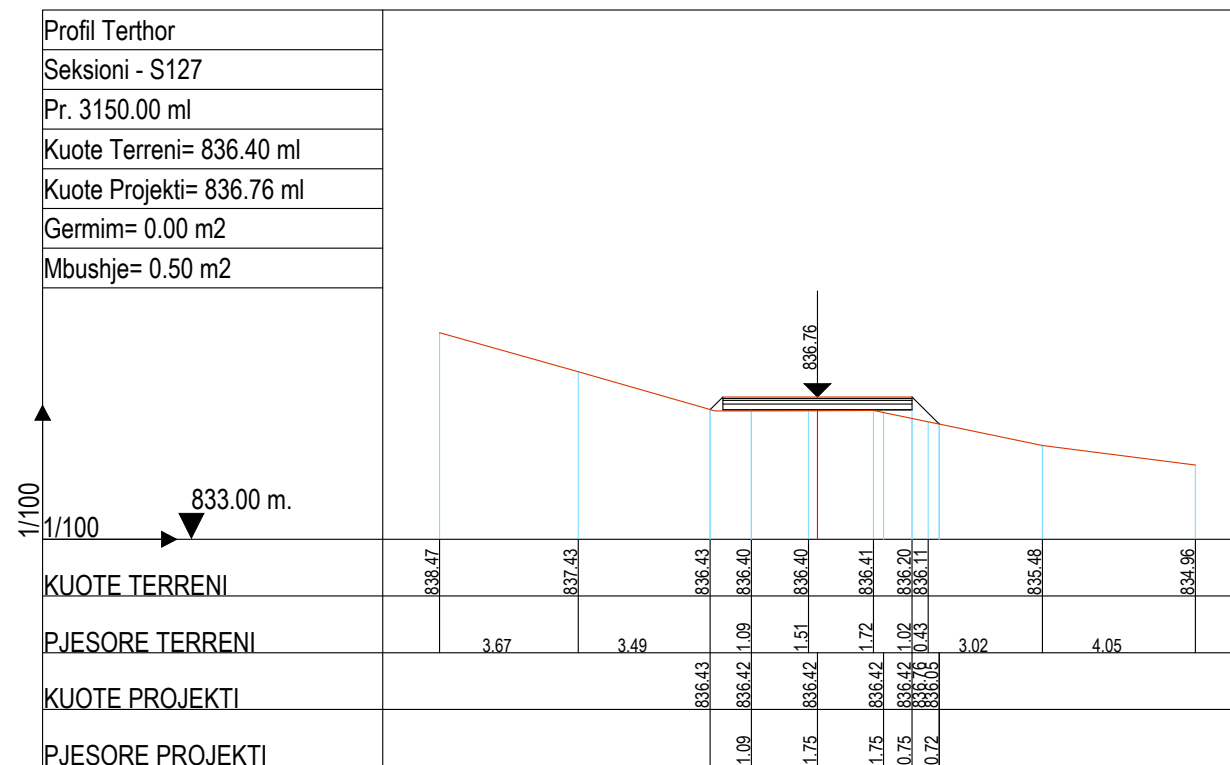
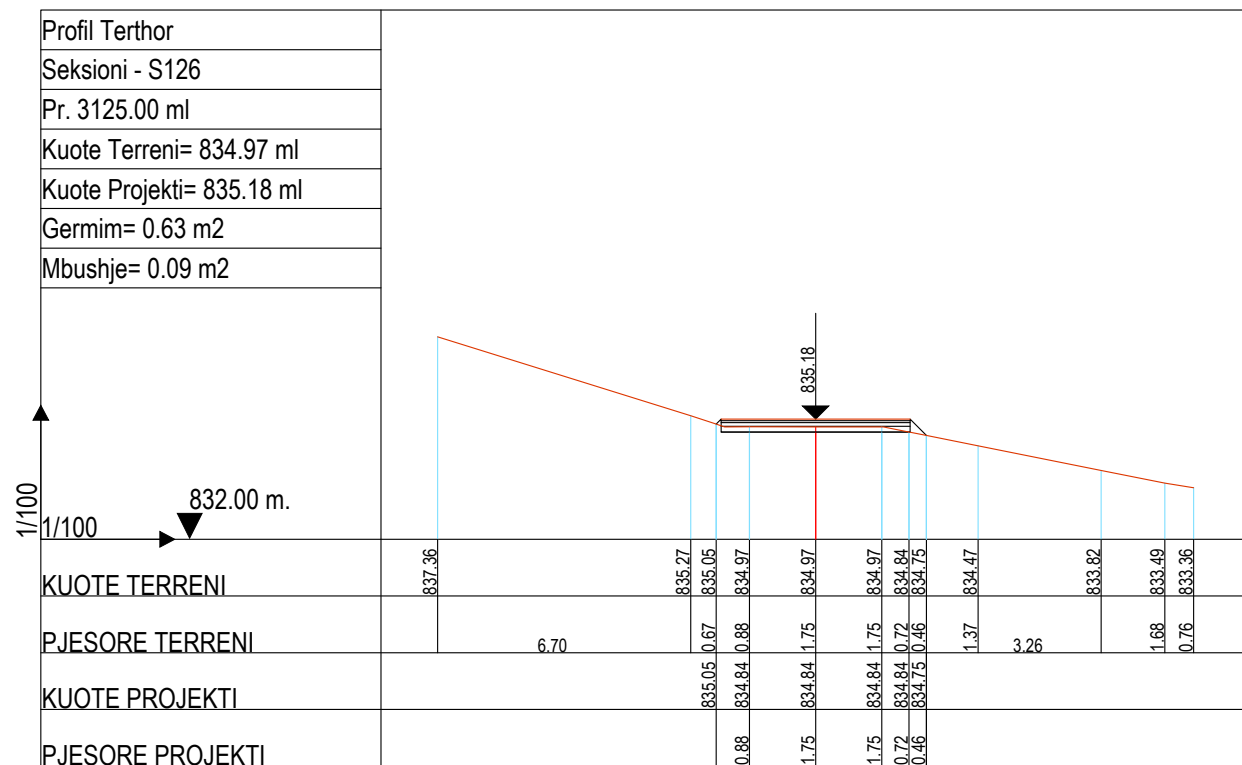

FOROSTITESH:

BASHKIA BULQIZE

EMERTIMI I PROJEKTTIT :

**SISTEM-ASFALTIM I RRUGES BLLACE,
LOTI I, N.J.A. SHUPENZE,
BASHKIA BULQIZE**

FAZA E PROJEKTTIT :

PROJEKT ZBATIMI

EMERTIMI I FLETES :

PROFILAT TERTHORE

SHKALLA 1:200	NR. FLETES 31
------------------	------------------

GRUPI I PROJEKTTIMIT : **"ALBGOLDING 2E" sh.p.k**

Ing. Hajredin MURGU

Ark. Soela MERKO

Ark. Erion MURGU



"ALBGOLDING 2E" sh.p.k

CONTACT:
E-MAIL : albgolding2@gmail.com
Cel: +355 68 52 07 550
+355 68 20 85 763

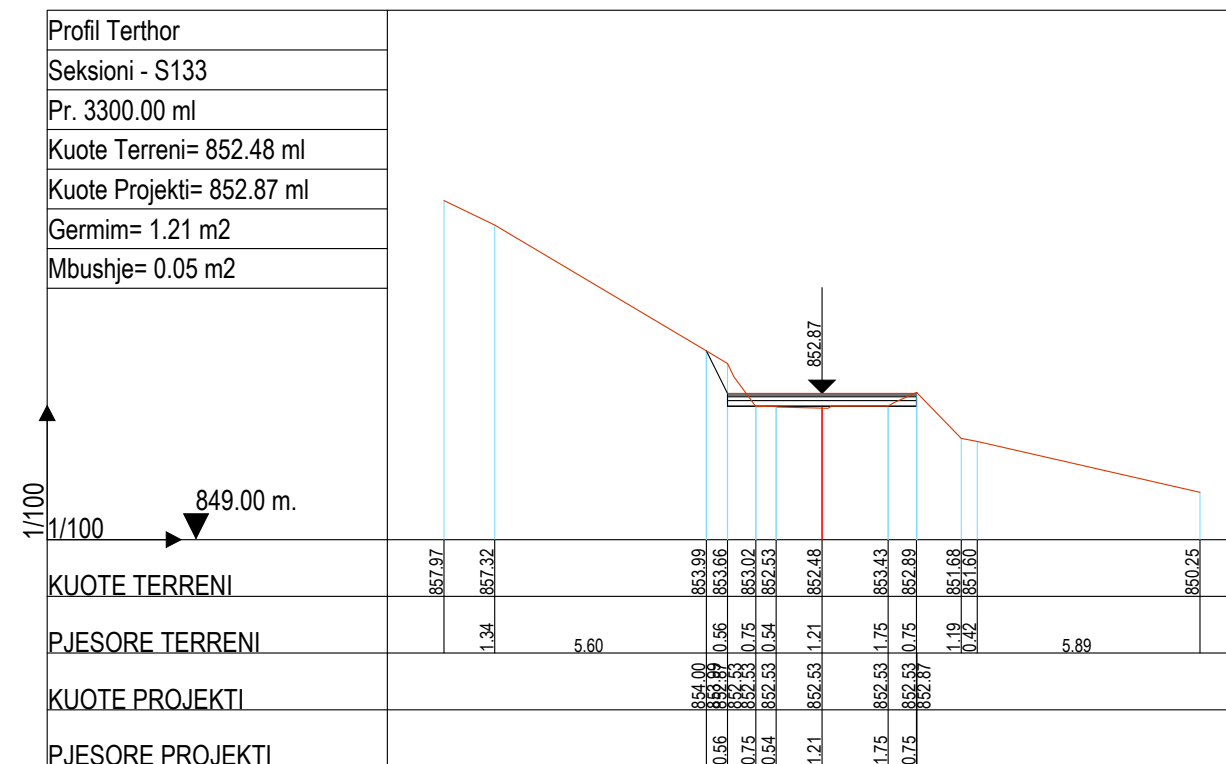
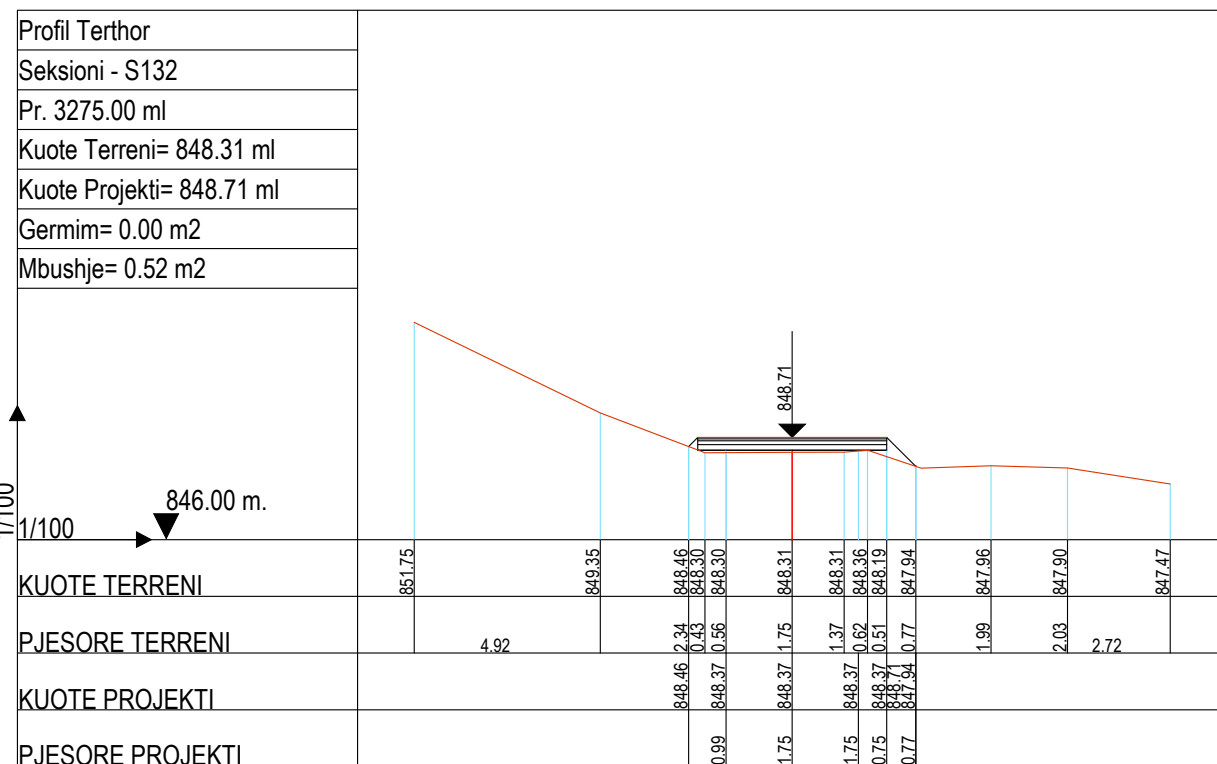
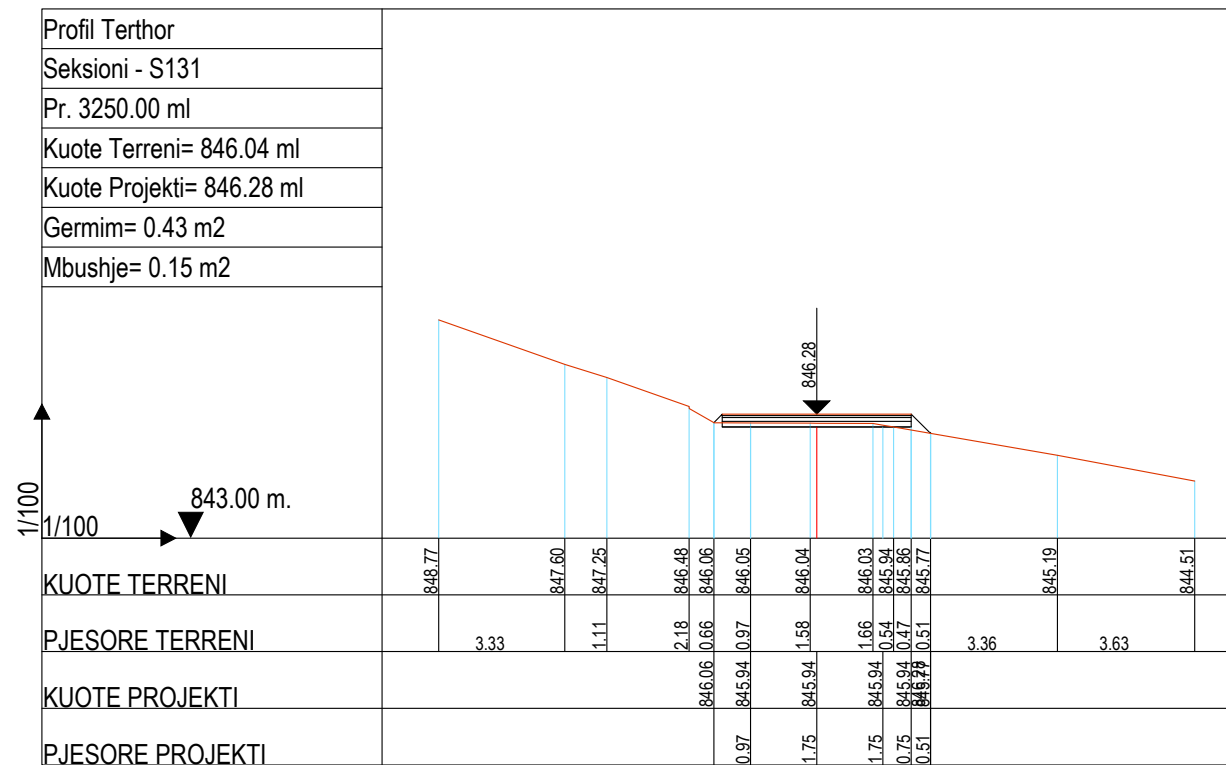
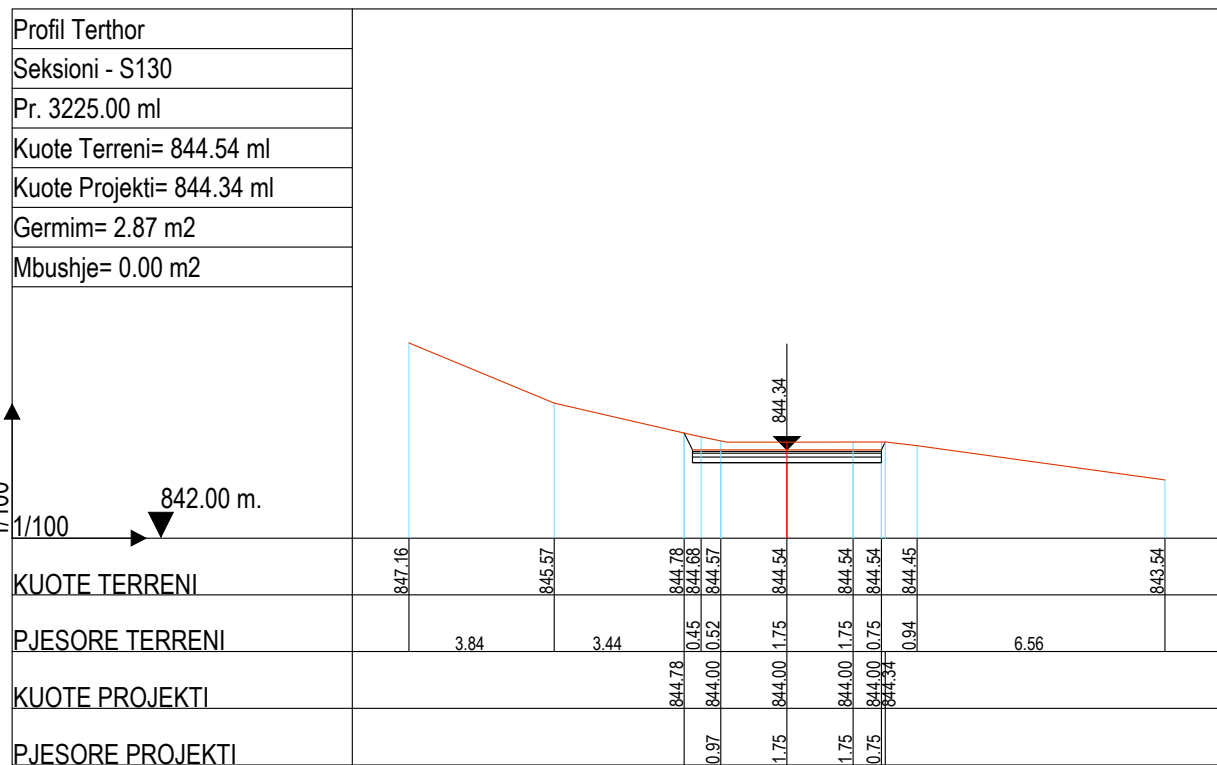

FOROSITESH:

BASHKIA BULQIZE

EMERTIMI I PROJEKTTIT :

**SISTEM-ASFALTIM I RRUGES BLLACE,
LOTI I, N.J.A. SHUPENZE,
BASHKIA BULQIZE**

FAZA E PROJEKTTIT :

PROJEKT ZBATIMI

EMERTIMI I FLETES :

PROFILAT TERTHORE

SHKALLA 1:200	NR. FLETES 32
------------------	------------------

GRUPI I PROJEKTTIMIT : **"ALBGOLDING 2E" sh.p.k**

Ing. Hajredin MURGU

Ark. Soela MERKO

Ark. Erion MURGU



"ALBGOLDING 2E" sh.p.k

CONTACT:
E-MAIL : albgolding2@gmail.com
Cel: +355 68 52 07 550
+355 68 20 85 763

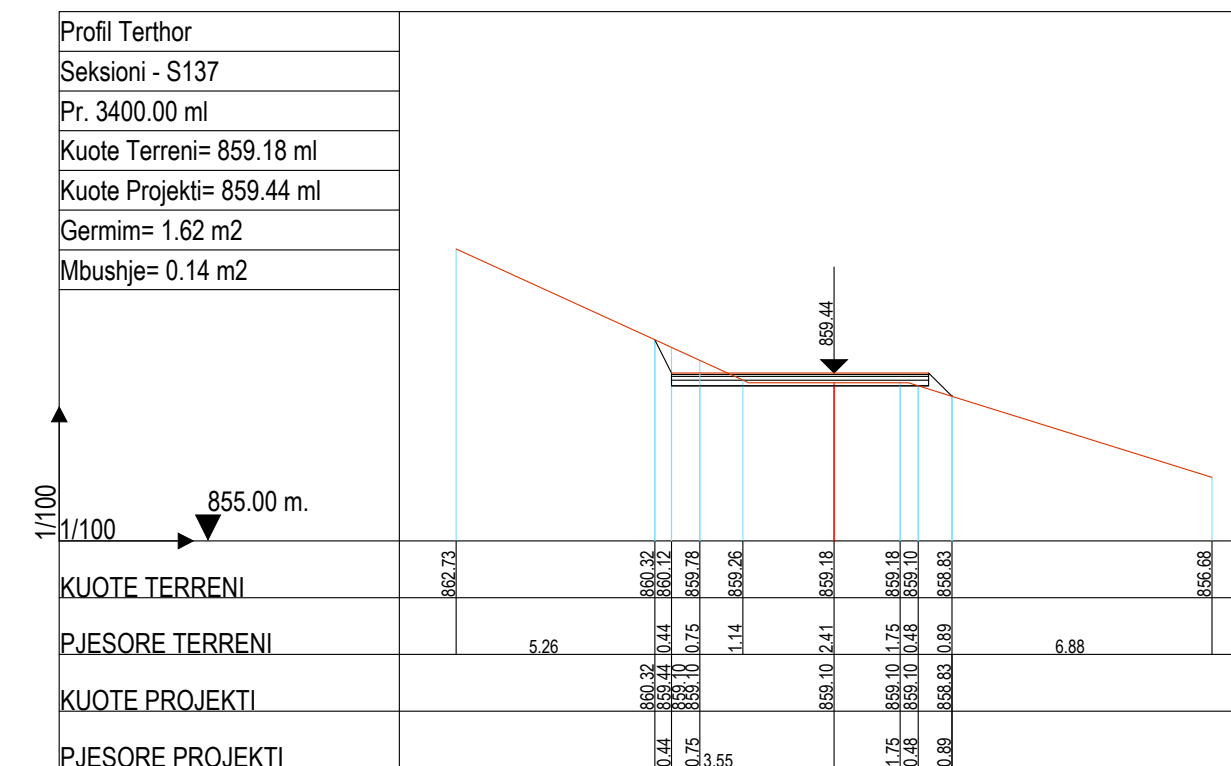
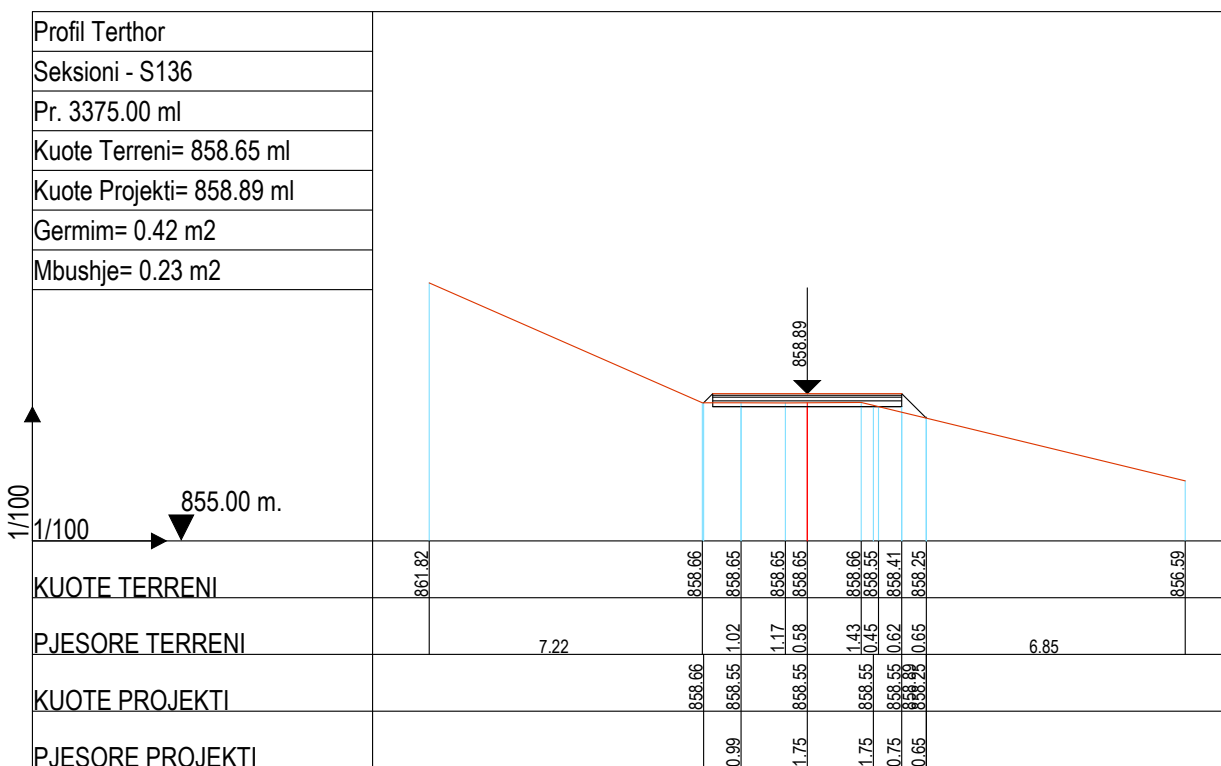
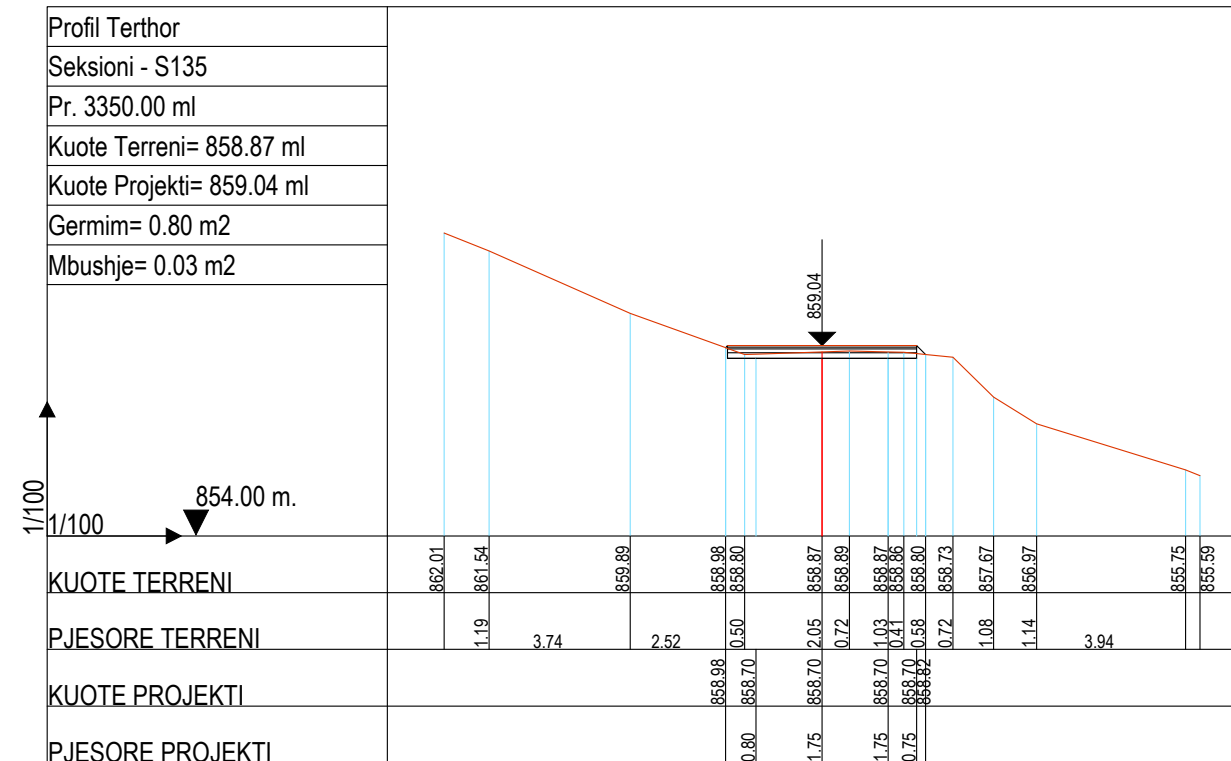
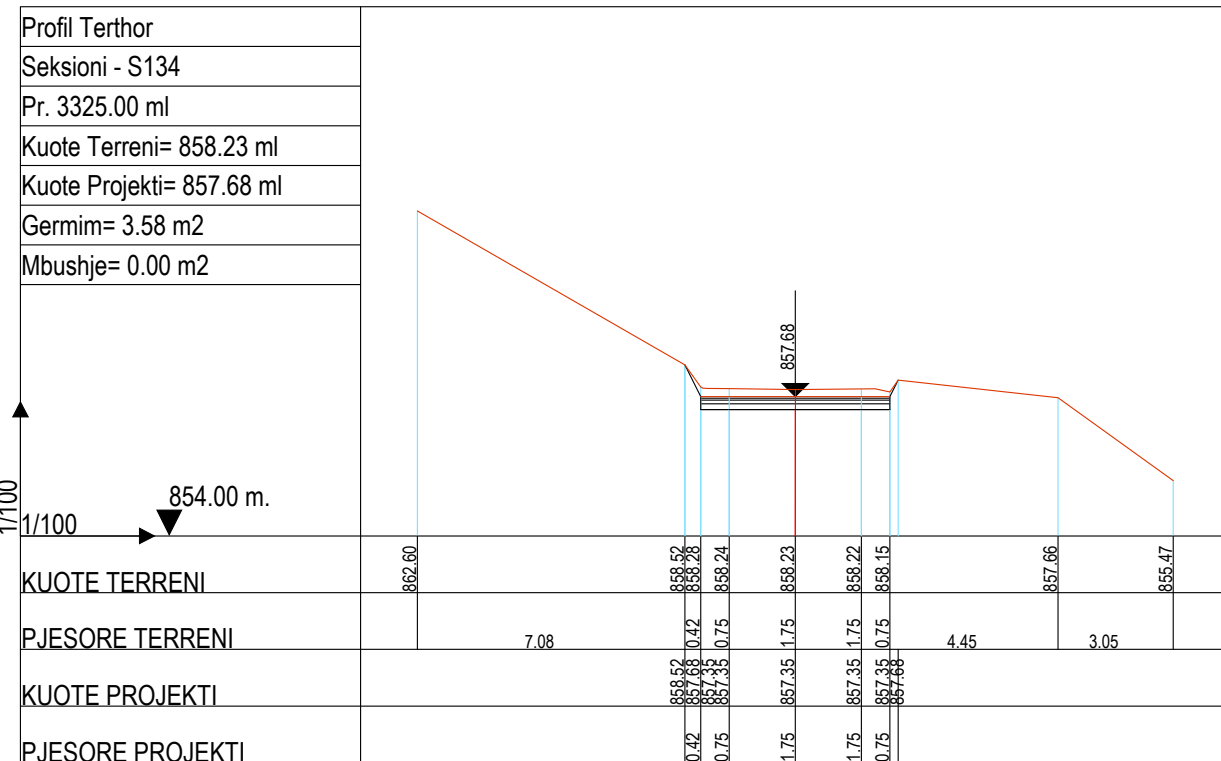

FOROSTITESH:

BASHKIA BULQIZE

EMERTIMI I PROJEKTTIT :

**SISTEM-ASFALTIM I RRUGES BLLACE,
LOTI I, N.J.A. SHUPENZE,
BASHKIA BULQIZE**

FAZA E PROJEKTTIT :

PROJEKT ZBATIMI

EMERTIMI I FLETES :

PROFILAT TERTHORE

SHKALLA 1:200	NR. FLETES 33
------------------	------------------

GRUPI I PROJEKTIMIT : **"ALBGOLDING 2E" sh.p.k**

Ing. Hajredin MURGU

Ark. Soela MERKO

Ark. Erion MURGU



"ALBGOLDING 2E" sh.p.k

CONTACT:
E-MAIL : albgolding2@gmail.com
Cel: +355 68 52 07 550
+355 68 20 85 763

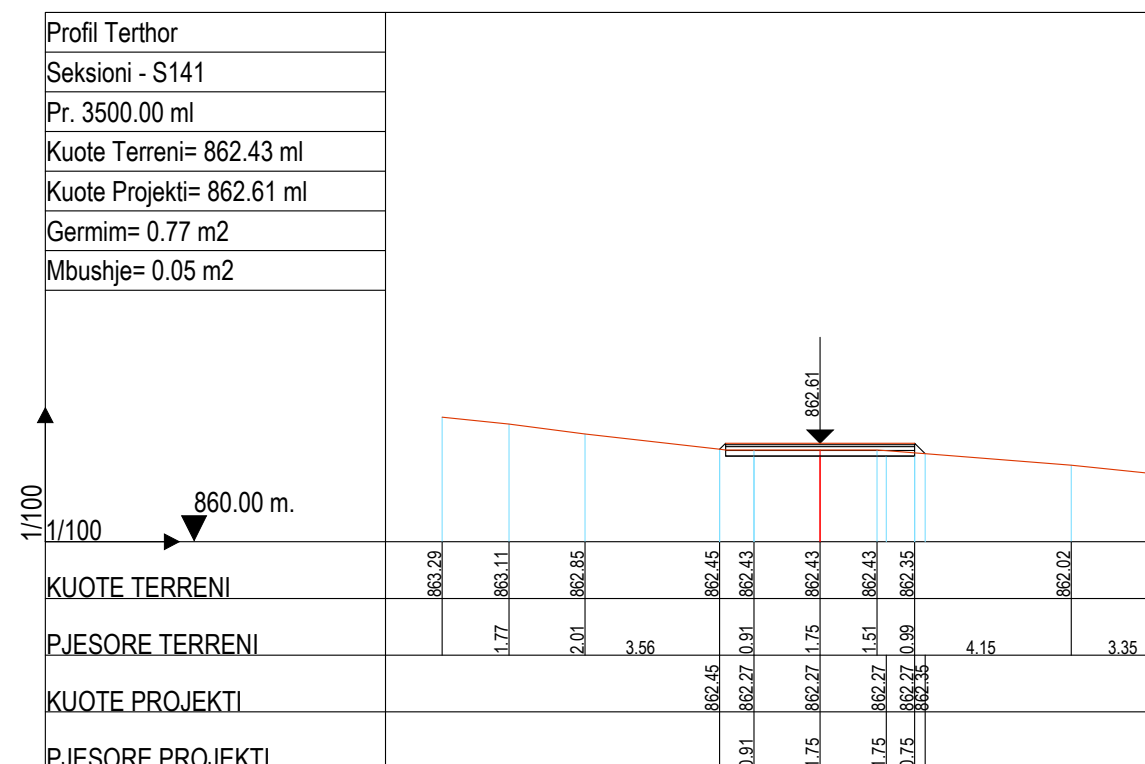
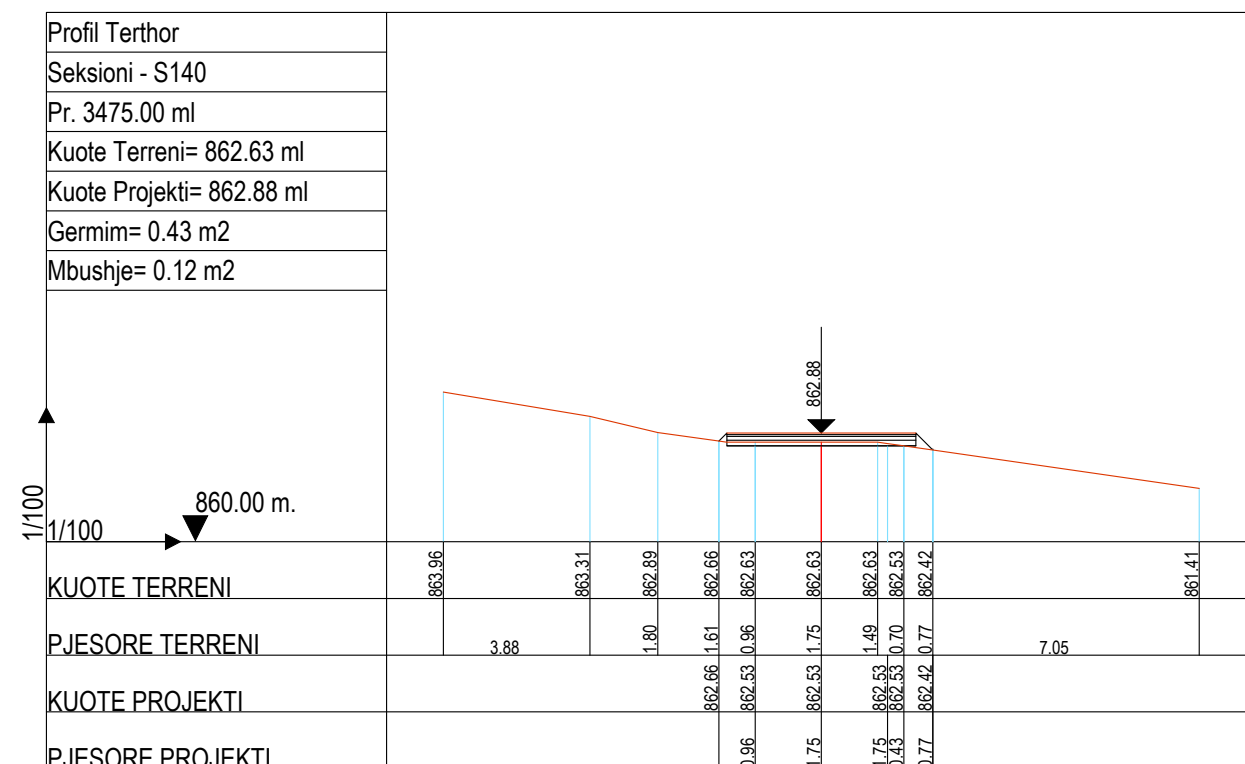
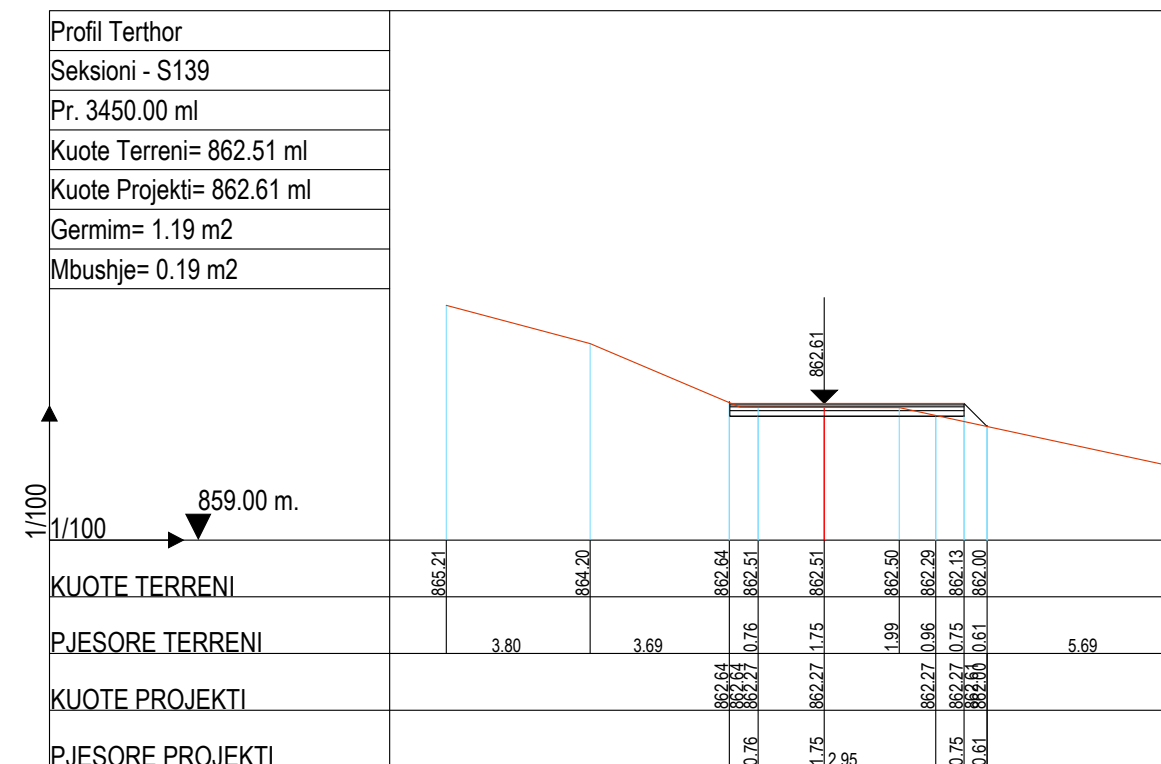
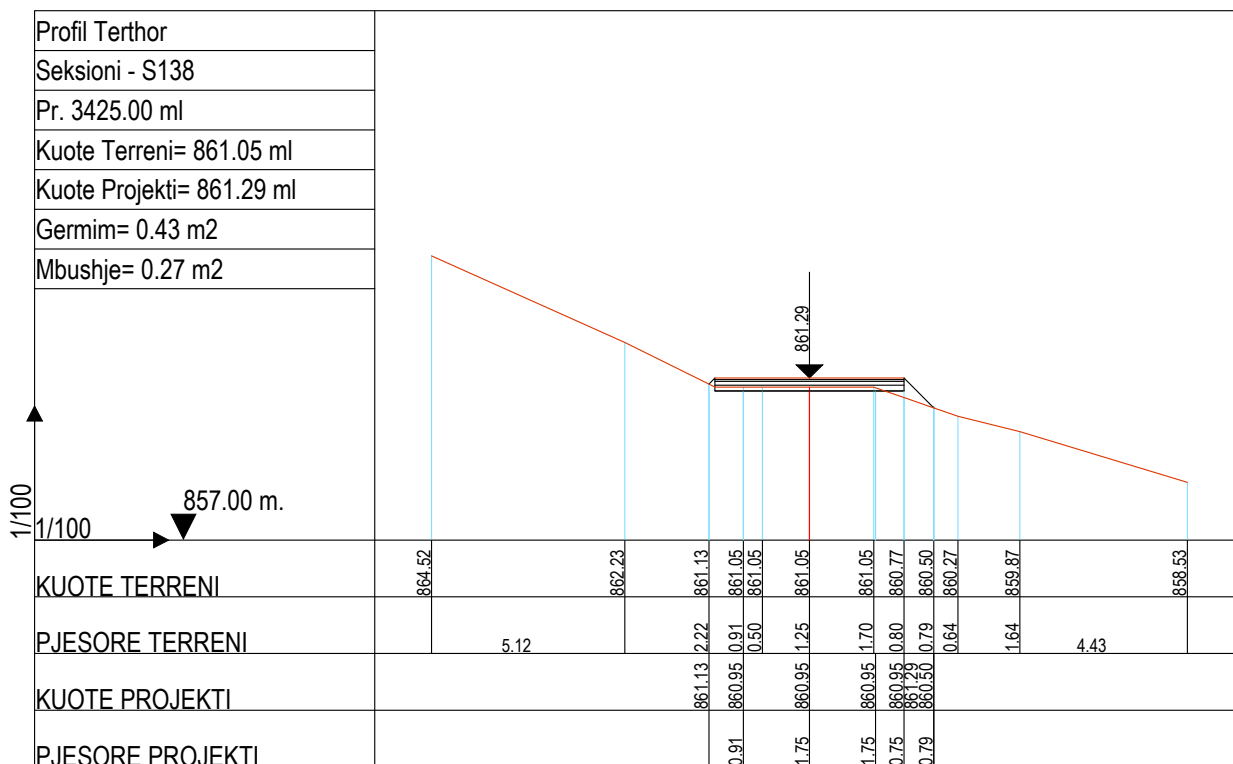

FOROSHTESI:

BASHKIA BULQIZE

EMERTIMI I PROJEKTTIT :

**SISTEM-ASFALTIM I RRUGES BLLACE,
LOTI I, N.J.A. SHUPENZE,
BASHKIA BULQIZE**

FAZA E PROJEKTTIT :

PROJEKT ZBATIMI

EMERTIMI I FLETES :

PROFILAT TERTHORE

SHKALLA 1:200	NR. FLETES 34
------------------	------------------

GRUPI I PROJEKTIMIT : **"ALBGOLDING 2E" sh.p.k**

Ing. Hajredin MURGU

Ark. Soela MERKO

Ark. Erion MURGU



"ALBGOLDING 2E" sh.p.k

CONTACT:
E-MAIL : albgolding2@gmail.com
Cel: +355 68 52 07 550
+355 68 20 85 763

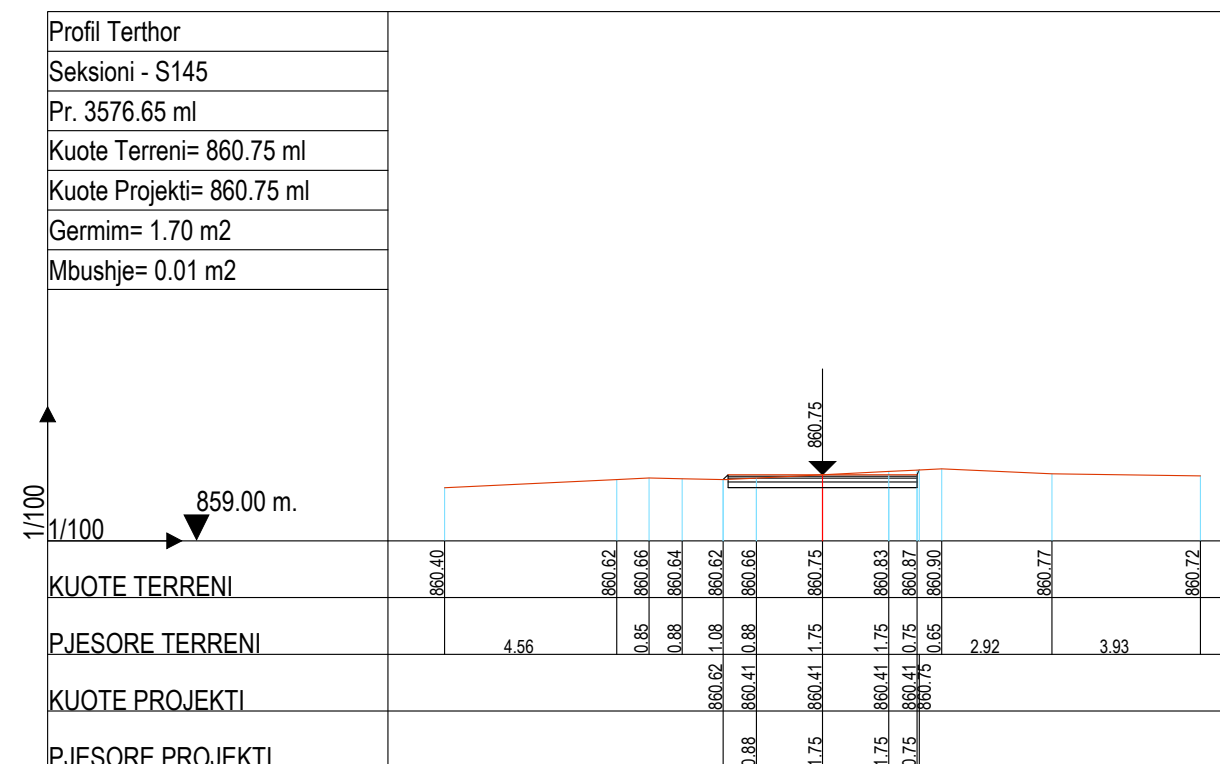
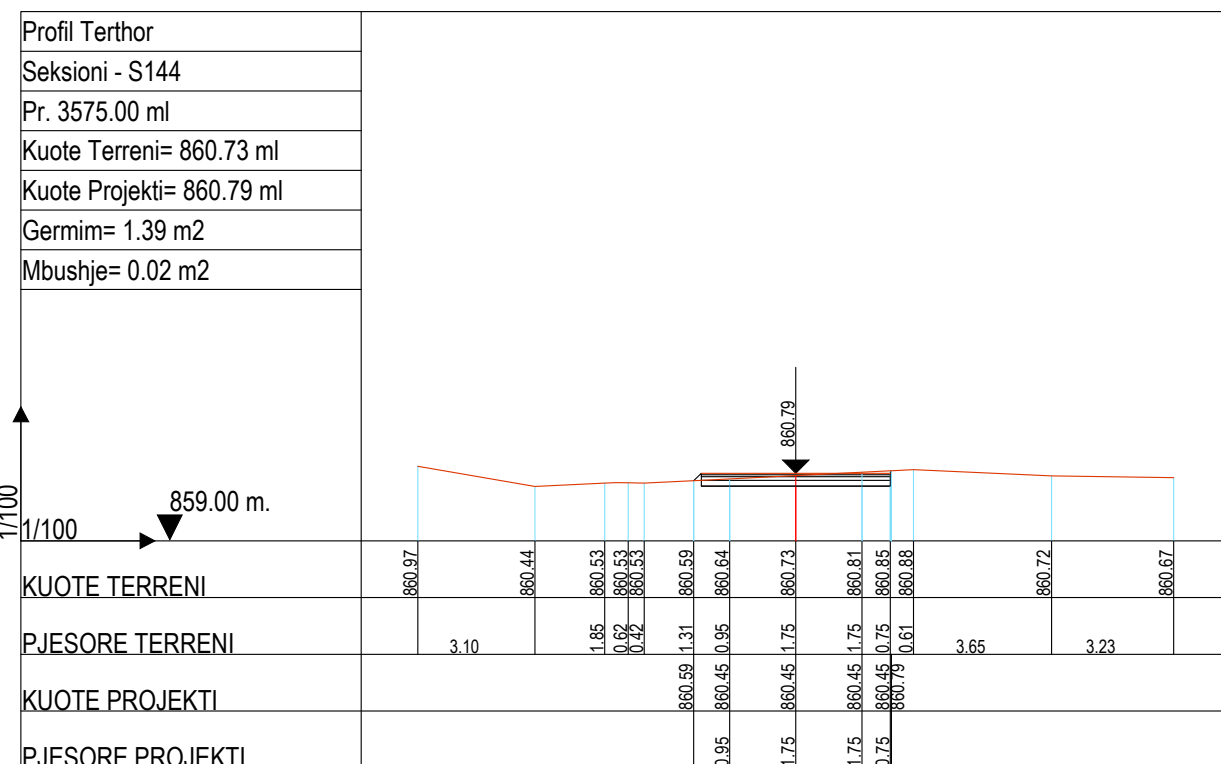
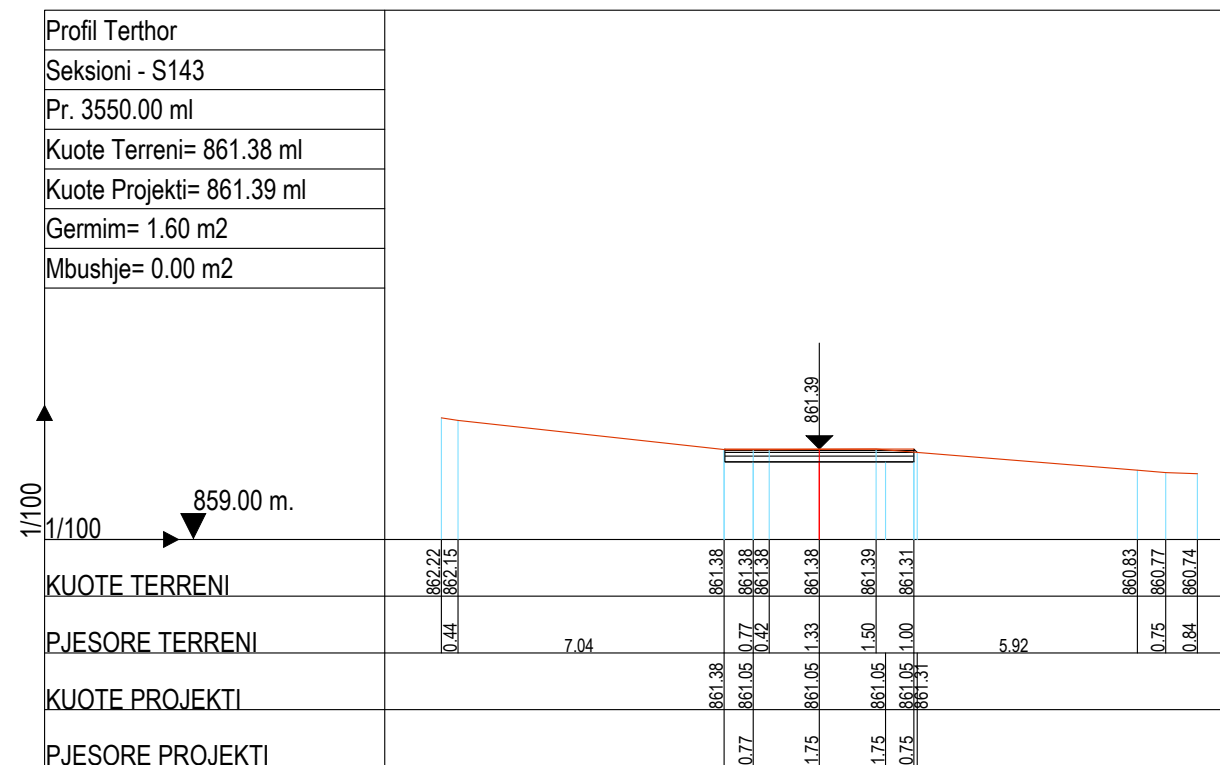
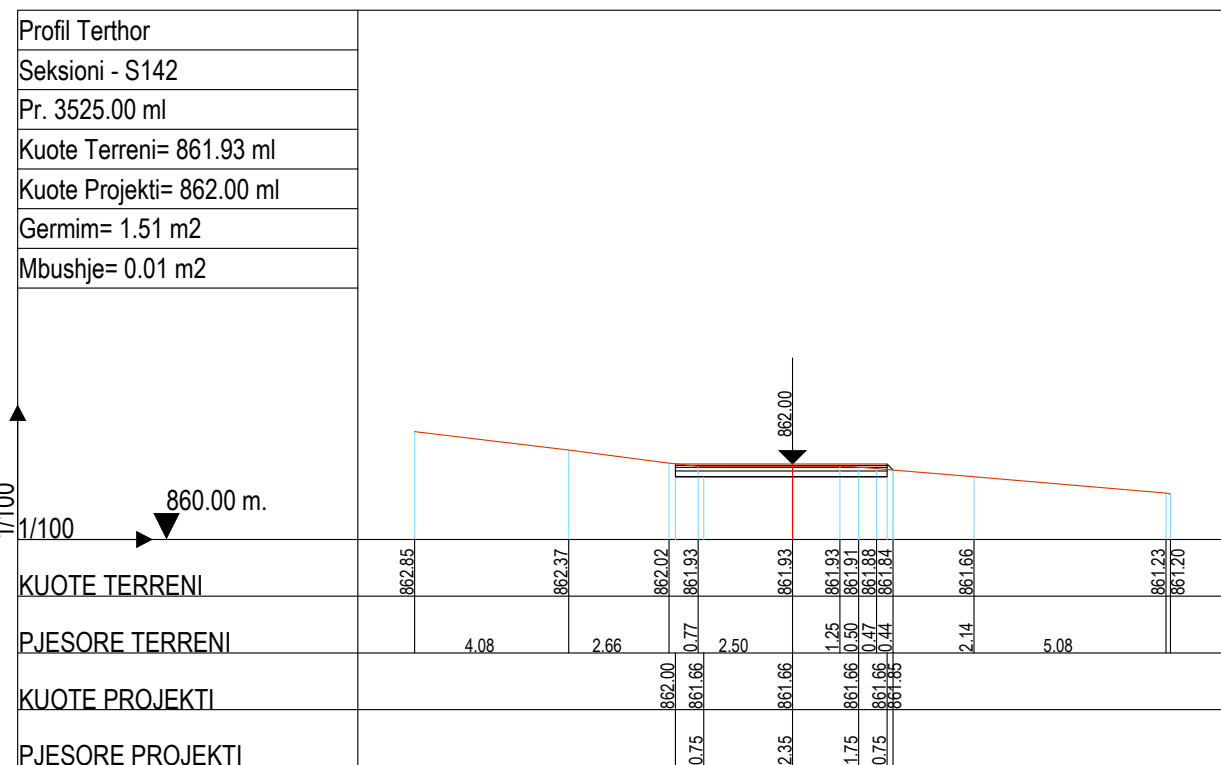

FOROSHTESI:

BASHKIA BULQIZE

EMERTIMI I PROJEKTTIT :

**SISTEM-ASFALTIM I RRUGES BLLACE,
LOTI I, N.J.A. SHUPENZE,
BASHKIA BULQIZE**

FAZA E PROJEKTTIT :

PROJEKT ZBATIMI

EMERTIMI I FLETES :

PROFILAT TERTHORE

SHKALLA 1:200	NR. FLETES 35
------------------	------------------

GRUPI I PROJEKTTIMIT : **"ALBGOLDING 2E" sh.p.k**

Ing. Hajredin MURGU

Ark. Soela MERKO

Ark. Erion MURGU



"ALBGOLDING 2E" sh.p.k

CONTACT:
E-MAIL : albgolding2@gmail.com
Cel: +355 68 52 07 550
+355 68 20 85 763

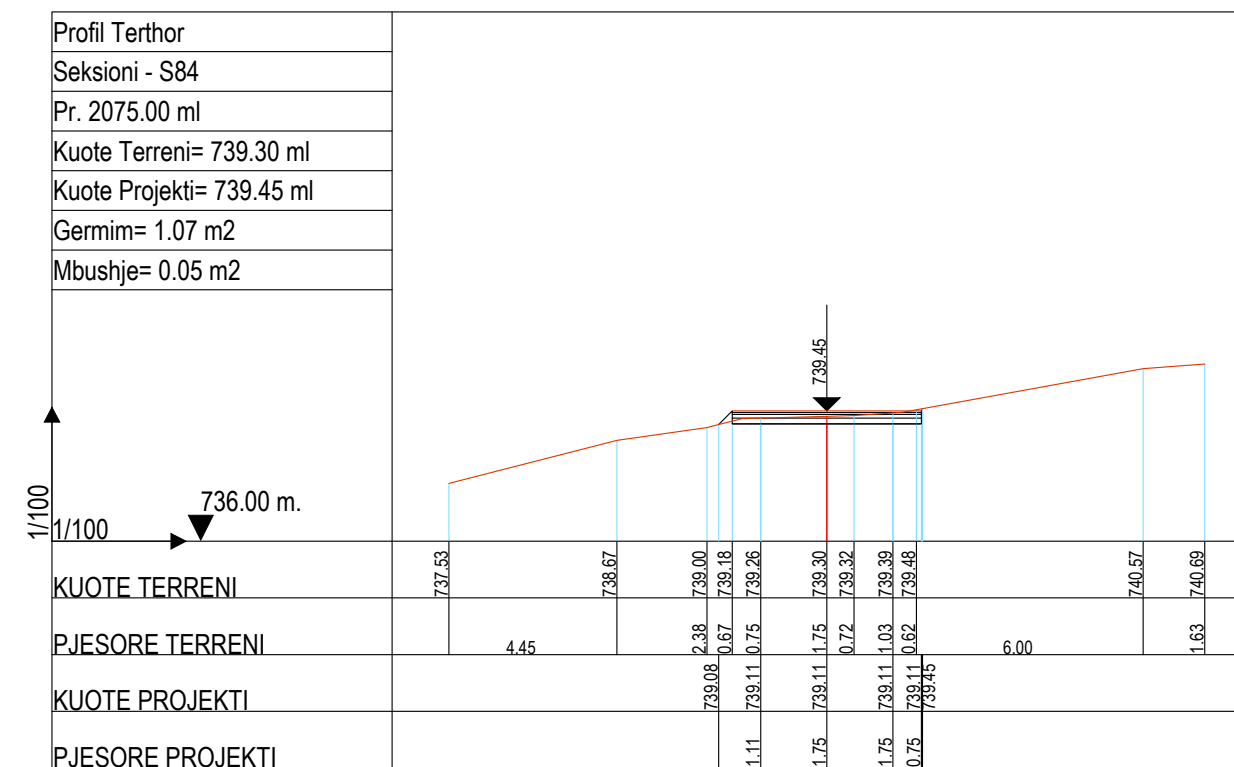
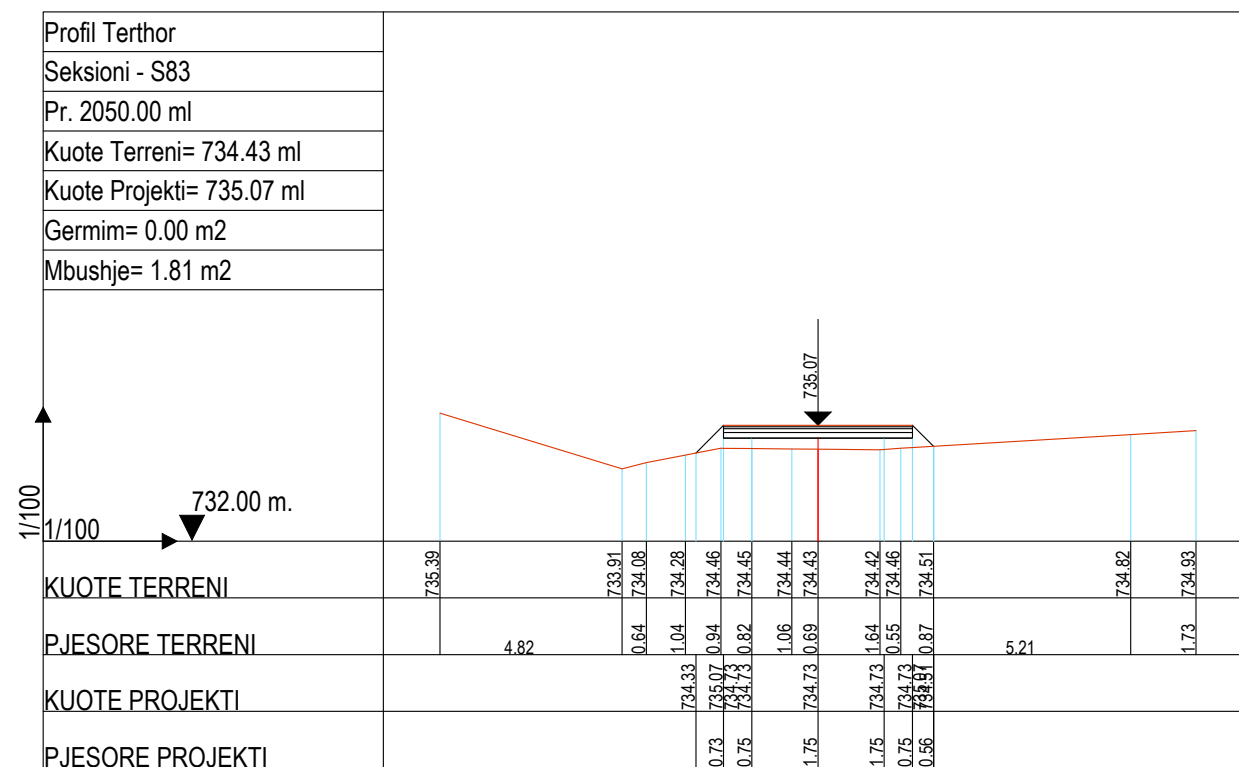
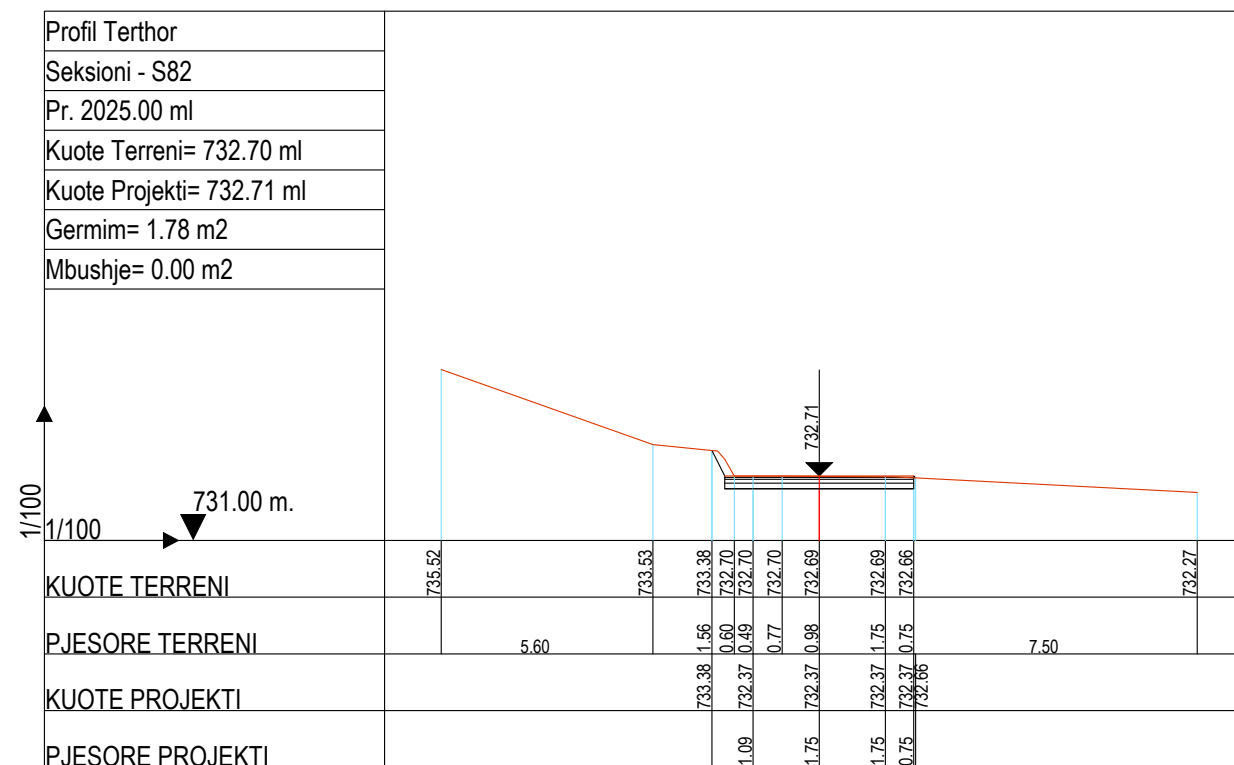
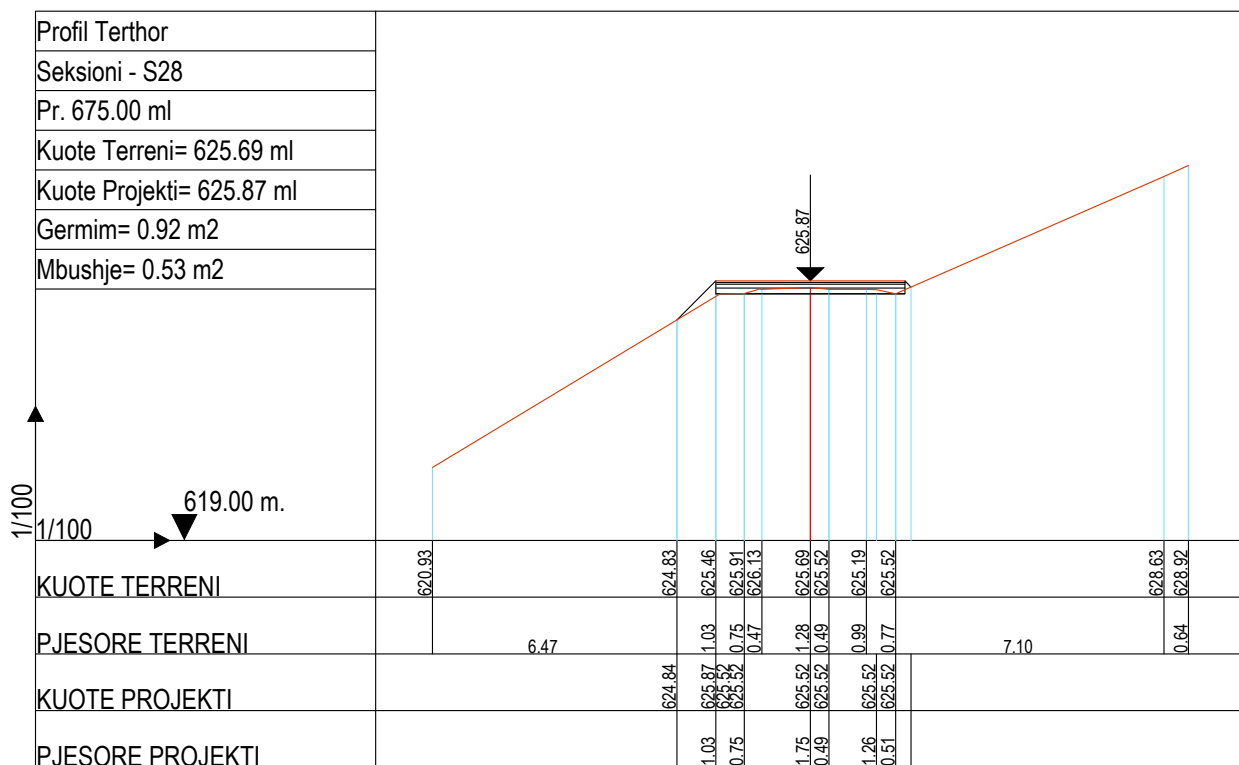

FOROSTITESH:

BASHKIA BULQIZE

EMERTIMI I PROJEKTTIT :

**SISTEM-ASFALTIM I RRUGES BLLACE,
LOTI I, N.J.A. SHUPENZE,
BASHKIA BULQIZE**

FAZA E PROJEKTTIT :

PROJEKT ZBATIMI

EMERTIMI I FLETES :

PROFILAT TERTHORE

SHKALLA 1:200	NR. FLETES 36
------------------	------------------

GRUPI I PROJEKTTIMIT : **"ALBGOLDING 2E" sh.p.k**

Ing. Hajredin MURGU

Ark. Soela MERKO

Ark. Erion MURGU



"ALBGOLDING 2E" sh.p.k

CONTACT:
E-MAIL : albgolding2@gmail.com
Cel: +355 68 52 07 550
+355 68 20 85 763

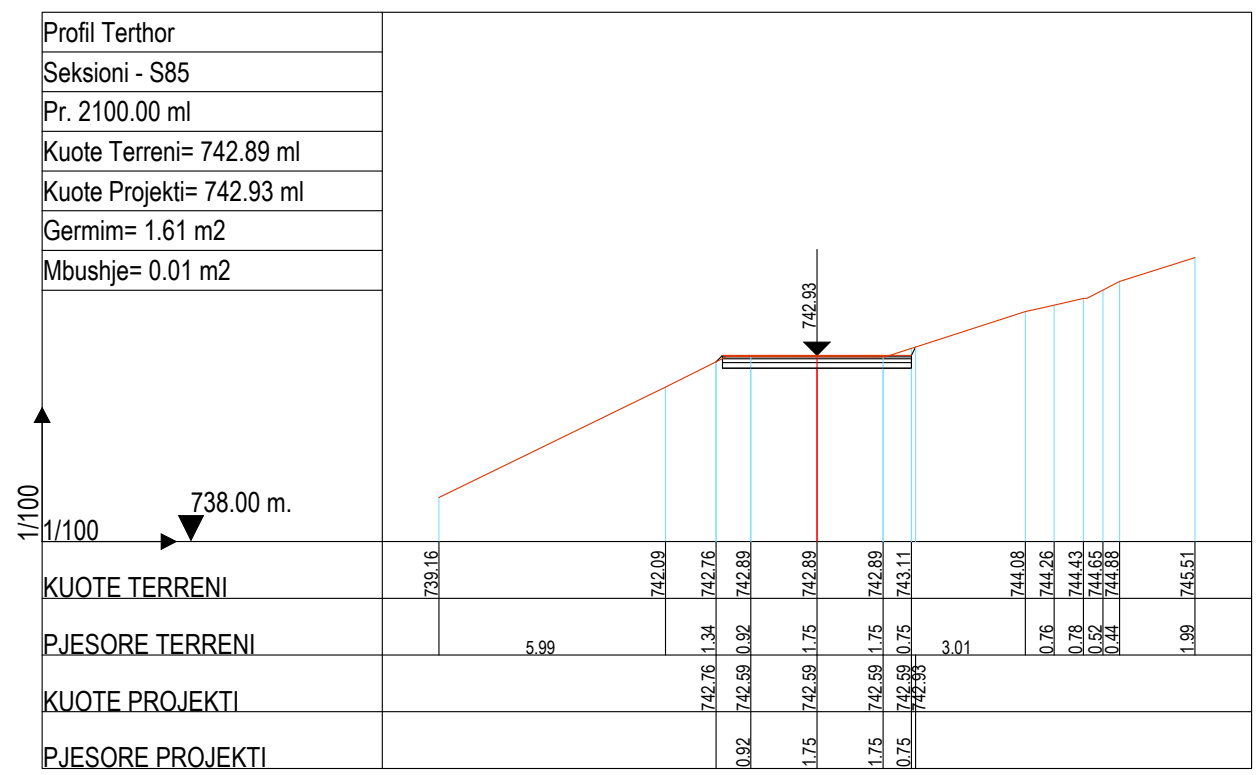

FOROSITESH:

BASHKIA BULQIZE

EMERTIMI I PROJEKTTIT :

**SISTEM-ASFALTIM I RRUGES BLLACE,
LOTI I, N.J.A. SHUPENZE,
BASHKIA BULQIZE**

FAZA E PROJEKTTIT :

PROJEKT ZBATIMI

EMERTIMI I FLETES :

PROFILAT TERTHORE

SHKALLA 1:200	NR. FLETES 37
------------------	------------------

GRUPI I PROJEKTIMIT : "ALBGOLDING 2E" sh.p.k

Ing. Hajredin MURGU

Ark. Soela MERKO

Ark. Erion MURGU



"ALBGOLDING 2E" sh.p.k

CONTACT:
E-MAIL : albgolding2@gmail.com
Cel: +355 68 52 07 550
+355 68 20 85 763



REPUBLIKA E SHQIPERISE
QARKU DIBER
BASHKIA BULQIZE

PROJEKT ZBATIMI

OBJEKTI:
SISTEM-ASFALTIM I RRUGES BLLACE, LOTI I,
NJ.A. SHUPENZE, BASHKIA BULQIZE

DETAJET E RRUGES

FOROSITESH:

BASHKIA BULQIZE

EMERTIMI I PROJEKTTIT :

**SISTEM-ASFALTIM I RRUGES BLLACE,
LOTI I, NJ.A. SHUPENZE,
BASHKIA BULQIZE**

FAZA E PROJEKTTIT :

PROJEKT ZBATIMI

EMERTIMI I FLETES :

KAPAKU

SHKALLA
1:1000

NR. FLETES

GRUPI I PROJEKTIMIT :

"ALBGOLDING 2E" sh.p.k

Ing. Hajredin MURGU

Ark. Soela MERKO

Ark. Erion MURGU



"ALBGOLDING 2E" sh.p.k

CONTACT:

E-MAIL : albgolding2@gmail.com

Cel: +355 68 52 07 550

+355 68 20 85 763

TOMBINO Ø 1500



REPUBLIKA E SHQIPERISE
QARKU DIBER
BASHKIA BULQIZE

DALJE

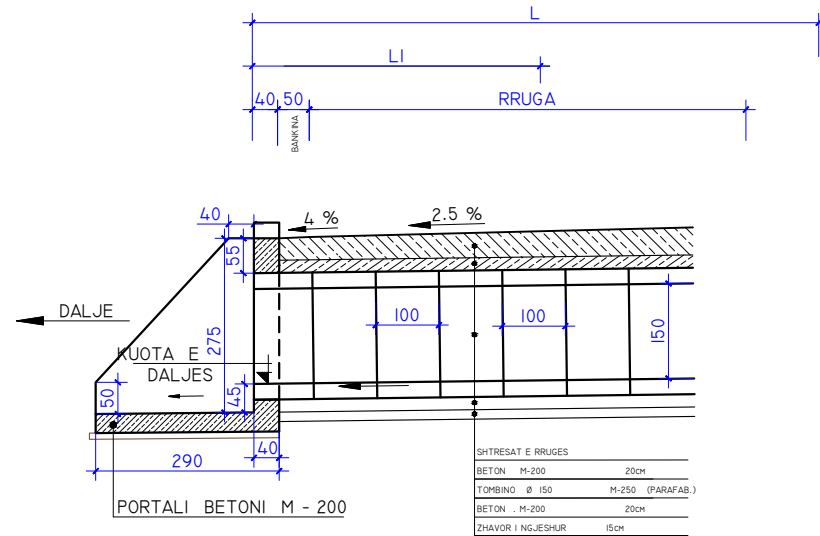

HYRJA

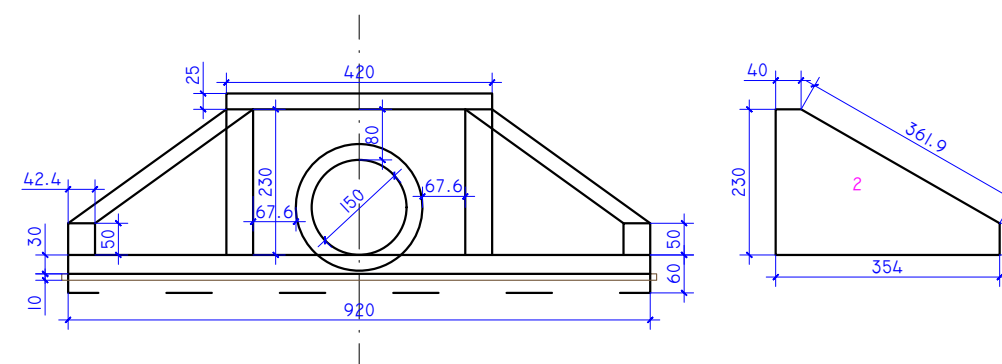
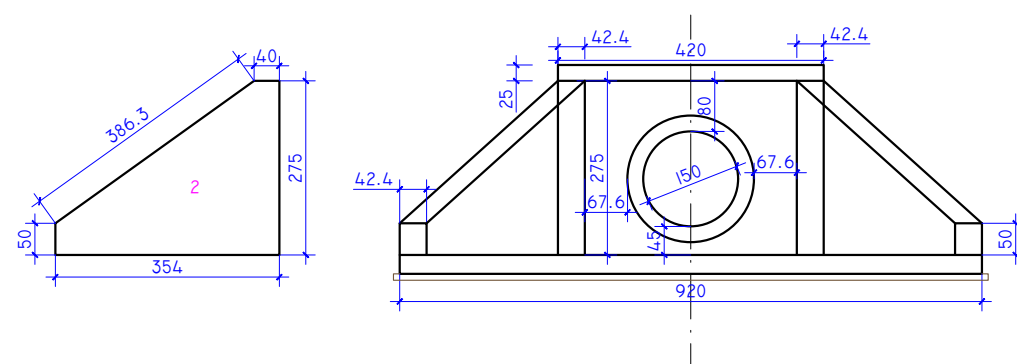
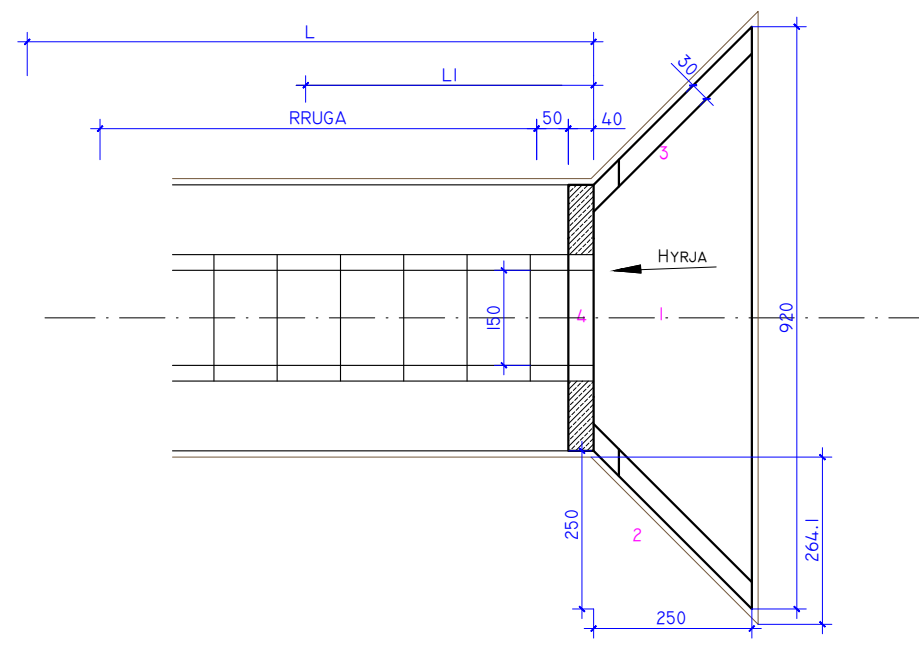
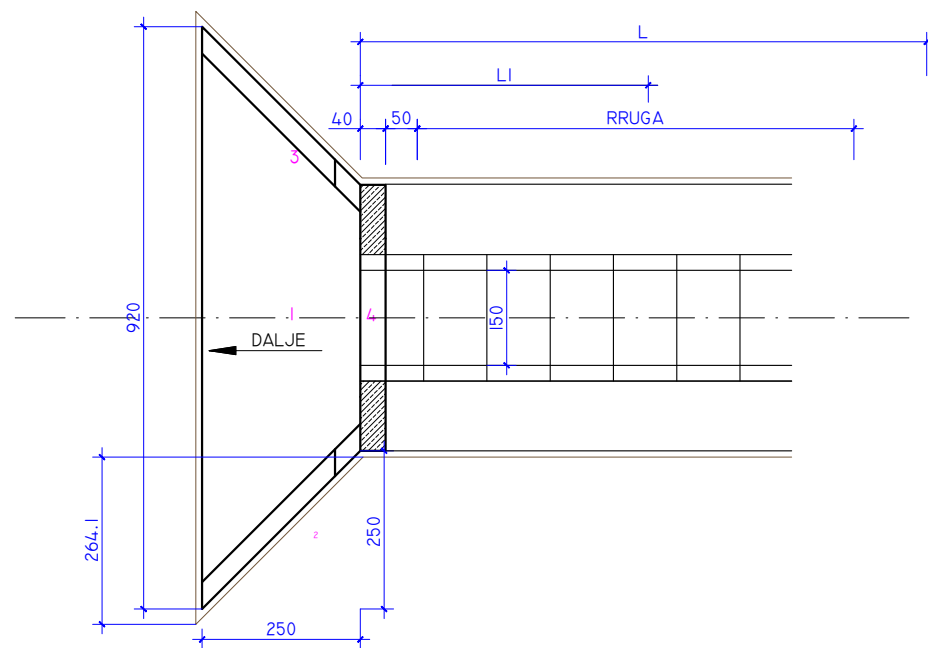
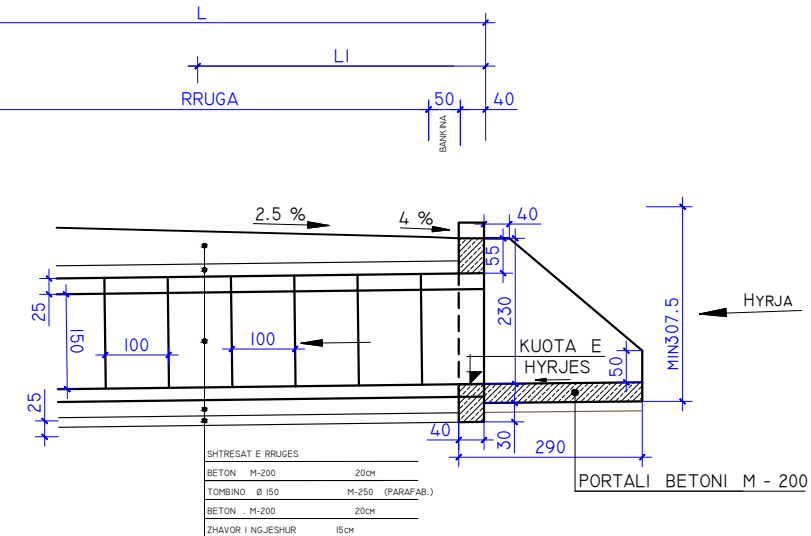

FOROSITESH:

BASHKIA BULQIZE

EMERTIMI I PROJEKTTIT :
**SISTEM-ASFALTIM I RRUGES BLLACE,
LOTI I, NJ.A. SHUPENZE,
BASHKIA BULQIZE**

FAZA E PROJEKTTIT :

PROJEKT ZBATIMI

EMERTIMI I FLETES :

DETAJET E RRUGES

SHKALLA 1:50	NR. FLETES 01
-----------------	------------------

GRUPI I PROJEKTTIMIT : "ALBGOLDING 2E" sh.p.k

Ing. Hajredin MURGU
Ark. Soela MERKO
Ark. Erion MURGU

"ALBGOLDING 2E" sh.p.k
CONTACT:
E-MAIL : albgolding2@gmail.com
Cel: +355 68 52 07 550
+355 68 20 85 763



MURE BETONI
H=1.5m

Plani i Munt b/a të portalit të pjerrët të tombinos Ø600mm, Sh. 1:25

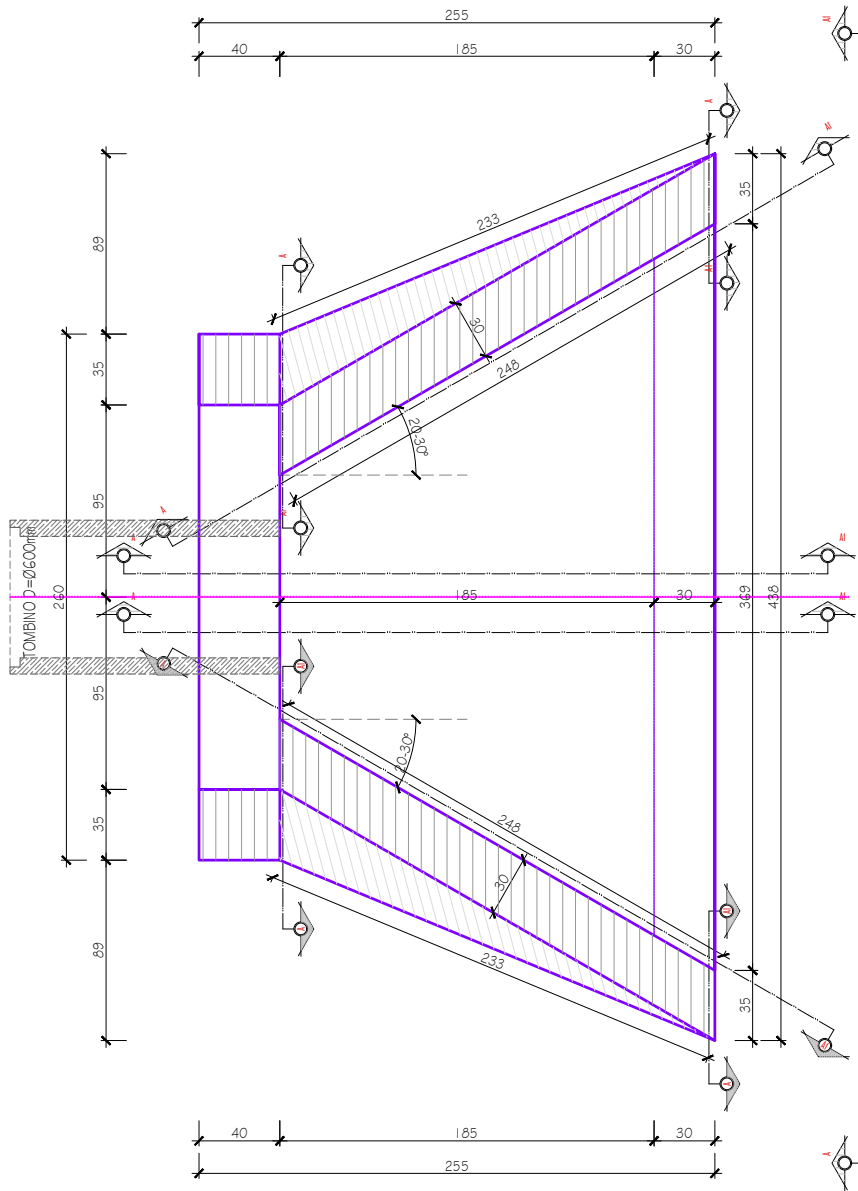

Pamja 3-3
e Munt b/a të portalit të pjerrët të tombinos Ø600mm, Sh. 1:25

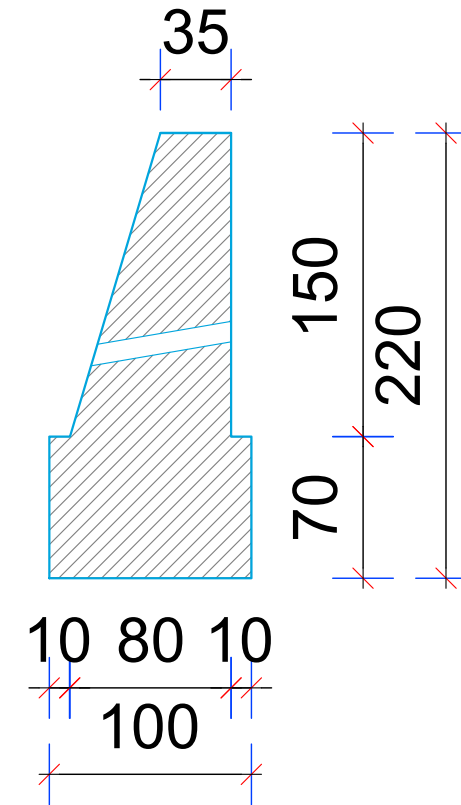
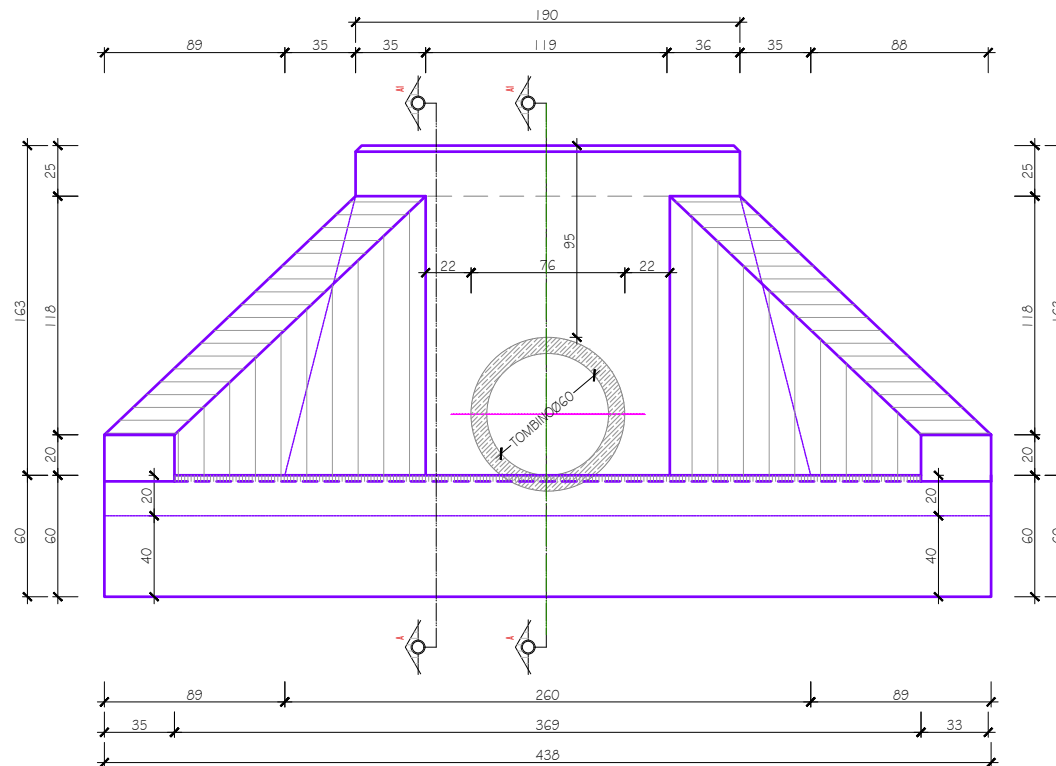

Prenja 2-2
e Munt b/a të portalit të pjerrët të tombinos Ø600mm, Sh. 1:25

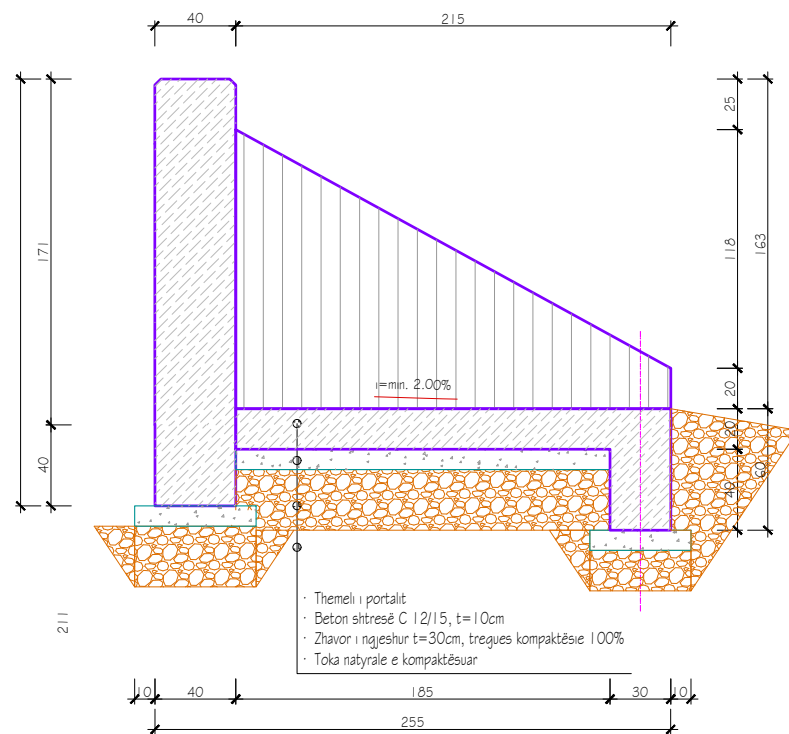

Prenja 1-1
e Munt b/a të portalit të pjerrët të tombinos Ø600mm, Sh. 1:25

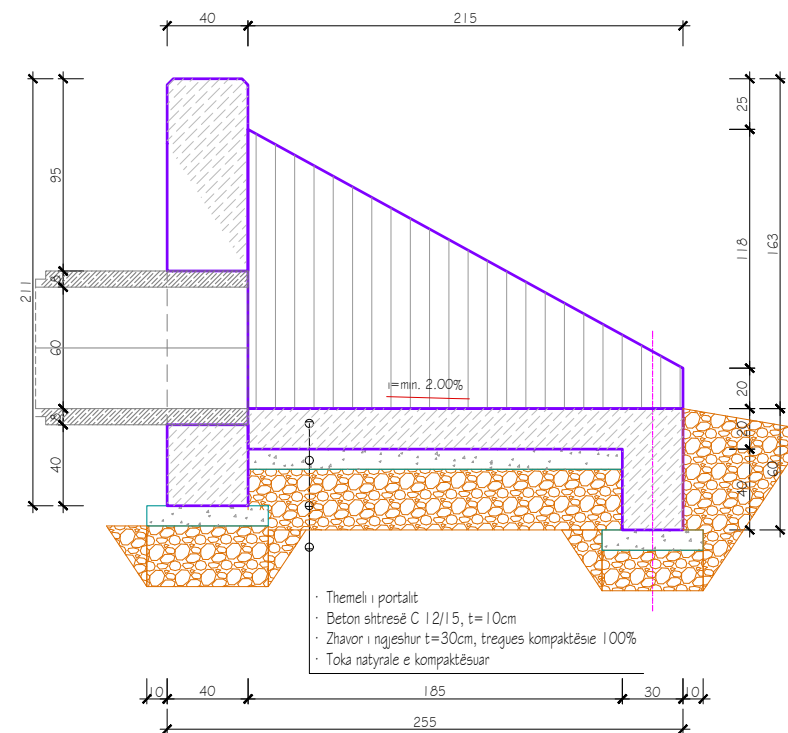

- Themeli i portalit
- Beton shtresë C 12/15, t=10cm
- Zhavor i ngjeshur t=30cm, tregues kompaktësie 100%
- Toka natyrale e kompaktësuar

- Themeli i portalit
- Beton shtresë C 12/15, t=10cm
- Zhavor i ngjeshur t=30cm, tregues kompaktësie 100%
- Toka natyrale e kompaktësuar

FORORSTESI:

BASHKIA BULQIZE

EMERTIMI I PROJEKTTIT:

**SISTEM-ASFALTIM I RRUGES BLLACE,
LOTI I, NJ.A. SHUPENZE,
BASHKIA BULQIZE**

FAZA E PROJEKTTIT:

PROJEKT ZBATIMI

EMERTIMI I FLETES:

DETAJET E RRUGES

SHKALLA 1:50	NR. FLETES 03
-----------------	------------------

GRUPI I PROJEKTTIMIT: "ALBGOLDING 2E" sh.p.k

Ing. Hajredin MURGU

Ark. Soela MERKO

Ark. Erion MURGU



"ALBGOLDING 2E" sh.p.k

CONTACT:
E-MAIL: albgolding2@gmail.com
Cel: +355 68 52 07 550
+355 68 20 85 763



SHENJA LAJMERUESE

LAJMERIM PER NDERPRERJE NGA RRUGE DYTESORE, KTHESAT E KURBEZUARA, FEMIJET, KEMBESORET DHE PER NDALJE/DHENIE RRUGE

TREKENDESHI: E KUQE REFLEKTUESE
SFONDI: I ZI
SYMBOLI: E BARDHE REFLEKTUESE

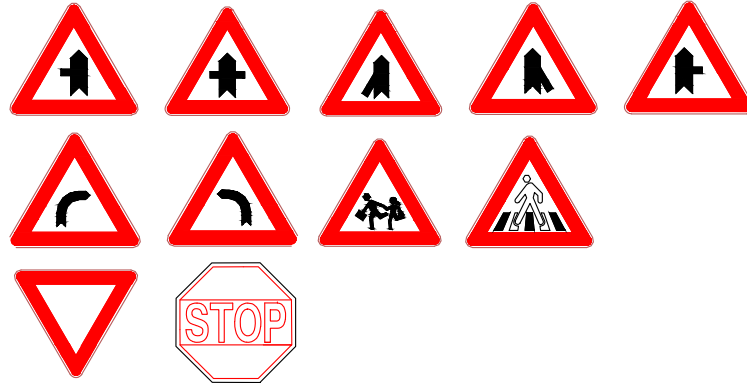

PERMASAT E SHENJAVE STANDARTE

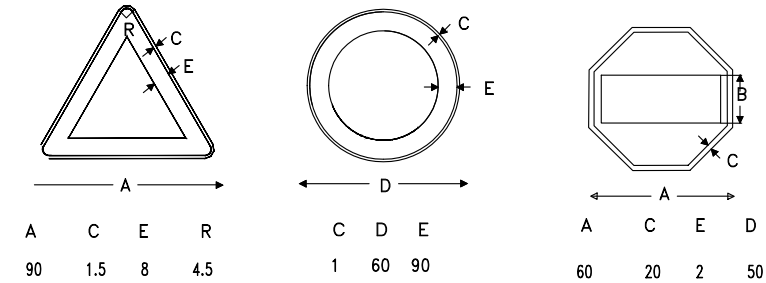

SHENJA NDALUESE

SHENJAT PER KUFIRIN E SHPEJTESISE DHE NDALIM PARAKALIMIN

RRETHI: E KUQE REFLEKTUESE
SHENJA: E ZEZE REFLEKTUESE

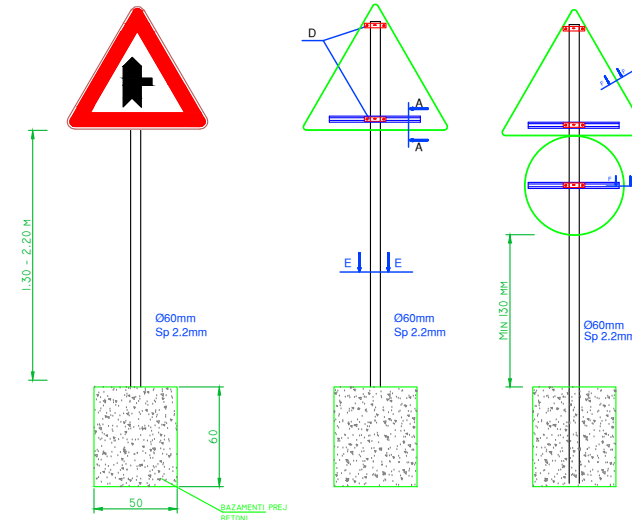
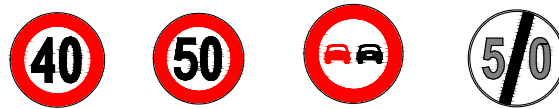

TIPET E VIZIMEVE TE RRUGES

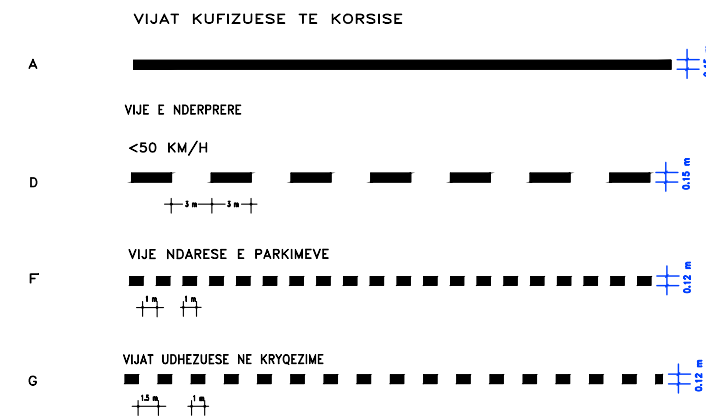

SHENJA INFORMUESE

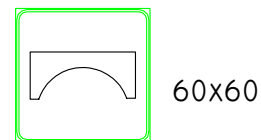

URE

Shenim: Shenjat rrugore per nga forma, madhesia, ngjyra reflektiviteti duhet te jene sipas Kodit Rrugor te Republikes se Shqiperise Materiali praparefektiv duhet te kete jetegjatesi 10vjet per Clasin 2 dhe 7 vjet per Clasin 1 Simboli brenda shenjes rrugore duhet te jete i realizuar me boje te trajtuar me pjekje e cila nuk humbet treguesit praparefektiv Shenja rrugore realizohet me llamarine çeliku e cila lyhet me boje opake kundrandra korozionit dhe trajtohet me pjekje.

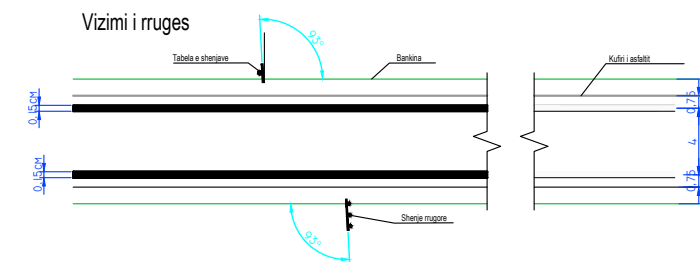
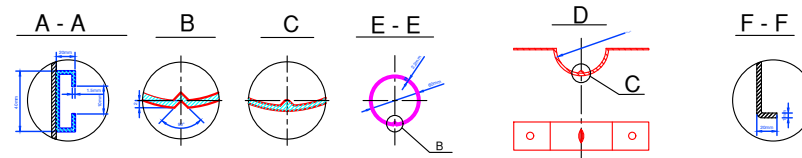

FOROSITESH:

BASHKIA BULQIZE

EMERTIMI I PROJEKTTIT :
**SISTEM-ASFALTIM I RRUGES BLLACE,
LOTI I, N.J.A. SHUPENZE,
BASHKIA BULQIZE**

FAZA E PROJEKTTIT :

PROJEKT ZBATIMI

EMERTIMI I FLETES :

DETAJET E RRUGES

SHKALLA 1:50	NR. FLETES 04
-----------------	------------------

GRUPI I PROJEKTTIMIT : "ALBGOLDING 2E" sh.p.k

Ing. Hajredin MURGU
Ark. Soela MERKO
Ark. Erion MURGU



"ALBGOLDING 2E" sh.p.k
CONTACT:
E-MAIL : albgolding2@gmail.com
Cel: +355 68 52 07 550
+355 68 20 85 763