



REPUBLIKA E SHQIPERISË
BASHKIA LUSHNJE
DREJTORIA E PLANIFIKIMIT DHE ZHVILLIMIT TË TERRITORIT
SEKTORI I PROJEKTIMIT

MIRATOI
KRYETARI BASHKISË
ERISELDA SEFA



PROJEKT

OBJEKTI: URBANIZIMI I BLOKUT TË BANIMIT NË DUSHK SEKTOR

DUSHK SEKTOR, NJËSIA ADMINISTRATIVE DUSHK, BASHKIA LUSHNJE

PLANI I VENDOSJES SË NDËRTIMIT

OBJEKTI: URBANIZIMI I BLOKUT TË BANIMIT NË DUSHK SEKTOR

INVESTITOR: BASHKIA LUSHNJE

VENDNDODHJA: DUSHK SEKTOR, NJËSIA ADMINISTRATIVE DUSHK, BASHKIA LUSHNJE

**MIRATOHET
KRYETARI I BASHKISË LUSHNJE
ERISELDA SEFA**

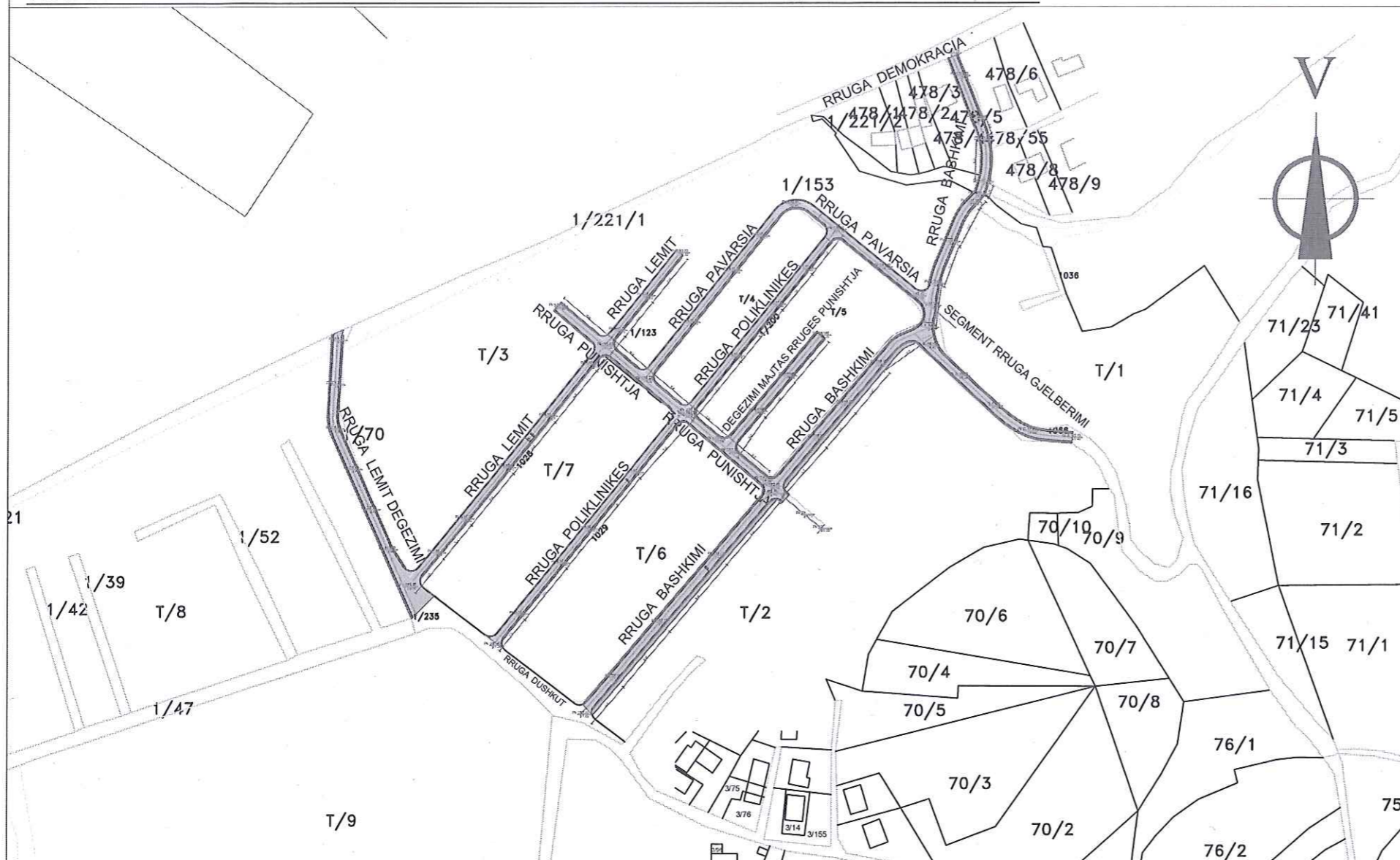

Rruga BASHKIMI - L=370ml, B=4ml asfalt+ 2x0.5 kuneta + trotuare 1.5ml ne njeren ane

Rruga LEMIT - L=195ml + 120ml degezimi majtas, B=3.5ml asfalt + 0.5 kunete ne njeren ane

Rruga PUNISHTJA L=130ml, degezimi L=65ml, B=4ml asfalt + 2x0.5 kuneta

Rruga PAVARSIA L=181ml asfalt + 0.5 kunete ne njeren ane

Rruga POLIKLINIKES L=242ml, B=3.5ml asfalt + 0.5 kuneta ne njeren ane

SEGMENTI I RRUGES GJELBERIMI L=90ml, B=4ml asfalt + 0.5 kuneta ne njeren ane

PAMJE NGA ORTOFOTO

**POZICIONI KADASTRAL I PRONAVE 1582, 1583
NR I PASURISË 1:7500**

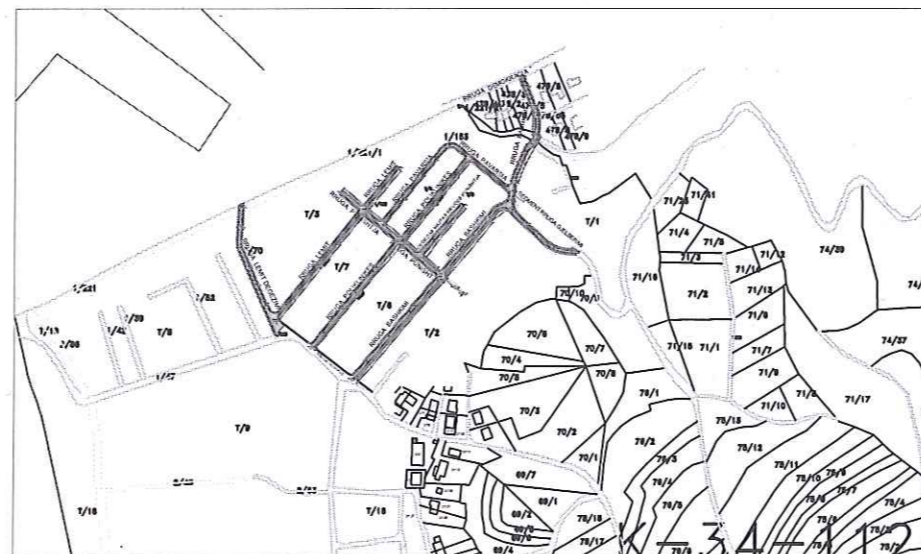

OBJEKTI	URBANIZIMI I BLOKUT TË BANIMIT NË DUSHK SEKTOR	NR.FLETES	A-
VENDNDODHJA	DUSHK SEKTOR, NJËSIA ADMINISTRATIVE DUSHK, BASHKIA LUSHNJE	FORMATI	420X297
EMERT. I FLETES	PLANIMETRIA E RRUGES	SHKALLA	1:500
DREJTORIA	ING. MIMOZA HAXHIU		
PERGJEGJES	ARK. ALBAN MANDUKU		
SPECIALIST	ING. ARIOLA BEO		
SPECIALIST	ING. FLORIANA TUSHA		
SPECIALIST	ING. ERSI VELIU		
SPECIALIST	ING. GARNI MYZEDARI		
SPECIALIST	ING. ARBEN MUÇA		
SPECIALIST	TOP. VASIL LENA		
			REPUBLIKA E SHQIPERISË BASHKIA LUSHNJE SEKTORI I PROJEKTIMIT



PLANIMETRIA

PLANIMETRIA E RRUGËS

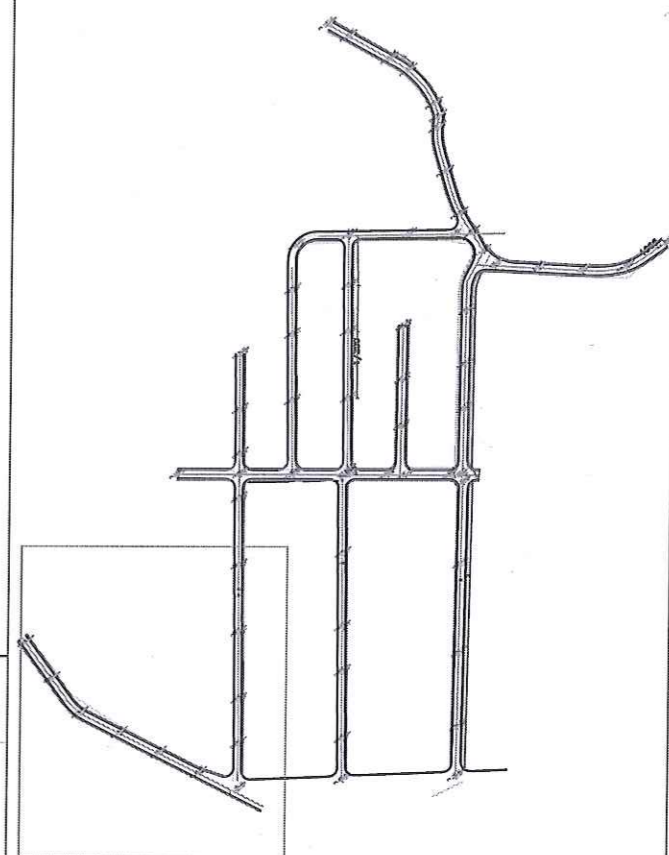
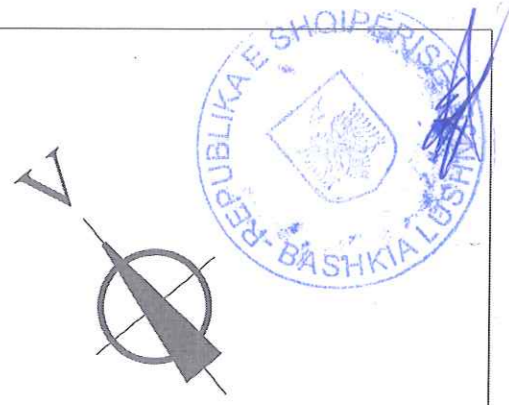
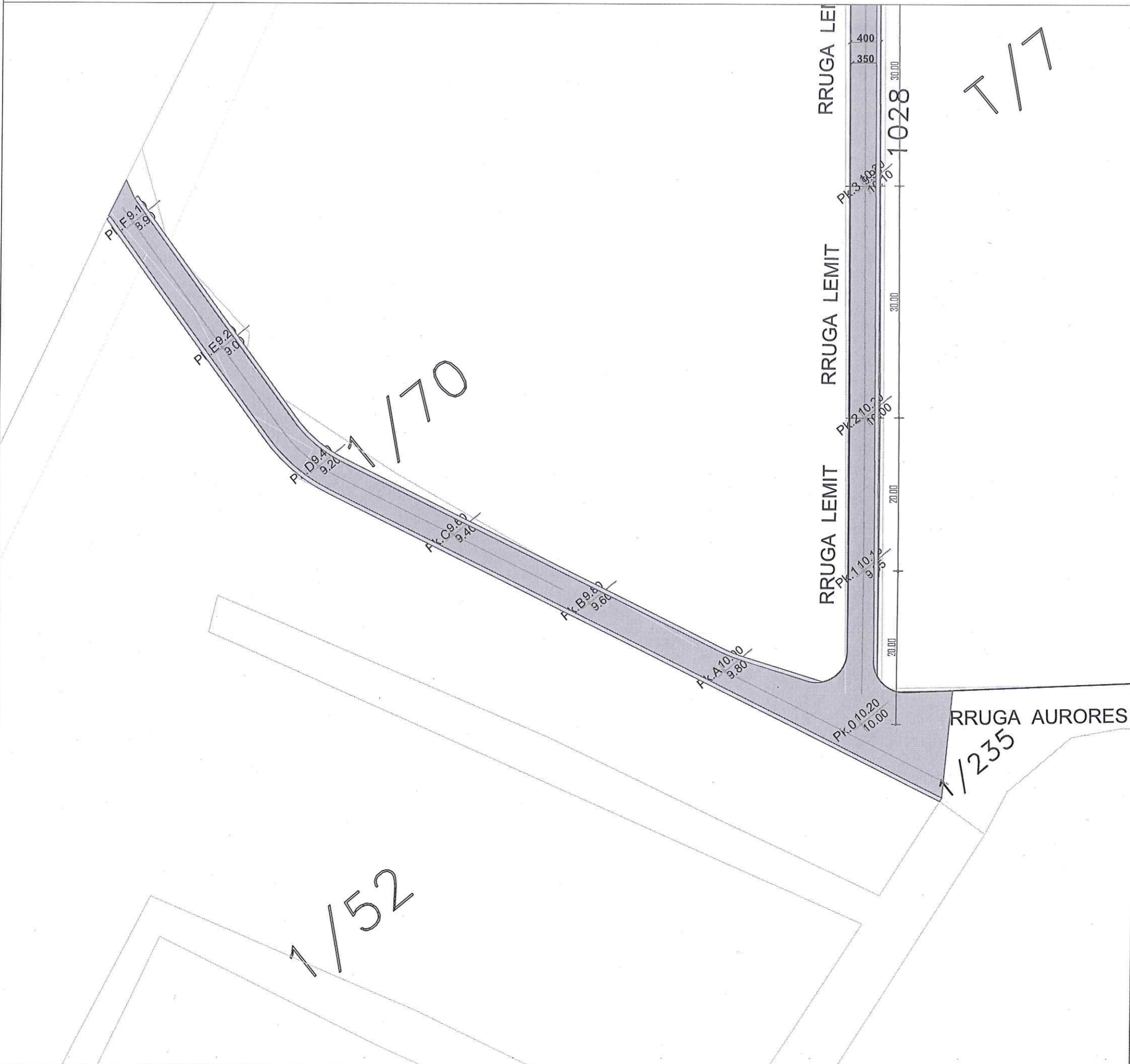

OBJEKTI	URBANIZIMI I BLOKUT TË BANIMIT NË DUSHK SEKTOR	NR.FLETES	A-
VENDNDODHJA	DUSHK SEKTOR, N.JESIA ADMINISTRATIVE DUSHK, BASHKIA LUSHNJE	FORMATI	420X297
EMERT. I FLETES	PLANIMETRIA E RRUGES	SHKALLA	1:500
DREJTORIA	ING. MIMOZA HAXHIU		
PERGJEGJES	ARK. ALBAN MANDU		
SPECIALIST	ING. ARIOLA BEO		
SPECIALIST	ING. FLORIANA TUSHA		
SPECIALIST	ING. ERSI VELIU		
SPECIALIST	ING. GANI MYZEDARI		
SPECIALIST	ING. ARBEH MUCA		
SPECIALIST	TOP. VASIL LEHA	REPUBLIKA E SHQIPERISE BASHKIA LUSHNJE SEKTORI I PROJEKTIMIT	

PLANIMETRIA E RRUGËS

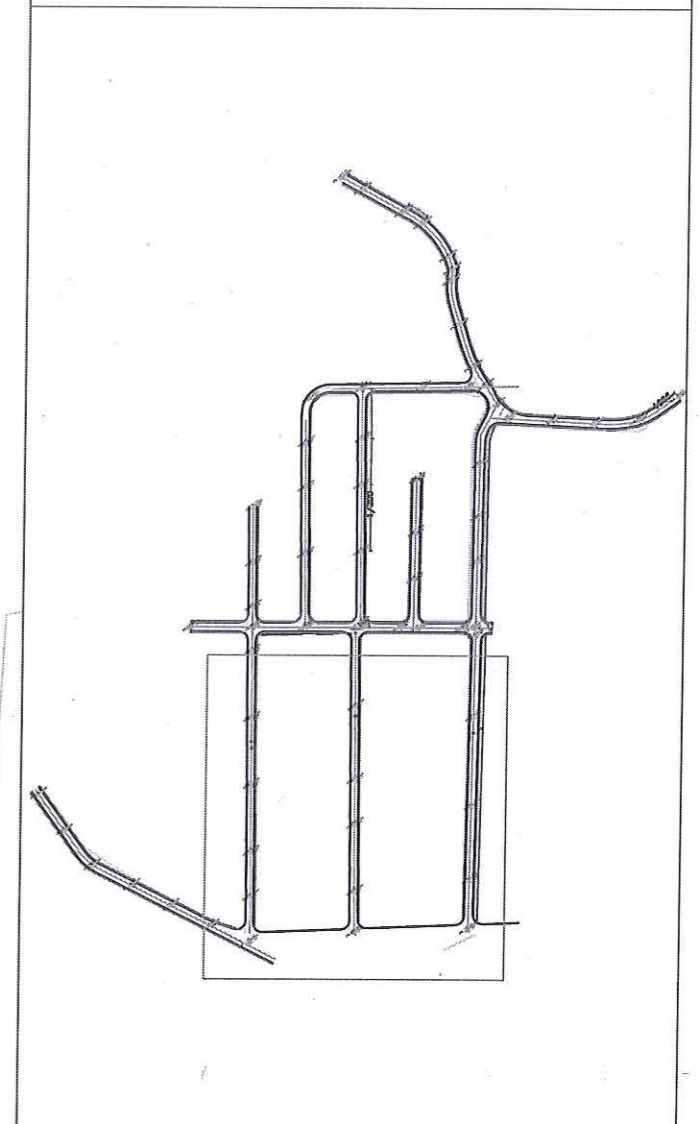
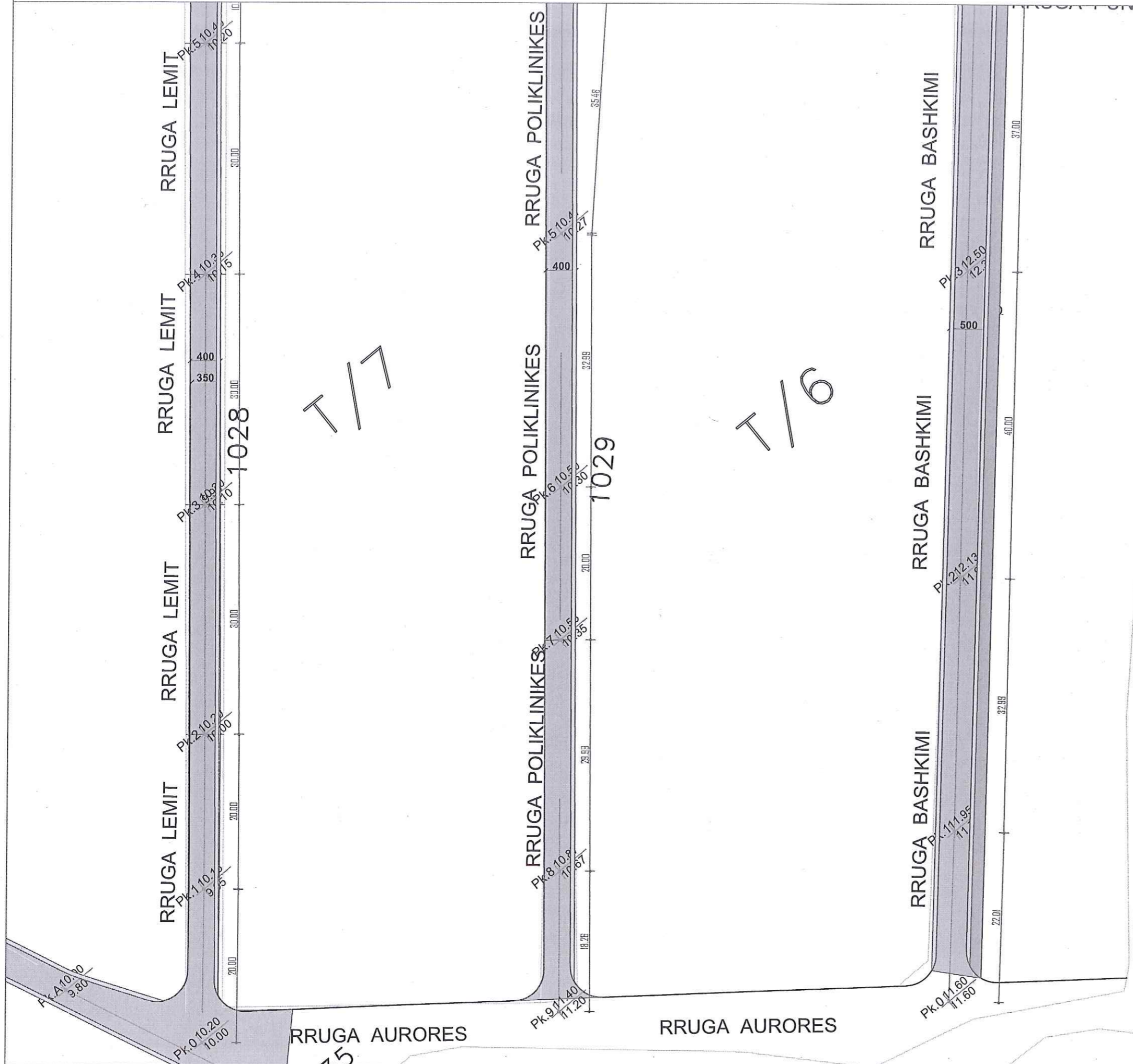

OBJEKTI	URBANIZIMI I BLOKUT TE BANIMIT NE DUSHK SEKTOR	NR.FLETES	A-
VENDNDODHJA	DUSHK SEKTOR, NJESIA ADMINISTRATIVE DUSHK, BASHKIA LUSHNJE	FORMATI	420X297
EMERT. I FLETES	PLANIMETRIA E RRUGES	SHKALLA	1:500
DREJTORIA	ING. MIMOZA HAXHIU		
PERGJEGJES	ARK. ALBAN MANDOKU		
SPECIALIST	ING. ARIOLA BEGO		
SPECIALIST	ING. FLORIANA TUSHA		
SPECIALIST	ING. ERSI VELIU		
SPECIALIST	ING. GANI MYZEDARI		
SPECIALIST	ING. ARBEN MUCA		
SPECIALIST	TOP. VASIL LENA	REPUBLIKA E SHQIPERISE BASHKIA LUSHNJE SEKTORI I PROJEKTIMIT	

PLANIMETRIA E RRUGËS

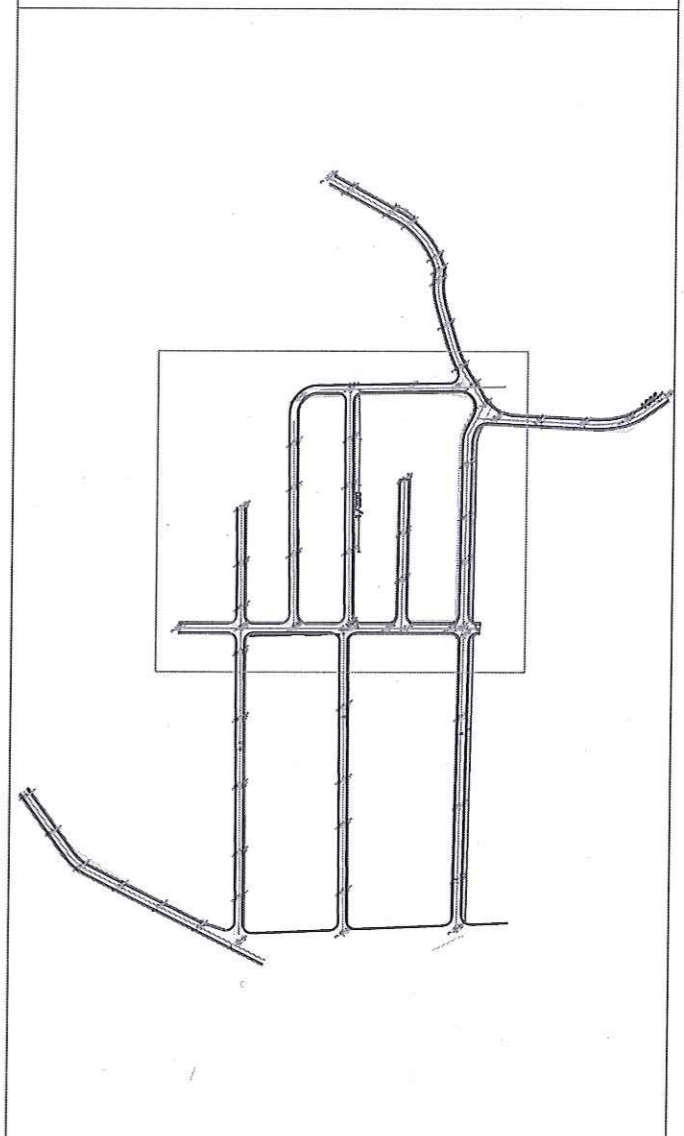
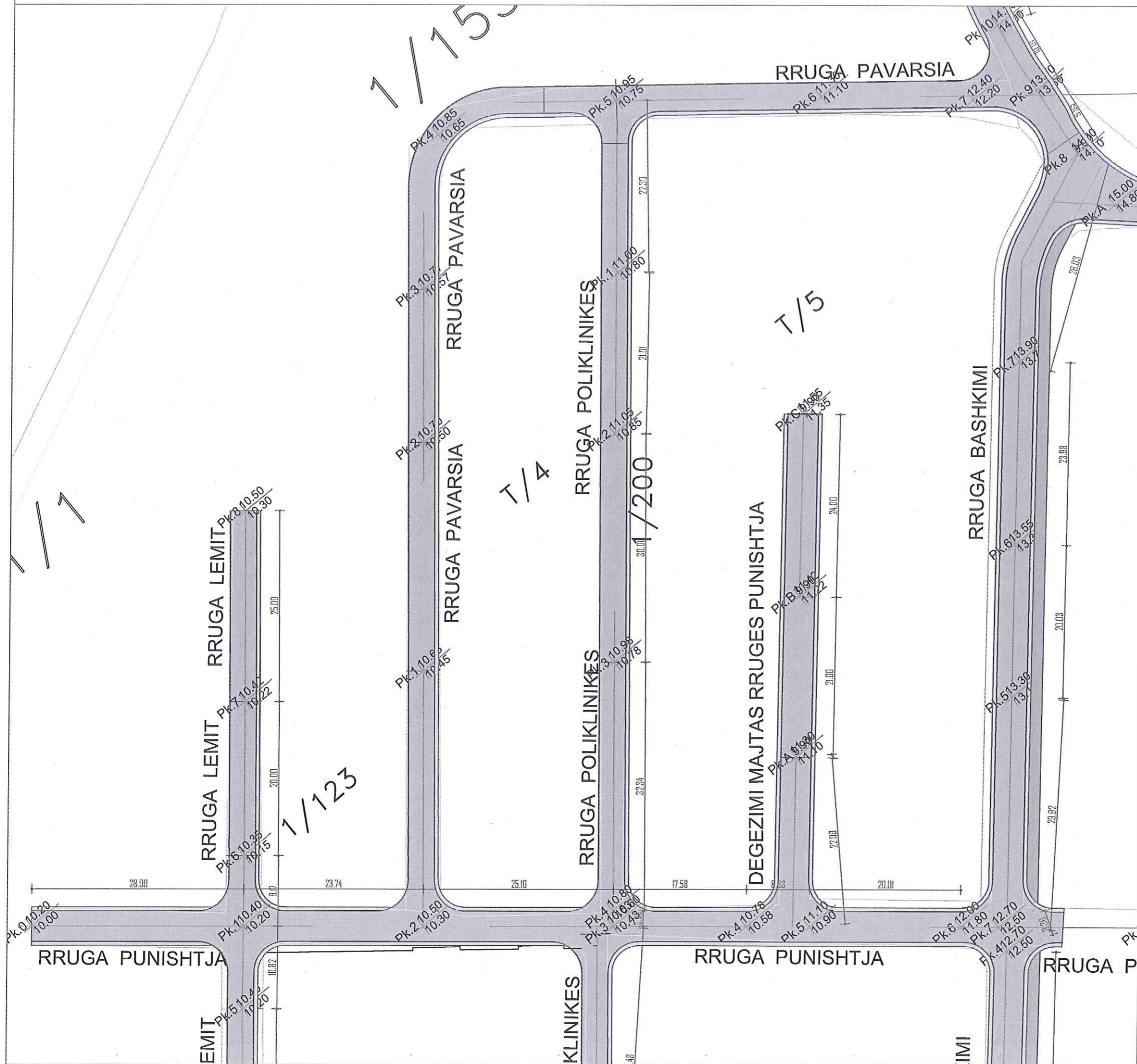

OBJEKTI	URBANIZIMI I BLOKUT TË BAHIMIT NË DUSHK SEKTOR	NR.FLETES	A-
VENDNDODHJA	DUSHK SEKTOR, NJËSIA ADMINISTRATIVE DUSHK, BASHKIA LUSHNJË	FORMATI	420X297
EMERT. I FLETES	PLANIMETRIA E RRUGËS	SHKALLA	1:500
DREJTORIA	ING. MIMOZA HAXHIU		
PERGJEGJES	ARK. ALBAN MANOKU		
SPECIALIST	ING. ARIOLA BEQO		
SPECIALIST	ING. FLORIANA TUSHA		
SPECIALIST	ING. ERSI VELIU		
SPECIALIST	ING. GANI MYZEQARI		
SPECIALIST	ING. ARBEN MUCA		
SPECIALIST	TOP. VASIL LENA		

PLANIMETRIA E RRUGËS

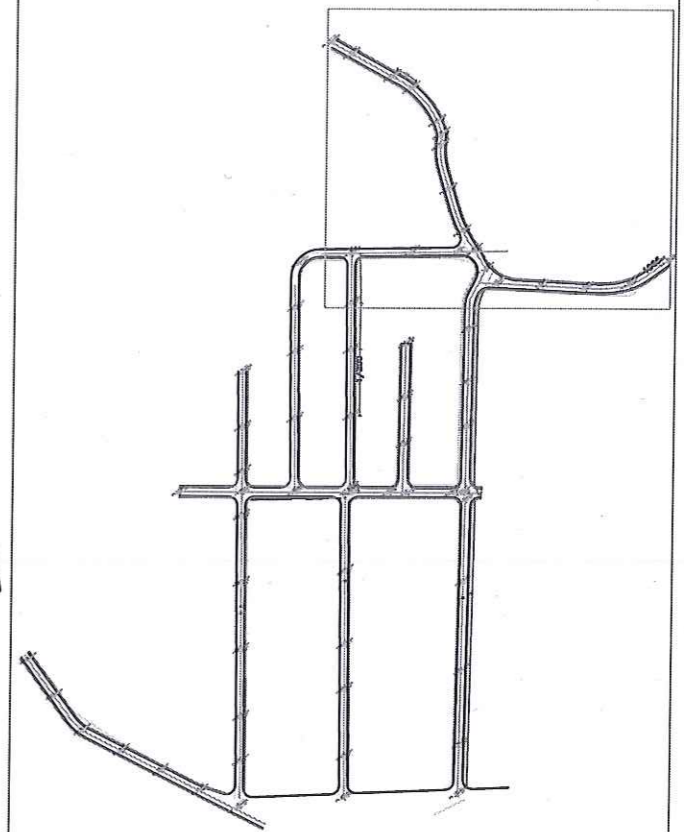
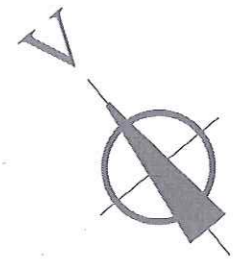

OBJEKTI	URBANIZIMI I BLOKUT TË BANIMIT NË DUSHK SEKTOR	NR.FLETES	A-
VENDNDODHJA	DUSHK SEKTOR, NJËSIA ADMINISTRATIVE DUSHK, BASHKIA LUSHNJE	FORMATI	420X287
EMERT. I FLETES	PLANIMETRIA E RRUGËS	SHKALLA	1:500
DREJTORIA	ING. MIMOZA HAXHIU		
PERGJEGJES	ARK. ALBAN MANOKU		
SPECIALIST	ING. ARIOLA BEQO		
SPECIALIST	ING. FLORIANA TUSHA		
SPECIALIST	ING. ERSI VELIU		
SPECIALIST	ING. GANI MYZEQARI		
SPECIALIST	ING. ARBEN MUCA		
SPECIALIST	TOP. VASIL LENA		



REPUBLIKA E SHQIPERISE
BASHKIA LUSHNJE
SEKTORI I PROJEKTIMIT



SINJALISTIKA

SINJALISTIKA E RRGËS

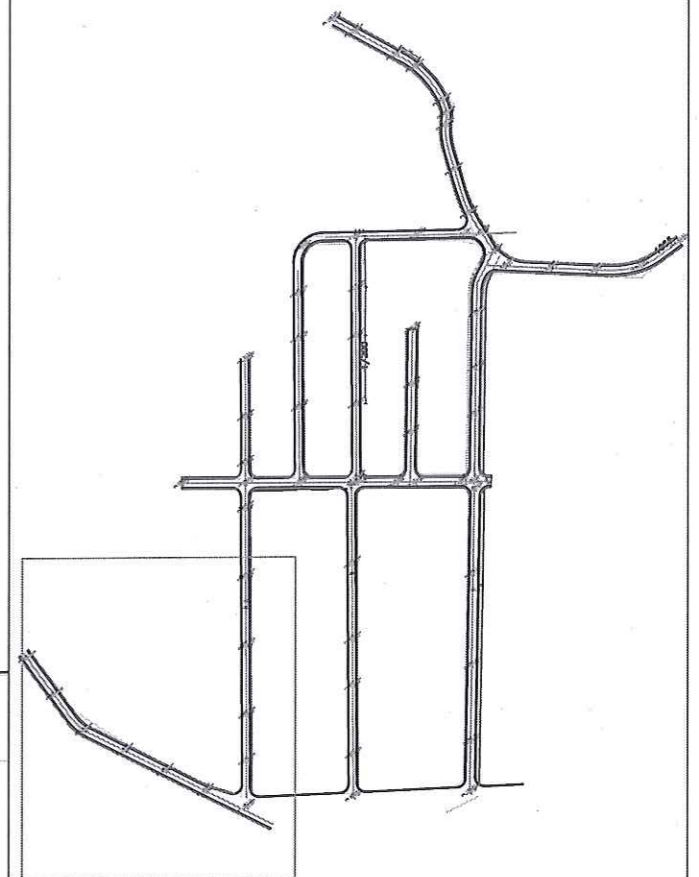
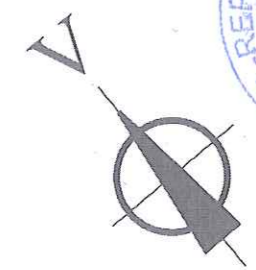
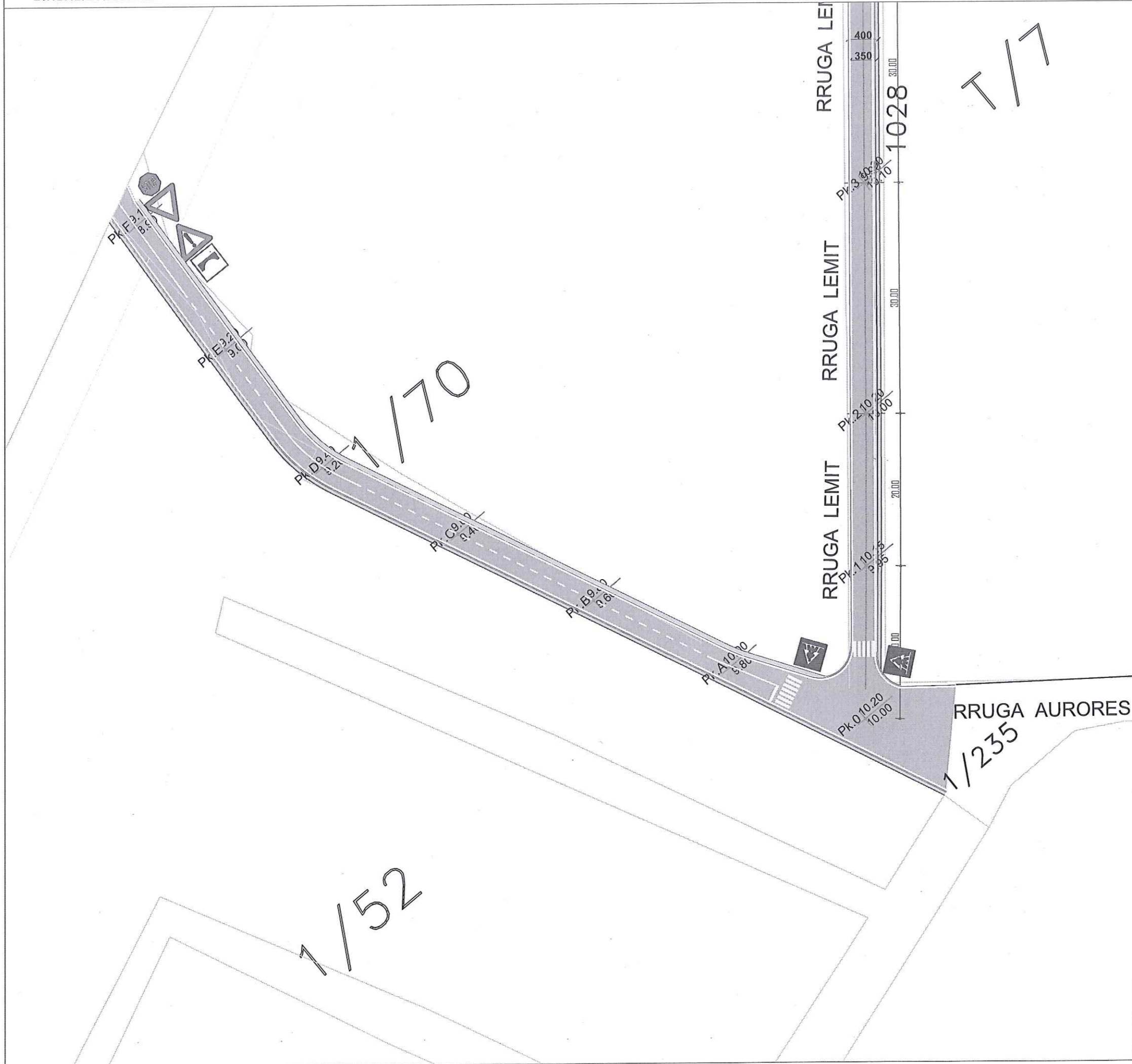

OBJEKTI	URBANIZIMI I BLOKUT TË BANIMIT NË DUSHK SEKTOR	NR.FLETES	A-
VENDNODHJA	DUSHK SEKTOR, NJESIA ADMINISTRATIVE DUSHK, BASHKIA LUSHNJE	FORMATI	420X297
EMERT. I FLETES	PLANIMETRIA E RRGËS	SHKALLA	1:500
DREJTORIA	ING. MIMOZA HAXHIU		
PERGJEGJES	ARK. ALBAN MANDOKU		
SPECIALIST	ING. ARIOLA BEQO		
SPECIALIST	ING. FLORIANA TUSHA		
SPECIALIST	ING. ERSI VELIU		
SPECIALIST	ING. GANI MYZEDARI		
SPECIALIST	ING. ARBEN MUCA		
SPECIALIST	TOP. VASIL LENA		

REPUBLIKA E SHQIPERISE
BASHKIA LUSHNJE
SEKTORI I PROJEKTIMIT

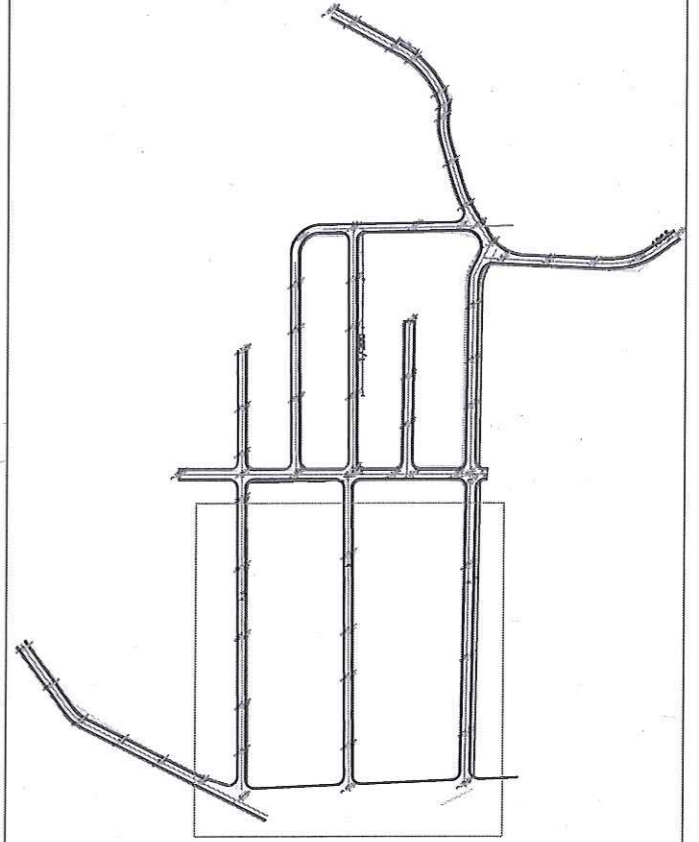
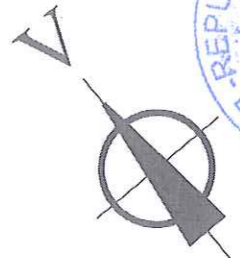
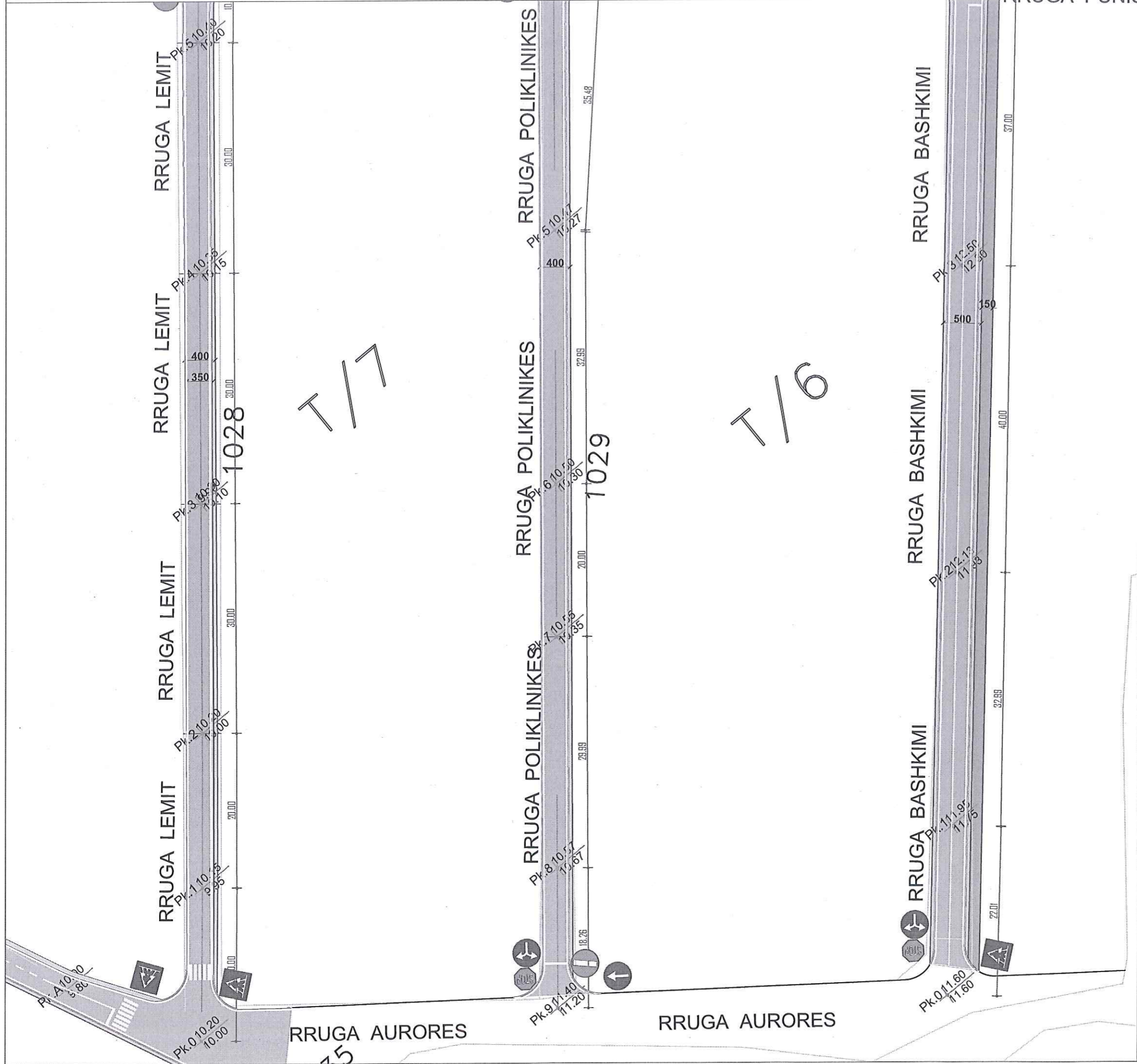

OBJEKTI	URBANIZIMI I BLOKUT TË BANIMIT NË DUSHK SEKTOR	NR.FLETES	A-
VENDNDODHJA	DUSHK SEKTOR, NJESIA ADMINISTRATIVE DUSHK BASHKIA LUSHNJE	FORMATI	420X297
EMERT. I FLETES	PLANIMETRIA E RRUGES	SHKALLA	1:500
DREJTORIA	ING. MIMOZA HAXHIU		
PERGJEGJES	ARK. ALBAN MANOKU		
SPECIALIST	ING. ARIOLA BEO		
SPECIALIST	ING. FLORIANA TUSHA		
SPECIALIST	ING. ERSI VELIU		
SPECIALIST	ING. GANI MYZEDARI		
SPECIALIST	ING. ARBEN MUCA		
SPECIALIST	TOP. VASIL LENA		



REPUBLIKA E SHQIPERISE
BASHKIA LUSHNJE
SEKTORI I PROJEKTIMIT

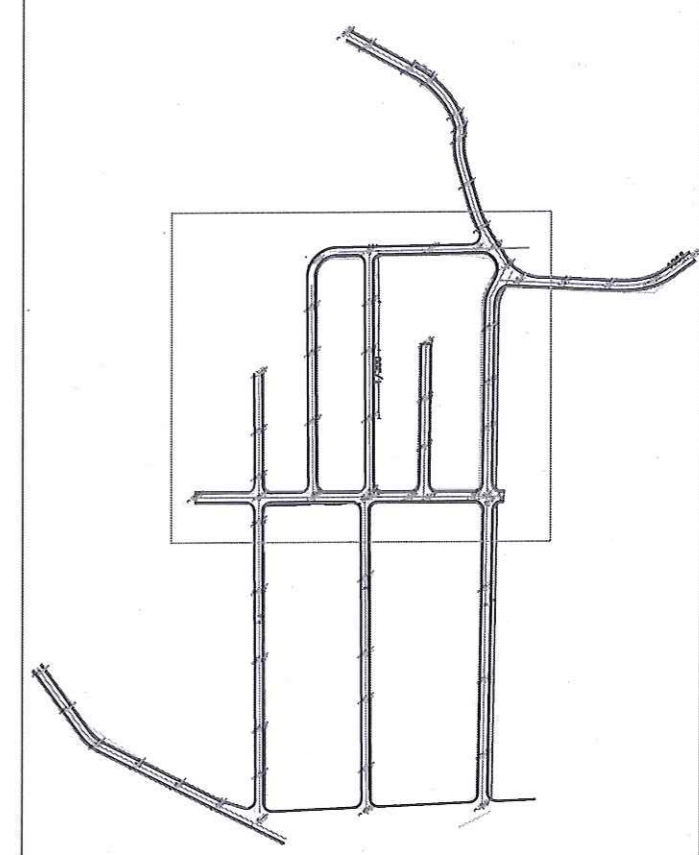

OBJEKTI	URBANIZIMI I BLOKUT TE BANIMIT NE DUSHK SEKTOR	NR.FLETES	A-
VENDNDODHJA	DUSHK SEKTOR, NJESIA ADMINISTRATIVE DUSHK, BASHKIA LUSHNJE	FORMATI	420X297
EMERT. I FLETES	PLANIMETRIA E RRUGES	SHKALLA	1:500
DREJTORIA	ING. MIMOZA HAXHIU		
PERGJEGJES	ARK. ALBAN MANOKU		
SPECIALIST	ING. ARIOLA BEQQ		
SPECIALIST	ING. FLORIANA TUSHA		
SPECIALIST	ING. ERSI VELIU		
SPECIALIST	ING. GANI MYZDARI		
SPECIALIST	ING. ARBEN MUCA		
SPECIALIST	TOP. VASIL LENA		

SINJALISTIKA E RRUGËS

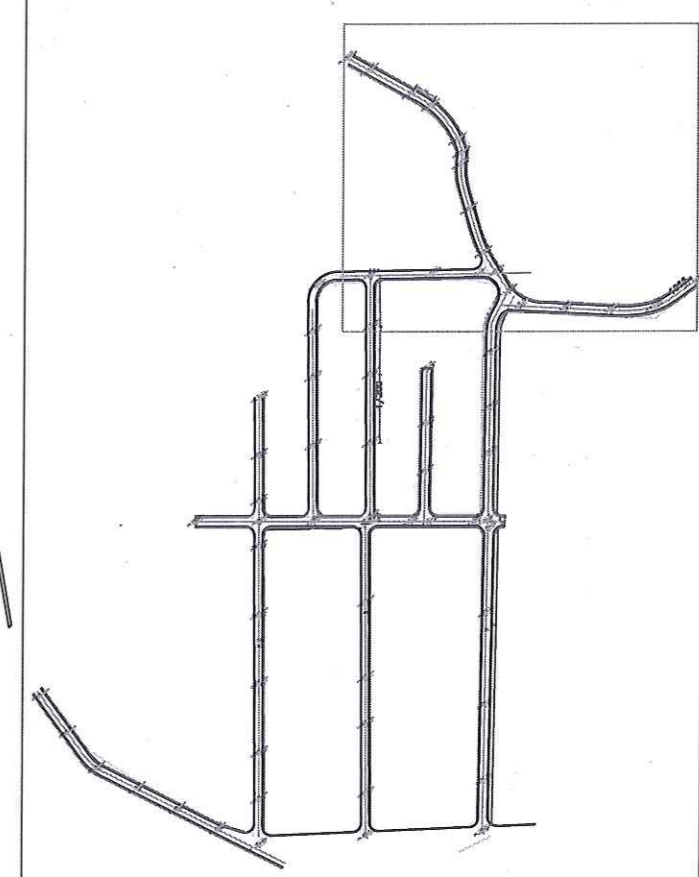

OBJEKTI	URBANIZIMI I BLOKUT TË BANIMIT NË DUSHK SEKTOR	NR.FLETES	A-
VENDNDODHJA	DUSHK SEKTOR, NJESIA ADMINISTRATIVE DUSHK, BASHKIA LUSHNJE	FORMATI	420X297
EMERT. I FLETES	PLANIMETRIA E RRUGES	SHKALLA	1:500
DREJTORIA	ING. MIMOZA HAXHIU		
PERGJEGJES	ARK. ALBAN MANOKU		
SPECIALIST	ING. ARIOLA BEO		
SPECIALIST	ING. FLORIANA TUSA		
SPECIALIST	ING. ERSI VELIU		
SPECIALIST	ING. GANI MYZEDARI		
SPECIALIST	ING. ARBEN MUCA		
SPECIALIST	TOP. VASIL LENA		



NDRIÇIMI

PLANIMETRIA E RRUGËS

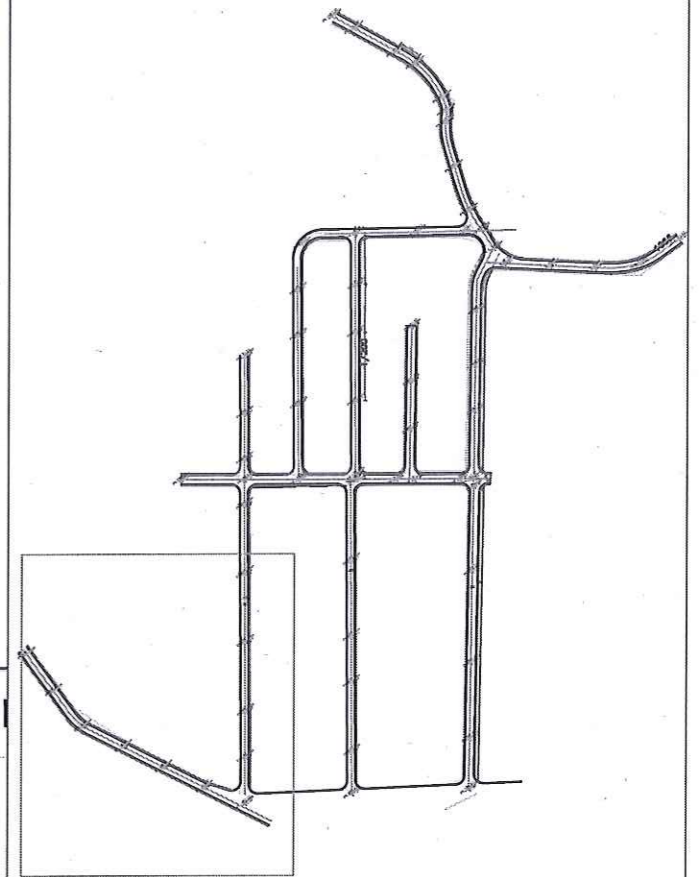
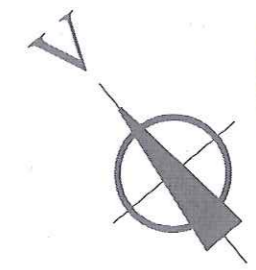
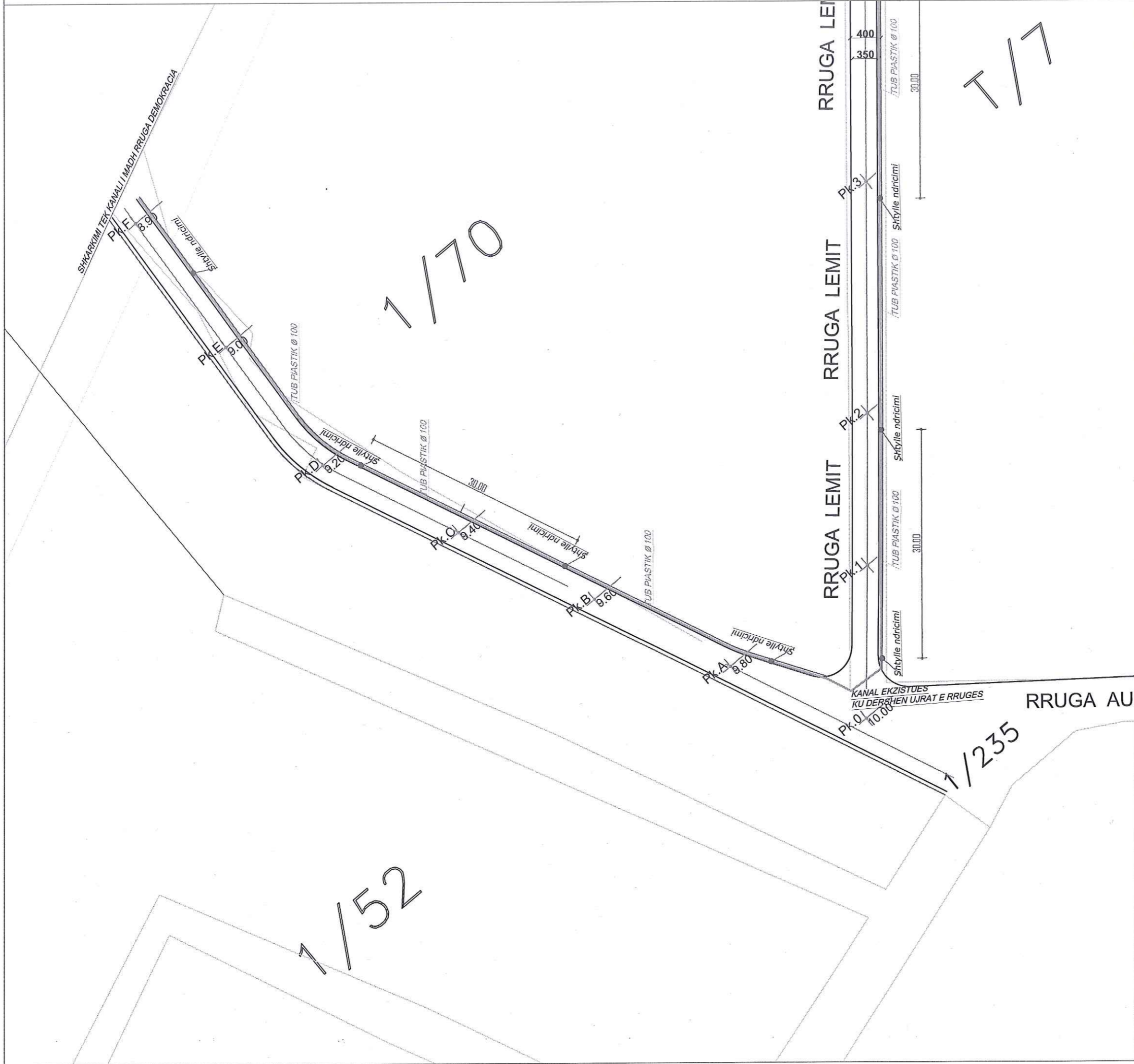

OBJEKTI	URBANIZIMI I BLOKUT TË BANIMIT NË DUSHK SEKTOR	NR.FLETES	A-
VENDNDODHJA	DUSHK SEKTOR, N.JËSIA ADMINISTRATIVE DUSHK BASHKIA LUSHNJË	FORMATI	420X297
EMERT. I FLETES	PLANIMETRIA E RRUGES	SHKALLA	1:500
DREJTORIA	ING. MIMOZA HAXHIU	<p>REPUBLIKA E SHQIPËRISE BASHKIA LUSHNJË SEKTORI I PROJEKTIMIT</p>	
PERGJEGJES	ARK. ALBAN MANDOKU		
SPECIALIST	ING. ARIOLA BEGO		
SPECIALIST	ING. FLORIANA TUSHA		
SPECIALIST	ING. ERSI VELIU		
SPECIALIST	ING. GARNI MYZEDARI		
SPECIALIST	ING. ARBEN MUCA		
SPECIALIST	TOP. VASIL LENA		

PLANIMETRIA E RRUGËS

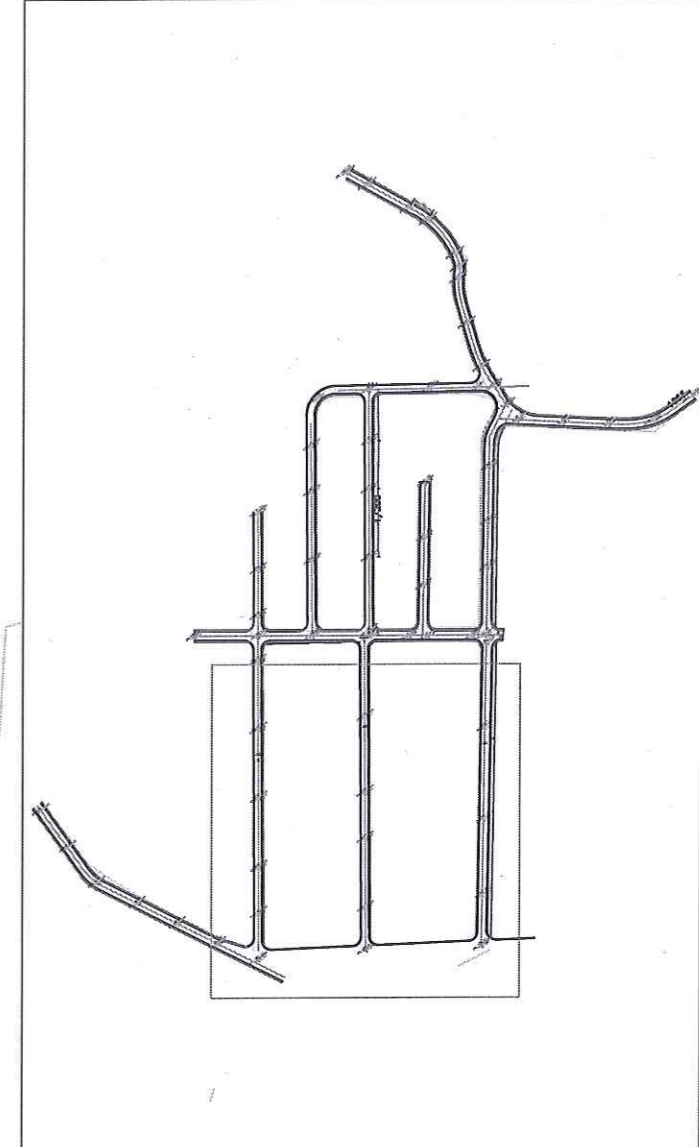
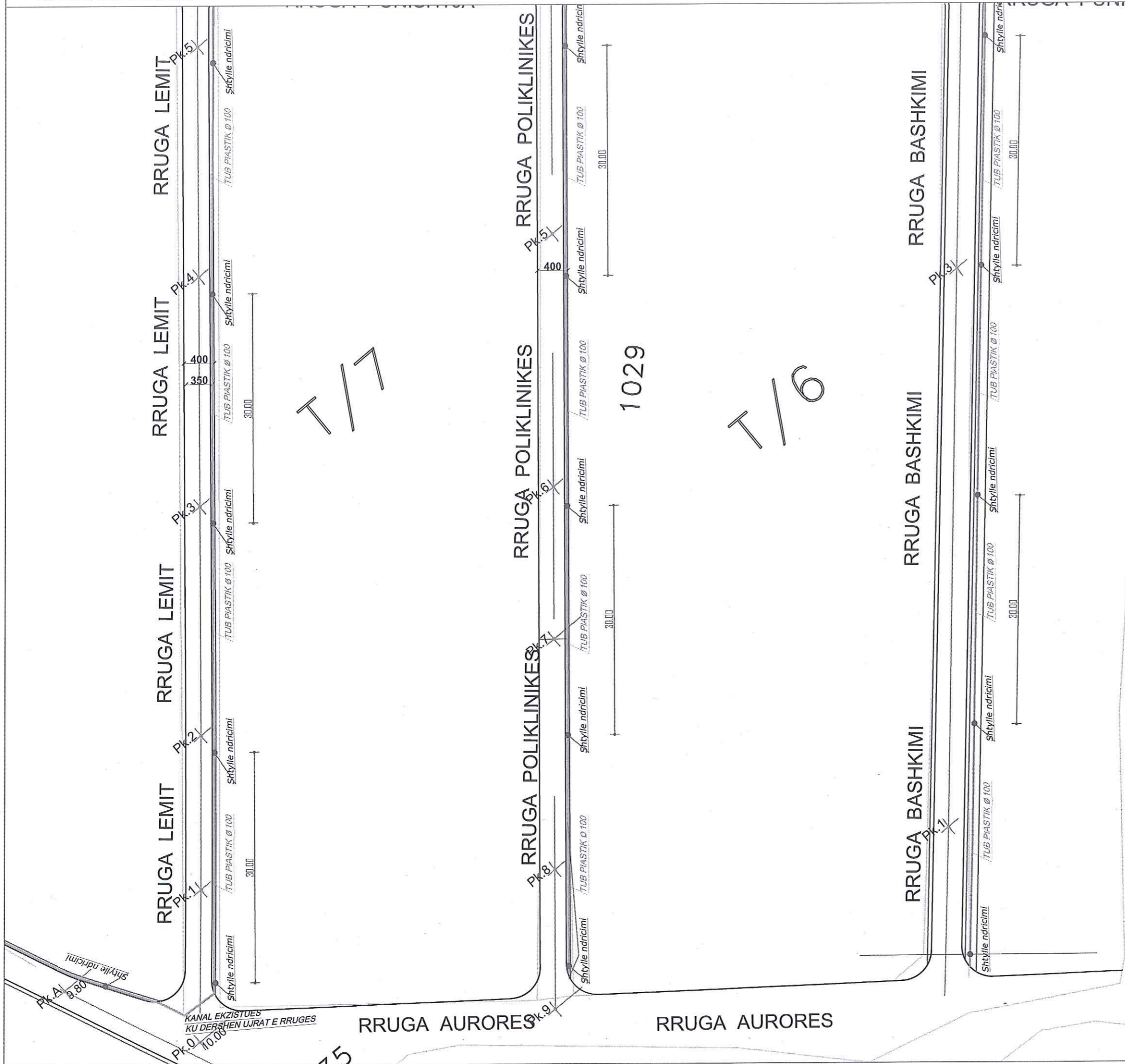

OBJEKTI	URBANIZIMI I BLOKUT TË BANIMIT NË DUSHK SEKTOR	NR.FLETES	A-
VENDNDODHJA	DUSHK SEKTOR, NJËSIA ADMINISTRATIVE DUSHK, BASHKIA LUSHNJE	FORMATI	420X297
EMERT. I FLETES	PLANIMETRIA E RRUGES	SHKALLA	1:500
DREJTORIA	ING. MIMOZA HAXHIU		
PERGJEGJES	ARK. ALBAN MANOKU		
SPECIALIST	ING. ARIOLA BEGO		
SPECIALIST	ING. FLORIANA TUSHA		
SPECIALIST	ING. ERSI VELIU		
SPECIALIST	ING. GARNI MYZEGARI		
SPECIALIST	ING. ARBEN MUCA		
SPECIALIST	TOP. VASIL LENA		



REPUBLIKA E SHQIPERISE
BASHKIA LUSHNJE
SEKTORI I PROJEKTIMIT

PLANIMETRIA E RRUGËS

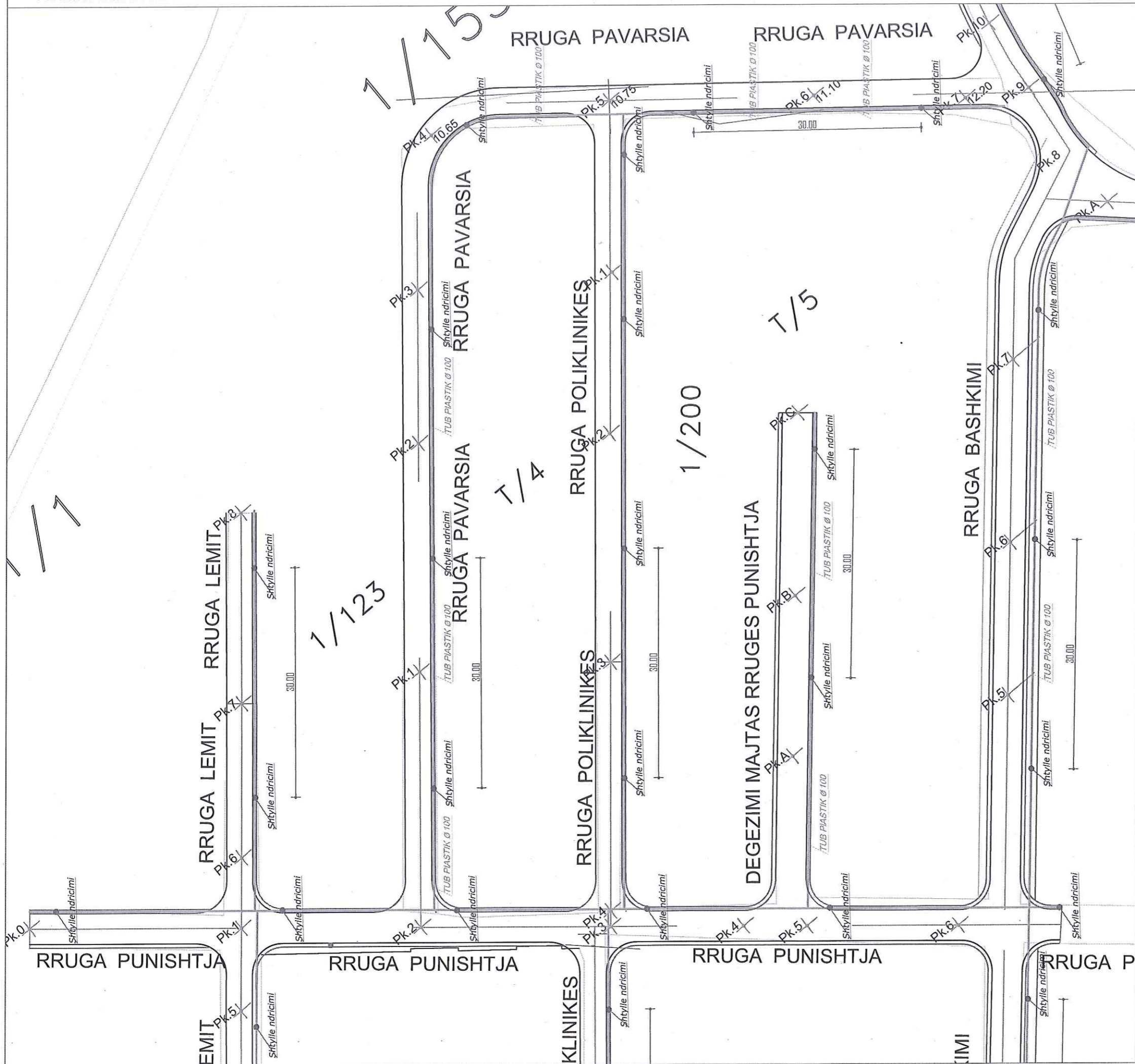

OBJEKTI	URBANIZIMI I BLOKUT TË BANIMIT NË DUSHK SEKTOR	NR.FLETES	A-
VENDNDODHJA	DUSHK SEKTOR, NJESIA ADMINISTRATIVE DUSHK, BASHKIA LUSHNJË	FORMATI	420X297
EMERT. I FLETES	PLANIMETRIA E RRUGES	SHKALLA	1:500
DREJTORIA	ING. MIMOZA HAXHIU		
PERGJEGJES	ARK. ALBAN MANOKU		
SPECIALIST	ING. ARIOLA BEO		
SPECIALIST	ING. FLORIANA TUSA		
SPECIALIST	ING. ERSI VELIU		
SPECIALIST	ING. GARNI MYZEGARI		
SPECIALIST	ING. ARBEN MUCA		
SPECIALIST	TOP. VASIL LENA		

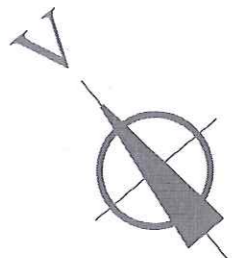
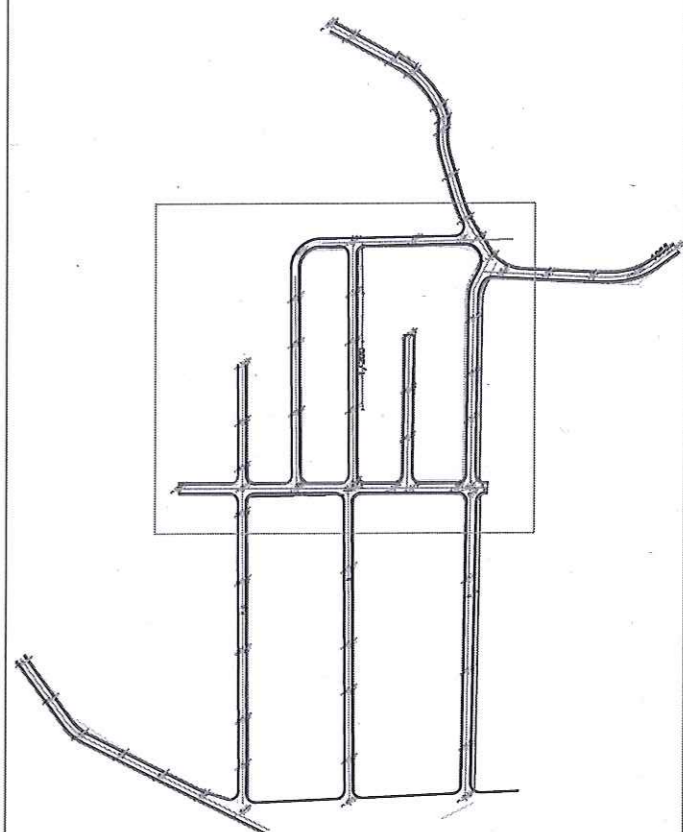

PLANIMETRIA E RRUGËS

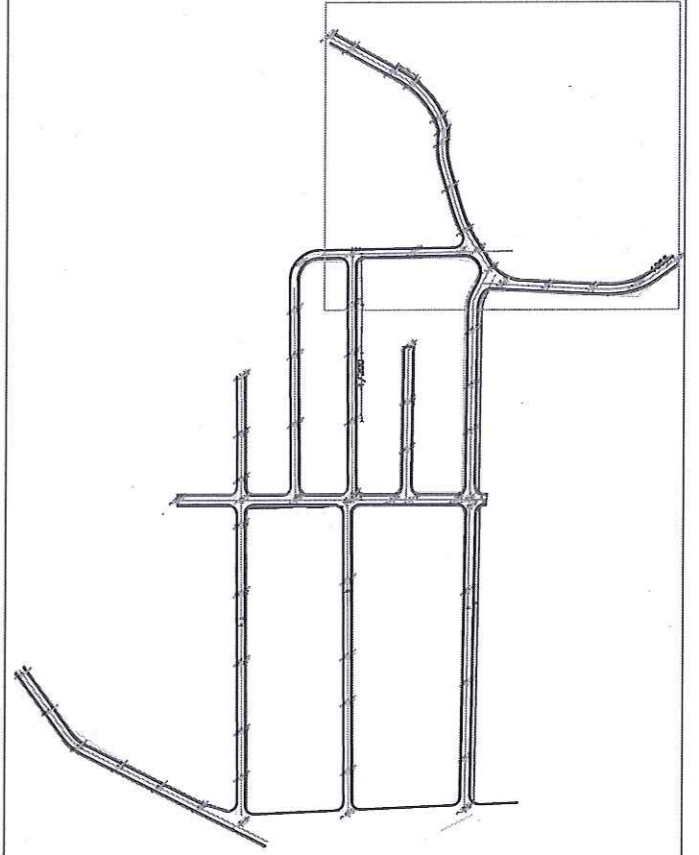

OBJEKTI	URBANIZIMI I BLOKUT TË BANIMIT NË DUSHK SEKTOR	NR.FLETES	A-
VENDNDODHJA	DUSHK SEKTOR, NJËSIA ADMINISTRATIVE DUSHK, BASHKIA LUSHNJE	FORMATI	420x297
EMERT. I FLETES	PLANIMETRIA E RRUGES	SHKALLA	1:500
DREJTORIA	ING. MIMOZA HAXHIU		
PERGJEGJES	ARK. ALBAN MANDKU		
SPECIALIST	ING. ARIOLA BEQI		
SPECIALIST	ING. FLORIANA TUSHA		
SPECIALIST	ING. ERSI VELIU		
SPECIALIST	ING. GARNI MYZEQARI		
SPECIALIST	ING. ARBEN MUCA		
SPECIALIST	TOP. VASIL LENA		



REPUBLIKA E SHQIPERISE
BASHKIA LUSHNJE
SEKTORI I PROJEKTIMIT



K.U.B

PLANIMETRIA E RRUGËS

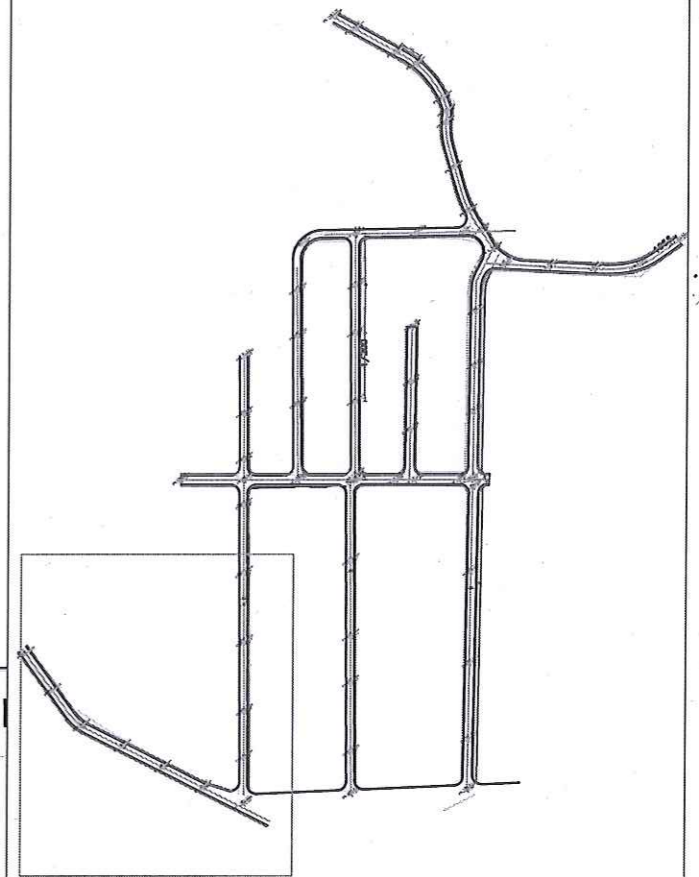
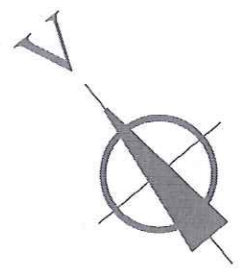
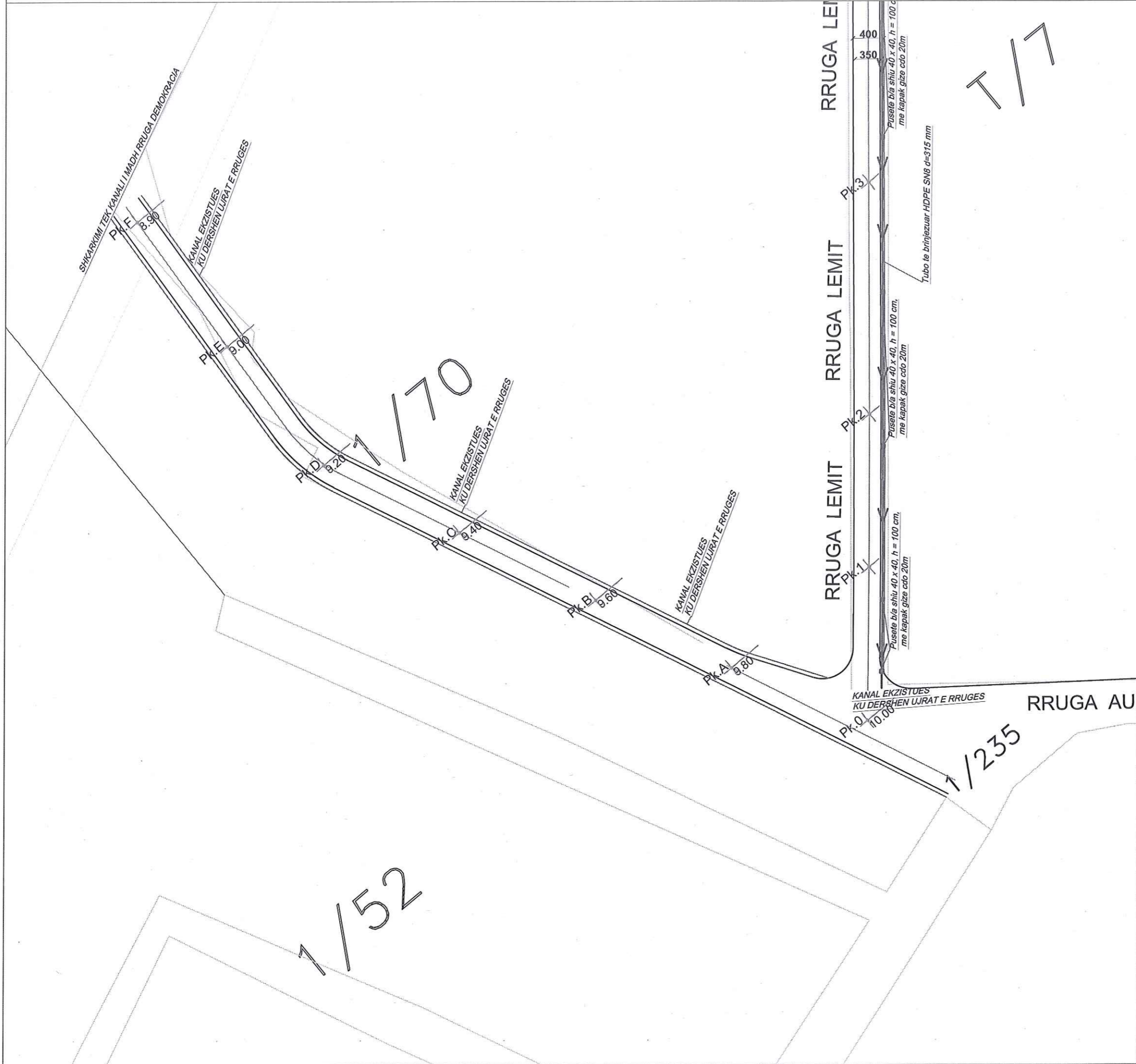

OBJEKTI	URBANIZIMI I BLOKUT TË BANIMIT NË DUSHK SEKTOR	NR.FLETES	A-
VENDNDODHJA	DUSHK SEKTOR, NJËSIA ADMINISTRATIVE DUSHK, BASHKIA LUSHNJE	FORMATI	420X297
EMERT. I FLETES	PLANIMETRIA E RRUGES	SHKALLA	1:500
DREJTORIA	ING. MIMOZA HAXHIU	<p>REPUBLIKA E SHQIPERISE BASHKIA LUSHNJE SEKTORI I PROJEKTIMIT</p>	
PERGJEGJES	ARK. ALBAN MANOKU		
SPECIALIST	ING. ARIOLA BEQQ		
SPECIALIST	ING. FLORIANA TUSHA		
SPECIALIST	ING. ERSI VELIU		
SPECIALIST	ING. GARNI MYZEGARI		
SPECIALIST	ING. ARBEN MUCA		
SPECIALIST	TOP. VASIL LENA		

PLANIMETRIA E RRUGËS

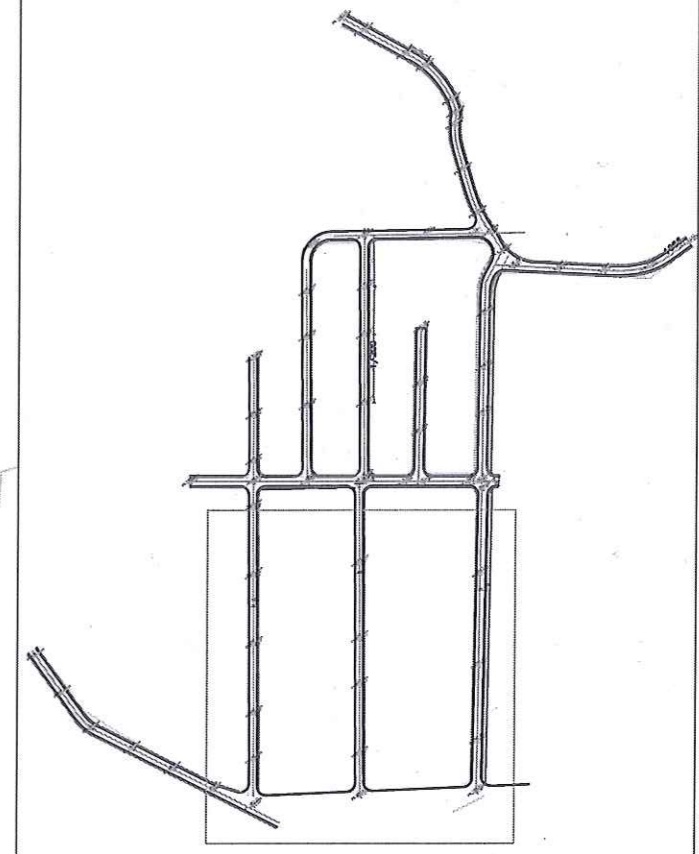
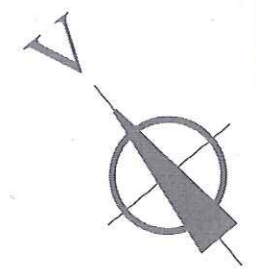
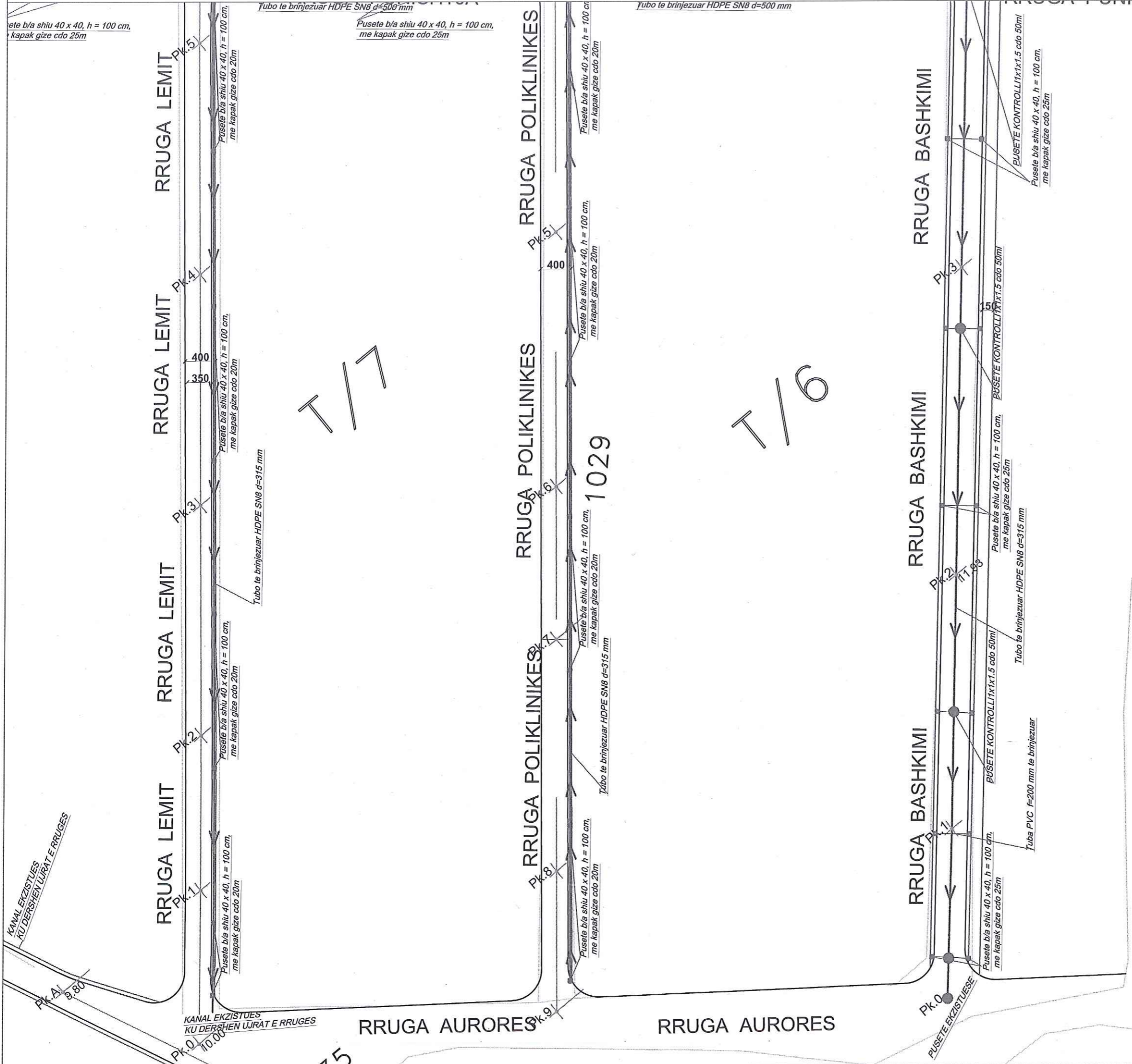

OBJEKTI	URBANIZIMI I BLOKUT TË BANIMIT NË DUSHK SEKTOR	NR.FLETES	A-
VENDNDODHJA	DUSHK SEKTOR, NJËSIA ADMINISTRATIVE DUSHK, BASHKIA LUSHNJË	FORMATI	420X297
EMERT. I FLETES	PLANIMETRIA E RRUGES	SHKALLA	1:500
DREJTORIA	ING. MIMOZA HAXHIU	<p>REPUBLIKA E SHQIPËRISE BASHKIA LUSHNJË SEKTORI I PROJEKTIMIT</p>	
PERGJEGJES	ARK. ALBAN MANOKU		
SPECIALIST	ING. ARIOLA BEO		
SPECIALIST	ING. FLORIANA TUSHA		
SPECIALIST	ING. ERSI VELIU		
SPECIALIST	ING. GARNI MYZEDARI		
SPECIALIST	ING. ARBEN MUCA		
SPECIALIST	TOP. VASHI LENA		

PLANIMETRIA E RRUGËS

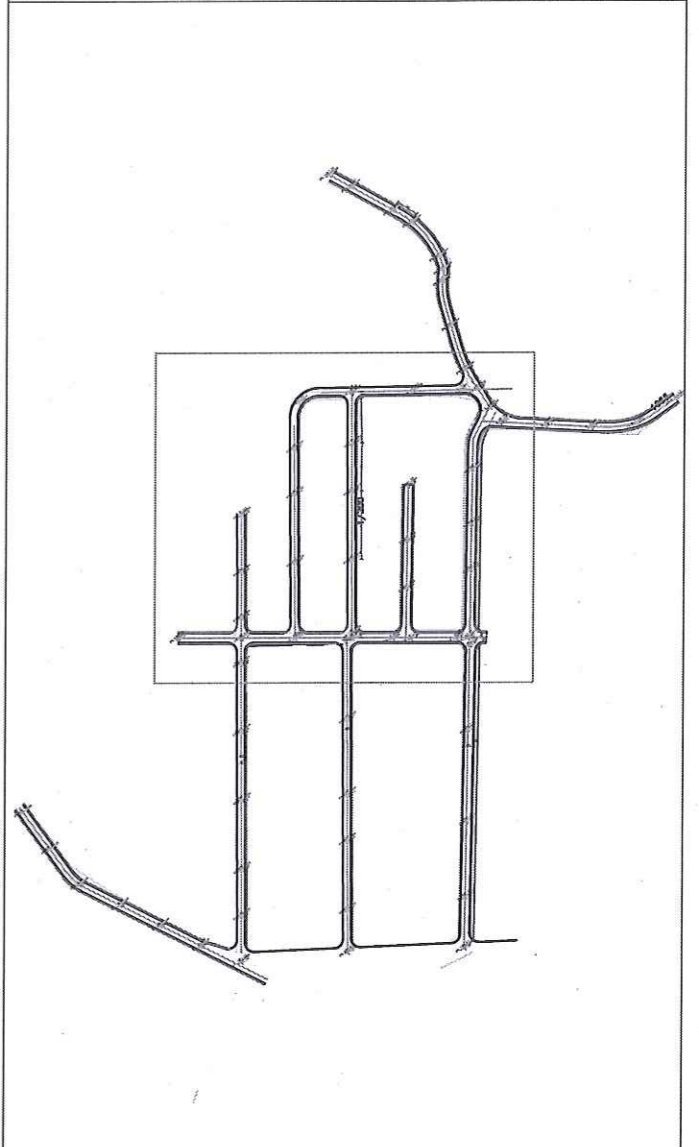
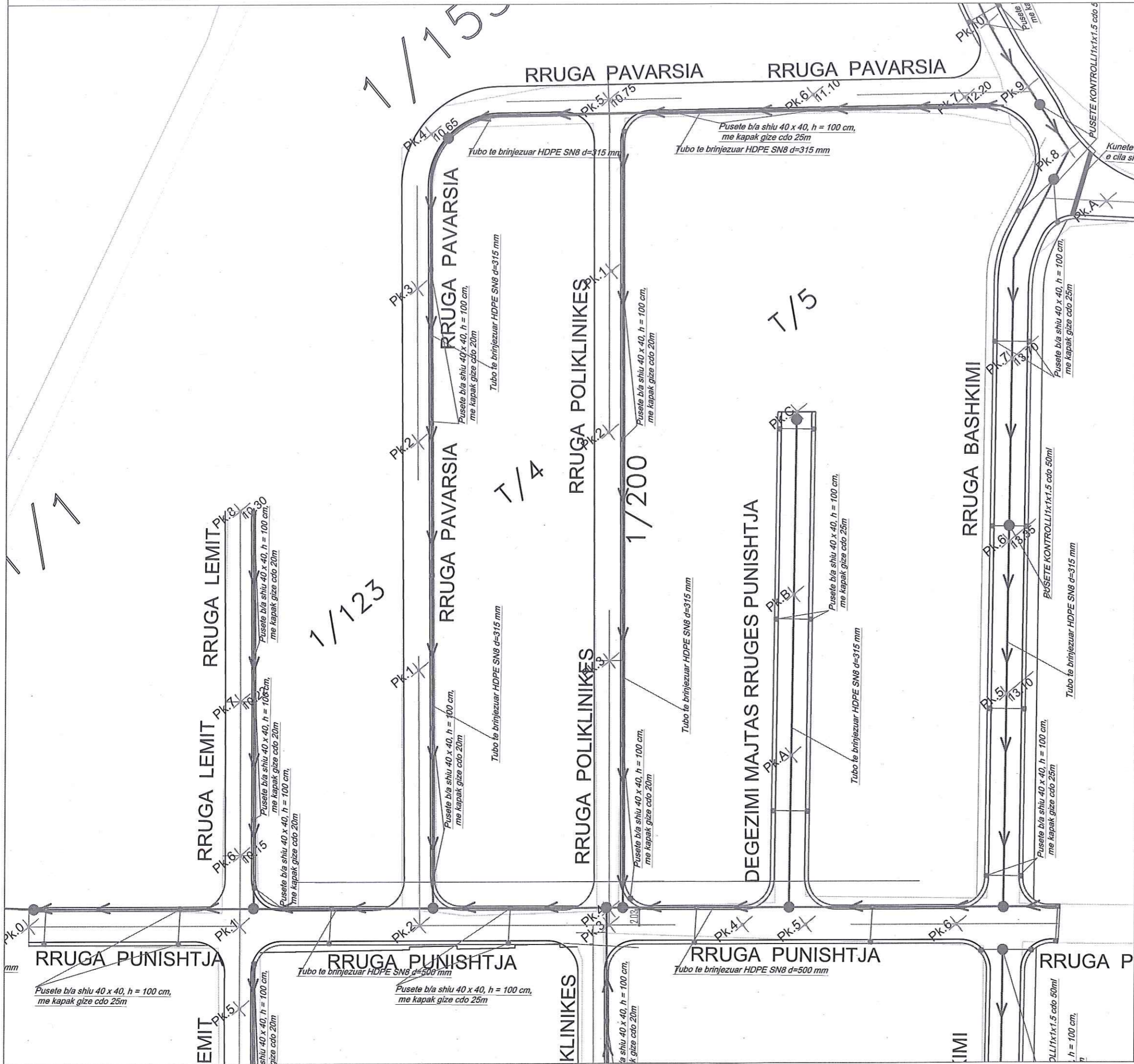

OBJEKTI	URBANIZIMI I BLOKUT TË BANIMIT NË DUSHK SEKTOR	NR.FLETES	A-
VENDNDODHJA	DUSHK SEKTOR, NJËSIA ADMINISTRATIVE DUSHK, BASHKIA LUSHNËJE	FORMATI	420X297
EMERT. I FLETES	PLANIMETRIA E RRUGËS	SHKALLA	1:500
DREJTORIA	ING. MIMOZA HAXHIU		
PERBJEGJES	ARK. ALBAN MANDKU		
SPECIALIST	ING. ARIOLA BEDO		
SPECIALIST	ING. FLORIANA TUSHA		
SPECIALIST	ING. ERSI VELIU		
SPECIALIST	ING. GARNI MYZEQARI		
SPECIALIST	ING. ARBEN MUCA		
SPECIALIST	TOP. VASIL LENA		



REPUBLIKA E SHQIPËRISE
BASHKIA LUSHNËJE
SEKTORI I PROJEKTIMIT

PLANIMETRIA E RRUGËS

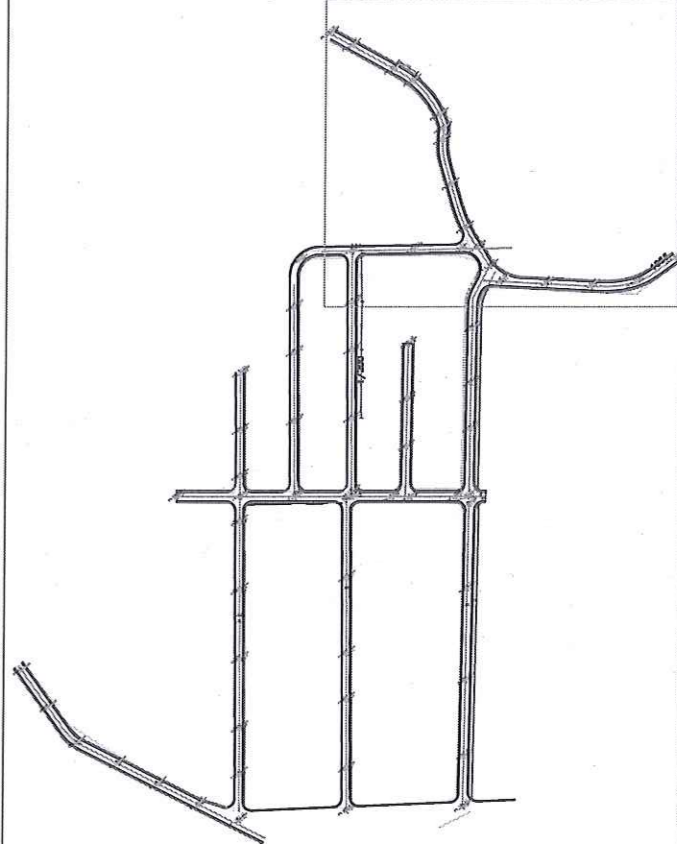

OBJEKTI	URBANIZIMI I BLOKUT TË BANIMIT NË DUSHK SEKTOR	NR.FLETES	A-
VENDNDODHJA	DUSHK SEKTOR, NJËSIA ADMINISTRATIVE DUSHK, BASHKIA LUSHNJË	FORMATI	420X297
EMERT. I FLETES	PLANIMETRIA E RRUGES	SHKALLA	1:500
DREJTORIA	ING. MIMOZA HAXHIU		
PERGJEGJES	ARK. ALBAN MANOKU		
SPECIALIST	ING. ARIOLA BEO		
SPECIALIST	ING. FLORIANA TUSHA		
SPECIALIST	ING. ERSI VELIU		
SPECIALIST	ING. GARNI MYZEDARI		
SPECIALIST	ING. ARBEN MUCA		
SPECIALIST	TOP. VASIL LENA		



REPUBLIKA E SHQIPËRISE
BASHKIA LUSHNJË
SEKTORI I PROJEKTIMIT



RELIEVI

PLANIMETRIA E RRUGËS

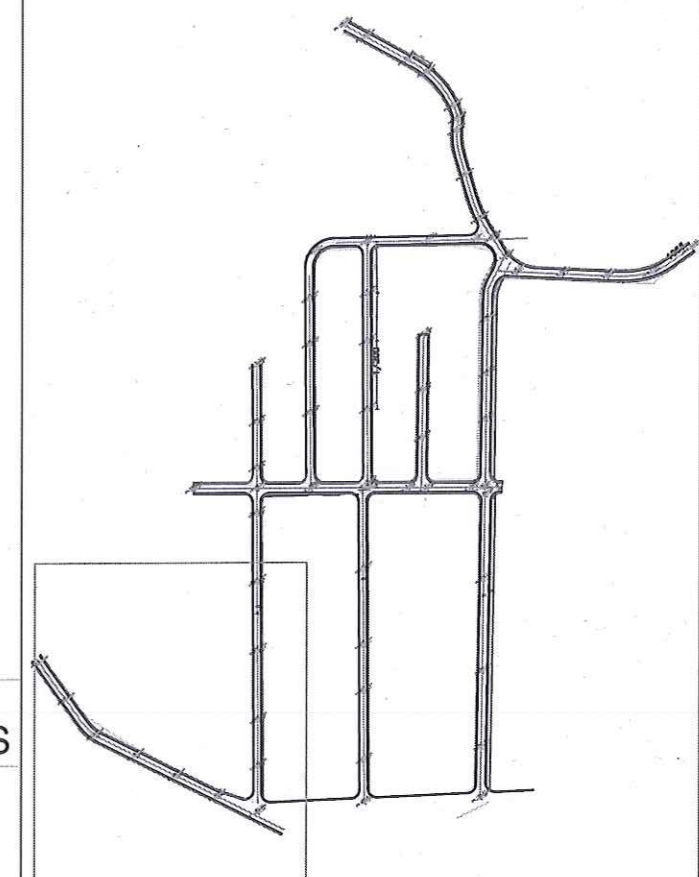
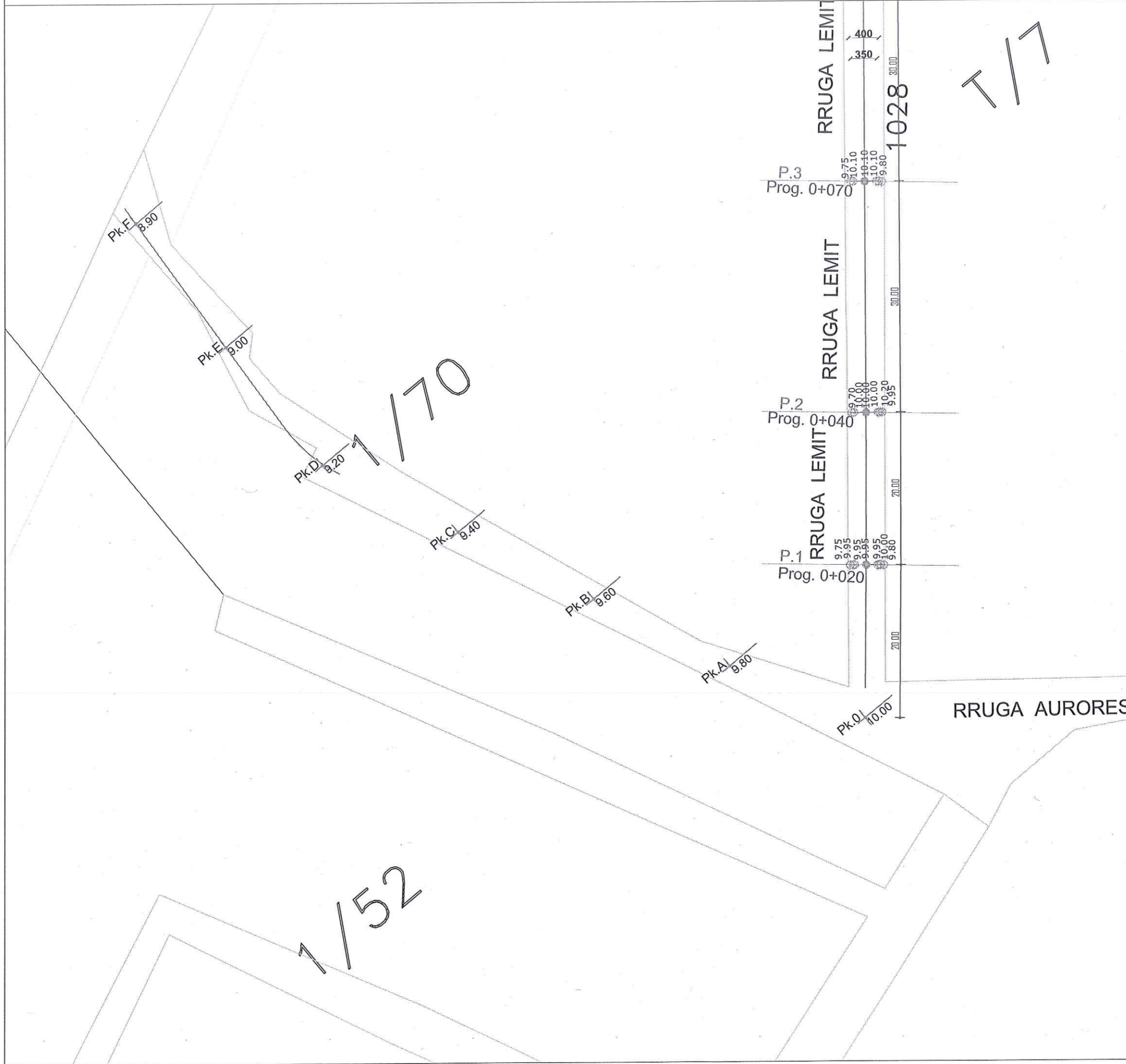

OBJEKTI	URBANIZIMI I BLOKUT TË BANIMIT NË DUSHK SEKTOR	NR.FLETES	A-
VENDNDODHJA	DUSHK SEKTOR, NJESIA ADMINISTRATIVE DUSHK, BASHKIA LUSHNJE	FORMATI	420X297
EMERT. I FLETES	PLANIMETRIA E RRUGES	SHKALLA	1:500
DREJTORIA	ING. MIMOZA HAXHIU		
PERGJEGJES	ARK. ALBAN MANDOKU		
SPECIALIST	ING. ARIOLA BEOO		
SPECIALIST	ING. FLORIANA TUSHA		
SPECIALIST	ING. ERSI VELIU		
SPECIALIST	ING. GANI MYZEDARI		
SPECIALIST	ING. ARBEN MUCA		
SPECIALIST	TOP. VASIL LENA		

PLANIMETRIA E RRUGËS

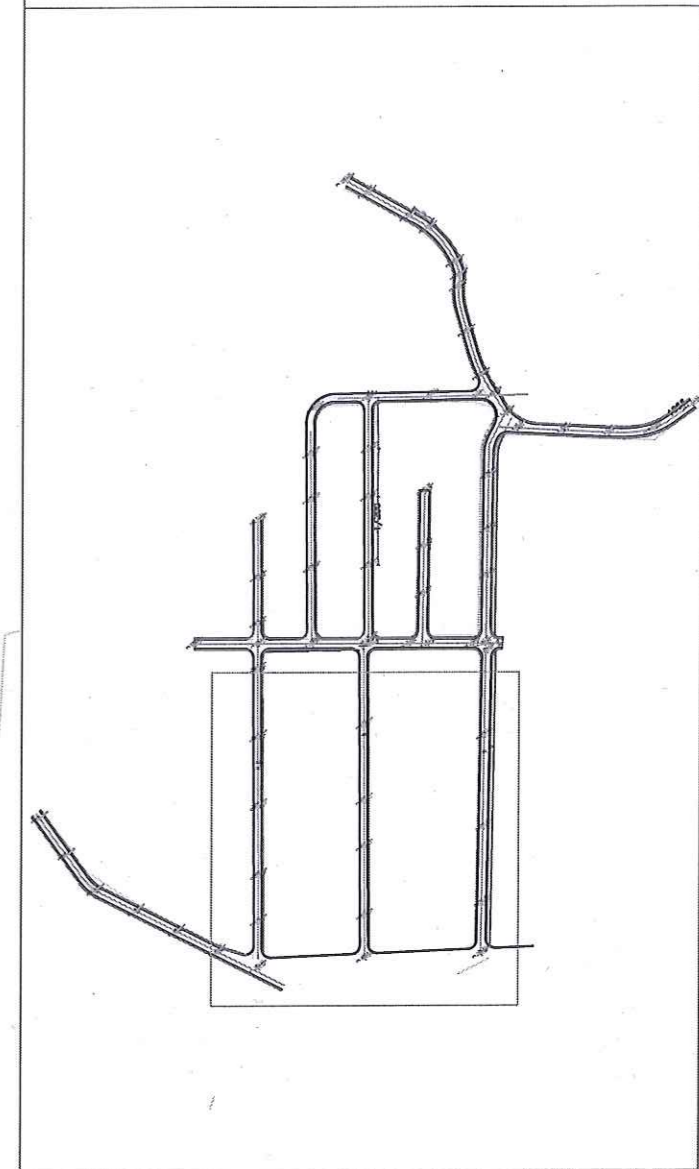
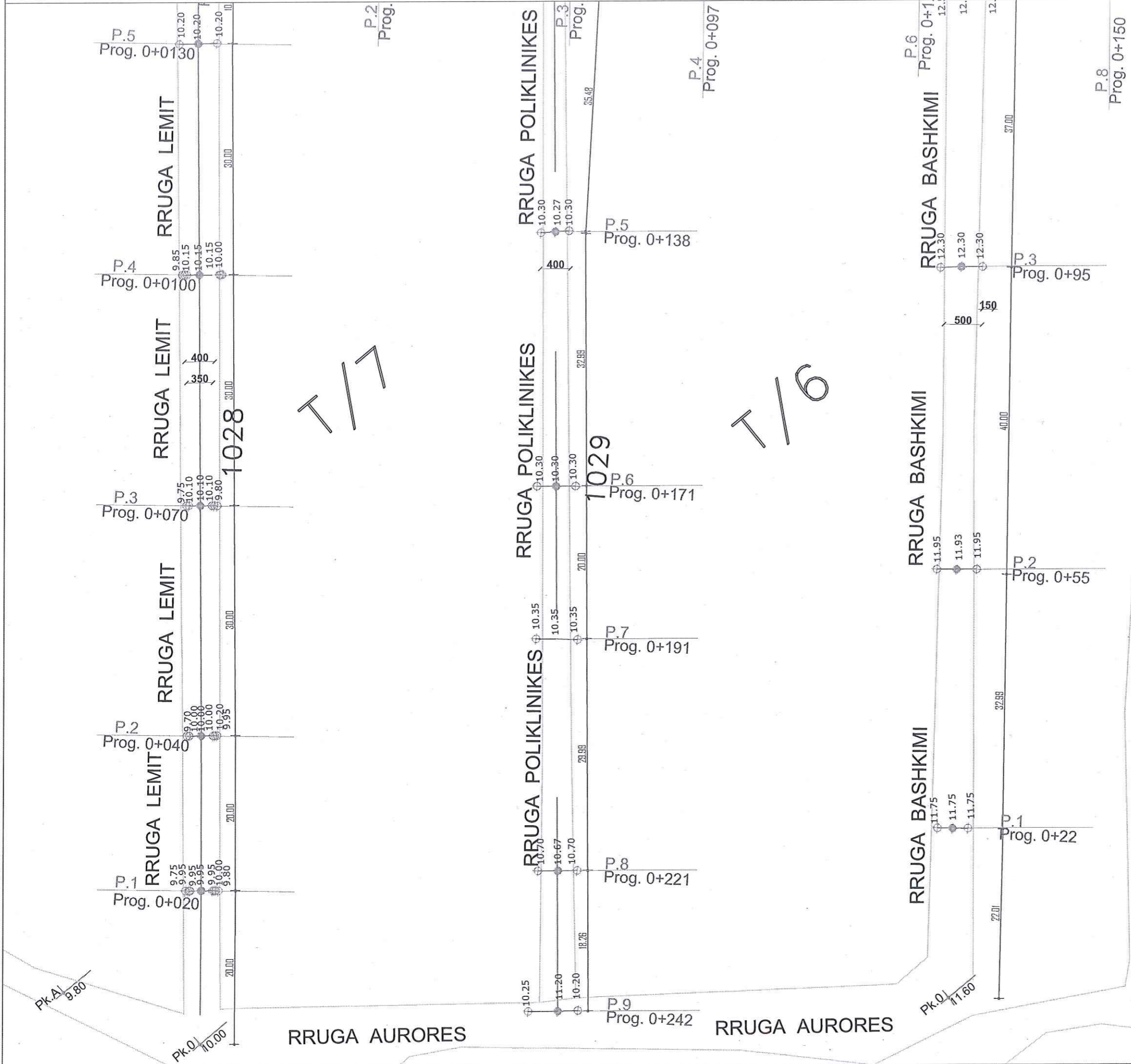

OBJEKTI	URBANIZIMI I BLOKUT TË BANIMIT NË DUSHKË SEKTOR	NR.FLETES	A-
VENDNDODHJA	DUSHKË SEKTOR, NJËSIA ADMINISTRATIVE DUSHKË, BASHKIA LUSHNJË	FORMATI	420X297
EMERT. I FLETES	PLANIMETRIA E RRUGËS	SHKALLA	1:500
DREJTORIA	ING. MIMOZA HAXHIU		
PERGJEGJES	ARK. ALBAN MANOKU		
SPECIALIST	ING. ARIOLA BEO		
SPECIALIST	ING. FLORIANA TUSHA		
SPECIALIST	ING. ERSI VELIU		
SPECIALIST	ING. GANI MYZEDARI		
SPECIALIST	ING. ARBEN MUCA		
SPECIALIST	TOP. VASIL LENA		

PLANIMETRIA E RRUGËS

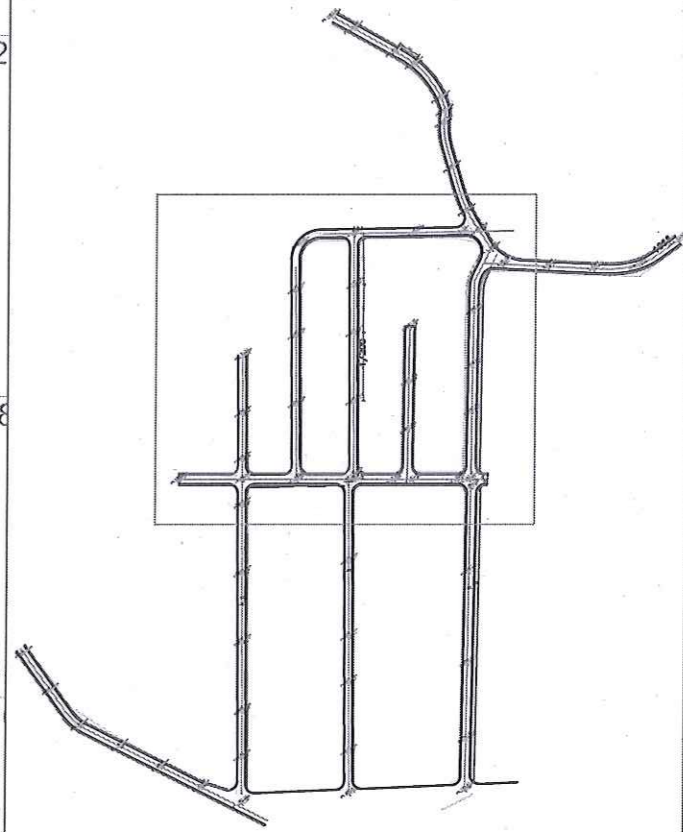
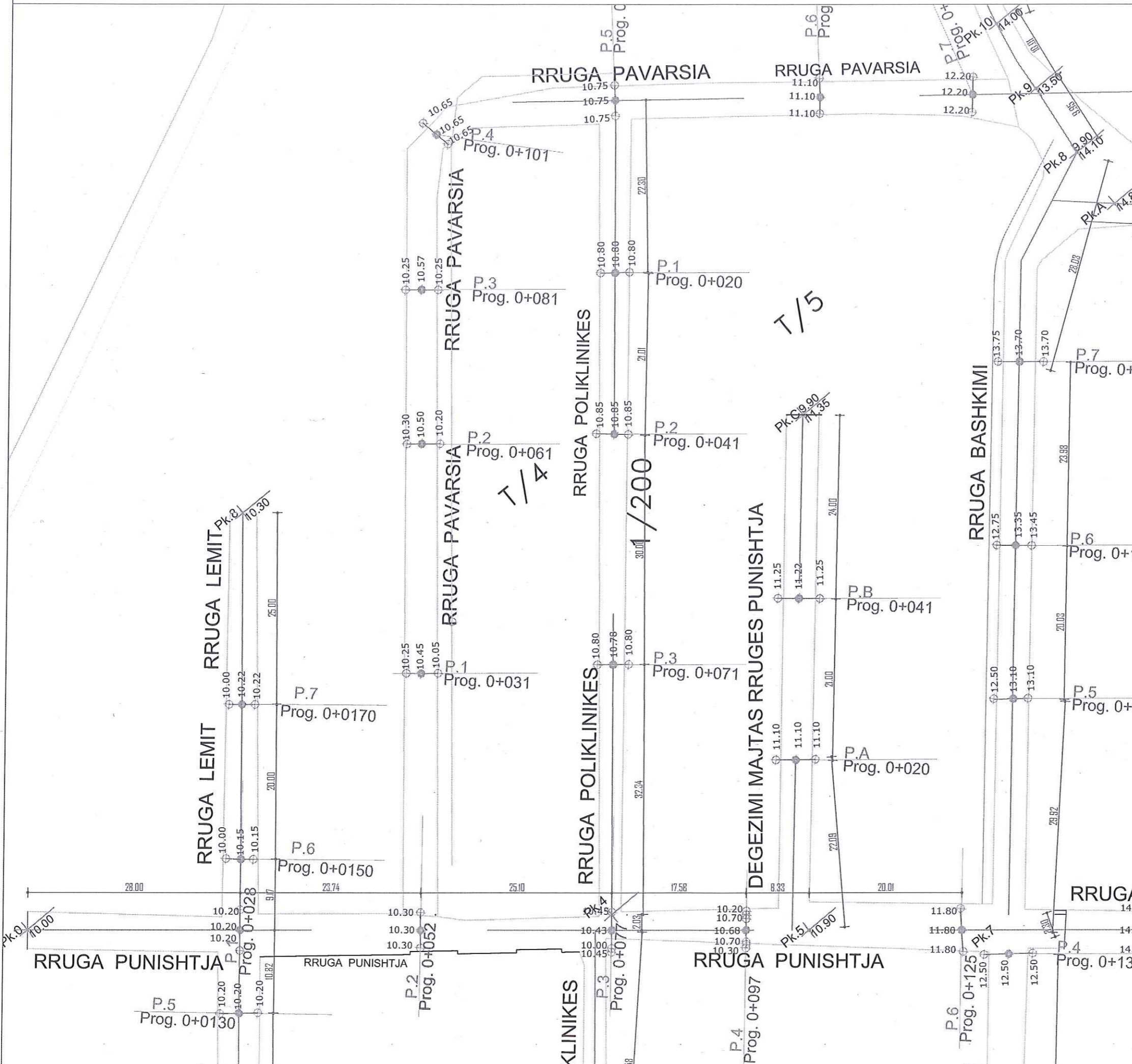

OBJEKTI	URBANIZIMI I BLOKUT TË BANIMIT NË DUSHK SEKTOR	NR.FLETES	A-
VENDNDODHJA	DUSHK SEKTOR, NJËSIA ADMINISTRATIVE DUSHK BASHKIA LUSHNJË	FORMATI	420X297
EMERT. I FLETES	PLANIMETRIA E RRUGËS	SHKALLA	1:500
DREJTORIA	ING. MIMOZA HAXHIU		
PERGJEGJES	ARK. ALBAN MANGKU		
SPECIALIST	ING. ARIOLA BEDO		
SPECIALIST	ING. FLORIANA TUSHA		
SPECIALIST	ING. ERSI VELIU		
SPECIALIST	ING. GANI MYZEDARI		
SPECIALIST	ING. ARBEN MUCA		
SPECIALIST	TOP. VASIL LENA		

REPUBLIKA E SHQIPËRIE
BASHKIA LUSHNJË
SEKTORI I PROJEKTIMIT

PLANIMETRIA E RRUGËS

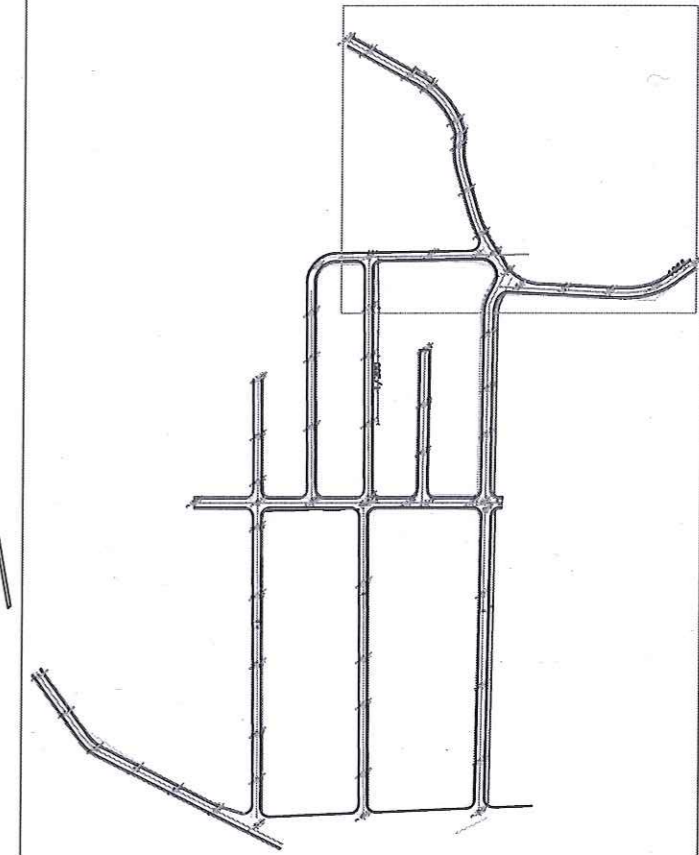

OBJEKTI	URBANIZIMI I BLOKUT TË BANIMIT NË DUSHK SEKTOR	NR.FLETES	A-
VENDNDODHJA	DUSHK SEKTOR, NJËSIA ADMINISTRATIVE DUSHK BASHKIA LUSHNJË	FORMATI	420X297
EMERT. I FLETES	PLANIMETRIA E RRUGËS	SHKALLA	1:500
DREJTORIA	ING. MIMOZA HAXHIU		
PERGJEGJES	ARK. ALBAN MANGUKU		
SPECIALIST	ING. ARIOLA BEQO		
SPECIALIST	ING. FLORIANA TUSHA		
SPECIALIST	ING. ERSI VELIU		
SPECIALIST	ING. GANI MYZEDARI		
SPECIALIST	ING. ARBEN MUCA		
SPECIALIST	TOP. VASIL LENA		



REPUBLIKA E SHQIPËRI
BASHKIA LUSHNJË
SEKTORI I PROJEKTIMIT



PROFILET GJATESORE

PROFILET GJATESORE , VAZHDIMI I RRUGES BASHKIMI NGA DEGEZIMI MAJTAS RRUGA PAVARSIA DERI NE RRUGEN DEMOKRACIA.

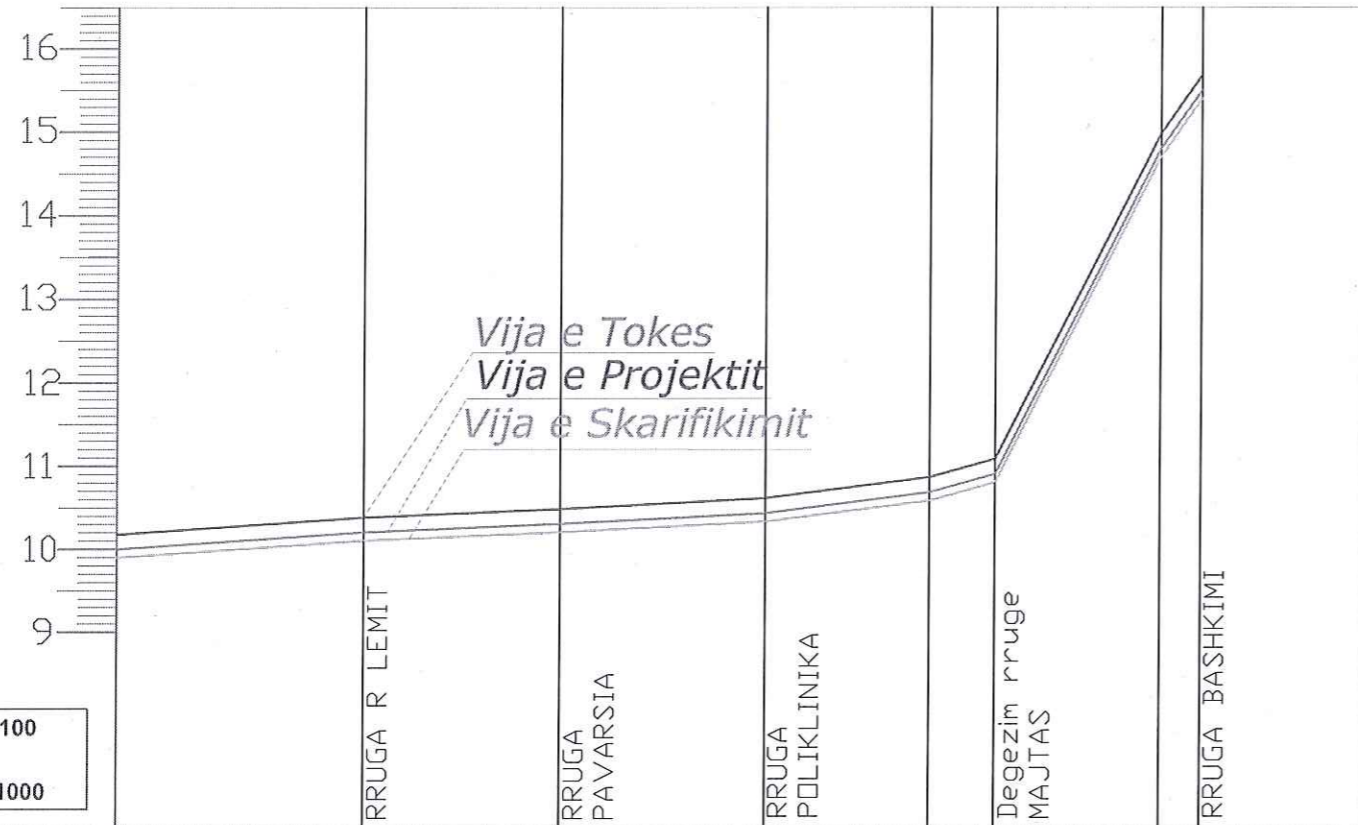

V=1:100
SH:
H=1:1000

PJERRESIA									
DIFERENCA	-0.18	-0.18	-0.18	-0.18	-0.18	-0.18	-0.18	-0.18	-0.18
KUOTA PROJEK	10.00	10.38	10.48	10.61	10.86	11.08	11.98	12.68	
KUOTA FAKTI	10.00	10.20	10.30	10.43	10.68	10.90	11.80	12.50	
NUMRI PIKETAVE	0	1	2	3	4	5	6	7	
D.PARCIALE	28	24	25	20	8	20	5		
D.PROGRESIVE	0.00	28.00	52.00	77.00	97.0	105.0	125.0	130.0	

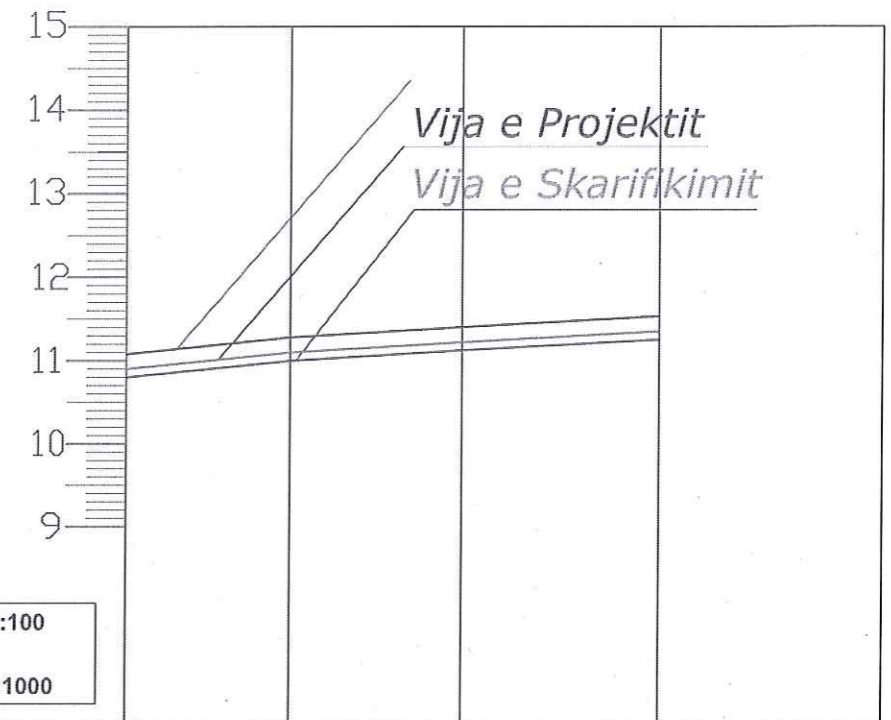

V=1:100
SH:
H=1:1000

PJERRESIA	i=6%			
DIFERENCA	0.18	0.18	0.18	0.18
KUOTA PROJEK	10.90	11.28	11.40	11.53
KUOTA FAKTI	10.90	11.10	11.22	11.35
NUMRI PIKETAVE	0	A	B	C
D.PARCIALE	20	21	24	
D.PROGRESIVE	0.00	20.00	41.00	65.00

OBJEKTI	URBANIZIMI I BLOKUT TË BANIMIT NË DUSHK SEKTOR	NR.FLETES	A-
VENDNDODHJA	DUSHK SEKTOR, NJËSIA ADMINISTRATIVE DUSHK, BASHKIA LUSHNJË	FORMATI	420X297
EMERT. I FLETES	PROFILAT E RRUGES	SHKALLA	1:500
DREJTORIA	ING. MIMOZA HAXHIU	 REPUBLIKA E SHQIPERISE BASHKIA LUSHNJË SEKTORI I PROJEKTIMIT	
PERGJEGJES	ARK. ALBAN MANOKU		
SPECIALIST	ING. ARIOLA BEGO		
SPECIALIST	ING. FLORIANA TUSHA		
SPECIALIST	ING. ERSI VELIU		
SPECIALIST	ING. GARNI MYZEDARI		
SPECIALIST	ING. ARBEN MUCA		
SPECIALIST	TOP. VASIL LENA		

PROFLET GJATESORE , RRUGA POLIKLINIKES.

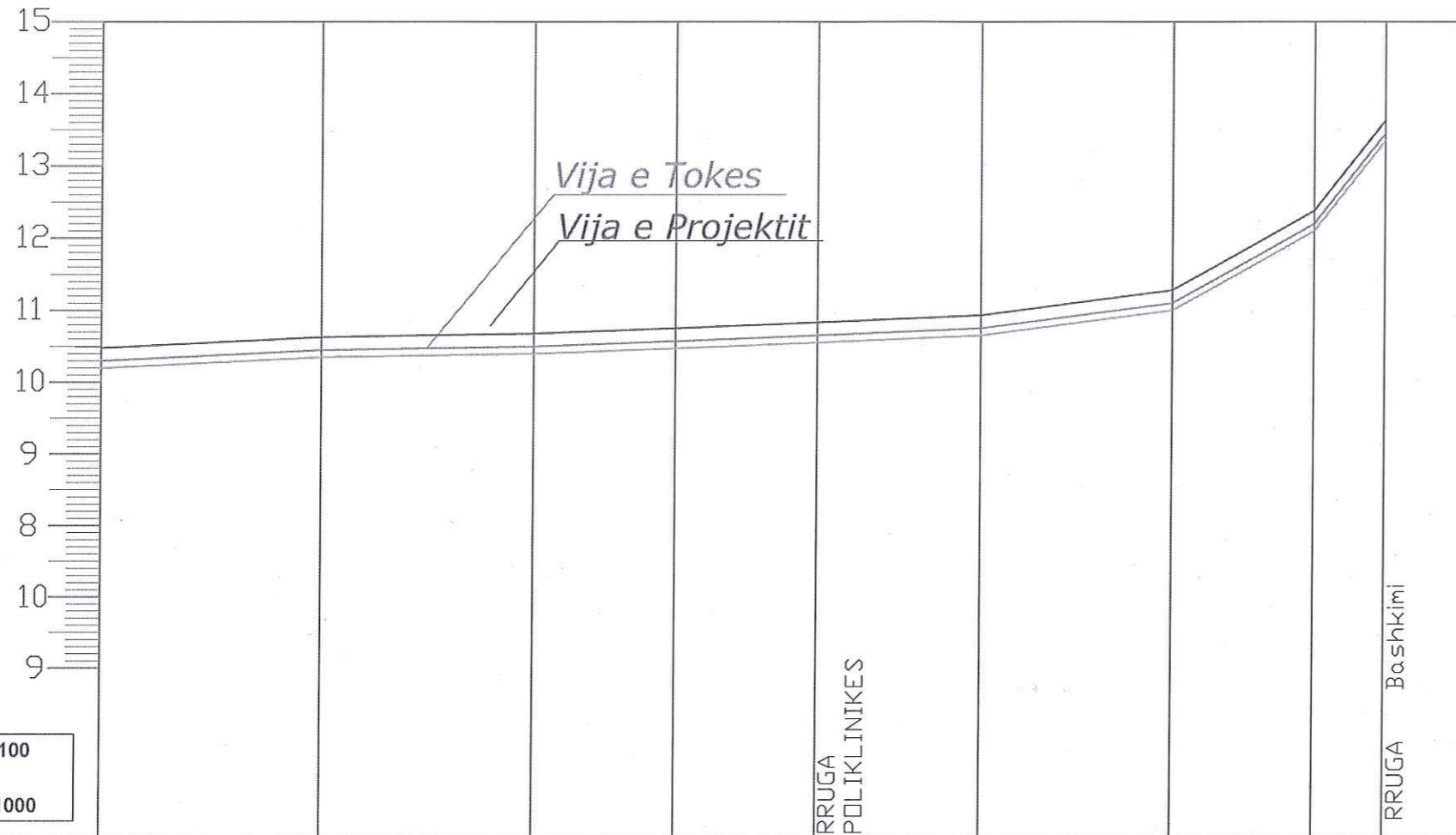

V=1:100
SH:
H=1:1000

PJERRESIA												
DIFERENCA	0.00	31	30	20	20	23	27	20	10	10	10	10
KUOTA PROJEKTI	10.30	10.45	10.50	10.57	10.65	10.75	11.10	11.28	12.20	12.38	13.45	13.63
KUOTA FAKTI	10.30	10.45	10.50	10.57	10.65	10.75	11.10	11.28	12.20	12.38	13.45	13.63
NUMRI PIKETAVE	0	1	2	3	4	5	6	7	8	9	10	11
D.PARCIALE	0.00	31	30	20	20	23	27	20	10	10	10	10
D.PROGRESIVE	0.00	-31.00	-31.00	-81.00	-101.0	-124.0	-151.0	-171.0	-181.0	-181.0	-181.0	-181.0

OBJEKTI	URBANIZIMI I BLOKUT TE BANIMIT NE DUSHK SEKTOR	NR.FLETES	A-
VENDNDODHJA	DUSHK SEKTOR, NJESIA ADMINISTRATIVE DUSHK, BASHKIA LUSHNJE	FORMATI	420X297
EMERT. I FLETES	PROFILAT E RRUGES	SHKALLA	1:500
DREJTORIA	ING. MIMOZA HAXHIU		
PERGJEGJES	ARK. ALBAN MANOKU		
SPECIALIST	ING. ARIOLA BEGO		
SPECIALIST	ING. FLORIANA TUSHA		
SPECIALIST	ING. ERSI VELIU		
SPECIALIST	ING. GARNI MYZEDARI		
SPECIALIST	ING. ARBEN MUCA		
SPECIALIST	TOP. VASIL LENA		



REPUBLIKA E SHQIPERISE
BASHKIA LUSHNJE
SEKTORI I PROJEKTIMIT

PROFILET GJATESORE , RRUGA POLIKLINIKES.

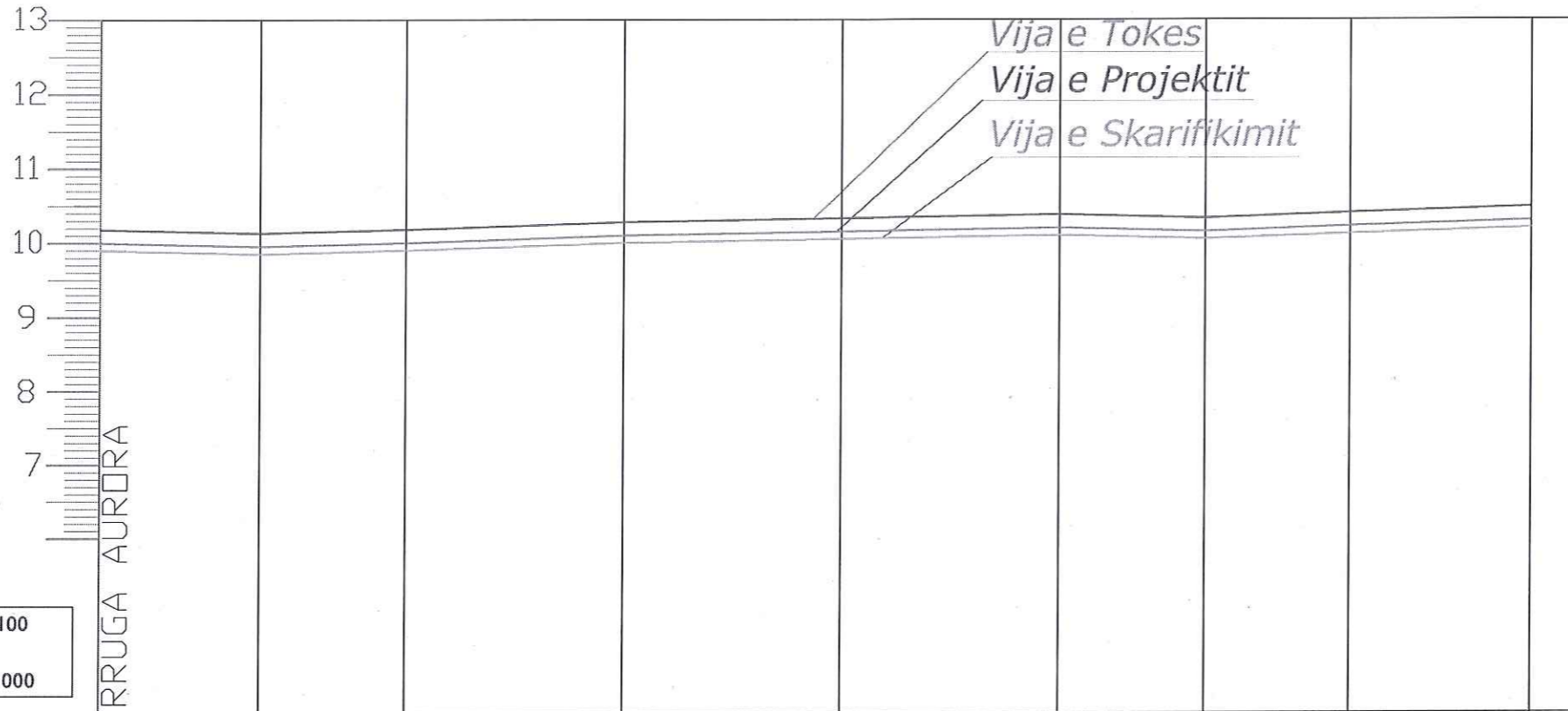

V=1:100
SH:
H=1:1000

PJERRESIA										
DIFERENCA	0.18	-0.18	-0.18	-0.18	-0.18	-0.18	-0.18	-0.18	-0.18	-0.18
KUOTA PROJEK	10.18	10.13	10.18	10.28	10.33	10.38	10.33	10.40	10.48	10.18
KUOTA FAKTI	10.00	9.95	10.00	10.10	10.15	10.20	10.15	10.22	10.30	10.00
NUMRI PIKETAVE	0	1	2	3	4	5	6	7	8	9
D.PARCIALE	20	20	30	30	30	20	20	25		
D.PROGRESIVE	0.00	20.00	40.00	70.00	100.0	130.0	150.0	170.0	195.0	

OBJEKTI	URBANIZIMI I BLOKUT TE BANIMIT NE DUSHK SEKTOR	NR.FLETES	A-
VENDODHJA	DUSHK SEKTOR, NJESIA ADMINISTRATIVE DUSHK, BASHKIA LUSHNJE	FORMATI	420X297
EMERT. I FLETES	PROFILAT E RRUGES	SHKALLA	1:500
DREJTORIA	ING. MIMOZA HAXHIU		
PERGJEGJES	ARK. ALBAN MANOKU		
SPECIALIST	ING. ARIOLA BEQQI		
SPECIALIST	ING. FLORIANA TUSHA		
SPECIALIST	ING. ERSI VELIU		
SPECIALIST	ING. GARNI MYZEGARI		
SPECIALIST	ING. ARBEN MUCA		
SPECIALIST	TOP. VASIL LENA		
			 REPUBLIKA E SHQIPERISE BASHKIA LUSHNJE SEKTORI I PROJEKTIMIT



PROFILE TERTHORE

PROFILET TERTHORE , DEGEZIMI NR.5 .



PK A

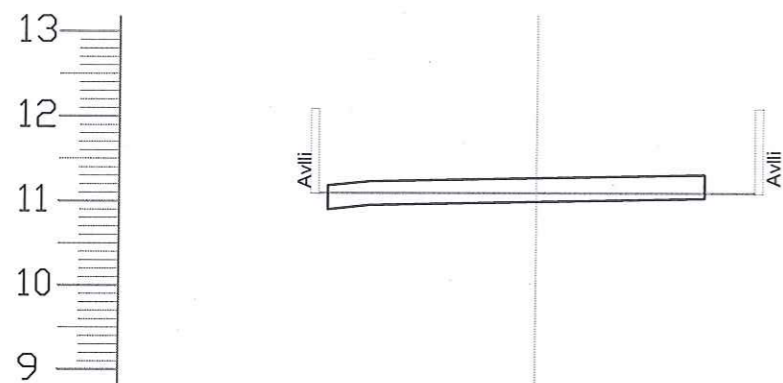

Kuota e Projektit	11.23	11.20	11.28	11.20
Distanca				
Kuota e Tokes	11.10	11.10	11.10	11.10
Distanca	260	260		

PK B

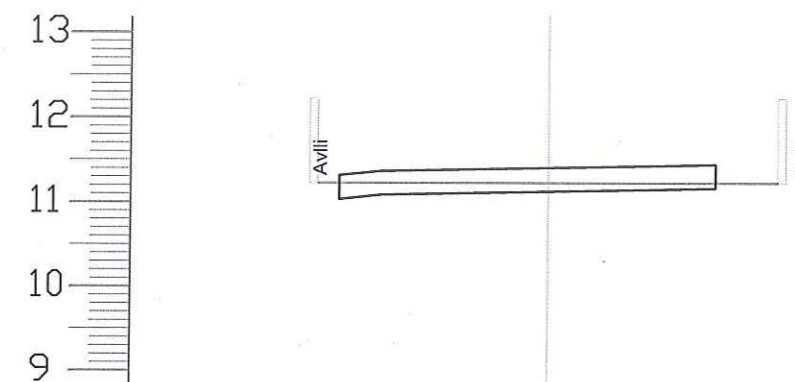

Kuota e Projektit	11.17	11.14	11.22	11.14
Distanca				
Kuota e Tokes	11.25	11.22	11.22	11.25
Distanca	275	275		

OBJEKTI	URBANIZIMI I BLOKUT TË BANIMIT NË DUSHK SEKTOR	NR.FLETES	A-
VENDNDODHJA	DUSHK SEKTOR, NJËSIA ADMINISTRATIVE DUSHK, BASHKIA LUSHNJË	FORMATI	420X297
EMERT. I FLETES	PROFILAT E RRUGES	SHKALLA	1:500
DREJTORIA	ING. MIMOZA HAXHIU		
PERGJEGJES	ARK. ALBAN MANDOKU		
SPECIALIST	ING. ARIOLA BEDO		
SPECIALIST	ING. FLORIANA TUSHA		
SPECIALIST	ING. ERSI VELIU		
SPECIALIST	ING. GARNI MYZEDARI		
SPECIALIST	ING. ARBEN MUCA		
SPECIALIST	TOP. VASIL LENA		
 REPUBLIKA E SHQIPERISE BASHKIA LUSHNJË SEKTORI I PROJEKTIMIT			

PROFILET TERTHORE , VAZHDIMI RRUGES NGA DEGEZIMI MAJTAS RR.PAVARESIA DERI NE RRUGEN DEMOKRACIA .

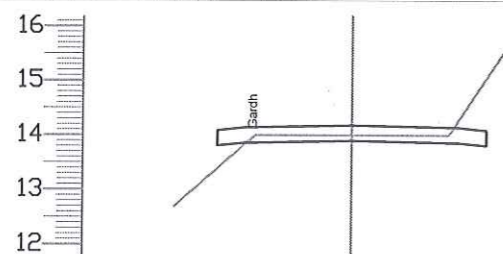

PK10

Kuota e Projektit	14.13	14.14	14.18	14.14	14.13
Distanca					
Kuota e Tokes	12.70	14.00	14.00	14.00	15.50
Distanca	150	180	180	100	

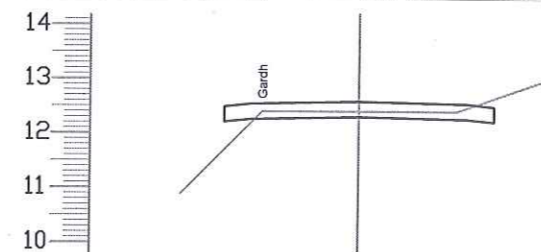

PK11

Kuota e Projektit	12.53	12.54	12.58	12.54	12.53
Distanca					
Kuota e Tokes	10.90	12.40	12.40	12.40	13.10
Distanca	150	180	180	200	

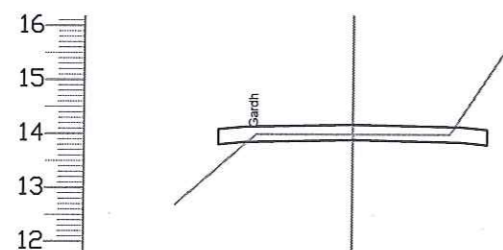

PK15

Kuota e Projektit	10.53	10.54	10.58	10.54	10.53
Distanca					
Kuota e Tokes	10.40	10.40	10.40	10.40	10.40
Distanca		320	320		

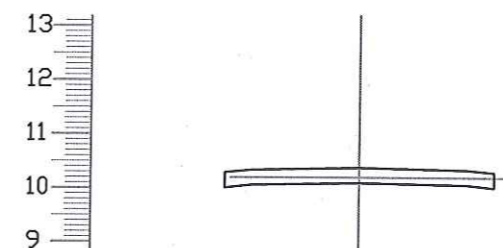

PK16

Kuota e Projektit	10.33	10.34	10.38	10.34	10.33
Distanca					
Kuota e Tokes	10.20	10.20	10.20	10.20	10.20
Distanca		240	240	60	

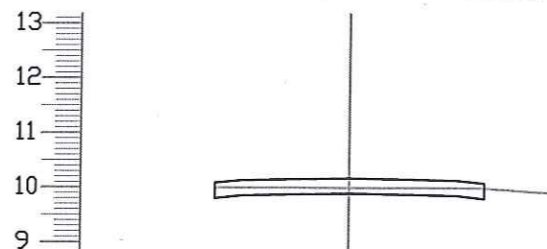

PK17

Kuota e Projektit	10.13	10.14	10.18	10.14	10.13
Distanca					
Kuota e Tokes	10.00	10.00	10.00	10.00	9.90
Distanca		250	250	150	

OBJEKTI	URBANIZIMI I BLOKUT TE BANIMIT NE DUSHK SEKTOR	NR.FLETES	A-
VENDNDODHJA	DUSHK SEKTOR, NJESIA ADMINISTRATIVE DUSHK, BASHKIA LUSHNJE	FORMATI	420X297
EMERT. I FLETES	PROFILAT E RRUGES	SHKALLA	1:500
DREJTORIA	ING. MIMOZA HAXHIU		
PERGJEGJES	ARK. ALBAN MANOKU		
SPECIALIST	ING. ARIOLA BEO		
SPECIALIST	ING. FLORIANA TUSA		
SPECIALIST	ING. ERSI VELIU		
SPECIALIST	ING. GARNI MYZEQARI		
SPECIALIST	ING. ARBEN MUCA		
SPECIALIST	TOP. VASIL LENA		



REPUBLIKA E SHQIPERISE
BASHKIA LUSHNJE
SEKTORI I PROJEKTIMIT

PROFILET TERTHORE , RRUGA PAVARESIA.

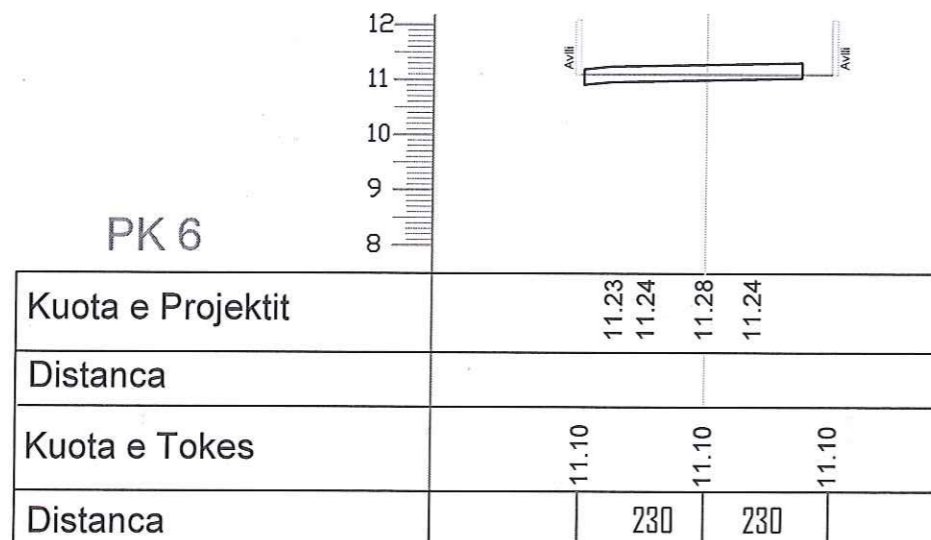
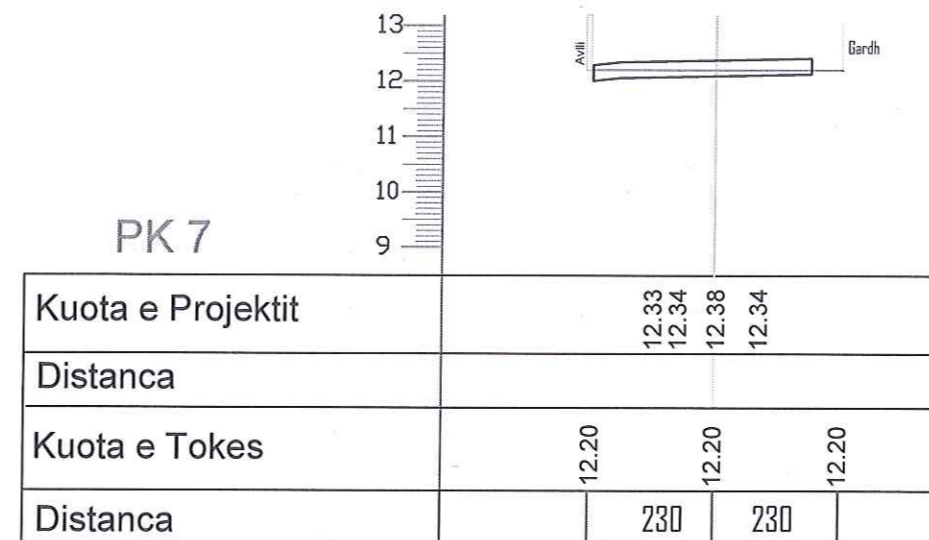
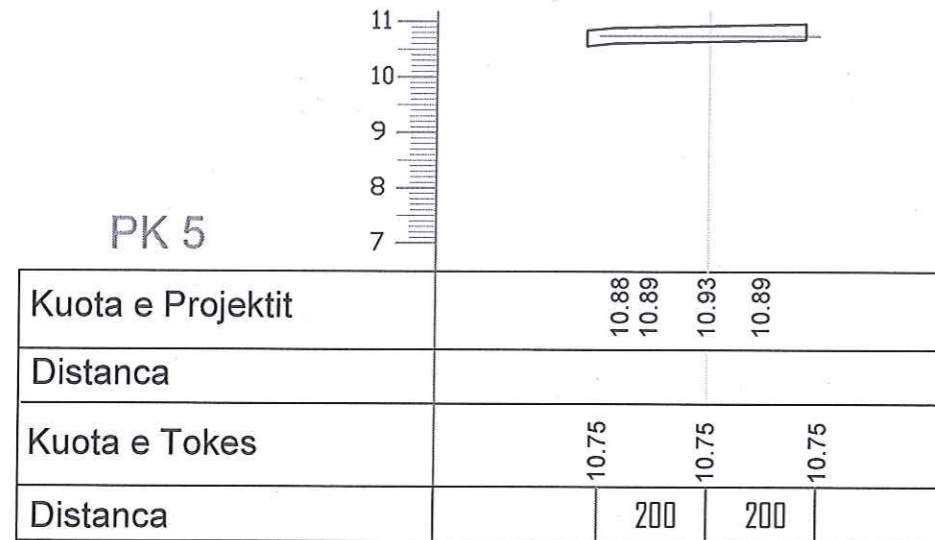

OBJEKTI	URBANIZIMI I BLOKUT TE BANIMIT NE DUSHK SEKTOR	NR.FLETES	A-
VENDNDODHJA	DUSHK SEKTOR, NJESIA ADMINISTRATIVE DUSHK, BASHKIA LUSHNJE	FORMATI	420X297
EMERT. I FLETES	PROFILAT E RRUGES	SHKALLA	1:500
DREJTORIA	ING. MIMOZA HAXHIU		
PERGJEGJES	ARK. ALBAN MANOKU		
SPECIALIST	ING. ARIOLA BEDO		
SPECIALIST	ING. FLORIANA TUSHA		
SPECIALIST	ING. ERSI VELIU		
SPECIALIST	ING. GARNI MYZEGARI		
SPECIALIST	ING. ARBEN MUCA		
SPECIALIST	TOP. VASIL LENA		



REPUBLIKA E SHQIPERISE
BASHKIA LUSHNJE
SEKTORI I PROJEKTIMIT

PROFILET TERTHORE , RRUGA PAVARESIA.



PK 1

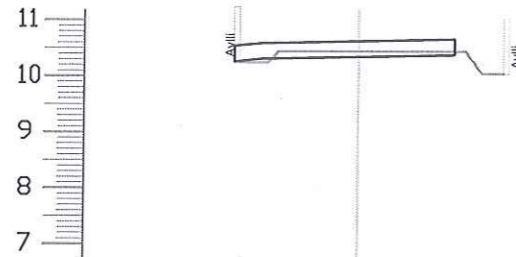

Kuota e Projektit		10.58	10.59	10.63	10.59
Distanca					
Kuota e Tokes		10.25	10.25	10.45	10.45
Distanca		30	20	145	145
				50	30

PK 3

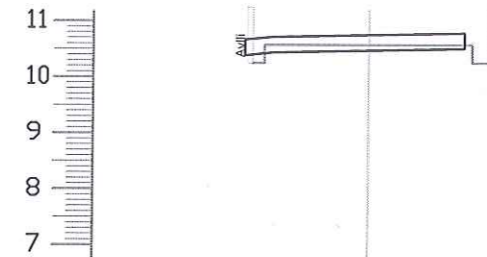

Kuota e Projektit		10.70	10.71	10.75	10.71
Distanca					
Kuota e Tokes		10.25	10.75	10.57	10.75
Distanca		20	190	190	30

PK 2

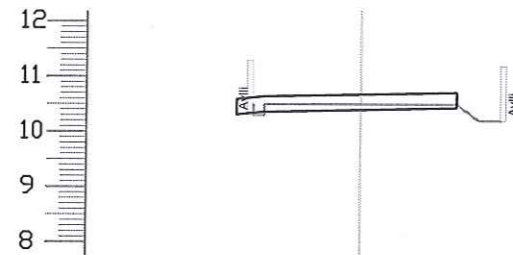

Kuota e Projektit		10.63	10.64	10.68	10.64
Distanca					
Kuota e Tokes		10.30	10.50	10.50	10.50
Distanca		20	175	175	40
					30

PK 4

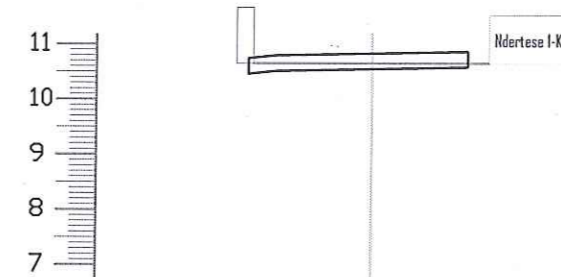

Kuota e Projektit		10.78	10.79	10.83	10.79
Distanca					
Kuota e Tokes		10.65	10.65	10.65	10.65
Distanca			215	215	

OBJEKTI	URBANIZIMI I BLOKUT TE BANIMIT NE DUSHK SEKTOR	NR.FLETES	A-
VENDODHJA	DUSHK SEKTOR, NJESIA ADMINISTRATIVE DUSHK, BASHKIA LUSHNJE	FORMATI	420X297
EMERT. I FLETES	PROFILAT E RRUGES	SHKALLA	1:500
DREJTORIA	ING. MIMOZA HAXHIU		
PERGJEGJES	ARK. ALBAN MANOKU		
SPECIALIST	ING. ARIOLA BEO		
SPECIALIST	ING. FLORIANA TUSHA		
SPECIALIST	ING. ERSI VELIU		
SPECIALIST	ING. GARNI MYZEDARI		
SPECIALIST	ING. ARBEN MUCA		
SPECIALIST	TOP. VASIL LENA		



REPUBLIKA E SHQIPERISE
BASHKIA LUSHNJE
SEKTORI I PROJEKTIMIT

PROFLET TERTHORE , RRUGA POLIKLINIKES.



PK 6

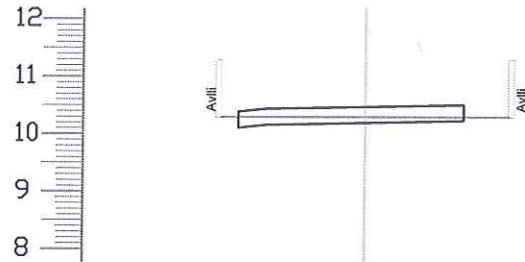

Kuota e Projektit	10.43	10.44	10.48	10.44
Distanca				
Kuota e Tokes	10.30		10.30	10.30
Distanca		255	255	

PK 8

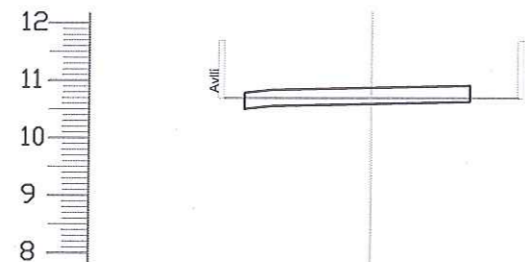

Kuota e Projektit	10.80	10.81	10.85	10.81
Distanca				
Kuota e Tokes	10.70		10.67	10.70
Distanca		260	260	

PK 9

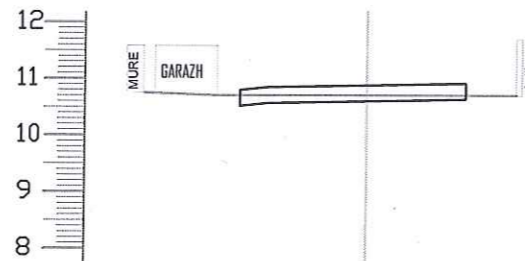

Kuota e Projektit	11.33	11.34	11.38	11.34
Distanca				
Kuota e Tokes	1125	1120	1120	1120
Distanca	130	265	265	

OBJEKTI	URBANIZIMI I BLOKUT TË BANIMIT NË DUSHK SEKTOR	NR.FLETES	A-
VENDNDODHJA	DUSHK SEKTOR, NJESIA ADMINISTRATIVE DUSHK, BASHKIA LUSHNJE	FORMATI	420X297
EMERT. I FLETES	PROFILAT E RRUGES	SHKALLA	1:500
DREJTORIA	ING. MIMOZA HAXHIU		
PERGJEGJES	ARK. ALBAN MANOKU		
SPECIALIST	ING. ARIOLA BEDO		
SPECIALIST	ING. FLORIANA TUSHA		
SPECIALIST	ING. ERSI VELIU		
SPECIALIST	ING. GARNI MYZEDARI		
SPECIALIST	ING. ARBEN MUCA		
SPECIALIST	TOP. VASIL LENA	REPUBLIKA E SHQIPERISE BASHKIA LUSHNJE SEKTORI I PROJEKTIMIT	

PROFLET TERTHORE , RRUGA POLIKLINIKES.



PK 1

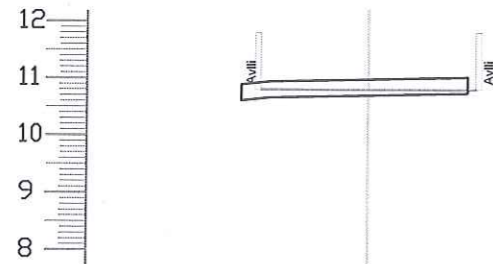

Kuota e Projektit	10.93	10.94	10.98	10.94
Distanca				
Kuota e Tokes	10.80	10.80	10.80	
Distanca	190	190		

PK 3

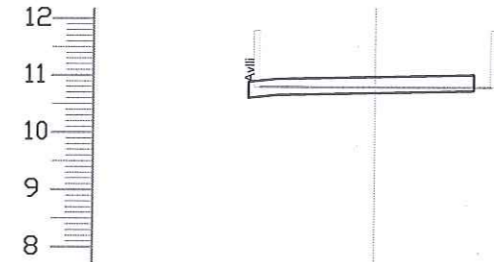

Kuota e Projektit	10.91	10.92	10.96	10.92
Distanca				
Kuota e Tokes	10.80	10.78	10.80	
Distanca	205	205		

PK 2

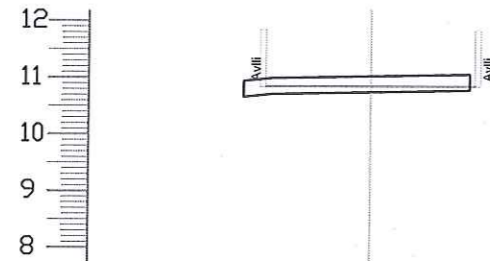

Kuota e Projektit	10.98	10.96	11.03	10.96
Distanca				
Kuota e Tokes	10.85	10.85	10.85	
Distanca	190	190		

PK 4

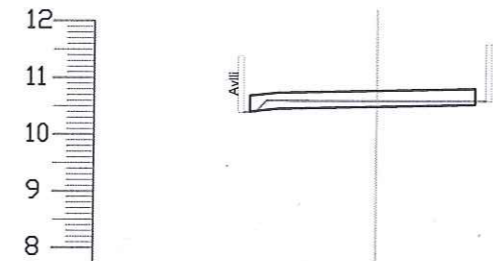

Kuota e Projektit	10.73	10.74	10.78	10.74
Distanca				
Kuota e Tokes	10.40	10.60	10.60	10.60
Distanca	200	195	195	

PK 6

Kuota e Projektit	
Distanca	
Kuota e Tokes	
Distanca	

PK 5

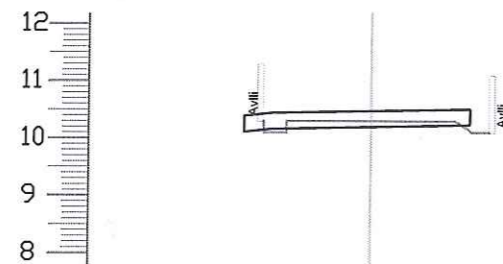

Kuota e Projektit	10.40	10.41	10.45	10.41
Distanca				
Kuota e Tokes	10.10	10.30	10.27	10.30
Distanca	40	150	150	30

PK 7

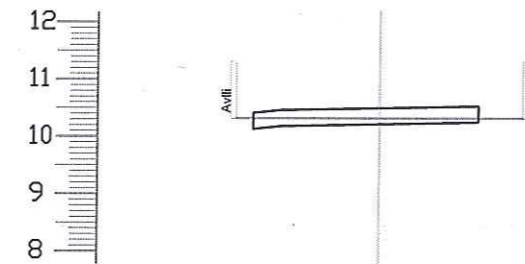

Kuota e Projektit	10.48	10.49	10.53	10.49
Distanca				
Kuota e Tokes	10.35	10.35	10.35	
Distanca	275	275		

OBJEKTI	URBANIZIMI I BLOKUT TË BANIMIT NË DUSHK SEKTOR	NR.FLETES	A-
VENDNDODHJA	DUSHK SEKTOR, NJESIA ADMINISTRATIVE DUSHK, BASHKIA LUSHNJE	FORMATI	420X297
EMERT. I FLETES	PROFILAT E RRUGES	SHKALLA	1:500
DREJTORIA	ING. MIMOZA HAXHIU		
PERGJEGJES	ARK. ALBAN MANOKU		
SPECIALIST	ING. ARIOLA BEDO		
SPECIALIST	ING. FLORIANA TUSHA		
SPECIALIST	ING. ERSI VELIU		
SPECIALIST	ING. GARNI MYZEQARI		
SPECIALIST	ING. ARBEN MUCA		
SPECIALIST	TOP. VASIL LENA		



REPUBLIKA E SHQIPERISE
BASHKIA LUSHNJE
SEKTORI I PROJEKTIMIT

PROFILET TERTHORE , RRUGA LEMIT.

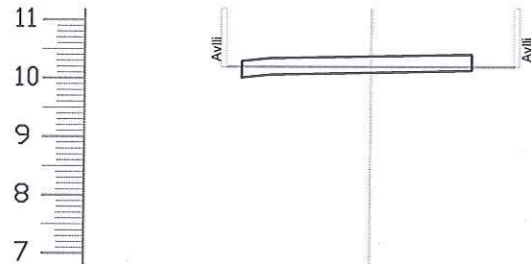

PK 5

Kuota e Projektit	10.33	10.34	10.38	10.34
Distanca				
Kuota e Tokes	10.20		10.20	10.20
Distanca		250	250	

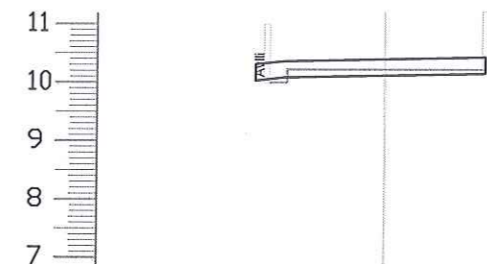

PK 7

Kuota e Projektit	10.35	10.36	10.40	10.36
Distanca				
Kuota e Tokes	10.22		10.22	10.22
Distanca	30	175	175	

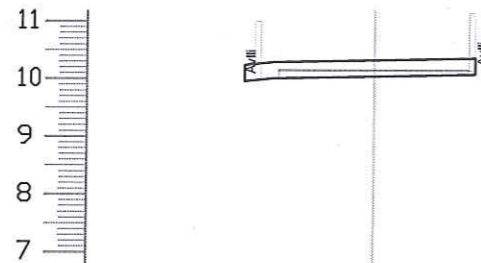

PK 6

Kuota e Projektit	10.28	10.29	10.33	10.29
Distanca				
Kuota e Tokes	10.15		10.15	10.15
Distanca	30	165	165	

OBJEKTI	URBANIZIMI I BLOKUT TË BANIMIT NË DUSHK SEKTOR	NR.FLETES	A-
VENDNDODHJA	DUSHK SEKTOR, NJËSIA ADMINISTRATIVE DUSHK, BASHKIA LUSHNJË	FORMATI	420X297
EMERT. I FLETES	PROFILAT E RRUGES	SHKALLA	1:500
DREJTORIA	ING. MIMOZA HAXHILI		
PERGJEGJES	ARK. ALBAN MANOKU		
SPECIALIST	ING. ARIOLA BEDO		
SPECIALIST	ING. FLORIANA TUSHA		
SPECIALIST	ING. ERSI VELIU		
SPECIALIST	ING. GARNI MYZEDARI		
SPECIALIST	ING. ARBEN MUCA		
SPECIALIST	TOP. VASIL LENA	REPUBLIKA E SHQIPERISE	BASHKIA LUSHNJË
		SEKTORI I PROJEKTIMIT	

PROFILET TERTHORE , RRUGA LEMIT.

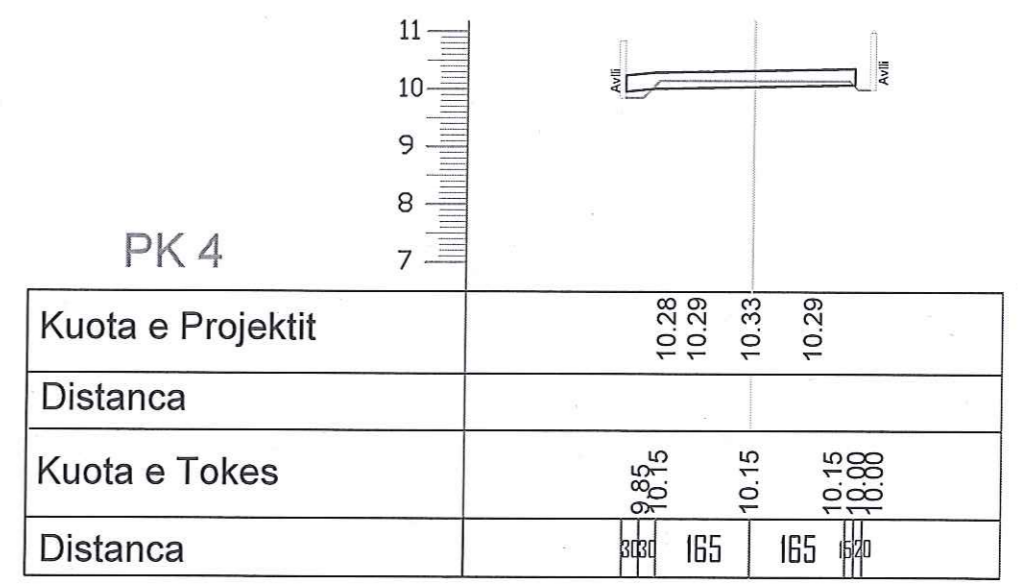
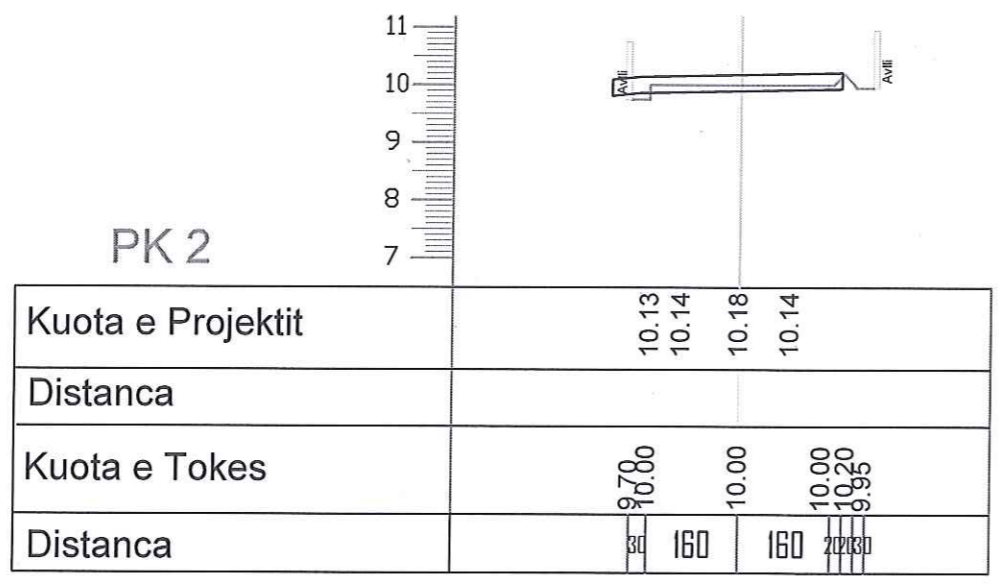
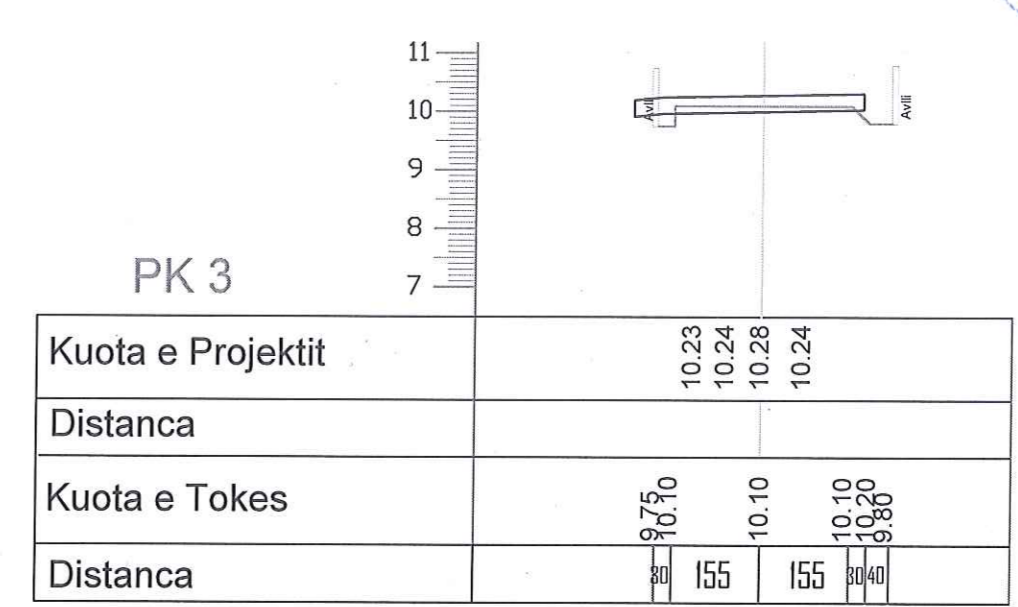
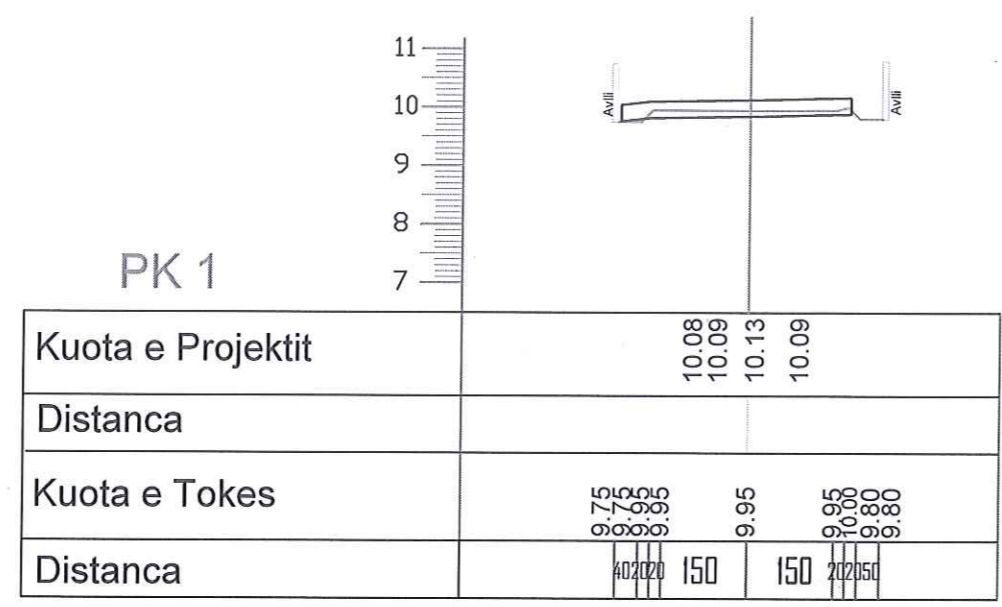

OBJEKTI	URBANIZIMI I BLOKUT TË BANIMIT NË DUSHK SEKTOR	NR.FLETES	A-
VENDNDODHJA	DUSHK SEKTOR, N.JESIA ADMINISTRATIVE DUSHK, BASHKIA LUSHNJE	FORMATI	420X297
EMERT. I FLETES	PROFILAT E RRUGES	SHKALLA	1:500
DREJTORIA	ING. MIMOZA HAXHIU	<p>REPUBLIKA E SHQIPERISE BASHKIA LUSHNJE SEKTORI I PROJEKTIMIT</p>	
PERGJEGJES	ARK. ALBAN MANKU		
SPECIALIST	ING. ARIOLA BEO		
SPECIALIST	ING. FLORIANA TUSHA		
SPECIALIST	ING. ERSI VELIU		
SPECIALIST	ING. GARNI MYZEDARI		
SPECIALIST	ING. ARBEN MUCA		
SPECIALIST	TOP. VASIL LENA		

PROFILET TERTHORE , RRUGA PUNISHTJA.

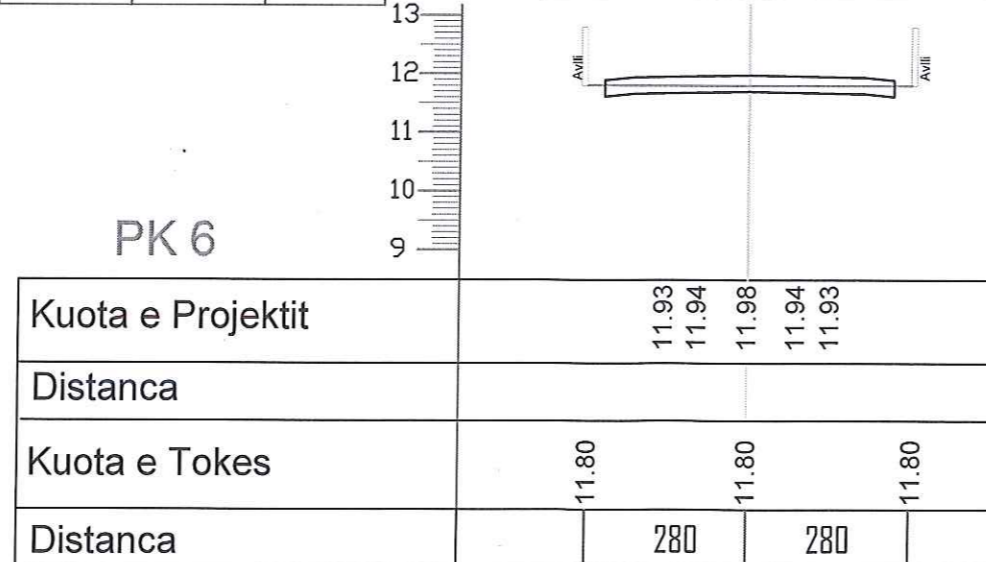
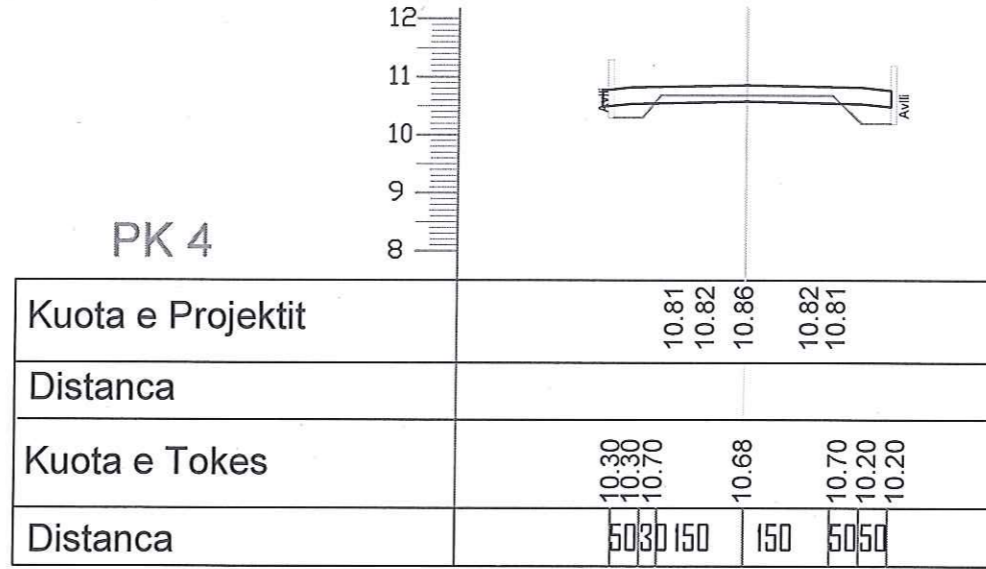
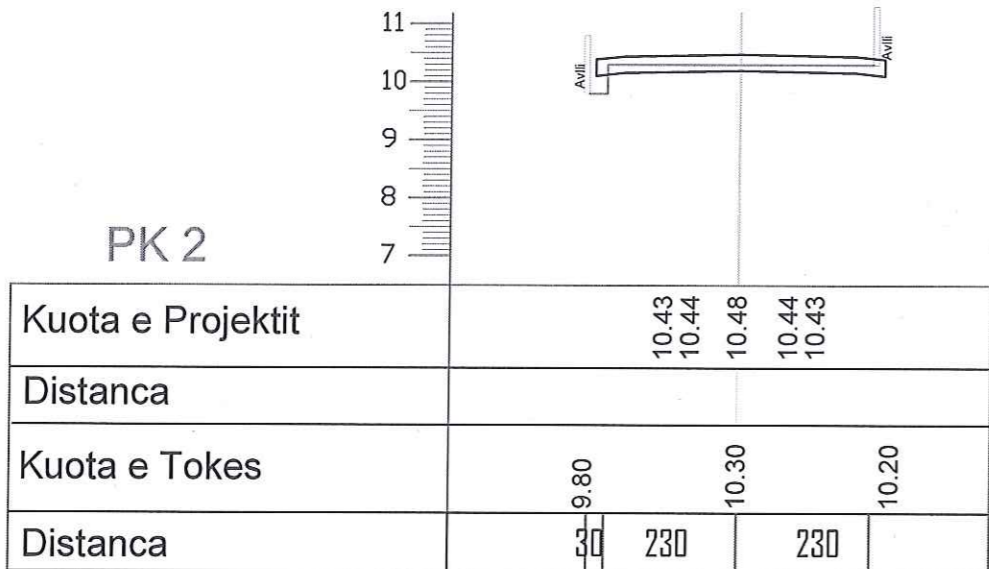
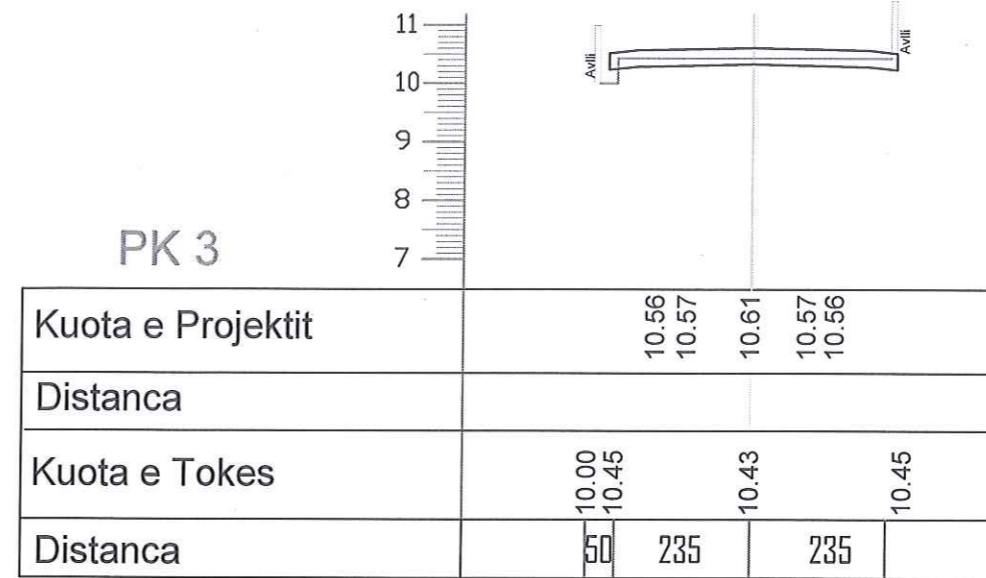
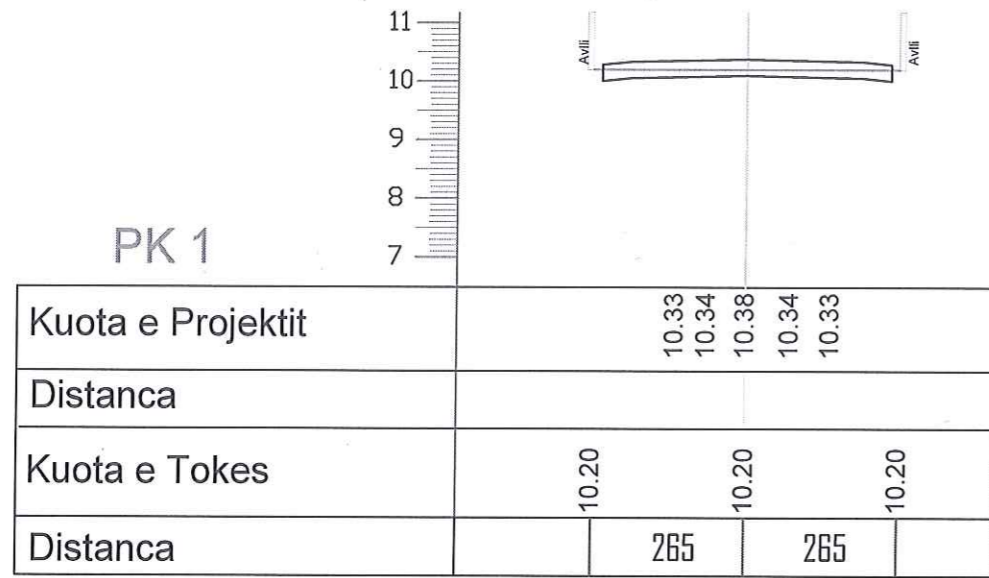

OBJEKTI	URBANIZIMI I BLOKUT TË BANIMIT NË DUSHK SEKTOR	NR.FLETES	A-
VENDNDODHJA	DUSHK SEKTOR, NJËSIA ADMINISTRATIVE DUSHK, BASHKIA LUSHNJE	FORMATI	420X297
EMERT. I FLETES	PROFILAT E RRUGES	SHKALLA	1:500
DREJTORIA	ING. MIMOZA HAXHIU		
PERGJEGJES	ARK. ALBAN MANOKU		
SPECIALIST	ING. ARIOLA BEDO		
SPECIALIST	ING. FLORIANA TUSHA		
SPECIALIST	ING. ERSI VELIU		
SPECIALIST	ING. GARNI MYZEDARI		
SPECIALIST	ING. ARBEN MUCA		
SPECIALIST	TOP. VASIL LENA		
			 REPUBLIKA E SHQIPERISE BASHKIA LUSHNJE SEKTORI I PROJEKTIMIT

PROFLET TERTHORE , RRUGA BASHKIMI.



PK 5

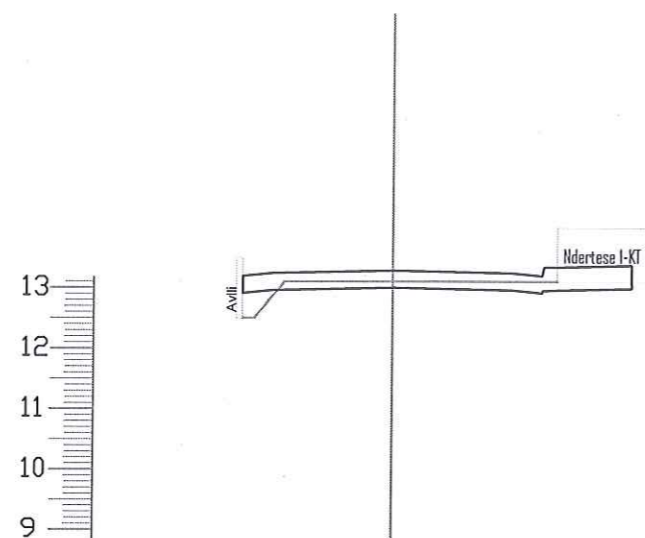

Kuota e Projektit	13.23 13.24	13.28	13.24 13.23	13.25
Distanca				
Kuota e Tokes	12.50 12.58 13.10	13.10	13.10	13.10 13.10
Distanca	20 50 20	160	160	40

PK 7

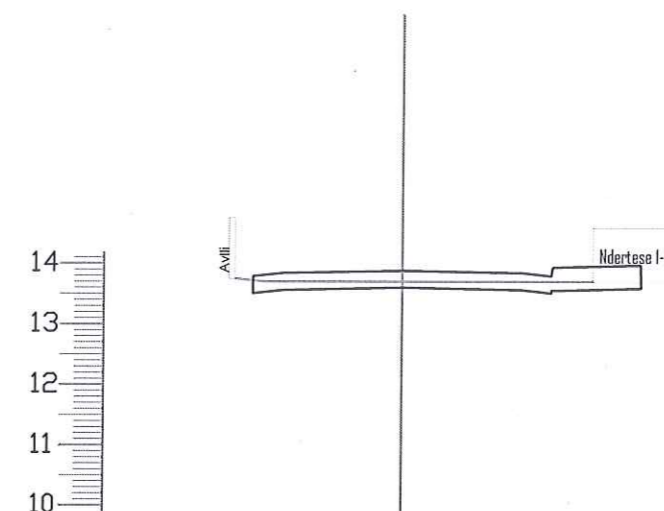

Kuota e Projektit	13.83 13.84	13.88	13.84 13.83	13.85
Distanca				
Kuota e Tokes	13.70 13.70	13.70	13.70	13.70
Distanca	50	230	230	90

PK 6

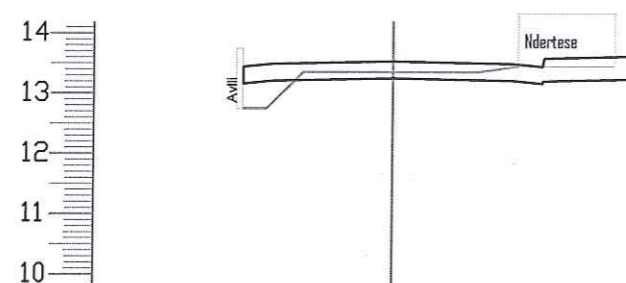

Kuota e Projektit	13.48 13.49	13.53	13.49 13.48	13.50
Distanca				
Kuota e Tokes	12.75 13.35 13.35	13.35	13.35	13.35 13.45
Distanca	40 50 20	140	140	70

OBJEKTI	URBANIZIMI I BLOKUT TË BANIMIT NË DUSHK SEKTOR	NR.FLETES	A-
VENDNDODHJA	DUSHK SEKTOR, NJËSIA ADMINISTRATIVE DUSHK, BASHKIA LUSHNJË	FORMATI	420X297
EMERT. I FLETES	PROFILAT E RRUGES	SHKALLA	1:500
DREJTORIA	ING. MIMOZA HAXHIU		
PERGJEGJES	ARK. ALBAN MANOKU		
SPECIALIST	ING. ARIOLA BEQO		
SPECIALIST	ING. FLORIANA TUSHA		
SPECIALIST	ING. ERSI VELIU		
SPECIALIST	ING. GARNI MYZEDARI		
SPECIALIST	ING. ARBEN MUCA		
SPECIALIST	TOP. VASIL LENA		
		REPUBLIKA E SHQIPERISE BASHKIA LUSHNJË SEKTORI I PROJEKTIMIT	

PROFLET TERTHORE , RRUGA BASHKIMI.

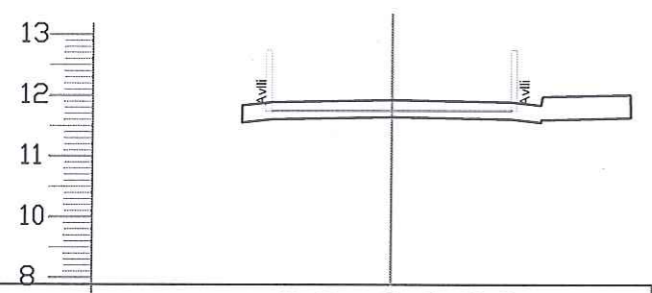

PK 1

Kuota e Projektit	11.88	11.89	11.93	11.89	11.88	11.90
Distanca						
Kuota e Tokes	11.75		11.75		11.75	
Distanca		200	200			

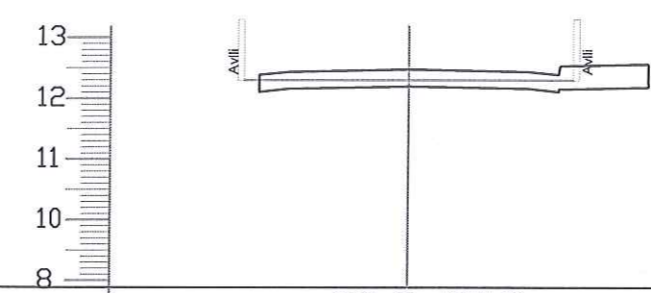

PK 3

Kuota e Projektit	12.44	12.45	12.49	12.45	12.44	12.46
Distanca						
Kuota e Tokes	12.30		12.30		12.30	
Distanca		275	275			

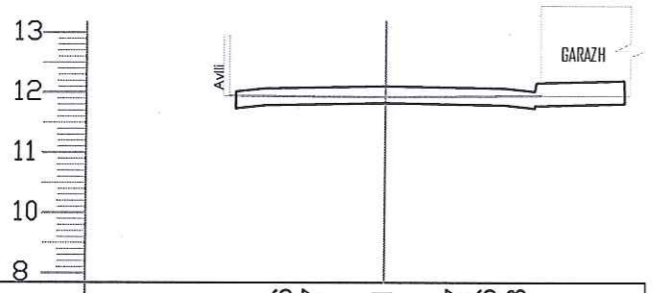

PK 2

Kuota e Projektit	12.06	12.07	12.11	12.07	12.06	12.08
Distanca						
Kuota e Tokes	11.95		11.93		11.95	
Distanca		260	260			

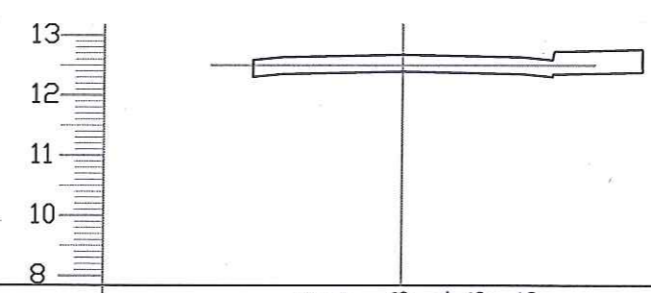

PK 4

Kuota e Projektit	12.63	12.64	12.68	12.64	12.63	12.65
Distanca						
Kuota e Tokes	12.50		12.50		12.50	
Distanca		320	320			

OBJEKTI	URBANIZIMI I BLOKUT TË BANIMIT NË DUSHK SEKTOR	NR.FLETES	A-
VENDODHJA	DUSHK SEKTOR, NJËSIA ADMINISTRATIVE DUSHK, BASHKIA LUSHNJE	FORMATI	420X297
EMERT. I FLETES	PROFILAT E RRUGES	SHKALLA	1:500
DREJTORIA	ING. MIMOZA HAXHIU		
PERGJEGJES	ARK. ALBAN MANOKU		
SPECIALIST	ING. ARIOLA BEO		
SPECIALIST	ING. FLORIANA TUSHA		
SPECIALIST	ING. ERSI VELIU		
SPECIALIST	ING. GARNI MYZEDARI		
SPECIALIST	ING. ARBEN MUCA		
SPECIALIST	TOP. VASIL LENA	REPUBLIKA E SHQIPERISE BASHKIA LUSHNJE SEKTORI I PROJEKTIMIT	

PROFLET TERTHORE , VAZHDIMI RRUGES BASHKIMI NGA DEGEZIMI MAJTAS RR.PAVARESIA DERI NE RRUGEN DEMOKRACIA .



PK10

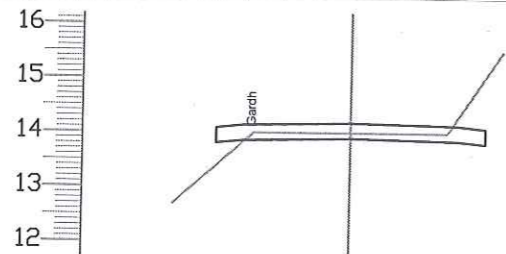

Kuota e Projektit		14.13	14.14	14.18	14.14	14.13
Distanca						
Kuota e Tokes	12.70	14.00	14.00	14.00	15.50	
Distanca		150	180	180	100	15.50

PK11

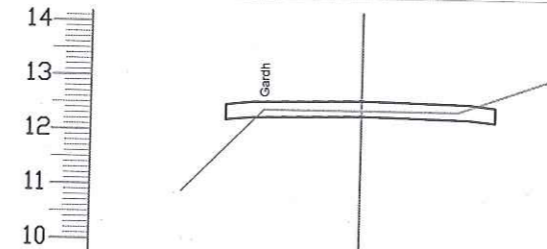

Kuota e Projektit		12.53	12.54	12.58	12.54	12.53
Distanca						
Kuota e Tokes	10.90	12.40	12.40	12.40	13.10	
Distanca		150	180	180	200	13.10

PK15

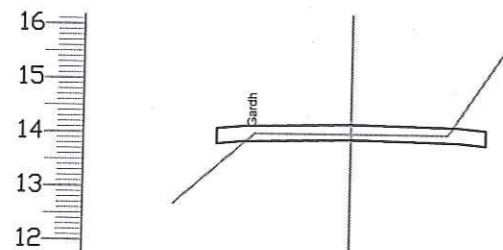

Kuota e Projektit		10.53	10.54	10.58	10.54	10.53
Distanca						
Kuota e Tokes	10.40	10.40	10.40	10.40		
Distanca		320	320			

PK16

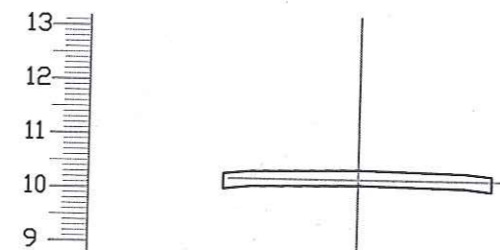

Kuota e Projektit		10.33	10.34	10.38	10.34	10.33
Distanca						
Kuota e Tokes	10.20	10.20	10.20	10.20	10.20	
Distanca		240	240	60		

PK17

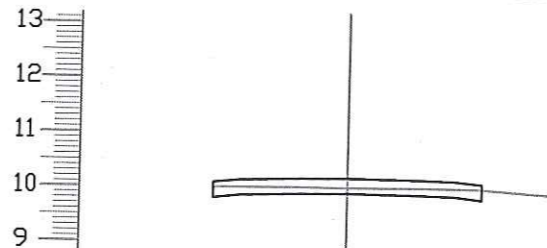

Kuota e Projektit		10.13	10.14	10.18	10.14	10.13
Distanca						
Kuota e Tokes	10.00	10.00	10.00	9.90		
Distanca		250	250	150		

OBJEKTI	URBANIZIMI I BLOKUT TE BANIMIT NE DUSHK SEKTOR	NR.FLETES	A-
VENDNODHJA	DUSHK SEKTOR, NJESIA ADMINISTRATIVE DUSHK, BASHKIA LUSHNJE	FORMATI	420X297
EMERT. I FLETES	PROFILAT E RRUGES	SHKALLA	1:500
DREJTORIA	ING. MIMOZA HAXHIU		
PERGJEGJES	ARK. ALBAN MANOKU		
SPECIALIST	ING. ARIOLA BEGO		
SPECIALIST	ING. FLORIANA TUSHA		
SPECIALIST	ING. ERSI VELIU		
SPECIALIST	ING. GARNI MYZEDARI		
SPECIALIST	ING. ARBEN MUCA		
SPECIALIST	TOP. VASIL LENA		



REPUBLIKA E SHQIPERISE
BASHKIA LUSHNJE
SEKTORI I PROJEKTIMIT



PROFILI TIP

PROFILI TIP I VAZHDIMIT TE RRUGES BASHKIMI NGA DEGEZIMI MAJTAS RRUGA PAVARESIA DERI NE RRUGEN DEMOKRACIA.

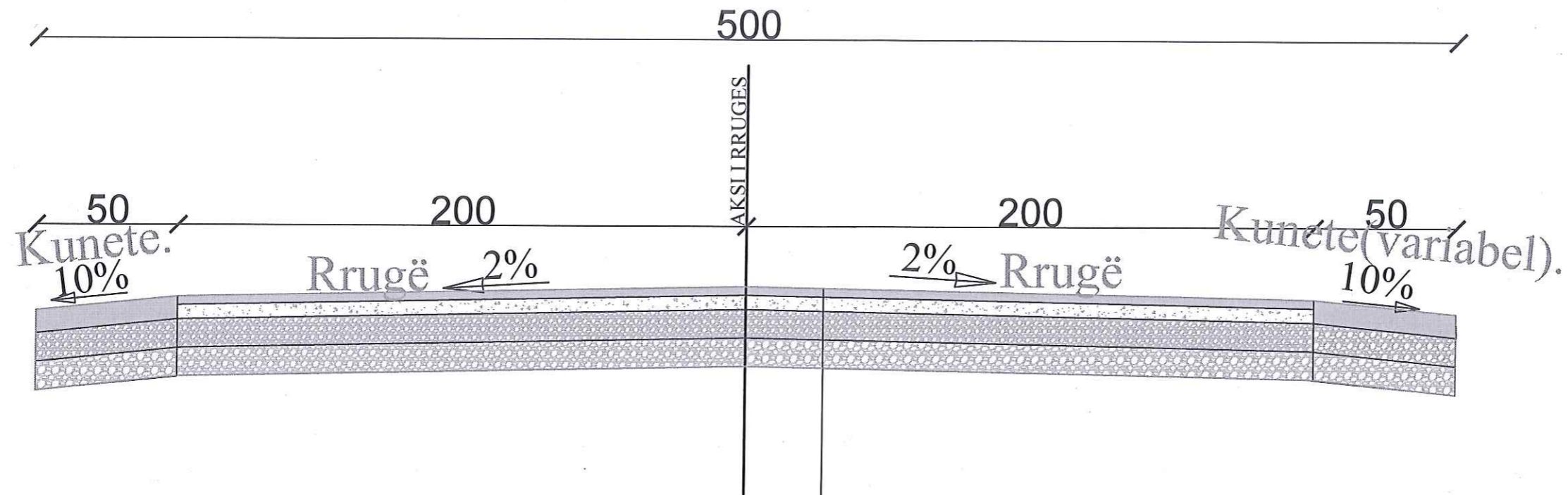

- 3 cm - Asfalto beton
- 5 cm - Binder
- 10 cm - Stabilizant
- 10 cm - Çakull
- Shtresa ekz / Tokë natyrale e ngjeshur

OBJEKTI	URBANIZIMI I BLOKUT TË BANIMIT NË DUSHK SEKTOR	NR.FLETES	A-
VENDNDODHJA	DUSHK SEKTOR, N.JËSIA ADMINISTRATIVE DUSHK, BASHKIA LUSHNJË	FORMATI	420X297
EMERT. I FLETES	PROFILAT E RRUGES	SHKALLA	1:500
DREJTORIA	ING. MIMOZA HAXHIU	 REPUBLIKA E SHQIPERISE BASHKIA LUSHNJË SEKTORI I PROJEKTIMIT	
PERGJEGJES	ARK. ALBAN MANDKU		
SPECIALIST	ING. ARIOLA BEGO		
SPECIALIST	ING. FLORIANA TUSHA		
SPECIALIST	ING. ERSI VELIU		
SPECIALIST	ING. GARNI MYZEDARI		
SPECIALIST	ING. ARBEN MUCA		
SPECIALIST	TOP. VASIL LENA		

PROFILI TIP I RRUGES GJELBERIMI.

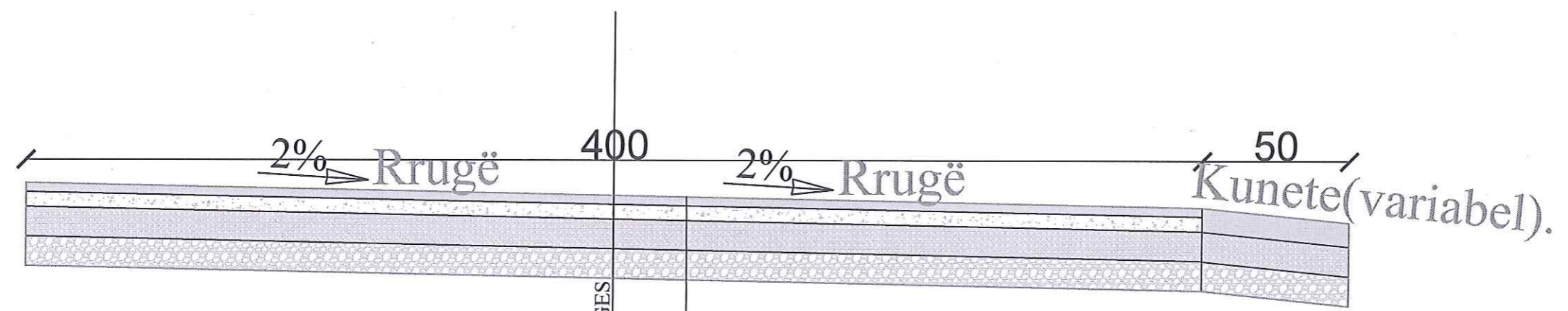

AKSII RRUGES

- 3 cm - Asfalto beton
- 5 cm - Binder
- 10 cm - Stabilizant
- 10 cm - Çakull
- Shtresa ekz / Tokë natyrale e ngjeshur

OBJEKTI	URBANIZIMI I BLOKUT TË BANIMIT NË DUSHK SEKTOR	NR.FLETES	A-
VENDNDODHJA	DUSHK SEKTOR, NJËSIA ADMINISTRATIVE DUSHK, BASHKIA LUSHNJË	FORMATI	420X297
EMERT. I FLETES	PROFILAT E RRUGES	SHKALLA	1:500
DREJTORIA	ING. MIMOZA HAXHIU	 REPUBLIKA E SHQIPERISE BASHKIA LUSHNJË SEKTORI I PROJEKTIMIT	
PERGJEGJES	ARK. ALBAN MANDU		
SPECIALIST	ING. ARIOLA BEO		
SPECIALIST	ING. FLORIANA TUSHA		
SPECIALIST	ING. ERSI VELIU		
SPECIALIST	ING. GARNI MYZEDARI		
SPECIALIST	ING. ARBEN MUCA		
SPECIALIST	TOP. VASIL LENA		

PROFILI TIP I RRUGES PUNISHTJA.

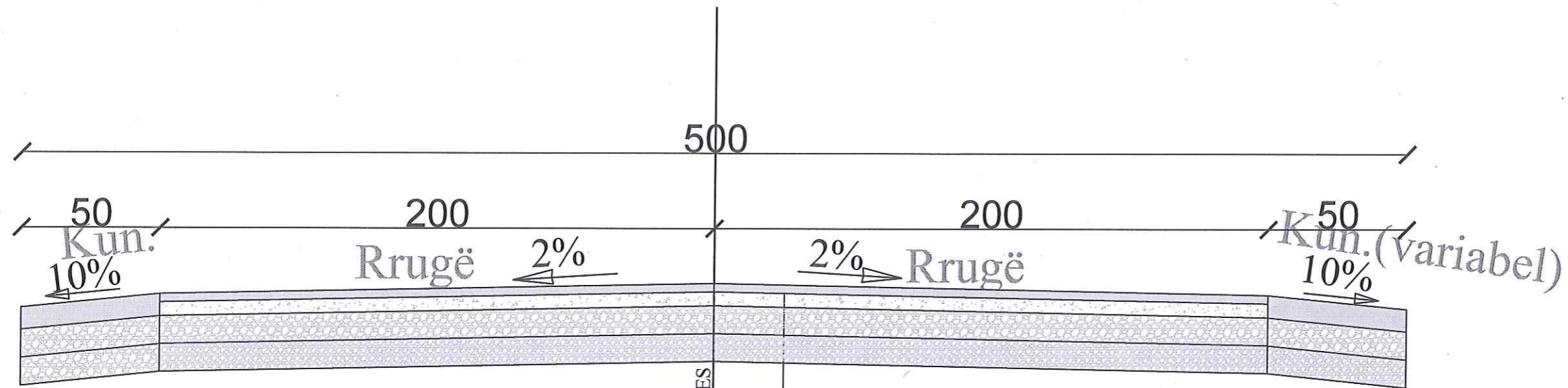

- 3 cm - Asfalto beton
- 5 cm - Binder
- 10 cm - Stabilizant
- 10 cm - Çakull
- Shtresa ekz / Tokë natyrale e ngjeshur

OBJEKTI	URBANIZIMI I BLOKUT TË BANIMIT NË DUSHK SEKTOR	NR.FLETES	A-
VENDNDODHJA	DUSHK SEKTOR, NJËSIA ADMINISTRATIVE DUSHK, BASHKIA LUSHNJË	FORMATI	420X297
EMERT. I FLETES	PROFILAT E RRUGES	SHKALLA	1:500
DREJTORIA	ING. MIMOZA HAXHIU	<p>REPUBLIKA E SHQIPERISE BASHKIA LUSHNJË SEKTORI I PROJEKTIMIT</p>	
PERGJEGJES	ARK. ALBAN MANDOKU		
SPECIALIST	ING. ARIOLA BEQO		
SPECIALIST	ING. FLORIANA TUSHA		
SPECIALIST	ING. ERSI VELIU		
SPECIALIST	ING. GARNI MYZEDARI		
SPECIALIST	ING. ARBEN MUÇA		
SPECIALIST	TOP. VASIL LENA		

PROFILI TIP I RRUGES PAVARESIA,LEMI,POLIKLINIKA.

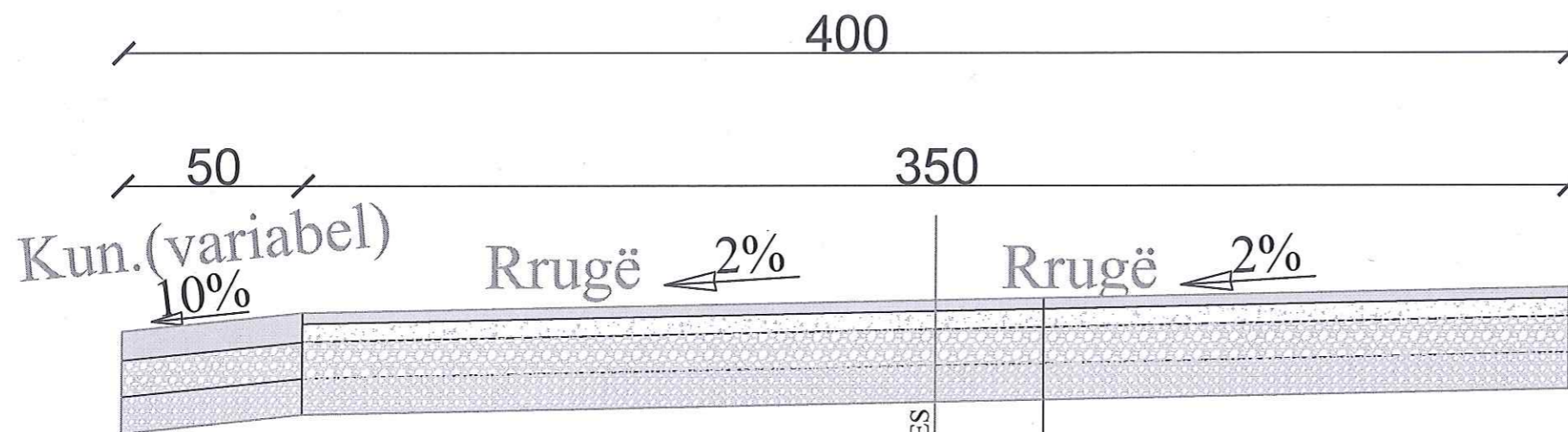

- 3 cm - Asfalto beton
- 5 cm - Binder
- 10 cm - Stabilizant
- 10 cm - Çakull
- Shtresa ekz / Tokë natyrale e ngjeshur

OBJEKTI	URBANIZIMI I BLOKUT TË BANIMIT NË DUSHK SEKTOR	NR.FLETES	A-
VENDNDODHJA	DUSHK SEKTOR, NJËSIA ADMINISTRATIVE DUSHK, BASHKIA LUSHNJE	FORMATI	420X297
EMERT. I FLETES	PROFILAT E RRUGES	SHKALLA	1:500
DREJTORIA	ING. MIMOZA HAXHIU	 REPUBLIKA E SHQIPERISE BASHKIA LUSHNJE SEKTORI I PROJEKTIMIT	
PERGJEGJES	ARK. ALBAN MANDKU		
SPECIALIST	ING. ARIOLA BEOO		
SPECIALIST	ING. FLORIANA TUSHA		
SPECIALIST	ING. ERSI VELIU		
SPECIALIST	ING. GARNI MYZEDARI		
SPECIALIST	ING. ARBEN MUCA		
SPECIALIST	TOP. VASIL LENA		

PROFILI TIP RRUGA BASHKIMI

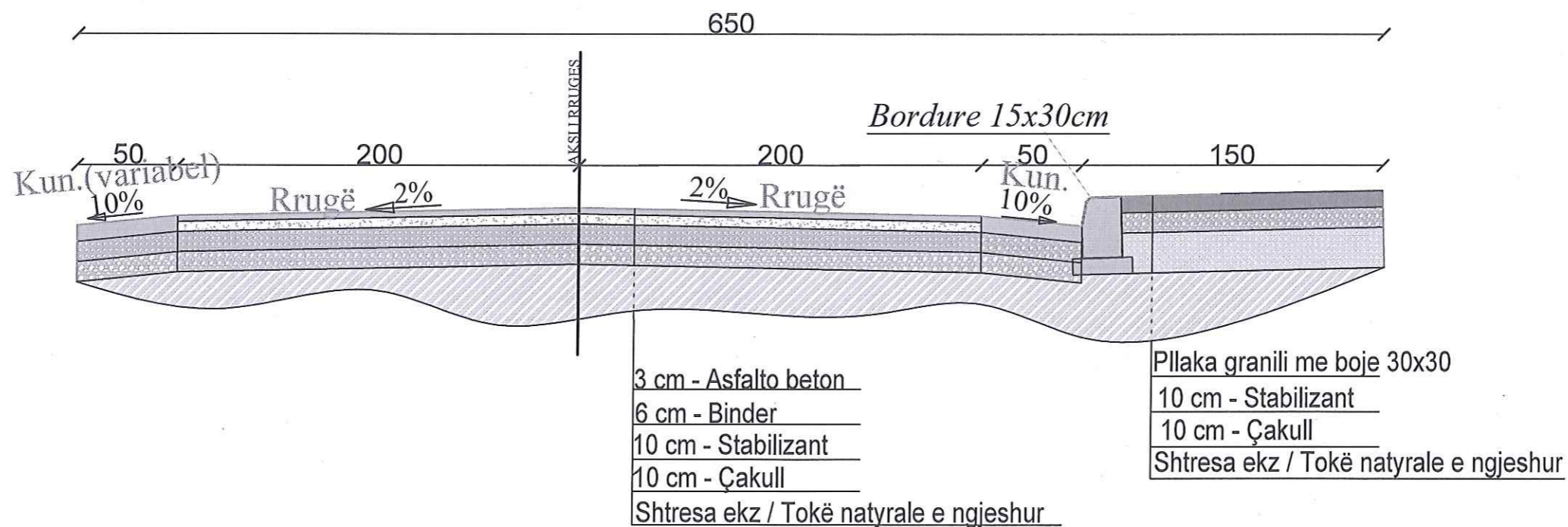

OBJEKTI	URBANIZIMI I BLOKUT TË BANIMIT NË DUSHK SEKTOR	NR.FLETES	A-
VENDNDODHJA	DUSHK SEKTOR, NJËSIA ADMINISTRATIVE DUSHK, BASHKIA LUSHNJË	FORMATI	420X297
EMERT. I FLETES	PROFILAT E RRUGES	SHKALLA	1:500
DREJTORIA	ING. MIMOZA HAXHIU		
PERGJEGJËS	ARK. ALBAN MANDOKU		
SPECIALIST	ING. ARIOLA BEQO		
SPECIALIST	ING. FLORIANA TUSHA		
SPECIALIST	ING. ERSI VELIU		
SPECIALIST	ING. GARNI MYZEDARI		
SPECIALIST	ING. ARBEN MUÇA		
SPECIALIST	TOP. VASIL LENA		
REPUBLIKA E SHQIPERISË BASHKIA LUSHNJË SEKTORI I PROJEKTIMIT			