

OBJEKTI:

"PERFORCIMI /REHABILITIMI I BANESES 1 KAT"

ANDRESA:

Z.K 2559, PASURIA ME NR. 146/26

FSHATI MALASEJ - NJ.AD. GOSTIME - B. CËRRIK

PERFITUES: ALI HAXHI ISHJA

POROSITI: SEKTORI I STREHIMIT

OBJEKTI: "PËRFORCIMI/REHABILITIMI I BANESAVE EKZISTUESE"			<i>Faza eProjektit:</i> <i>Projekt-zbatimi</i>
EMËRTESA E FLETËS: KOPERTINA			Nr.fletes 1
BASHKIA CERRIK  Drejtoria/P & ZH	<i>Porositësi: Sektori i Strehimit</i> <i>Përfituese: Ali Haxhi Ishja</i> <i>Adresa: Rruga "Gjimnazi 1962", Lagja Nr. 2, Cërrik</i> <i>e-mail: bashkiacerrik@yahoo.com</i>	<i>Hartoi:</i> ing. Fatmir Uruçi ing. Erdison Baxhja ing. Arbër Disha tek. Shkëlqim Liçi	<i>nënshtkrimi</i> Sh.----- <i>janar 2023</i>

PLANVENDOSJE PER PUNIME "PERFORCIM/REHABILITIMI I BANESES I KAT"
 ME VENDODHJE: FSHATI MALASEJ, NJ.AD. GOSTIME - BASHKIA CERRIK. ZHVILLUESI: B.CERRIK
 PRONARI I NDERTESES Z. ALI HAXHI ISHJA SH.1:500

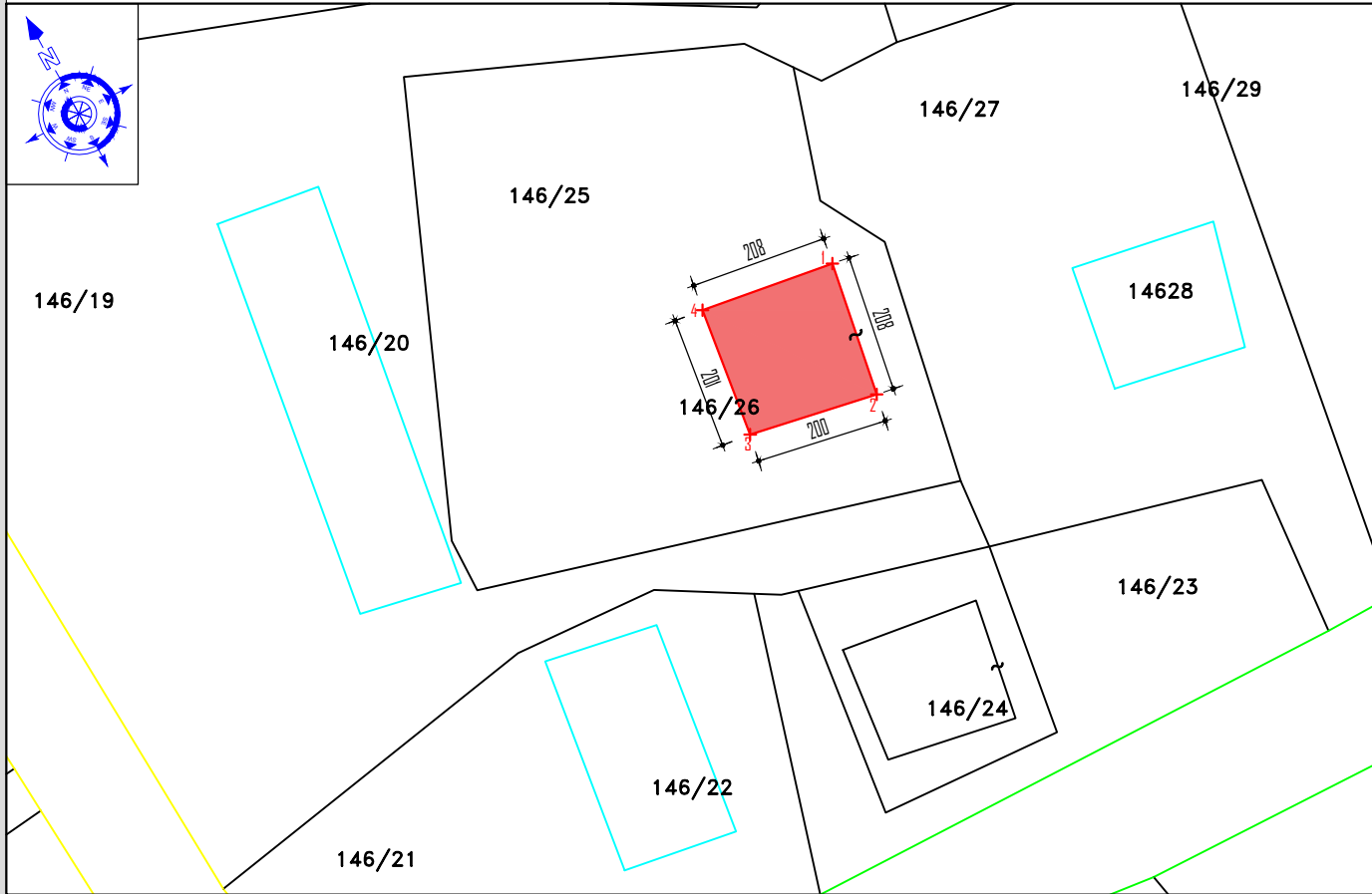

Përmasat janë në cm

BANESA NË ORTOFOTO SH.1:1500

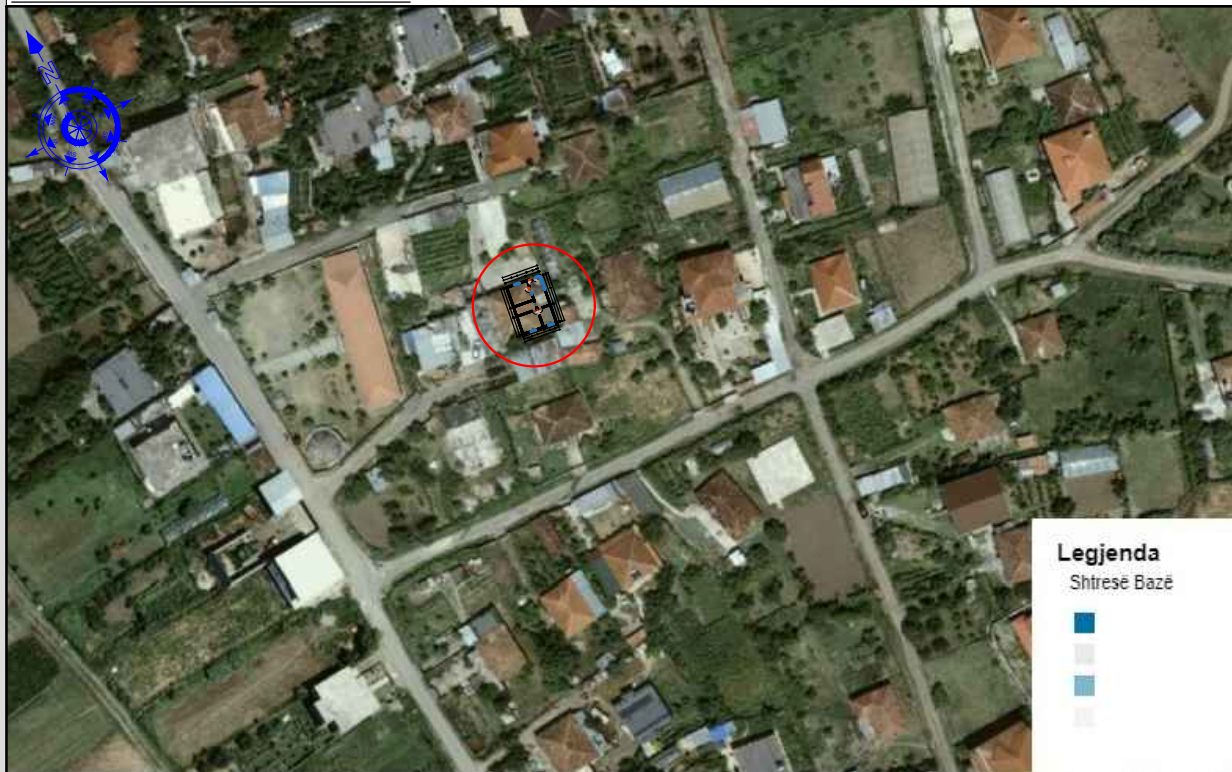

- Çatia me sipërfaqe 80.4 m² ne plan
- Konturet e mureve perimetrale te katit perdhe
- Konturet e parceles toke truall prone e zhvilluesit

Koordinatat e Konturit te baneses ne
projeksionin Nderkombetar - KRGJSH

1.X = 500464.852 Y = 4542772.907
 2.X = 500469.892 Y = 4542762.127
 3.X = 500462.664 Y = 4542759.205
 4.X = 500457.344 Y = 4542770.405

TE DHENA TE PERGJITHSHME

EMERTIMI I PUNIMEVE: "PERFORCIMI/REHABILITIMI I BANESES I KAT EKZISTUESE"
 KATEGORIA E PERDORIMIT TE TOKES: ----
 LLOJI I STRUKTURES EKZISTUESE: MUR GURI, ÇATI DRURI, TJENGULLA VENDI
 ZHVILLUESII PUNIMEVE: BASHKIA CERRIK
 PRONARI I NDERTESES EKZISTUESE: ALI HAXHI ISHJA
 PERFITUESI: ALI HAXHI ISHJA
 ADRESA: Z.K. 2559, PAS. 146/26, FSHATI MALASEJ, NJ.AD. GOSTIME, B.CERRIK
 KODI NEN-NJESISE STRUKTUREORE 2/369
 KODI I PERDORIMIT SIPAS PLANIT (Kategoria Baze e Perdorimit te Tokes) A-Banim

TREGUESIT E ZHVILLIMIT EKZISTUESE

SIPERFAQE E TRUALLIT	250 m ²
SIPERFAQJA E BANESES SIPAS VERTETIMIT	107 m ²
SIPERFAQJA E BANESES SIPAS FAKTIT	94 m ²
SIPERFAQJA E ÇATISE	66 m ²
SIPERFAQJA E TARACES	43.8 m ²
LARTESIA MESATARE E XOKOLIT	0.35 m
LARTESIA E BANESES	2.50 m
LARTESIA E ÇATISE	1.80 m
LARTESIA MAX E STRUKTURES NGA TOKA SISTEMUAR	4.65 m

TREGUESIT E OBJEKTIT PAS RESTAURIMIT

SIPERFAQJA E KATIT PERDHE E BANESES	94 m ²
SIPERFAQJA E ÇATISE	110 m ²
SIPERFAQJA E TARACES	---- m ²
LARTESIA MESATARE E XOKOLIT	0.35 m
LARTESIA E BANESES	2.85 m
LARTESIA E ÇATISE	1.80 m
LARTESIA MAX E STRUKTURES NGA TOKA SISTEMUAR	5.00 m



Kryetari:
Bashkia Cërrik

Andis SALLA

Drejtori D.P.ZH

Ing.Fatmir URUÇI

Përfituesi:

Ali Haxhi Ishja

Pozicioni Topografik i Nderteses			
Veriu: Pasuria 289/4	Jugu: Pasuria 295/5		
Lindje: Pasuria 285/3	Perendimi: Pasuria 289/4		

OBJEKTI: "PËRFORCIMI/REHABILITIMI I BANESAVE EKZISTUESE"		Faza eProjektit: Projekt-zbatimi
EMERTESA E FLETES: PLANVENDOSJE		Nr.fletes 2
BASHKIA CERRIK 	Porositesi: Sektori i Strehimit Përfituese: Altin Ilmi Deliu Adresa: Rruga "Gjimnazi 1962", Lagja Nr. 2, Cërrik e-mail: bashkiacerrrik@yahoo.com	Hartoi ing.Fatmir Uruçi ing.Erdison Baxhija ing.Arber Disha tek.Shkelqim Liçi
Drejtorja/P & ZH		nënshkrimi
		Sh.1:500, 1:1500
		janar 2023



PLANIMETRIA E BANESES SH.1:100

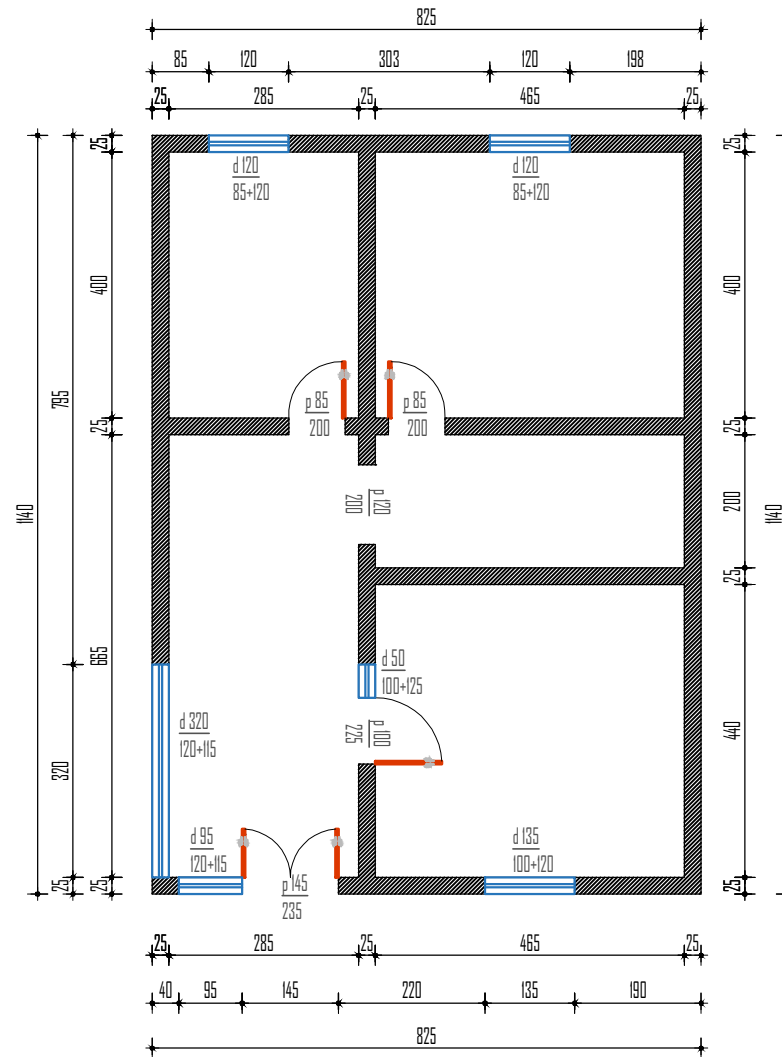

OBJEKTI: "PËRFORCIMI/REHABILITIMI I BANESAVE EKZISTUESE"		<i>Faza eProjektit:</i> <i>Projekt-zbatimi</i>	
EMERTESA E FLETES: PLANIMETRIA E BANESES			
BASHKIA CERRIK  Drejtoria/P & ZH		<i>Porositesi: Sektori i Strehimit</i> <i>Përfutuese: Altin Ilmi Deliu</i> <i>Adresa: Rruga "Gjimnazi 1962", Lagja Nr. 2, Cërrik</i> <i>e-mail: bashkiacerrik@yahoo.com</i>	
		<i>Hartoi</i> ing.Fatmir Uruçi ing. Erdison Baxhja ing.Arber Disha tek.Shkelqim Liçi	
		<i>nënshkrimi</i>	
		Sh.1:75	
		<i>janar 2023</i>	
		Nr.fletes 3	





FOTO TE GJENDJES EKZISTUESE

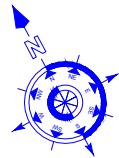

OBJEKTI: "PËRFORCIMI/REHABILITIMI I BANESAVE EKZISTUESE"			<i>Faza eProjektit:</i> <i>Projekt-zbatimi</i>
EMERTESA E FLETES: FOTO TE BANESAVE EKZISTUESE			Nr.fletes 4
BASHKIA CERRIK  Drejtoria/P & ZH	<i>Porositesi: Sektori i Strehimit</i>	Hartoi ing.Fatmir Uruçi ing. Erdison Baxhja ing.Arber Disha tek.Shkelqim Liçi	<i>nënshkrimi</i>
	<i>Adresa: Rruga "Gjimnazi 1962", Lagja Nr. 2, Cërrik</i> <i>e-mail:bashkiacerrik@yahoo.com</i>		Sh.----
			janar 2023

OBJEKTI:

"PERFORCIMI /REHABILITIMI I BANESES 1 KAT"

ANDRESA:

Z.K 2163, PASURIA ME NR. 289/5

FSHATI KLOS - NJ.AD. KLOS - B. CËRRIK

PERFITUES: ALTIN ILMI DELIU

POROSITI: SEKTORI I STREHIMIT

OBJEKTI: "PËRFORCIMI/REHABILITIMI I BANESAVE EKZISTUESE"			<i>Faza eProjektit:</i> <i>Projekt-zbatimi</i>
EMËRTESA E FLETËS: KOPERTINA			Nr.fletes 1
BASHKIA CERRIK  Drejtoria/P & ZH	<i>Porositësi: Sektori i Strehimit</i> <i>Përfituese: Altin Ilmi Deliu</i> <i>Adresa: Rruga "Gjimnazi 1962", Lagja Nr. 2, Cërrik</i> <i>e-mail: bashkiacerrik@yahoo.com</i>	<i>Hartoi:</i> ing. Fatmir Uruçi ing. Erdison Baxhja ing. Arbër Disha tek. Shkëlqim Liçi	<i>nënshkrimi</i> Sh.----- <i>janar 2023</i>

PLANVENDOSJE PER PUNIME "PERFORCIM/REHABILITIMI I BANESES I KAT"
 ME VENDODHJE: FSHATI KLOS, NJ.AD. KLOS - BASHKIA CERRIK. ZHVILLUESI: B.CERRIK
 PRONARI I NDERTESES Z. ALTIN ILMI DELIU SH.1:500

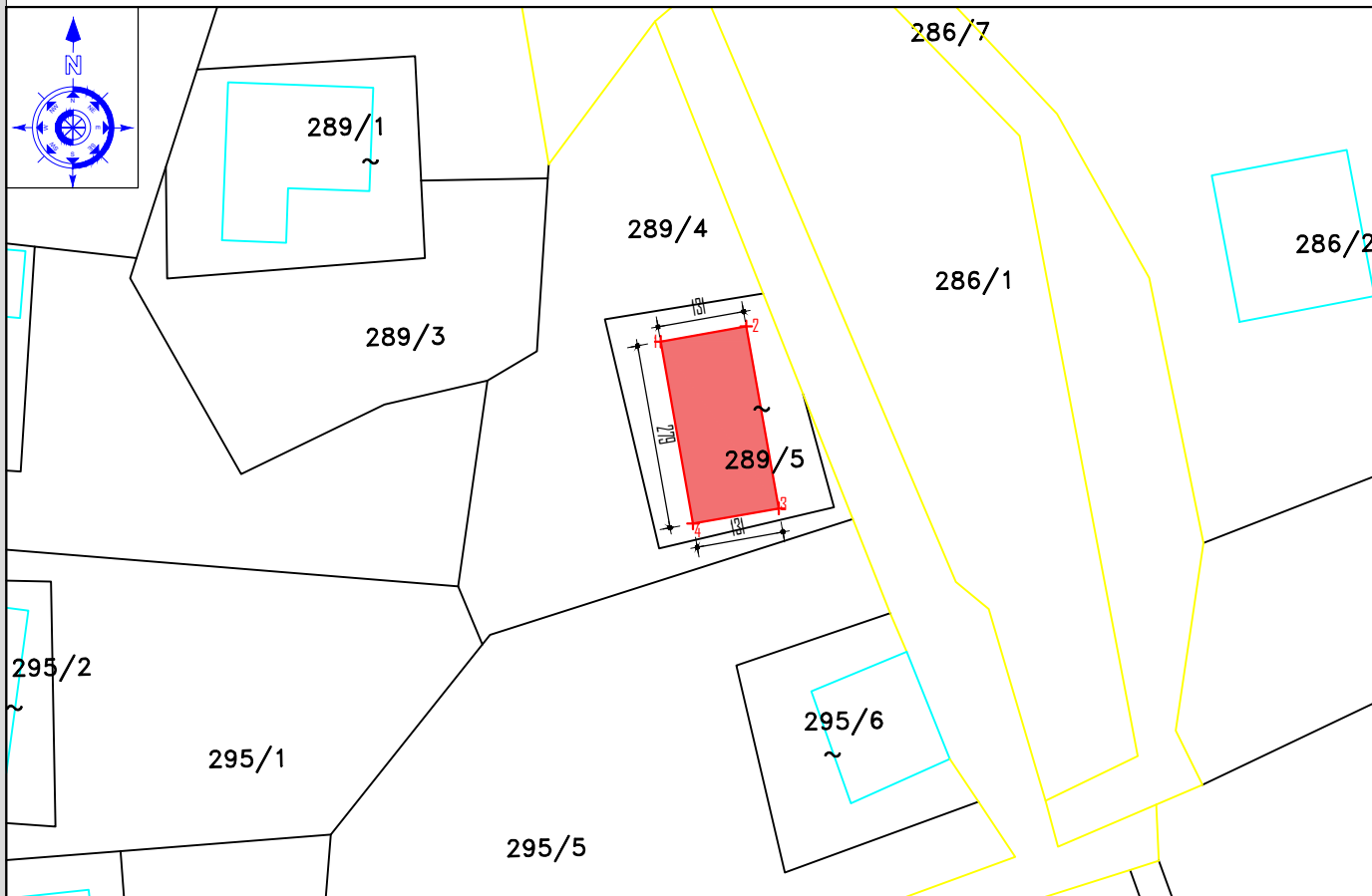

Përmasat janë në cm

BANESA NË ORTOFOTO SH.1:2000



- Çatia me sipërfaqe 79.3 m² ne plan
- Konturet e mureve perimetrale te katit perdhe
- Konturet e parceles toke truall prone e zhvilluesit

Koordinatat e Konturit te baneses ne
 projeksjonin Nderkombetar - KRGJSH

1.X = 500962.959 Y = 4534335.026
 2.X = 500968.559 Y = 4534336.482
 3.X = 500971.247 Y = 4534324.162
 4.X = 500966.543 Y = 4534322.930



Kryetari:
 Bashkia Cërrik

Andis SALLA

Drejtori D.P.ZH

Ing.Fatmir URUÇI

Përfituesi:

Altin Ilmi Deliu

TE DHENA TE PERGJITHSHME

EMERTIMI I PUNIMEVE: "PERFORCIMI/REHABILITIMI I BANESES I KAT EKZISTUESE"
 KATEGORIA E PERDORIMIT TE TOKES: ----
 LLOJI I STRUKTURES EKZISTUESE: MUR GURI, ÇATI DRURI, TJENGULLA VENDI
 ZHVILLUESII PUNIMEVE: BASHKIA CERRIK
 PRONARI I NDERTESES EKZISTUESE: ILMI AHMET DELIU
 PERFITUESI: ALTIN ILMI DELIU
 ADRESA: Z.K. 2163, PAS. 289/5, FSHATI KLOS, NJ.AD. KLOS, B.CERRIK
 KODI NEN-NJESISE STRUKTUREORE 3/170
 KODI I PERDORIMIT SIPAS PLANIT (Kategoria Baze e Perdorimit te Tokes) A-Banim

TREGUESIT E ZHVILLIMIT EKZISTUESE	
SIPERFAQE E TRUALLIT	250 m ²
SIPERFAQJA E BANESES SIPAS VERTETIMIT	100 m ²
SIPERFAQJA E BANESES SIPAS FAKTIT	64.3 m ²
SIPERFAQJA E ÇATISE	79.3 m ²
SIPERFAQJA E TARACES	---- m ²
LARTESIA MESATARE E XOKOLIT	0.10 m
LARTESIA E BANESES	2.55m
LARTESIA E ÇATISE	1.73m
LARTESIA MAX E STRUKTURES NGA TOKA SISTEMUAR	4.38m
TREGUESIT E OBJEKTIT PAS RESTAURIMIT	
SIPERFAQJA E KATIT PERDHE E BANESES	64.3 m ²
SIPERFAQJA E ÇATISE	79.3 m ²
SIPERFAQJA E TARACES	---- m ²
LARTESIA MESATARE E XOKOLIT	0.10 m
LARTESIA E BANESES	2.85 m
LARTESIA E ÇATISE	1.68 m
LARTESIA MAX E STRUKTURES NGA TOKA SISTEMUAR	4.63 m

Pozicioni Topografik i Nderteses

Veriu: Pasuria 289/4 Jugu: Pasuria 295/5
 Lindje: Pasuria 285/3 Perendimi: Pasuria 289/4

OBJEKTI: "PËRFORCIMI/REHABILITIMI I BANESAVE EKZISTUESE"		Faza eProjektit: Projekt-zbatimi
EMERTESA E FLETES: PLANVENDOSJE		Nr.fletes 2
BASHKIA CERRIK Drejtoria/P & ZH	Porositesi: Sektori i Strehimit Përfituese: Altin Ilmi Deliu Adresa: Rruga "Gjimnazi 1962", Lagja Nr. 2, Cërrik e-mail: bashkiacerrik@yahoo.com	Hartoi ing.Fatmir Uruçi ing.Erdison Baxhija ing.Arber Disha tek.Shkelqim Liçi
		nënshkrimi
		Sh.1:500, 1:1000
		janar 2023

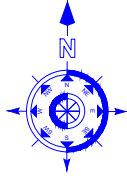

PLANIMETRIA E BANESES SH.1:75

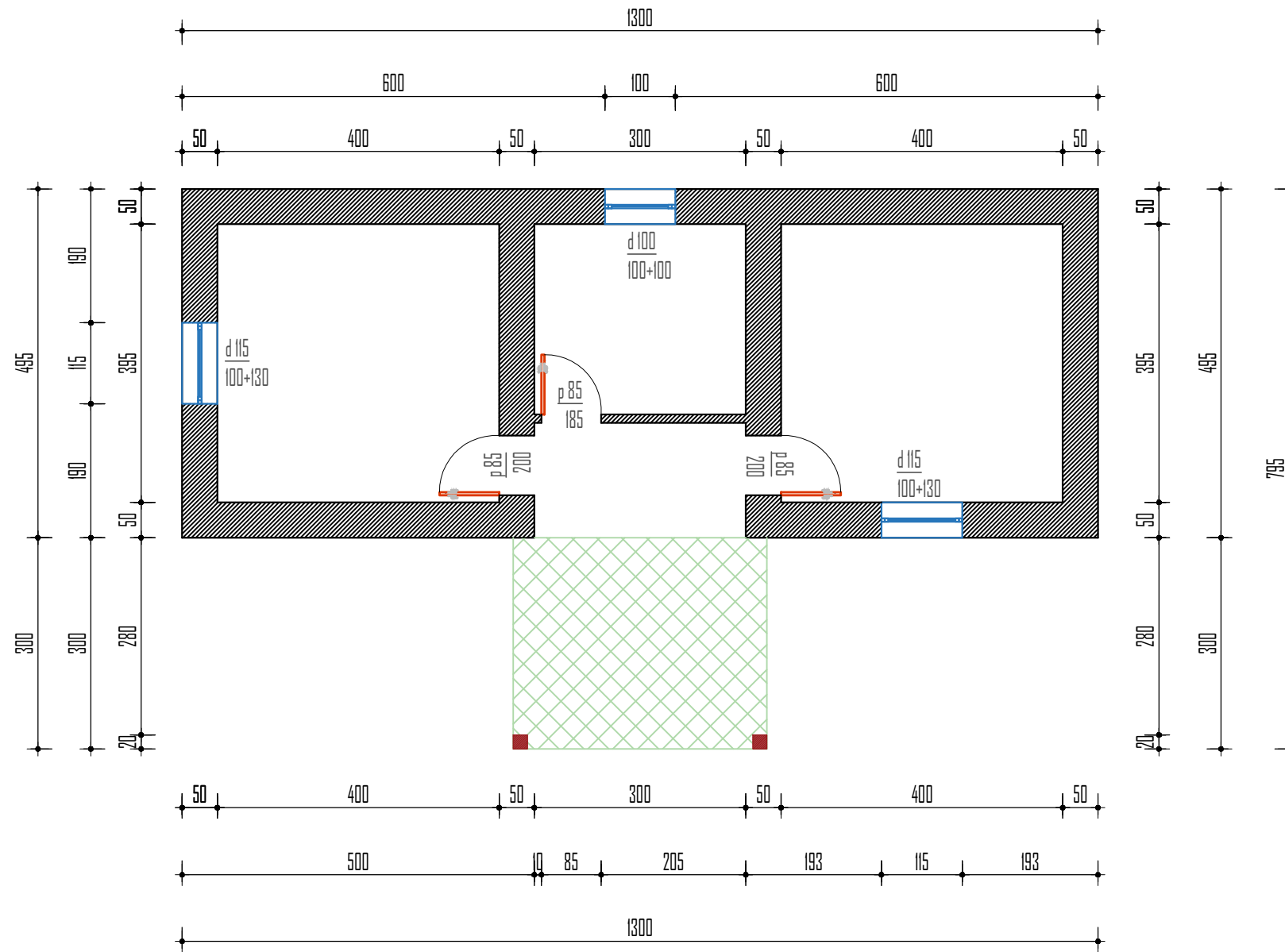

OBJEKTI: "PËRFORCIMI/REHABILITIMI I BANESAVE EKZISTUESE"			Faza eProjektit: Projekt-zbatimi
EMERTESA E FLETES: PLANIMETRIA E BANESES			Nr.fletes 3
BASHKIA CERRIK  Drejtoria/P & ZH	Porositesi: <i>Spektori i Strehimit</i> Përfutuese: <i>Altin Ilmi Deliu</i> Adresa: <i>Rruga "Gjimnazi 1962", Lagja Nr. 2, Cërrik</i> e-mail: <i>bashkiacerrik@yahoo.com</i>	Hartoi ing.Fatmir Uruçi ing. Erdison Baxhja ing.Arber Disha tek.Shkelqim Liçi	nënshkrimi <hr style="border: 1px solid black;"/> Sh.1:75 janar 2023





FOTO TE GJENDJES EKZISTUESE

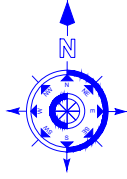

OBJEKTI: "PËRFORCIMI/REHABILITIMI I BANESAVE EKZISTUESE"		<i>Faza eProjektit:</i> <i>Projekt-zbatimi</i>	
EMERTESA E FLETES: FOTO TE BANESAS EKZISTUESE		Nr.fletes 4	
BASHKIA CERRIK  Drejtoria/P & ZH	Porositesi: <i>Spektori i Strehimit</i>	Hartoi	<i>nënshkrimi</i>
	Përfutuese: <i>Altin Ilmi Deliu</i> Adresa: <i>Rruga "Gjimnazi 1962", Lagja Nr. 2, Cërrik</i> e-mail: <i>bashkiacerrik@yahoo.com</i>	ing.Fatmir Uruçi ing. Erdison Baxhja ing.Arber Disha tek.Shkelqim Liçi	
			<i>janar 2023</i>

OBJEKTI:

"PERFORCIMI/REHABILITIMI I BANESES 1 KAT"

ANDRESA:

Z. K. 3122, PASURIA 143/6/1

FSHATI QYRKAN - NJ. AD. KLOS - B. CERRIK

PERFITUES: BAJAME HAMIT XIBRAKU

POROSITI: SEKTORI E STREHIMIT

OBJEKTI: PERFORCIMI/REHABILITIMI I BANESAVE EKZISTUESE			<i>Faza eProjektit:</i> <i>Projekt-zbatimi</i>
EMERTESA E FLETES: KOPERTINA			Nr.fletes 1
BASHKIA CERRIK  Drejtoria/P & ZH	<i>Porositesi: Sektori i Strehimit</i> <i>Perfituese: Bajame Hamit Xibraku</i> <i>Adresa: Rruga "Gjimnazi 1962", Lagja Nr. 2, Cërrrik, e-mail: bashkiacerrik@yahoo.com</i>	<i>Hartoi</i> ing.Fatmir Uruçi ing. Erdison Baxhja ing.Arbri Dishaj tek.Shkelqim Liçi	<i>nënshtkrimi</i> <i>Sh.----</i> <i>janar 2023</i>

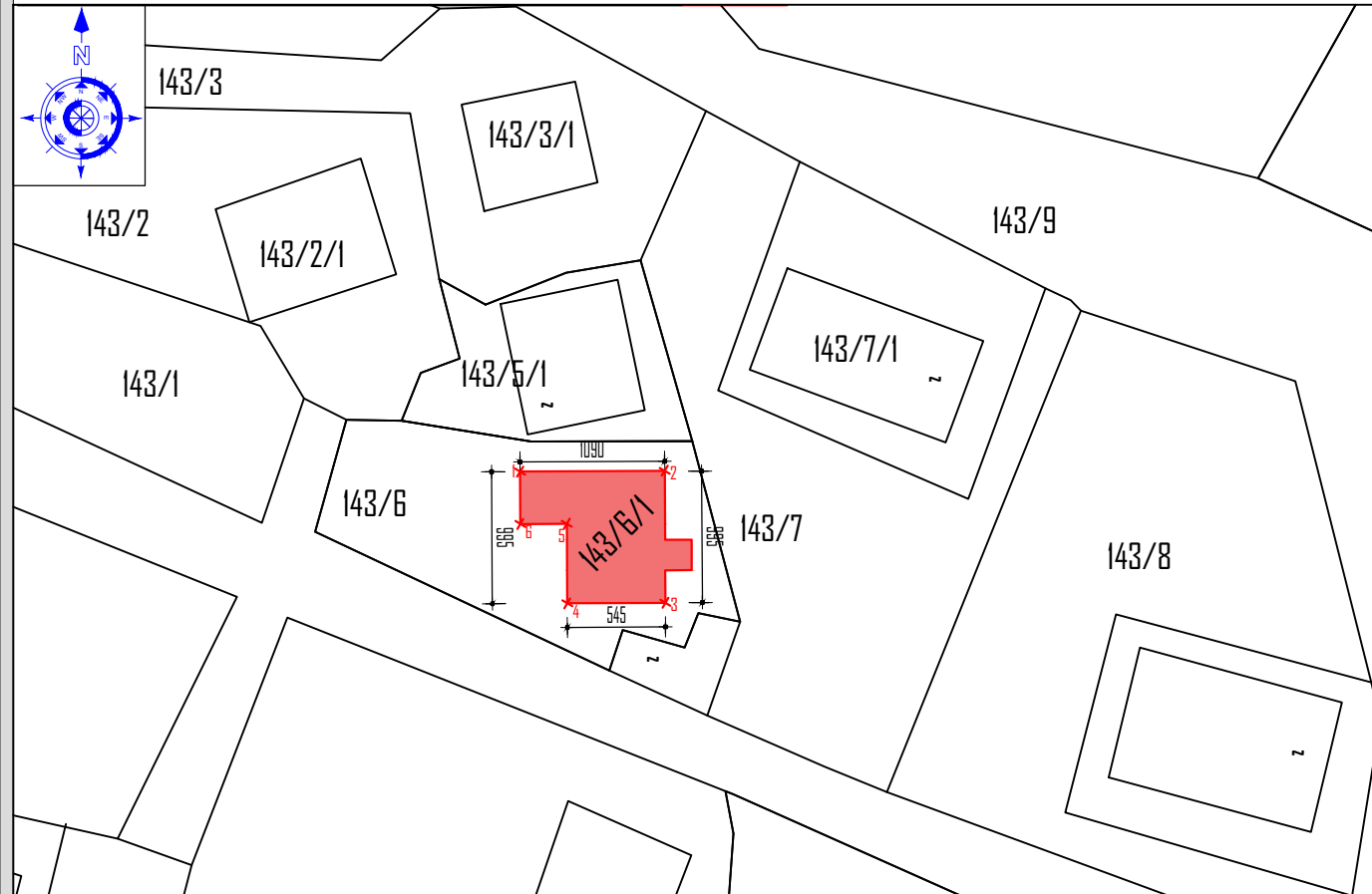

PLANVENDOSJE PER PUNIME "PERFORCIM/REHABILITIMI I BANESES I KAT"
 ME VENDODHJE: FSHATI QYRKAN, NJ. AD. KLOS - BASHKIA CERRIK. ZHVILLUESI: B. CERRIK
 PRONARI I NDERTESES: BAJAME HAMIT XIBRAKU SH.1:500



Permasat jane ne cm

BANESA NE ORTOFOTO SH.1:1500



-  Çatija me siperfaqe 120 m² ne plan
-  Konturet e mureve perimetrale te katit pare
-  Konturet e parceles toke truall prone e zhvilluesit

Pozicioni Topografik i Nderteses		
Veriu. Pasuria 143/6	Jugu Pasuria;	143/6
Lindje Pasuria 143/6	Perendimi. Pasuria	143/6

Kryetari
Bashkise Cerrik

Andis SALLA

Drejtori D.P.T.&ZH.

Ing.Fatmir URUÇI

Perfituesi

Bajame Hamit Xibraku

TE DHENA TE PERGJITHSHME	
EMERTIMI I PUNIMEVE: "PERFORCIMI /REHABILITIMI I BANESES I KAT EKZISTUESE"	
KATEGORIA E PERDORIMIT TE TOKES: TOKE TRUALL	
LLOJI I STRUKTURES EKZISTUESE: MUR GURI, ÇATI DRURI, TJENGULLA VENDI ZHVILLUESI PUNIMEVE : BASHKIA CERRIK	
PRONARI I NDERTESES EKZISTUESE: BAJAME HAMIT XIBRAKU	
PERFITUESI: BAJAME HAMIT XIBRAKU	
ADRESA: Z.K. 3122, PAS. 143/6/1, FSHATI QYRKAN, NJ. AD. KLOS, B. CERRIK	
KODI NEN-NJESISE STRUKTURERE 3/17	
KODI I PERDORIMIT SIPAS PLANIT(Kategoria Baze e Perdorimit te Tokes) A-Banim	
TREGUESIT E ZHVILLIMIT EKZISTUESE	
SIPERFAQE E TRUALLIT	250 m ²
SIPERFAQJA E BANESES SIPAS VERTETIMIT	100 m ²
SIPERFAQJA E BANESES SIPAS FAKTIT	92 m ²
SIPERFAQJA E ÇATISE	74.5 m ²
SIPERFAQJA E TARACES	34.9 m ²
LARTESIA MESATARE E XOKOLIT	0.00 m
LARTESIA E BANESES	2.30m
LARTESIA E ÇATISE	1.34m
LARTESIA MAX E STRUKTURES NGA ±0.00 NE KULM ÇATIE	3.64m
TREGUESIT E OBJEKTIT PAS NDERTIMIT TE ÇATISE	
SIPERFAQJA E BANESES SIPAS FAKTIT	92 m ²
SIPERFAQJA E ÇATISE	120 m ²
SIPERFAQJA E TARACES	---- m ²
LARTESIA MESATARE E XOKOLIT	0.00 m
LARTESIA E BANESES	2.60m
LARTESIA E ÇATISE	1.34m
LARTESIA MAX E STRUKTURES NGA ±0.00 NE KULM ÇATIE	3.94m

Koordinatat e Konturit te baneses ne projektionin Nderkombetar - KRGJSH	
1.X = 500801.489	Y = 4534275.807
2.X = 500809.049	Y = 4534272.727
3.X = 500805.409	Y = 4534262.087
4.X = 500797.009	Y = 4534264.747

OBJEKTI: PERFORCIMI/REHABILITIMI I BANESAVE EKZISTUESE		Faza eProjektit: Projekt-zbatimi
EMERTESA E FLETES:PLANVENDOSJE		Nr.fletes 2
 Drejtoria/P & ZH	Porositesi: <i>Sektori i Strehimit</i>	Hartoi ing.Fatmir Uruçi ing.Erdison Baxhia ing.Arberi Disha tek.Shkelqim Liçi
	Perfituesi: <i>Bajame Hamit Xibraku</i>	
Adresa: <i>Rruga "Gjimnazi 1962", Lagja Nr. 2, Cërrik, e-mail:bashkiacerrik@yahoo.com</i>		janar 2023

PLANVENDOSJE PËR PUNIME PËRFORCIM/REHABILITIMI I BANESËS 1 KAT
 ME VENDODHJE: FSHATI KLOS, NJ. AD. KLOS -BASHKIA CERRIK. ZHVILLUESI: B. CERRIK
 PRONARI I NDËRTESES NURI IBRAHIM XHERIJA .SH.1:500

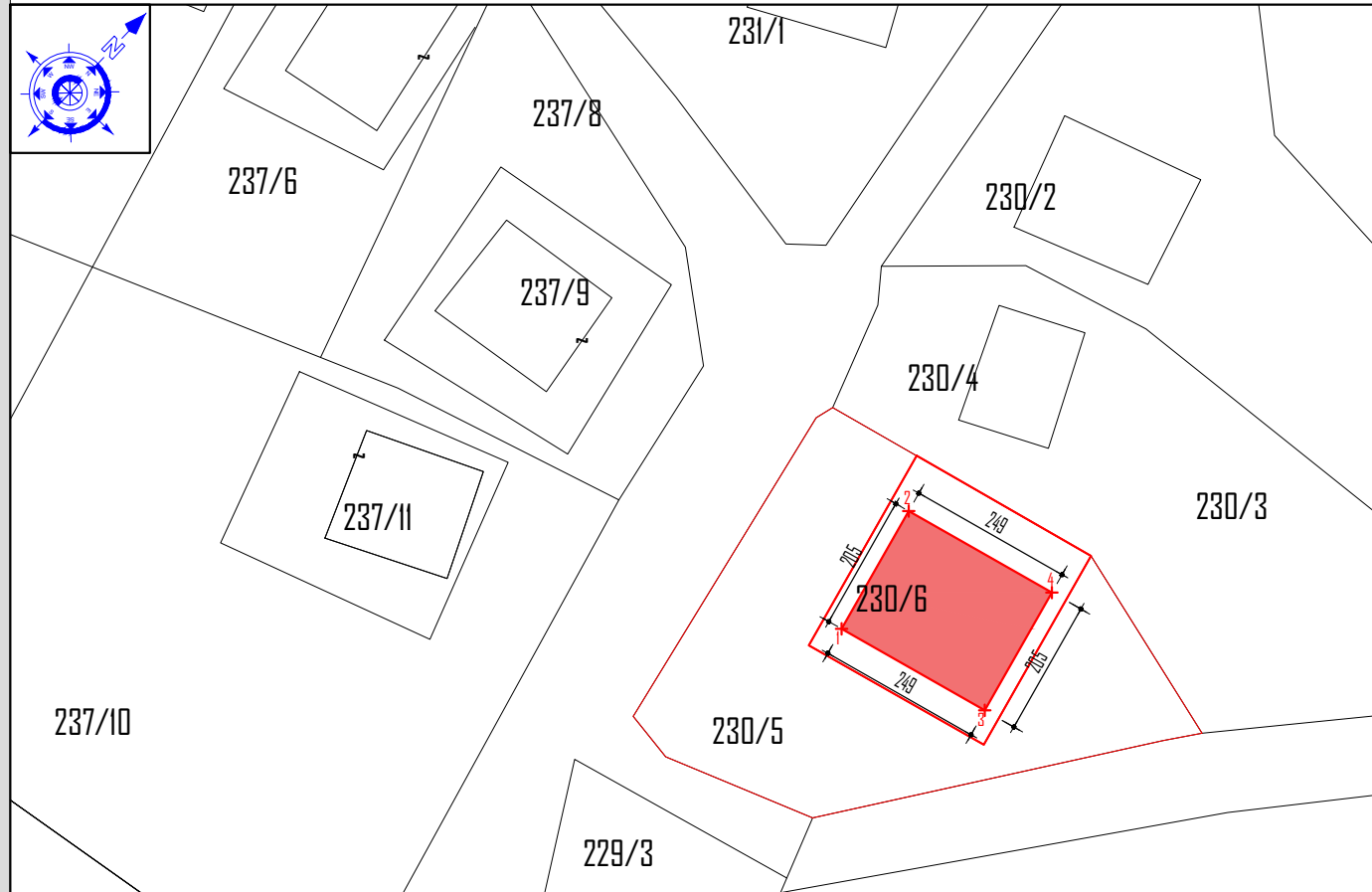

Përmasat janë në cm

BANESA NË ORTOFOTO SH.1:1500



Kryetari
 Bashkise Cerrik

Andis SALLA

Drejtori D.P.T.&ZH.

Ing.Fatmir URUÇI

Përfituesi

Nuri Ibrahim Xherija

TE DHENA TE PERGJITHSHME

EMERTIMI I PUNIMEVE:"PËRFORCIMI /REHABILITIMI I BANESËS 1 KAT EKZISTUESE
 KATEGORIA E PERDORIMIT TE TOKES: **TOKE TRUALL**
 LLOJI I STRUKTURES EKZISTUESE:MUR GURI ,ÇATI DRURI ,TJENGULLA VENDI
 ZHVILLUESI PUNIMEVE :**BASHKIA CERRIK**
 PRONARI I NDERTESËS EKZISTUESE: NURI IBRAHIM XHERIJA
 PERFTUESI: NURI IBRAHIM XHERIJA
 ADRESA:**Z.K. 2163, PAS.230/6, FSHATI KLOS, NJ.AD. KLOS, B.CERRIK**
 KODI NEN-NJESISE STRUKTUREORE
 KODI I PERDORIMIT SIPAS PLANIT(Kategoria Baze e Perdorimit te Tokes) A-Banim

TREGUESIT E ZHVILLIMIT EKZISTUESE

SIPERFAQE E TRUALLIT	--- m ²
SIPERFAQJA E BANESËS 1 KAT	127 m ²
SIPERFAQJA E ÇATISE	150 m ²
SIPERFAQJA E TARACES	---- m ²
LARTESIA MESATARE E XOKOLIT	0.55 m
LARTESIA E BANESËS	2.30m
LARTESIA E ÇATISE	1.75m
LARTESIA MAX E STRUKTURES NGA TOKA SISTEMUAR	4.60m
TREGUESIT E OBJEKTIT PAS NDERTIMIT TE ÇATISE	
SIPERFAQJA E BANESËS 1 KAT	61.6 m ²
SIPERFAQJA E ÇATISE	75 m ²
SIPERFAQJA E TARACES	---- m ²
LARTESIA MESATARE E XOKOLIT	0.50 m
LARTESIA E BANESËS	3.05m
LARTESIA E ÇATISE	1.85m
LARTESIA MAX E STRUKTURES NGA TOKA SISTEMUAR	5.40m

Çatija me sipërfaqe 75 m² ne plan

Konturet e mureve perimetrale te katit pare

Konturet e parceles toke truall prone e zhvilluesit

Pozicioni Topografik i Nderteses	
Veriu. Pasuria 230/5	Jugu Pasuria;230/5
Lindje Pasuria 230/5	Perendimi. Pasuria 230/5

Koordinatat e Konturit te baneses ne projektionin Nderkombetar-UTM Sistemi 2000	
1.X =500931.380	Y = 4534680.142
2.X =500937.092	Y = 4534689.102
3.X =500941.012	Y = 4534673.646
4.X =500947.172	Y = 4534682.606

OBJEKTI: PËRFORCIMI/REHABILITIMI I BANESAVE EKZISTUESE		Faza eProjektit: Projekt-zbatimi
EMËRTESEA E FLETËS: PLANVENDOSJE		Nr. fletës 2
BASHKIA CERRIK 	Porositësi: <i>Spektori i Strehimit</i>	Hartoi ing. Fatmir Uruçi
Drejtori D. P. ZH. T.	Përfituesi: <i>Nuri Ibrahim Xherija</i>	ing. Erdison Baxhija
	Rruga: <i>"Gjimnazi 1962"</i>	ing. Arbri Disha
	Lagja <i>'Lagja Nr 2' Cerrik</i>	tek. Shkelqim Liçi
	E-Mail: <i>bashkiacerrik@yahoo.com</i>	nëshkrimi
		Sh.1:75
		Gusht 2023

PLANIMETRIA E BANESËS SH.1:100



FOTO E GJENDJES EKZISTUESE



OBJEKTI: PËRFORCIMI/REHABILITIMI I BANESAVE EKZISTUESE			Faza eProjektit: Projekt-zbatimi
EMËRTESA E FLETËS: PLANIMETRI			Nr.fletes 3
BASHKIA CERRIK  Drejtori D. P. ZH. T.	Porositësi: Sektori i Strehimit	Hartoi ing. Fatmir Uruçi	nëshkrimi
	Përfutuesi: Nuri Ibrahim Xherija Rruga: "Gjimnazi 1962" Lagja 'Lagja Nr 2' Cerrik E-Mail: bashkiacerrik@yahoo.com	ing. Erdison Baxhija ing. Arbri Disha tek. Shkelqim Liçi	
			Gusht 2023

PLANIMETRIA E BANESËS SH.1:100

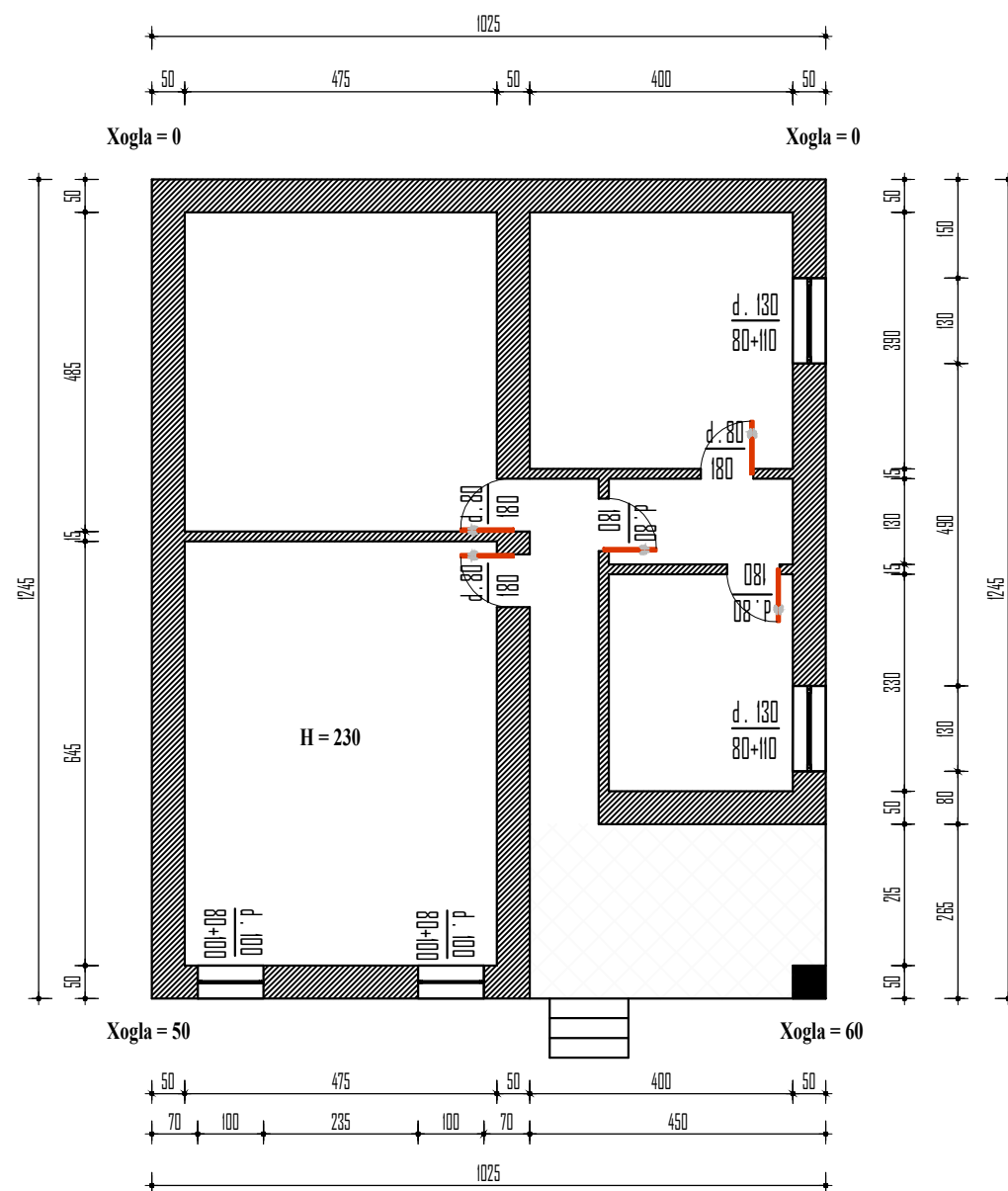



FOTO E GJENDJES EKZISTUESE

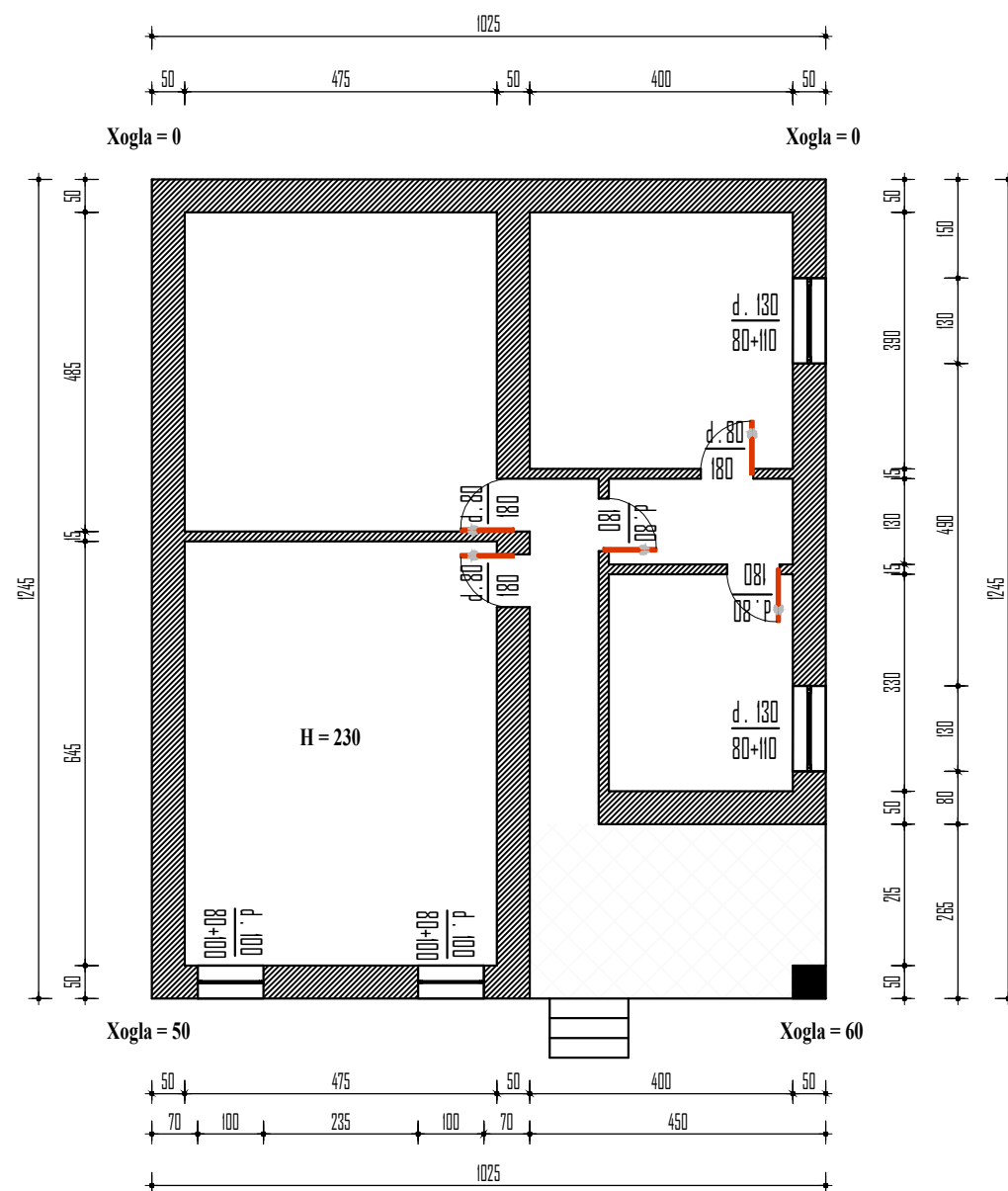

OBJEKTI: PËRFORCIMI/REHABILITIMI I BANESAVE EKZISTUESE			Faza eProjektit: Projekt-zbatimi
EMËRTESA E FLETËS: PLANIMETRI			Nr.fletes 3
BASHKIA CERRIK  Drejtori D. P. ZH. T.	Porositësi: Sektori i Strehimit	Hartoi ing. Fatmir Uruçi	nëshkrimi
	Përfutuesi: Nuri Ibrahim Xherija Rruga: "Gjimnazi 1962" Lagja 'Lagja Nr 2' Cerrik E-Mail: bashkiacerrik@yahoo.com	ing. Erdison Baxhija ing. Arbri Disha tek. Shkelqim Liçi	
			Gusht 2023

OBJEKTI:

"PERFORCIMI /REHABILITIMI I BANESES 1 KAT

ANDRESA:

3294 PASURIA 80/2/1

FSHATI SELITE -NJ.AD.MOLLAS -B CERRIK

PERFITUES:PELLUMB RRAPUSH SULA

POROSITI:SEKTORI E STREHIMIT

OBJEKTI: PERFORCIMI/REHABILITIMI I BANESAVE EKZISTUESE			<i>Faza eProjektit:</i> <i>Projekt-zbatimi</i>		
EMERTESA E FLETES:KOPERTINA			Nr.fletes 1		
 Drejtori D.P.T.&ZH.	<i>Porositesi: Sektori i Strehimit</i>	Hartoi	<i>neshkrimi</i>		
	<i>Perfituese: Pellumb Rrapush Sula</i>	ing.Fatmir Uruçi		Sh.1:75	
	<i>Rruga: "Gjimnazi 1962"</i>	ing.Erdison Baxhia			janar 2023
	<i>Lagja 'Lagja Nr 2" Cerrik</i> <i>E-Mail: bashkiacerrik@yahoo.com</i>	ing.Arber Disha tek.Shkelqim Liçi			

PLANIMETRIA E BANESES SH.1:100





FOTO E GJENDJES EKZISTUESE

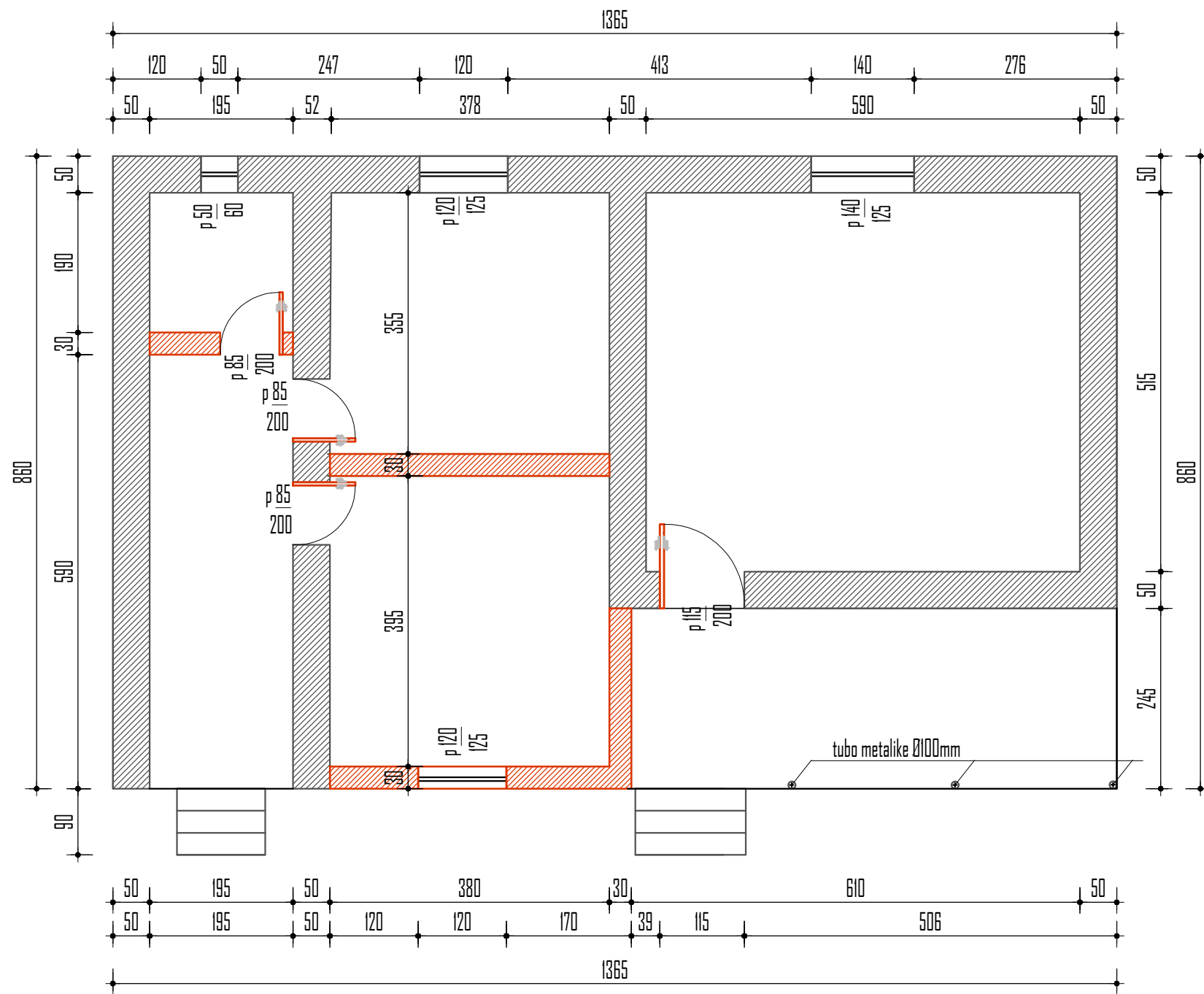

OBJEKTI: PERFORCIMI/REHABILITIMI I BANESAVE EKZISTUESE		<i>Faza eProjektit:</i> <i>Projekt-zbatimi</i>	
EMERTESA E FLETES:PLANI I I BANESES EKZISTUESE		Nr.fletes 3	
BASHKIA CERRIK  Drejtori D.P.T.&ZH.	Porositesi: <i>Sektori i Strehimit</i>	Hartoi ing.Fatmir Uruçi ing.Erdison Baxhia ing.Arber Disha tek.Shkelqim Liçi	<i>neshkrimi</i>
	Perfituese: <i>Pellumb Rrapush Sula</i> Rruga: <i>"Gjimnazi 1962"</i> Lagja <i>'Lagja Nr 2" Cerrik</i> E-Mail: <i>bashkiacerrik@yahoo.com</i>	Sh.1:75	<i>janar 2023</i>

PLANI I VENDOSJES SE KOLLONAVE B.A NE VERANDE SH.1:100

FOTO E GJENDJES EKZISTUESE

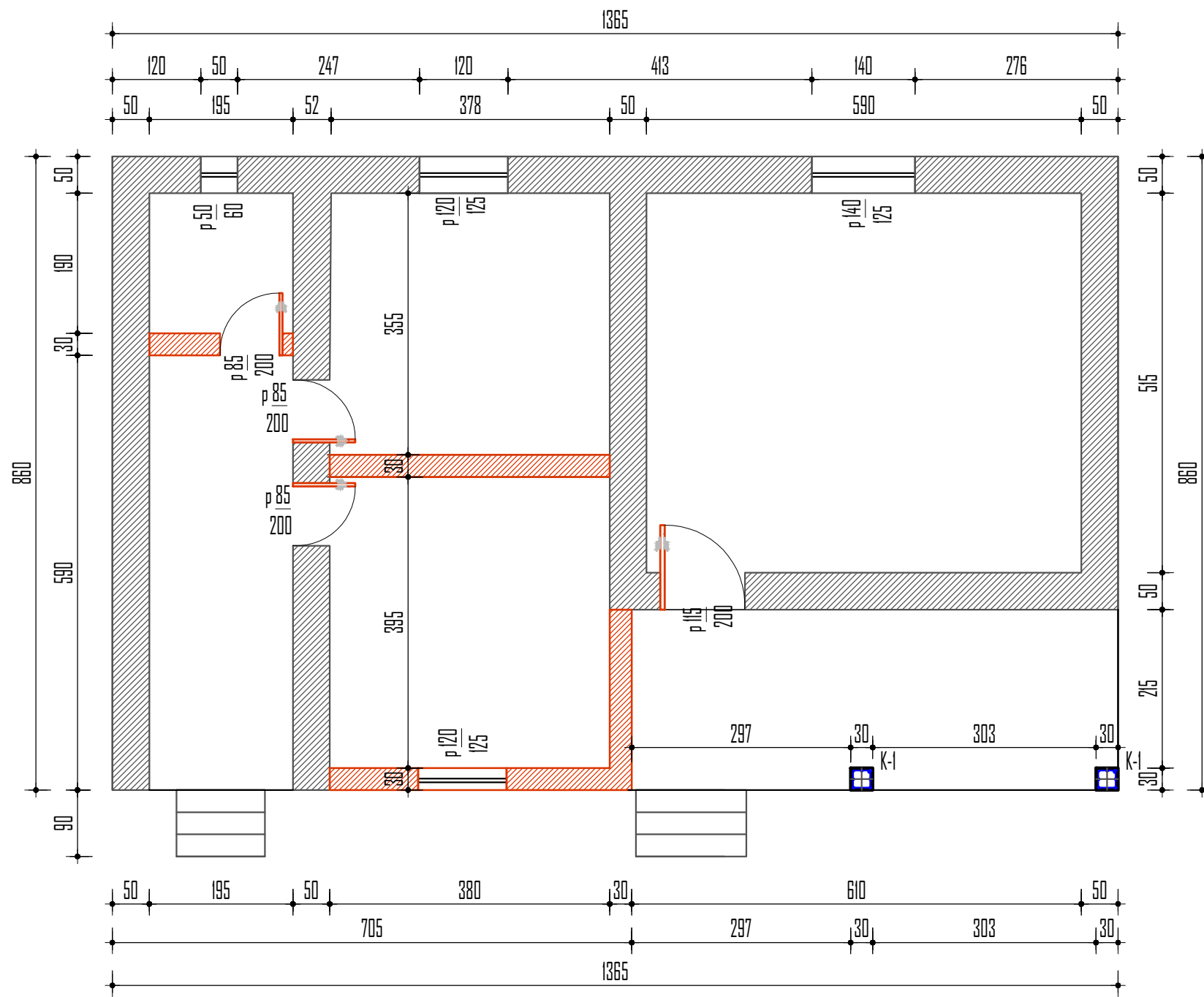

OBJEKTI: PERFORCIMI/REHABILITIMI I BANESAVE EKZISTUESE			<i>Faza eProjektit:</i> <i>Projekt-zbatimi</i>
EMERTESA E FLETES:PLANI I KOLLONAVE B.A NE VERANDE			Nr.fletes 4
BASHKIA CERRIK  Drejtori D.P.T.&ZH.	Porositesi: <i>Sektori i Strehimit</i> Perfituese: <i>Pellumb Rrapush Sula</i> Rruga: <i>"Gjimnazi 1962"</i> Lagja <i>'Lagja Nr 2" Cerrik</i> E-Mail: <i>bashkiacerrik@yahoo.com</i>	Hartoi ing.Fatmir Uruçi ing.Erdison Baxhia ing.Arber Disha tek.Shkelqim Liçi	<i>neshkrimi</i>
			Sh.1:75
			<i>janar 2023</i>

PLANI I VENDOSJES SE PLINTAVE B.A NE VERANDE SH.1:100

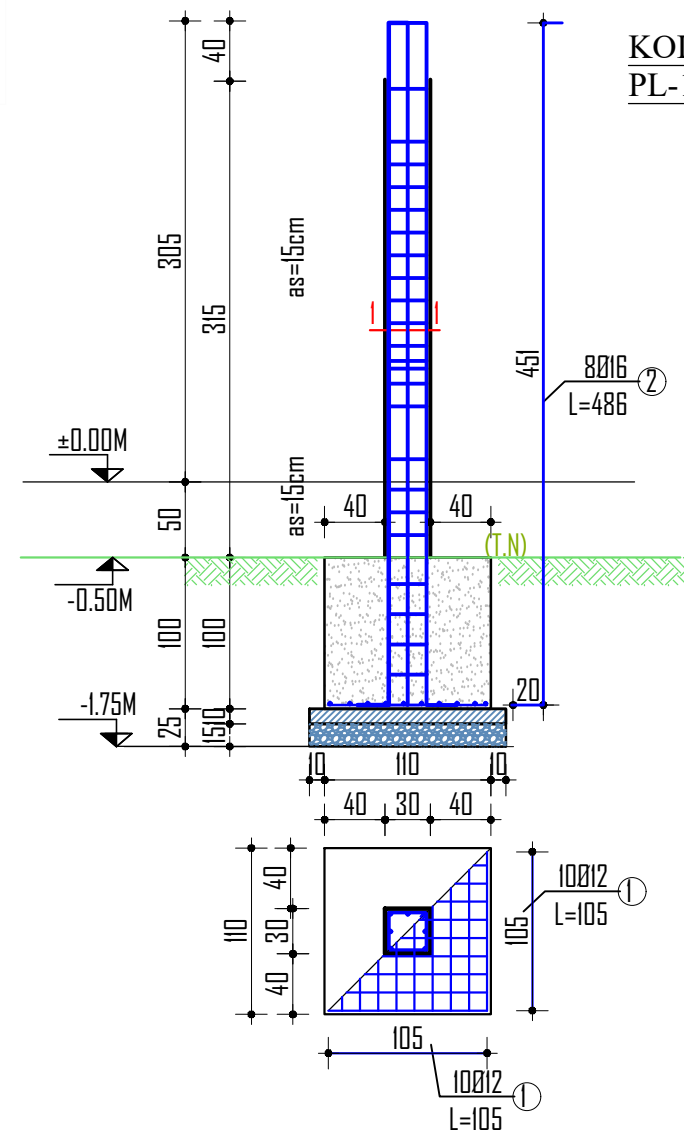
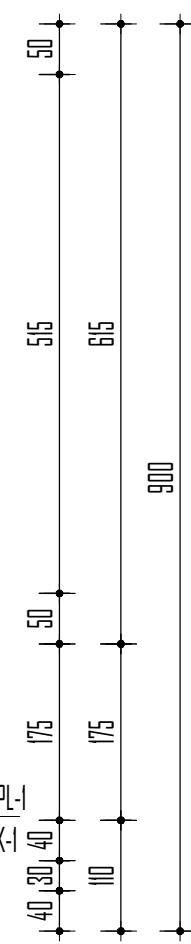
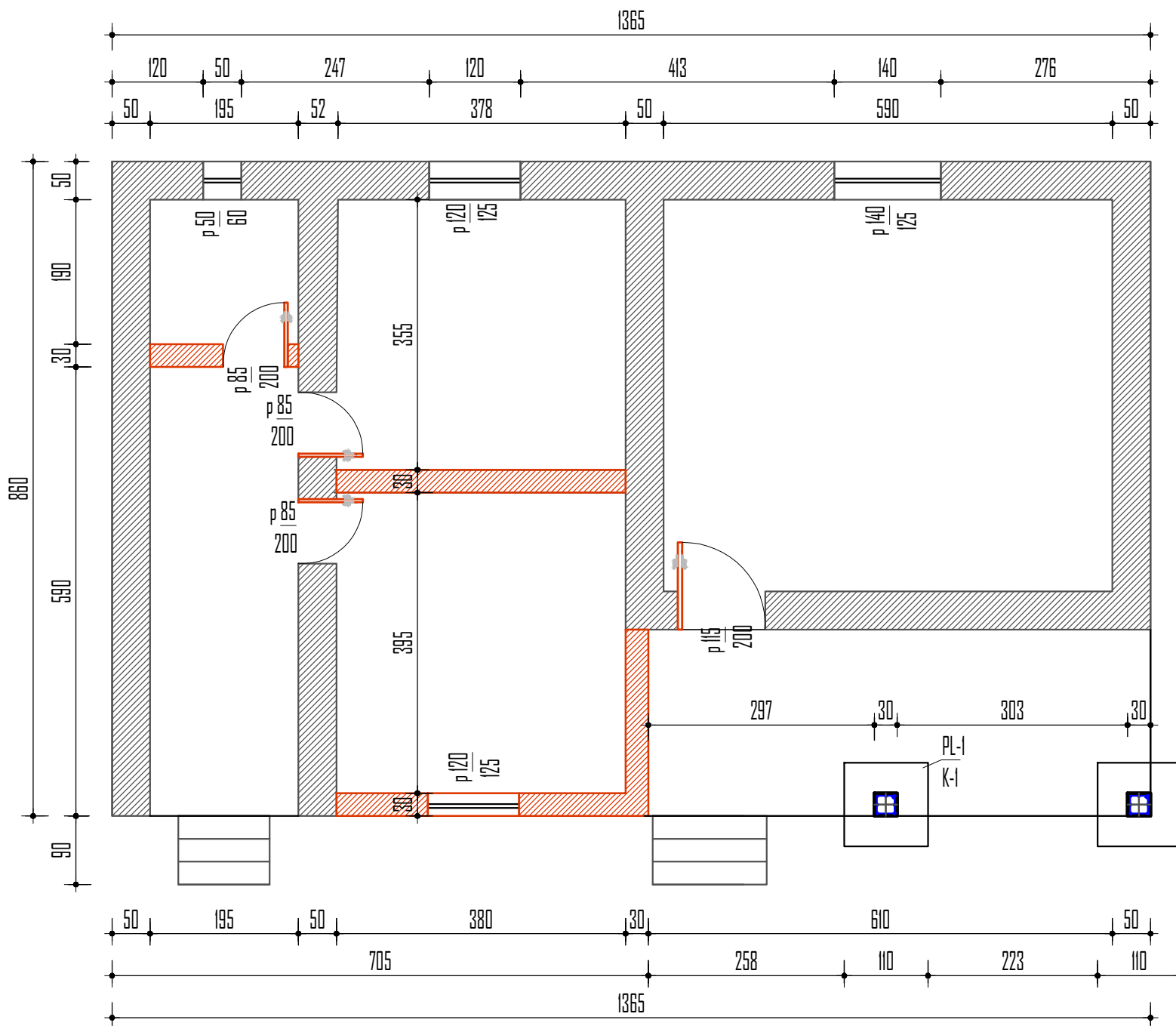

KOLLONA K-1, COPE2, PL-1 COPE2 SH.1:50

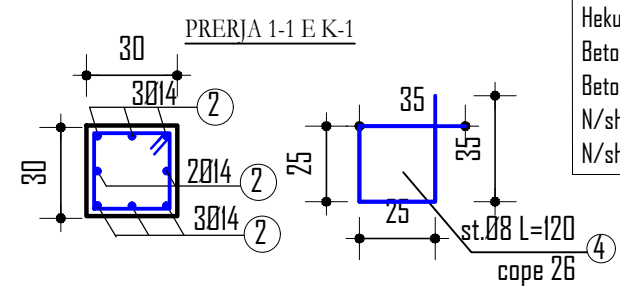

Hekur Ø8mm	=25kg
Hekur Ø12mm	=38kg
Hekur Ø16mm	=118kg
Beton plinta C16/20	=2.42m ³
Beton kollona C20/25	=0.5m ³
N/shtres zhavori	0.6m ³
N/shtres Betoni C7/10	=0.4m ³

OBJEKTI: PERFORCIMI/REHABILITIMI I BANESAVE EKZISTUESE		<i>Faza eProjektit:</i> <i>Projekt-zbatimi</i>
EMERTESA E FLETES:PLANI I PLINTAVE NE VERANDE		Nr.fletes 5
BASHKIA CERRIK  Drejtori D.P.T.&ZH.	Porositesi: <i>Sektori i Strehimit</i> Perfituese: <i>Pellumb Rrapush Sula</i> Rruga: <i>"Gjimnazi 1962"</i> Lagja <i>'Lagja Nr 2" Cerrik</i> E-Mail: <i>bashkiacerrik@yahoo.com</i>	Hartoi ing.Fatmir Uruçi ing.Erdison Baxhia ing.Arber Disha tek.Shkelqim Liçi
	<i>neshkrimi</i>	
		janar 2023

PLANI I BREZIT B.A NENÇATI NE 3.05M SH.1:100

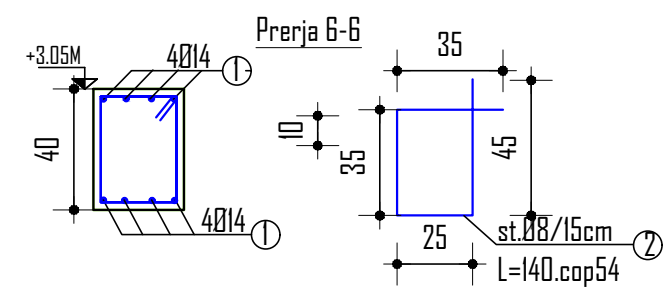
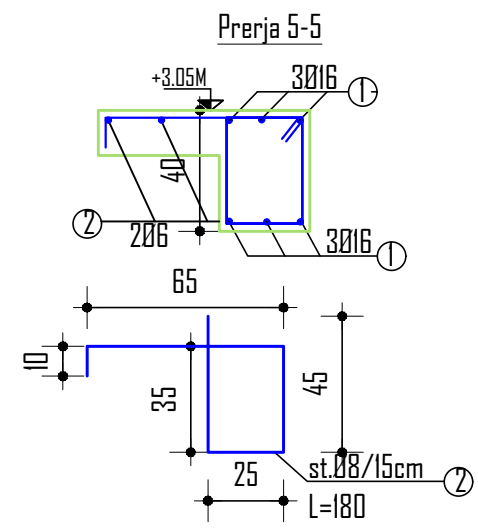
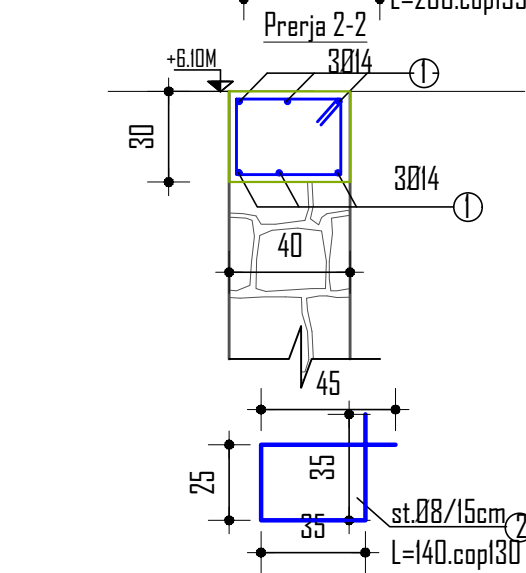
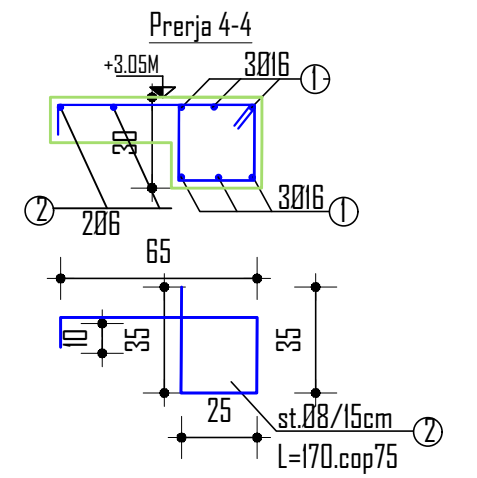
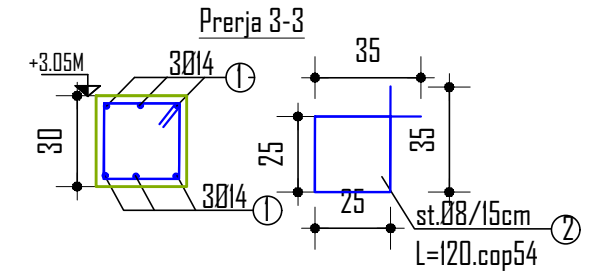
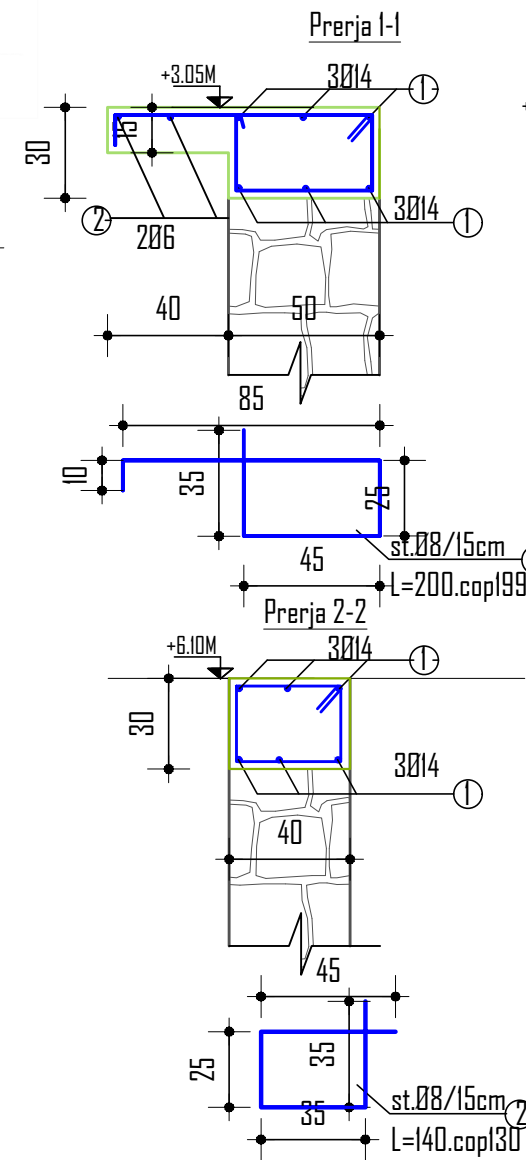
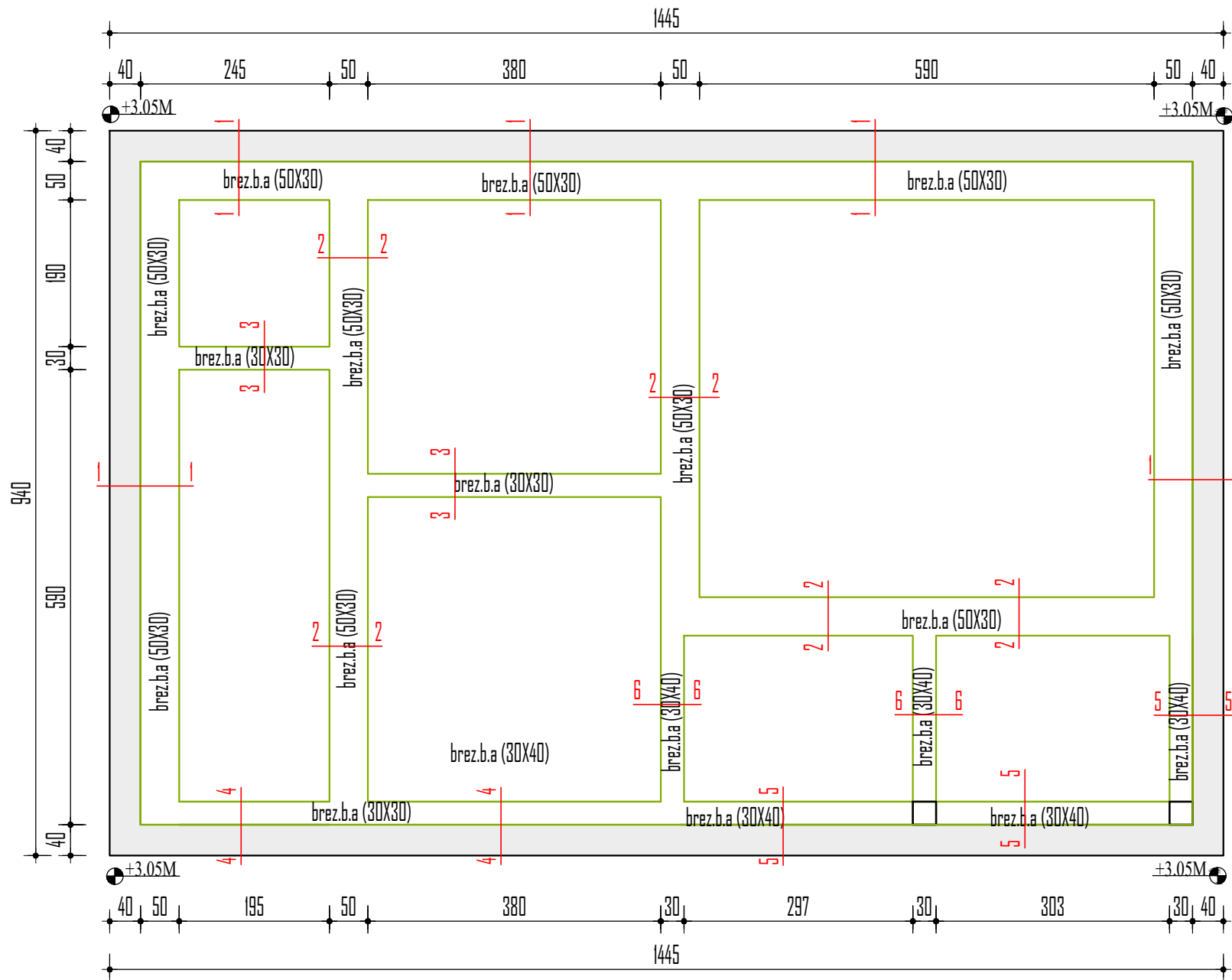

Hekur Ø8mm	61.23kg
Hekur Ø14mm	174.72kg

OBJEKTI: PERFORCIMI/REHABILITIMI I BANESAVE EKZISTUESE		Faza eProjektit: Projekt-zbatimi	
EMERTESA E FLETES:PLANI I BREZAVE NENÇATI		Nr.fletes 6	
BASHKIA CERRIK Drejtori D.P.T.&ZH.	Porositesi: <i>Sektori i Strehimit</i>	Hartoi ing.Fatmir Uruçi	neshkrimi
	Perfituese: <i>Pellumb Rrapush Sula</i> Rruga: "Gjimnazi 1962" Lagja "Lagja Nr 2" Cerrik E-Mail: bashkiacerrik@yahoo.com	ing.Erdison Baxhia ing.Arber Disha tek.Shkelqim Liçi	
		janar 2023	

PRERJA A-A

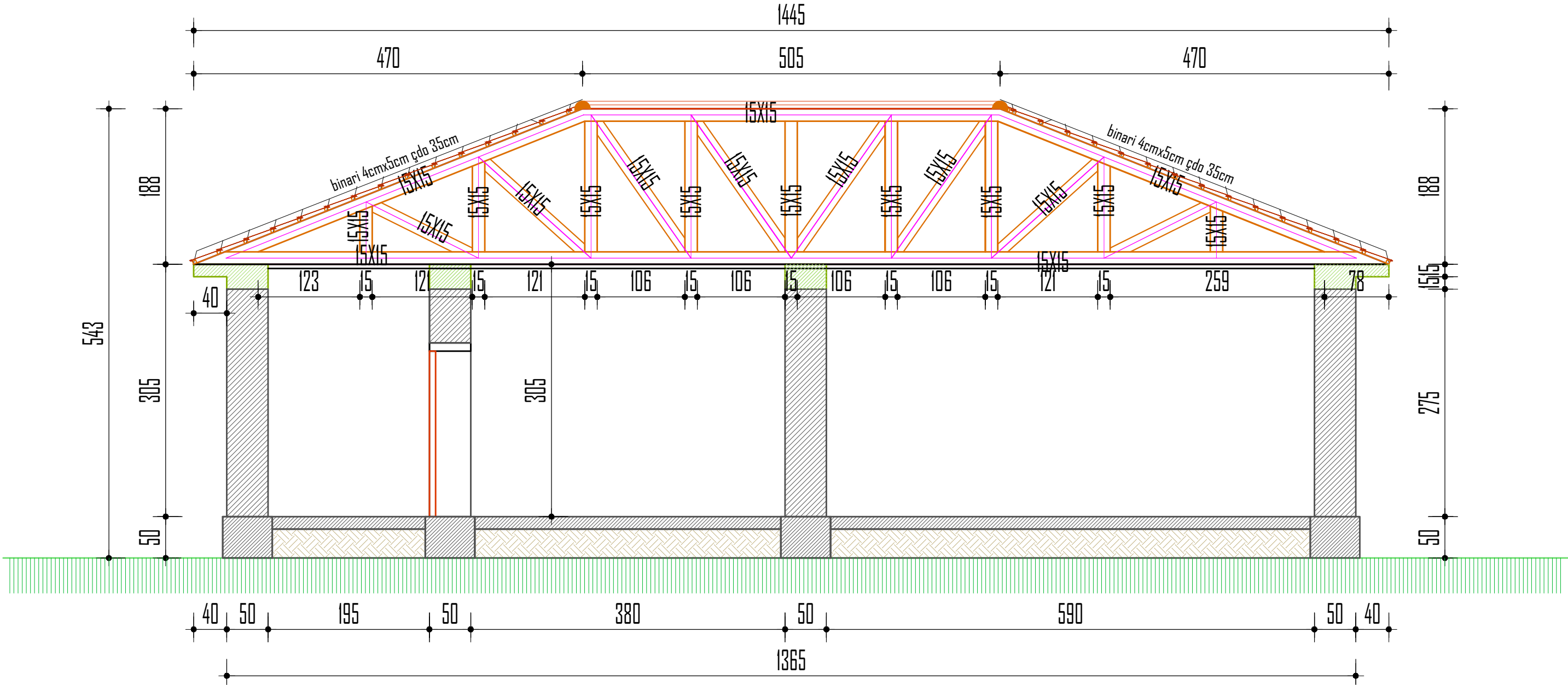

OBJEKTI: PERFORCIMI/REHABILITIMI I BANESAVE EKZISTUESE			<i>Faza eProjektit:</i> Projekt-zbatimi
EMERTESA E FLETES:PRERJA A-A			Nr.fletes 7
BASHKIA CERRIK  Drejtori D.P.T.&ZH.	Porositesi: <i>Sektori i Strehimit</i> Perfituese: <i>Pellumb Rrapush Sula</i> Rruga: <i>"Gjimnazi 1962"</i> Lagja <i>'Lagja Nr 2" Cerrik</i> E-Mail: <i>bashkiacerrik@yahoo.com</i>	Hartoi ing.Fatmir Uruçi ing.Erdison Baxhia ing.Arber Disha tek.Shkelqim Liçi	<i>neshkrimi</i> Sh.1:50 janar 2023

PLANI I BREZIT B.A NENÇATI NE 3.05M SH.1:100

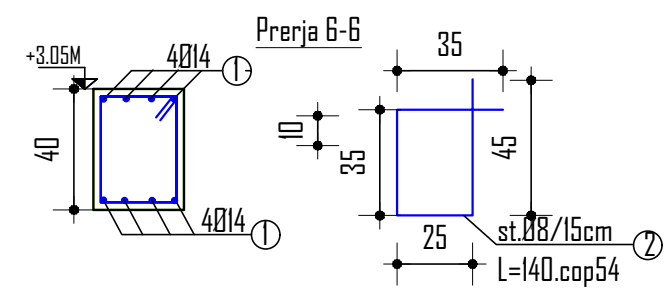
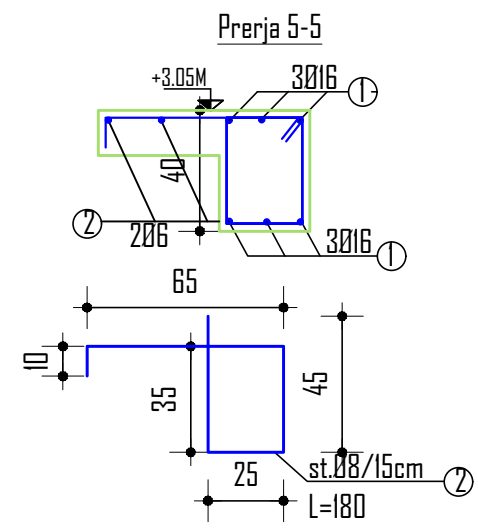
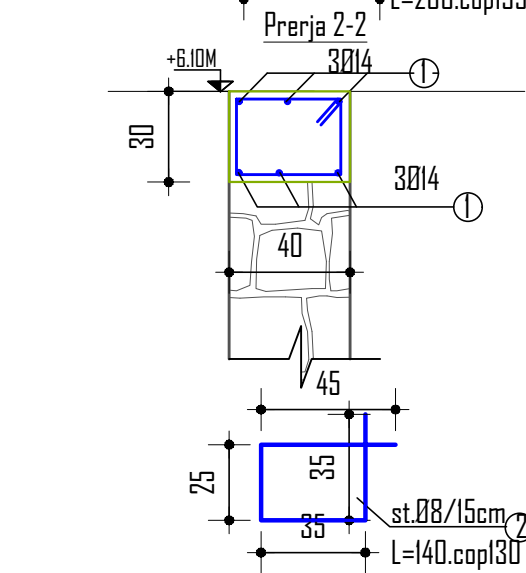
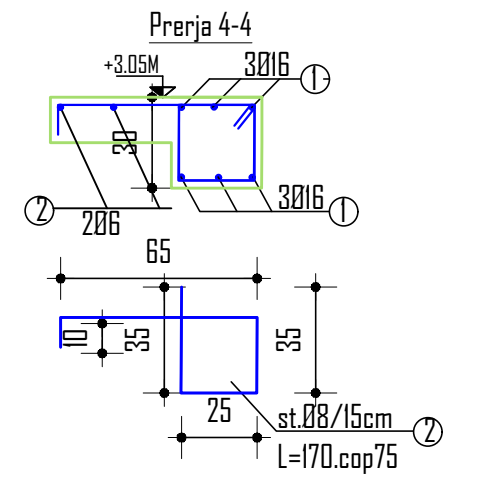
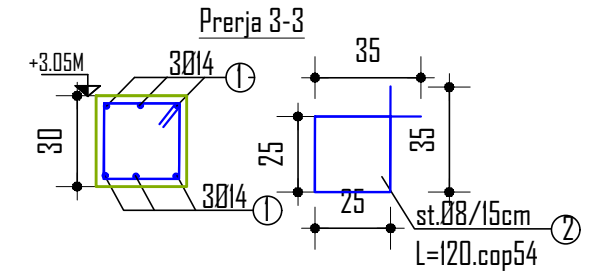
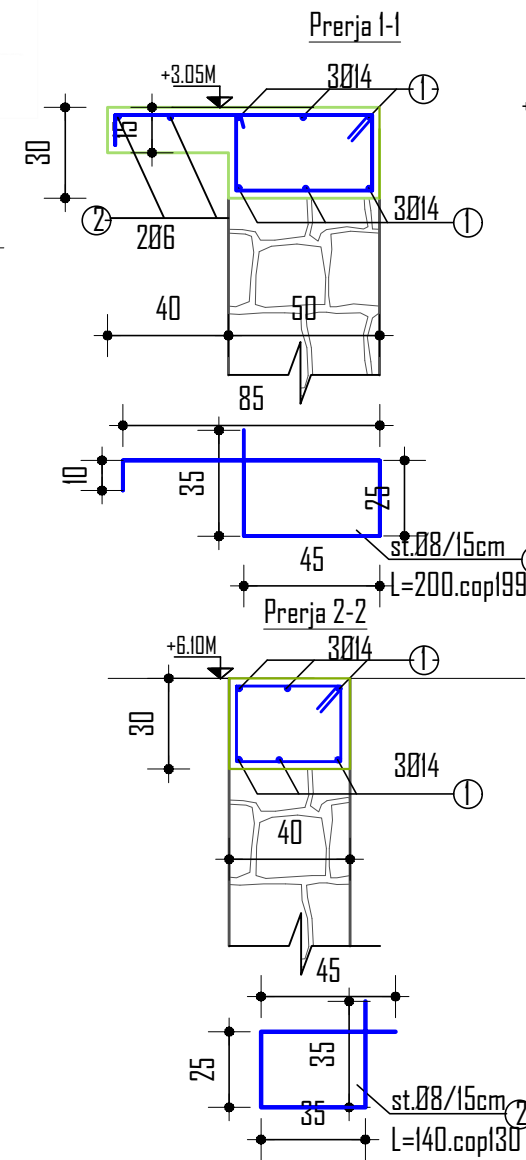
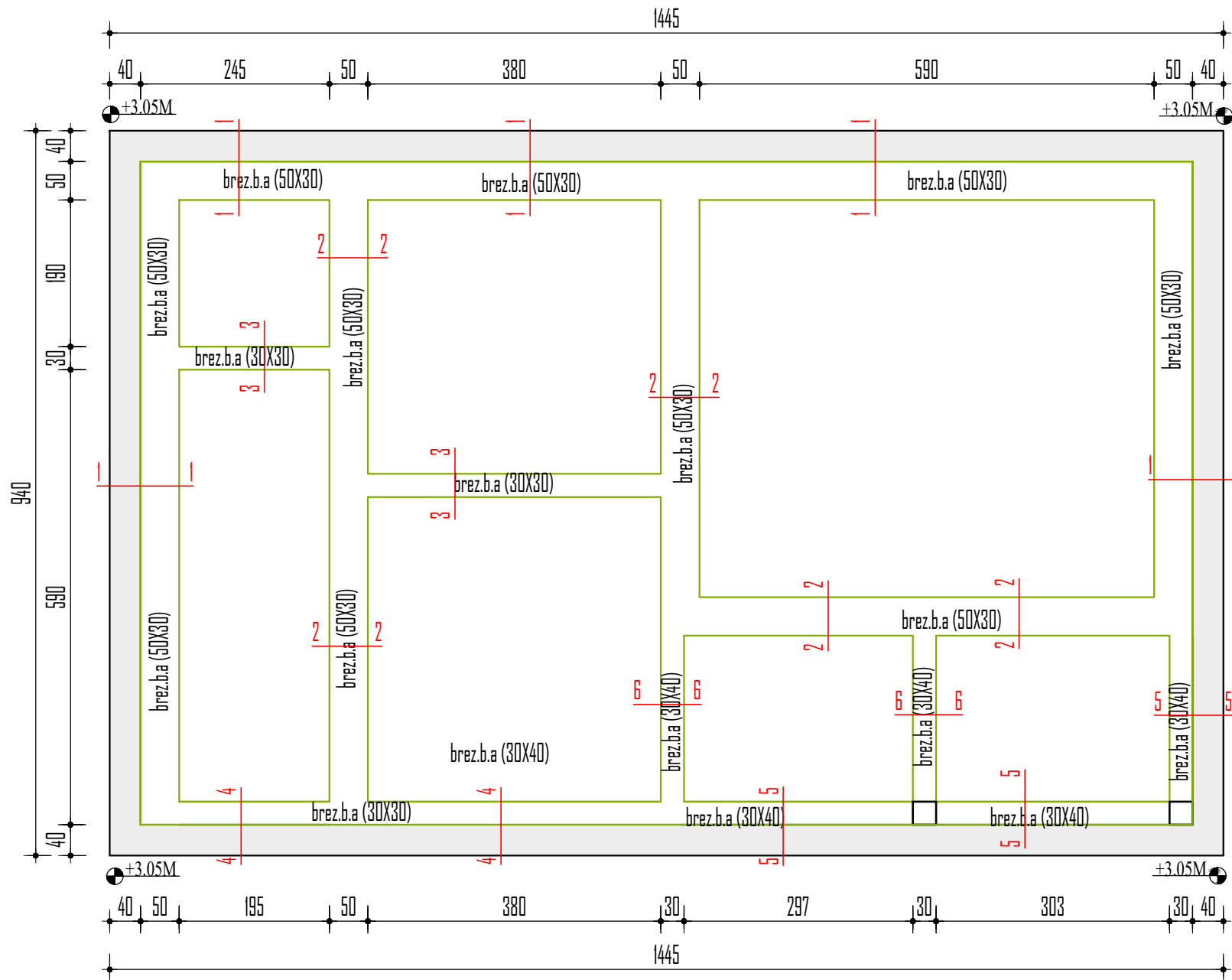

Hekur Ø8mm	61.23kg
Hekur Ø14mm	174.72kg

OBJEKTI: PERFORCIMI/REHABILITIMI I BANESAVE EKZISTUESE		Faza eProjektit: Projekt-zbatimi	
EMERTESA E FLETES:PLANI I BREZAVE NENÇATI		Nr.fletes 6	
BASHKIA CERRIK  Drejtori D.P.T.&ZH.	Porositesi: <i>Sektori i Strehimit</i>	Hartoi ing.Fatmir Uruçi	neshkrimi
	Perfituese: <i>Pellumb Rrapush Sula</i> <i>Rruga: "Gjimnazi 1962"</i> <i>Lagja "Lagja Nr 2" Cerrik</i> <i>E-Mail: bashkiacerrik@yahoo.com</i>	ing.Erdison Baxhia ing.Arber Disha tek.Shkelqim Liçi	
		janar 2023	

PRERJA A-A

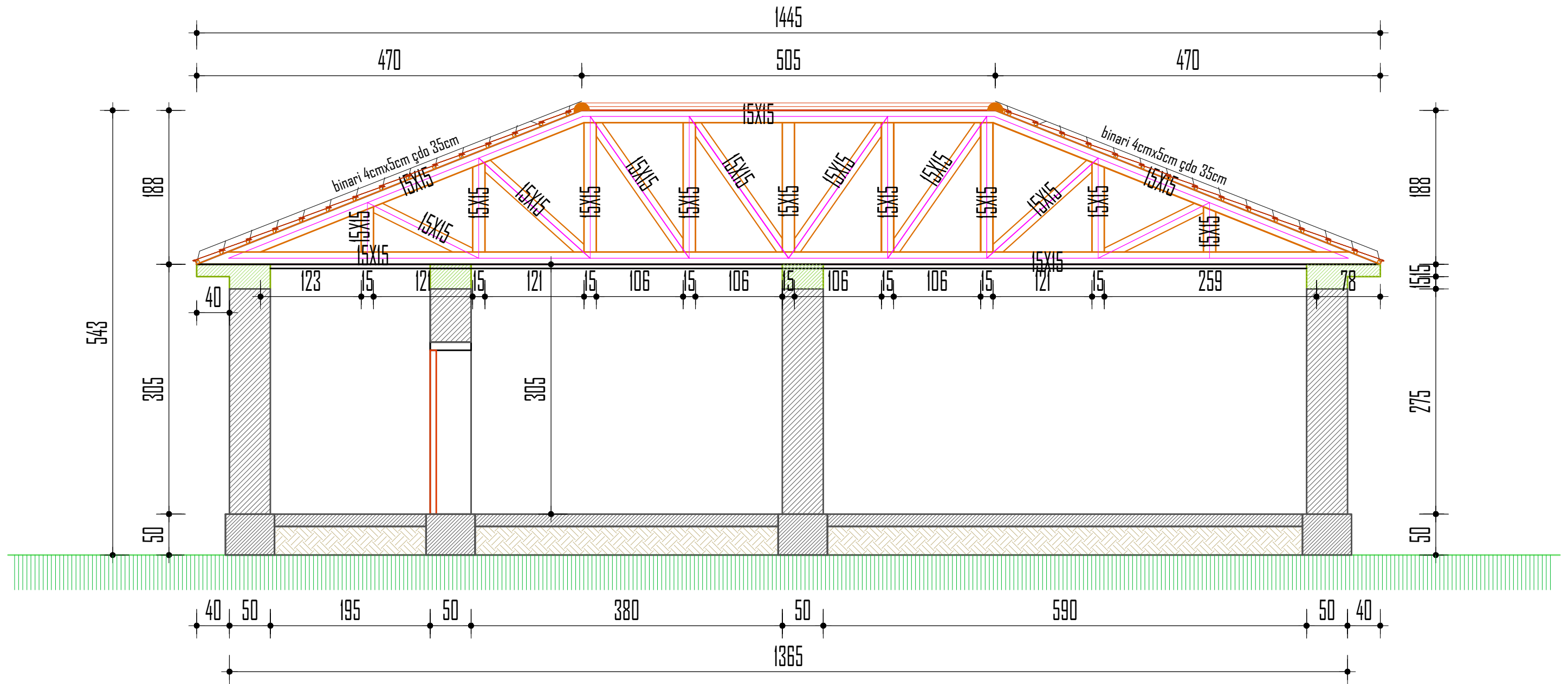

OBJEKTI: PERFORCIMI/REHABILITIMI I BANESAVE EKZISTUESE		<i>Faza eProjektit:</i> <i>Projekt-zbatimi</i>	
EMERTESA E FLETES:PRERJA A-A		Nr.fletes 7	
BASHKIA CERRIK  Drejtori D.P.T.&ZH.	Porositesi: <i>Sektori i Strehimit</i> Perfituese: <i>Pellumb Rrapush Sula</i> Rruga: <i>"Gjimnazi 1962"</i> Lagja <i>'Lagja Nr 2" Cerrik</i> E-Mail: <i>bashkiacerrik@yahoo.com</i>	Hartoi ing.Fatmir Uruçi ing.Erdison Baxhia ing.Arber Disha tek.Shkelqim Liçi	<i>neshkrimi</i> Sh.1:50 janar 2023

PAMJE NGA LART E ÇATISE SH.1:100

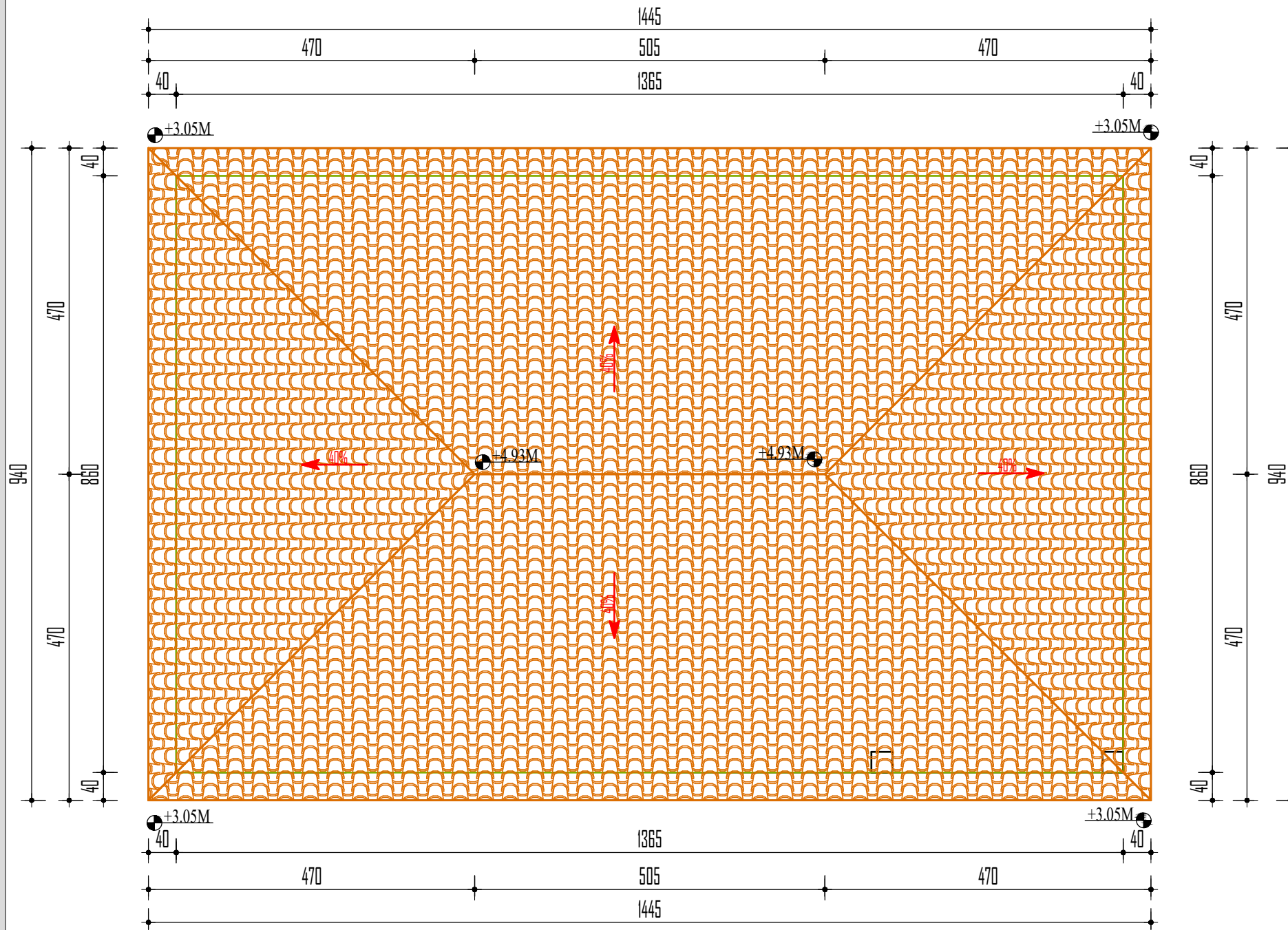

OBJEKTI: PERFORCIMI/REHABILITIMI I BANESAVE EKZISTUESE			<i>Faza eProjektit:</i> <i>Projekt-zbatimi</i>
EMERTESA E FLETES:PAMJE NGA LART E ÇATISE			Nr.fletes 8
BASHKIA CERRIK  Drejtori D.P.T.&ZH.	Porositesi: <i>Sektori i Strehimit</i>	Hartoi ing.Fatmir Uruçi ing.Erdison Baxhia ing.Arber Disha tek.Shkelqim Liçi	<i>neshkrimi</i> Sh.1:75 <i>janar 2023</i>
	Rrugë: <i>"Gjimnazi 1962"</i> Lagja <i>'Lagja Nr 2" Cerrik</i> E-Mail: <i>bashkiacerrik@yahoo.com</i>		

PLANVENDOSJE PER PUNIME PERFORCIM/REHABILITIMI I BANESES 1 KAT
ME VENDODHJE: „SELITE NJ.AD. MOLLAS -BASHKIA CERRIK.ZHVILLUESI:B.CERRIK

PERFITUES PELLUMB RRAPUSH SULA

.SH.1:1000

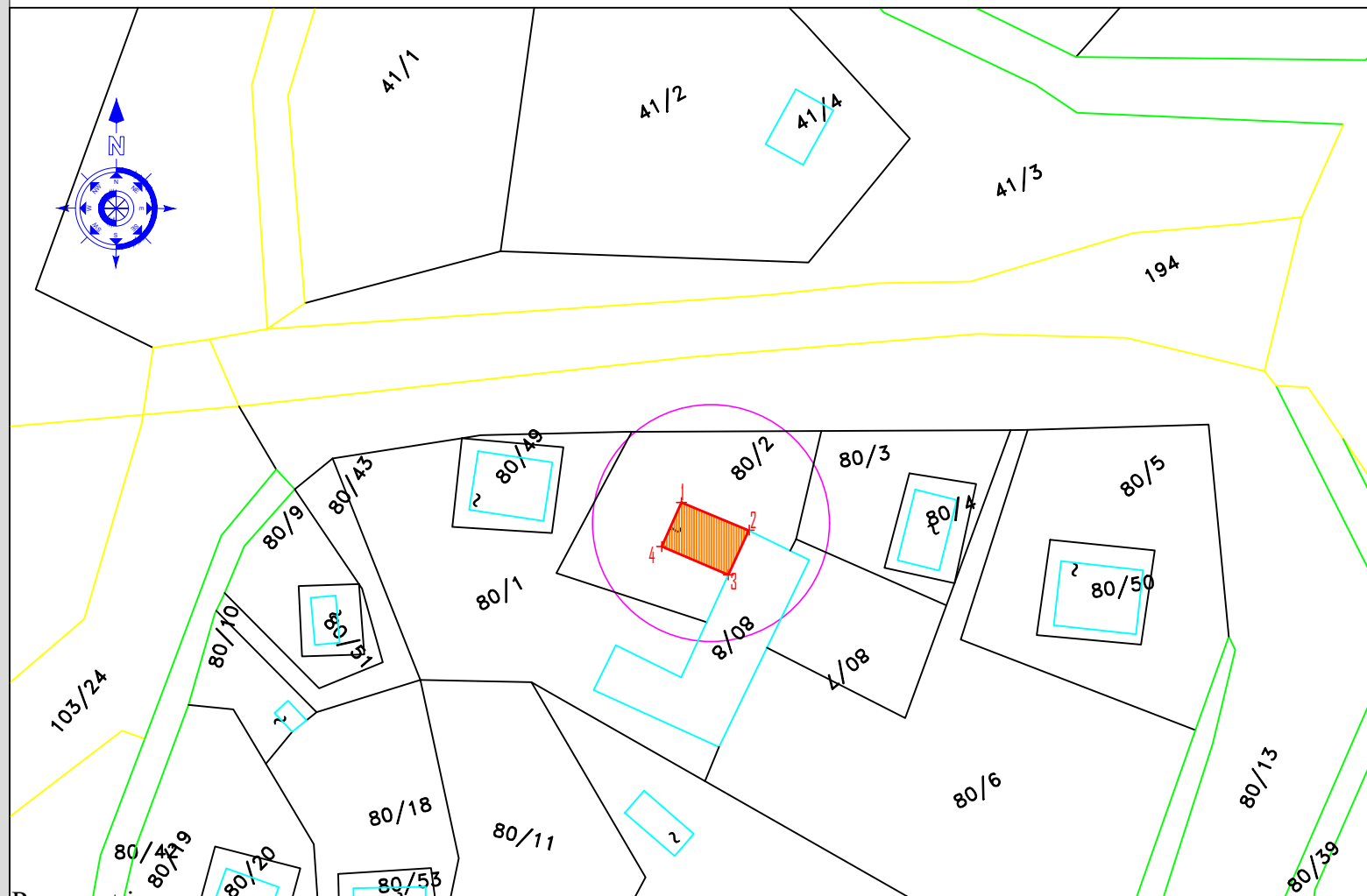

Permasat jane ne cm

BANESA NE ORTOFOTO SH.1:1500

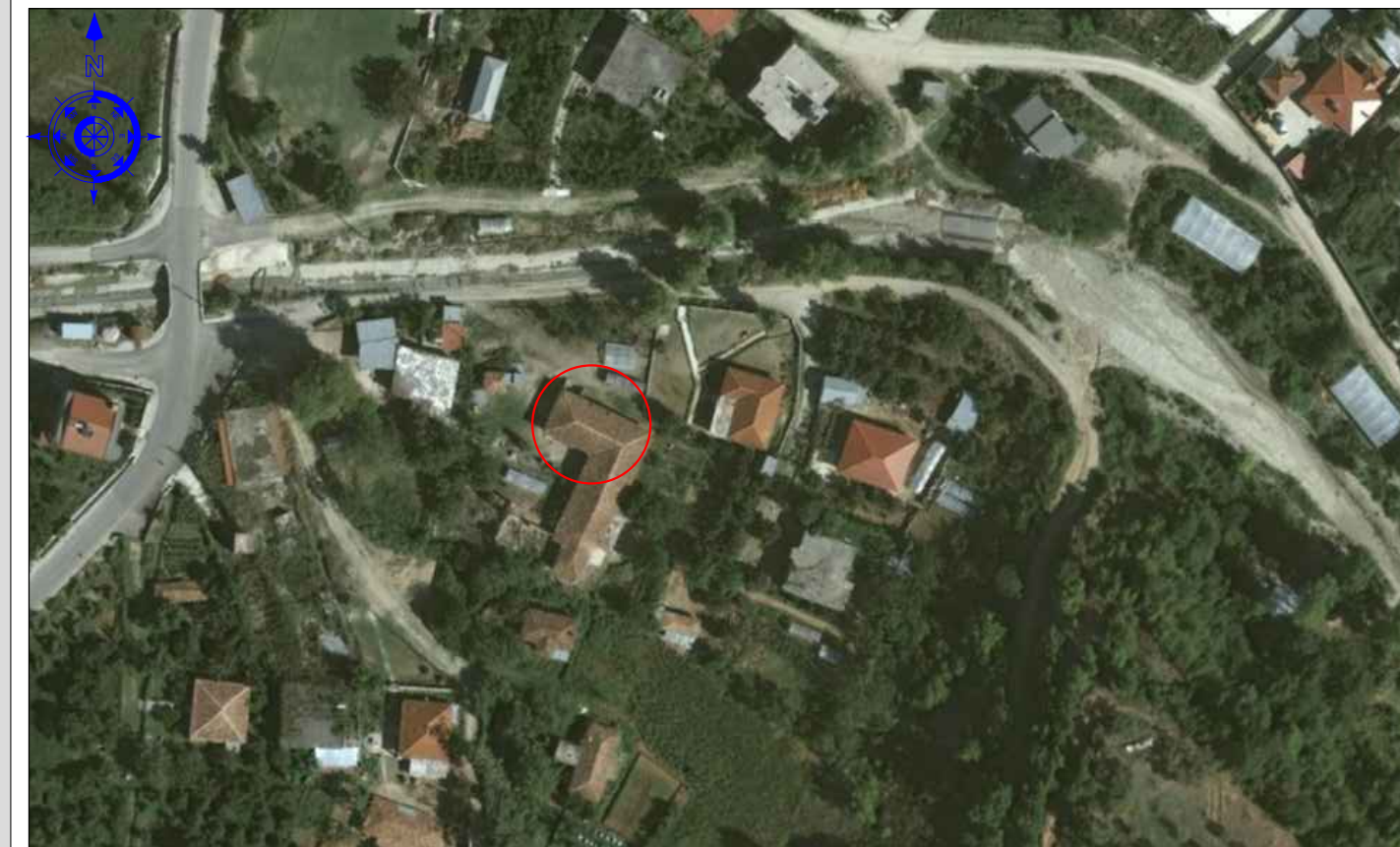

 Konturet e mureve perimetrale te katit pare

Koordinatat e Konturit te baneses
ne projektionin Nderkombetar-UTM
Sistemi 2000
1.X = 4526589.09 Y = 413898.33
2.X = 4526583.94 Y = 413907.79
3.X = 4526575.88 Y = 413902.66
4.X = 4526580.74 Y = 413894.31

TE DHENA TE PERGJITHSHME

EMERTIMI I PUNIMEVE: "PERFORCIMI /REHABILITIMI I BANESES 1 KAT EKZISTUESE
KATEGORIA E PERDORIMIT TE TOKES: **TOKE TRUALL**
LLOJI I STRUKTURES EKZISTUESE: MUR GURI ,ÇATI DRURI ,TJENGULLA VENDI
ZHVILLUESI PUNIMEVE :**BASHKIA CERRIK**
PRONARI I NDERTESES EKZISTUESE: PELLUMB RRAPUSH SULA
PERFITUESI: PELLUMB RRAPUSH SULA
ADRESA: **Z.K. 3294 PAS.80/2/1** FSHATI SELITE, NJ. AD. MOLLAS, B. CERRIK
KODI NEN-NJESISE STRUKTURORE 4/18
KODI I PERDORIMIT SIPAS PLANIT (Kategoria Baze e Perdorimit te Tokes) A-Banim

TREGUESIT E ZHVILLIMIT EKZISTUESE

SIPERFAQE E TRUALLIT	250m ²
SIPERFAQJA E BANESES SIPAS ASHK	70 m ²
SIPERFAQJA E BANESES SIPAS FAKTIT	117 m ²
SIPERFAQJA E ÇATISE	136m ²
LARTESIA MESATARE E XOKOLIT	0.50 m
LARTESIA E BANESES	2.75m
LARTESIA E ÇATISE	1.88m
LARTESIA MAX E STRUKTURES NGA TOKA SISTEMUAR	5.13m
TREGUESIT E OBJEKTIT PAS NDERTIMIT TE ÇATISE	
SIPERFAQJA E KATIT PERDHE SIPAS FAKTIT	117 m ²
SIPERFAQJA E ÇATISE	136m ²
LARTESIA MESATARE E XOKOLIT	0.50 m
LARTESIA E BANESES	3.05m
LARTESIA E ÇATISE	1.88m
LARTESIA MAX E STRUKTURES NGA TOKA SISTEMUAR	5.43m

Kryetari
Bashkise Cerrik

Andis SALLA

Drejtori D.P.T.&ZH.

Ing.Fatmir URUÇI

Perfituesi

Pellumb Rrapush Sula

Pozicioni Topografik i Nderteses

Veriu. Pasuria 80/2 Jugu Pasuria;80/2
Lindje Pasuria 80/2 Perendimi. Pasuria 80/2

OBJEKTI:
PERFORCIMI/REHABILITIMI I BANESEVE EKZISTUESE

Faza e Projektit:
Projekt-zbatimi

EMERTESA E FLETES: PLANVENDOSJE

Nr.fletes 2

BASHKIA CERRIK



Drejtori D.P.T.&ZH.

Porositesi: *Sektori i Strehimit*

Perfituese: *Pellumb Rrapush Sula*

Rruga: *"Gjimnazi 1962"*

Lagja *'Lagja Nr 2" Cerrik*

E-Mail: *bashkiacerrik@yahoo.com*

Hartoi

ing.Fatmir Uruçi

ing.Erdison Baxhia

ing.Arber Disha

tek.Shkelqim Liçi

neshkrimi

Sh.1:75

janar 2023

FOTO E GJENDJES EKZISTUESE

PLANIMETRIA E BANESES SH.1:100

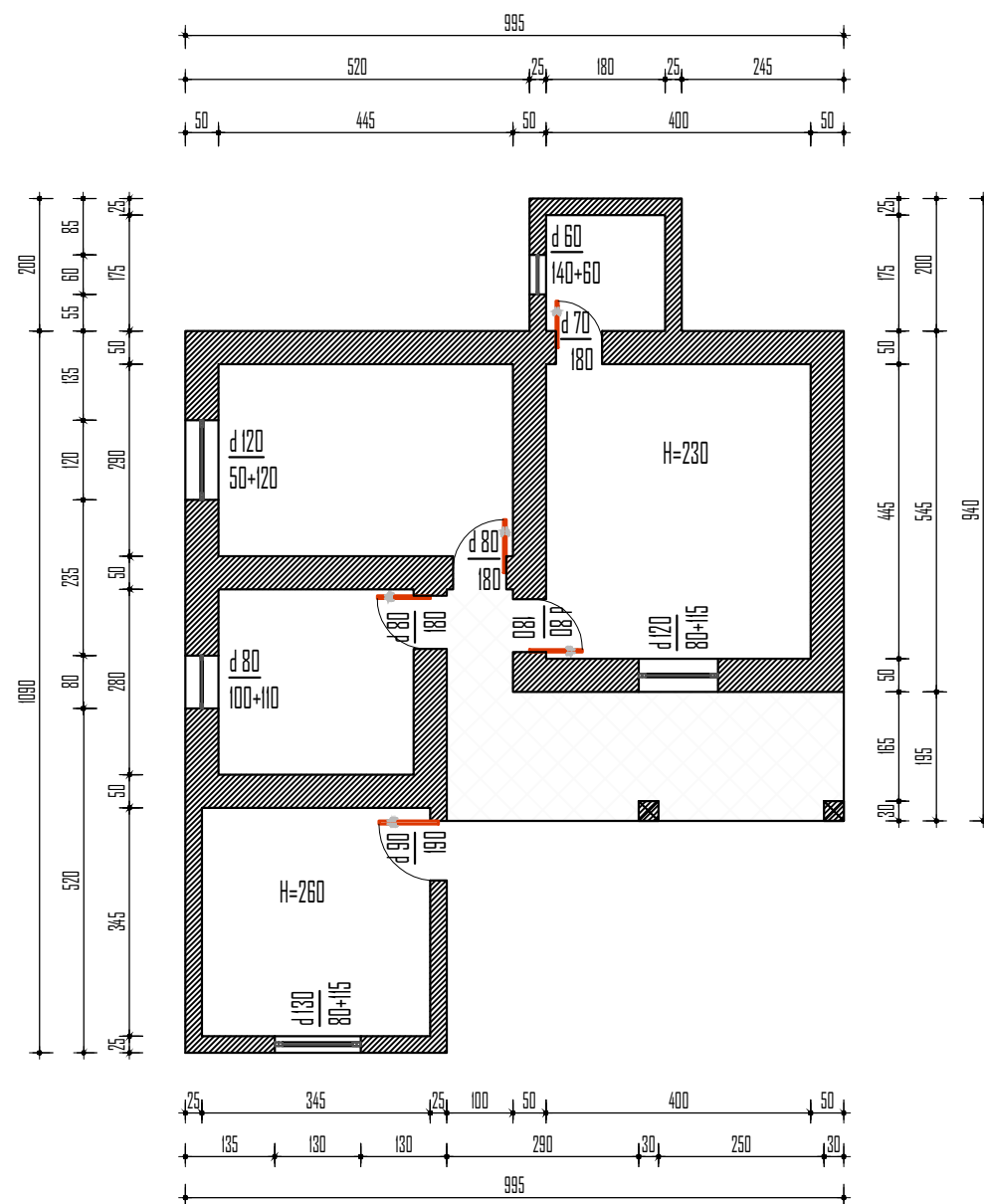

OBJEKTI: PERFORCIMI/REHABILITIMI I BANESAVE EKZISTUESE		<i>Faza eProjektit:</i> <i>Projekt-zbatimi</i>	
EMERTESA E FLETES:PLANVENDOSJE		Nr.fletes 3	
BASHKIA CERRIK  Drejtori D.P.T.&ZH.	<i>Porositesi: Sektori i Strehimit</i>	Hartoi ing.Fatmir Uruçi	<i>neshkrimi</i>
	<i>Perfituese: Bajame Hamit Xibraku</i> <i>Rruga:"Gjimnazi 1962"</i> <i>Lagja 'Lagja Nr 2" Cerrik</i> <i>E-Mail:bashkiacerrik@yahoo.com</i>	ing.Erdison Baxhia ing.Arberi Disha tek.Shkelqim Liçi	
			<i>janar 2023</i>

OBJEKTI:

"PERFORCIMI /REHABILITIMI I BANESES 1 KAT

ANDRESA:

Z.K.1452,PASURIA 34/7 FSHATI DASAR -NJ.AD.MOLLAS -B CERRIK

PERFITUES:PETRIT MEHALLA

POROSITI:SEKTORI E STREHIMIT

OBJEKTI: PERFORCIMI/REHABILITIMI I BANESAVE EKZISTUESE			<i>Faza eProjektit:</i> Projekt-zbatimi
EMERTESA E FLETES:KOPERTINA			Nr.fletes 1
 BASHKIA CERRIK Drejtori D.P.T.&ZH.	<i>Porositesi: Sektori i Strehimit</i>	Hartoi	<i>neshkrimi</i>
	<i>Perfituese: Petrit Mehalla</i>	ing.Fatmir Uruçi	
	<i>Rruga: "Gjimnazi 1962"</i>	ing.Erdison Baxhia	
	<i>Lagja 'Lagja Nr 2" Cerrik</i> <i>E-Mail: bashkiacerrik@yahoo.com</i>	ing.Arber Disha	
		tek.Shkelqim Liçi	<i>janar 2023</i>

OBJEKTI:

"PERFORCIMI /REHABILITIMI I BANESES 1 KAT

ANDRESA:

Z.K.1452,PASURIA 34/7 FSHATI DASAR -NJ.AD.MOLLAS -B CERRIK

PERFITUES:PETRIT MEHALLA

POROSITI:SEKTORI E STREHIMIT

OBJEKTI: PERFORCIMI/REHABILITIMI I BANESAVE EKZISTUESE			<i>Faza eProjektit:</i> <i>Projekt-zbatimi</i>
EMERTESA E FLETES:KOPERTINA			Nr.fletes 1
 Drejtori D.P.T.&ZH.	<i>Porositesi: Sektori i Strehimit</i>	Hartoi	<i>neshkrimi</i>
	<i>Perfituese:Petrit Mehalla</i>	ing.Fatmir Uruçi	
	<i>Rruga:"Gjimnazi 1962"</i>	ing.Erdison Baxhia	
	<i>Lagja 'Lagja Nr 2" Cerrik</i> <i>E-Mail:bashkiacerrik@yahoo.com</i>	ing.Arber Disha	
		tek.Shkelqim Liçi	<i>janar 2023</i>

PLANIMETRIA E BANESES SH.1:100





FOTO E GJENDJES EKZISTUESE

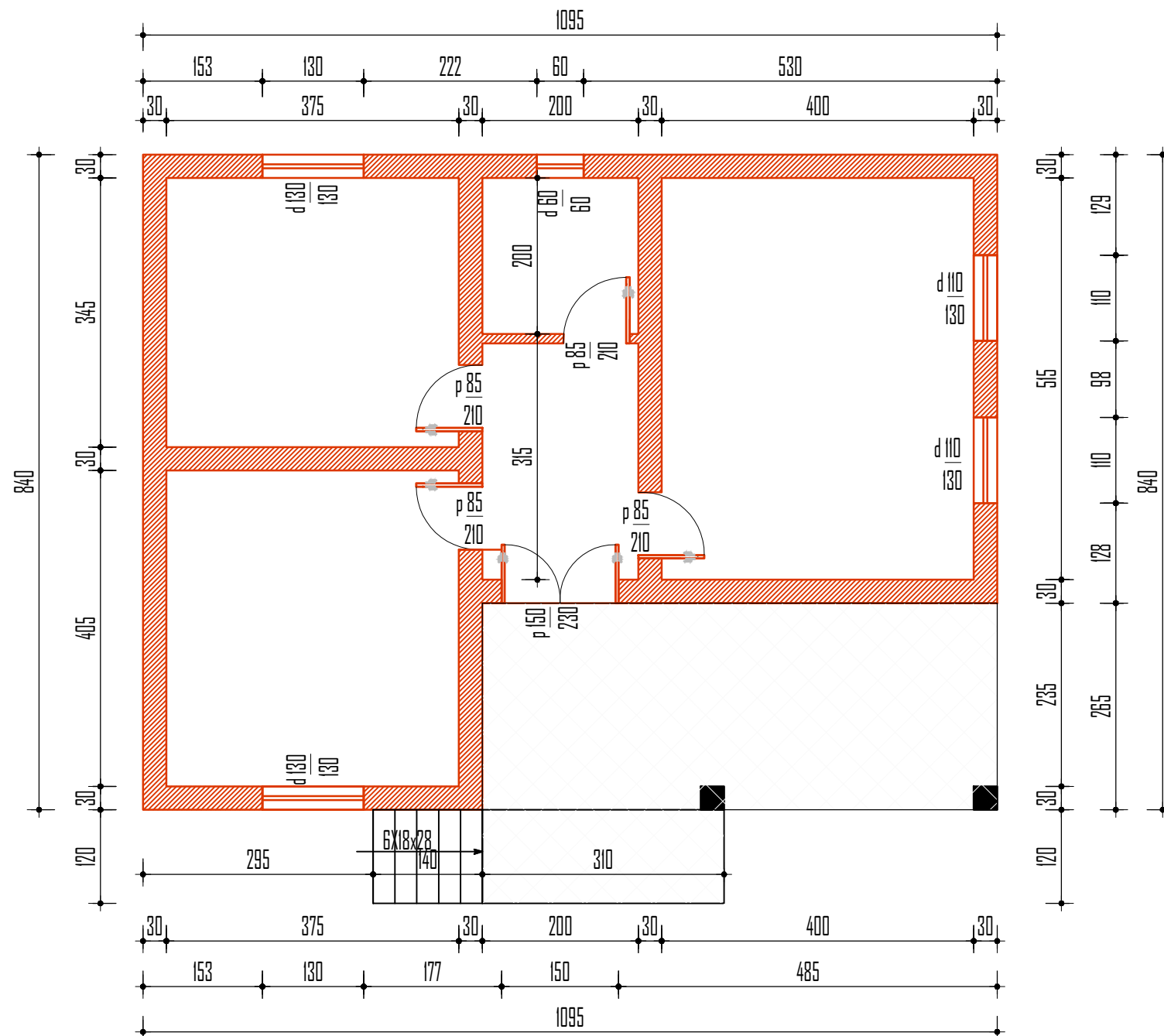
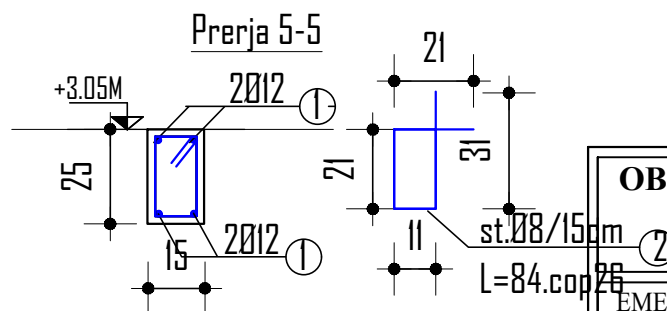
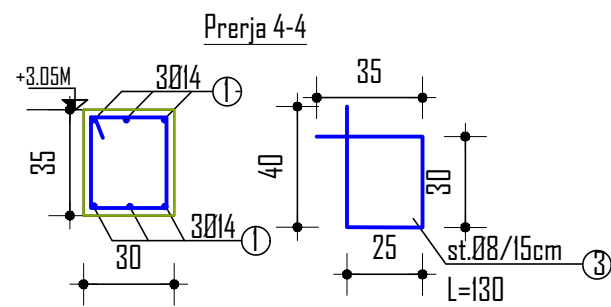
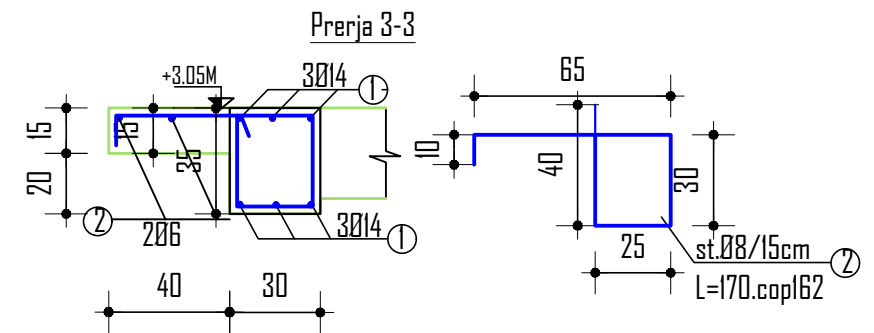
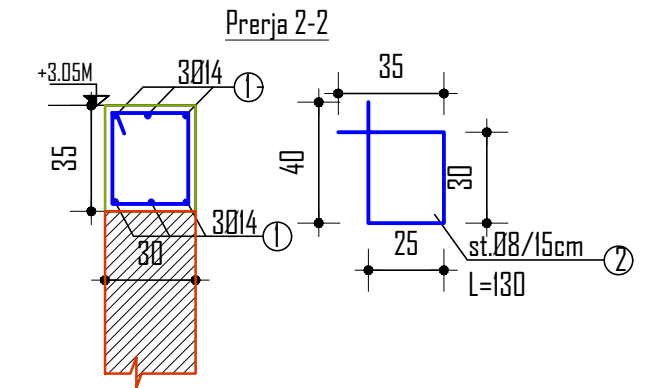
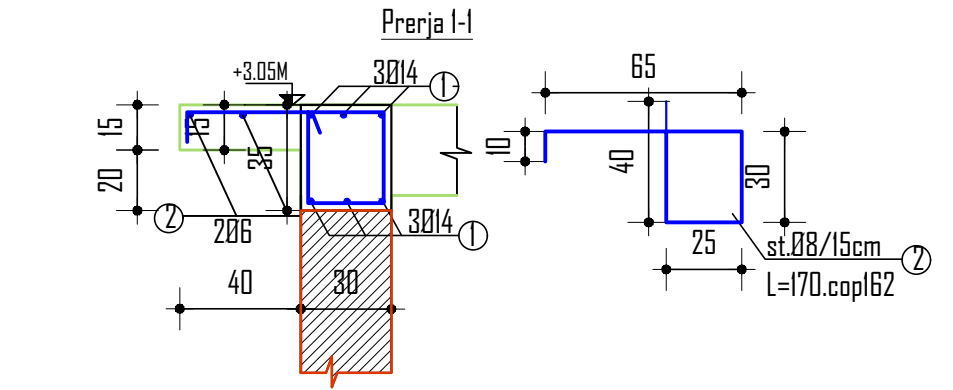
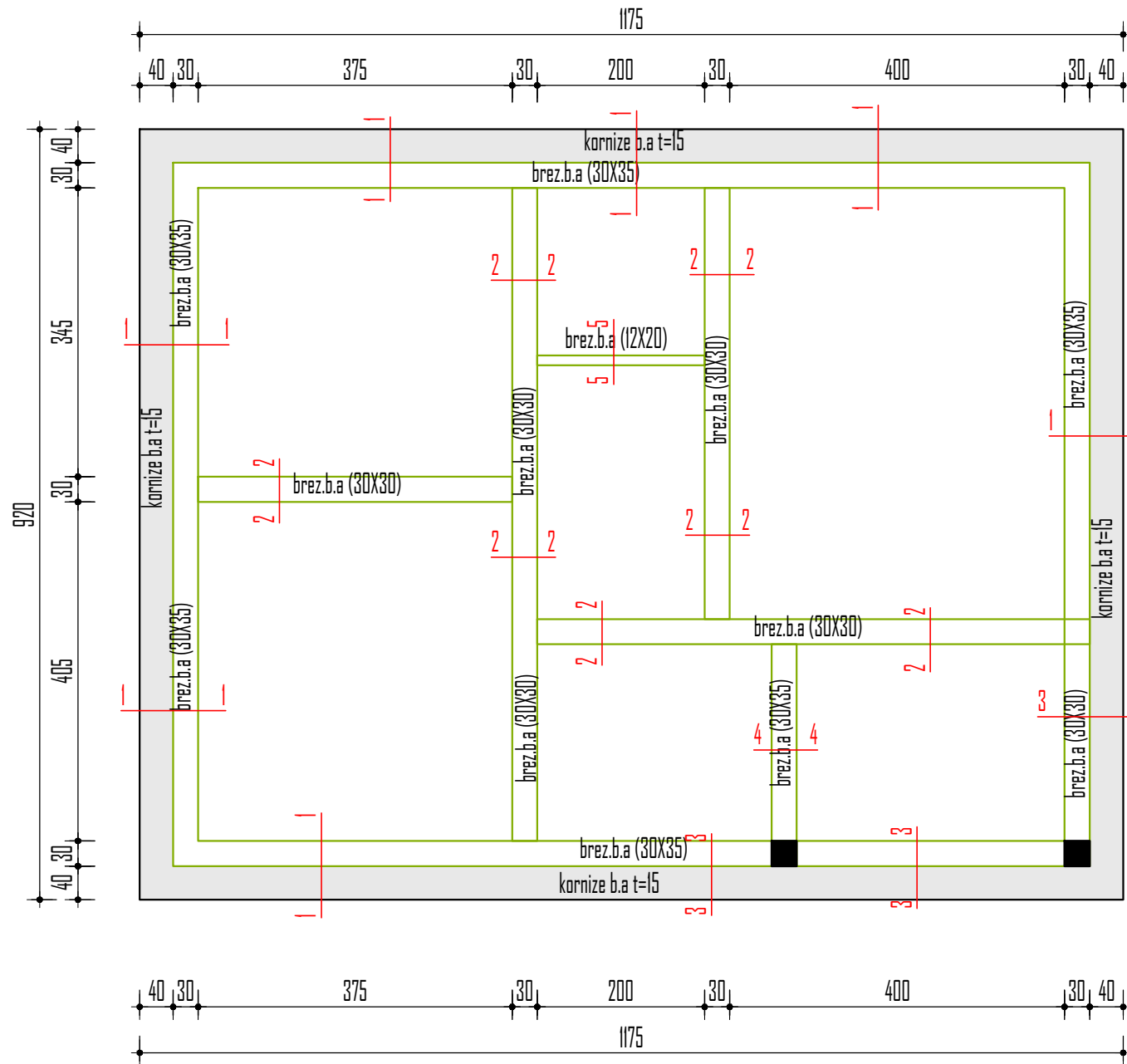

OBJEKTI: PERFORCIMI/REHABILITIMI I BANESAVE EKZISTUESE		<i>Faza eProjektit:</i> <i>Projekt-zbatimi</i>	
EMERTESA E FLETES:PLANI I I BANESES EKZISTUESE		Nr.fletes 3	
BASHKIA CERRIK  Drejtori D.P.T.&ZH.	Porositesi: <i>Sektori i Strehimit</i> Perfituese: <i>Petrit Mehalla</i> Rruga: <i>"Gjimnazi 1962"</i> Lagja <i>'Lagja Nr 2" Cerrik</i> E-Mail: <i>bashkiacerrik@yahoo.com</i>	Hartoi ing.Fatmir Uruçi ing.Erdison Baxhia ing.Arber Disha tek.Shkelqim Liçi	<i>neshkrimi</i> Sh.1:75 <i>janar 2023</i>

PLANI I KORNIZES DHE I BREZAVE NENÇATI
SH.1:100



OBJEKTI: PERFORCIMI/REHABILITIMI I BANESAVE EKZISTUESE		Faza eProjektit: Projekt-zbatimi
EMERTESA E FLETES:PLANI I BREZAVE B.A		Nr.fletes 4
BASHKIA CERRIK  Drejtori D.P.T.&ZH.	Porositesi: <i>Spektori i Strehimit</i> Perfituese: <i>Petrit Mehalla</i> Rruga: <i>"Gjimnazi 1962"</i> Lagja <i>'Lagja Nr 2" Cerrik</i> E-Mail: <i>bashkiacerrik@yahoo.com</i>	Hartoi ing.Fatmir Uruçi ing.Erdison Baxhia ing.Arber Disha tek.Shkelqim Liçi <i>neshkrimi</i>
		Sh.1:75
		janar 2023

PRERJA A-A

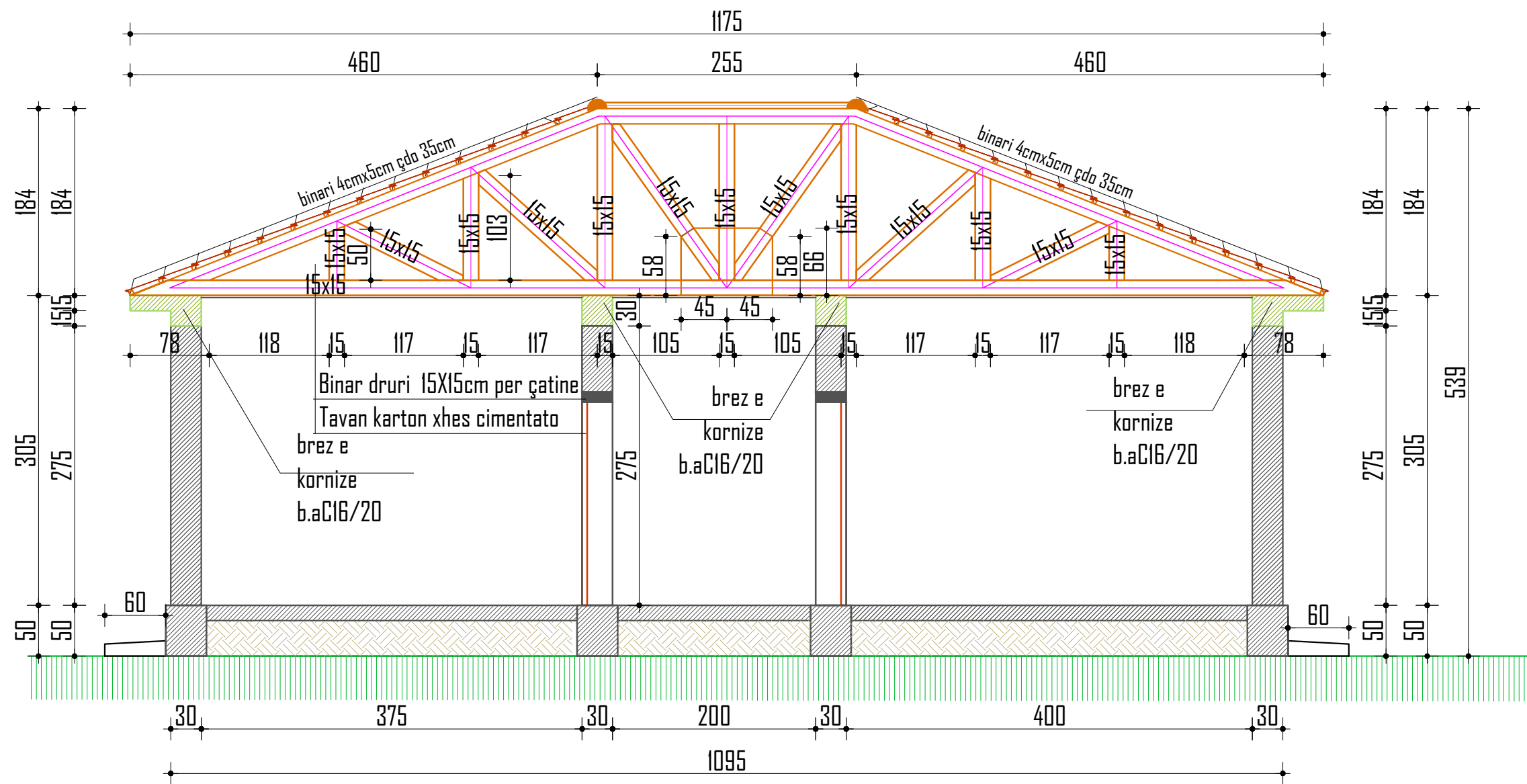

OBJEKTI: PERFORCIMI/REHABILITIMI I BANESAVE EKZISTUESE		<i>Faza eProjektit:</i> <i>Projekt-zbatimi</i>
EMERTESA E FLETES:PRERJA A-A		Nr.fletes 5
BASHKIA CERRIK  Drejtori D.P.T.&ZH.	Porositesi: <i>Sektori i Strehimit</i> Perfituese: <i>Petrit Mehalla</i> Rruga: <i>"Gjimnazi 1962"</i> Lagja <i>'Lagja Nr 2" Cerrik</i> E-Mail: <i>bashkiacerrik@yahoo.com</i>	Hartoi ing.Fatmir Uruçi ing.Erdison Baxhia ing.Arber Disha tek.Shkelqim Liçi
	<i>neshkrimi</i>	
		<i>janar 2023</i>

PAMJE NGA LART E ÇATISE SH.1:100

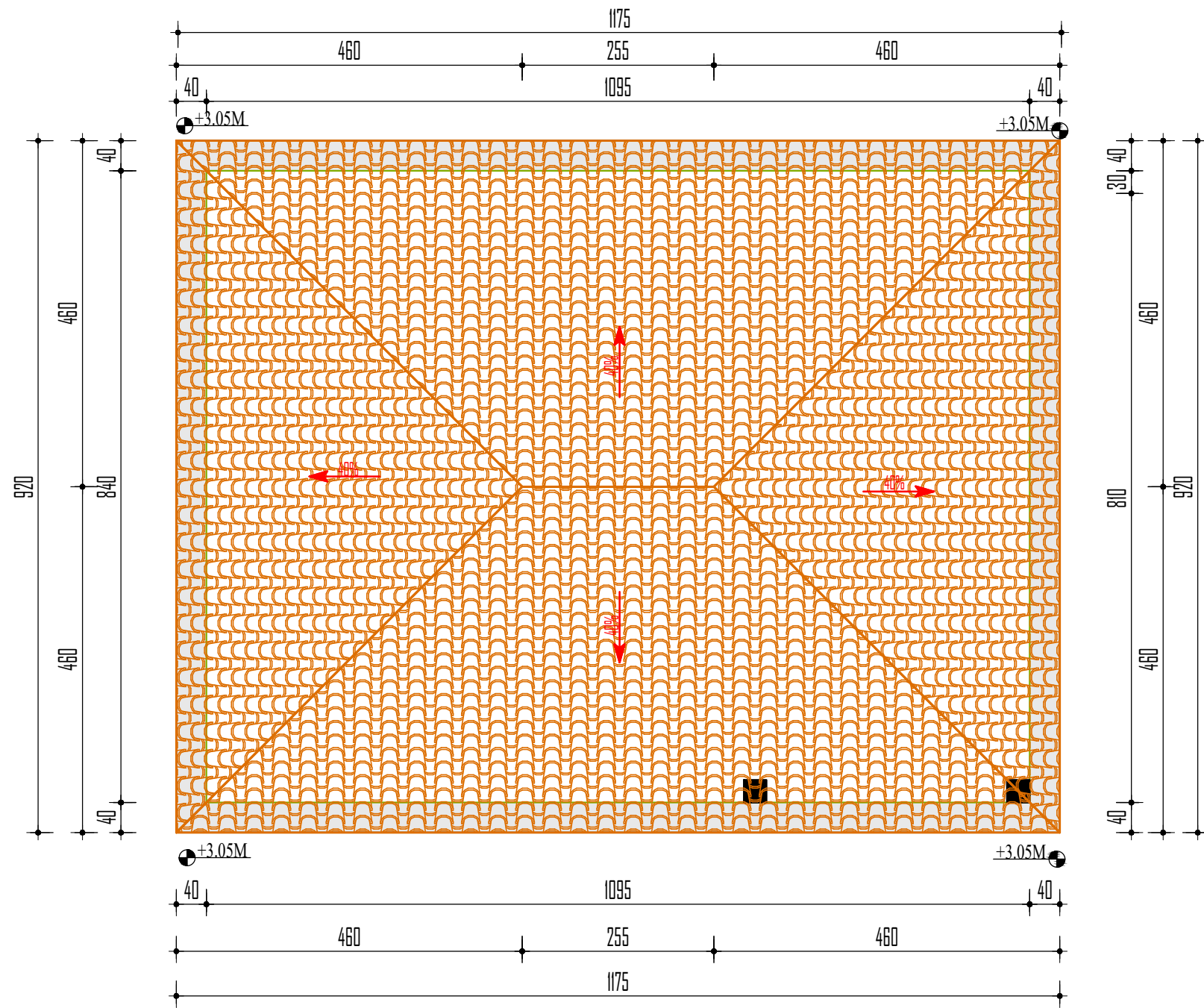

OBJEKTI: PERFORCIMI/REHABILITIMI I BANESAVE EKZISTUESE			<i>Faza eProjektit:</i> <i>Projekt-zbatimi</i>
EMERTESA E FLETES:PAMJE E ÇATISE NGA LART			Nr.fletes 6
BASHKIA CERRIK  Drejtori D.P.T.&ZH.	Porositesi: <i>Sektori i Strehimit</i> Perfituese: <i>Petrit Mehalla</i> Rruga: <i>"Gjimnazi 1962"</i> Lagja <i>'Lagja Nr 2" Cerrik</i> E-Mail: <i>bashkiacerrik@yahoo.com</i>	Hartoi ing.Fatmir Uruçi ing.Erdison Baxhia ing.Arber Disha tek.Shkelqim Liçi	<i>neshkrimi</i>
			Sh.1:75
			<i>janar 2023</i>

PLANVENDOSJE PER PUNIME PERFORCIM/REHABILITIMI I BANESES 1 KAT
 VENDODHJE: DASAR ,NJ.AD. MOLLAS -BASHKIA CERRIK.ZHVILLUESI: B.CERRIK

PERFITUES: PETRIT HALIM MEHALLA

SH.1:1000

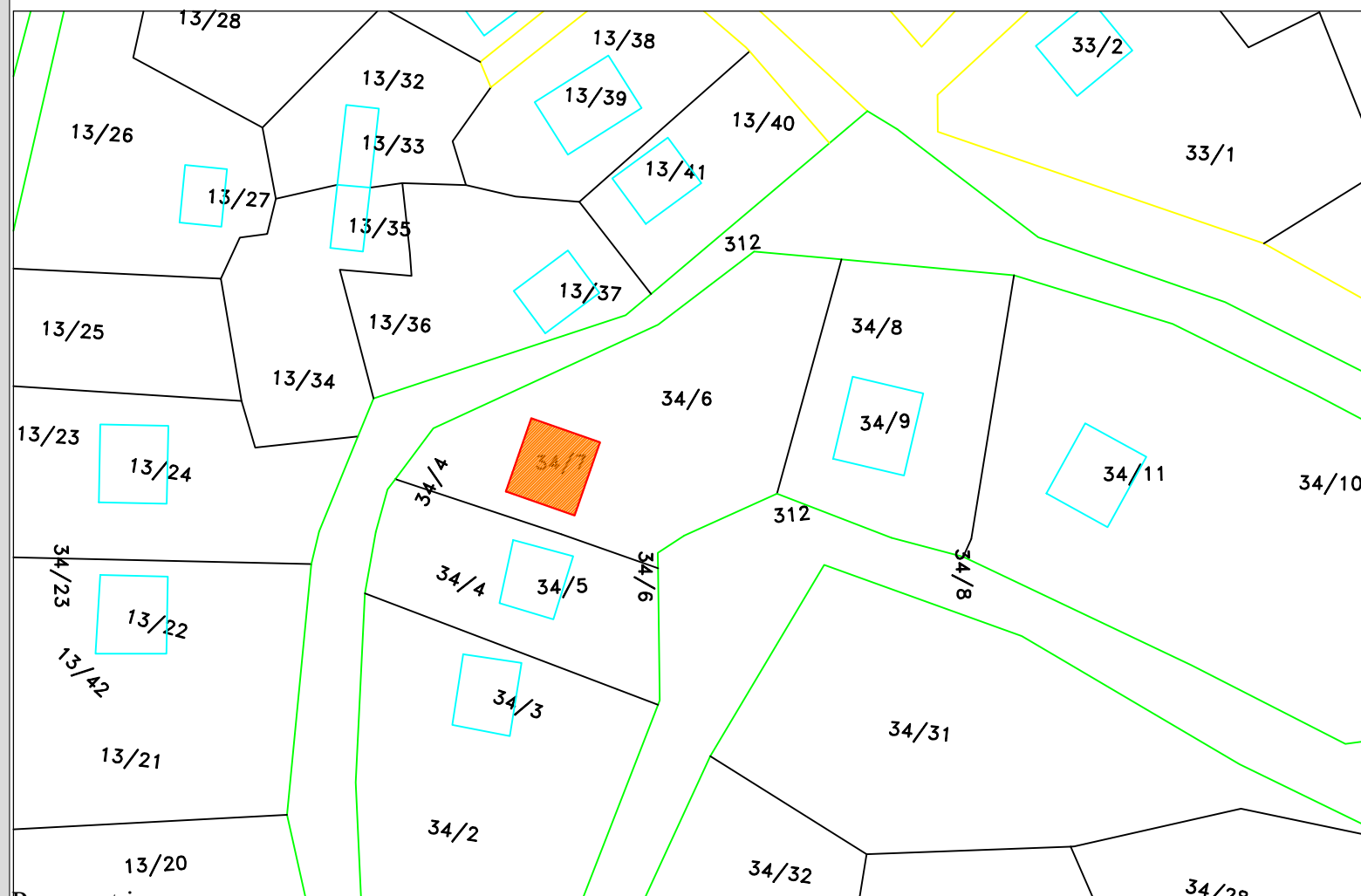

Permasat jane ne cm

BANESA NE ORTOFOTO SH.1:1500



 Konturet e mureve perimetrale te katit pare

Koordinatat e Konturit te baneses
 ne projektionin Nderkombetar-UTM
 Sistemi 2000
 1.X =4532252.37 Y = 416311.54
 2.X =4532249.21 Y = 416319.07
 3.X =4532240.56 Y =416316.17
 4.X =4532242.05 Y =4532242.05

TE DHENA TE PERGJITHSHME

EMERTIMI I PUNIMEVE: "PERFORCIMI /REHABILITIMI I BANESES 1 KAT EKZISTUESE
 KATEGORIA E PERDORIMIT TE TOKES: **TOKE TRUALL**
 LLOJI I STRUKTURES EKZISTUESE: MUR GURI ,ÇATI DRURI ,TJENGULLA VENDI
 ZHVILLUESI PUNIMEVE :**BASHKIA CERRIK**
 PRONARI I NDERTESES EKZISTUESE: PETRIT HALIM MEHALLA
 PERFITUESI: PETRIT MEHALLA
 ADRESA: **Z.K. 1452 PAS.34/7** FSHATI DASAR,NJ.AD. MOLLAS,B.CERRIK
 KODI NEN-NJESISE STRUKTUREORE 4/265
 KODI I PERDORIMIT SIPAS PLANIT (Kategoria Baze e Perdorimit te Tokes) A-Banim

TREGUESIT E ZHVILLIMIT EKZISTUESE

SIPERFAQE E TRUALLIT	250m ²
SIPERFAQJA E BANESES SIPAS ASHK	99 m ²
SIPERFAQJA E BANESES SIPAS FAKTIT	92 m ²
SIPERFAQJA E ÇATISE	108m ²
LARTESIA MESATARE E XOKOLIT	0.50 m
LARTESIA E BANESES	2.75m
LARTESIA E ÇATISE	1.84m
LARTESIA MAX E STRUKTURES NGA TOKA SISTEMUAR	5.09m
TREGUESIT E OBJEKTIT PAS NDERTIMIT TE ÇATISE	
SIPERFAQJA E KATIT PERDHE SIPAS FAKTIT	92 m ²
SIPERFAQJA E ÇATISE	108m ²
LARTESIA MESATARE E XOKOLIT	0.50 m
LARTESIA E BANESES	3.05m
LARTESIA E ÇATISE	1.84m
LARTESIA MAX E STRUKTURES NGA TOKA SISTEMUAR	5.39m

Kryetari
 Bashkise Cerrik

Andis SALLA

Drejtori D.P.T.&ZH.

Ing.Fatmir URUÇI

Perfituesi

Petrit Halim Mehalla

Pozicioni Topografik i Nderteses

Veriu. Pasuria 34/6 Jugu Pasuria; 34/6
 Lindje Pasuria 34/6 Perendimi. Pasuria 34/6

OBJEKTI:
PERFORCIMI/REHABILITIMI I BANESEVE EKZISTUESE

Faza eProjektit:
 Projekt-zbatimi

EMERTESA E FLETES: PLANVENDOSJE

Nr.fletes 2

BASHKIA CERRIK



Drejtori D.P.T.&ZH.

Porositesi: Sektori i Strehimit

Perfituese: Petrit Mehalla

Rruga: "Gjimnazi 1962"

Lagja "Lagja Nr 2" Cerrik

E-Mail: bashkiacerrik@yahoo.com

Hartoi

ing.Fatmir Uruçi

ing.Erdison Baxhia

ing.Arber Disha

tek.Shkelqim Liçi

neshkrimi

Sh.1:500

2023

PLANI I BREZAVE SH.1:100

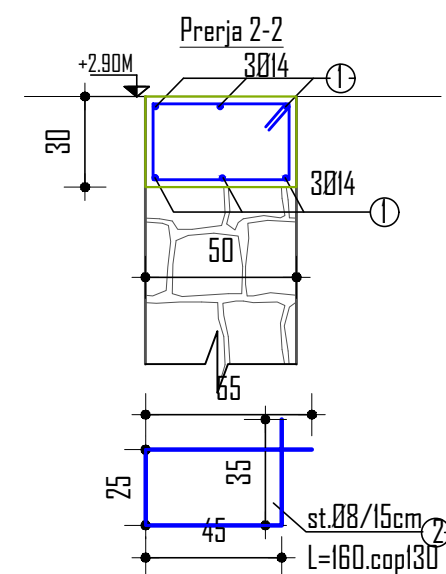
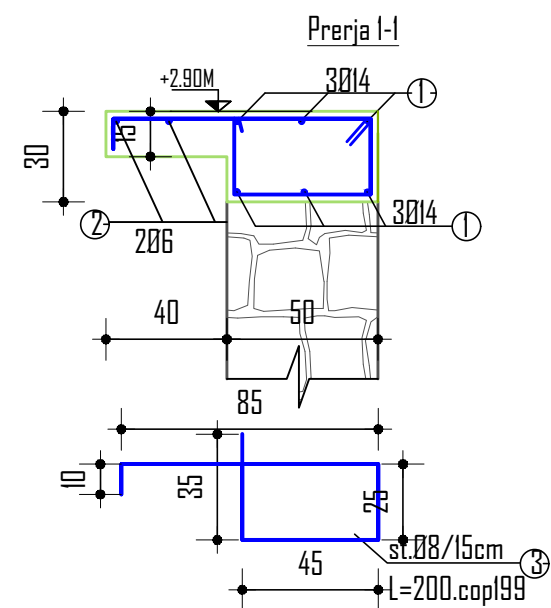
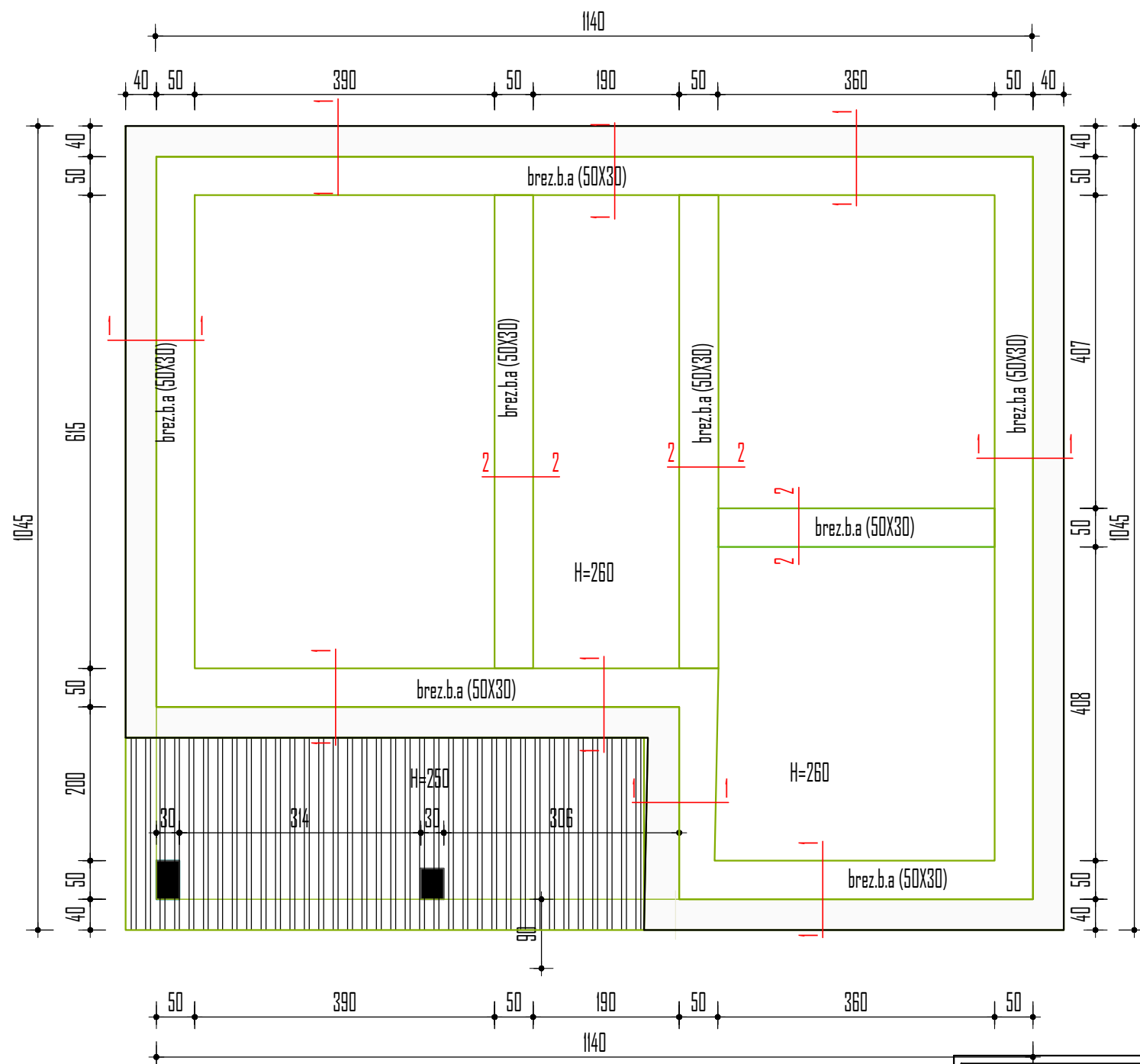

OBJEKTI: PERFORCIMI/REHABILITIMI I BANESAVE EKZISTUESE		<i>Faza eProjektit:</i> <i>Projekt-zbatimi</i>
EMERTESA E FLETES:PLANI I BREZAVE TE NENÇATISE		Nr.fletes 4
BASHKIA CERRIK  Drejtori D.P.T.&ZH.	Porositesi: <i>Sektori i Strehimit</i> Perfituese: <i>Servet Livan Senja</i> Rruga: <i>"Gjimnazi 1962"</i> Lagja <i>'Lagja Nr 2" Cerrik</i> E-Mail: <i>bashkiacerrik@yahoo.com</i>	Hartoi ing.Fatmir Uruçi ing.Erdison Baxhia ing.Arber Disha tek.Shkelqim Liçi
	neshkrimi Sh.1:75 janar 2023	

PRERJA A-A

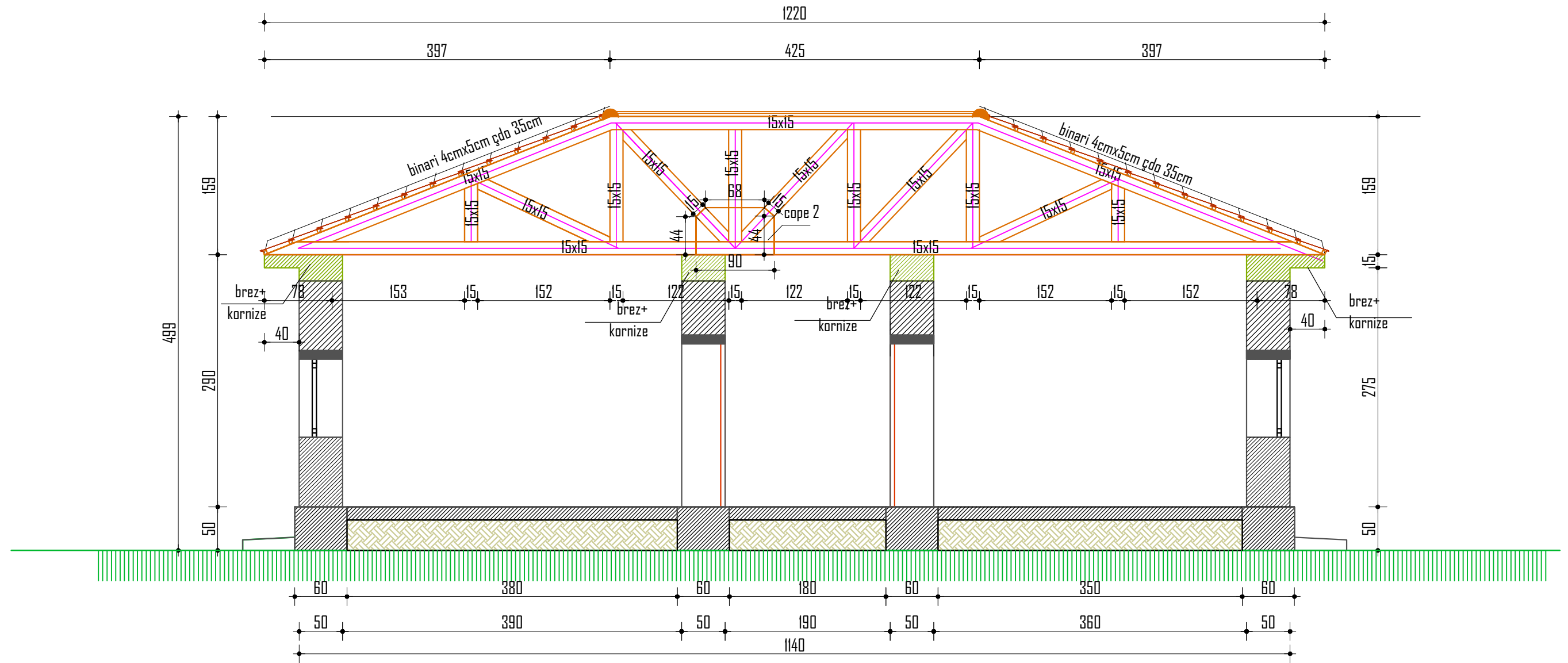

OBJEKTI: PERFORCIMI/REHABILITIMI I BANESAVE EKZISTUESE		<i>Faza eProjektit:</i> <i>Projekt-zbatimi</i>	
EMERTESA E FLETES:PRERJA A-A		Nr.fletes 5	
BASHKIA CERRIK  Drejtori D.P.T.&ZH.	Porositesi: <i>Sektori i Strehimit</i>	Hartoi ing.Fatmir Uruçi ing.Erdison Baxhia ing.Arber Disha tek.Shkelqim Liçi	<i>neshkrimi</i> Sh.1:75 <i>janar 2023</i>
	Perfituese: <i>Servet Livan Senja</i> Rruga: <i>"Gjimnazi 1962"</i> Lagja <i>'Lagja Nr 2" Cerrik</i> E-Mail: <i>bashkiacerrik@yahoo.com</i>		

PLANI I BREZAVE B.A NE +2.75M TE BANESES SE RE SH.1:75

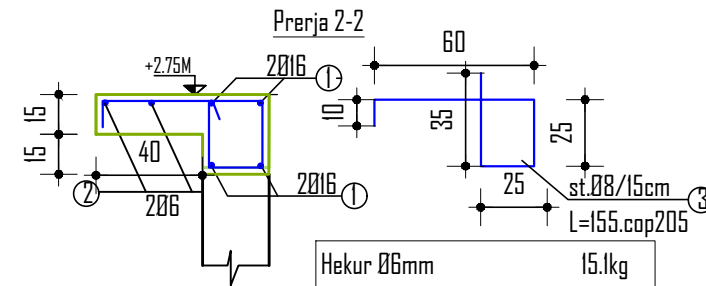
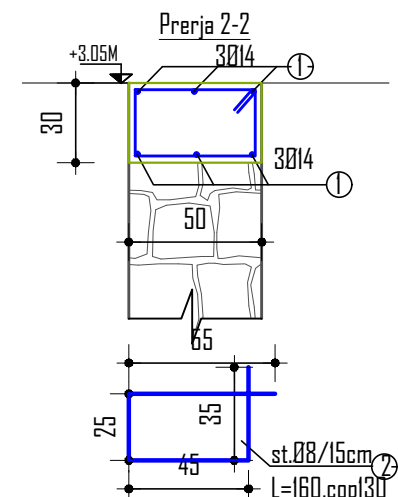
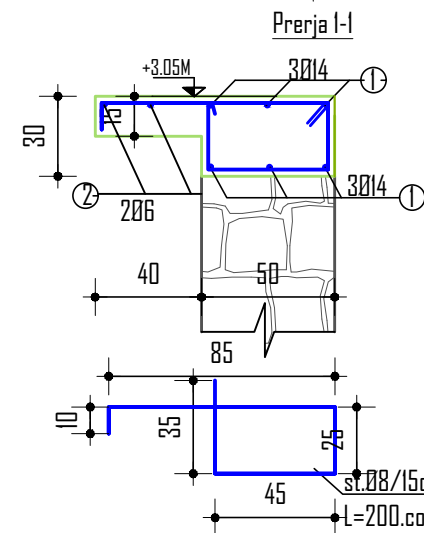
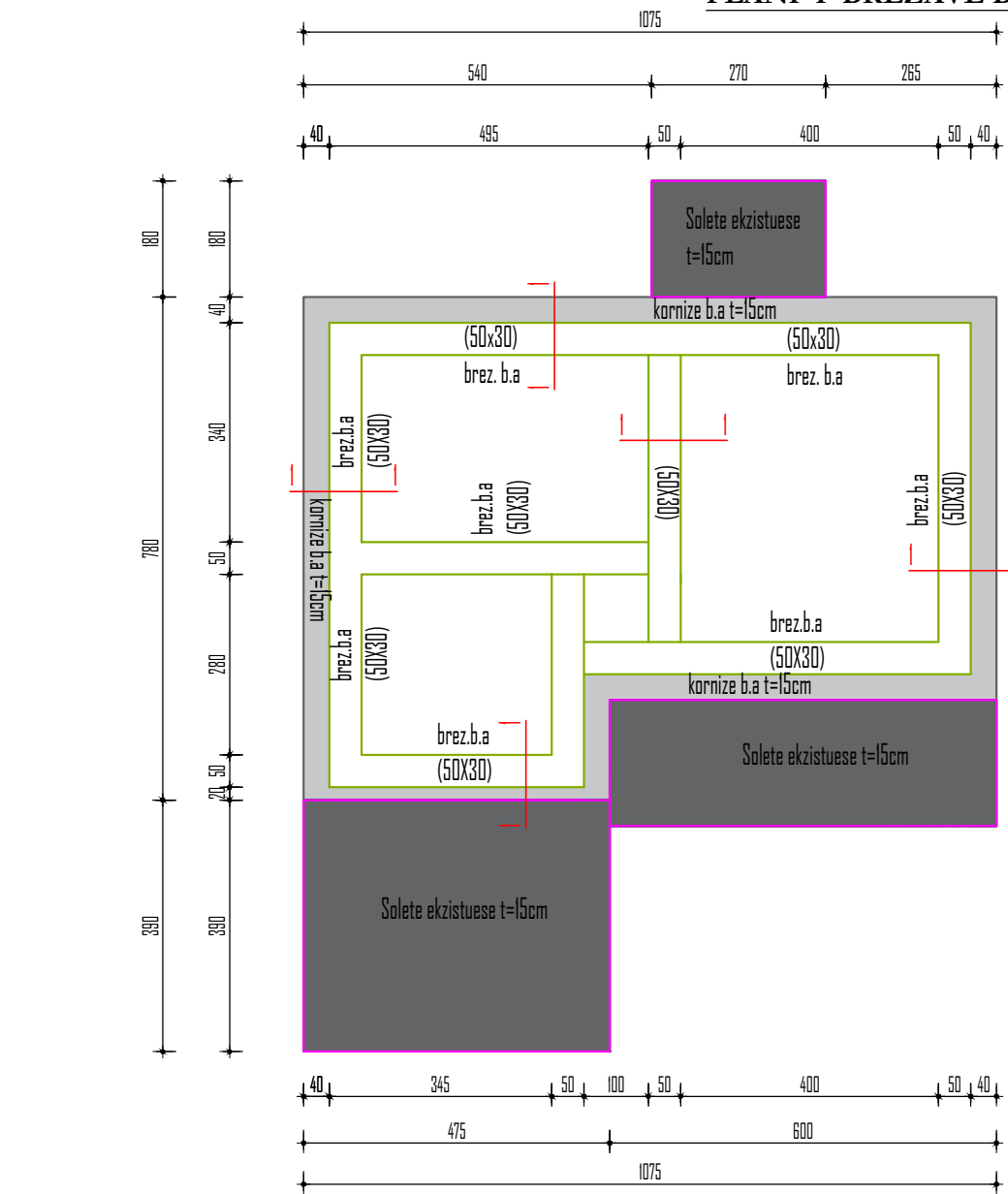

Hekur Ø6mm	15.1kg
Hekur Ø8mm	137.1kg
Hekur Ø16mm	206.54kg
Breza betoni C16/20	2.45m ³
Kornize betoni C16/20	2.1m ³

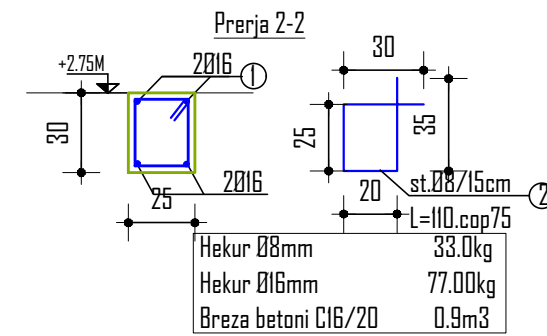

Hekur Ø8mm	33.0kg
Hekur Ø16mm	77.00kg
Breza betoni C16/20	0.9m ³

OBJEKTI: "PERFORCIMI/REHABILITIMI I BANESAVE EKZISTUESE"		Faza eProjektit: Projekt-zbatimi
EMERTESA E FLETES: PLANI I BREZAVE TE NENÇATISE		Nr.fletes 4
BASHKIA CERRIK  Drejtoria/P & ZH	Porositesi: <i>Spektori i Strehimit</i> Perfituese: <i>Bajame Hamit Xibraku</i> Adresa: <i>Rruga "Gjimnazi 1962", Lagja Nr. 2, Cërrik</i> e-mail: <i>bashkiacerrik@yahoo.com</i>	Hartoi ing.Fatmir Uruçi ing. Erdison Baxhja ing.Ar bri Dish tek.Shkelqim Liçi
		nënshkrimi
		Sh.1:75
		janar 2023

PAMJE NGA LART E ÇATISE SH.1:100

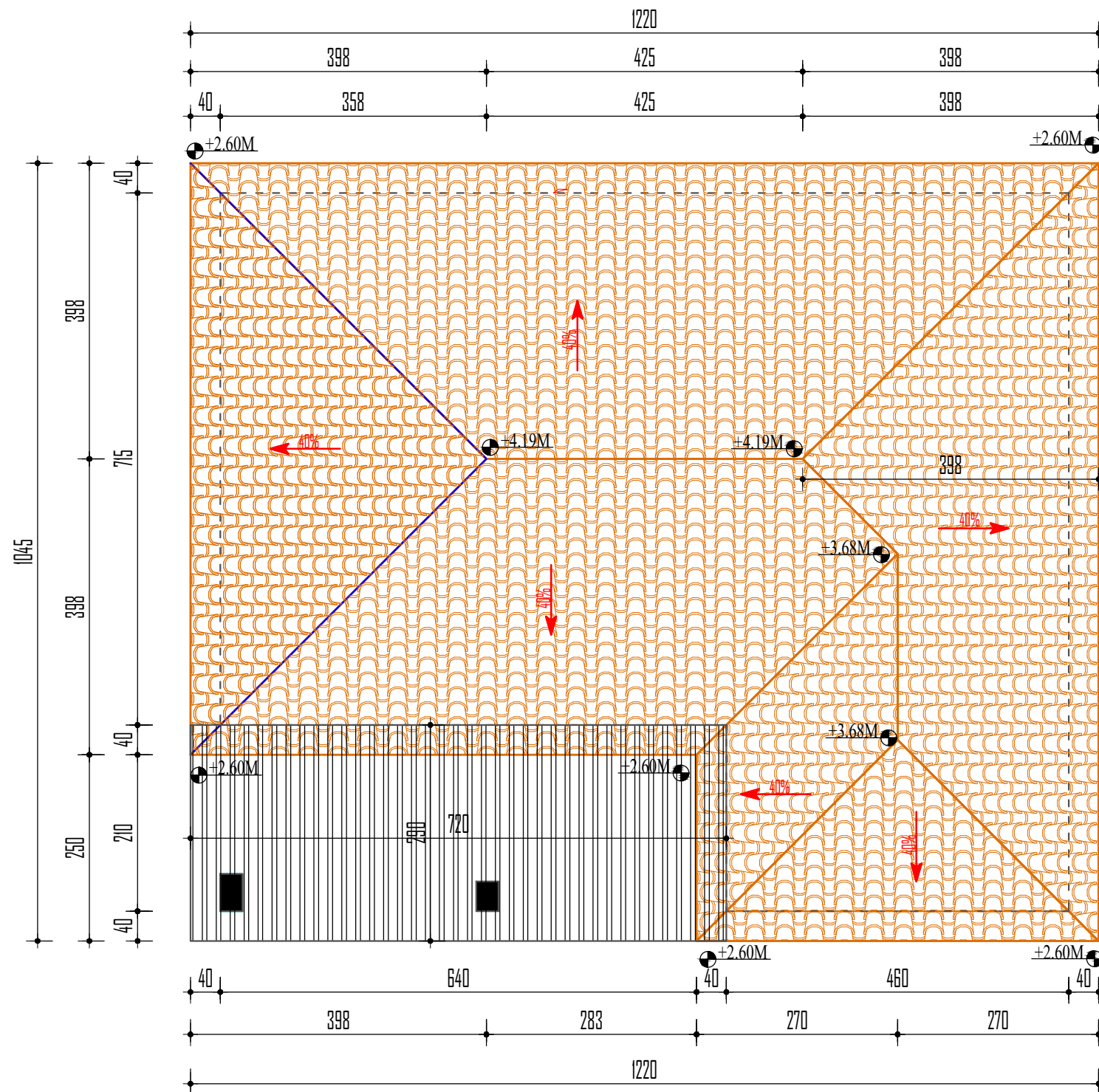

OBJEKTI: PERFORCIMI/REHABILITIMI I BANESAVE EKZISTUESE			<i>Faza eProjektit:</i> <i>Projekt-zbatimi</i>
EMERTESA E FLETES:PLANI ÇATISE			Nr.fletes 6
BASHKIA CERRIK  Drejtori D.P.T.&ZH.	Porositesi: <i>Spektori i Strehimit</i>	Hartoi	<i>neshkrimi</i>
	Perfituese: <i>Servet Livan Senja</i> Rruga: <i>"Gjimnazi 1962"</i> Lagja <i>'Lagja Nr 2" Cerrik</i> E-Mail: <i>bashkiacerrik@yahoo.com</i>	ing.Fatmir Uruçi ing.Erdison Baxhia ing.Arber Disha tek.Shkelqim Liçi	
			<i>janar 2023</i>

PLANVENDOSJE PER PUNIME PERFORCIM/REHABILITIMI I BANESES 1 KAT
 ME VENDODHJE:DRAGOT,NJ.AD. MOLLAS -BASHKIA CERRIK.ZHVILLUESI:B.CERRIK
 PRONARI I NDERTESES SERVET LIVAN SENJA .SH.1:500

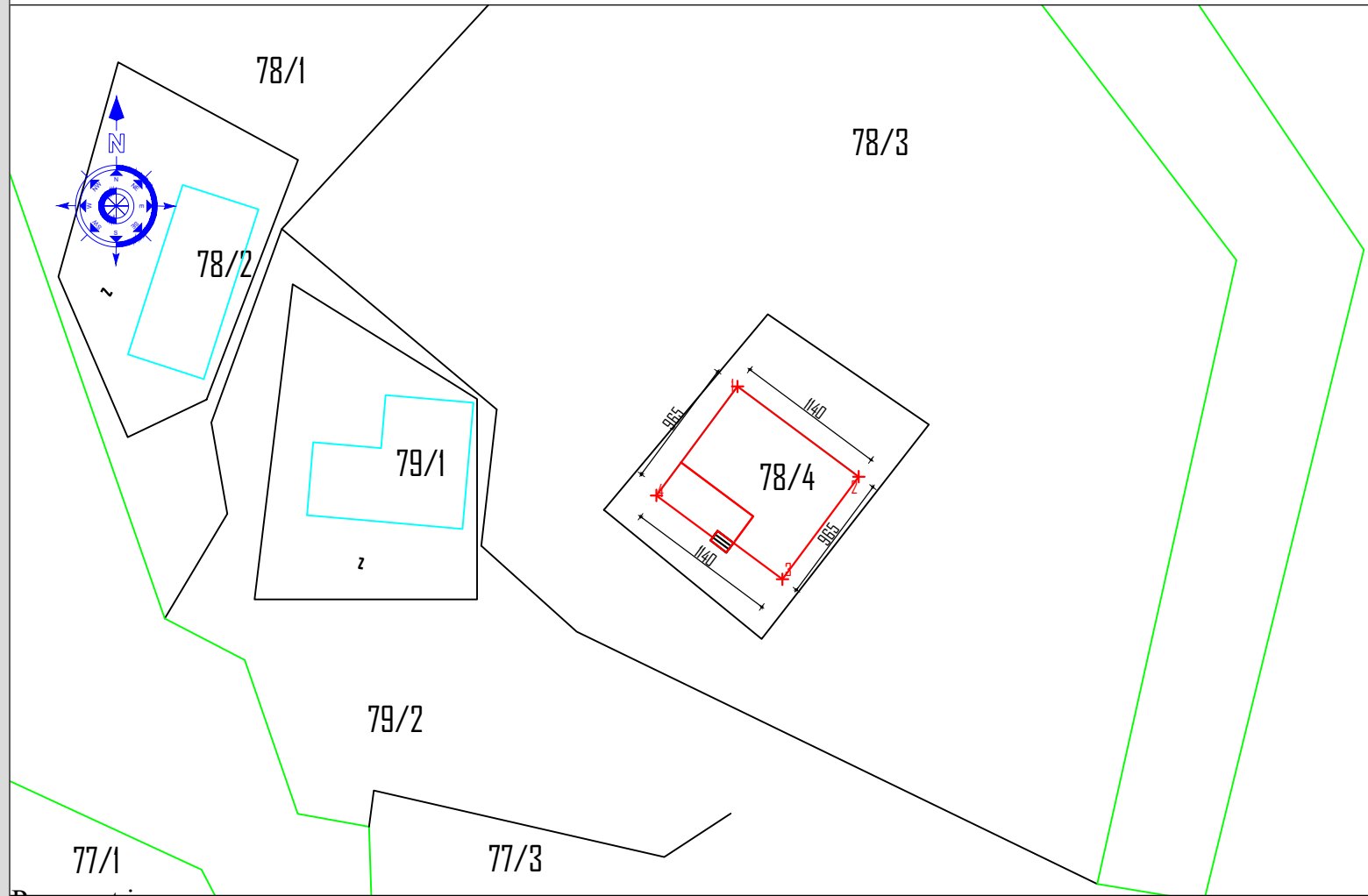

Permasat jane ne cm

BANESA NE ORTOFOTO SH.1:2000



 Çatija me sipërfaqe 110m2 ne plan

 Konturet e mureve perimetrale te katit pare

Koordinatat e Konturit te baneses
 ne projektionin Nderkombetar-UTM
 Sistemi 2000

1.X =4528070.22 Y = 416455.63
 2.X =4528068.88 Y = 416462.61
 3.X =4528060.08 Y =416461.39
 4.X =4528061.13 Y =416454.68

Kryetari
 Bashkise Cerrik

Andis SALLA

Drejtori D.P.T.&ZH.

Ing.Fatmir URUÇI

Perfituesi

Servet Livan Senja

TE DHENA TE PERGJITHSHME

EMERTIMI I PUNIMEVE:"PERFORCIMI /REHABILITIMI I BANESES 1 KAT EKZISTUESE
 KATEGORIA E PERDORIMIT TE TOKES: **TOKE TRUALL**
 LLOJI I STRUKTURES EKZISTUESE:MUR GURI ,ÇATI DRURI ,TJENGULLA VENDI
 ZHVILLUESII PUNIMEVE :**BASHKIA CERRIK**
 PRONARI I NDERTESES EKZISTUESE: SERVET LIVAN SENJA
 PERFITUESI:SERVET LIVAN SENJA
 ADRESA:**Z.K. 1530 PAS.78/4** FSHATI DRAGOT,NJ.AD. MLLAS,B.CERRIK
 KODI NEN-NJESISE STRUKTUREORE 4/404
 KODI I PERDORIMIT SIPAS PLANIT(Kategoria Baze e Perdorimit te Tokes) A-Banim

TREGUESIT E ZHVILLIMIT EKZISTUESE

SIPERFAQE E TRUALLIT	250m ²
SIPERFAQJA E BANESES 1 KAT	110 m ²
SIPERFAQJA E ÇATISE	110 m ²
SIPERFAQJA E TARACES	20 m ²
LARTESIA MESATARE E XOKOLIT	0.50 m
LARTESIA E BANESES	2.60m
LARTESIA E ÇATISE	1.59m
LARTESIA MAX E STRUKTURES NGA TOKA SISTEMUAR	4.69m
TREGUESIT E OBJEKTIT PAS NDERTIMIT TE ÇATISE	
SIPERFAQJA E BANESES 1 KAT	110 m ²
SIPERFAQJA E ÇATISE	110 m ²
SIPERFAQJA E TARACES	20 m ²
LARTESIA MESATARE E XOKOLIT	0.50 m
LARTESIA E BANESES	2.90m
LARTESIA E ÇATISE	1.59m
LARTESIA MAX E STRUKTURES NGA TOKA SISTEMUAR	4.99m

Pozicioni Topografik i Nderteses

Veriu. Pasuria 78/4 Jugu Pasuria;78/4
 Lindje Pasuria 78/4 Perendimi. Pasuria78/4

OBJEKTI:
PERFORCIMI/REHABILITIMI I BANESEVE EKZISTUESE

Faza eProjektit:
 Projekt-zbatimi

EMERTESA E FLETES:PLANVENDOSJE

Nr.fletes 2

BASHKIA CERRIK



Drejtori D.P.T.&ZH.

Porositesi: *Spektori i Strehimit*

Perfituese: *Servet Livan Senja*

Rruga: *"Gjimnazi 1962"*

Lagja *'Lagja Nr 2" Cerrik*

E-Mail: *bashkiacerrik@yahoo.com*

Hartoi

ing.Fatmir Uruçi

ing.Erdison Baxhia

ing.Arber Disha

tek.Shkelqim Liçi

neshkrimi

Sh.1:75

janar 2023

OBJEKTI:

"PERFORCIMI /REHABILITIMI I BANESES 1 KAT

ANDRESA:

2717 PASURIA 163/22/13

FSHATI MOLLAS -NJ.AD.MOLLAS -B CERRIK

PERFITUES:VELI QANI KERKAPI

POROSITI:SEKTORI E STREHIMIT

OBJEKTI: PERFORCIMI/REHABILITIMI I BANESAVE EKZISTUESE			<i>Faza eProjektit:</i> <i>Projekt-zbatimi</i>
EMERTESA E FLETES:KOPERTINA			Nr.fletes 1
 Drejtori D.P.T.&ZH.	<i>Porositesi: Sektori i Strehimit</i>	Hartoi	<i>neshkrimi</i>
	<i>Perfituese: Veli Kerkapi</i>	ing.Fatmir Uruçi	
	<i>Rruga: "Gjimnazi 1962"</i>	ing.Erdison Baxhia	
	<i>Lagja 'Lagja Nr 2" Cerrik</i> <i>E-Mail: bashkiacerrik@yahoo.com</i>	ing.Arber Disha	
		tek.Shkelqim Liçi	<i>janar 2023</i>

PLANIMETRIA E BANESES SH.1:75







FOTO E GJENDJES EKZISTUESE

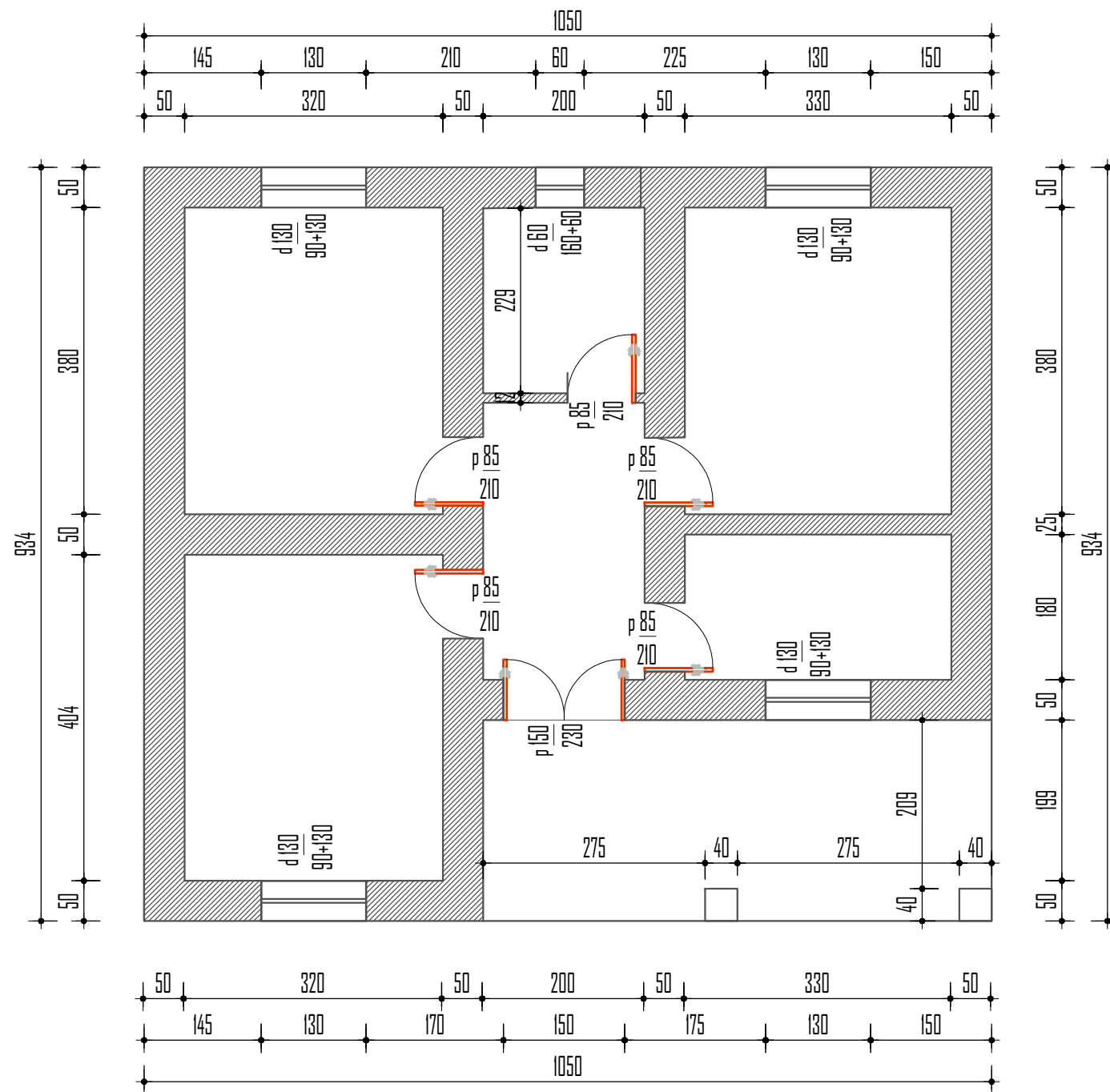

OBJEKTI: PERFORCIMI/REHABILITIMI I BANESAVE EKZISTUESE		<i>Faza eProjektit:</i> <i>Projekt-zbatimi</i>	
EMERTESA E FLETES:PLANI I I BANESES EKZISTUESE		Nr.fletes 3	
BASHKIA CERRIK  Drejtori D.P.T.&ZH.	<i>Porositesi: Sektori i Strehimit</i>	Hartoi ing.Fatmir Uruçi ing.Erdison Baxhia ing.Arber Disha tek.Shkelqim Liçi	<i>neshkrimi</i>
	Perfituese: Veli Kerkapi Rruga: "Gjimnazi 1962" Lagja 'Lagja Nr 2" Cerrik E-Mail: bashkiacerrik@yahoo.com		

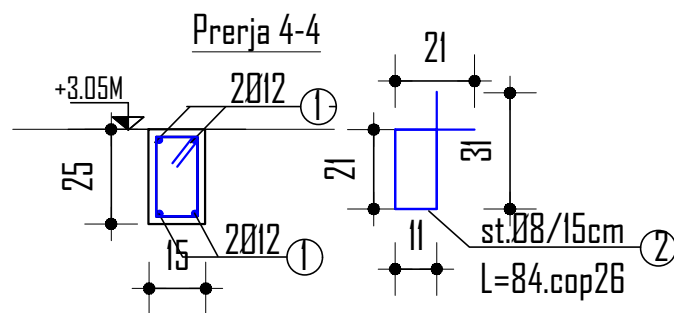
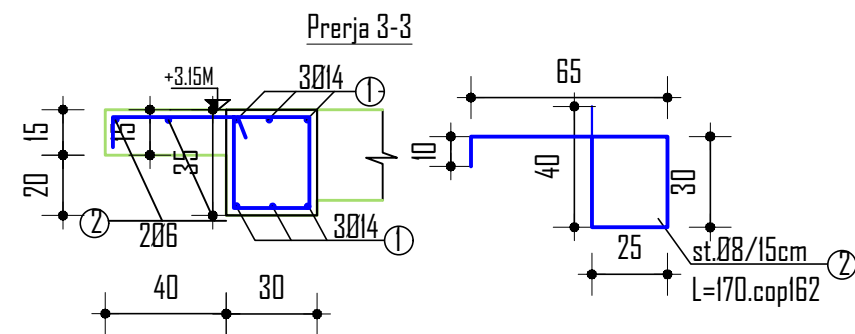
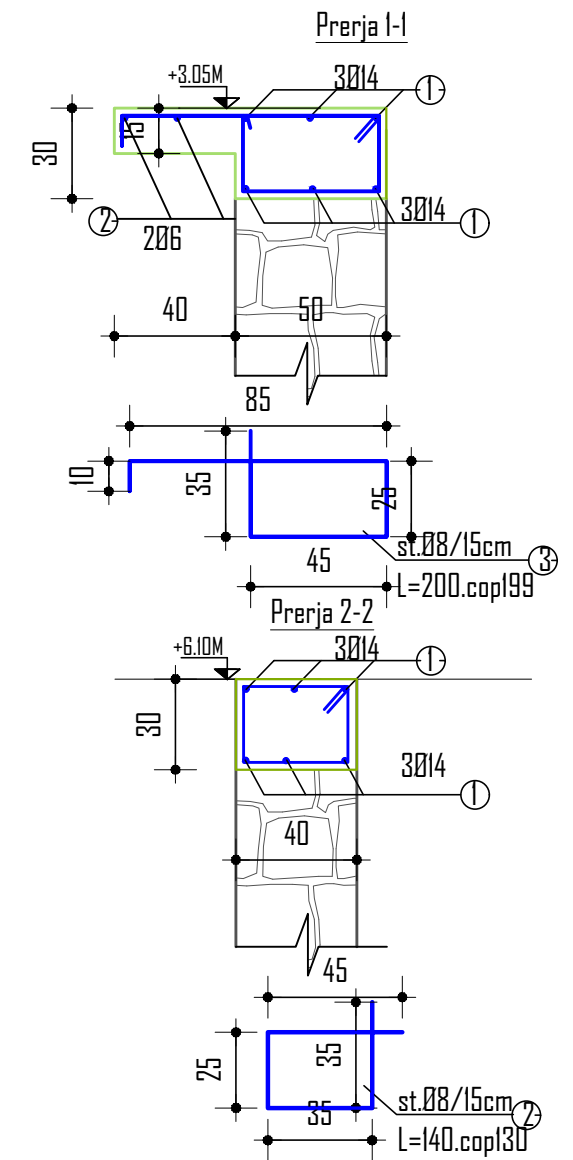
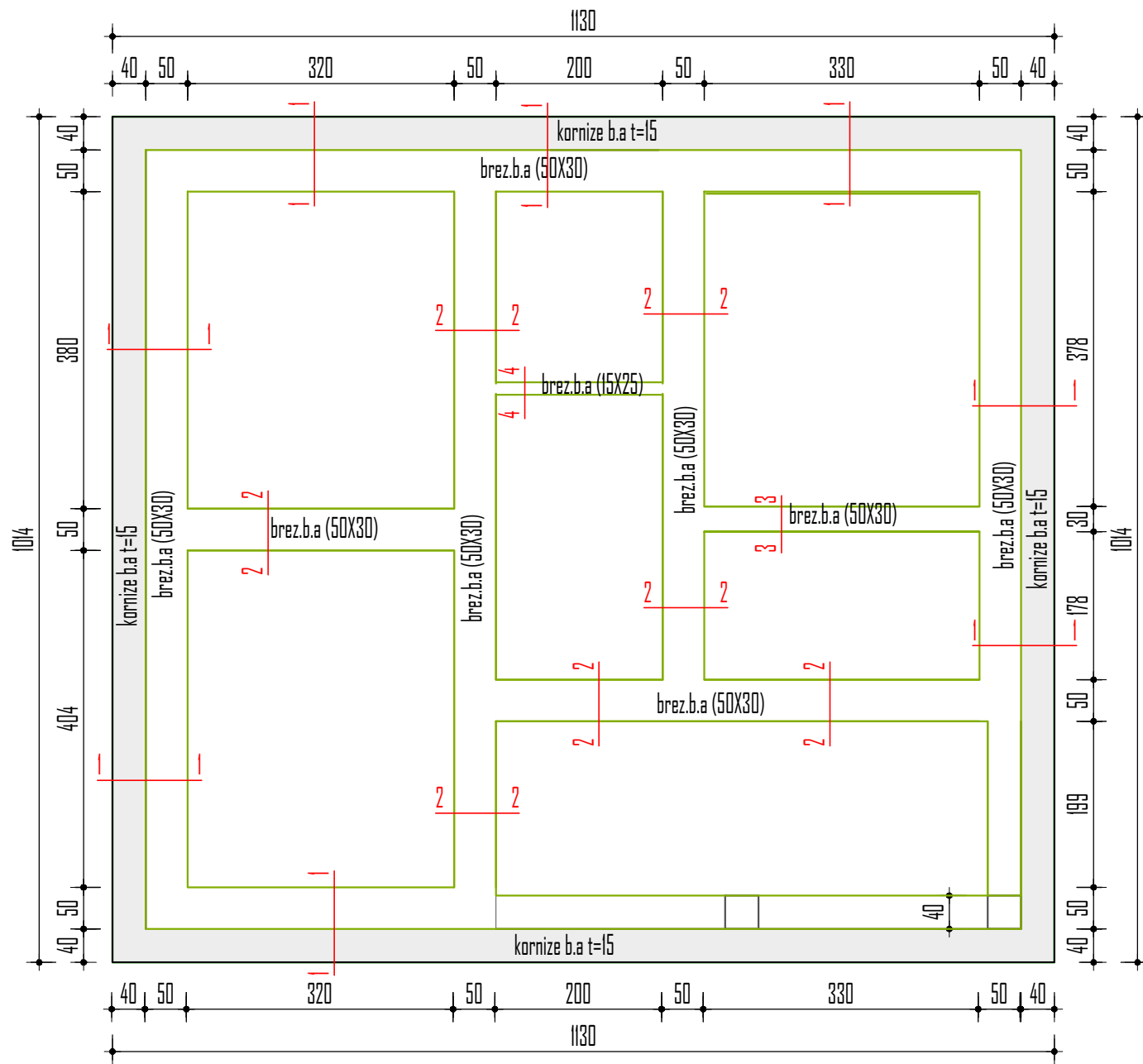
PLANI I BREZAVE NENÇATI SH.1:100



OBJEKTI: PERFORCIMI/REHABILITIMI I BANESAVE EKZISTUESE		Faza eProjektit: Projekt-zbatimi
EMERTESA E FLETES:PLANI I BREZAVE NEN ÇATI		Nr.fletes 4
BASHKIA CERRIK  Drejtori D.P.T.&ZH.	Porositesi: <i>Spektori i Strehimit</i> Perfituese: <i>Veli Kerkapi</i> Rruga: <i>"Gjimnazi 1962"</i> Lagja <i>'Lagja Nr 2' Cerrik</i> E-Mail: <i>bashkiacerrik@yahoo.com</i>	Hartoi ing.Fatmir Uruçi ing.Erdison Baxhia ing.Arber Disha tek.Shkelqim Liçi <i>neshkrimi</i>
		Sh.1:75
		janar 2023

PAMJA E ÇATISE NGA LART SH.1:75

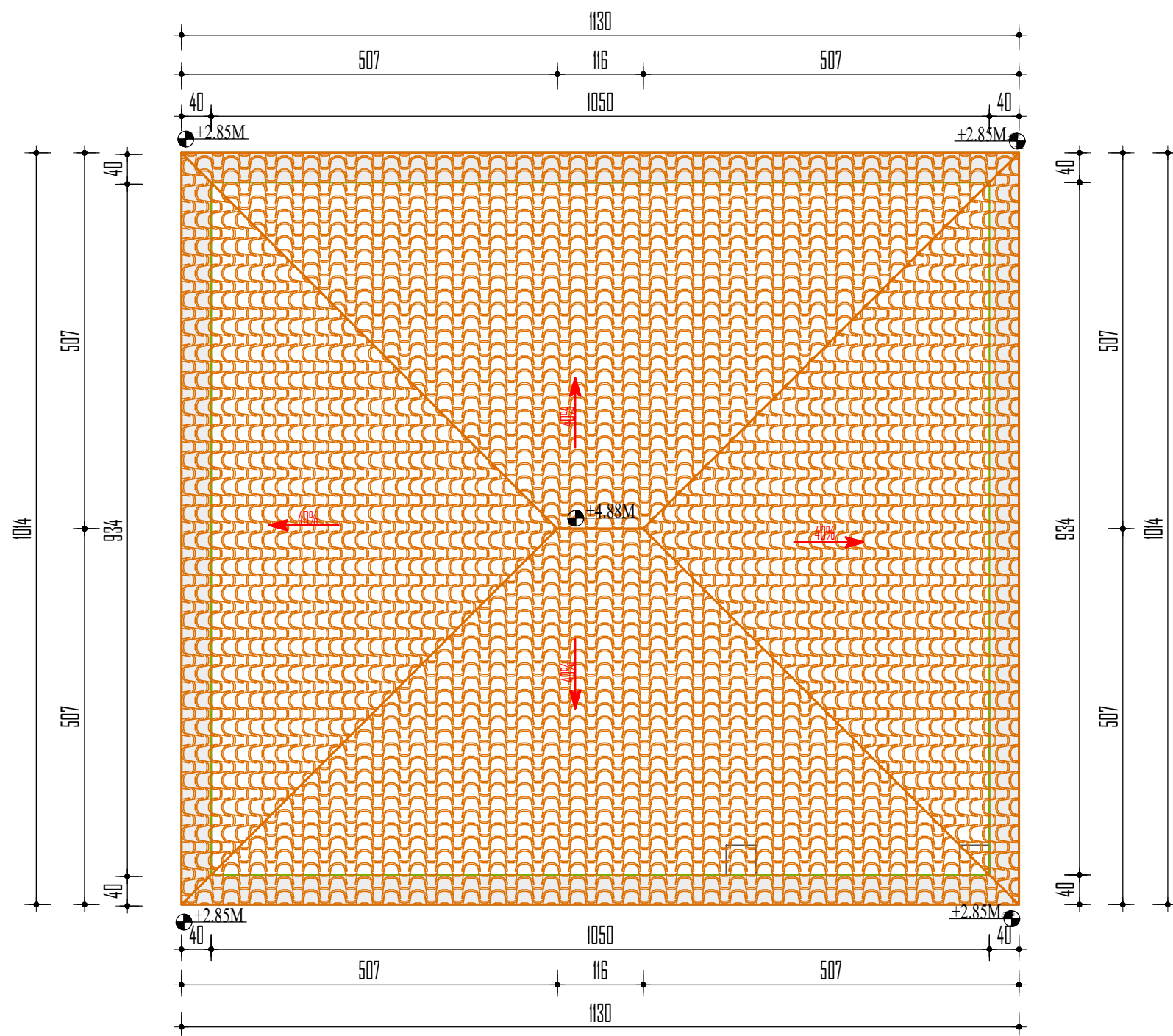

OBJEKTI: PERFORCIMI/REHABILITIMI I BANESAVE EKZISTUESE			<i>Faza eProjektit:</i> <i>Projekt-zbatimi</i>
EMERTESA E FLETES:PAMJE E ÇATISE NGA LART			Nr.fletes 6
BASHKIA CERRIK  Drejtori D.P.T.&ZH.	Porositesi: <i>Sektori i Strehimit</i> Perfituese: <i>Veli Kerkapi</i> Rruga: <i>"Gjimnazi 1962"</i> Lagja <i>'Lagja Nr 2" Cerrik</i> E-Mail: bashkiacerrik@yahoo.com	Hartoi ing.Fatmir Uruçi ing.Erdison Baxhia ing.Arber Disha tek.Shkelqim Liçi	<i>neshkrimi</i> Sh.1:75 <i>janar 2023</i>

PLANVENDOSJE PER PUNIME PERFORCIM/REHABILITIMI I BANESES 1 KAT
ME VENDODHJE:MOLLAS,NJ.AD. MOLLAS -BASHKIA CERRIK.ZHVILLUESI:B.CERRIK

PERFITUES:SHERIF RAMADAN BULLARI .SH.1:1000

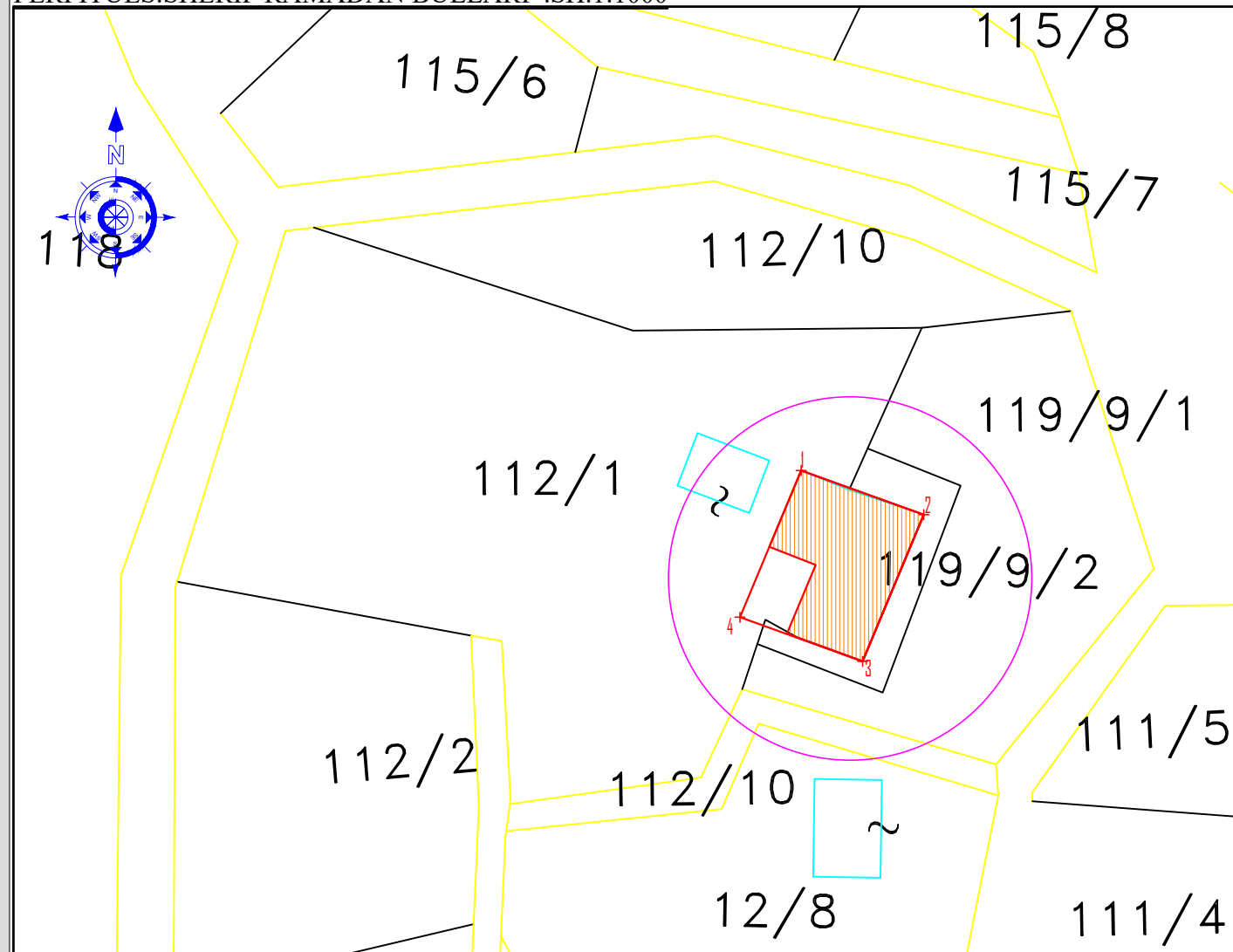

BANESA NE ORTOFOT .SH.1:1500



Kryetari
Bashkise Cerrik

Andis SALLA

Drejtori D.P.T.&ZH.

Ing.Fatmir URUÇI

Perfituesi

Sherif Bullari

Shenim.
Gjysma e baneses eshte e rrenuar
1.Muret jane shembur po ashtu e çatija,ne funksion
jane dy dhoma dhe nje wc(edhe ketu tavani eshte i
rene,catija eshte e deformuar)
2.Ndertesat duhet prishur dhe ne vend te saj te
ndertothen
nje dhome gjumi,nje ambient gatimi ,ngrenie e ndenjeje
si dhe nje wc

Koordinatat e Konturit te baneses
ne projektionin Nderkombetar-UTM
Sistemi 2000
1.X =4528656.72 Y =414551.79
2.X =4528655.78 Y =414560.88
3.X =4528645.43 Y =414559.92
4.X = 4528646.24 Y =414550.69

TE DHENA TE PERGJITHSHME

EMERTIMI I PUNIMEVE:"PERFORCIMI /REHABILITIMI I BANESES 1 KAT EKZISTUESE
KATEGORIA E PERDORIMIT TE TOKES: **TOKE TRUALL**
LLOJI I STRUKTURES EKZISTUESE:MUR GURI ,ÇATI DRURI ,TJENGULLA VENDI
ZHVILLUESII PUNIMEVE :**BASHKIA CERRIK**
PRONARI I NDERTESES EKZISTUESE: SHERIF RAMADAN BULLARI
PERFITUESI:SHERIF RAMADAN BULLARI
ADRESA:**Z.K. 2459PAS.119/9/2** FSHATI LINAS,NJ.AD. MOLLAS,**B.CERRIK**
KODI NEN-NJESISE STRUKTURORE
KODI I PERDORIMIT SIPAS PLANIT(Kategoria Baze e Perdorimit te Tokes) A-Banim

TREGUESIT E ZHVILLIMIT EKZISTUESE	
SIPERFAQE E TRUALLIT	250m ²
SIPERFAQJA E BANESES SIPAS ASHK	126 m ²
SIPERFAQJA E BANESES SIPAS FAKTIT	107.3 m ²
SIPERFAQJA E ÇATISE	127.2m ²
LARTESIA MESATARE E XOKOLIT	0.10 m
LARTESIA E BANESES	2.70m
LARTESIA E ÇATISE	1.47m
LARTESIA MAX E STRUKTURES NGA TOKA SISTEMUAR	4.27m
TREGUESIT E OBJEKTIT PAS NDERTIMIT TE ÇATISE	
SIPERFAQJA E KATIT PERDHE SIPAS FAKTIT	61.6 m ²
SIPERFAQJA E ÇATISE	75m ²
LARTESIA MESATARE E XOKOLIT	0.50 m
LARTESIA E BANESES	3.05m
LARTESIA E ÇATISE	1.61m
LARTESIA MAX E STRUKTURES NGA TOKA SISTEMUAR	5.16m

Pozicioni Topografik i Nderteses

Veriu. Pasuria 119/9/1 Jugu Pasuria;119/9/1
Lindje Pasuria 119/9/1 Perendimi. Pasuria 119/9/1

OBJEKTI: PERFORCIMI/REHABILITIMI I BANESEVE EKZISTUESE
(PRISHJE DHE NDERTIMI I BANESES 1 KAT)

Faza eProjektit:
Projekt-zbatimi

EMERTESA E FLETES:PLANVENDOSJE

Nr.fletes 2

BASHKIA CERRIK



Drejtori D.P.T.&ZH.

Porositesi: Sektori i Strehimit

Perfituese: Sherif Bullari

Rruga: "Gjimnazi 1962"

Lagja "Lagja Nr 2" Cerrik

E-Mail: bashkiacerrik@yahoo.com

Hartoi

ing.Fatmir Uruçi

ing.Erdison Baxhia

ing.Arber Disha

tek.Shkelqim Liçi

neshkrimi

Sh.1:75

janar 2023

OBJEKTI:

"PËRFORCIMI /REHABILITIMI I BANESËS 1 KAT

ADRESA: 1774, PASURIA 202/24/1 FSHATI GJYRALE - NJ. AD. GOSTIM -B. CERRIK

PËRFITUES; SHKELQIM RIZA KICKA

POROSITI: SEKTORI E STREHIMIT

OBJEKTI: PËRFORCIMI/REHABILITIMI I BANESAVE EKZISTUESE		<i>Faza eProjektit:</i> <i>Projekt-zbatimi</i>	
EMËRTESA E FLETËS: KOPERTINA		Nr. fletës 1	
 Drejtori D. P. ZH. T.	Porositësi: <i>Spektori i Strehimit</i>	Hartoi	<i>nëshkrimi</i>
	Përfituesi: <i>Shkelqim Riza Kicka</i> Rruga: <i>"Gjimnazi 1962"</i> Lagja <i>'Lagja Nr 2" Cerrik</i> E-Mail: <i>bashkiacerrik@yahoo.com</i>	ing. Fatmir Uruçi ing. Erdison Baxhija ing. Arbri Disha tek. Shkelqim Liçi	Sh.1:75 <i>Gusht 2023</i>

OBJEKTI:

"PERFORCIMI /REHABILITIMI I BANESES 1 KAT"

ANDRESA:

Z.K 3422, PASURIA ME NR. 158/36

FSHATI SHTERMEN - NJ.AD. GOSTIME - B. CËRRIK

PERFITUES: VALENTINA VIKTOR KUMJA

POROSITI: SEKTORI I STREHIMIT

OBJEKTI: "PËRFORCIMI/REHABILITIMI I BANESAVE EKZISTUESE"		<i>Faza eProjektit:</i> <i>Projekt-zbatimi</i>	
EMËRTESA E FLETËS: KOPERTINA		Nr.fletes 1	
 BASHKIA CERRIK Drejtoria/P & ZH	Porositësi: <i>Spektori i Strehimit</i>	Hartoi:	<i>nënshkrimi</i>
	Përfituese: <i>Valentina Viktor Kumja</i>	ing. Fatmir Uruçi	Sh.-----
	Adresa: <i>Rruga "Gjimnazi 1962", Lagja Nr. 2, Cërrik</i>	ing. Erdison Baxhja	
	<i>e-mail: bashkiacerrik@yahoo.com</i>	ing. Arbër Disha	
		tek. Shkëlqim Liçi	<i>janar 2023</i>

OBJEKTI:

"PERFORCIMI /REHABILITIMI I BANESES 1 KAT

ANDRESA:

2717 PASURIA 152/2/2

FSHATI MOLLAS -NJ.AD.MOLLAS -B CERRIK

PERFITUES:XHEVIT ZYKO MEHALLA

POROSITI:SEKTORI E STREHIMIT

OBJEKTI: PERFORCIMI/REHABILITIMI I BANESAVE EKZISTUESE			<i>Faza eProjektit:</i> Projekt-zbatimi		
EMERTESA E FLETES:KOPERTINA			Nr.fletes 1		
 Drejtori D.P.T.&ZH.	Porositesi: <i>Sektori i Strehimit</i>	Hartoi	<i>neshkrimi</i>		
	Perfituese: <i>Xhevit Zuko Mehalla</i>	ing.Fatmir Uruçi		Sh.	
	Rruga: <i>"Gjimnazi 1962"</i>	ing.Erdison Baxhia			janar 2023
	Lagja <i>'Lagja Nr 2" Cerrik</i> E-Mail: bashkiacerrik@yahoo.com	ing.Arber Disha			
		tek.Shkelqim Liçi			

OBJEKTI:

"PERFORCIMI /REHABILITIMI I BANESES 1 KAT

ANDRESA:

2717 PASURIA 172/4/2

FSHATI MOLLAS -NJ.AD.MOLLAS -B CERRIK

PERFITUES:MYZAFER AVNI GJINI

POROSITI:SEKTORI E STREHIMIT

OBJEKTI: PERFORCIMI/REHABILITIMI I BANESAVE EKZISTUESE			<i>Faza eProjektit:</i> <i>Projekt-zbatimi</i>
EMERTESA E FLETES:KOPERTINA			Nr.fletes 1
BASHKIA CERRIK  Drejtori D.P.T.&ZH.	<i>Porositesi: Sektori i Strehimit</i> <i>Perfituese:Myzafer Avni Gjini</i> <i>Rruga:"Gjimnazi 1962"</i> <i>Lagja 'Lagja Nr 2" Cerrik</i> <i>E-Mail:bashkiacerrik@yahoo.com</i>	Hartoi ing.Fatmir Uruçi ing.Erdison Baxhia ing.Arber Disha tek.Shkelqim Liçi	<i>neshkrimi</i> <i>janar 2023</i>
			Sh.1:75

OBJEKTI:

"PERFORCIMI /REHABILITIMI I BANESES 1 KAT

ANDRESA:

1452 PASURIA 67/26

FSHATI DASAR -NJ.AD.MOLLAS -B CERRIK

PERFITUES:KUJTIM ZENUN GJINI

POROSITI:SEKTORI E STREHIMIT

OBJEKTI: PERFORCIMI/REHABILITIMI I BANESAVE EKZISTUESE			<i>Faza eProjektit:</i> <i>Projekt-zbatimi</i>
EMERTESA E FLETES:KOPERTINA			Nr.fletes 1
BASHKIA CERRIK  Drejtori D.P.T.&ZH.	<i>Porositesi: Sektori i Strehimit</i> <i>Perfituese:Kujtim Zenun Gjini</i> <i>Rruga:"Gjimnazi 1962"</i> <i>Lagja 'Lagja Nr 2" Cerrik</i> <i>E-Mail:bashkiacerrik@yahoo.com</i>	Hartoi ing.Fatmir Uruçi ing.Erdison Baxhia ing.Arber Disha tek.Shkelqim Liçi	<i>neshkrimi</i> <i>janar 2023</i>
			Sh.1:75

OBJEKTI:

"PËRFORCIMI /REHABILITIMI I BANESËS 1 KAT

ADRESA: 2559, PASURIA 152/23/1 FSHATI MALASEJ - NJ. AD. GOSTIM -B. CERRIK

PËRFITUES; ALTI JEMIN AHMATI

POROSITI: SEKTORI E STREHIMIT

OBJEKTI: PËRFORCIMI/REHABILITIMI I BANESAVE EKZISTUESE		<i>Faza eProjektit:</i> <i>Projekt-zbatimi</i>	
EMËRTESA E FLETËS: KOPERTINA		Nr. fletës 1	
 Drejtori D. P. ZH. T.	Porositësi: <i>Spektori i Strehimit</i>	Hartoi	<i>nëshkrimi</i>
	Përfituesi: <i>Alti Jemin Ahmati</i>	ing. Fatmir Uruçi	
	Rruga: <i>"Gjimnazi 1962"</i>	ing. Erdison Baxhija	
	Lagja <i>'Lagja Nr 2' Cerrik</i>	ing. Arbri Disha	
E-Mail: bashkiacerrik@yahoo.com		tek. Shkelqim Liçi	
			<i>Gusht 2023</i>

OBJEKTI:

"PERFORCIMI /REHABILITIMI I BANESES 1 KAT"

ANDRESA:

Z.K 3422, PASURIA ME NR. 183/8/1

FSHATI GOSTIME - NJ.AD. GOSTIME - B. CËRRIK

PERFITUES: BAJRAM DILAVER TOPOLLARI

POROSITI: SEKTORI I STREHIMIT

OBJEKTI: "PËRFORCIMI/REHABILITIMI I BANESAVE EKZISTUESE"			<i>Faza eProjektit:</i> <i>Projekt-zbatimi</i>
EMËRTEZA E FLETËS: KOPERTINA			Nr.fletes 1
BASHKIA CERRIK  Drejtoria/P & ZH	<i>Porositësi: Sektori i Strehimit</i> <i>Përfituese: Bajram Dilaver Topollari</i> <i>Adresa: Rruga "Gjimnazi 1962", Lagja Nr. 2, Cërrik</i> <i>e-mail: bashkiacerrik@yahoo.com</i>	<i>Hartoi:</i> ing. Fatmir Uruçi ing. Erdison Baxhja ing. Arbër Disha tek. Shkëlqim Liçi	<i>nënshtkrimi</i> Sh.----- <i>janar 2023</i>

OBJEKTI:

"PERFORCIMI /REHABILITIMI I BANESES 1 KAT

ANDRESA:

Z.K.2449PASURIA 300 / 11 / 1

FSHATI LIÇAJ -NJ. AD. SHALES - B CERRIK

ZHVILLUES : VASIF REXHEP LIÇI

POROSITI: VASIF REXHEP LIÇI

OBJEKTI: PERFORCIMI/REHABILITIMI I BANESAVE EKZISTUESE			<i>Faza eProjektit: Projekt-zbatimi</i>
EMERTESA E FLETES:KOPERTINA			Nr.fletes 1
 Drejtori D.P.T.&ZH.	Porositesi: <i>Spektori i Strehimit</i>	Hartoi	<i>neshkrimi</i>
	Perfituese: <i>Vasif Liçi</i>	ing.Fatmir Uruçi	
	<i>Rruga: "Gjimnazi 1962"</i>	ing.Erdison Baxhia	
	<i>Lagja 'Lagja Nr 2" Cerrik</i> <i>E-Mail: bashkiacerrik@yahoo.com</i>	ing.Arber Disha	
		tek.Shkelqim Liçi	<i>janar 2023</i>

OBJEKTI:

"PERFORCIMI /REHABILITIMI I BANESES 1 KAT

ANDRESA:

Z.K. 2449 PASURIA ; 300/9

FSHATI LIÇAJ -NJ.AD.SHALES -B CERRIK

PERFITUES : MISIR OSMAN LIÇI

POROSITI: SEKTORI I STREHIMIT B.CERRIK

OBJEKTI: PERFORCIMI/REHABILITIMI I BANESAVE EKZISTUESE			<i>Faza eProjektit: Projekt-zbatimi</i>
EMERTESA E FLETES:KOPERTINA			Nr.fletes 1
 Drejtori D.P.T.&ZH.	Porositesi: <i>Sektori i Strehimit</i>	Hartoi	<i>neshkrimi</i>
	Perfituese: <i>Misir Liçi</i>	ing.Fatmir Uruçi	
	Rruga: <i>"Gjimnazi 1962"</i>	ing.Erdison Baxhia	
	Lagja <i>'Lagja Nr 2" Cerrik</i> E-Mail: bashkiacerrik@yahoo.com	ing.Arber Disha	
		tek.Shkelqim Liçi	<i>janar 2023</i>

OBJEKTI:

"PERFORCIMI /REHABILITIMI I BANESES 1 KAT

ANDRESA:

Z.K. 2449 PASURIA 300/15

FSHATI LIÇAJ -NJ.AD. SHALES - B CERRIK

PERFITUES : BEKTASH RAMAZAN LIÇI

POROSITI:SEKTORI I STREHIMIT B.CERRIK

OBJEKTI: PERFORCIMI/REHABILITIMI I BANESAVE EKZISTUESE			<i>Faza eProjektit: Projekt-zbatimi</i>		
EMERTESA E FLETES:KOPERTINA			Nr.fletes 1		
 Drejtori D.P.T.&ZH.	Porositesi: <i>Sektori i Strehimit</i>	Hartoi	<i>neshkrimi</i>		
	Perfituese: <i>Bektash Liçi</i>	ing.Fatmir Uruçi		Sh.1:75	
	Rruga: <i>"Gjimnazi 1962"</i>	ing.Erdison Baxhia			janar 2023
	Lagja <i>'Lagja Nr 2" Cerrik</i> E-Mail: bashkiacerrik@yahoo.com	ing.Arber Disha tek.Shkelqim Liçi			

OBJEKTI:

"PERFORCIMI /REHABILITIMI I BANESES 1 KAT "

ANDRESA:

Z. K. 1630 PASURIA 107/7/1

FSHATI FLOQ -NJ. AD. KLOS - B. CERRIK

PERFITUES; AQIF ARSHIN TAFI

POROSITI: SEKTORI E STREHIMIT

OBJEKTI: "PERFORCIMI/REHABILITIMI I BANESAVE EKZISTUESE"			<i>Faza eProjektit:</i> <i>Projekt-zbatimi</i>
EMERTESA E FLETES: KOPERTINA			Nr.fletes 1
BASHKIA CERRIK  Drejtori D. P. ZH.	<i>Porositesi: Sektori i Strehimit</i> <i>Perfitues : Aqif Arshin Tafa</i> <i>Rruga: "Gjimnazi 1962"</i> <i>Lagja 'Lagja Nr 2' Cerrik</i> <i>E-Mail: bashkiacerrik@yahoo.com</i>	<i>Hartoi</i> ing.Fatmir Uruçi ing.Erdison Baxhija ing.Arbri Dishaj tek.Shkelqim Liçi	<i>nënshtkrimi</i> <i>janar 2023</i>

OBJEKTI:

"PERFORCIMI /REHABILITIMI I BANESES 1 KAT

ANDRESA:

1530 PASURIA 78/4

FSHATI DRAGOT -NJ.AD.MOLLAS -B CERRIK

PERFITUES;SERVET LIVAN SENJA

POROSITI:SEKTORI E STREHIMIT

OBJEKTI: PERFORCIMI/REHABILITIMI I BANESAVE EKZISTUESE			<i>Faza eProjektit:</i> <i>Projekt-zbatimi</i>
EMERTESA E FLETES:KOPERTINA			Nr.fletes 1
 Drejtori D.P.T.&ZH.	<i>Porositesi: Sektori i Strehimit</i>	Hartoi	<i>neshkrimi</i>
	<i>Perfituese: Servet Livan Senja</i>	ing.Fatmir Uruçi	
	<i>Rruga: "Gjimnazi 1962"</i>	ing.Erdison Baxhia	
	<i>Lagja 'Lagja Nr 2" Cerrik</i> <i>E-Mail: bashkiacerrik@yahoo.com</i>	ing.Arber Disha	
		tek.Shkelqim Liçi	<i>janar</i>

OBJEKTI:

"PERFORCIMI /REHABILITIMI I BANESES 1 KAT"

ANDRESA:

Z.K 3422, PASURIA ME NR. 145/16/1

FSHATI SHTERMEN - NJ.AD. GOSTIME - B. CËRRIK

PERFITUES: ÇLIRIM PREN MURIQI

POROSITI: SEKTORI I STREHIMIT

OBJEKTI: "PËRFORCIMI/REHABILITIMI I BANESAVE EKZISTUESE"			<i>Faza eProjektit:</i> <i>Projekt-zbatimi</i>
EMËRTESA E FLETËS: KOPERTINA			Nr.fletes 1
BASHKIA CERRIK  Drejtoria/P & ZH	<i>Porositësi: Sektori i Strehimit</i> <i>Përfituese: Çlirim Pren Muriqi</i> <i>Adresa: Rruga "Gjimnazi 1962", Lagja Nr. 2, Cërrik</i> <i>e-mail: bashkiacerrik@yahoo.com</i>	<i>Hartoi:</i> ing. Fatmir Uruçi ing. Erdison Baxhja ing. Arbër Disha tek. Shkëlqim Liçi	<i>nënshtkrimi</i> Sh.----- <i>janar 2023</i>

OBJEKTI:

"PERFORCIMI /REHABILITIMI I BANESES 1 KAT"

ANDRESA:

Z.K 2559, PASURIA ME NR. 146/26

FSHATI MALASEJ - NJ.AD. GOSTIME - B. CËRRIK

PERFITUES: EMIN HAXHI ISHJA

POROSITI: SEKTORI I STREHIMIT

OBJEKTI: "PËRFORCIMI/REHABILITIMI I BANESAVE EKZISTUESE"		<i>Faza eProjektit:</i> <i>Projekt-zbatimi</i>	
EMËRTESA E FLETËS: KOPERTINA		Nr.fletes 1	
 BASHKIA CERRIK Drejtoria/P & ZH	Porositësi: <i>Spektori i Strehimit</i>	Hartoi:	<i>nënshkrimi</i>
	Përfutuese: <i>Emin Haxhi Ishja</i>	ing. Fatmir Uruçi	Sh.-----
	Adresa: <i>Rruga "Gjimnazi 1962", Lagja Nr. 2, Cërrik</i>	ing. Erdison Baxhja	
	<i>e-mail: bashkiacerrik@yahoo.com</i>	ing. Arbër Disha	
		tek. Shkëlqim Liçi	<i>janar 2023</i>

OBJEKTI:

"PERFORCIMI /REHABILITIMI I BANESES 2 KAT

ANDRESA:

2717 PASURIA 144/9/1

FSHATI MOLLAS -NJ.AD.MOLLAS -B CERRIK

PERFITUES;GENTJAN RUZHDI ASLLANITJAN ASLLANI DHE

IRIDIAN

POROSITI:SEKTORI E STREHIMIT

OBJEKTI: PERFORCIMI/REHABILITIMI I BANESAVE EKZISTUESE			<i>Faza eProjektit:</i> <i>Projekt-zbatimi</i>
EMERTESA E FLETES:KOPERTINA			Nr.fletes 1
 Drejtori D.P.T.&ZH.	<i>Porositesi: Sektori i Strehimit</i>	Hartoi	<i>neshkrimi</i>
	<i>Perfituese:Gentjan dhe Iridian ASllani</i>	ing.Fatmir Uruçi	Sh.
	<i>Rruga:"Gjimnazi 1962"</i>	ing.Erdison Baxhia	
	<i>Lagja 'Lagja Nr 2" Cerrik</i> <i>E-Mail:bashkiacerrik@yahoo.com</i>	ing.Arber Disha	
		tek.Shkelqim Liçi	2023

OBJEKTI:

"PËRFORCIMI /REHABILITIMI I BANESËS 1 KAT"

ADRESA: 2523 PASURIA 22/11 FSHATI LUMAS - NJ. AD. KLOS -B. CERRIK

PËRFITUES; ALI SHAQIR XIBRAKU

POROSITI: SEKTORI E STREHIMIT

OBJEKTI: PËRFORCIMI/REHABILITIMI I BANESAVE EKZISTUESE			<i>Faza eProjektit:</i> <i>Projekt-zbatimi</i>		
EMËRTESE E FLETËS: KOPERTINA			Nr. fletës 1		
 Drejtori D. P. ZH. T.	Porositësi: <i>Spektori i Strehimit</i>	Hartoi	<i>nëshkrimi</i>		
	Përfituesi: <i>Halim Shaqir Xibraku</i>	ing. Fatmir Uruçi		Sh.1:75	
	Rruga: <i>"Gjimnazi 1962"</i>	ing. Erdison Baxhija			Gusht 2023
	Lagja <i>'Lagja Nr 2' Cerrik</i>	ing. Arbri Disha			
E-Mail: <i>bashkiacerrik@yahoo.com</i>	Lagja <i>'Lagja Nr 2' Cerrik</i>	tek. Shkelqim Liçi			

OBJEKTI:

"PUNIME PER REHABILITIM E BANESES I KAT"

ADRESA:

Z.K. 2559 PAS.271/8, FSHATI ÇARTALLOZ, – NJ.AD.GOSTIME – B

CERRIK

PRONARI: ZNJ. HURMA NEXHIP TAFANI & BASHKEPRONARET

INVESTITORI: ZNJ. HURMA NEXHIP TAFANI

POROSITI: ZNJ. HURMA NEXHIP TAFANI

OBJEKTI: "PËRFORCIMI/REHABILITIMI I BANESAVE EKZISTUESE"			<i>Faza eProjektit:</i> <i>Projekt-zbatimi</i>
EMËRTESE E FLETËS: KOPERTINA			Nr.fletes 0
 BASHKIA CERRIK Drejtoria/P & ZH	Porositësi: <i>Saktori i Strehimit</i>	Hartoi:	<i>nëshkrimi</i>
	Përfituese: <i>Hurma Nexhip Tafani</i>	ing. Fatmir Uruçi	Sh.-----
	Adresa: <i>Rruga "Gjimnazi 1962", Lagja Nr. 2, Cërrik</i>	ing. Erdison Baxhja	
	e-mail: bashkiacerrik@yahoo.com	ing. Arbër Disha	
		tek. Shkëlqim Liçi	<i>janar 2023</i>

OBJEKTI:

"PËRFORCIMI /REHABILITIMI I BANESËS 1 KAT"

ADRESA: 2163 PASURIA 289/3 FSHATI KLOS - NJ. AD. KLOS -B. CERRIK

PËRFITUES; KADRI AHMET XIBRAKU

POROSITI: SEKTORI E STREHIMIT

OBJEKTI: PËRFORCIMI/REHABILITIMI I BANESAVE EKZISTUESE			<i>Faza eProjektit:</i> <i>Projekt-zbatimi</i>		
EMËRTESE E FLETËS: KOPERTINA			Nr. fletës 1		
 Drejtori D. P. ZH. T.	Porositësi: <i>Spektori i Strehimit</i>	Hartoi	<i>nëshkrimi</i>		
	Përfituesi: <i>Kadri Ahmet Xibraku</i>	ing. Fatmir Uruçi		Sh.1:75	
	Rruga: <i>"Gjimnazi 1962"</i>	ing. Erdison Baxhija			Gusht 2023
	Lagja <i>'Lagja Nr 2' Cerrik</i>	ing. Arbri Disha			
E-Mail: <i>bashkiacerrik@yahoo.com</i>	Lagja <i>'Lagja Nr 2' Cerrik</i>	tek. Shkelqim Liçi			

OBJEKTI:

"PERFORCIMI /REHABILITIMI I BANESES 1 KAT

ANDRESA:

2717 PASURIA 210/24

FSHATI MOLLAS -NJ.AD.MOLLAS -B CERRIK

PERFITUES;MALIQ DEMIR GJINI

POROSITI:SEKTORI E STREHIMIT

OBJEKTI: PERFORCIMI/REHABILITIMI I BANESAVE EKZISTUESE			<i>Faza eProjektit:</i> Projekt-zbatimi		
EMERTESA E FLETES:KOPERTINA			Nr.fletes 1		
 BASHKIA CERRIK Drejtori D.P.T.&ZH.	Porositesi: <i>Sektori i Strehimit</i>	Hartoi	<i>neshkrimi</i>		
	Perfituese: <i>Maliq Demir Gjini</i>	ing.Fatmir Uruçi		Sh.	
	Rruga: <i>"Gjimnazi 1962"</i>	ing.Erdison Baxhia			janar 2023
	Lagja <i>'Lagja Nr 2" Cerrik</i> E-Mail: bashkiacerrik@yahoo.com	ing.Arber Disha tek.Shkelqim Liçi			

OBJEKTI:

"PËRFORCIMI /REHABILITIMI I BANESËS 1 KAT"

ADRESA: Z.K. 2559, PASURIA 18/54, FSHATI MALASEJ - NJ. AD. GOSTIM -B. CERRIK

PËRFITUES; MILAZIM AHMET GASHI

POROSITI: SEKTORI E STREHIMIT

OBJEKTI: PËRFORCIMI/REHABILITIMI I BANESAVE EKZISTUESE			<i>Faza eProjektit:</i> <i>Projekt-zbatimi</i>	
EMËRTESE E FLETËS: KOPERTINA			Nr. fletës 1	
 Drejtori D. P. ZH. T.	Porositësi: <i>Spektori i Strehimit</i>	Hartoi	<i>nëshkrimi</i>	
	Përfituesi: <i>Milazim Ahmet Gashi</i>	ing. Fatmir Uruçi		Sh. -----
	Rruga: <i>"Gjimnazi 1962"</i>	ing. Erdison Baxhija		
	Lagja <i>'Lagja Nr 2' Cerrik</i>	ing. Arbri Disha		
E-Mail: bashkiacerrik@yahoo.com		tek. Shkelqim Liçi	<i>Gusht 2023</i>	

OBJEKTI:

'PERFORCIMI /REHABILITIMI I BANESES 1 KAT

(PRISHJE DHE NDERTIMI I BANESES 1KAT)

ANDRESA:

3609 PASURIA 164/2

FSHATI TOPOJAN -NJ.AD.MOLLAS -B CERRIK

PERFITUES:NAZMI REFAT TABAKU

POROSITI:SEKTORI E STREHIMIT

OBJEKTI: PERFORCIMI/REHABILITIMI I BANESAVE EKZISTUESE (PRISHJE DHE NDERTIMI I BANESES 1 KAT)			<i>Faza eProjektit: Projekt-zbatimi</i>		
EMERTESA E FLETES:KOPERTINA			Nr.fletes 1		
 Drejtori D.P.T.&ZH.	<i>Porositesi: Sektori i Strehimit</i>	Hartoi	<i>neshkrimi</i>		
	<i>Perfituese:Nazmi Refat Tabaku</i>	ing.Fatmir Uruçi		Sh.1:75	
	<i>Rruga:"Gjimnazi 1962"</i>	ing.Erdison Baxhia			2023
	<i>Lagja 'Lagja Nr 2" Cerrik</i> <i>E-Mail:bashkiacerrik@yahoo.com</i>	ing.Arber Disha			
		tek.Shkelqim Liçi			

OBJEKTI:

"PERFORCIMI/REHABILITIMI I BANESES 1 KAT"

ANDRESA:

Z. K. 2163, PASURIA 293/10

FSHATI KLOS - NJ. AD. KLOS - B. CERRIK

PERFITUES: NEIM ABAZ GJINI DHE SHPRESA QEMAL GJINI

POROSITI: SEKTORI E STREHIMIT

OBJEKTI: "PERFORCIMI/REHABILITIMI I BANESAVE EKZISTUESE"			<i>Faza eProjektit:</i> <i>Projekt-zbatimi</i>
EMERTESA E FLETES: KOPERTINA			Nr.fletes 1
BASHKIA CERRIK  Drejtoria/P & ZH	<i>Porositesi: Sektori i Strehimit</i> <i>Perfituese: Neim Abaz Gjini & Shpresa Qemal Gjini</i> <i>Adresa: Rruga "Gjimnazi 1962", Lagja Nr. 2, Cërrik</i> <i>e-mail: bashkiacerrik@yahoo.com</i>	Hartoi ing.Fatmir Uruçi ing. Erdison Baxhja ing.Ar bri Dish tek.Shkelqim Liçi	<i>nënshtkrimi</i> Sh.----- <i>janar 2023</i>

OBJEKTI:

"PËRFORCIMI /REHABILITIMI I BANESËS 1 KAT

ADRESA: 2163 PASURIA 230/6 FSHATI KLOS - NJ. AD. KLOS -B. CERRIK

PËRFITUES; NURI IBRAHIM XHERIJA

POROSITI: SEKTORI E STREHIMIT

OBJEKTI: PËRFORCIMI/REHABILITIMI I BANESAVE EKZISTUESE			<i>Faza eProjektit:</i> <i>Projekt-zbatimi</i>		
EMËRTESE E FLETËS: KOPERTINA			Nr. fletës 1		
 Drejtori D. P. ZH. T.	Porositësi: <i>Spektori i Strehimit</i>	Hartoi	<i>nëshkrimi</i>		
	Përfituesi: <i>Nuri Ibrahim Xherija</i>	ing. Fatmir Uruçi		Sh.1:75	
	Rruga: <i>"Gjimnazi 1962"</i>	ing. Erdison Baxhija			Gusht 2023
	Lagja <i>'Lagja Nr 2" Cerrik</i> E-Mail: bashkiacerrik@yahoo.com	ing. Arbri Disha			
		tek. Shkelqim Liçi			