



REPUBLIKA E SHQIPERISE
UJESJELLES KANALIZIME ELBASAN

0.10.2016

PROJEKT

NDERITIM I RRJETIT TE HIDRANTEVE PER KRASTEN,
BASHKIA ELBASAN

HARTOI

Ing. Lulzime DAMA

Ing. Julian DERVISHI

Ing. Julian DOÇI

MIRATOI
ADMINISTRATORI
Luan DERVISHI

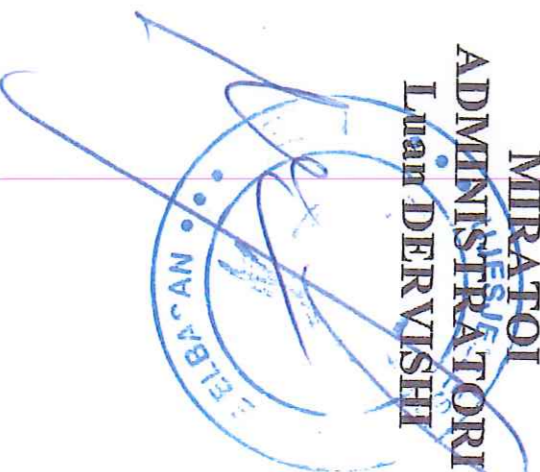



PROJEKTI
HIDRANTEVE PER KRASHTEN
OBJEKTI: NDRERTIM I RRJETIT TE
PORSIT
KONSTRUKTIVITETI
PORSIT

PROJEKTI
ING. LULZIME DAMA
LICENCE: K.2169/1
ING. JULIAN DOCI
LICENCE: K.2490
ING. JULIAN DERVISHI

HOROGRAFIA

1:10000

POMPE CENTRIFUGALE

Ø 204mm
168

TUB PE 125mmPN10

TUB PE 125mmPN10

TUB PE 125mmPN10

Ø 201m
HIDRANT NENTOKESOR

Ø 276m

TUB PE 125mmPN10

Ø 250m
HIDRANT NENTOKESOR

TUB PE 125mmPN10

TUB PE 125mmPN10

Ø 249m
HIDRANT NENTOKESOR

TUB PE 125mmPN10

Ø 246m
HIDRANT NENTOKESOR

TUB PE 125mmPN10

Ø 244m
HIDRANT NENTOKESOR

TUB PE 125mmPN10

Ø 242m
HIDRANT NENTOKESOR

TUB PE 125mmPN10

Ø 241m

TUB PE 125mmPN10

TUB PE 125mmPN10

Ø 239m
HIDRANT NENTOKESOR



POROSI

UESSELLES KANALIZIME

OBREKT: NDERITM I RREJTT TE
HIDRANTEVE PER KRASTEN

PROJEKTOR

Ing. LULZIME DAMA
LICENCE: K.2169/1

Ing. JULIAN DOCI
LICENCE: K.2490

Ing. JULIAN DERVISHI
LICENCE: K.2490

Plani i Përgjithshem

Planimetria e Projektit

PROJEKTOR
Ing. LULZIME DAMA
LICENCE: K.2169
Ing. JULIAN DOCI
LICENCE: K.2490
Ing. JULIAN DERVISHI

OBJEKTI: NDERITIM I RRJETIT TE
HIDRANTEVE PER KRASTEN



POROSI

TUB PE 125mm PN10

POMPE CENTRIFUGALE

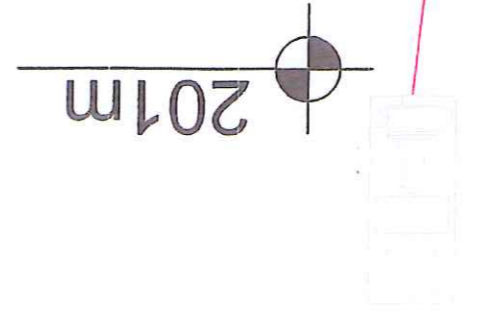

201m

TUB PE 125mmPN10

TUB F

HIDRANT
NENTOKESOF

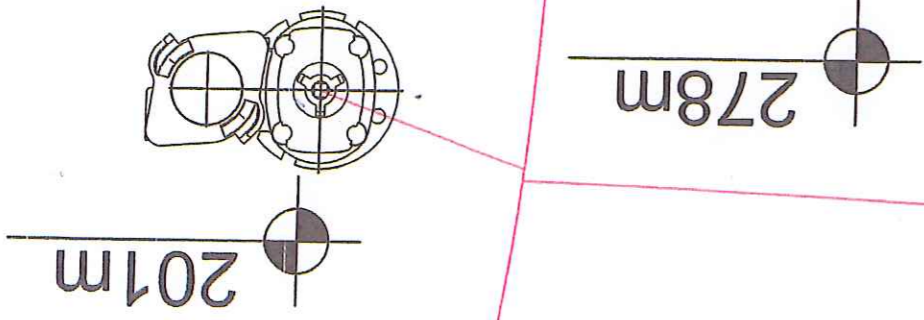

Planimetria e Projektit

PROJEKTOR
Ing. LULZIME DAMA
LICENCE: K.2169/1
Ing. JULIAN DOçi
LICENCE: K.2490
Ing. JULIAN DERVISHI

Viti 2020

ELBASAN sh.p.ë
UJESJELTES KANALIZIME
POROSITI
HIDRANTEVE PER KRASTEN
OBJEKTI: NDRERTIM I RRJETIT TE

SHKALLA 1:1000	FLETA NR.	VII 2020	UJESITËS KANALIZIME ELBASAN sh.p POROSIT  HIDRANTEVE PER KRASTEN OJESIT: NDERTIM I RRJETIT TE
Planimetria e Projektit		PROJEKTOR Ing. LULZIME DAMA LICENCE: K. 2169/1 Ing. JUAN DOÇI LICENCE: K. 2490 Ing. JUAN DERSHI	





TUB PE

TUB PE 125mm PN10

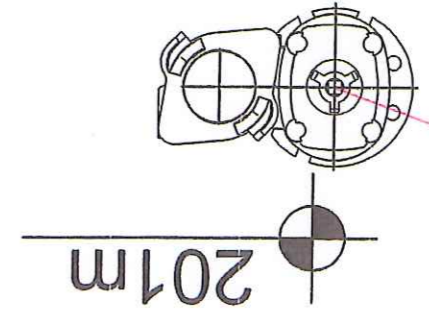
HIDRANT
NENTOKESOR



278m

EBSAN s.h.o	KONSTRUKTOR	VITI 2020	URBANIZIM I KANALIZIMET POROSIT 
EBSAN s.h.o	Ing. JULIAN DOÇI LICENCE: K.2490 Ing. JULIAN DERSHII LICENCE: K.2169/1 Ing. LULZIME DAMA LICENCE: K.2169/1 PROJEKTOR	Ing. LULZIME DAMA LICENCE: K.2169/1 Ing. JULIAN DOÇI LICENCE: K.2490 Ing. JULIAN DERSHII LICENCE: K.2169/1 PROJEKTOR	URBANIZIM I KANALIZIMET POROSIT 

TUB PE 125mm PN10

HIDRANT NENTOKESOR

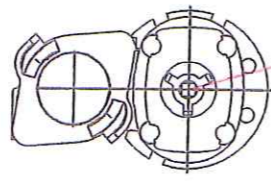

TUB PE



HIDRANTEVE PER KRASTEN
OBJEKTE NDERTIM I RRËFTIT TE

PROJEKTOR
Ing. LULZIME DAMA
LICENCE: K. 2169 / 1
Ing. JUAN DOÇI
LICENCE: K. 2490
Ing. JULIAN DERVISHI

Planimetria e Projektit

HIDRANT
NENTOKESOR

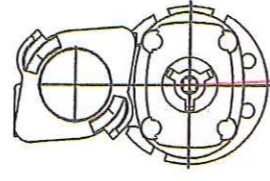

246m

TUB PE
125mm PN10

SHKALLA 1:1000	FLETA NR.	VITI 2020	UËSHTJES KANALIZIME ELBASAN sh.a POBOSI 
Planimetria e Projektit		PROJEKTOI Ing. LULZIME DAMA LICENCE: K.2169/1 Ing. JULIAN DOÇI LICENCE: K.2490 Ing. JULIAN DERSHII	OBJEKTI: NDERITIM I RRJETIT TE HIDRANTEVE PER KRASTEN

TUB PE 125mmPN10

HIDRANT
NENTOKESOR

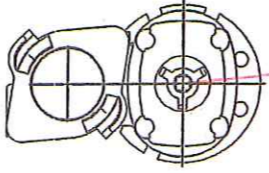

242m

URSULES KANALIZIME
 ELBASAN sh.p
 POROSIT

SHKURTY: NDERTM I RREJITIT TE
 HIDRANTEVE PER KRASTEN

WIT 2020
 PROJEKTOR
 Ing. LULZIME DAMA
 LICENCE: K.2169/1
 Ing. JULIAN DOÇI
 LICENCE: K.2490
 Ing. JULIAN DERSHII

Planimetria e Projektit

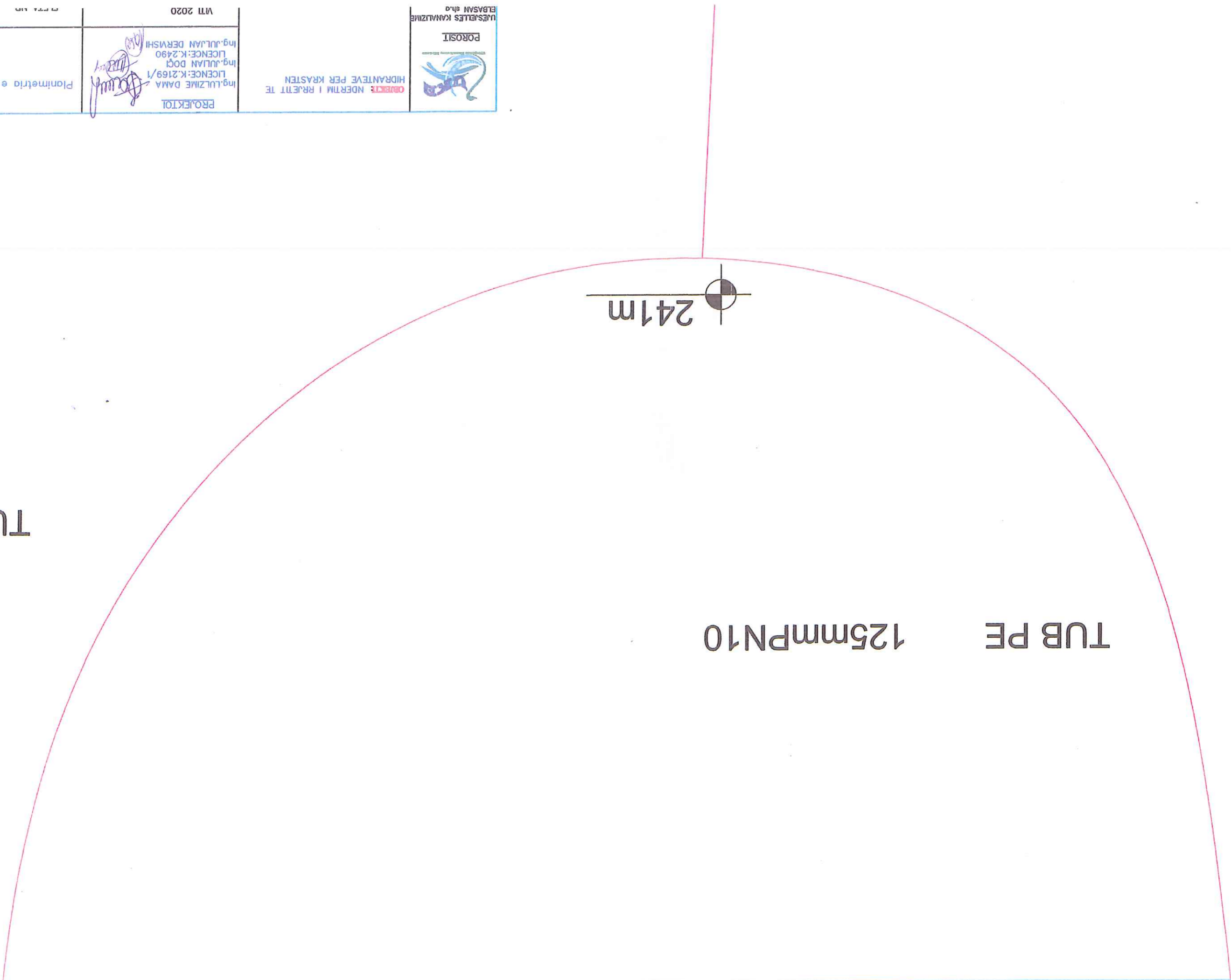

TUB PE

TUB PE 125mm PN10

241m

SHKALLA 1:1000

FLETA NR.

VITI 2020

UJESJELLE KANALIZIME
ELBASAN sh.a

POROSIT



OBJEKTI: NDERITIM I RRJETIT TE
HIDRANTEVE PER KRASTEN

PROJEKTORI
Ing. LULIZIME DAMA
LICENCE: K.2169/1
Ing. JULIAN DOCI
LICENCE: K.2490
Ing. JULIAN DERVISHI

Planimetria e Projektit

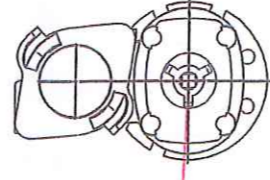

HIDRANT

233m
NENTOKFSOR

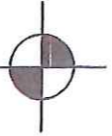

UJESJELLE'S KANALIZIME
ELBASAN sh.a



POROSIT

OBJEKTI: NDERITIM I RRJETIT TE
HIDRANTEVE PER KRASTEN

PROJEKTORI

Ing. LULZIME DAMA
LICENCE: K.2169/1

Ing. JIJUAN DQI
LICENCE: K.2490

Ing. JIJUAN DERVISHI



VITI 2020

Planimetria e Projektit

TUB PE 125mmPN10



POROSITI

OBJEKTI: NDERRTIM I RRJETIT TE
HIDRANTEVE PER KRASTEN

PROJEKTORI
Ing. LULZIME DAMA
LIGENCE: K.2169/1
Ing. JULIAN DOCI
LIGENCE: K.2490
Ing. JULIAN DERVISHI

Planimetria e Projektit

HIDRANT NENTORRESOR

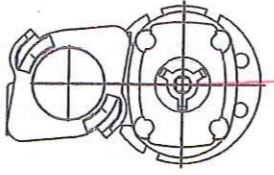

244m

TUB PE 125mmPN10

NENTOKESOR



TUB PE 125mmPN10

TUB PE 125mmPN10

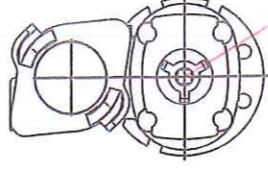
249m



HIDRANT
NENTOKESOR

SHKALLA 1:1000	FLETA NR.	VITI 2020	UESJELLES KANALIZIME ELBASAN sh.p
Planimetria e Projektit	 Ing. LULZIME DAMA LICENCE: K.2169/T Ing. JULIAN DOÇI LICENCE: K.2490 Ing. JULIAN DERSHII	PROJEKTOR	 OBJEKTI: NDERITIM I RRJETIT TE HIDRANTVE PER KRASTEN

PJRRESIA		188	276	249	244	241	242	246	250	276
KUOTA E TOKES	188	276	249	244	241	242	246	250	276	276
KUOTA E PROJEKTI	186,8	274,8	247,8	242,8	238,9	240,8	244,8	248,3	274,8	274,8
THELESIA E GERMIMITI	1,2	1,2	1,2	1,2	1,2	1,2	1,2	1,2	1,2	1,2
DISTANCA PJESORE		455	277	283	288	362	190	274	490	490

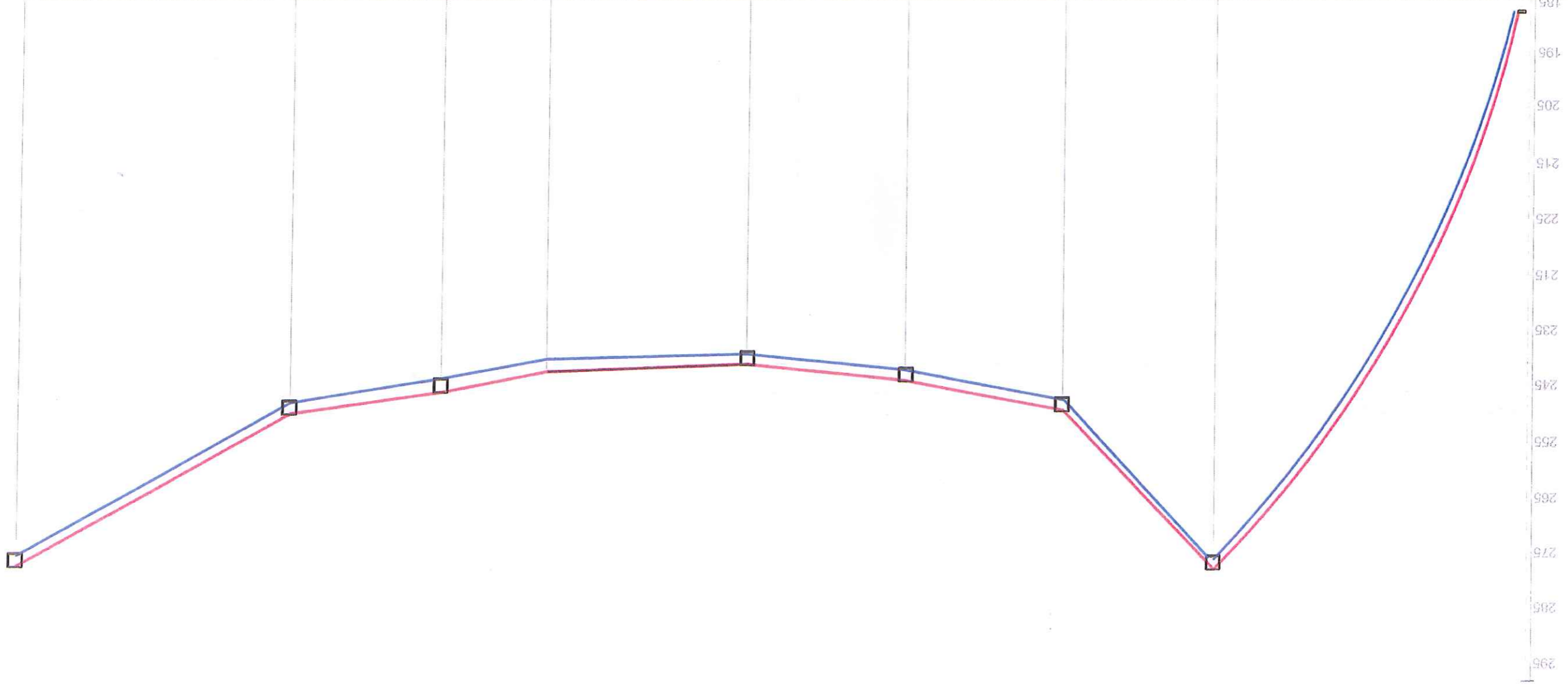

POROSIT
 HIDRANTEVE PER KRASTEN
 QUBETI: NDERTIM I RRJETIT TE

PROJEKTI
 Ing. LULZIME DAMA
 LICENCE: K. 2169
 Ing. JULIAN DOÇI
 LICENCE: K. 2490
 Ing. JULIAN DERSHI

Profili Gjatësore

Prerja terthore e kanalit
 Rruge pa asfalt
 Tub 125 PE

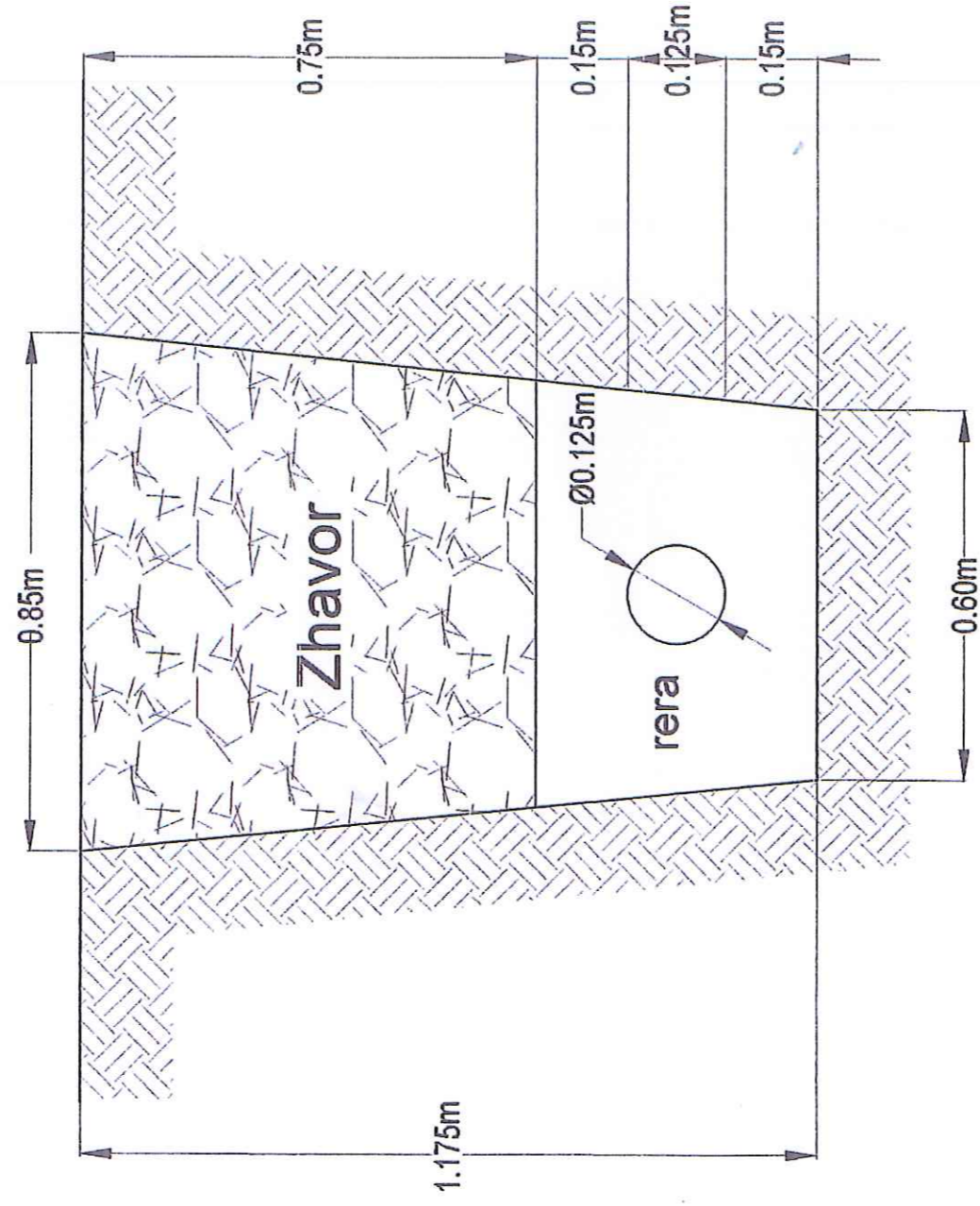

EOROSII
 UJESIELLES KANALIZIME
 ELBASAN sh.a

OBJEKTI: NDERTIM I RRJETIT TE
 HIDRANTEVE PER KRASTEN

PROJEKTORI

Ing. LULZIME DAMA
 LICENCE: K.2169/1
 Ing. JULIAN DOQI
 LICENCE: K.2490
 Ing. JULJAN DERSHISHI

Planimetria e Projektit

VITI 2020

FLETA NR. SHKALLA