

REPUBLIKA E SHQIPËRISË  
BASHKIA E TIRANËS

OBJEKTI: "RIKUALIFIKIMI URBAN I ZONËS  
INFORMALE QË KUFIZOHET NGA RRUGËT  
-SABAUDIN GABRANI -JONUZ RAMA-HAMDI  
CULLHAJ-DAMIAN HIMARIOTI-BARI  
ISHKA-VASFI SAMIMI-ALUSH ELMAZ TAKA."

Projektoi :

Ing.A.JAKOVA  
Ing.G.ISLAMI  
Ing.S.MYRSELI  
Ing.P.SHKURTI

Ark.M.DADO  
Ing.Gjeol.Xh.KASMI  
Ing.Mjedis.E.CALI  
Top.A.BECECI

Projektoi :  
"S&L STUDIO SH.P.K"

Projektim-kupervizion-cosnulence



FAZA

DORËZIM

PROJEKT ZBATIMI

1.0

PROFILE TËRTHORE  
RRUGA RR.ILMAZ TAKA 2

SHKALLA 1:100

Nr. I FLETËS 001

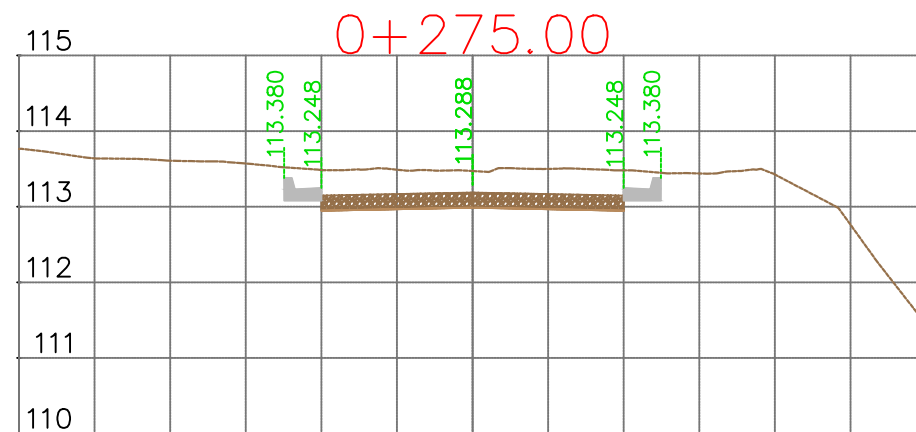
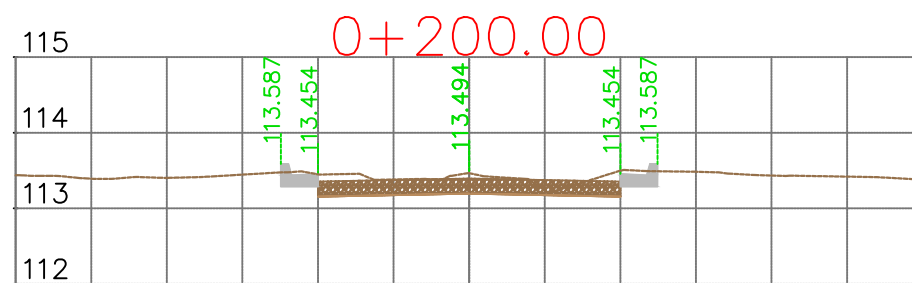
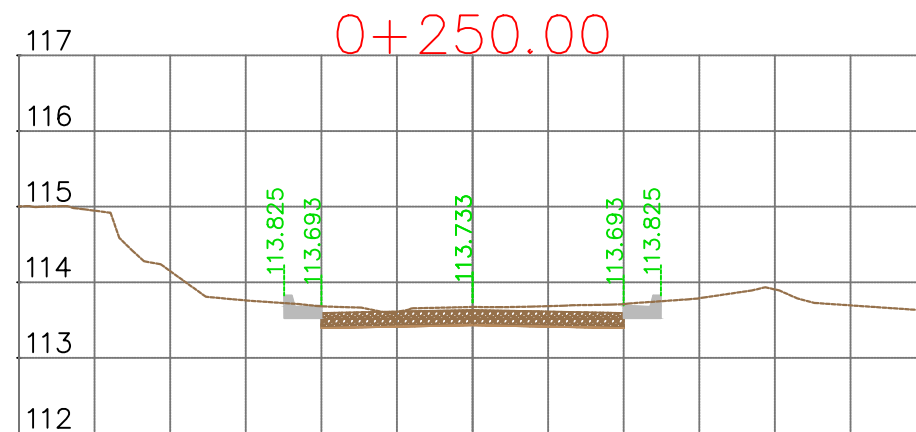
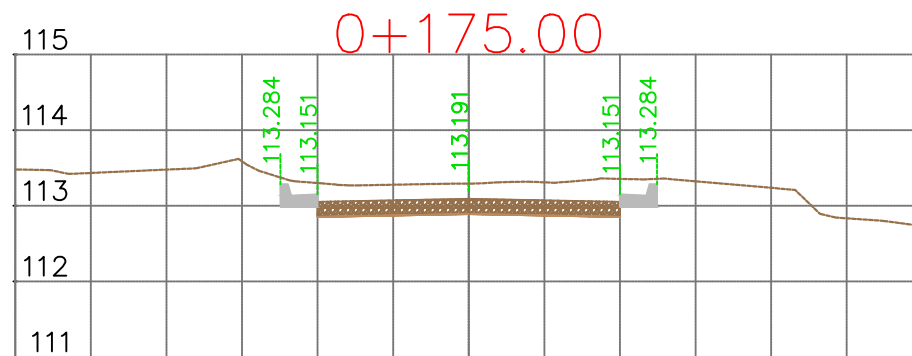
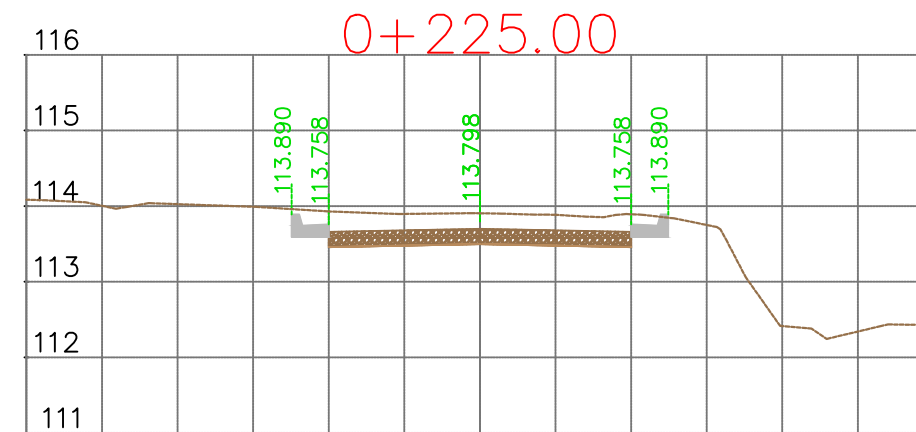
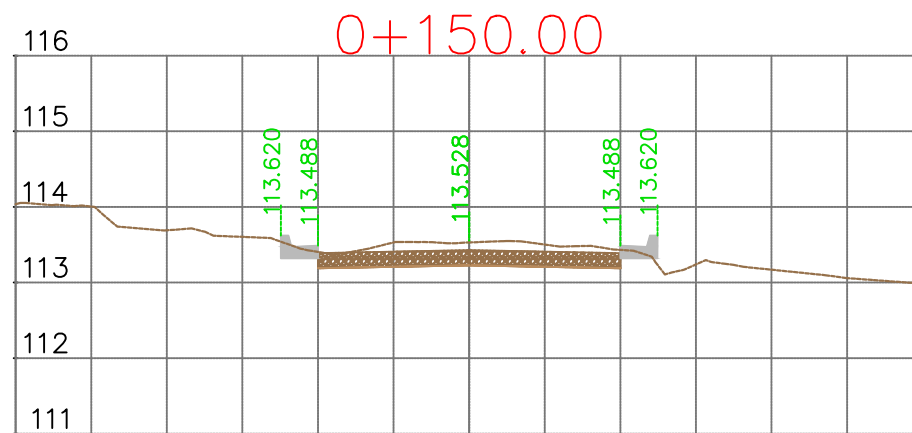

REPUBLIKA E SHQIPËRISË  
BASHKIA E TIRANËS

OBJEKTI: "RIKUALIFIKIMI URBAN I ZONËS  
INFORMALE QË KUFIZOHET NGA RRUGËT  
-SABAUDIN GABRANI -JONUZ RAMA-HAMDI  
CULLHAJ-DAMIAN HIMARIOTI-BARI  
ISHKA-VASFI SAMIMI-ALUSH ELMAZ TAKA."

Projektoi :

Ing.A.JAKOVA  
Ing.G.ISLAMI  
Ing.S.MYRSELI  
Ing.P.SHKURTI

Ark.M.DADO  
Ing.Gjeol.Xh.KASMI  
Ing.Mjedis.E.CALI  
Top.A.BECECI

Projektoi :

"S&L STUDIO SH.P.K"

Projektim-kupervizion-cosnulence



FAZA

DORËZIM

PROJEKT ZBATIMI

1.0

PROFILE TËRTHORE  
RRUGA RR.ILMAZ TAKA 2

SHKALLA 1:100

Nr. I FLETËS 002

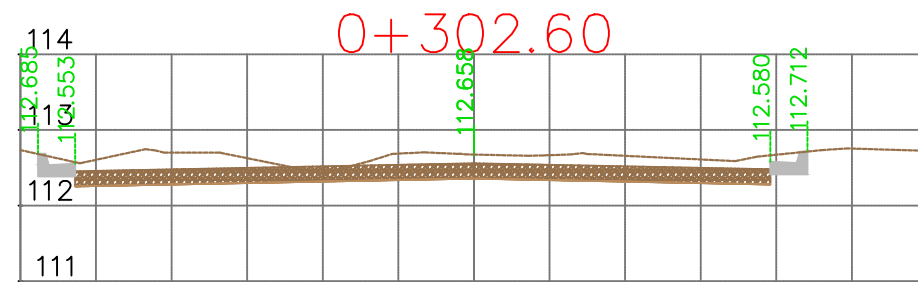
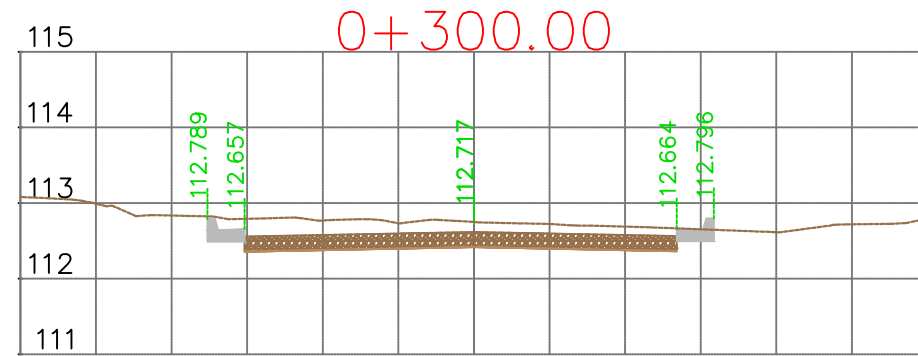

REPUBLIKA E SHQIPËRISË  
BASHKIA E TIRANËS

OBJEKTI: "RIKUALIFIKIMI URBAN I ZONËS INFORMALE QË KUFIZOHET NGA RRUGËT -SABAUDIN GABRANI -JONUZ RAMA-HAMDI CULLHAJ-DAMIAN HIMARIOTI-BARI ISHKA-VASFI SAMIMI-ALUSH ELMAZ TAKA."

Projektoi :

Ing.A.JAKOVA  
Ing.G.ISLAMI  
Ing.S.MYRSELI  
Ing.P.SHKURTI

Ark.M.DADO  
Ing.Gjeol.Xh.KASMI  
Ing.Mjedis.E.CALI  
Top.A.BECECI

Projektoi :

**"S&L STUDIO SH.P.K"**

Projektim-kupervizion-cosnulence



FAZA

DORËZIM

PROJEKT ZBATIMI

1.0

PROFILE TËRTHORE  
RRUGA RR.ILMAZ TAKA 2

SHKALLA 1:100

Nr. I FLETËS 003

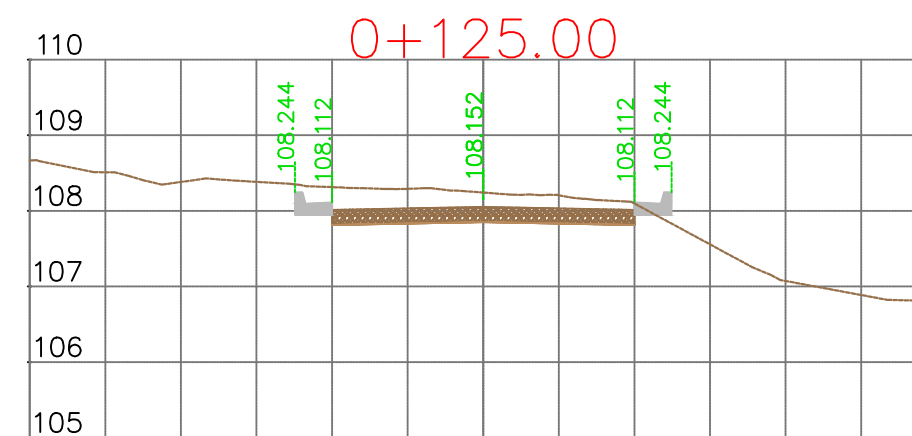
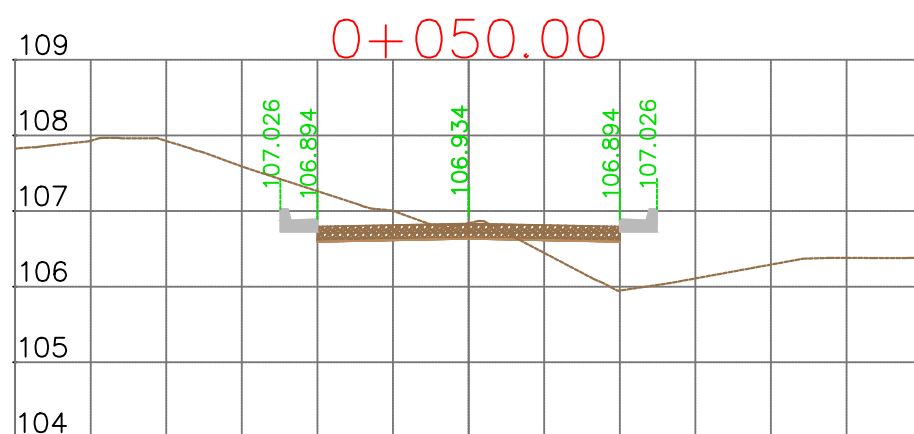
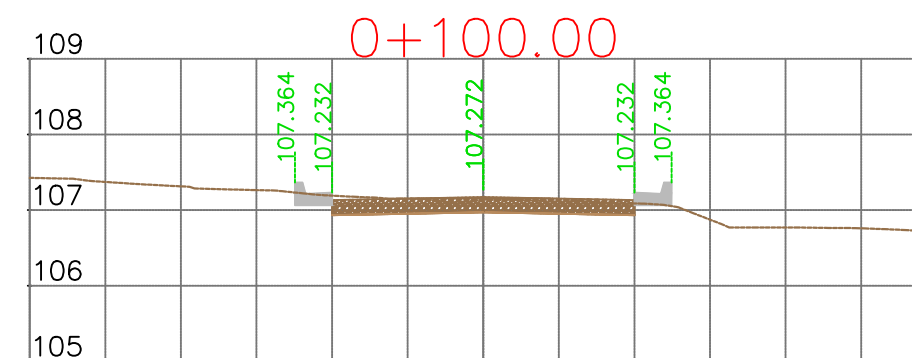
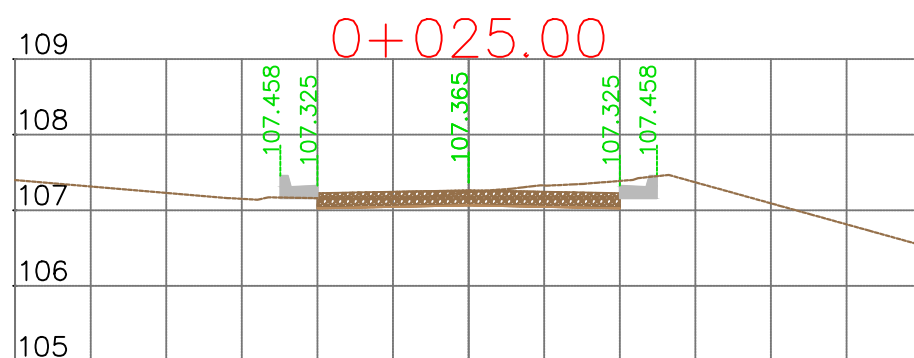
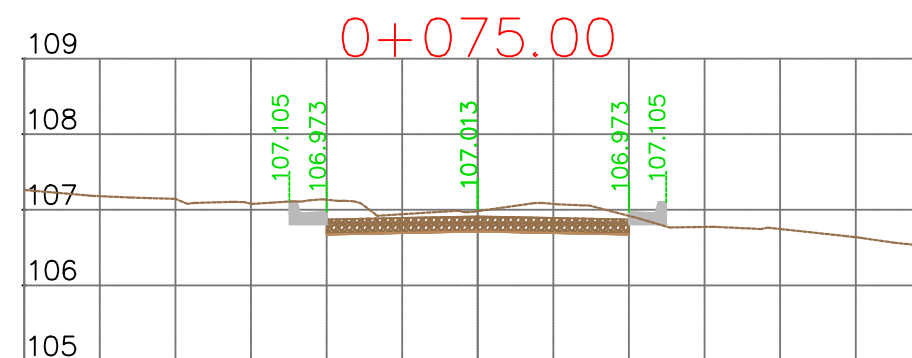
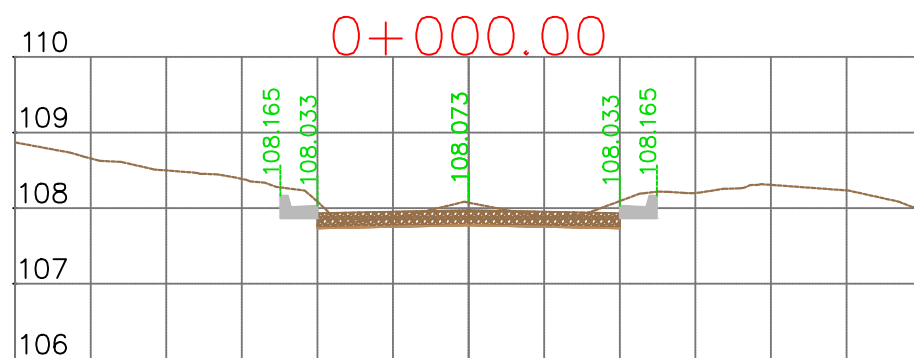

REPUBLIKA E SHQIPËRISË  
BASHKIA E TIRANËS

OBJEKTI: "RIKUALIFIKIMI URBAN I ZONËS  
INFORMALE QË KUFIZOHET NGA RRUGËT  
-SABAUDIN GABRANI -JONUZ RAMA-HAMDI  
CULLHAJ-DAMIAN HIMARIOTI-BARI  
ISHKA-VASFI SAMIMI-ALUSH ELMAZ TAKA."

Projektoi :

Ing.A.JAKOVA  
Ing.G.ISLAMI  
Ing.S.MYRSELI  
Ing.P.SHKURTI

Ark.M.DADO  
Ing.Gjeol.Xh.KASMI  
Ing.Mjedis.E.CALI  
Top.A.BECECI

Projektoi :  
"S&L STUDIO SH.P.K"

Projektim-kupervizion-cosnulence



FAZA

DORËZIM

PROJEKT ZBATIMI

1.0

PROFILE TËRTHORE  
RRUGA RR.ATE STATH MELANI

SHKALLA 1:100

Nr. I FLETËS 001

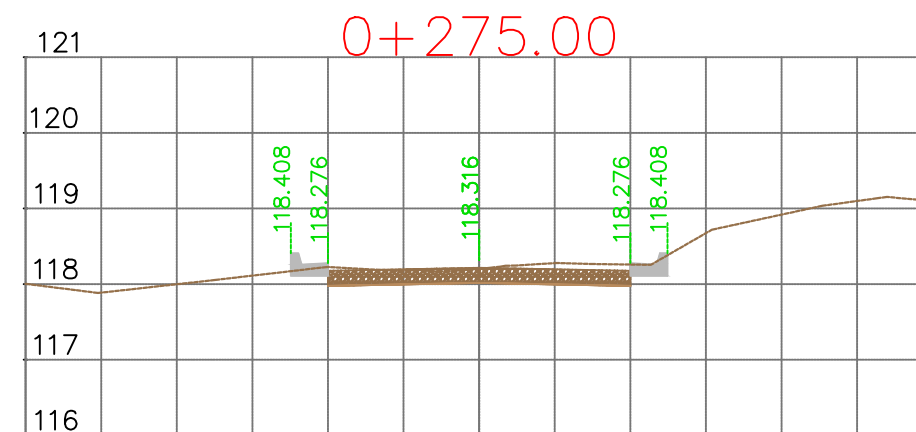
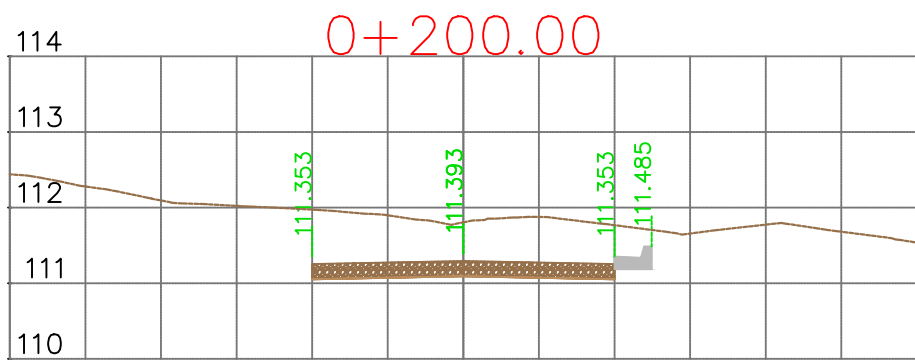
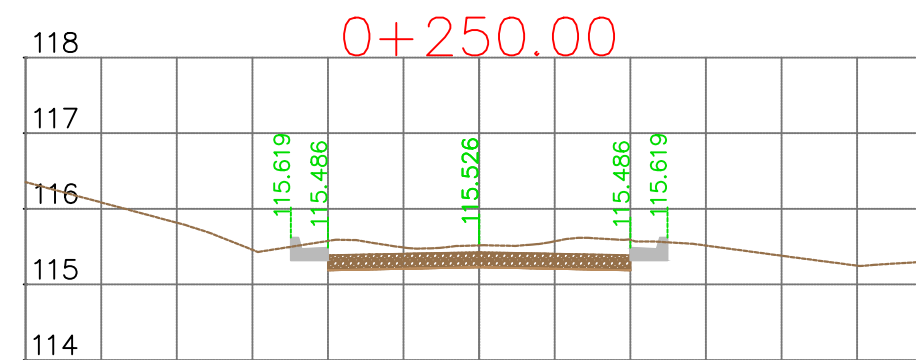
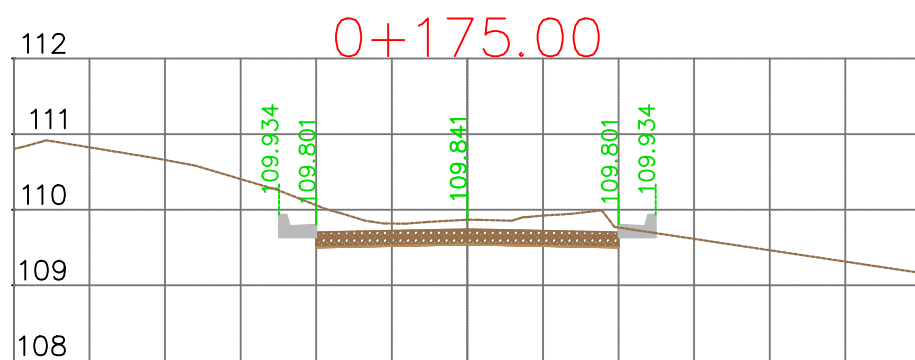
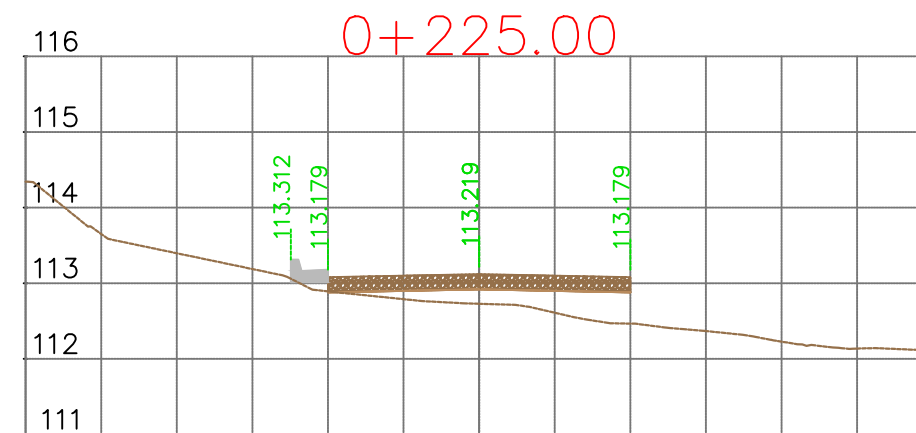
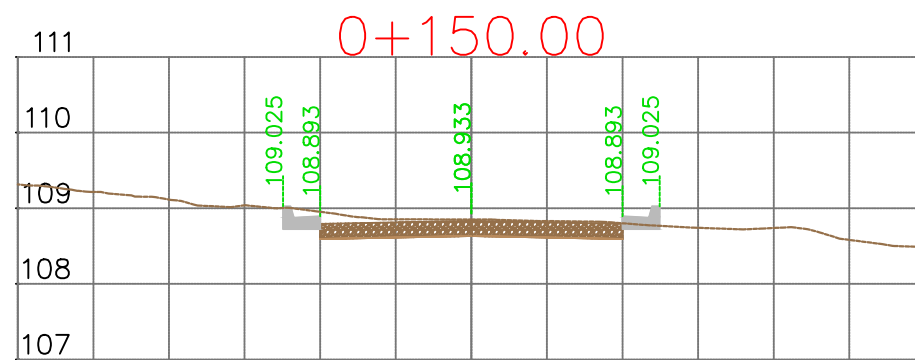

REPUBLIKA E SHQIPËRISË  
BASHKIA E TIRANËS

OBJEKTI: "RIKUALIFIKIMI URBAN I ZONËS  
INFORMALE QË KUFIZOHET NGA RRUGËT  
-SABAUDIN GABRANI -JONUZ RAMA-HAMDI  
CULLHAJ-DAMIAN HIMARIOTI-BARI  
ISHKA-VASFI SAMIMI-ALUSH ELMAZ TAKA."

Projektoi :

Ing.A.JAKOVA  
Ing.G.ISLAMI  
Ing.S.MYRSELI  
Ing.P.SHKURTI

Ark.M.DADO  
Ing.Gjeol.Xh.KASMI  
Ing.Mjedis.E.CALI  
Top.A.BECECI

Projektoi :

"S&L STUDIO SH.P.K"

Projektim-kupervizion-cosnulence



FAZA

DORËZIM

PROJEKT ZBATIMI

1.0

PROFILE TËRTHORE  
RRUGA RR.ATE STATH MELANI

SHKALLA 1:100

Nr. I FLETËS 002

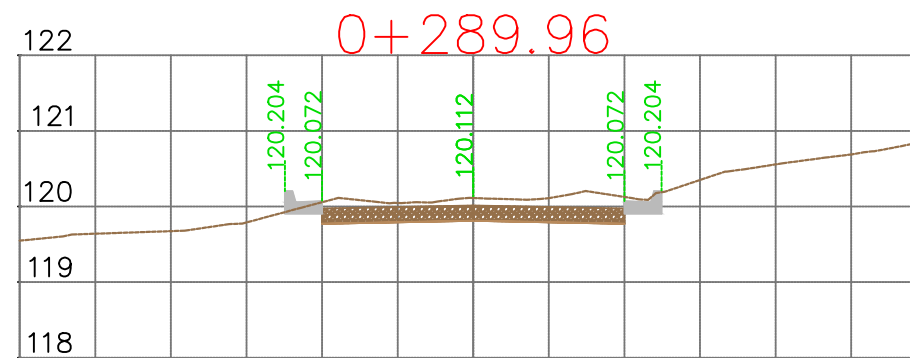

REPUBLIKA E SHQIPËRISË  
BASHKIA E TIRANËS

OBJEKTI: "RIKUALIFIKIMI URBAN I ZONËS  
INFORMALE QË KUFIZOHET NGA RRUGËT  
-SABAUDIN GABRANI -JONUZ RAMA-HAMDI  
CULLHAJ-DAMIAN HIMARIOTI-BARI  
ISHKA-VASFI SAMIMI-ALUSH ELMAZ TAKA."

Projektoi :

Ing.A.JAKOVA  
Ing.G.ISLAMI  
Ing.S.MYRSELI  
Ing.P.SHKURTI

Ark.M.DADO  
Ing.Gjeol.Xh.KASMI  
Ing.Mjedis.E.CALI  
Top.A.BECECI

Projektoi :

**"S&L STUDIO SH.P.K"**

Projektim-kupervizion-cosnulence



FAZA

DORËZIM

PROJEKT ZBATIMI

1.0

PROFILE TËRTHORE  
RRUGA RR.ATE STATH MELANI

SHKALLA 1:100

Nr. I FLETËS 003

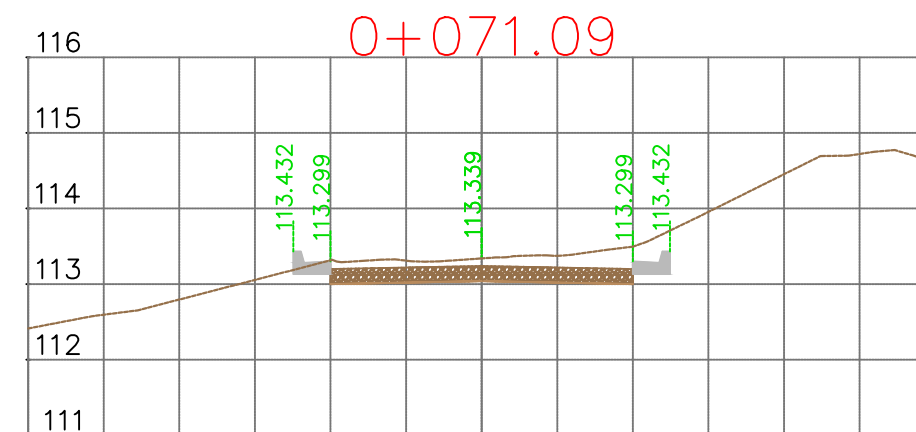
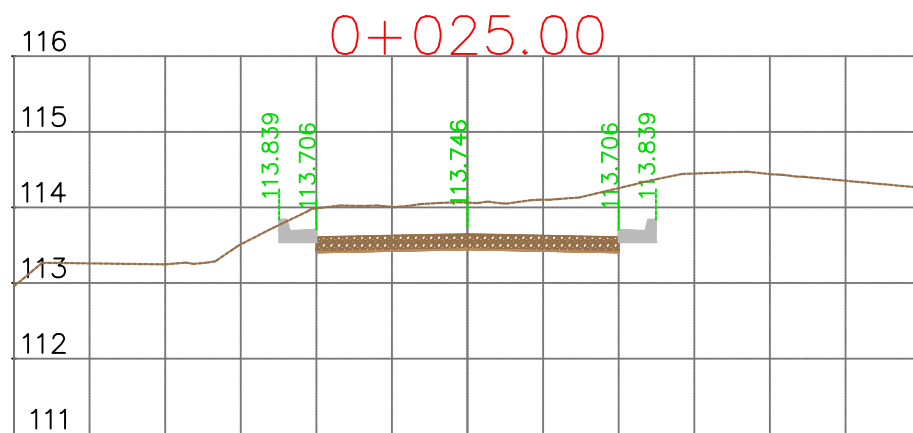
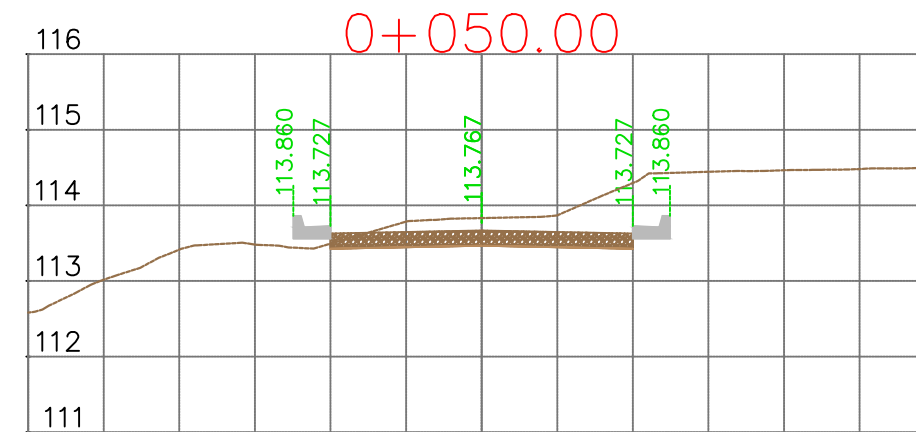
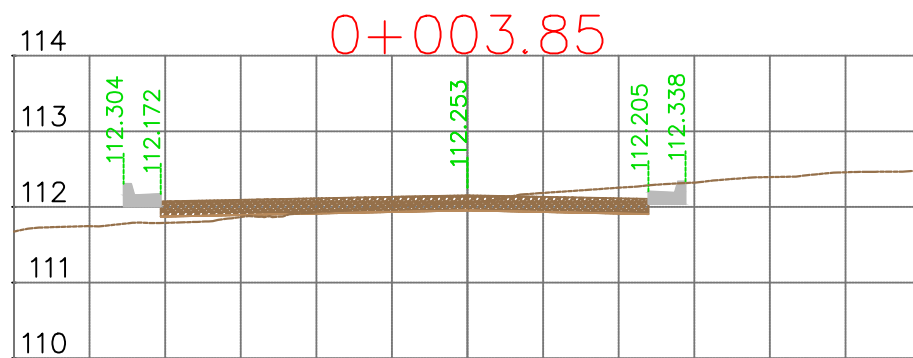

REPUBLIKA E SHQIPËRISË  
BASHKIA E TIRANËS

OBJEKTI: "RIKUALIFIKIMI URBAN I ZONËS  
INFORMALE QË KUFIZOHET NGA RRUGËT  
-SABAUDIN GABRANI -JONUZ RAMA-HAMDI  
CULLHAJ-DAMIAN HIMARIOTI-BARI  
ISHKA-VASFI SAMIMI-ALUSH ELMAZ TAKA."

Projektoi :

Ing.A.JAKOVA  
Ing.G.ISLAMI  
Ing.S.MYRSELI  
Ing.P.SHKURTI

Ark.M.DADO  
Ing.Gjeol.Xh.KASMI  
Ing.Mjedis.E.CALI  
Top.A.BECECI

Projektoi :  
"S&L STUDIO SH.P.K"

Projektim-kupervizion-cosnulence



FAZA

DORËZIM

PROJEKT ZBATIMI

1.0

PROFILE TËRTHORE  
RRUGA RR.ATE STATH MELANI

SHKALLA 1:100

Nr. I FLETËS 004

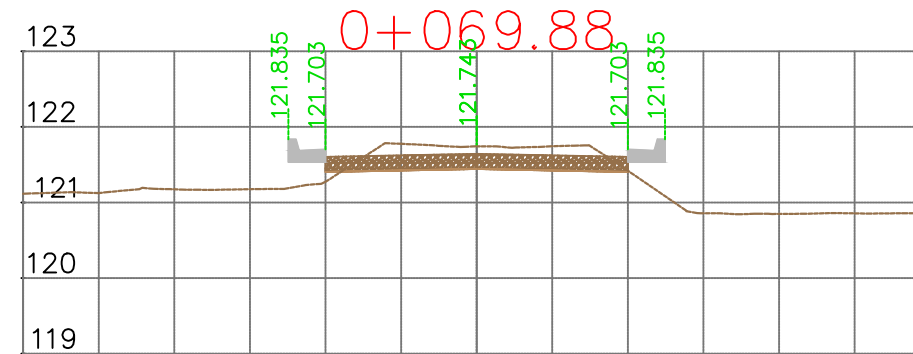
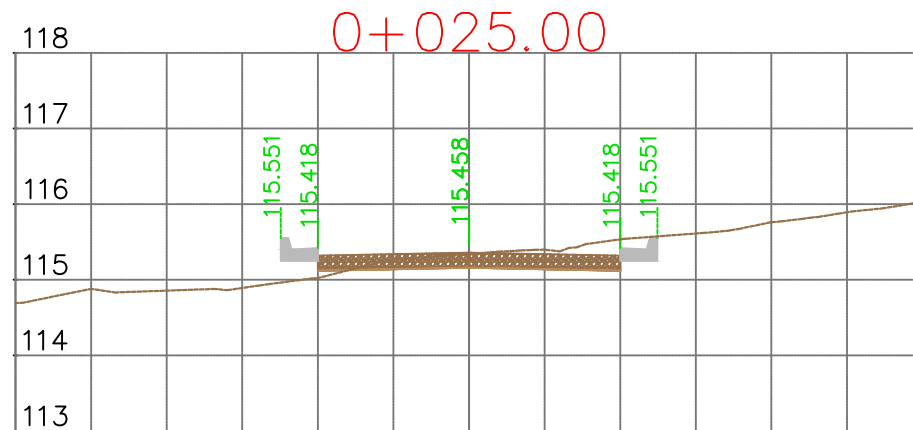
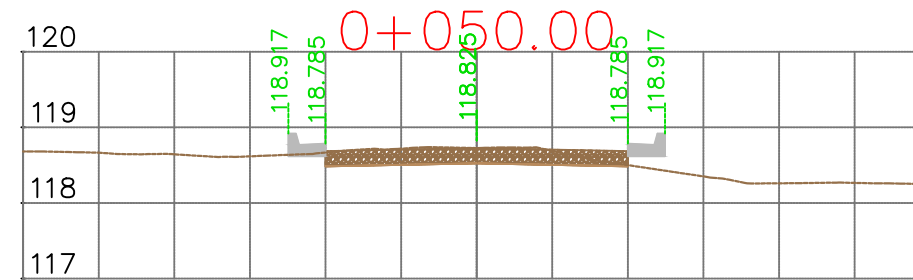
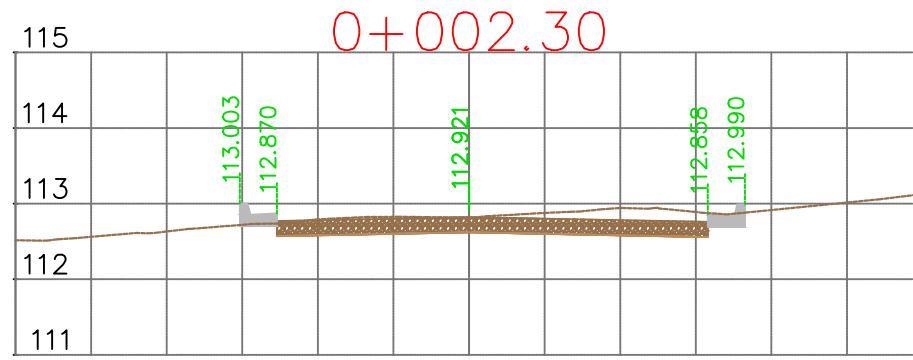

REPUBLIKA E SHQIPËRISË  
BASHKIA E TIRANËS

OBJEKTI: "RIKUALIFIKIMI URBAN I ZONËS  
INFORMALE QË KUFIZOHET NGA RRUGËT  
-SABAUDIN GABRANI -JONUZ RAMA-HAMDI  
CULLHAJ-DAMIAN HIMARIOTI-BARI  
ISHKA-VASFI SAMIMI-ALUSH ELMAZ TAKA."

Projektoi :

Ing.A.JAKOVA  
Ing.G.ISLAMI  
Ing.S.MYRSELI  
Ing.P.SHKURTI

Ark.M.DADO  
Ing.Gjeol.Xh.KASMI  
Ing.Mjedis.E.CALI  
Top.A.BECECI

Projektoi :  
"S&L STUDIO SH.P.K"

Projektim-kupervizion-cosnulence



FAZA

DORËZIM

PROJEKT ZBATIMI

1.0

PROFILE TËRTHORE  
RRUGA RR.ATE STATH MELANI

SHKALLA 1:100

Nr. I FLETËS 005



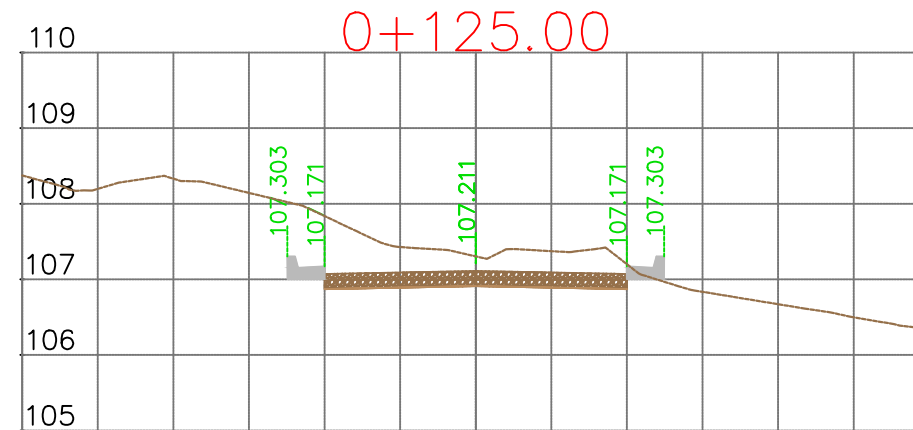
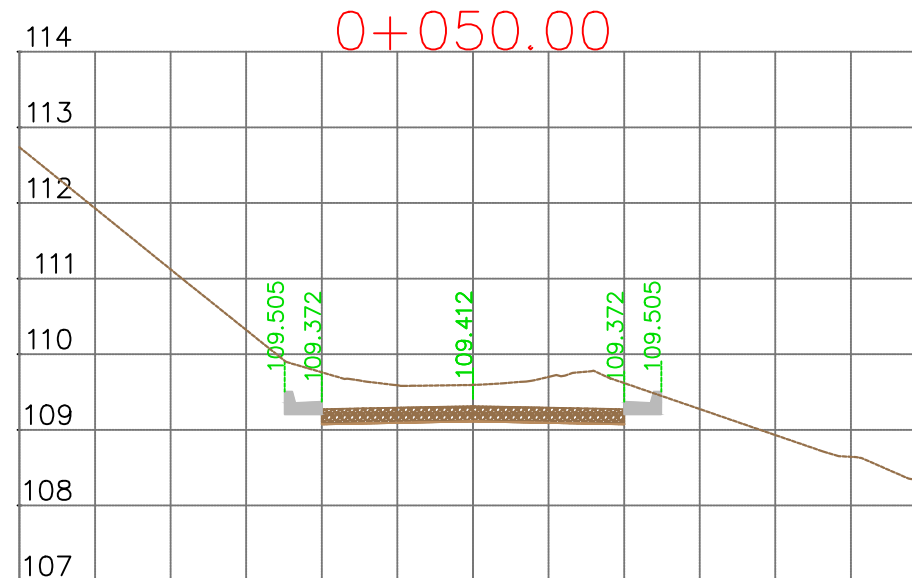
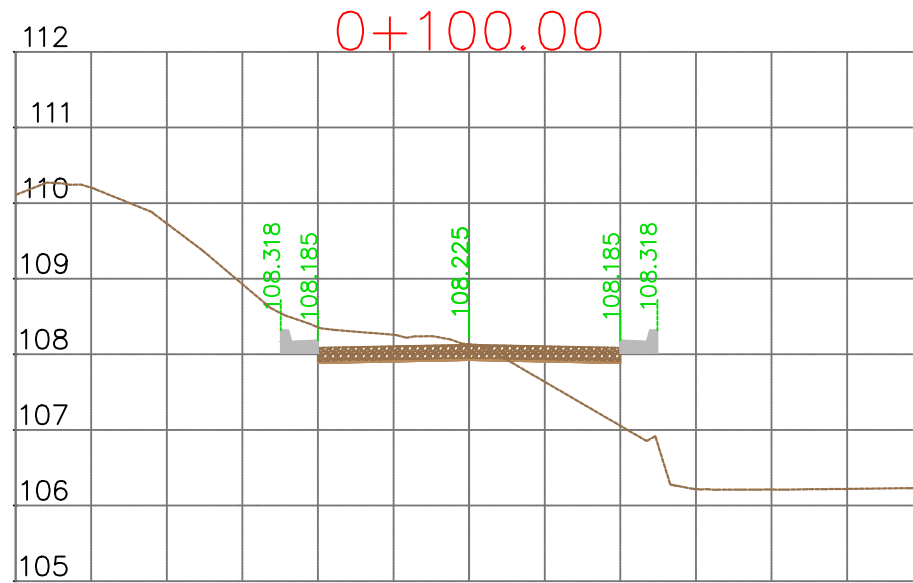
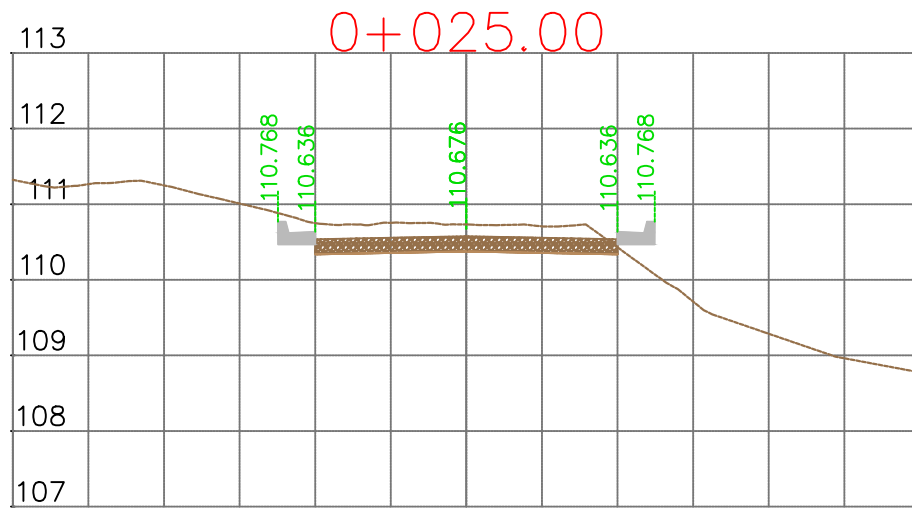
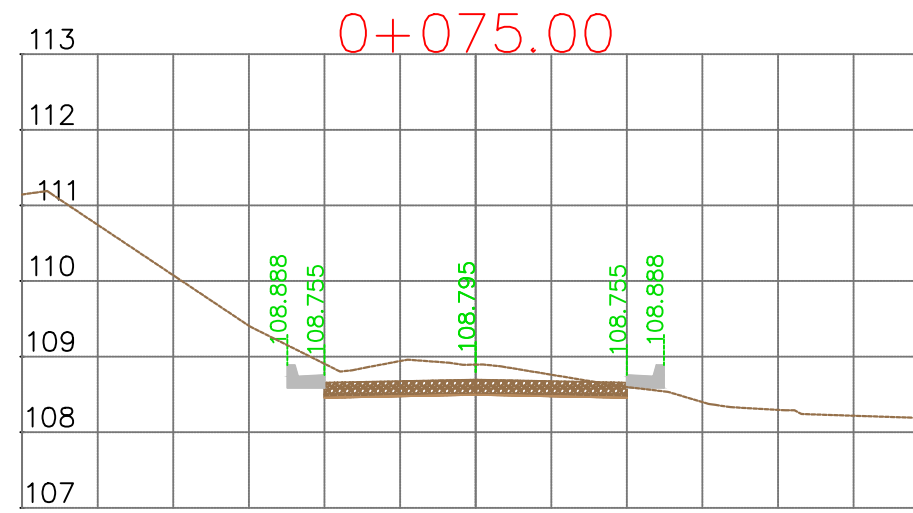
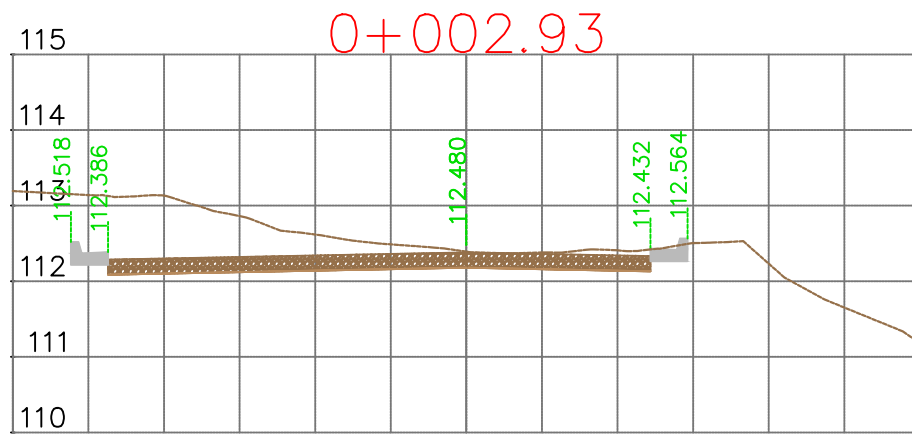

REPUBLIKA E SHQIPËRISË  
BASHKIA E TIRANËS

OBJEKTI: "RIKUALIFIKIMI URBAN I ZONËS  
INFORMALE QË KUFIZOHET NGA RRUGËT  
-SABAUDIN GABRANI -JONUZ RAMA-HAMDI  
CULLHAJ-DAMIAN HIMARIOTI-BARI  
ISHKA-VASFI SAMIMI-ALUSH ELMAZ TAKA."

Projektoi :

Ing.A.JAKOVA  
Ing.G.ISLAMI  
Ing.S.MYRSELI  
Ing.P.SHKURTI

Ark.M.DADO  
Ing.Gjeol.Xh.KASMI  
Ing.Mjedis.E.CALI  
Top.A.BECECI

Projektoi :

"S&L STUDIO SH.P.K"

Projektim-kupervizion-cosnulence



FAZA

DORËZIM

PROJEKT ZBATIMI

1.0

PROFILE TËRTHORE  
RRUGA RR.ATE STATH MELANI

SHKALLA 1:100

Nr. I FLETËS 006

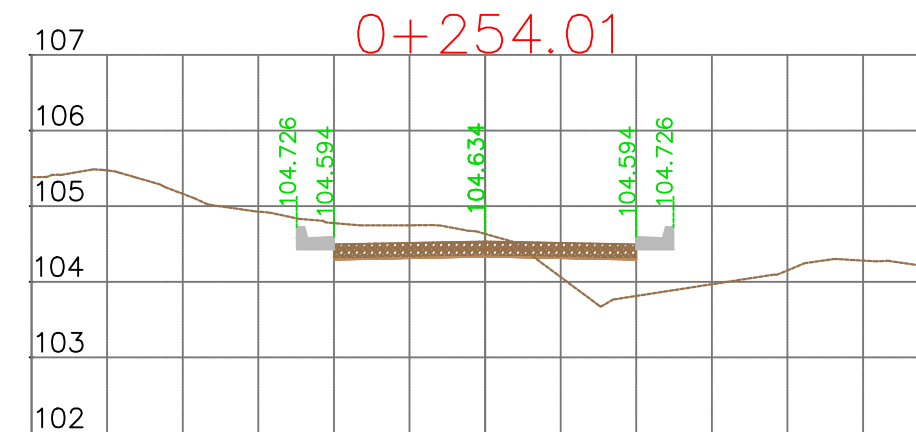
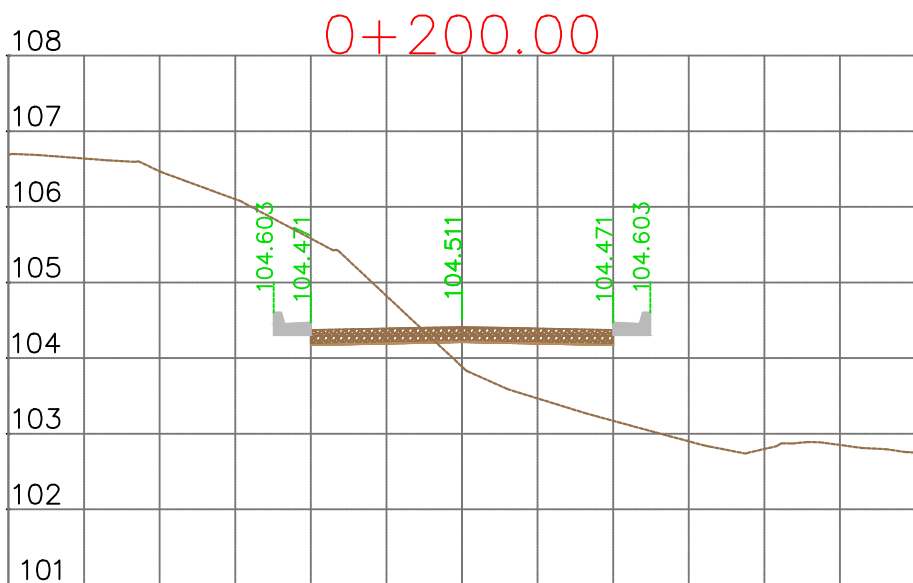
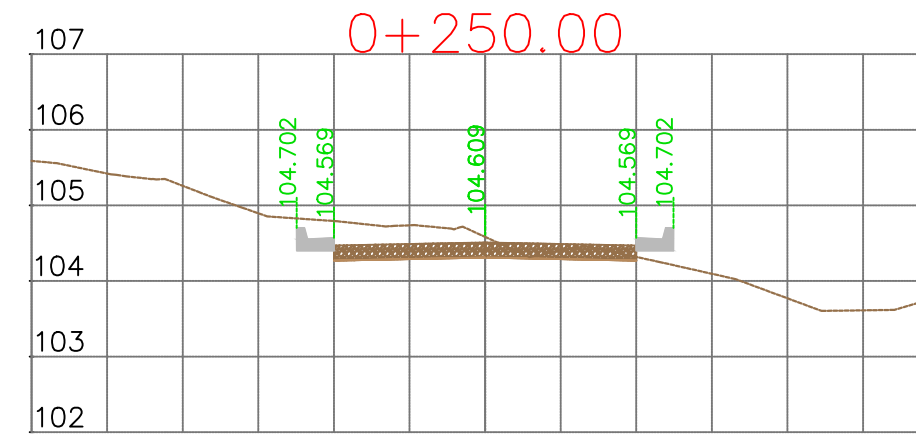
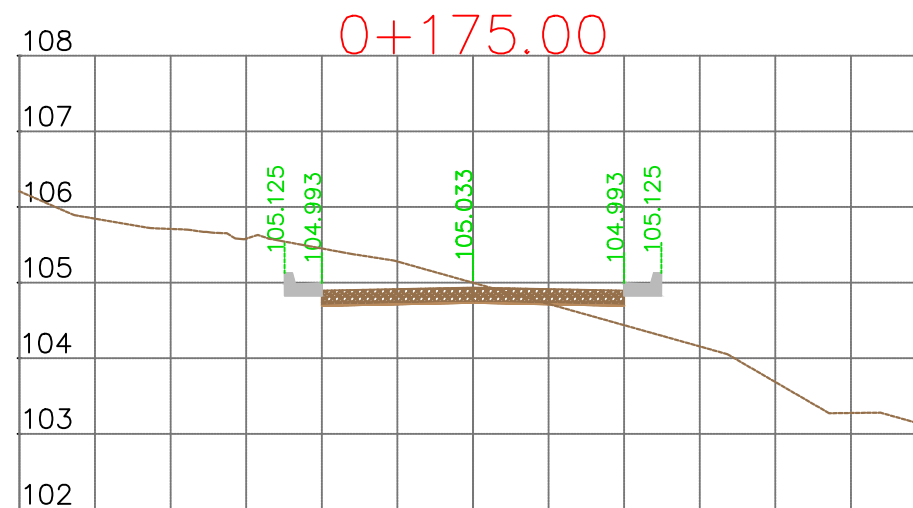
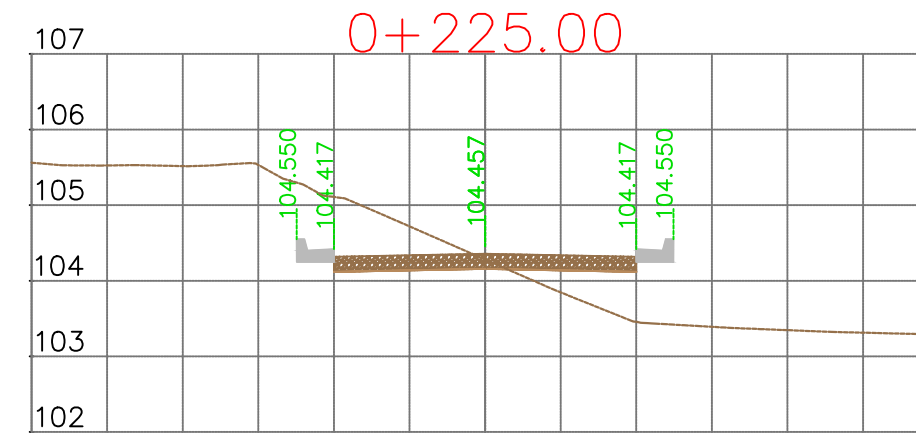

REPUBLIKA E SHQIPËRISË  
BASHKIA E TIRANËS

OBJEKTI: "RIKUALIFIKIMI URBAN I ZONËS  
INFORMALE QË KUFIZOHET NGA RRUGËT  
-SABAUDIN GABRANI -JONUZ RAMA-HAMDI  
CULLHAJ-DAMIAN HIMARIOTI-BARI  
ISHKA-VASFI SAMIMI-ALUSH ELMAZ TAKA."

Projektoi :

Ing.A.JAKOVA  
Ing.G.ISLAMI  
Ing.S.MYRSELI  
Ing.P.SHKURTI

Ark.M.DADO  
Ing.Gjeol.Xh.KASMI  
Ing.Mjedis.E.CALI  
Top.A.BECECI

Projektoi :  
"S&L STUDIO SH.P.K"

Projektim-kupervizion-cosnulence



FAZA

DORËZIM

PROJEKT ZBATIMI

1.0

PROFILE TËRTHORE  
RRUGA RR.ATE STATH MELANI

SHKALLA 1:100

Nr. I FLETËS 007

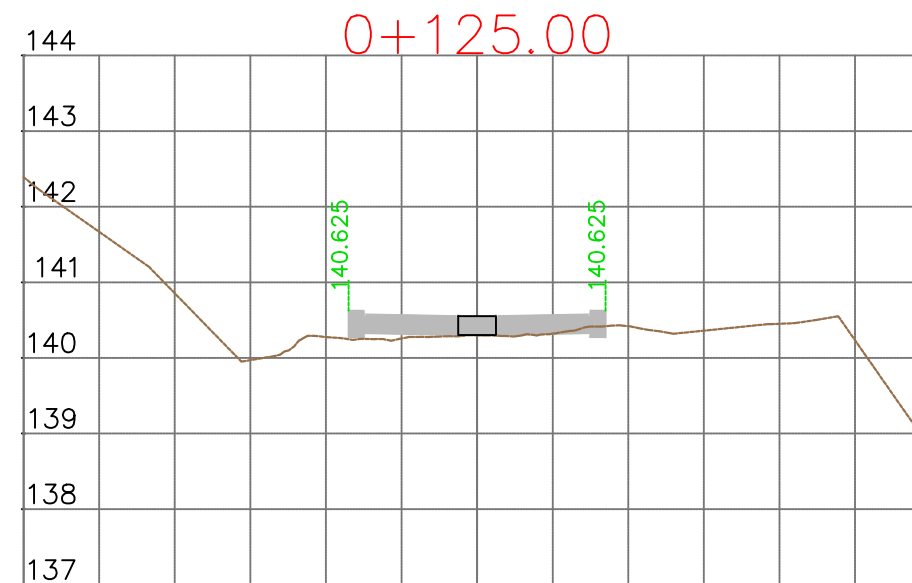
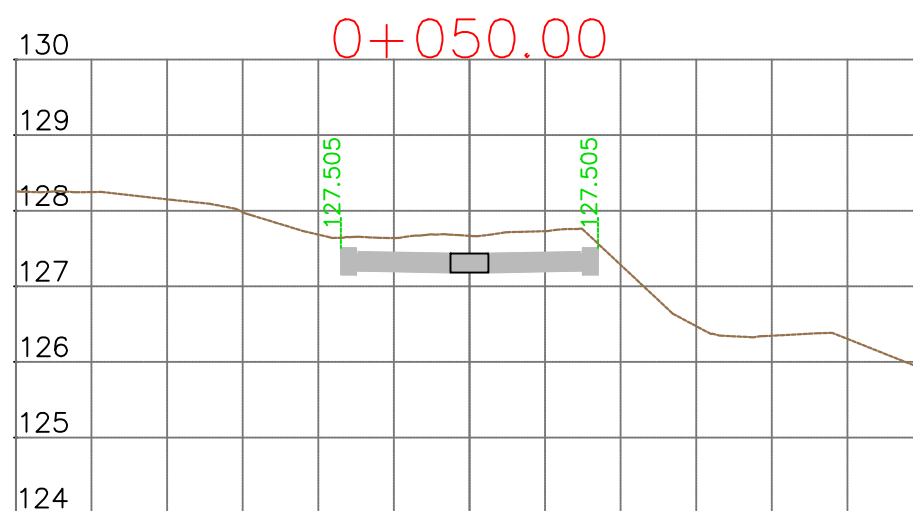
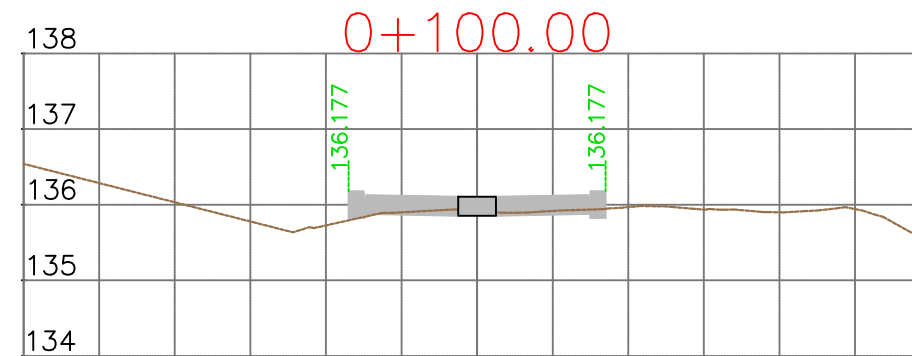
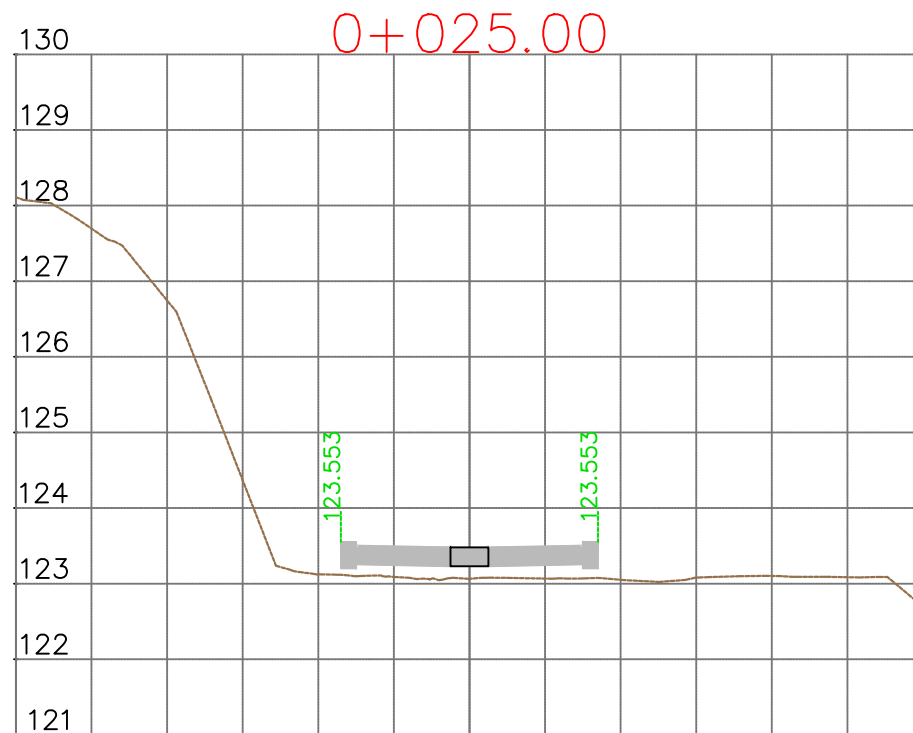
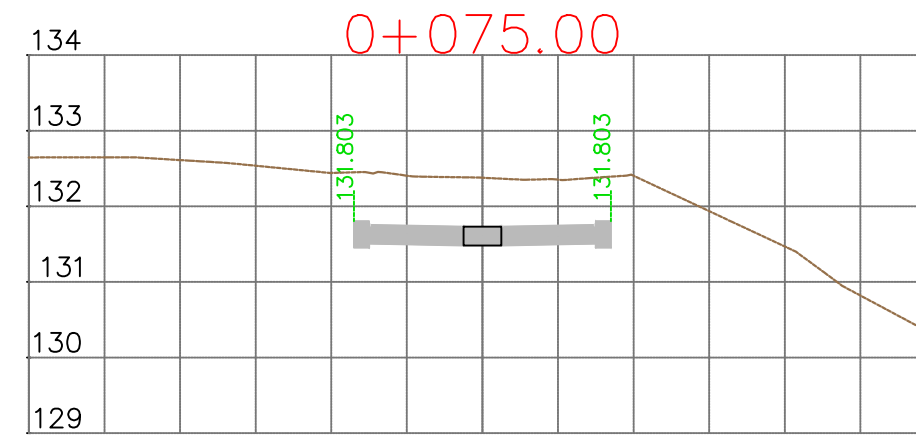
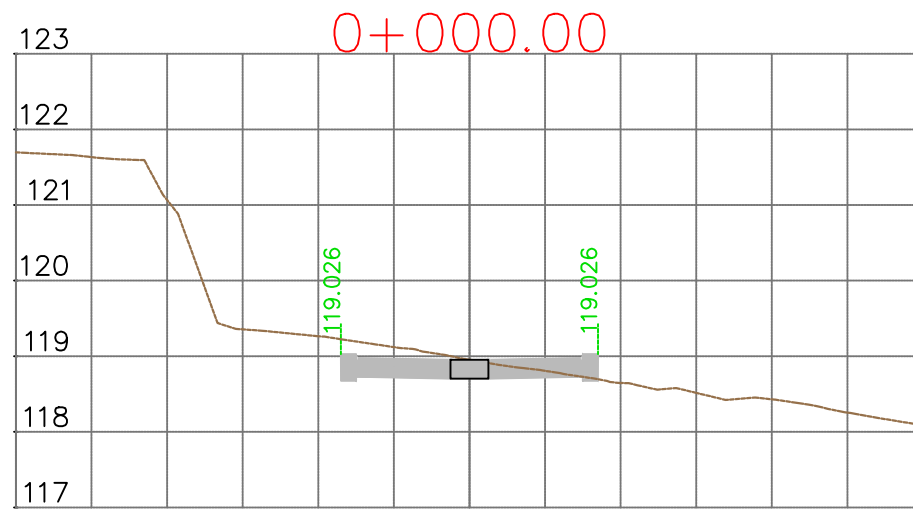

REPUBLIKA E SHQIPËRISË  
BASHKIA E TIRANËS

OBJEKTI: "RIKUALIFIKIMI URBAN I ZONËS  
INFORMALE QË KUFIZOHET NGA RRUGËT  
-SABAUDIN GABRANI -JONUZ RAMA-HAMDI  
CULLHAJ-DAMIAN HIMARIOTI-BARI  
ISHKA-VASFI SAMIMI-ALUSH ELMAZ TAKA."

Projektoi :

Ing.A.JAKOVA  
Ing.G.ISLAMI  
Ing.S.MYRSELI  
Ing.P.SHKURTI

Ark.M.DADO  
Ing.Gjeol.Xh.KASMI  
Ing.Mjedis.E.CALI  
Top.A.BECECI

Projektoi :

"S&L STUDIO SH.P.K"

Projektim-kupervizion-cosnulence



FAZA

DORËZIM

PROJEKT ZBATIMI

1.0

PROFILE TËRTHORE  
RRUGA RR.DAMIAN HIMARIOTI

SHKALLA 1:100

Nr. I FLETËS 001

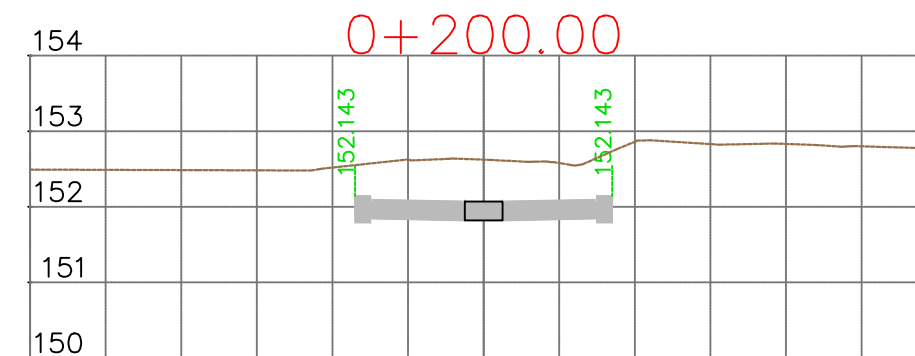
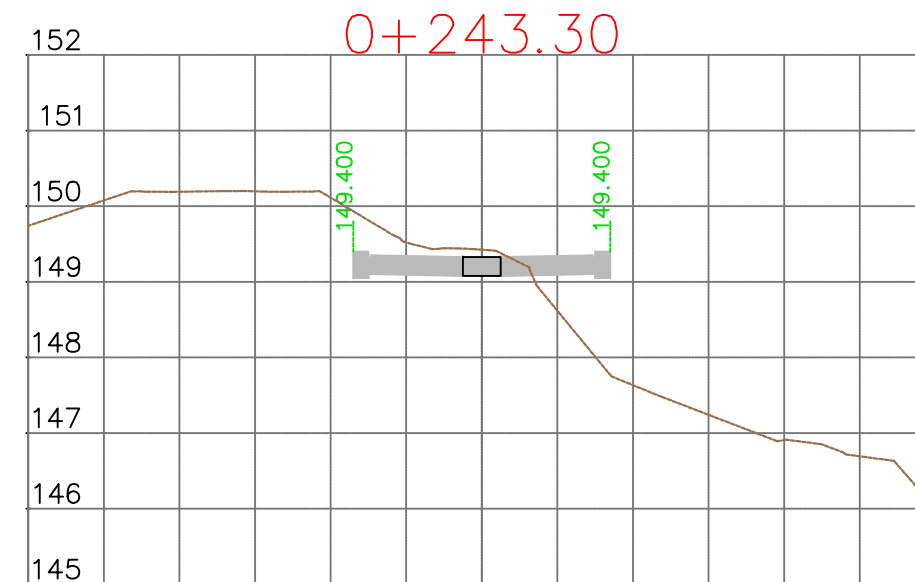
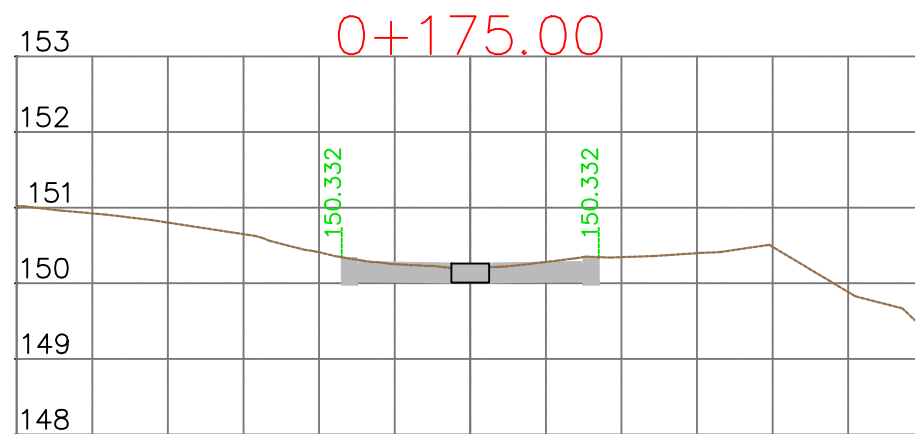
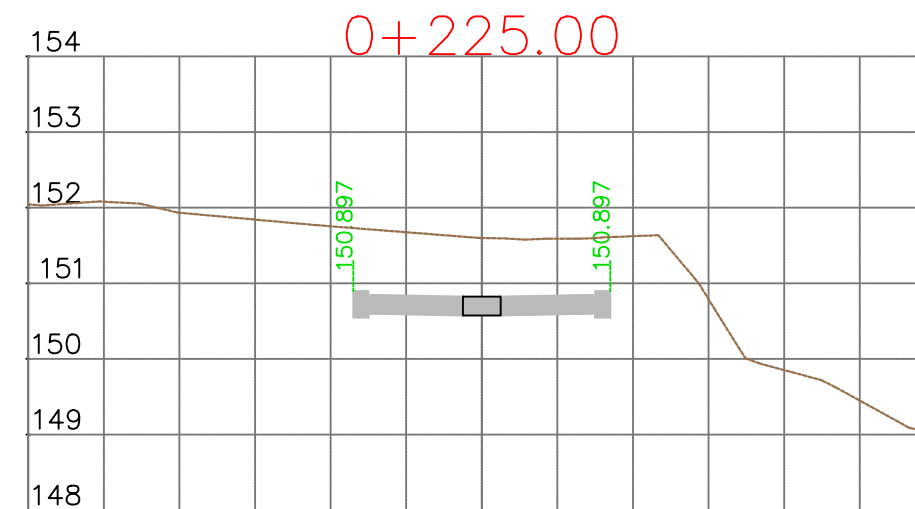
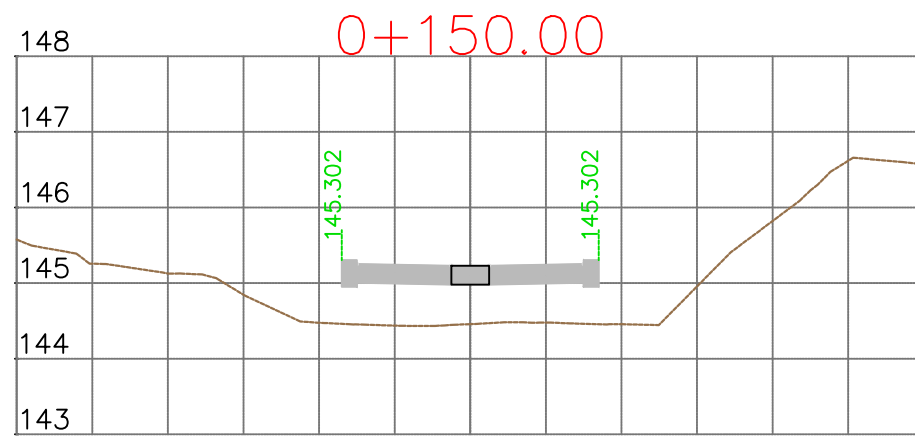

REPUBLIKA E SHQIPËRISË  
BASHKIA E TIRANËS

OBJEKTI: "RIKUALIFIKIMI URBAN I ZONËS  
INFORMALE QË KUFIZOHET NGA RRUGËT  
-SABAUDIN GABRANI -JONUZ RAMA-HAMDI  
CULLHAJ-DAMIAN HIMARIOTI-BARI  
ISHKA-VASFI SAMIMI-ALUSH ELMAZ TAKA."

Projektoi :

Ing.A.JAKOVA  
Ing.G.ISLAMI  
Ing.S.MYRSELI  
Ing.P.SHKURTI

Ark.M.DADO  
Ing.Gjeol.Xh.KASMI  
Ing.Mjedis.E.CALI  
Top.A.BECECI

Projektoi :

"S&L STUDIO SH.P.K"

Projektim-kupervizion-cosnulence



FAZA

DORËZIM

PROJEKT ZBATIMI

1.0

PROFILE TËRTHORE  
RRUGA RR.DAMIAN HIMARIOTI

SHKALLA 1:100

Nr. I FLETËS 002

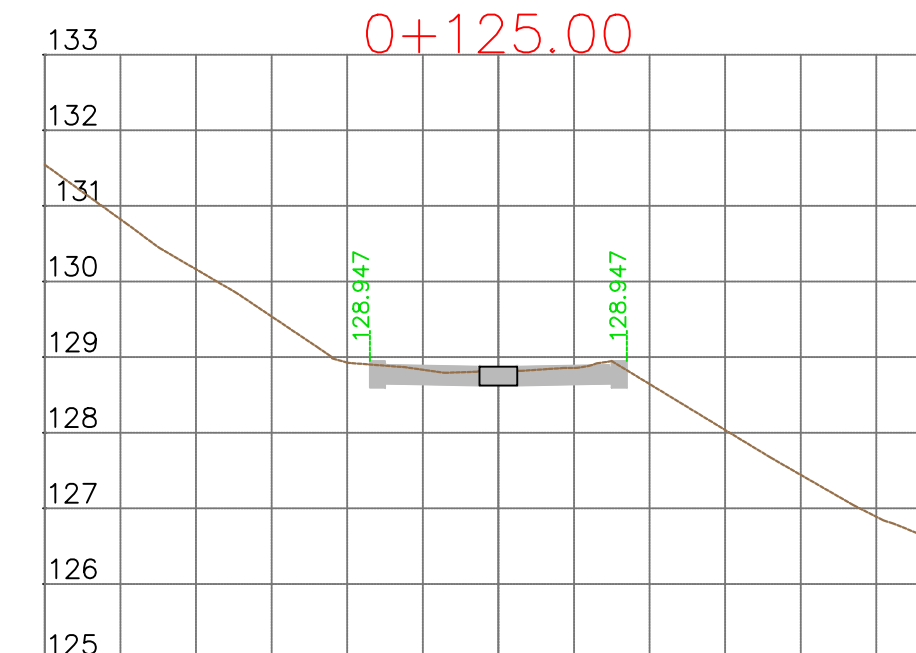
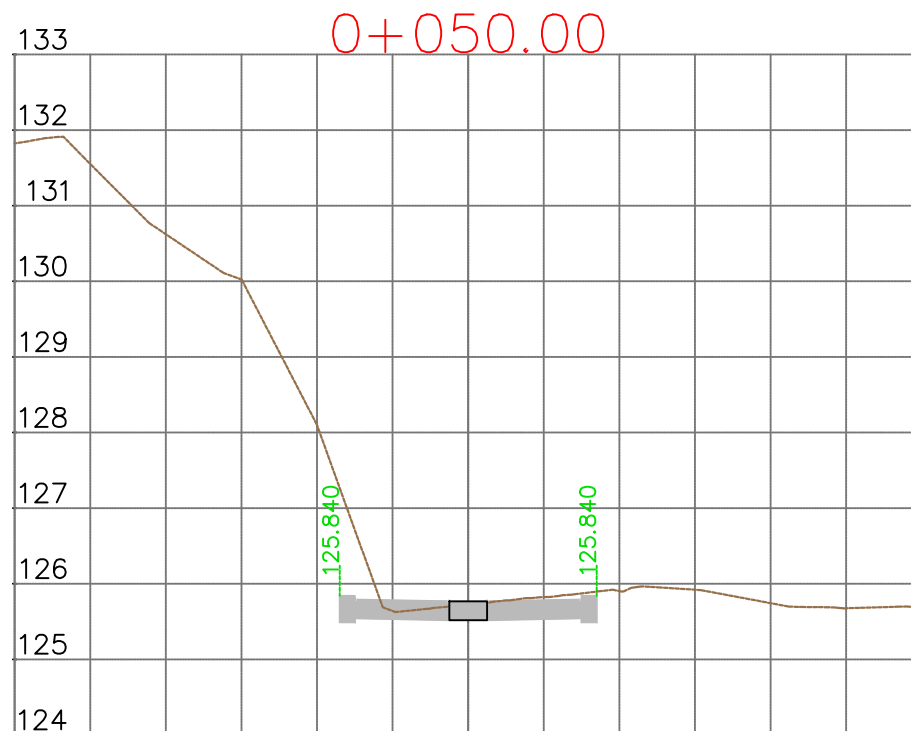
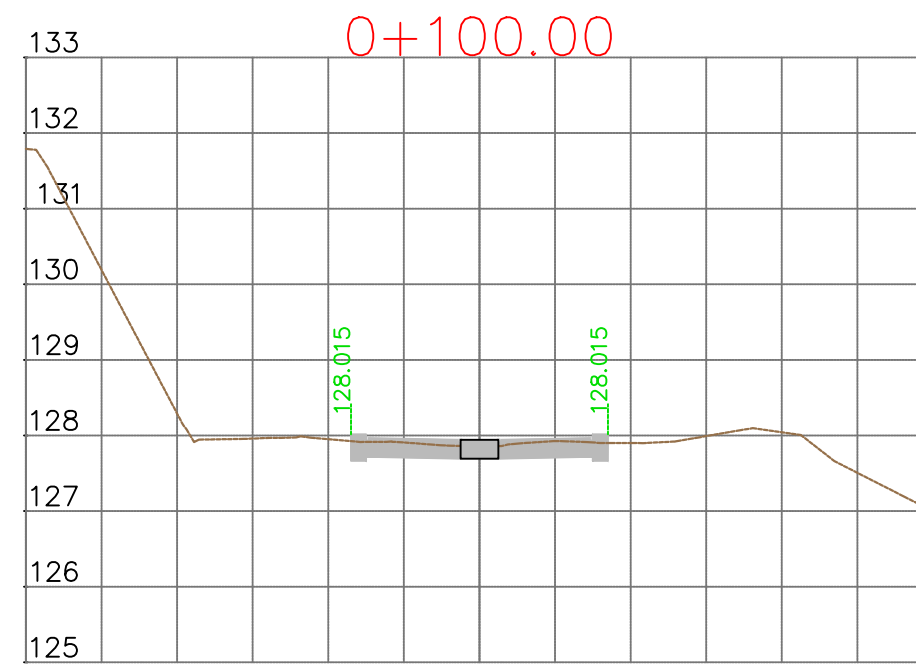
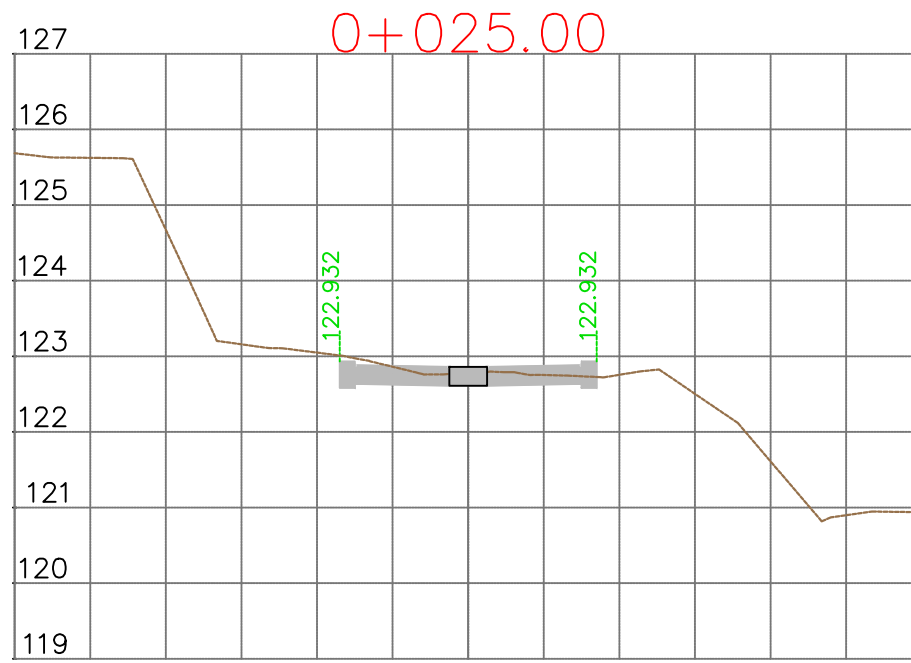
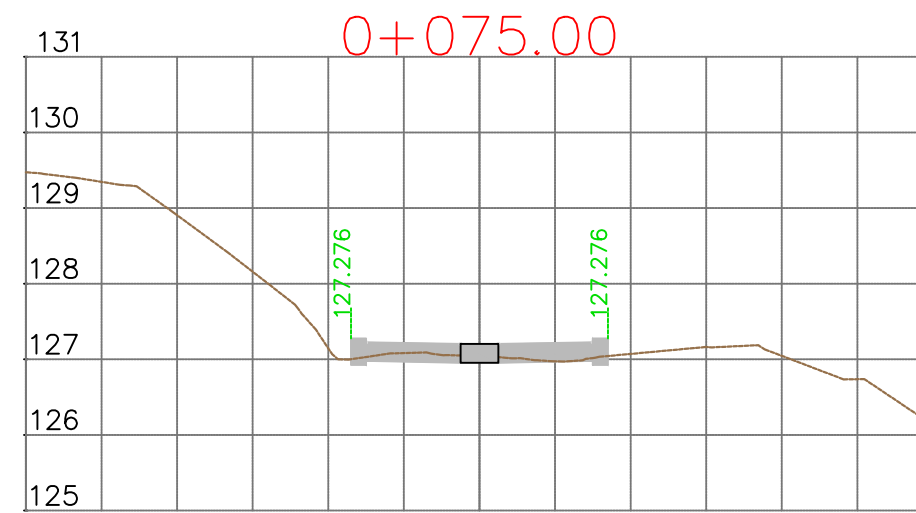
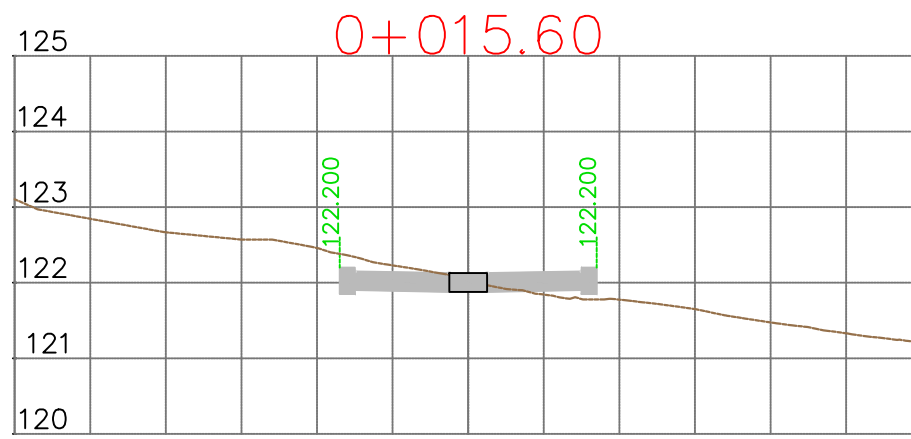

REPUBLIKA E SHQIPËRISË  
BASHKIA E TIRANËS

OBJEKTI: "RIKUALIFIKIMI URBAN I ZONËS  
INFORMALE QË KUFIZOHET NGA RRUGËT  
-SABAUDIN GABRANI -JONUZ RAMA-HAMDI  
CULLHAJ-DAMIAN HIMARIOTI-BARI  
ISHKA-VASFI SAMIMI-ALUSH ELMAZ TAKA."

Projektoi :

Ing.A.JAKOVA  
Ing.G.ISLAMI  
Ing.S.MYRSELI  
Ing.P.SHKURTI

Ark.M.DADO  
Ing.Gjeol.Xh.KASMI  
Ing.Mjedis.E.CALI  
Top.A.BECECI

Projektoi :  
"S&L STUDIO SH.P.K"

Projektim-kupervizion-cosnulence



FAZA

DORËZIM

PROJEKT ZBATIMI

1.0

PROFILE TËRTHORE  
RRUGA RR.KROI BANES

SHKALLA 1:100

Nr. I FLETËS 001

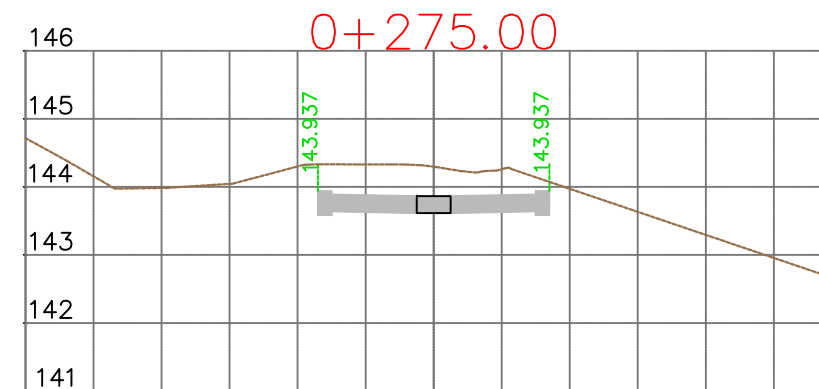
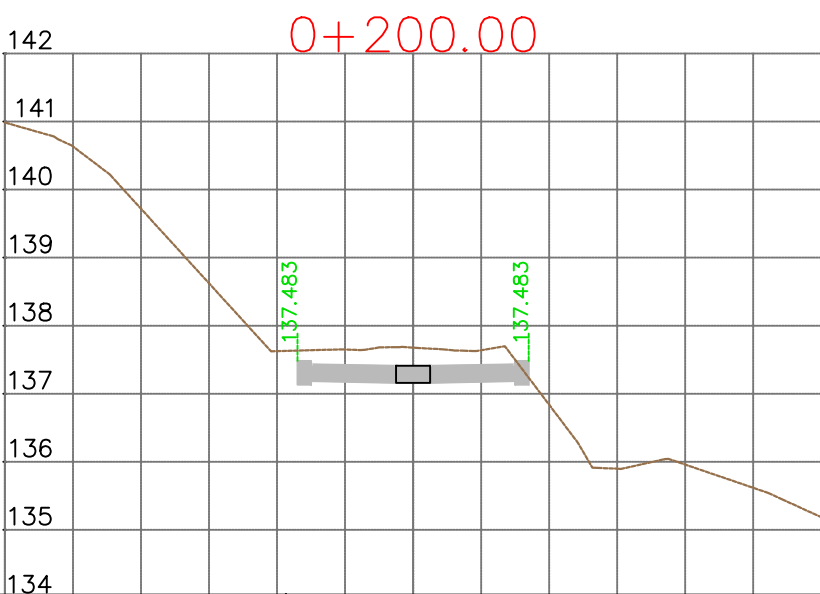
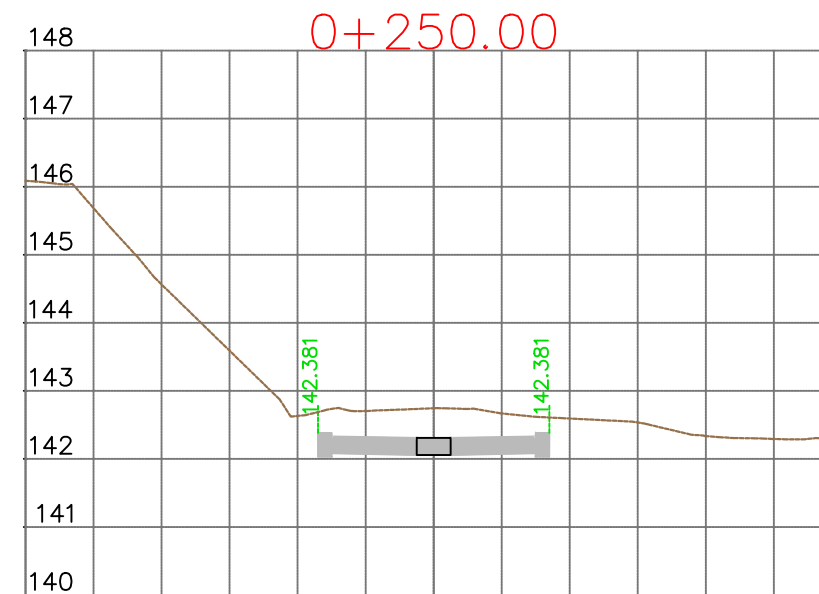
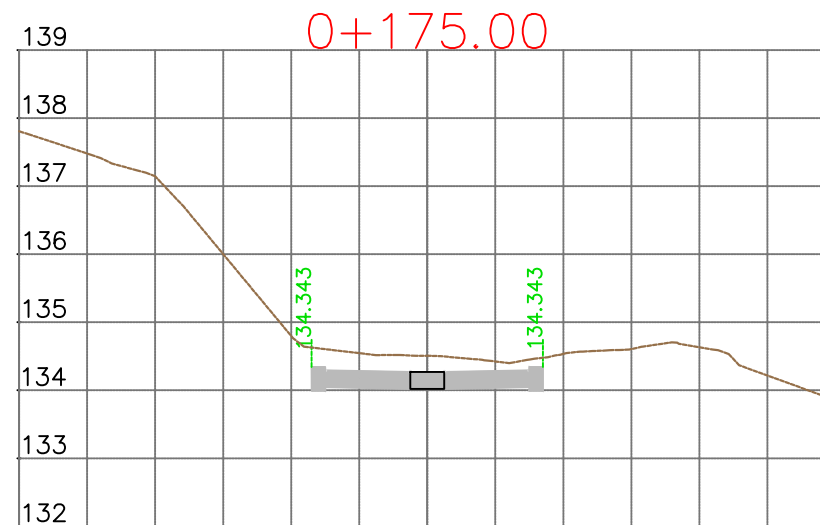
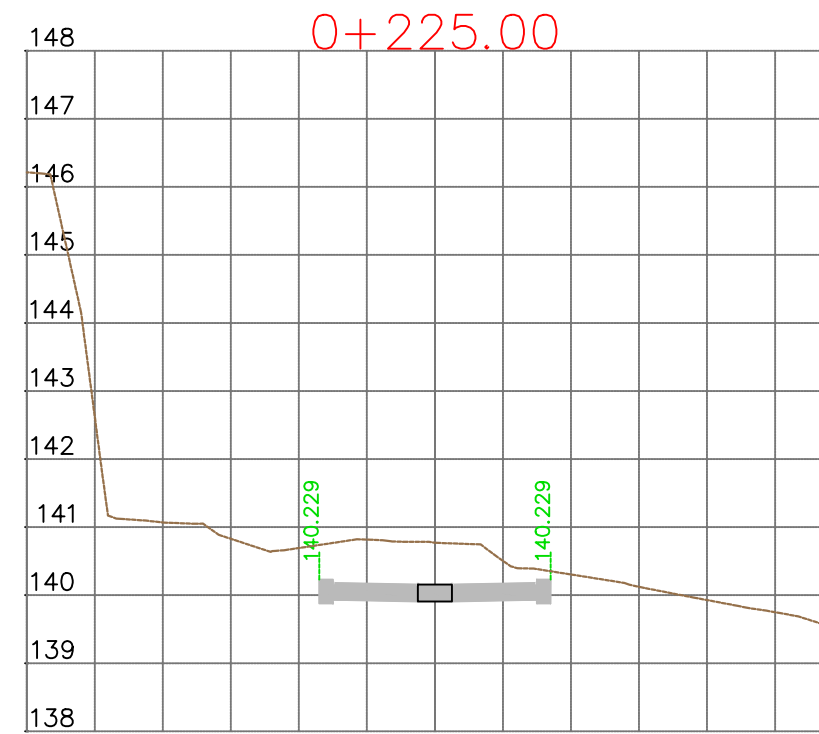
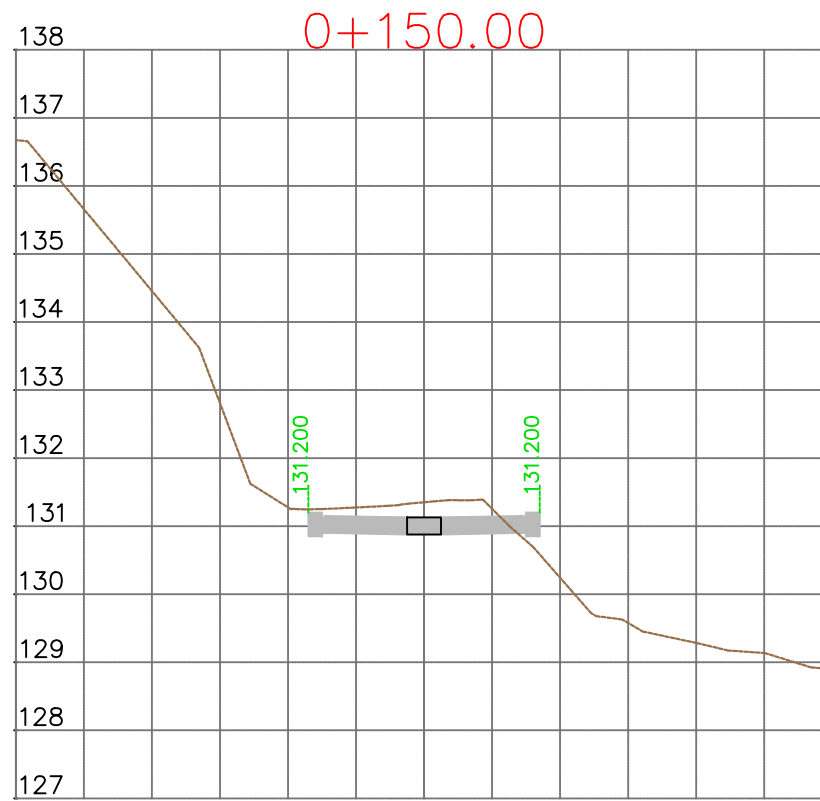

REPUBLIKA E SHQIPËRISË  
BASHKIA E TIRANËS

OBJEKTI: "RIKUALIFIKIMI URBAN I ZONËS  
INFORMALE QË KUFIZOHET NGA RRUGËT  
-SABAUDIN GABRANI -JONUZ RAMA-HAMDI  
CULLHAJ-DAMIAN HIMARIOTI-BARI  
ISHKA-VASFI SAMIMI-ALUSH ELMAZ TAKA."

Projektoi :

Ing.A.JAKOVA  
Ing.G.ISLAMI  
Ing.S.MYRSELI  
Ing.P.SHKURTI

Ark.M.DADO  
Ing.Gjeol.Xh.KASMI  
Ing.Mjedis.E.CALI  
Top.A.BECECI

Projektoi :

"S&L STUDIO SH.P.K"

Projektim-kupervizion-cosnulence



FAZA

DORËZIM

PROJEKT ZBATIMI

1.0

PROFILE TËRTHORE  
RRUGA RR.KROI BANES

SHKALLA 1:100

Nr. I FLETËS 002

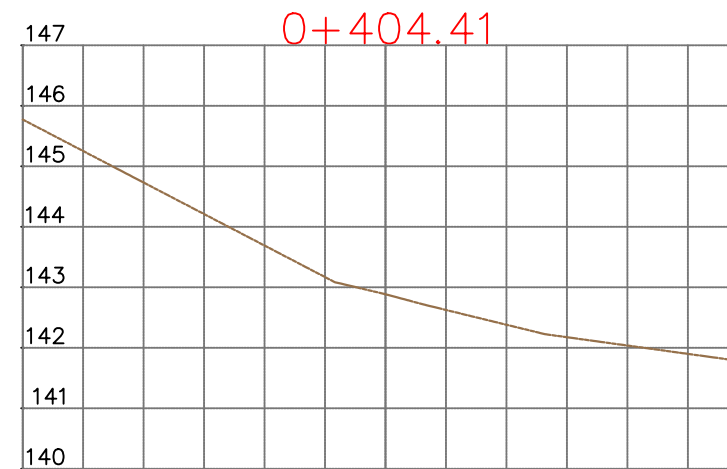
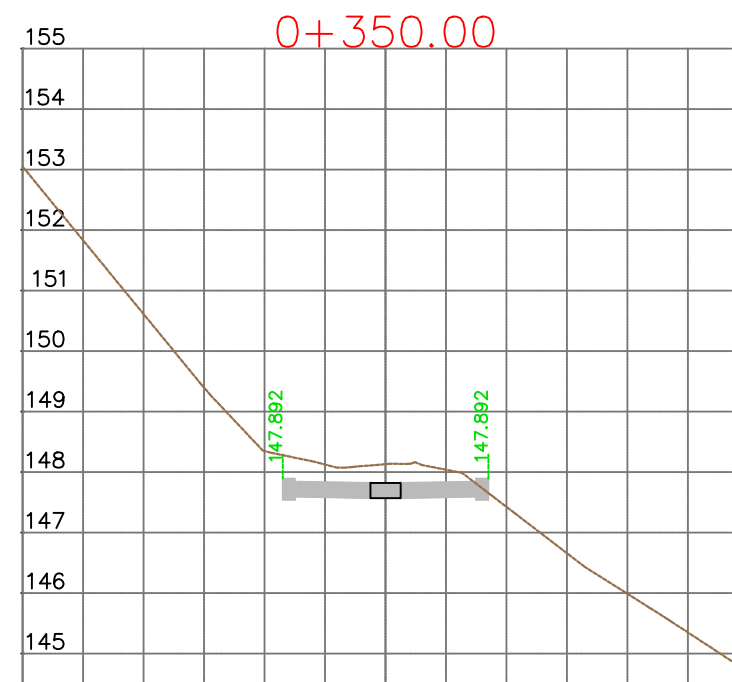
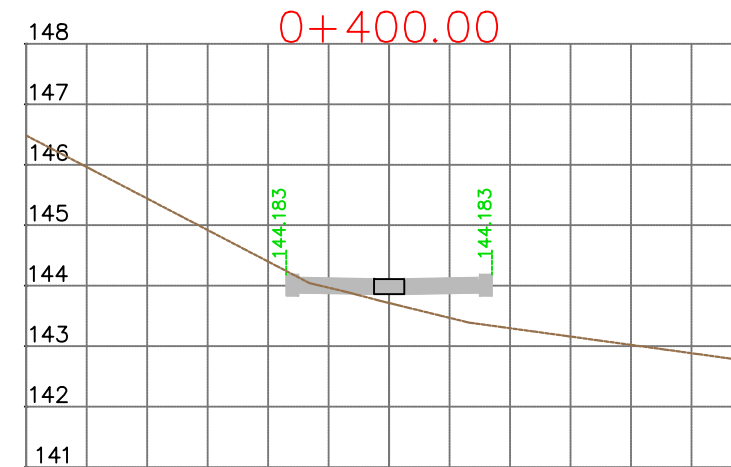
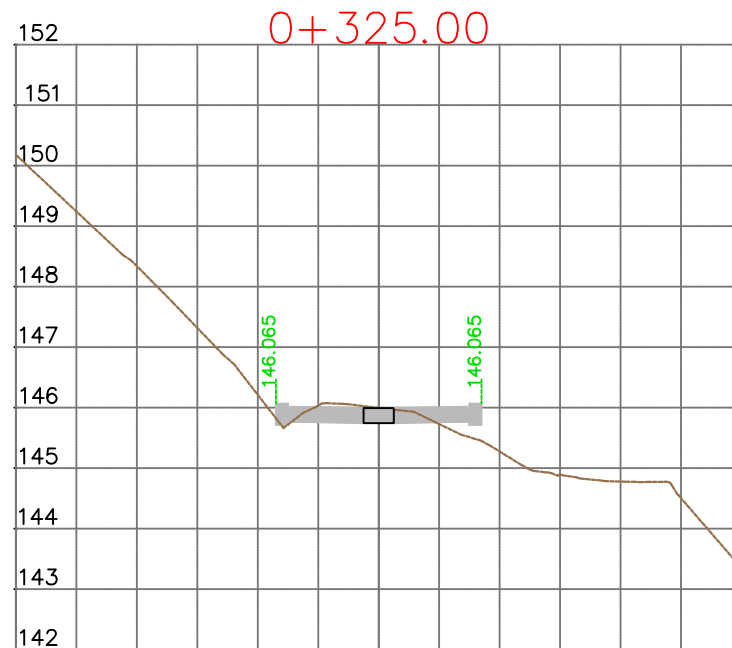
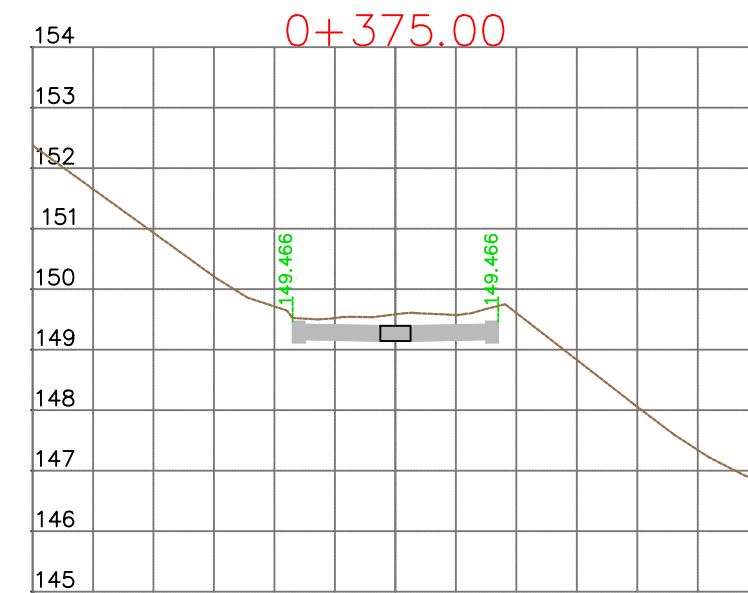
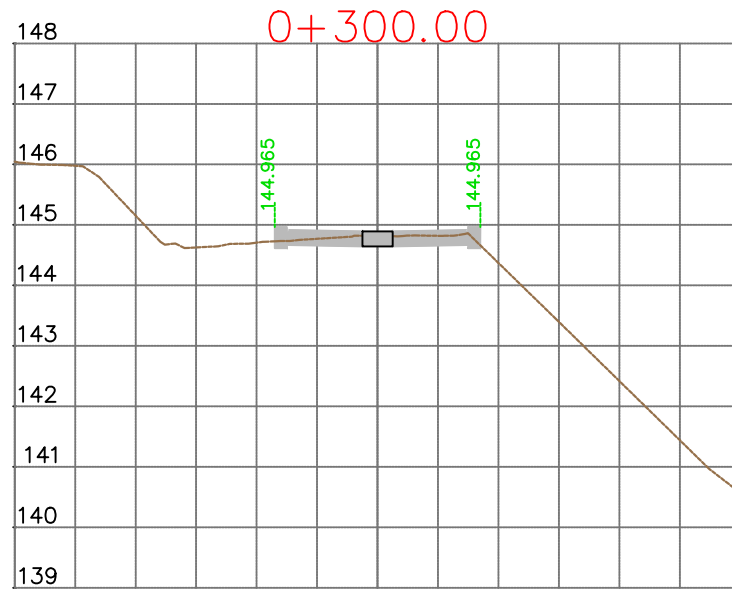

REPUBLIKA E SHQIPËRISË  
BASHKIA E TIRANËS

OBJEKTI: "RIKUALIFIKIMI URBAN I ZONËS  
INFORMALE QË KUFIZOHET NGA RRUGËT  
-SABAUDIN GABRANI -JONUZ RAMA-HAMDI  
CULLHAJ-DAMIAN HIMARIOTI-BARI  
ISHKA-VASFI SAMIMI-ALUSH ELMAZ TAKA."

Projektoi :

Ing.A.JAKOVA  
Ing.G.ISLAMI  
Ing.S.MYRSELI  
Ing.P.SHKURTI

Ark.M.DADO  
Ing.Gjeol.Xh.KASMI  
Ing.Mjedis.E.CALI  
Top.A.BECECI

Projektoi :

"S&L STUDIO SH.P.K"

Projektim-kupervizion-cosnulence



FAZA

DORËZIM

PROJEKT ZBATIMI

1.0

PROFILE TËRTHORE  
RRUGA RR.KROI BANES

SHKALLA 1:100

Nr. I FLETËS 003

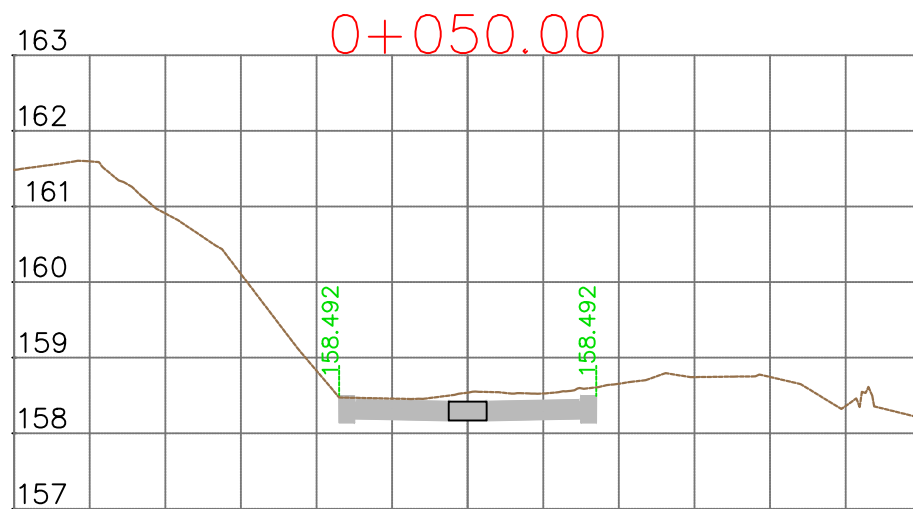
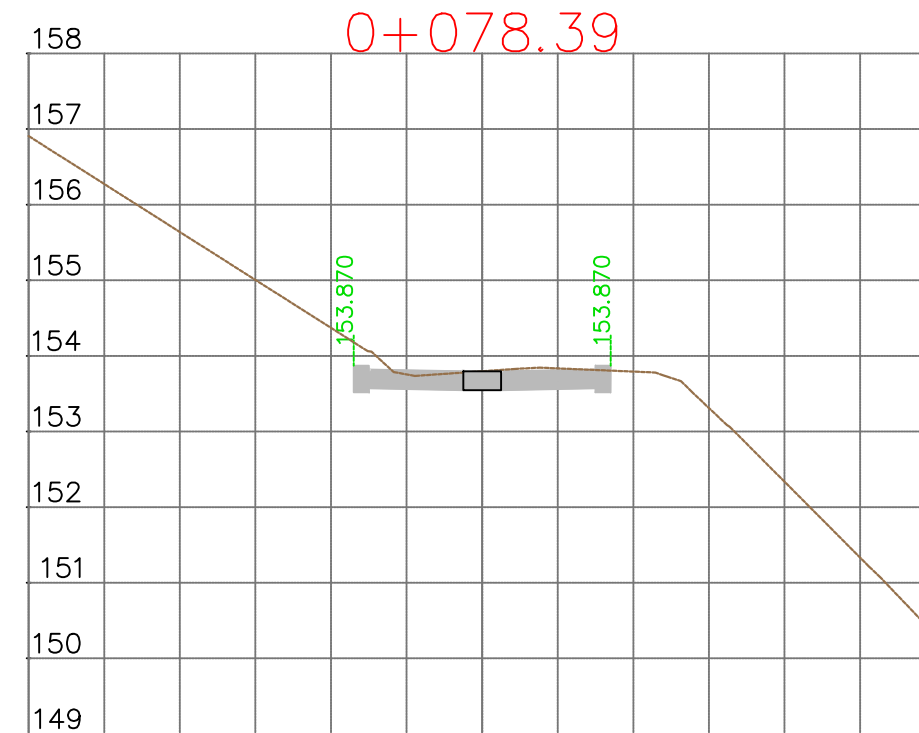
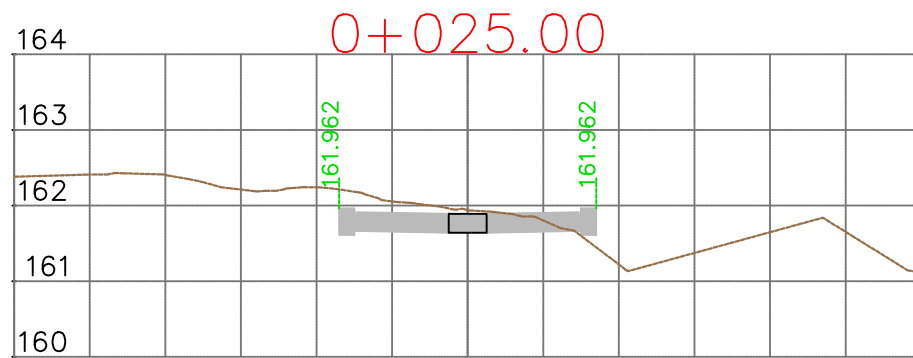
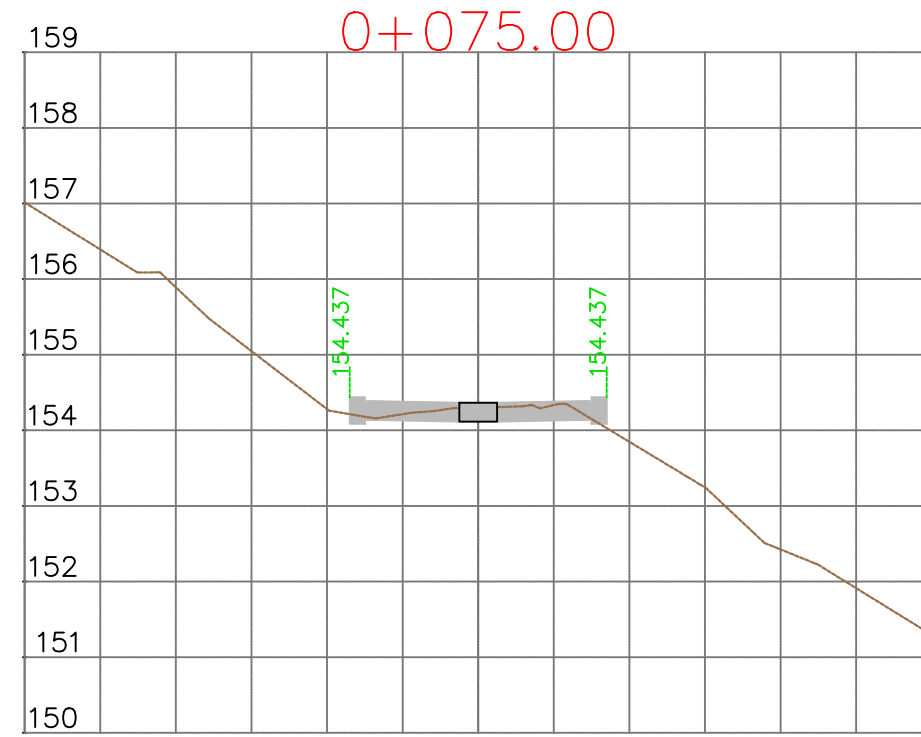
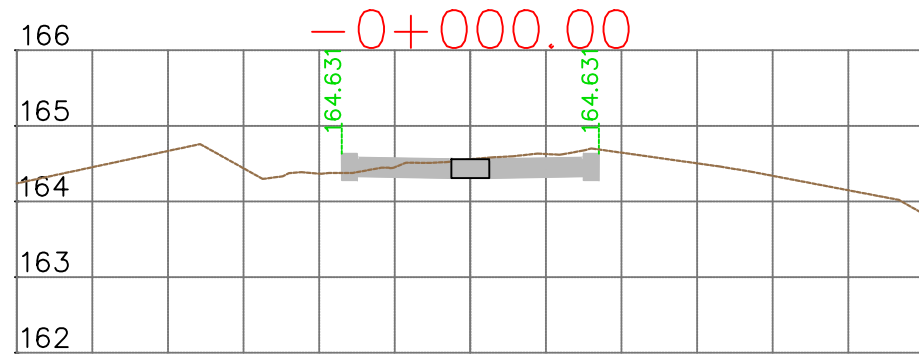

REPUBLIKA E SHQIPËRISË  
BASHKIA E TIRANËS

OBJEKTI: "RIKUALIFIKIMI URBAN I ZONËS  
INFORMALE QË KUFIZOHET NGA RRUGËT  
-SABAUDIN GABRANI -JONUZ RAMA-HAMDI  
CULLHAJ-DAMIAN HIMARIOTI-BARI  
ISHKA-VASFI SAMIMI-ALUSH ELMAZ TAKA."

Projektoi :

Ing.A.JAKOVA  
Ing.G.ISLAMI  
Ing.S.MYRSELI  
Ing.P.SHKURTI

Ark.M.DADO  
Ing.Gjeol.Xh.KASMI  
Ing.Mjedis.E.CALI  
Top.A.BECECI

Projektoi :

"S&L STUDIO SH.P.K"

Projektim-kupervizion-cosnulence



FAZA

DORËZIM

PROJEKT ZBATIMI

1.0

PROFILE TËRTHORE  
RRUGA RR.KROI BANES

SHKALLA 1:100

Nr. I FLETËS 004



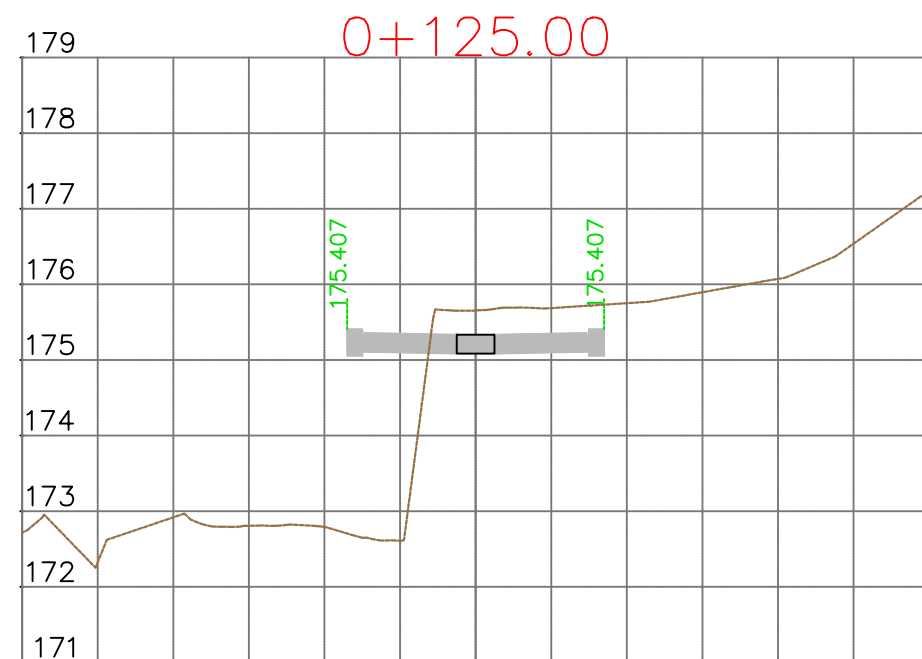
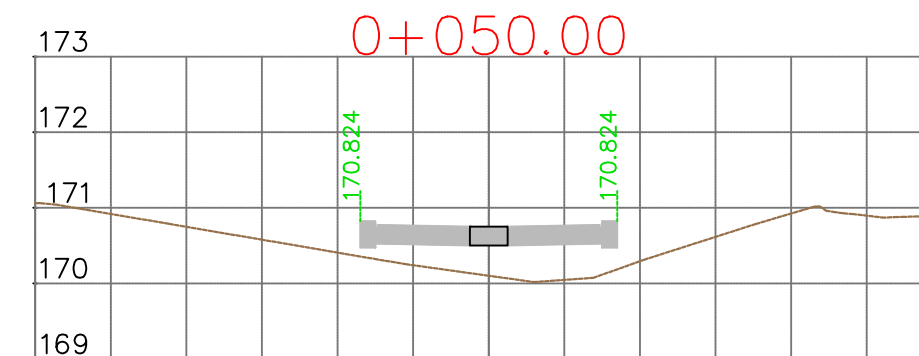
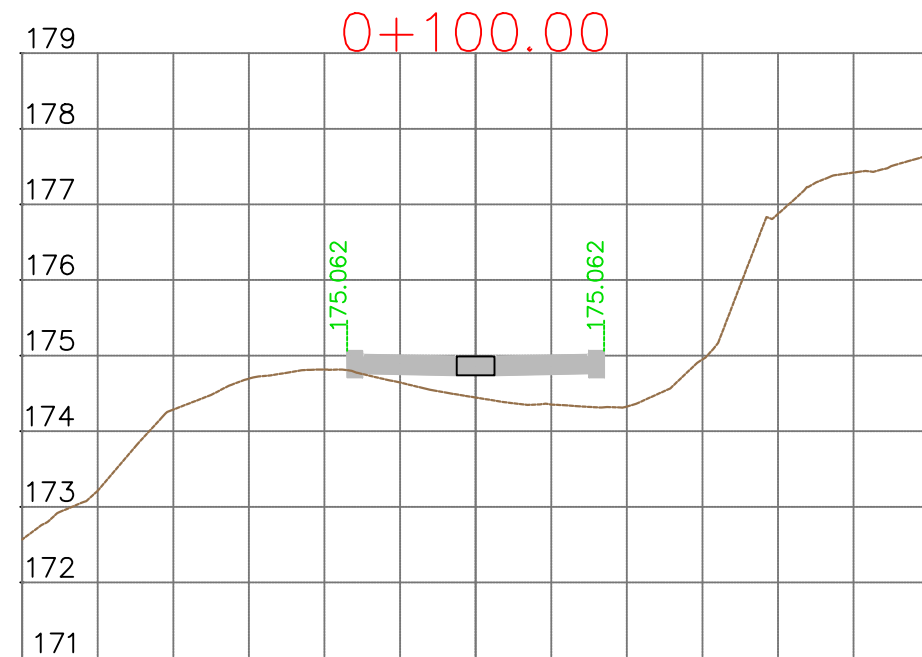
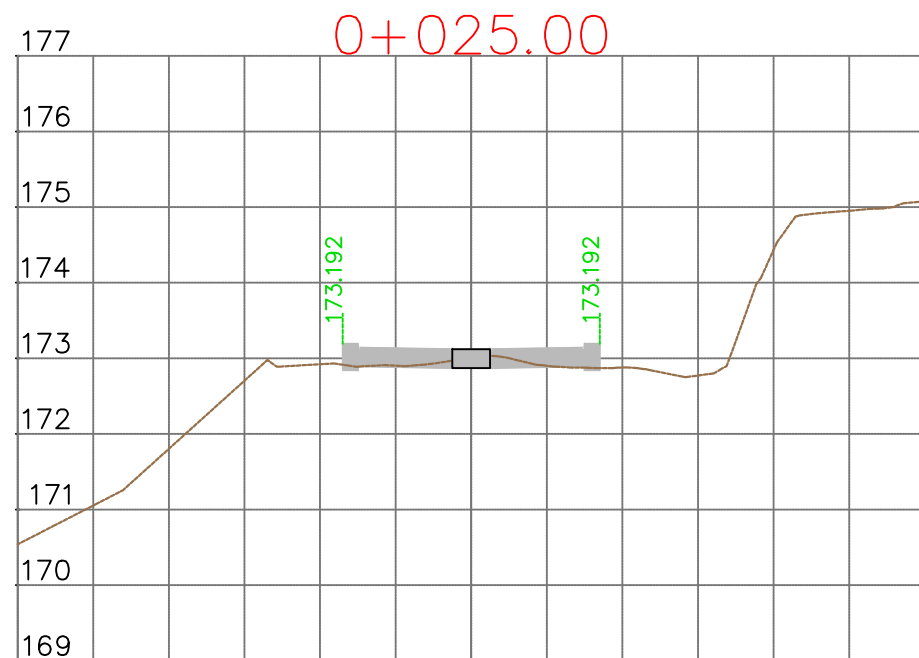
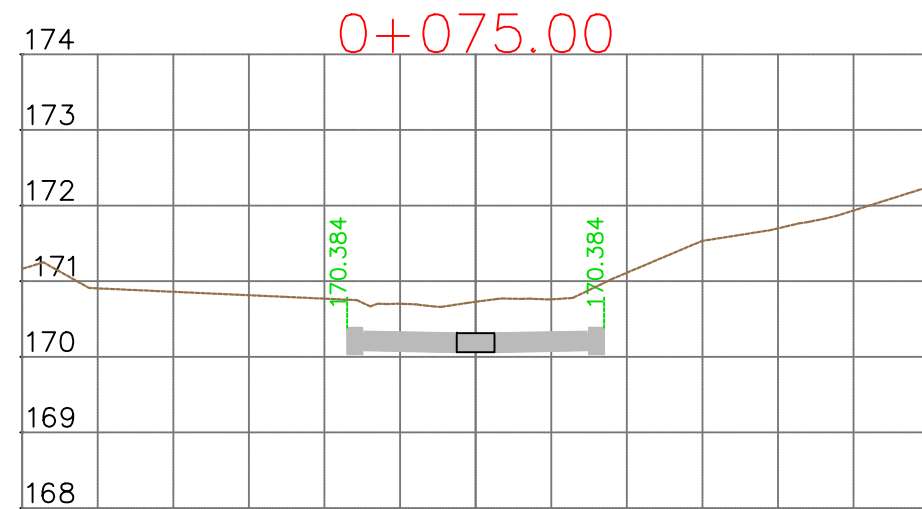
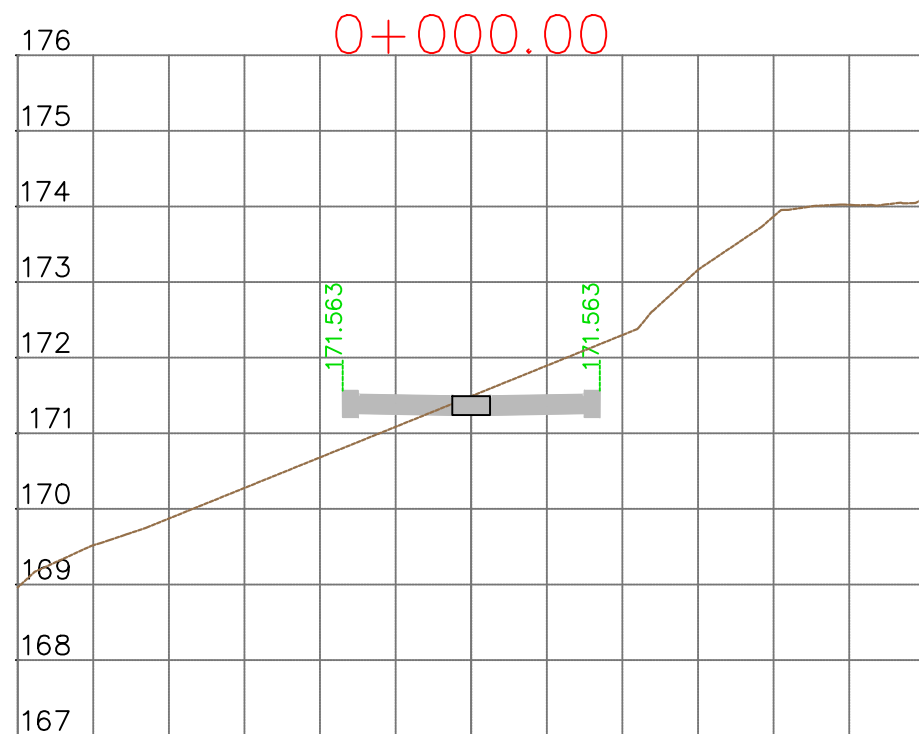

REPUBLIKA E SHQIPËRISË  
BASHKIA E TIRANËS

OBJEKTI: "RIKUALIFIKIMI URBAN I ZONËS  
INFORMALE QË KUFIZOHET NGA RRUGËT  
-SABAUDIN GABRANI -JONUZ RAMA-HAMDI  
CULLHAJ-DAMIAN HIMARIOTI-BARI  
ISHKA-VASFI SAMIMI-ALUSH ELMMAZ TAKA."

Projektoi :

Ing.A.JAKOVA  
Ing.G.ISLAMI  
Ing.S.MYRSELI  
Ing.P.SHKURTI

Ark.M.DADO  
Ing.Gjeol.Xh.KASMI  
Ing.Mjedis.E.CALI  
Top.A.BECECI

Projektoi :  
"S&L STUDIO SH.P.K"

Projektim-kupervizion-cosnulence



FAZA

DORËZIM

PROJEKT ZBATIMI

1.0

PROFILE TËRTHORE  
RRUGA RR.KROI BANES

SHKALLA 1:100

Nr. I FLETËS 005

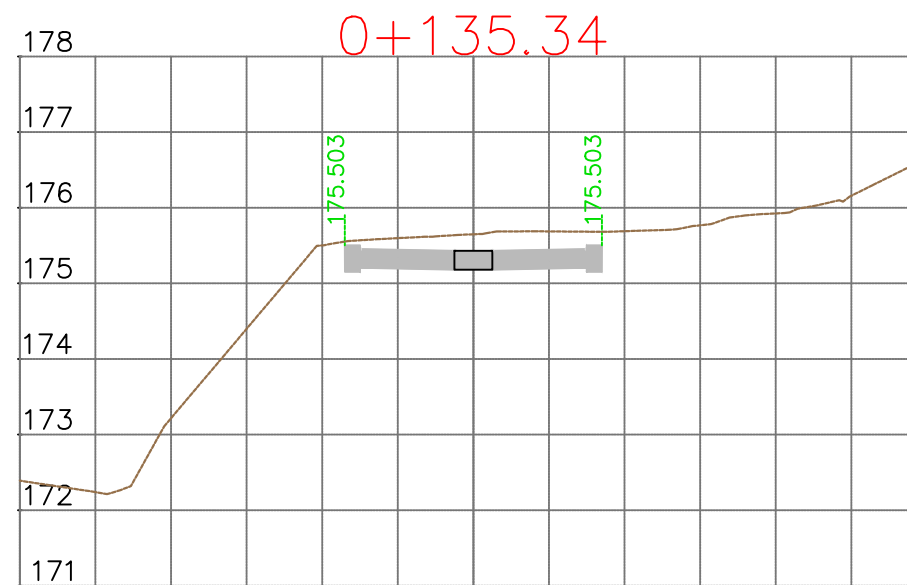

REPUBLIKA E SHQIPËRISË  
BASHKIA E TIRANËS

OBJEKTI: "RIKUALIFIKIMI URBAN I ZONËS  
INFORMALE QË KUFIZOHET NGA RRUGËT  
-SABAUDIN GABRANI -JONUZ RAMA-HAMDI  
CULLHAJ-DAMIAN HIMARIOTI-BARI  
ISHKA-VASFI SAMIMI-ALUSH ELMAZ TAKA."

Projektoi :

Ing.A.JAKOVA  
Ing.G.ISLAMI  
Ing.S.MYRSELI  
Ing.P.SHKURTI

Ark.M.DADO  
Ing.Gjeol.Xh.KASMI  
Ing.Mjedis.E.CALI  
Top.A.BECECI

Projektoi :  
"S&L STUDIO SH.P.K"

Projektim-kupervizion-cosnulence



FAZA

DORËZIM

PROJEKT ZBATIMI

1.0

PROFILE TËRTHORE  
RRUGA RR.KROI BANES

SHKALLA 1:100

Nr. I FLETËS 006

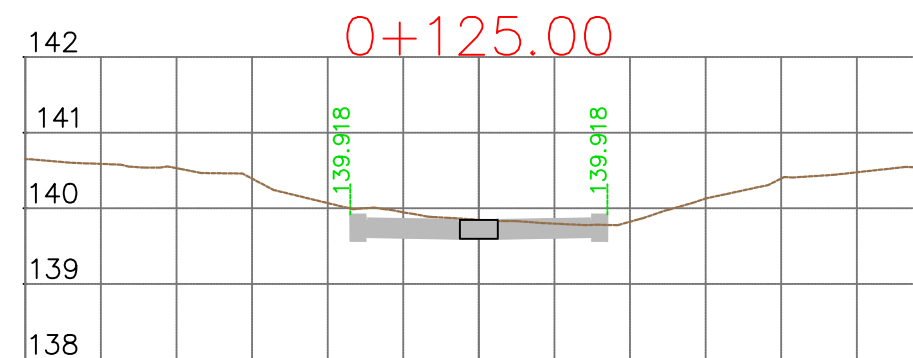
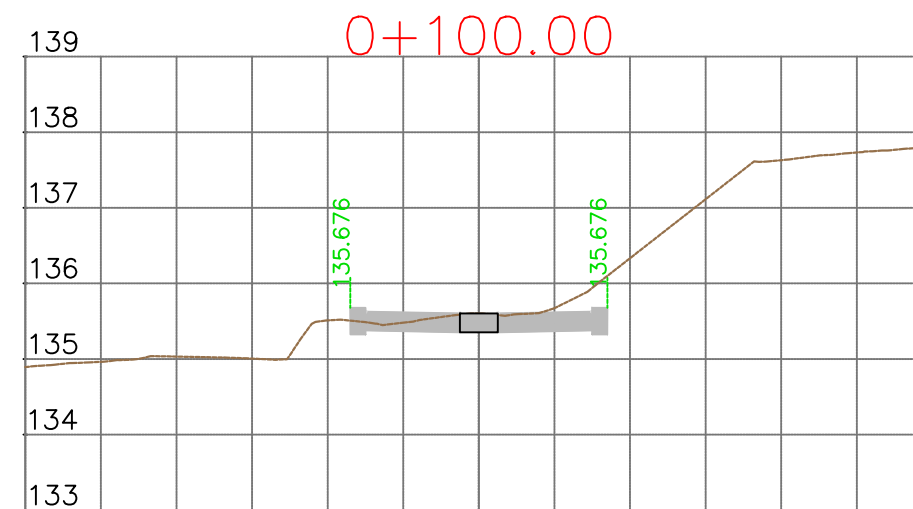
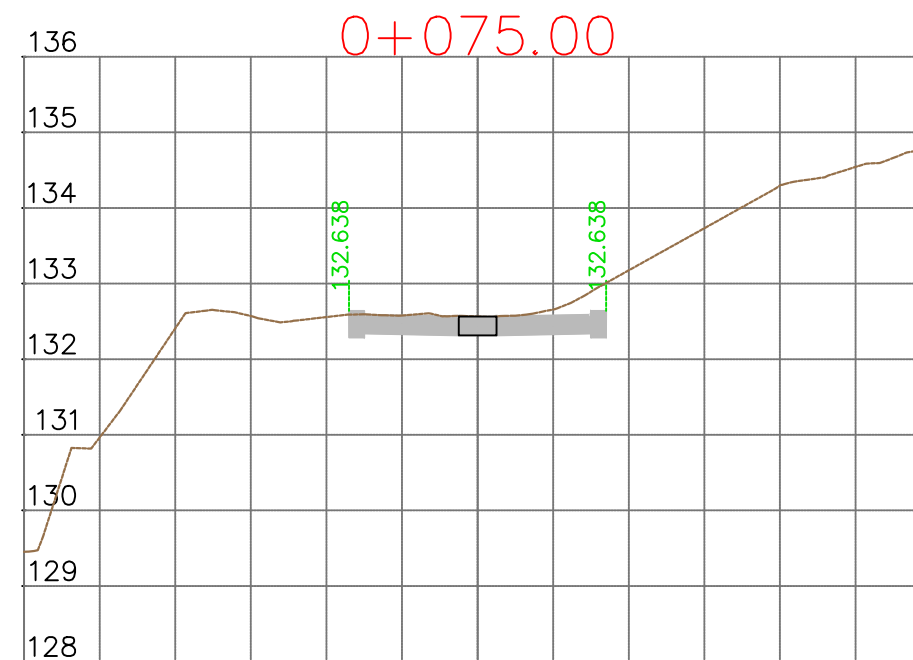
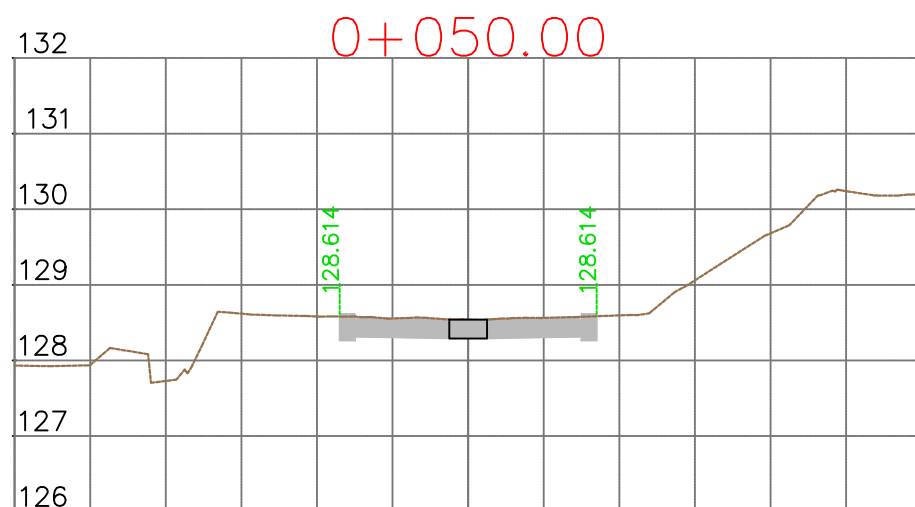
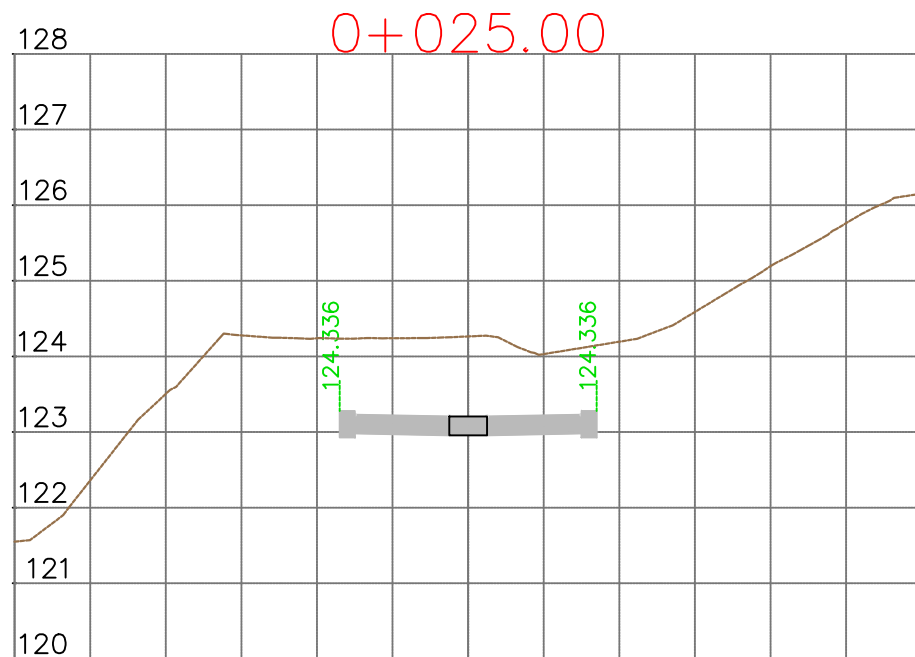
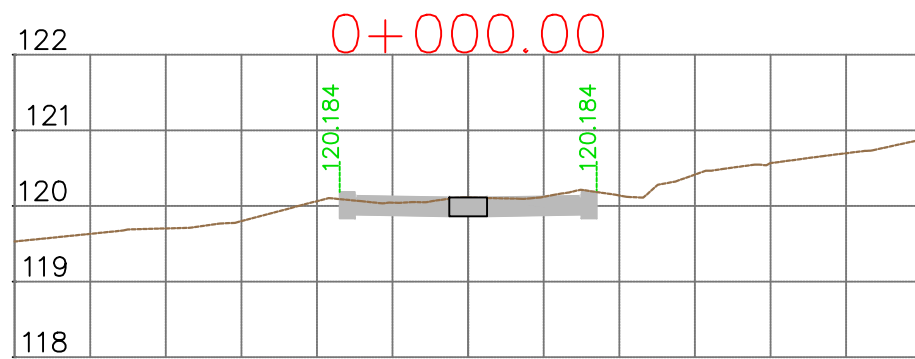

REPUBLIKA E SHQIPËRISË  
BASHKIA E TIRANËS

OBJEKTI: "RIKUALIFIKIMI URBAN I ZONËS  
INFORMALE QË KUFIZOHET NGA RRUGËT  
-SABAUDIN GABRANI -JONUZ RAMA-HAMDI  
CULLHAJ-DAMIAN HIMARIOTI-BARI  
ISHKA-VASFI SAMIMI-ALUSH ELMAZ TAKA."

Projektoi :

Ing.A.JAKOVA  
Ing.G.ISLAMI  
Ing.S.MYRSELI  
Ing.P.SHKURTI

Ark.M.DADO  
Ing.Gjeol.Xh.KASMI  
Ing.Mjedis.E.CALI  
Top.A.BECECI

Projektoi :

"S&L STUDIO SH.P.K"

Projektim-kupervizion-cosnulence



FAZA

DORËZIM

PROJEKT ZBATIMI

1.0

PROFILE TËRTHORE  
RRUGA RR.BAHRRI ISHKA

SHKALLA 1:100

Nr. I FLETËS 001

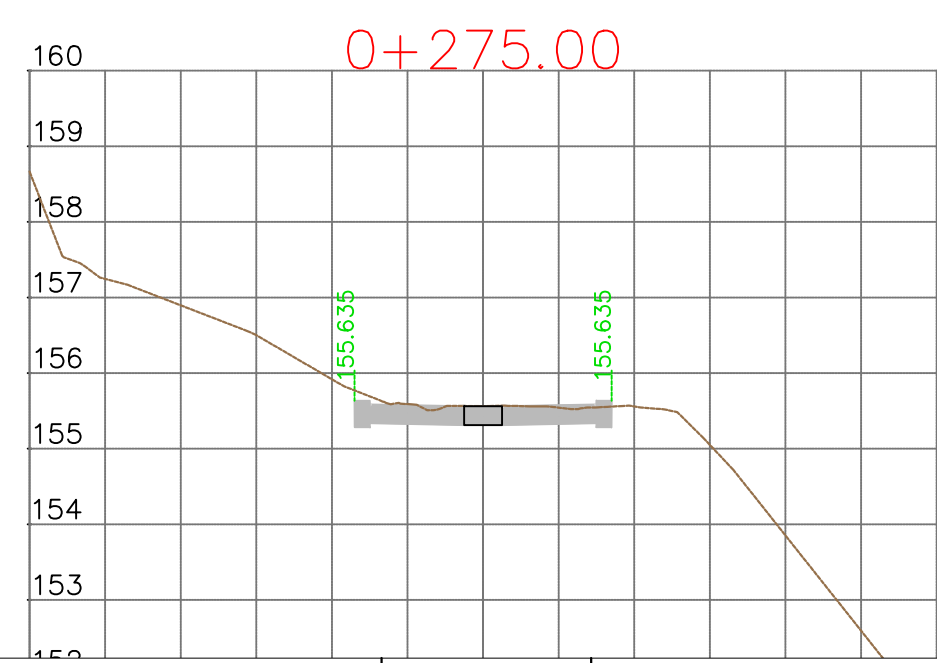
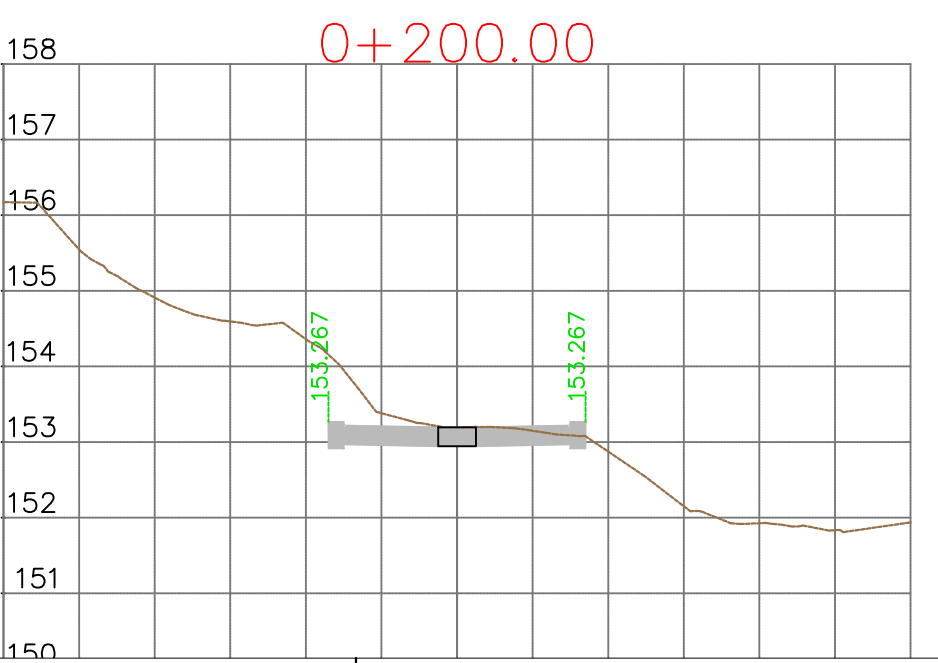
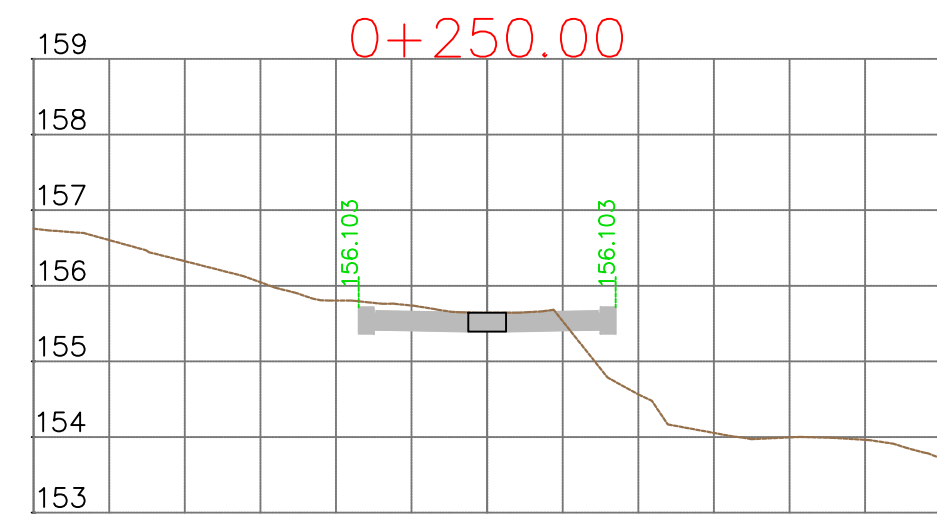
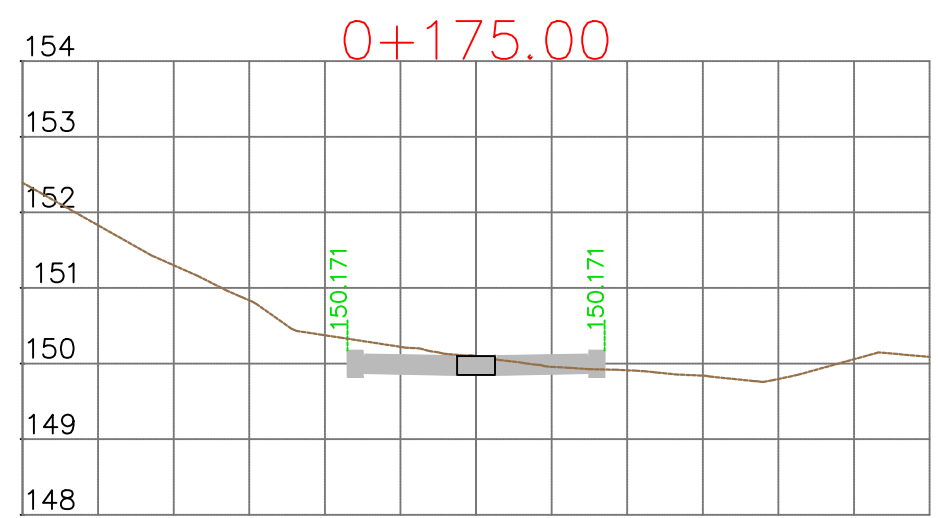
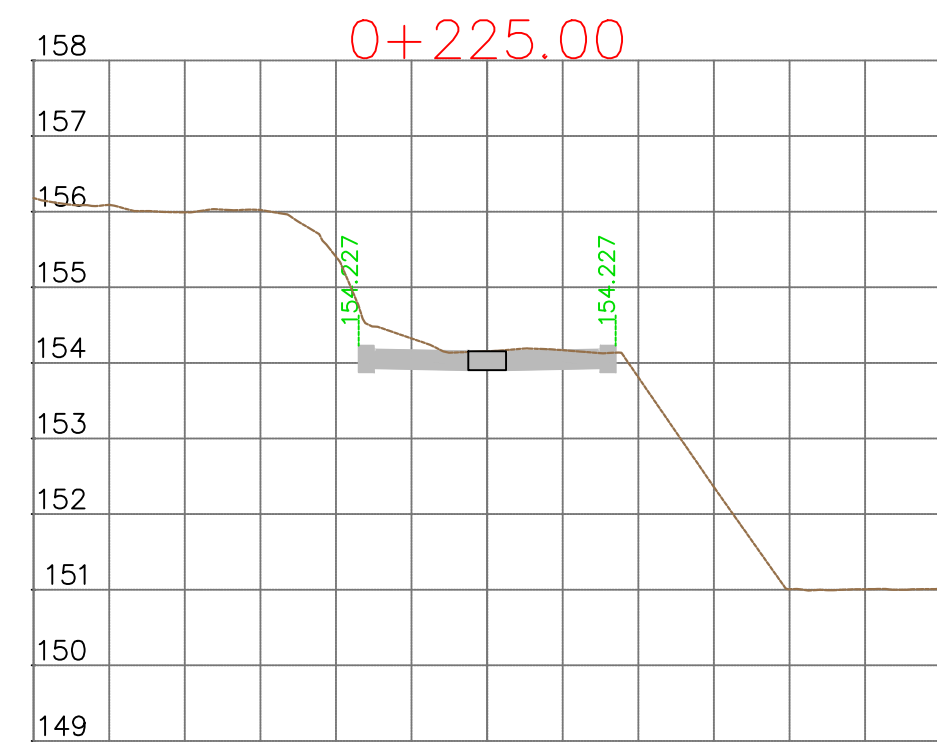
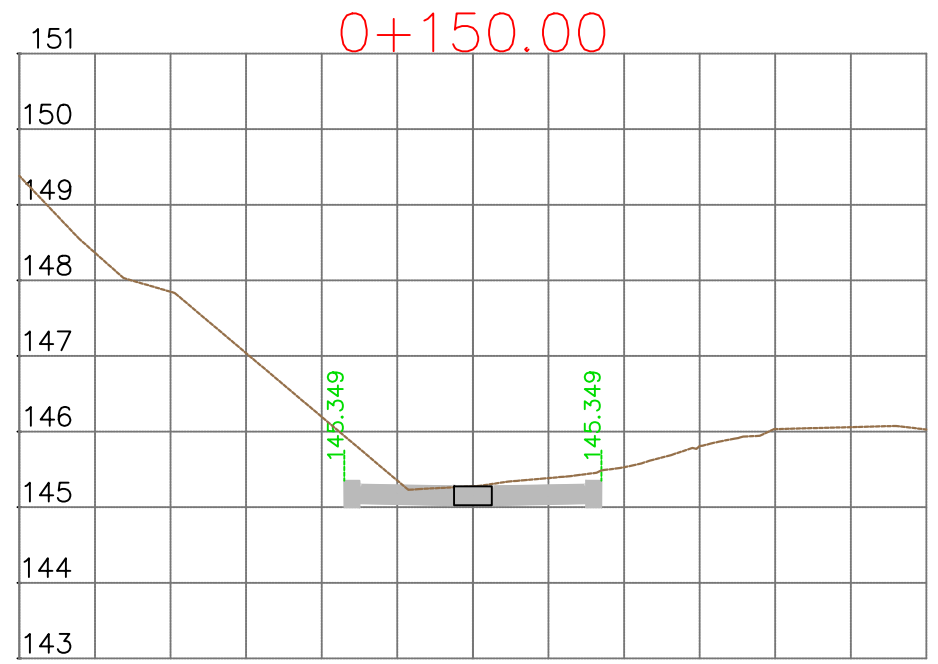

OBJEKTI: "RIKUALIFIKIMI URBAN I ZONËS INFORMALE QË KUFIZOHET NGA RRUGËT -SABAUDIN GABRANI -JONUZ RAMA-HAMDI CULLHAJ-DAMIAN HIMARIOTI-BARI ISHKA-VASFI SAMIMI-ALUSH ELMAZ TAKA."

Projektoi :  
Ing.A.JAKOVA  
Ing.G.ISLAMI  
Ing.S.MYRSELI  
Ing.P.SHKURTI  
Ark.M.DADO  
Ing.Gjeol.Xh.KASMI  
Ing.Mjedis.E.CALI  
Top.A.BECECI

Projektoi :  
"S&L STUDIO SH.P.K"  
Projektim-kupervizion-cosnulence  
**R A L D - G**  
PROJEKTIM DESIGN  
SUPERVISION KOLAUDIM

FAZA  
DORËZIM

PROJEKT ZBATIMI  
1.0

PROFILE TËRTHORE  
RRUGA RR.BAHRRI ISHKA  
SHKALLA 1:100  
Nr. I FLETËS 002

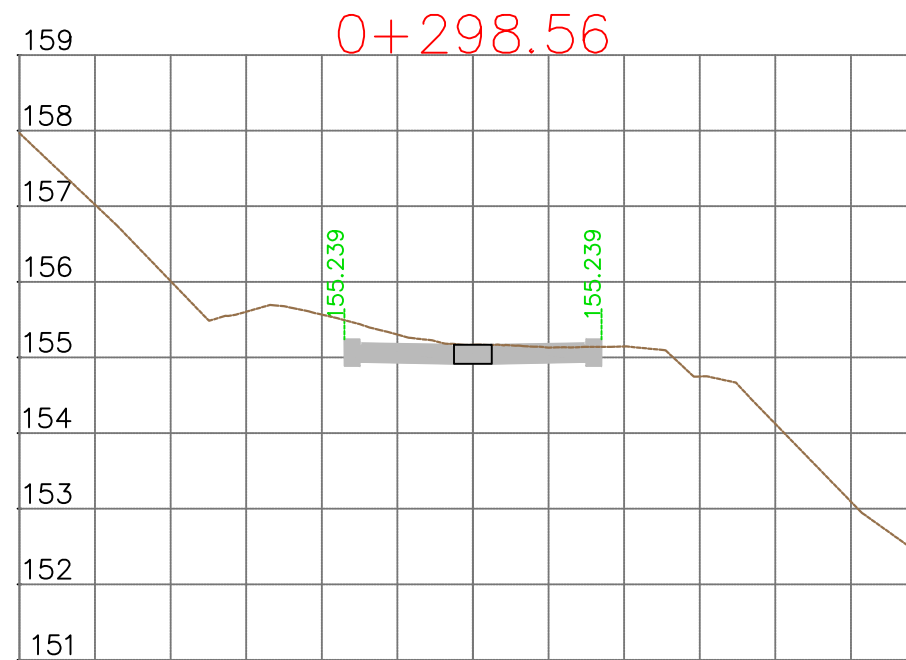

REPUBLIKA E SHQIPËRISË  
BASHKIA E TIRANËS

OBJEKTI: "RIKUALIFIKIMI URBAN I ZONËS  
INFORMALE QË KUFIZOHET NGA RRUGËT  
-SABAUDIN GABRANI -JONUZ RAMA-HAMDI  
CULLHAJ-DAMIAN HIMARIOTI-BARI  
ISHKA-VASFI SAMIMI-ALUSH ELMAZ TAKA."

Projektoi :

Ing.A.JAKOVA  
Ing.G.ISLAMI  
Ing.S.MYRSELI  
Ing.P.SHKURTI

Ark.M.DADO  
Ing.Gjeol.Xh.KASMI  
Ing.Mjedis.E.CALI  
Top.A.BECECI

Projektoi :  
"S&L STUDIO SH.P.K"

Projektim-kupervizion-cosnulence



FAZA

DORËZIM

PROJEKT ZBATIMI

1.0

PROFILE TËRTHORE  
RRUGA RR.BAHRRI ISHKA

SHKALLA 1:100

Nr. I FLETËS 003

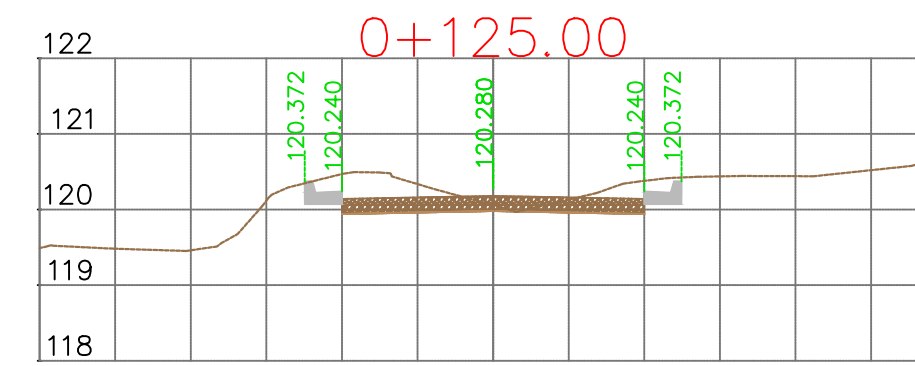
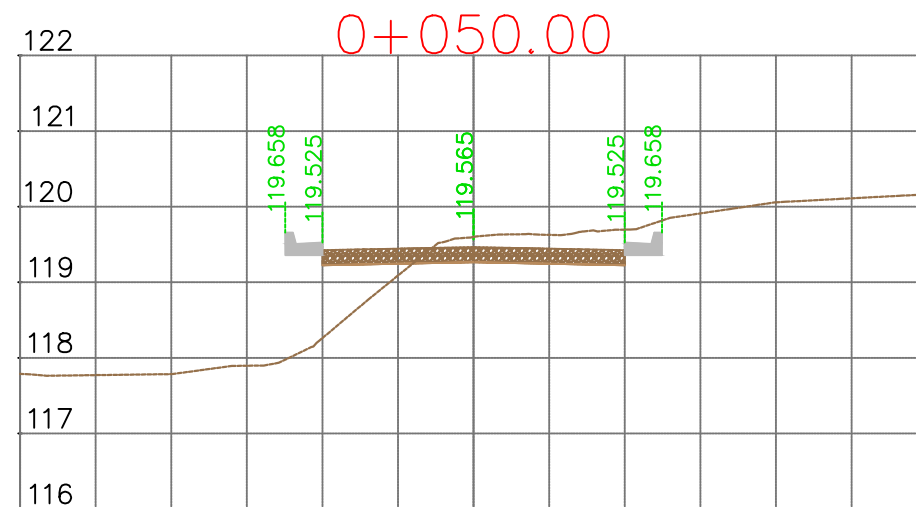
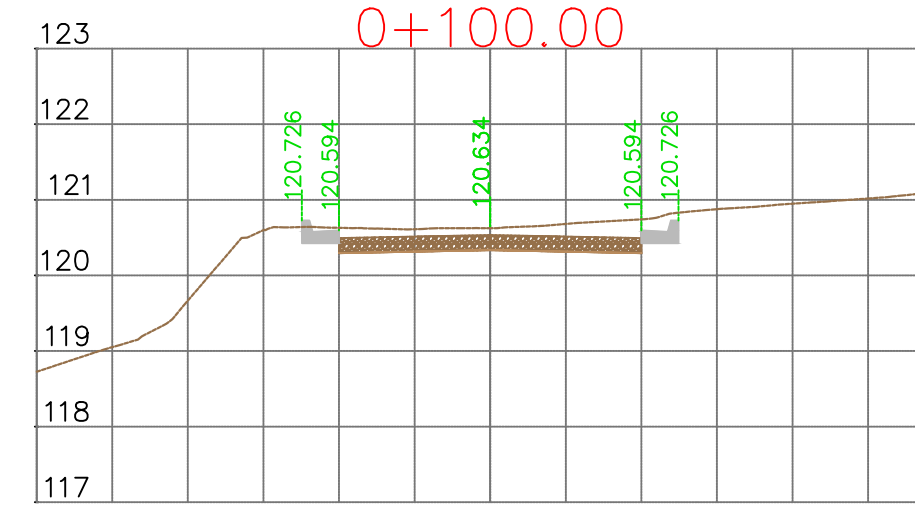
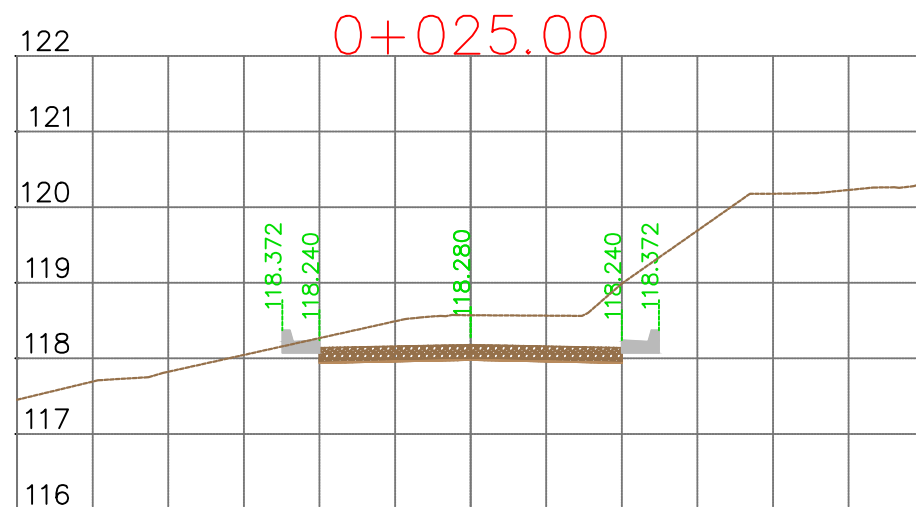
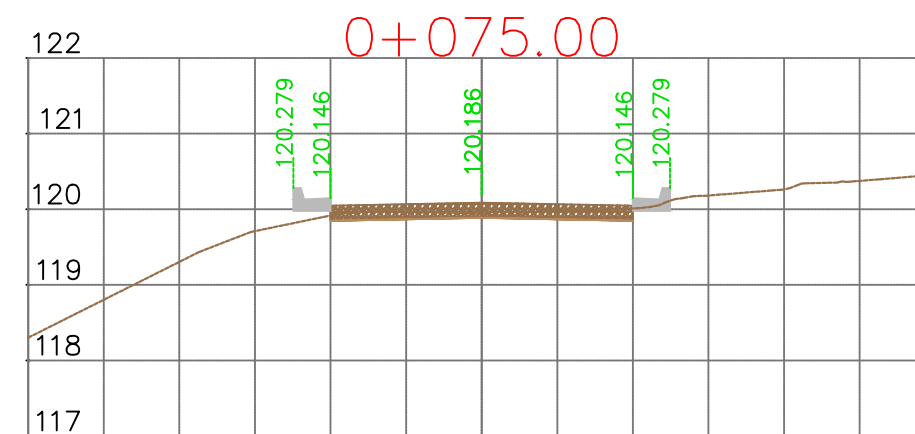
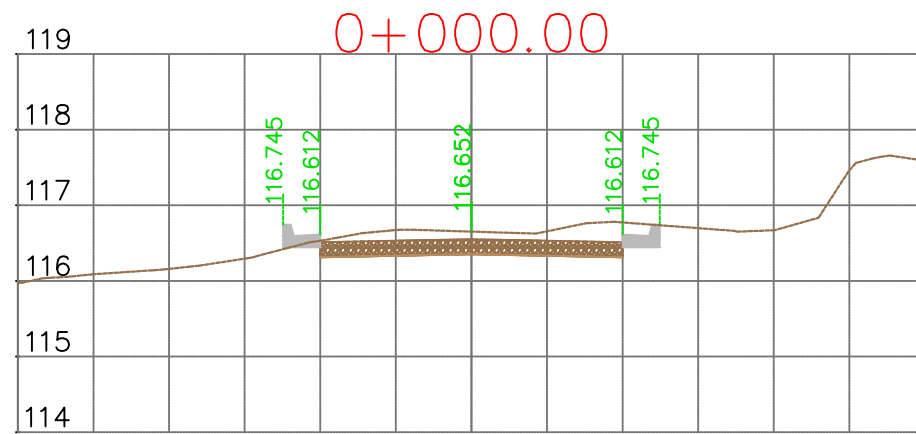

REPUBLIKA E SHQIPËRISË  
BASHKIA E TIRANËS

OBJEKTI: "RIKUALIFIKIMI URBAN I ZONËS INFORMALE QË KUFIZOHET NGA RRUGËT -SABAUDIN GABRANI -JONUZ RAMA-HAMDI CULLHAJ-DAMIAN HIMARIOTI-BARI ISHKA-VASFI SAMIMI-ALUSH ELMAZ TAKA."

Projektoi :

Ing.A.JAKOVA  
Ing.G.ISLAMI  
Ing.S.MYRSELI  
Ing.P.SHKURTI

Ark.M.DADO  
Ing.Gjeol.Xh.KASMI  
Ing.Mjedis.E.CALI  
Top.A.BECECI

Projektoi :

"S&L STUDIO SH.P.K"

Projektim-kupervizion-cosnulence



FAZA

DORËZIM

PROJEKT ZBATIMI

1.0

PROFILE TËRTHORE  
RRUGA RR.VAFSI SAMIMI

SHKALLA 1:100

Nr. I FLETËS 001

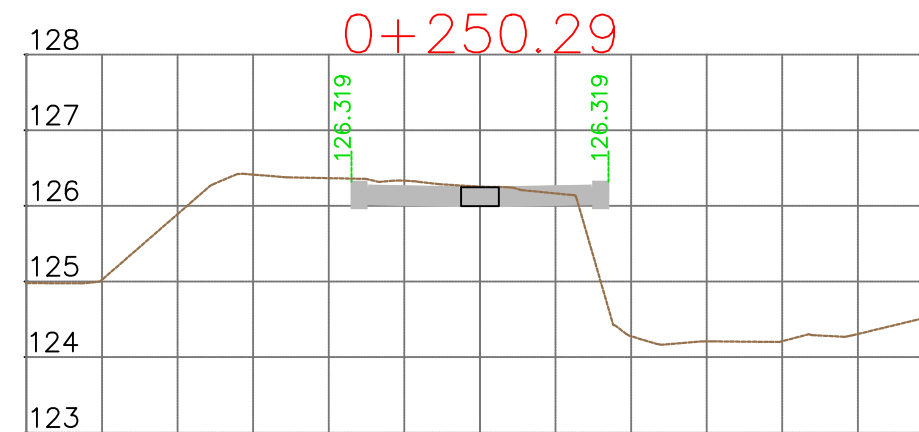
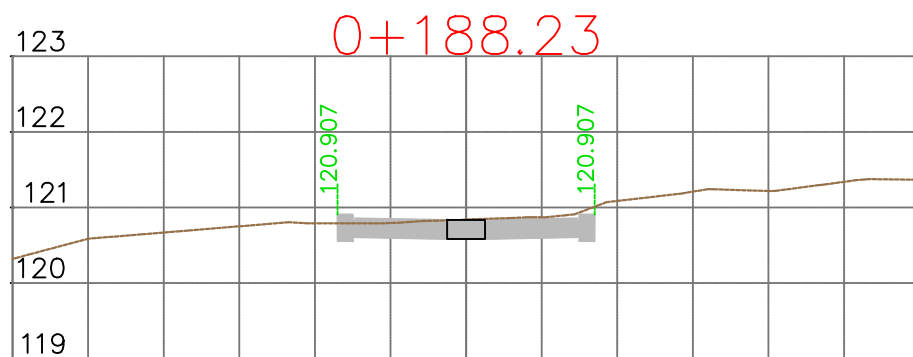
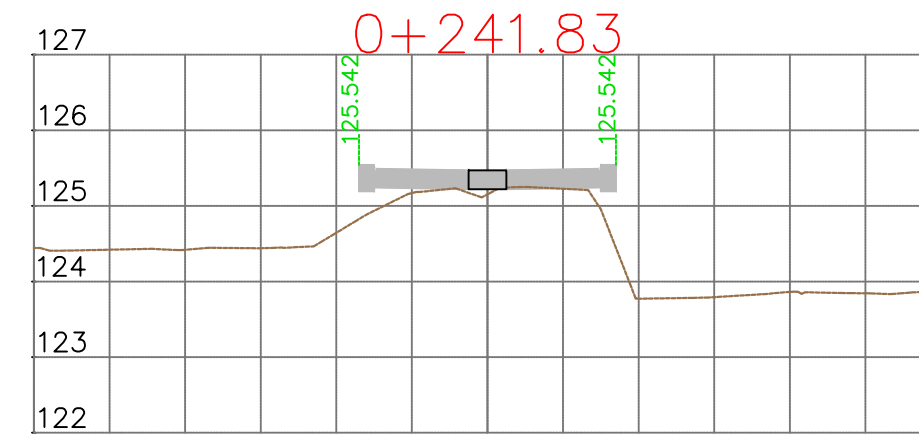
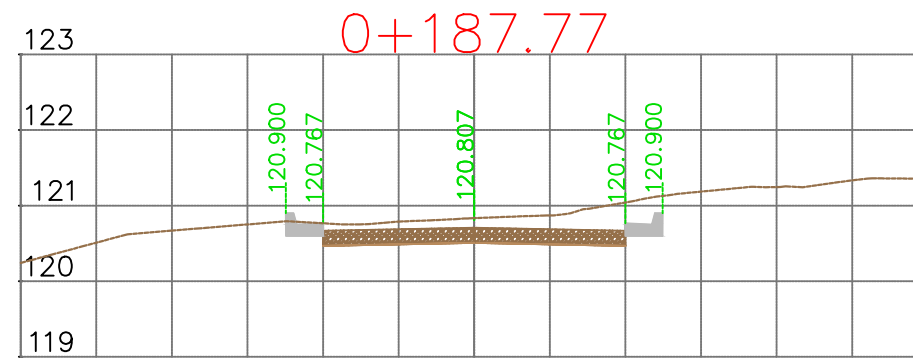
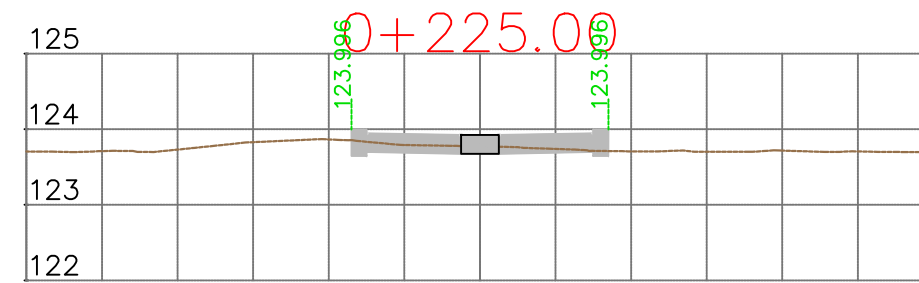
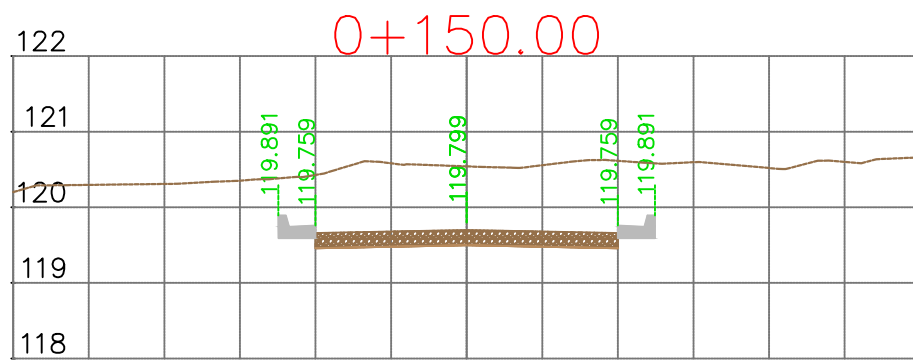

REPUBLIKA E SHQIPËRISË  
BASHKIA E TIRANËS

OBJEKTI: "RIKUALIFIKIMI URBAN I ZONËS  
INFORMALE QË KUFIZOHET NGA RRUGËT  
-SABAUDIN GABRANI -JONUZ RAMA-HAMDI  
CULLHAJ-DAMIAN HIMARIOTI-BARI  
ISHKA-VASFI SAMIMI-ALUSH ELMAZ TAKA."

Projektoi :

Ing.A.JAKOVA  
Ing.G.ISLAMI  
Ing.S.MYRSELI  
Ing.P.SHKURTI

Ark.M.DADO  
Ing.Gjeol.Xh.KASMI  
Ing.Mjedis.E.CALI  
Top.A.BECECI

Projektoi :  
"S&L STUDIO SH.P.K"

Projektim-kupervizion-cosnulence



FAZA

DORËZIM

PROJEKT ZBATIMI

1.0

PROFILE TËRTHORE  
RRUGA RR.VAFSI SAMIMI

SHKALLA 1:100

Nr. I FLETËS 002

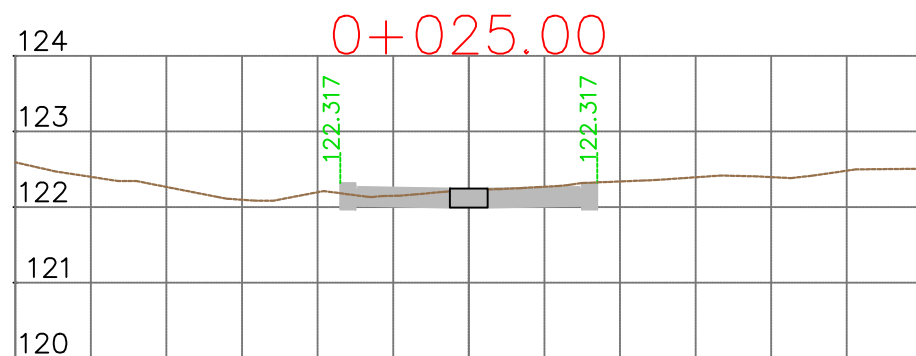
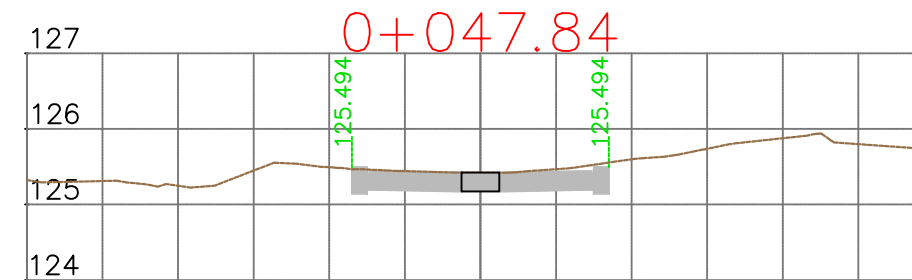
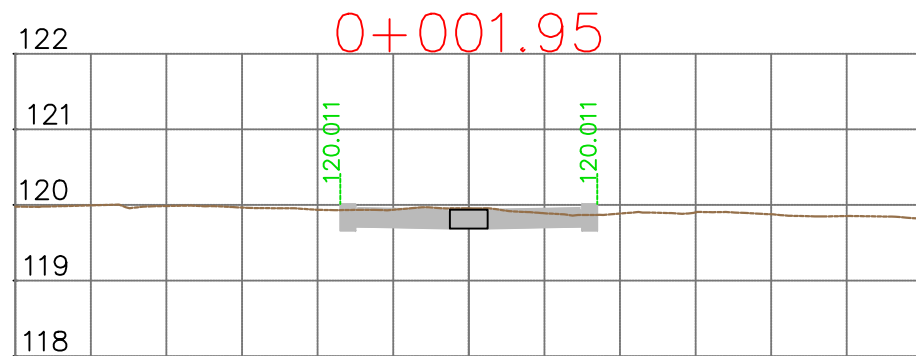

REPUBLIKA E SHQIPËRISË  
BASHKIA E TIRANËS

OBJEKTI: "RIKUALIFIKIMI URBAN I ZONËS  
INFORMALE QË KUFIZOHET NGA RRUGËT  
-SABAUDIN GABRANI -JONUZ RAMA-HAMDI  
CULLHAJ-DAMIAN HIMARIOTI-BARI  
ISHKA-VASFI SAMIMI-ALUSH ELMAZ TAKA."

Projektoi :

Ing.A.JAKOVA  
Ing.G.ISLAMI  
Ing.S.MYRSELI  
Ing.P.SHKURTI

Ark.M.DADO  
Ing.Gjeol.Xh.KASMI  
Ing.Mjedis.E.CALI  
Top.A.BECECI

Projektoi :  
"S&L STUDIO SH.P.K"

Projektim-kupervizion-cosnulence



FAZA

DORËZIM

PROJEKT ZBATIMI

1.0

PROFILE TËRTHORE  
RRUGA RR.VAFSI SAMIMI

SHKALLA 1:100

Nr. I FLETËS 003



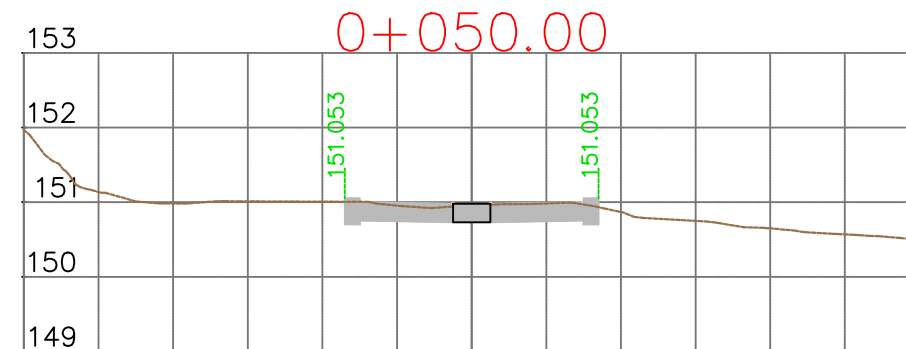
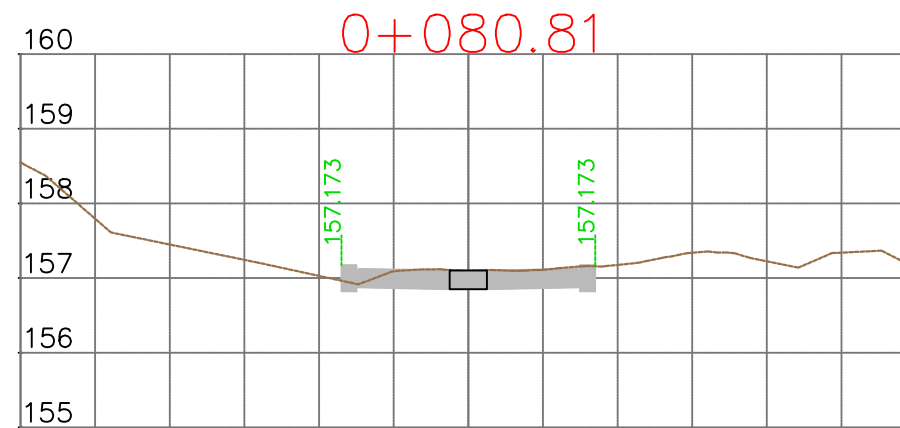
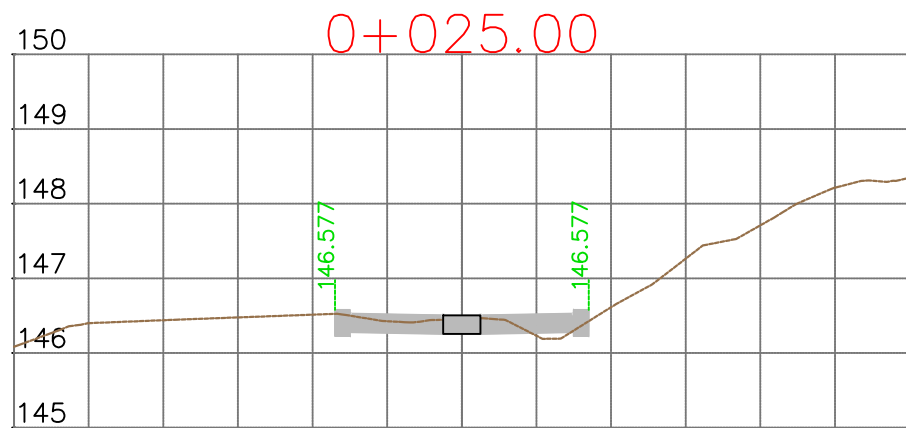
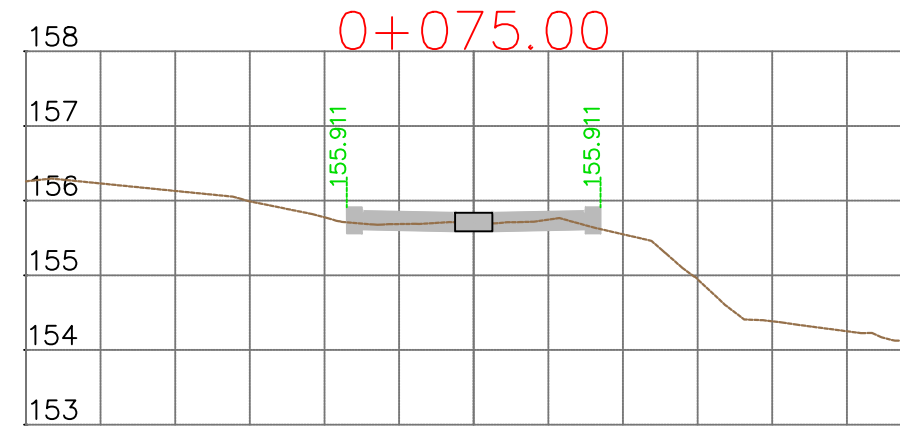
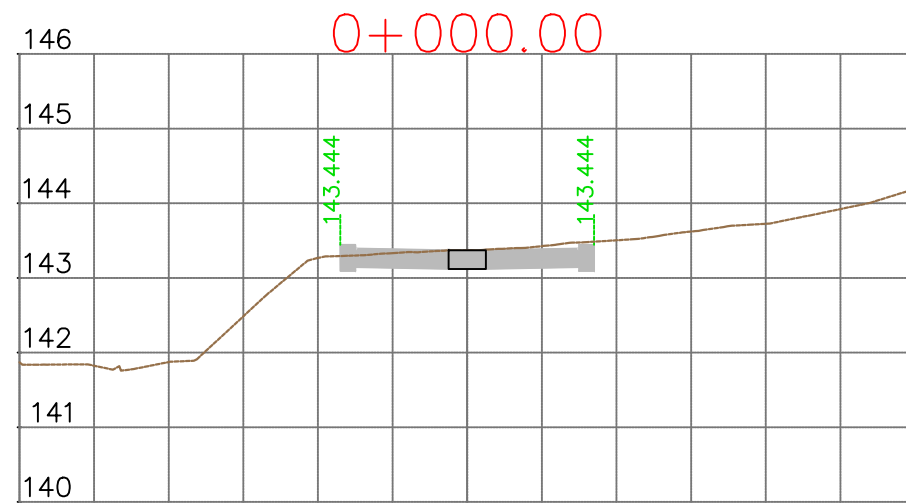

REPUBLIKA E SHQIPËRISË  
BASHKIA E TIRANËS

OBJEKTI: "RIKUALIFIKIMI URBAN I ZONËS  
INFORMALE QË KUFIZOHET NGA RRUGËT  
-SABAUDIN GABRANI -JONUZ RAMA-HAMDI  
CULLHAJ-DAMIAN HIMARIOTI-BARI  
ISHKA-VASFI SAMIMI-ALUSH ELMAZ TAKA."

Projektoi :

Ing.A.JAKOVA  
Ing.G.ISLAMI  
Ing.S.MYRSELI  
Ing.P.SHKURTI

Ark.M.DADO  
Ing.Gjeol.Xh.KASMI  
Ing.Mjedis.E.CALI  
Top.A.BECECI

Projektoi :

"S&L STUDIO SH.P.K"

Projektim-kupervizion-cosnulence



FAZA

DORËZIM

PROJEKT ZBATIMI

1.0

PROFILE TËRTHORE  
RRUGA RR.SABAUDIN GABRANI

SHKALLA 1:100

Nr. I FLETËS 001

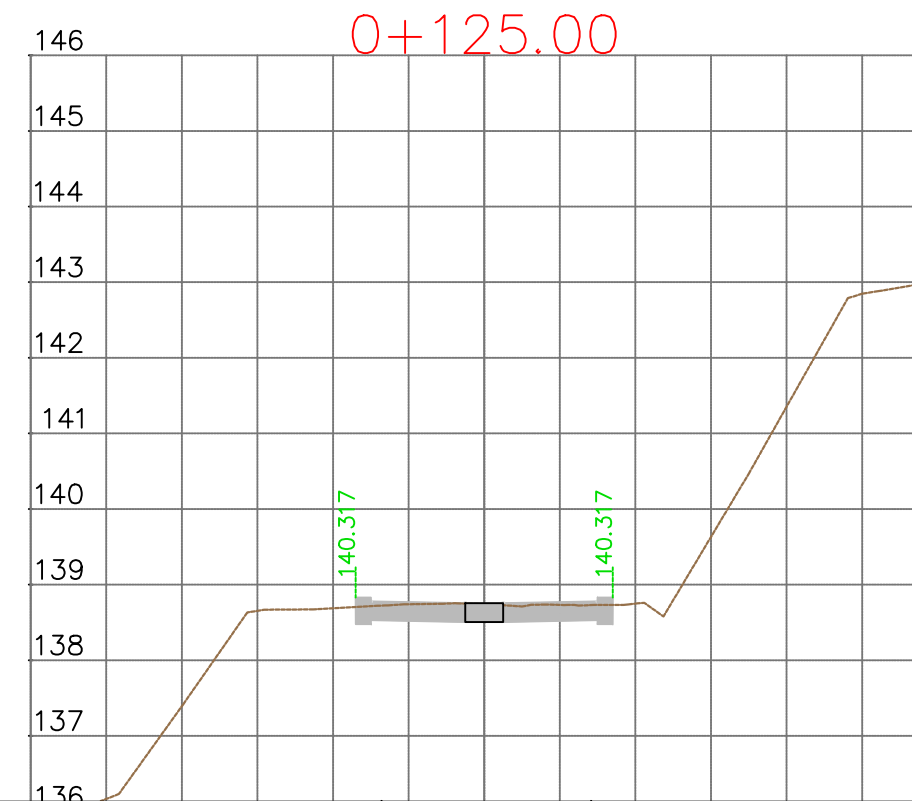
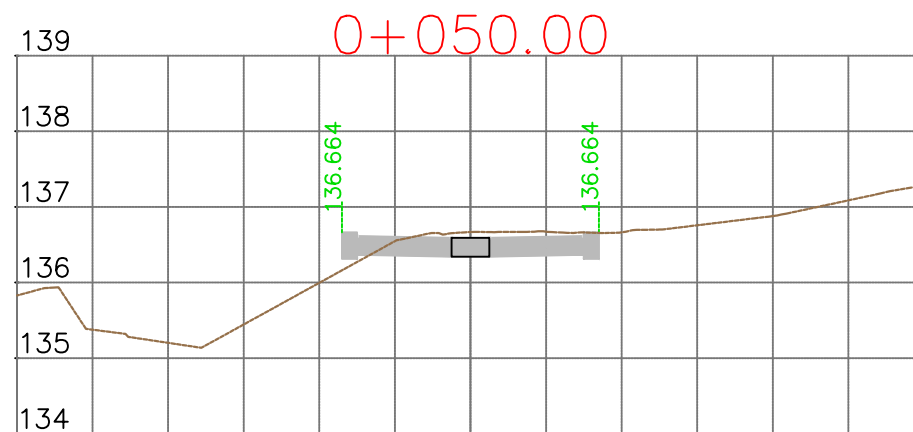
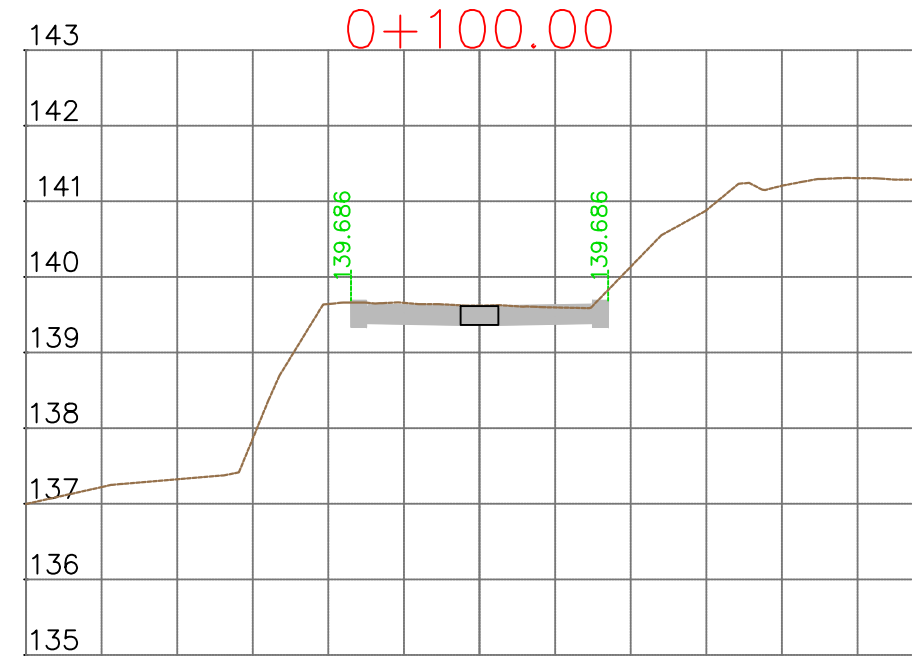
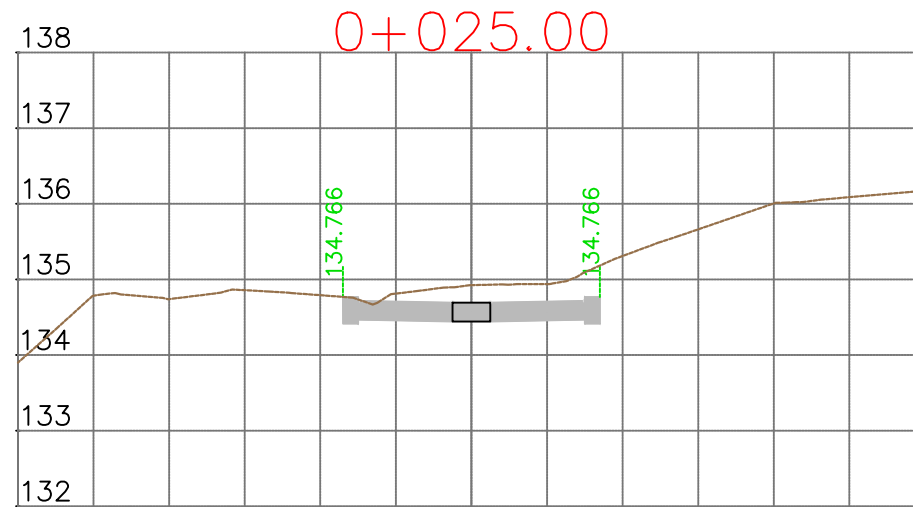
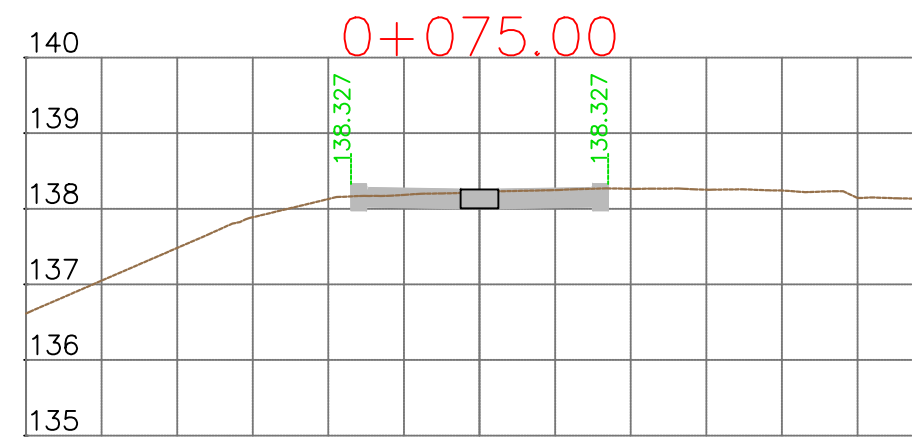
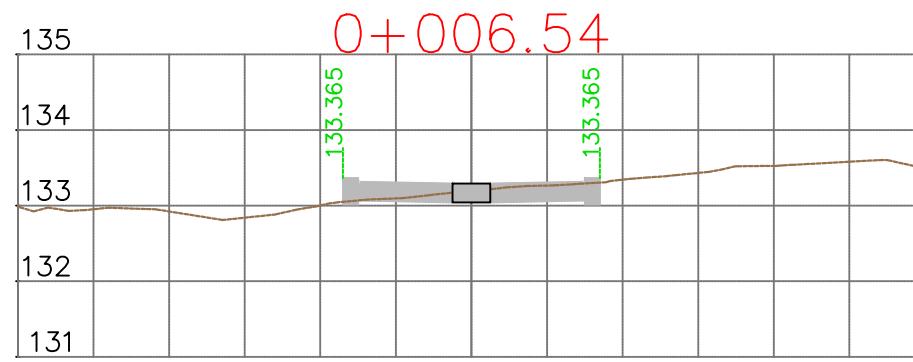

REPUBLIKA E SHQIPËRISË  
BASHKIA E TIRANËS

OBJEKTI: "RIKUALIFIKIMI URBAN I ZONËS  
INFORMALE QË KUFIZOHET NGA RRUGËT  
-SABAUDIN GABRANI -JONUZ RAMA-HAMDI  
CULLHAJ-DAMIAN HIMARIOTI-BARI  
ISHKA-VASFI SAMIMI-ALUSH ELMAZ TAKA."

Projektoi :

Ing.A.JAKOVA  
Ing.G.ISLAMI  
Ing.S.MYRSELI  
Ing.P.SHKURTI

Ark.M.DADO  
Ing.Gjeol.Xh.KASMI  
Ing.Mjedis.E.CALI  
Top.A.BECECI

Projektoi :

"S&L STUDIO SH.P.K"

Projektim-kupervizion-cosnulence



FAZA

DORËZIM

PROJEKT ZBATIMI

1.0

PROFILE TËRTHORE  
RRUGA RR.JONUZ RAMA

SHKALLA 1:100

Nr. I FLETËS 001

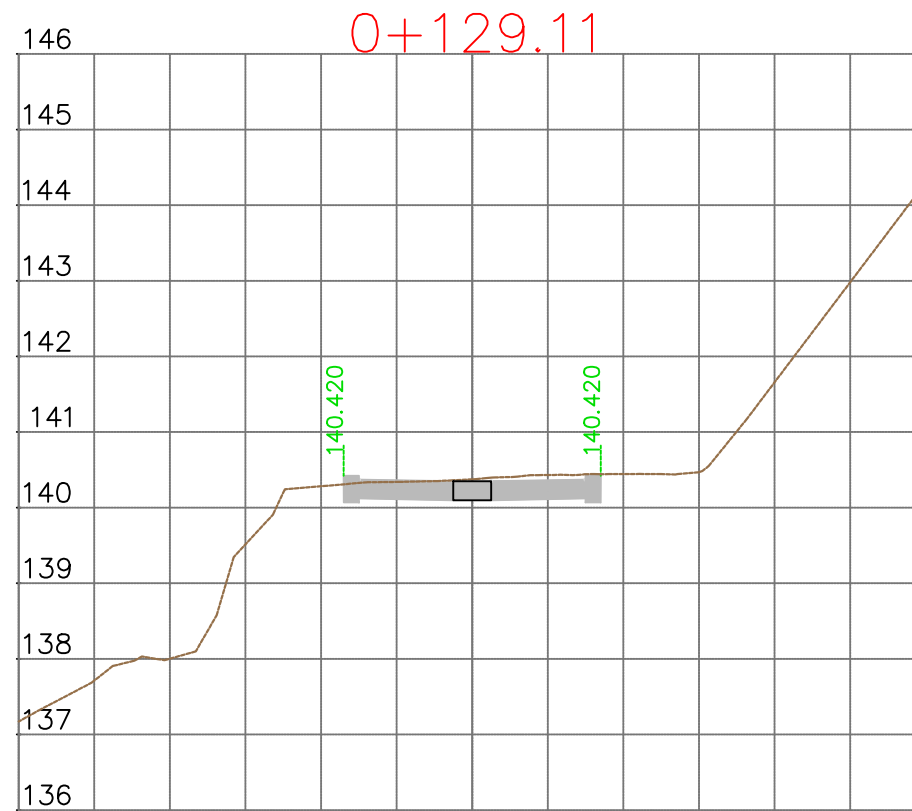

REPUBLIKA E SHQIPËRISË  
BASHKIA E TIRANËS

OBJEKTI: "RIKUALIFIKIMI URBAN I ZONËS  
INFORMALE QË KUFIZOHET NGA RRUGËT  
-SABAUDIN GABRANI -JONUZ RAMA-HAMDI  
CULLHAJ-DAMIAN HIMARIOTI-BARI  
ISHKA-VASFI SAMIMI-ALUSH ELMAZ TAKA."

Projektoi :

Ing.A.JAKOVA  
Ing.G.ISLAMI  
Ing.S.MYRSELI  
Ing.P.SHKURTI

Ark.M.DADO  
Ing.Gjeol.Xh.KASMI  
Ing.Mjedis.E.CALI  
Top.A.BECECI

Projektoi :

"S&L STUDIO SH.P.K"

Projektim-kupervizion-cosnulence



FAZA

DORËZIM

PROJEKT ZBATIMI

1.0

PROFILE TËRTHORE  
RRUGA RR.JONUZ RAMA

SHKALLA 1:100

Nr. I FLETËS 002

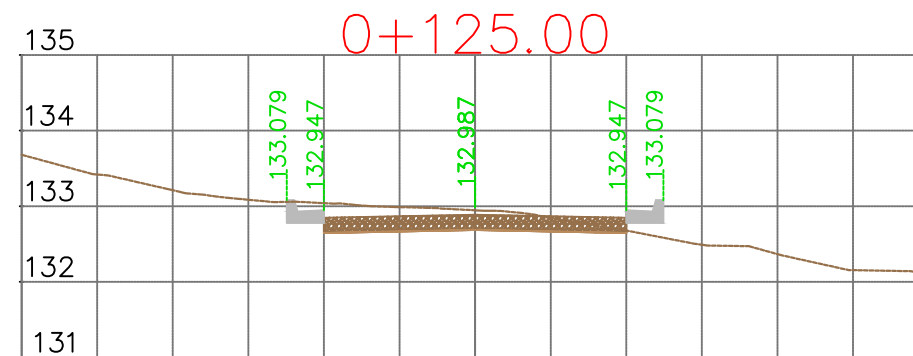
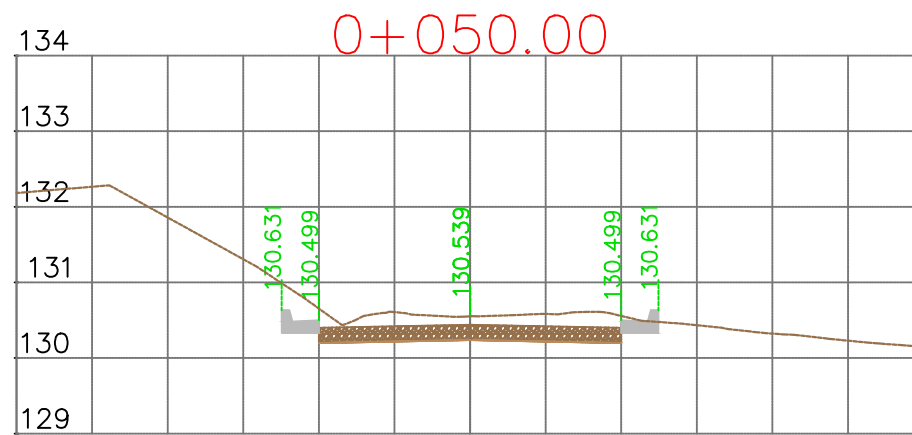
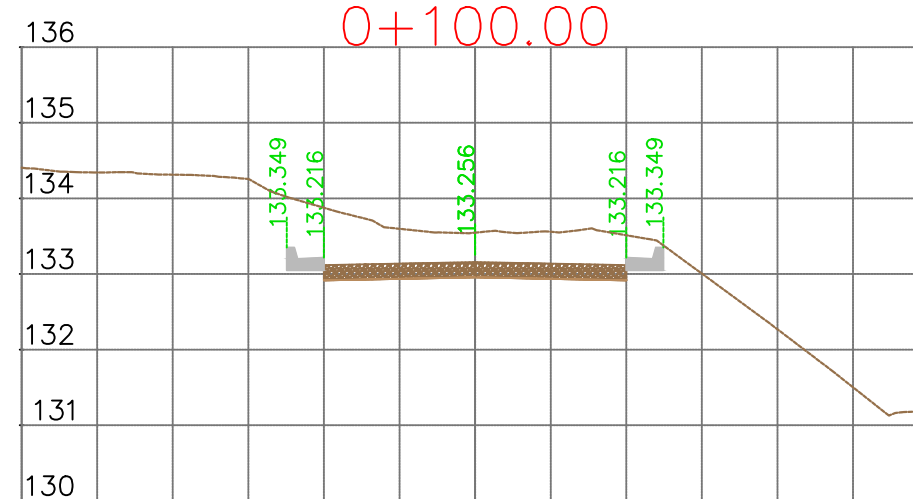
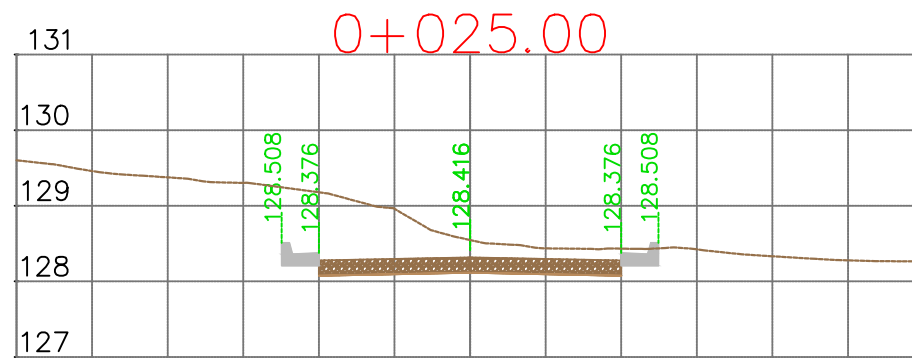
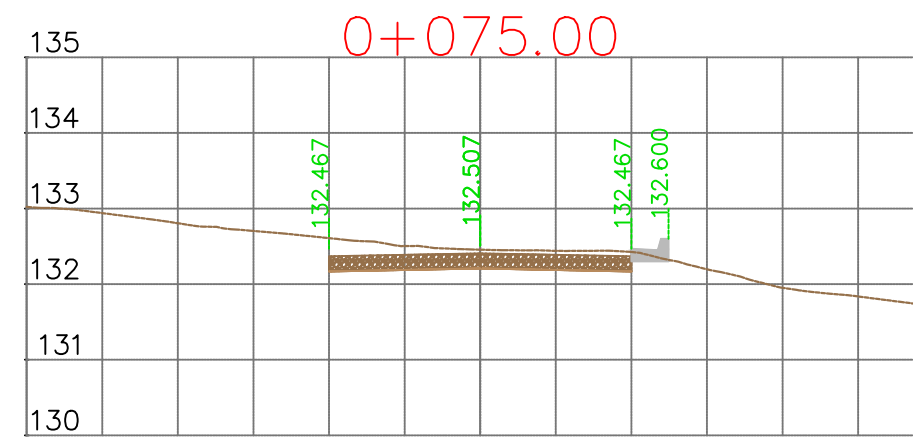
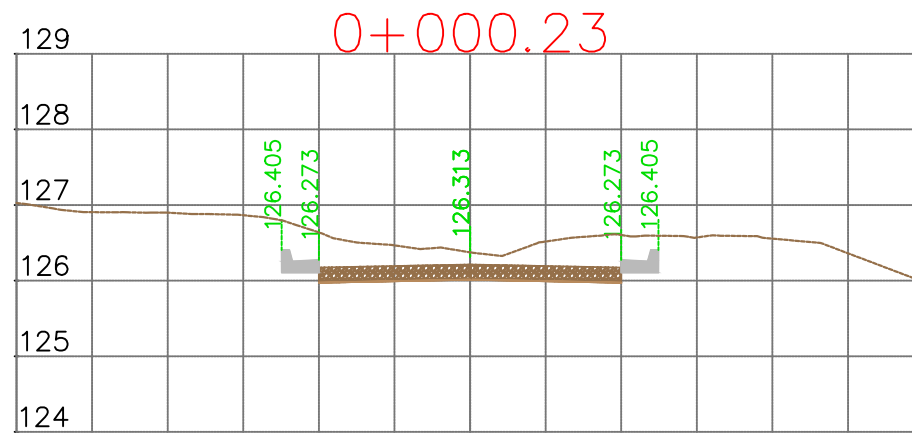

REPUBLIKA E SHQIPËRISË  
BASHKIA E TIRANËS

OBJEKTI: "RIKUALIFIKIMI URBAN I ZONËS  
INFORMALE QË KUFIZOHET NGA RRUGËT  
-SABAUDIN GABRANI -JONUZ RAMA-HAMDI  
CULLHAJ-DAMIAN HIMARIOTI-BARI  
ISHKA-VASFI SAMIMI-ALUSH ELMAZ TAKA."

Projektoi :

Ing.A.JAKOVA  
Ing.G.ISLAMI  
Ing.S.MYRSELI  
Ing.P.SHKURTI

Ark.M.DADO  
Ing.Gjeol.Xh.KASMI  
Ing.Mjedis.E.CALI  
Top.A.BECECI

Projektoi :

"S&L STUDIO SH.P.K"

Projektim-kupervizion-cosnulence



FAZA

DORËZIM

PROJEKT ZBATIMI

1.0

PROFILE TËRTHORE  
RRUGA RR.JONUZ RAMA

SHKALLA 1:100

Nr. I FLETËS 003

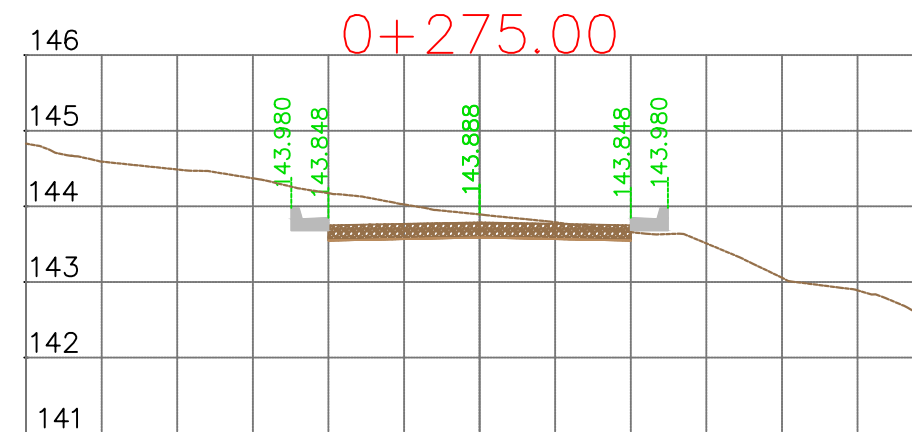
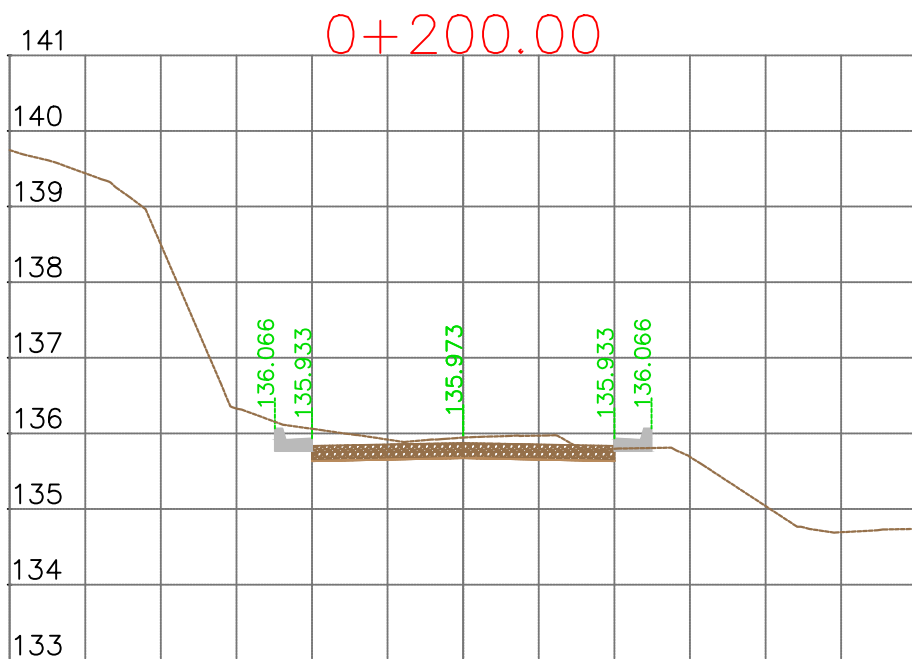
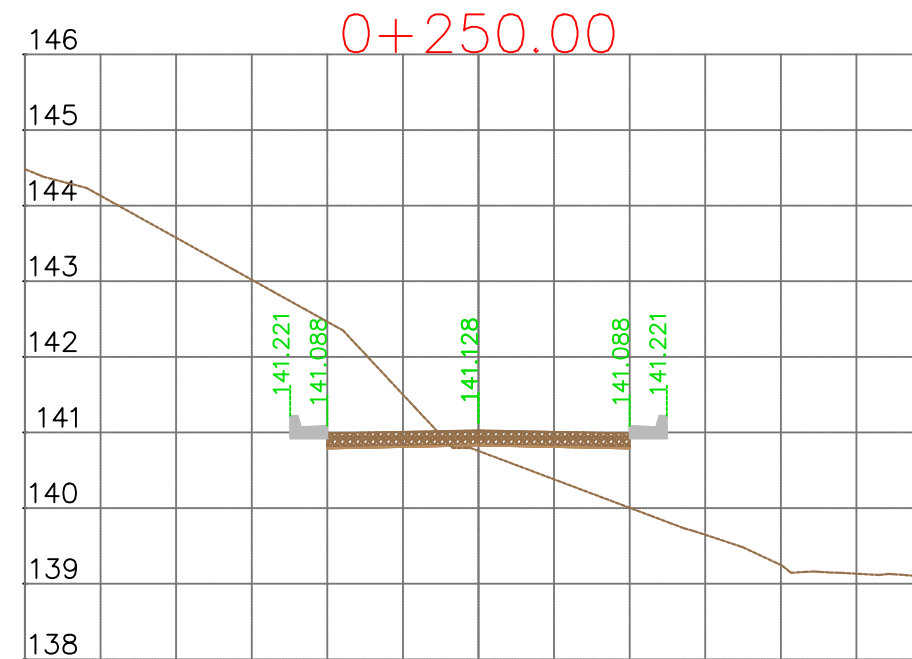
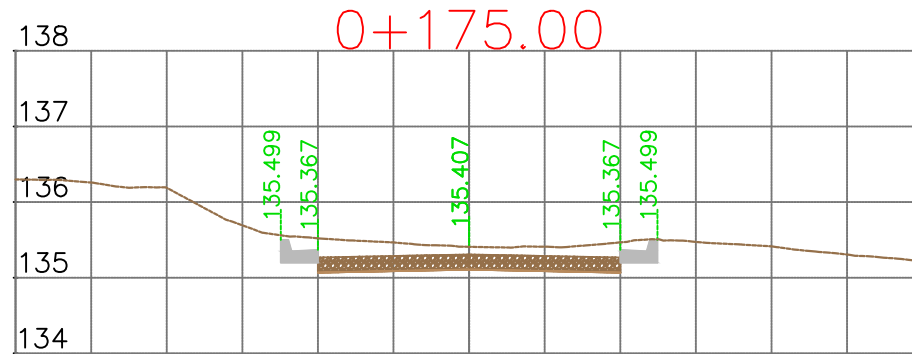
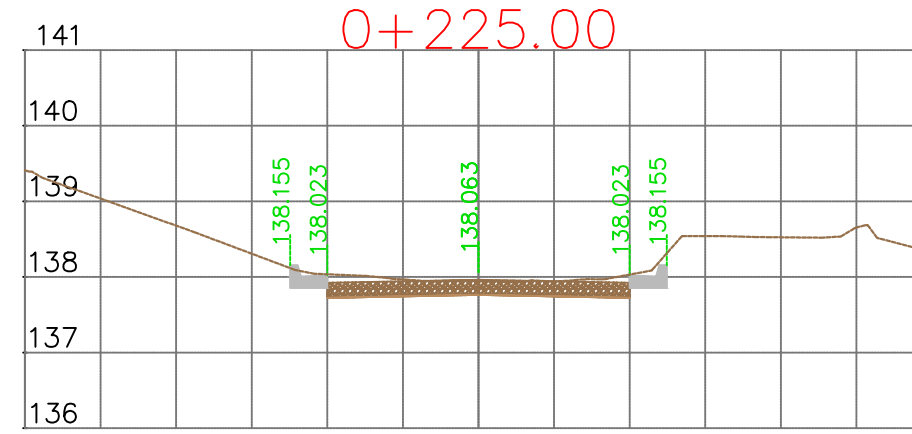
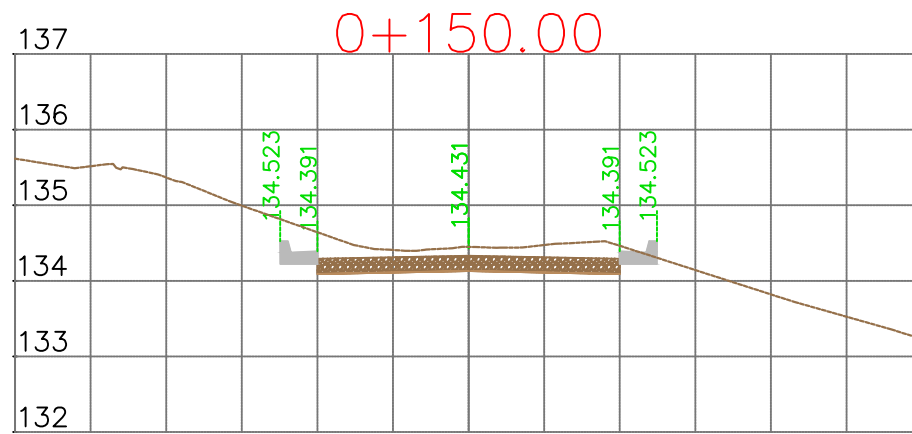

REPUBLIKA E SHQIPËRISË  
BASHKIA E TIRANËS

OBJEKTI: "RIKUALIFIKIMI URBAN I ZONËS  
INFORMALE QË KUFIZOHET NGA RRUGËT  
-SABAUDIN GABRANI -JONUZ RAMA-HAMDI  
CULLHAJ-DAMIAN HIMARIOTI-BARI  
ISHKA-VASFI SAMIMI-ALUSH ELMAZ TAKA."

Projektoi :

Ing.A.JAKOVA  
Ing.G.ISLAMI  
Ing.S.MYRSELI  
Ing.P.SHKURTI

Ark.M.DADO  
Ing.Gjeol.Xh.KASMI  
Ing.Mjedis.E.CALI  
Top.A.BECECI

Projektoi :  
"S&L STUDIO SH.P.K"

Projektim-kupervizion-cosnulence



FAZA

DORËZIM

PROJEKT ZBATIMI

1.0

PROFILE TËRTHORE  
RRUGA RR.JONUZ RAMA

SHKALLA 1:100

Nr. I FLETËS 004

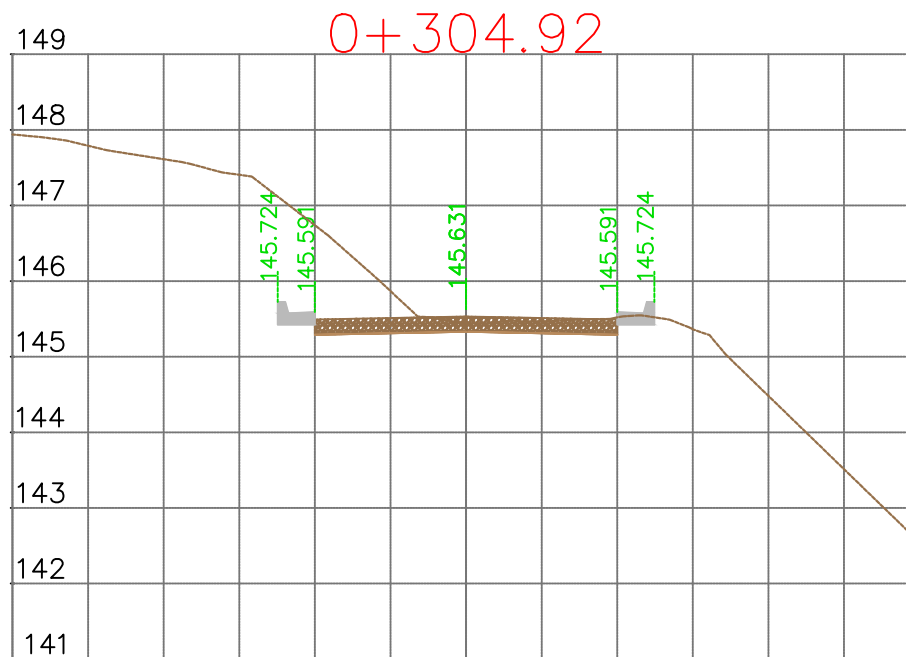
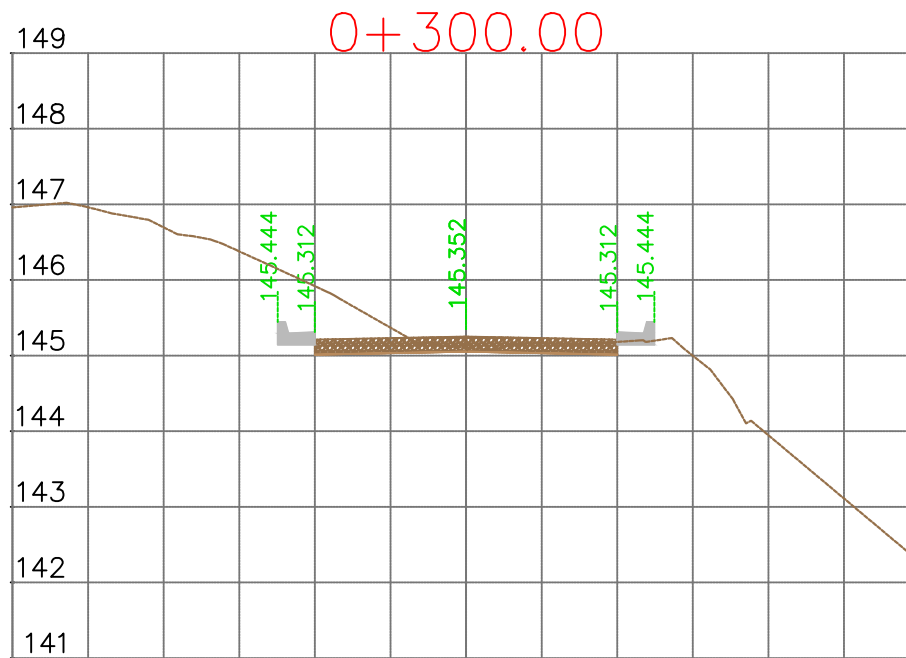

REPUBLIKA E SHQIPËRISË  
BASHKIA E TIRANËS

OBJEKTI: "RIKUALIFIKIMI URBAN I ZONËS  
INFORMALE QË KUFIZOHET NGA RRUGËT  
-SABAUDIN GABRANI -JONUZ RAMA-HAMDI  
CULLHAJ-DAMIAN HIMARIOTI-BARI  
ISHKA-VASFI SAMIMI-ALUSH ELMAZ TAKA."

Projektoi :

Ing.A.JAKOVA  
Ing.G.ISLAMI  
Ing.S.MYRSELI  
Ing.P.SHKURTI

Ark.M.DADO  
Ing.Gjeol.Xh.KASMI  
Ing.Mjedis.E.CALI  
Top.A.BECECI

Projektoi :

**"S&L STUDIO SH.P.K"**

Projektim-kupervizion-cosnulence



FAZA

DORËZIM

PROJEKT ZBATIMI

1.0

PROFILE TËRTHORE  
RRUGA RR.JONUZ RAMA

SHKALLA 1:100

Nr. I FLETËS 005

*07-PLANI I SINJALISTIKËS RRUGORE*

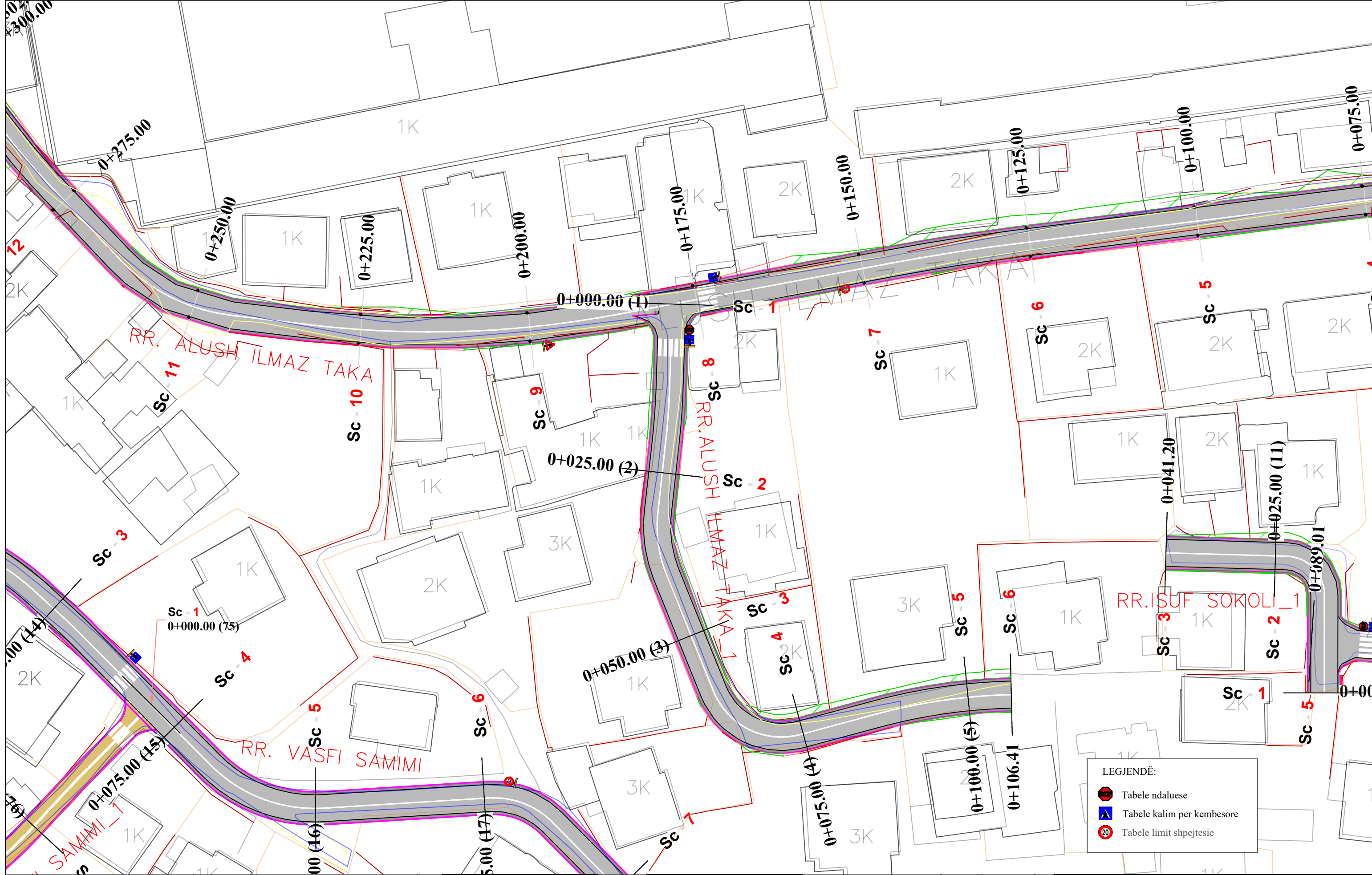

OBJEKTI: "RIKUALIFIKIMI URBAN I ZONËS INFORMALE QË KUFIZOHET NGA RRUGËT -SABAUDIN GABRANI -JONUZ RAMA-HAMDI CULLHAJ-DAMIAN HIMARIOTI-BARI ISHKA-VASFI SAMIMI-ALUSH ELMAZ TAKA."

Projektoi :  
Ing.A.JAKOVA  
Ing.G.ISLAMI  
Ing.S.MYRSELI  
Ing.P.SHKURTI

Ark.M.DADO  
Ing.Gjeol.Xh.KASMI  
Ing.Mjedis.E.CALI  
Top.A.BECECI

Projektoi :  
"S&L STUDIO SH.P.K"  
Projektim-kupervizion-cosnulence

PROJEKTIM DESIGN  
SUPERVISION KOLAUDIM

FAZA  
DORËZIM

PROJEKT ZBATIMI  
1.0

PLANIMETRI  
RRUGA RR.ALUSH ILMAZ TAKA1

|              |       |
|--------------|-------|
| SHKALLA      | 1:500 |
| Nr. I FLETËS | 001   |



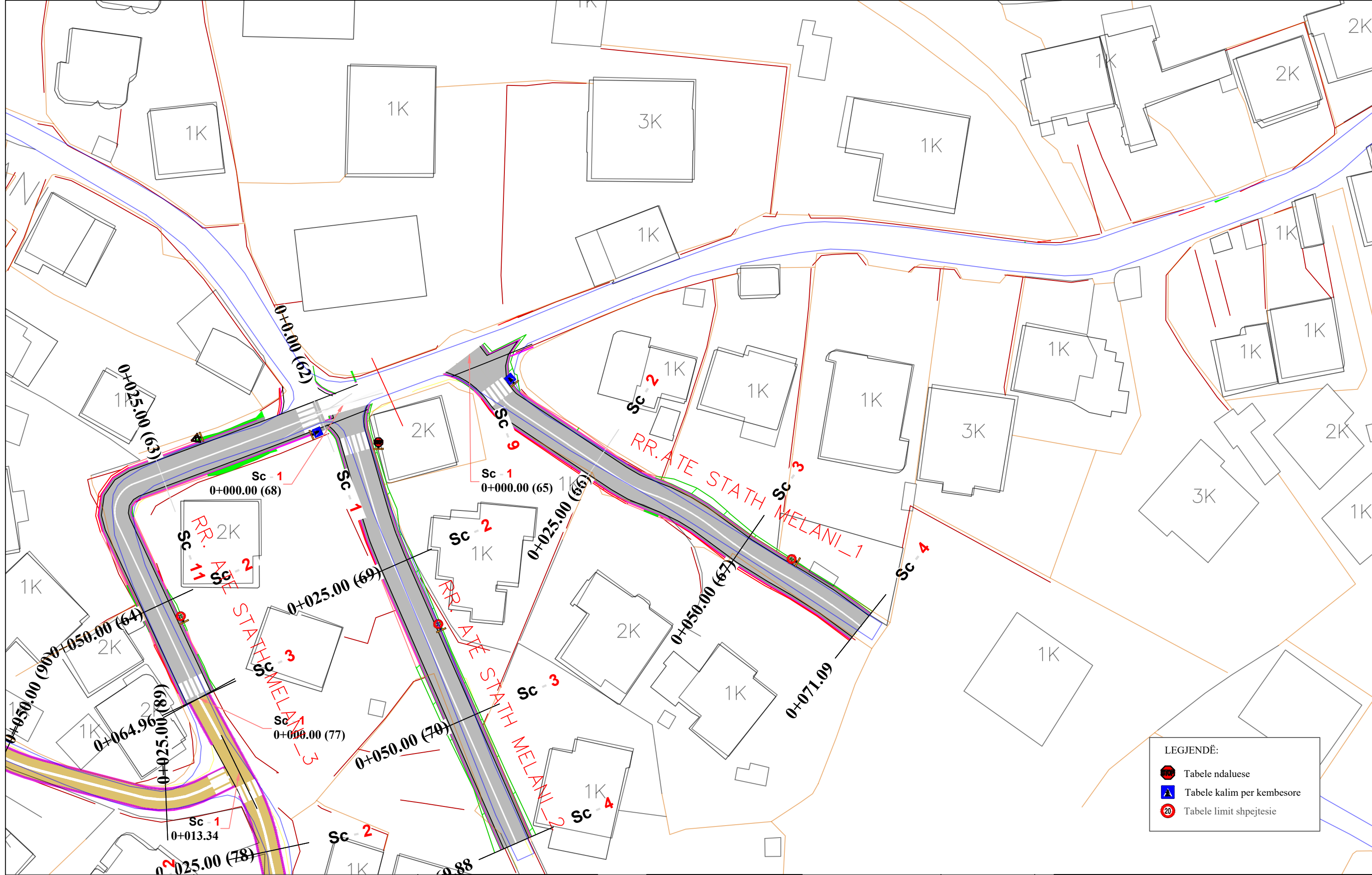

LEGJENDË:

- Tabele ndaluese
- Tabele kalim per kembesore
- Tabele limit shpejtesie

REPUBLIKA E SHQIPËRISË  
BASHKIA E TIRANËS

OBJEKTI: "RIKUALIFIKIMI URBAN I ZONËS INFORMALE QË KUFIZOHET NGA RRUGËT -SABAUDIN GABRANI -JONUZ RAMA-HAMDI CULLHAJ-DAMIAN HIMARIOTI-BARI ISHKA-VASFI SAMIMI-ALUSH ELMAZ TAKA."

Projektoi :  
Ing.A.JAKOVA  
Ing.G.ISLAMI  
Ing.S.MYRSELI  
Ing.P.SHKURTI

Ark.M.DADO  
Ing.Gjeol.Xh.KASMI  
Ing.Mjedis.E.CALI  
Top.A.BECECI

Projektoi :  
**"S&L STUDIO SH.P.K"**  
Projektim-kupervizion-cosnulence

PROJEKTIM DESIGN  
SUPERVISION KOLAUDIM

FAZA  
DORËZIM

PROJEKT ZBATIMI  
1.0

PLANIMETRI  
RRUGA RR.ATE STATH MELANI 1

SHKALLA 1:500  
Nr. I FLETËS 001

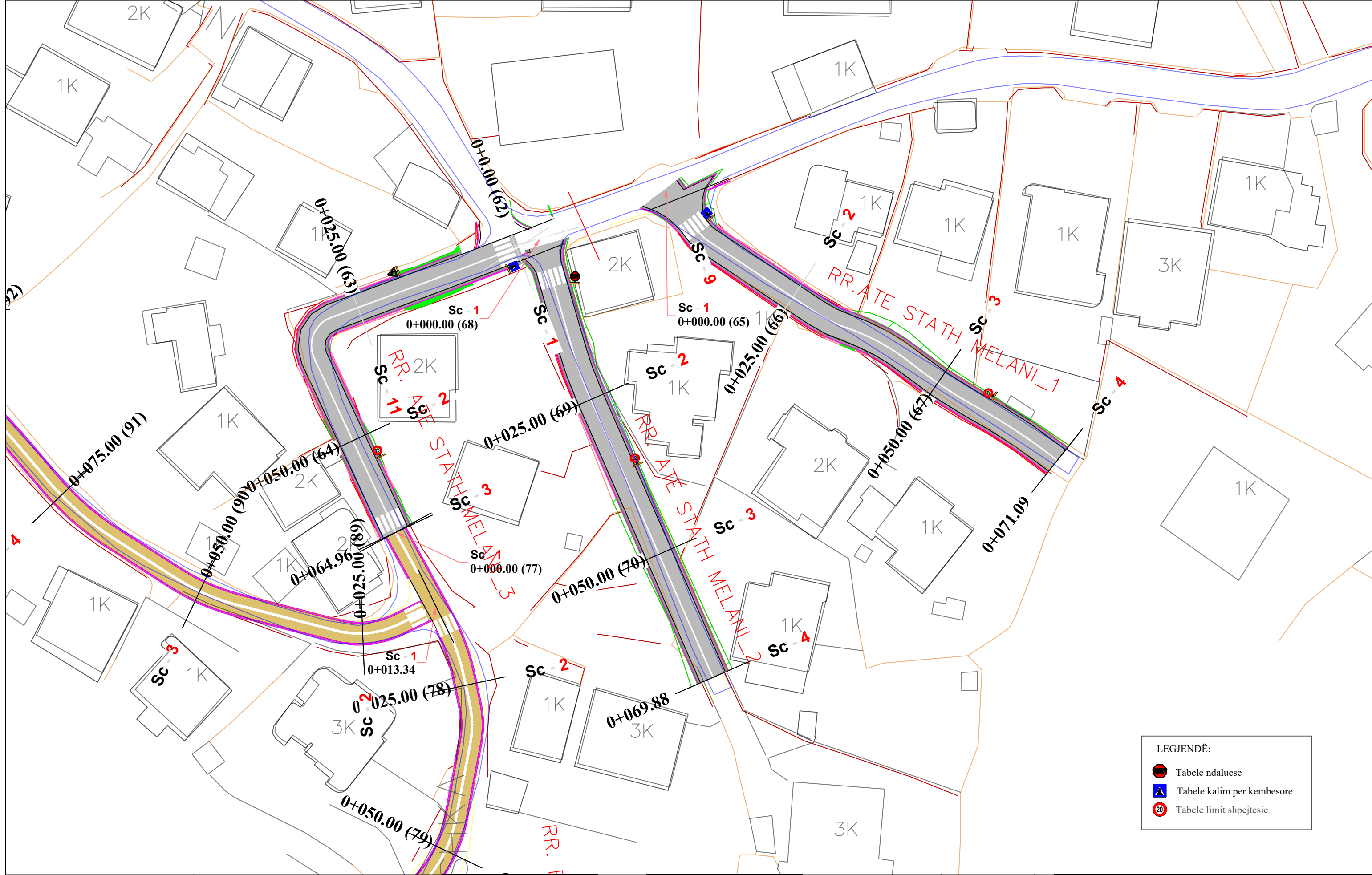

LEGJENDË:

|  |                            |
|--|----------------------------|
|  | Tabele ndaluese            |
|  | Tabele kalim per kembesore |
|  | Tabele limit shpejtesie    |



OBJEKTI: "RIKUALIFIKIMI URBAN I ZONËS INFORMALE QË KUFIZOHET NGA RRUGËT -SABAUDIN GABRANI -JONUZ RAMA-HAMDI CULLHAJ-DAMIAN HIMARIOTI-BARI ISHKA-VASFI SAMIMI-ALUSH ELMAZ TAKA."

Projektoi :  
Ing.A.JAKOVA  
Ing.G.ISLAMI  
Ing.S.MYRSELI  
Ing.P.SHKURTI  
Ark.M.DADO  
Ing.Gjeol.Xh.KASMI  
Ing.Mjedis.E.CALI  
Top.A.BECECI

Projektoi :  
"S&L STUDIO SH.P.K"  
Projektim-kupervizion-cosnulence  
**R A L D - G**  
PROJEKTIM DESIGN  
SUPERVISION KOLAUDIM

FAZA  
DORËZIM

PROJEKT ZBATIMI  
1.0

PLANIMETRI  
RRUGA RR.ATE STATH MELANI 2  
SHKALLA 1:500  
Nr. I FLETËS 001

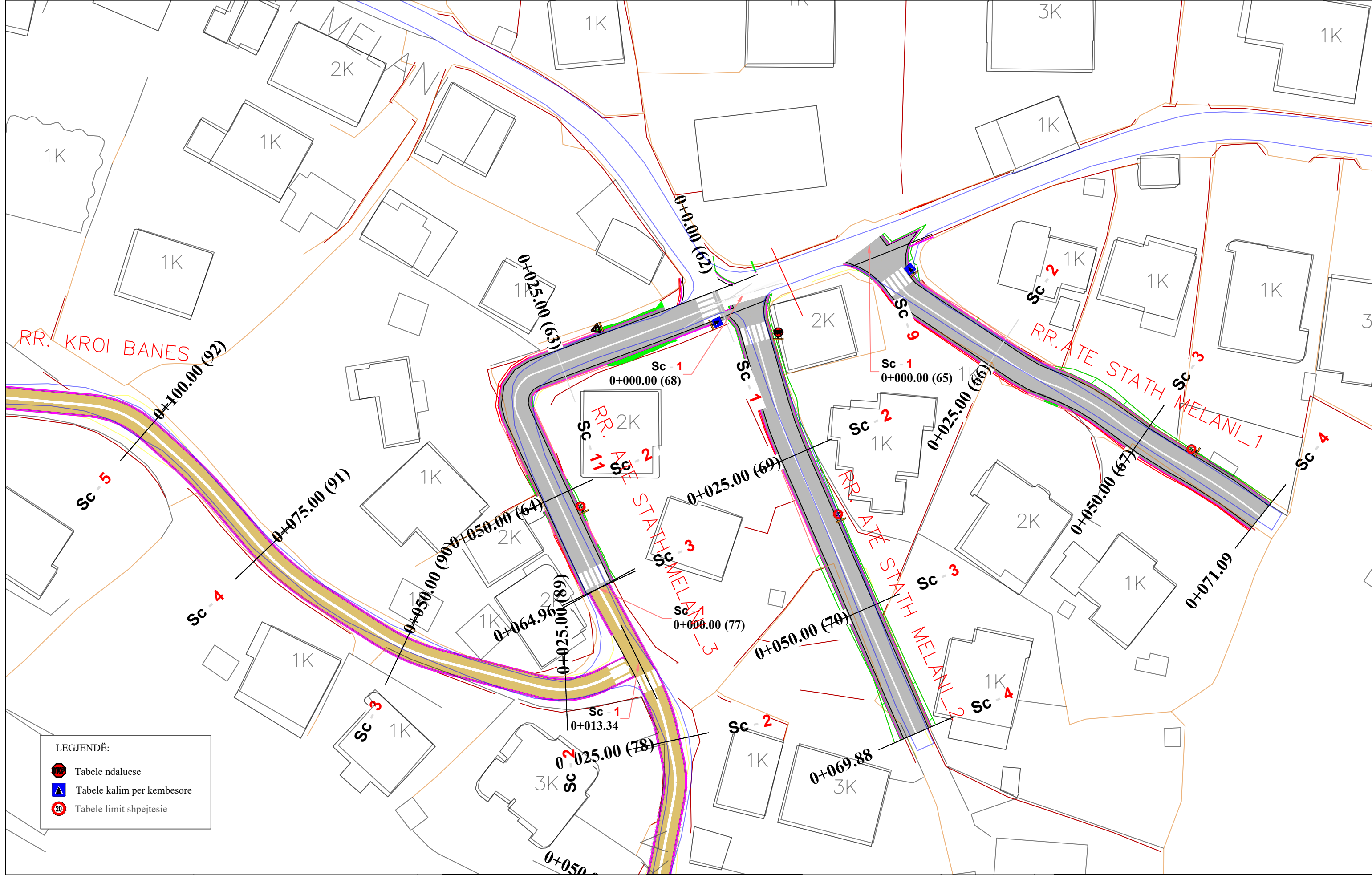

LEGJENDË:

|  |                            |
|--|----------------------------|
|  | Tabele ndaluese            |
|  | Tabele kalim per kembesore |
|  | Tabele limit shpejtesie    |



REPUBLIKA E SHQIPËRISË  
BASHKIA E TIRANËS

OBJEKTI: "RIKUALIFIKIMI URBAN I ZONËS INFORMALE QË KUFIZOHET NGA RRUGËT -SABAUDIN GABRANI -JONUZ RAMA-HAMDI CULLHAJ-DAMIAN HIMARIOTI-BARI ISHKA-VASFI SAMIMI-ALUSH ELMAZ TAKA."

Projektoi :  
Ing.A.JAKOVA  
Ing.G.ISLAMI  
Ing.S.MYRSELI  
Ing.P.SHKURTI  
Ark.M.DADO  
Ing.Gjeol.Xh.KASMI  
Ing.Mjedis.E.CALI  
Top.A.BECECI

Projektoi :  
"S&L STUDIO SH.P.K"  
Projektim-kupervizion-cosnulence  

FAZA  
DORËZIM

PROJEKT ZBATIMI  
1.0

PLANIMETRI  
RRUGA RR.ATE STATH MELANI 3  
SHKALLA 1:500  
Nr. I FLETËS 001

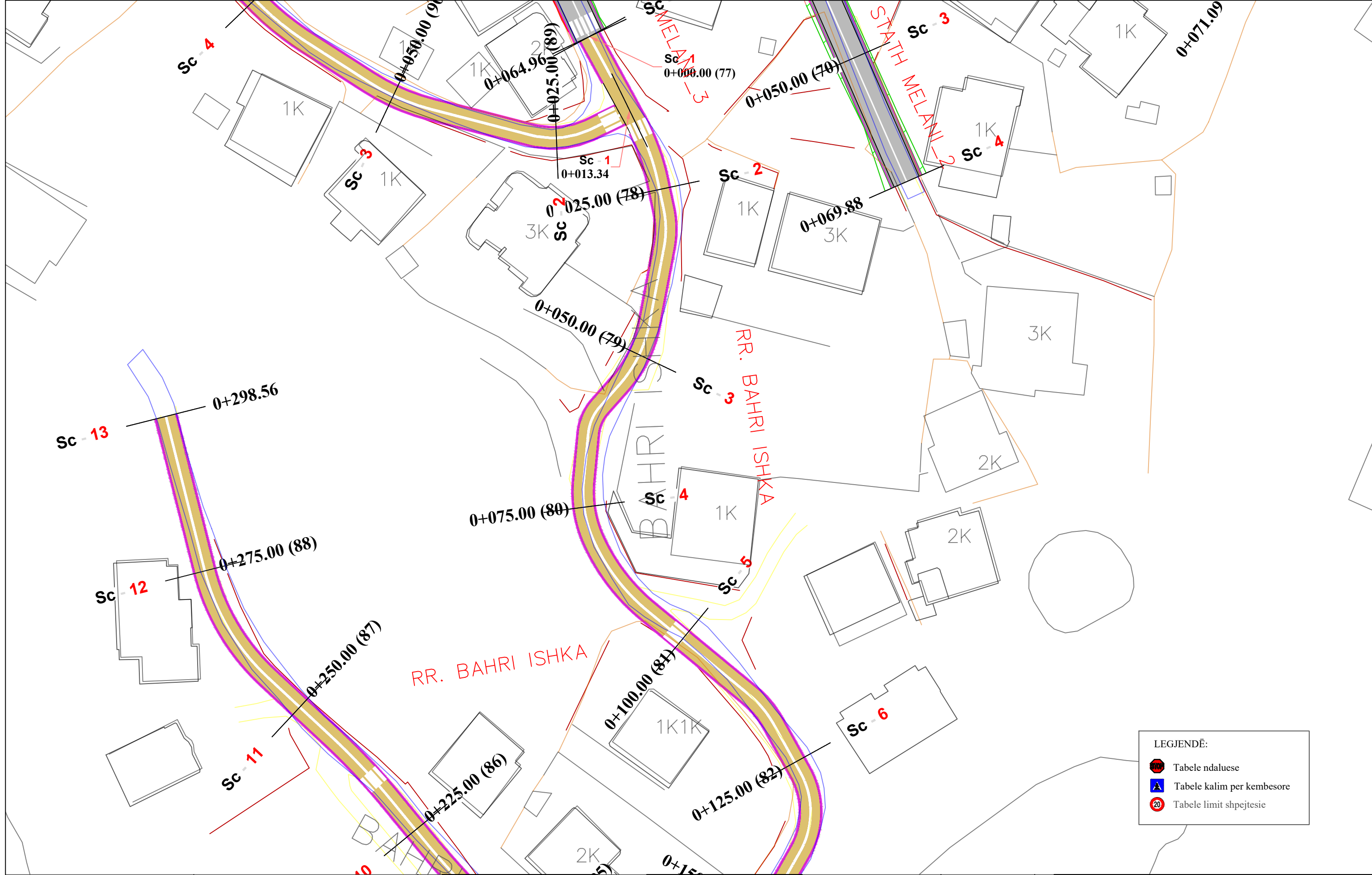

LEGJENDË:

|  |                            |
|--|----------------------------|
|  | Tabele ndaluese            |
|  | Tabele kalim per kembesore |
|  | Tabele limit shpejtesie    |



OBJEKTI: "RIKUALIFIKIMI URBAN I ZONËS INFORMALE QË KUFIZOHET NGA RRUGËT -SABAUDIN GABRANI -JONUZ RAMA-HAMDI CULLHAJ-DAMIAN HIMARIOTI-BARI ISHKA-VASFI SAMIMI-ALUSH ELMAZ TAKA."

Projektoi :  
Ing.A.JAKOVA  
Ing.G.ISLAMI  
Ing.S.MYRSELI  
Ing.P.SHKURTI

Ark.M.DADO  
Ing.Gjeol.Xh.KASMI  
Ing.Mjedis.E.CALI  
Top.A.BECECI

Projektoi :  
"S&L STUDIO SH.P.K"  
Projektim-kupervizion-cosnulence

PROJEKTIM DESIGN  
SUPERVISION KOLAUDIM

FAZA  
DORËZIM

PROJEKT ZBATIMI  
1.0

PLANIMETRI  
RRUGA RR.BARI ISHKA

|              |       |
|--------------|-------|
| SHKALLA      | 1:500 |
| Nr. I FLETËS | 001   |

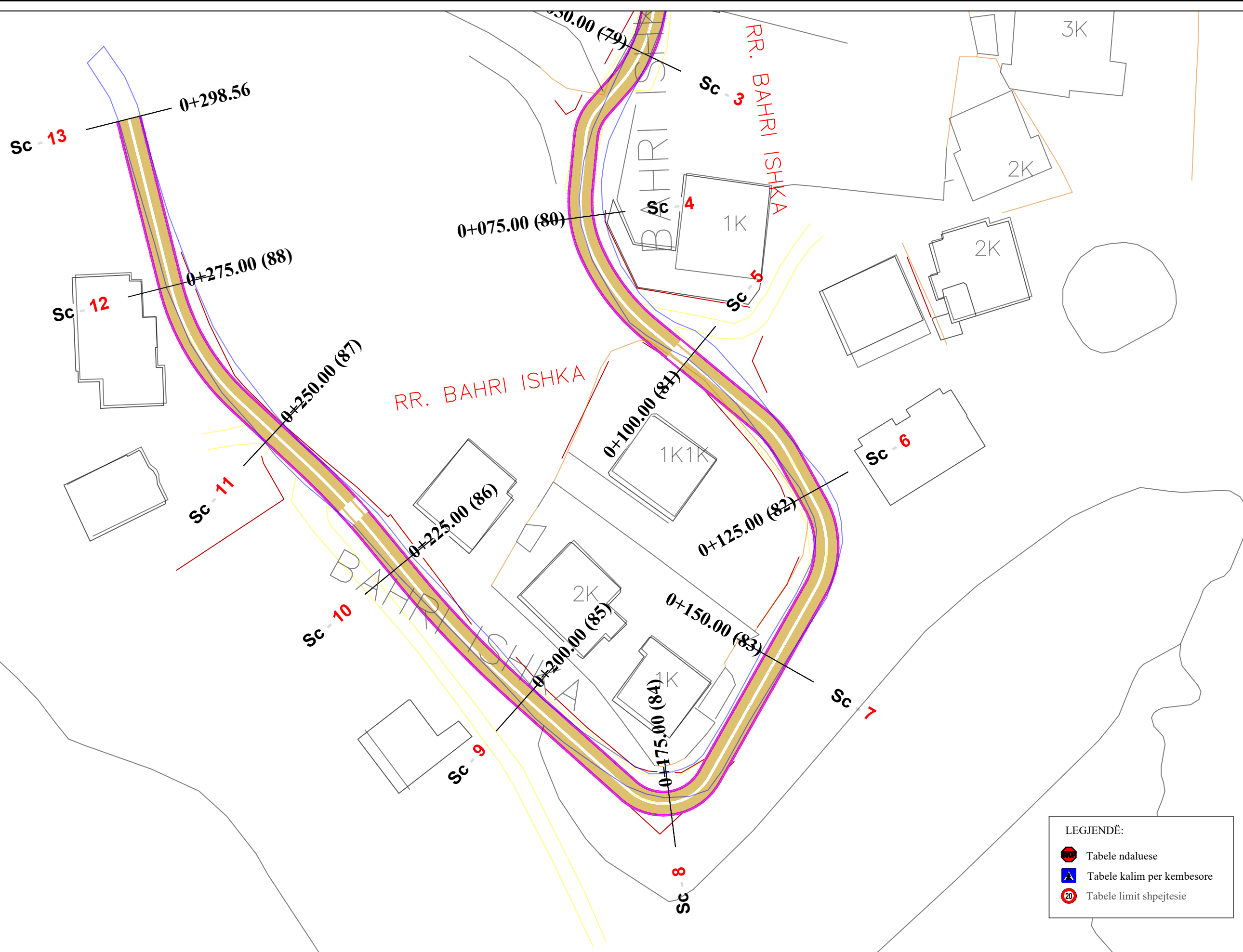

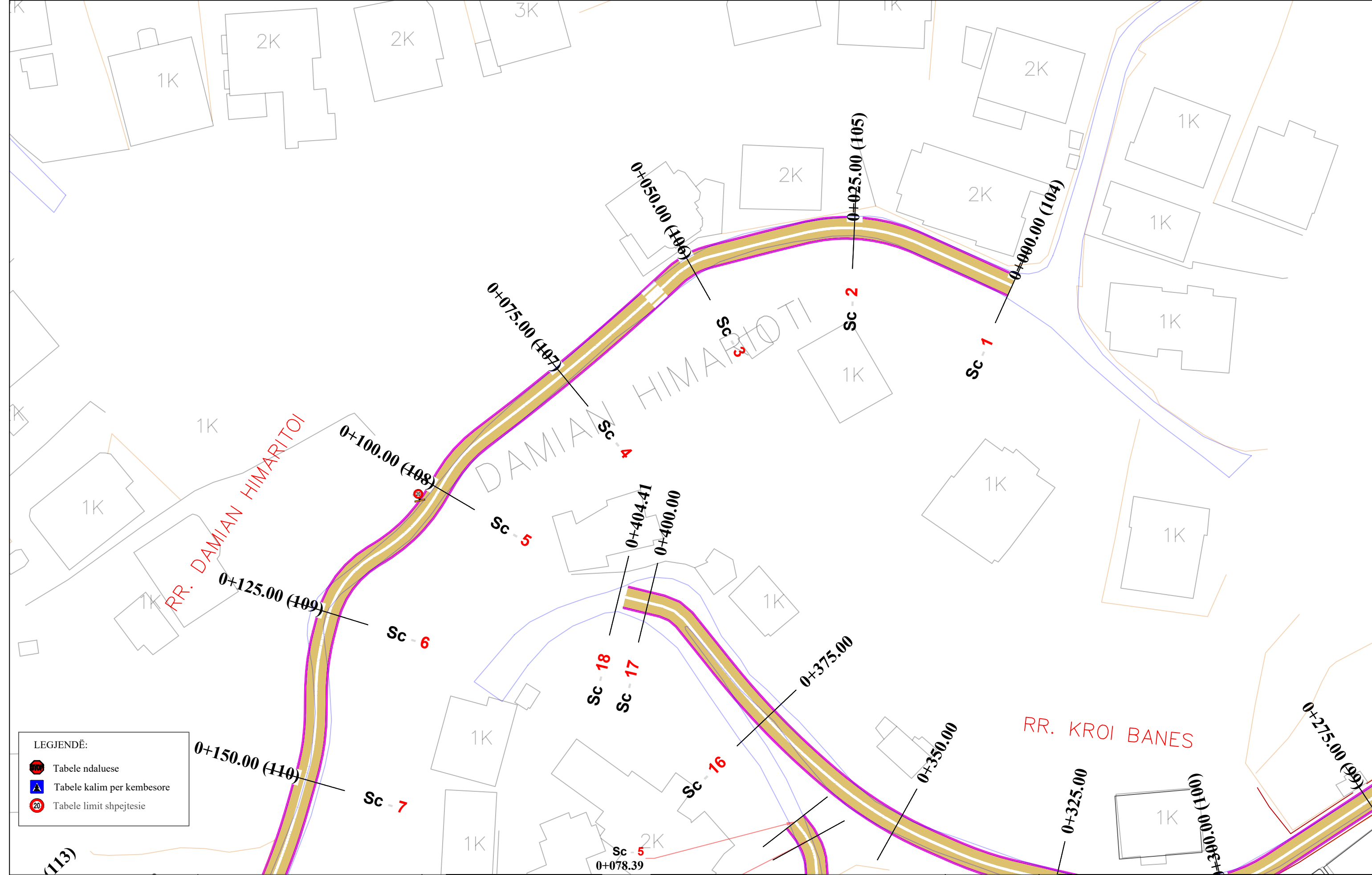

**LEGJENDË:**

- Tabele ndaluese
- Tabele kalim per kembesore
- Tabele limit shpejtesie

REPUBLIKA E SHQIPËRISË  
BASHKIA E TIRANËS

OBJEKTI: "RIKUALIFIKIMI URBAN I ZONËS INFORMALE QË KUFIZOHET NGA RRUGËT -SABAUDIN GABRANI -JONUZ RAMA-HAMDI CULLHAJ-DAMIAN HIMARIOTI-BARI ISHKA-VASFI SAMIMI-ALUSH ELMAZ TAKA."

Projektoi :  
 Ing.A.JAKOVA  
 Ing.G.ISLAMI  
 Ing.S.MYRSELI  
 Ing.P.SHKURTI

Ark.M.DADO  
 Ing.Gjeol.Xh.KASMI  
 Ing.Mjedis.E.CALI  
 Top.A.BECECI

Projektoi :  
**"S&L STUDIO SH.P.K"**  
 Projektim-kupervizion-cosnulence

PROJEKTIM DESIGN  
SUPERVISION KOLAUDIM

|         |                 |
|---------|-----------------|
| FAZA    | PROJEKT ZBATIMI |
| DORËZIM | 1.0             |

|   |       |
|---|-------|
| PLANIMETRI<br>RRUGA RR.DAMIAN HIMARITOI |       |
| SHKALLA                                 | 1:500 |
| Nr. I FLETËS                            | 001   |

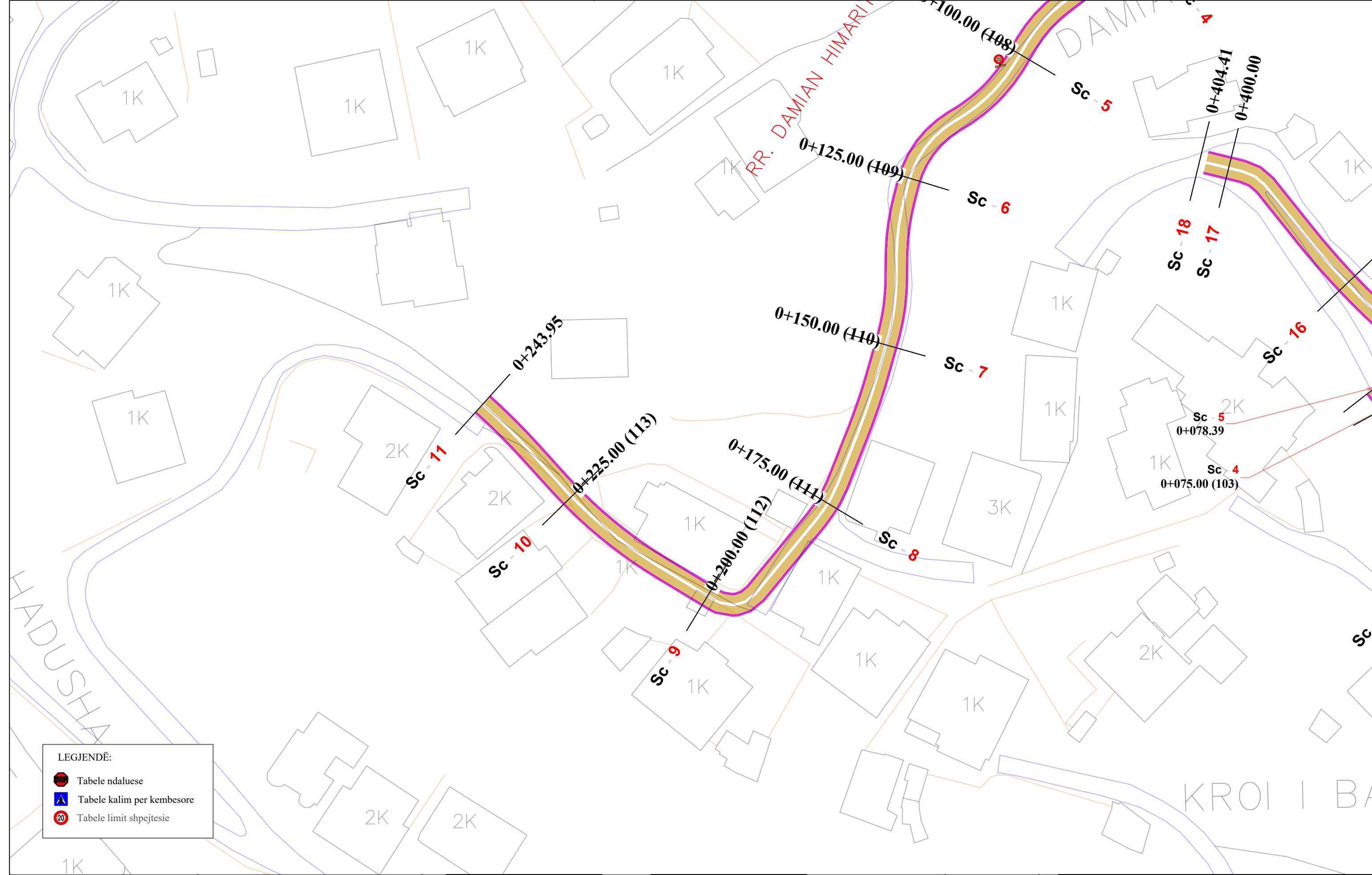

**LEGJENDË:**

|  |                            |
|--|----------------------------|
|  | Tabele ndaluese            |
|  | Tabele kalim per kembesore |
|  | Tabele limit shpejtesie    |



REPUBLIKA E SHQIPËRISË  
BASHKIA E TIRANËS

OBJEKTI: "RIKUALIFIKIMI URBAN I ZONËS INFORMALE QË KUFIZOHET NGA RRUGËT -SABAUDIN GABRANI -JONUZ RAMA-HAMDI CULLHAJ-DAMIAN HIMARIOTI-BARI ISHKA-VASFI SAMIMI-ALUSH ELMAZ TAKA."

Projektoi :  
Ing.A.JAKOVA  
Ing.G.ISLAMI  
Ing.S.MYRSELI  
Ing.P.SHKURTI

Ark.M.DADO  
Ing.Gjeol.Xh.KASMI  
Ing.Mjedis.E.CALI  
Top.A.BECECI

Projektoi :  
**"S&L STUDIO SH.P.K"**  
Projektim-kupervizion-cosnulence



PROJEKTIM DESIGN  
SUPERVISION KOLAUDIM

FAZA  
DORËZIM

PROJEKT ZBATIMI  
1.0

PLANIMETRI  
RRUGA RR.DAMIAN HIMARITOI

|              |       |
|--------------|-------|
| SHKALLA      | 1:500 |
| Nr. I FLETËS | 002   |

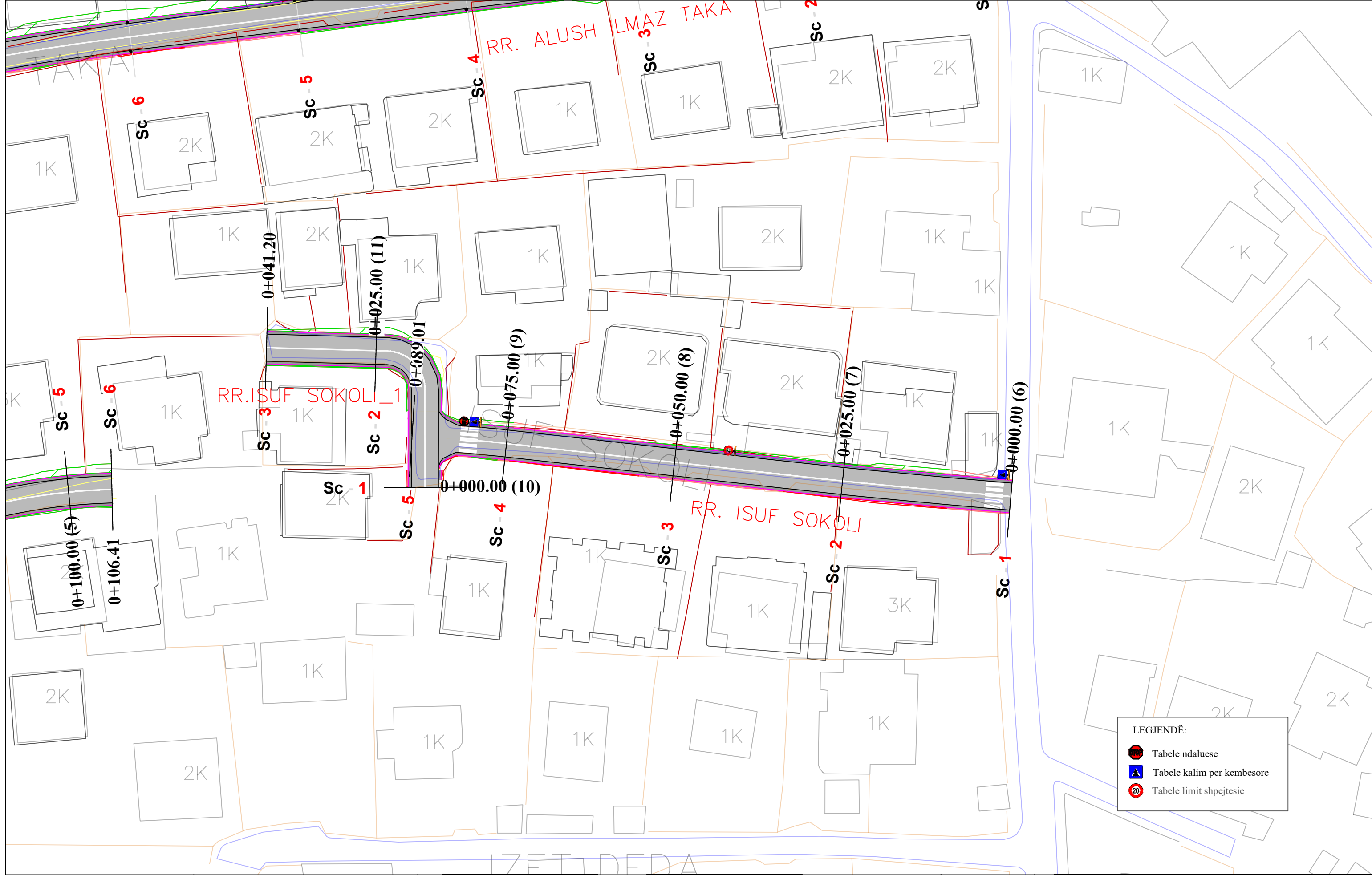



IZETI DEDA

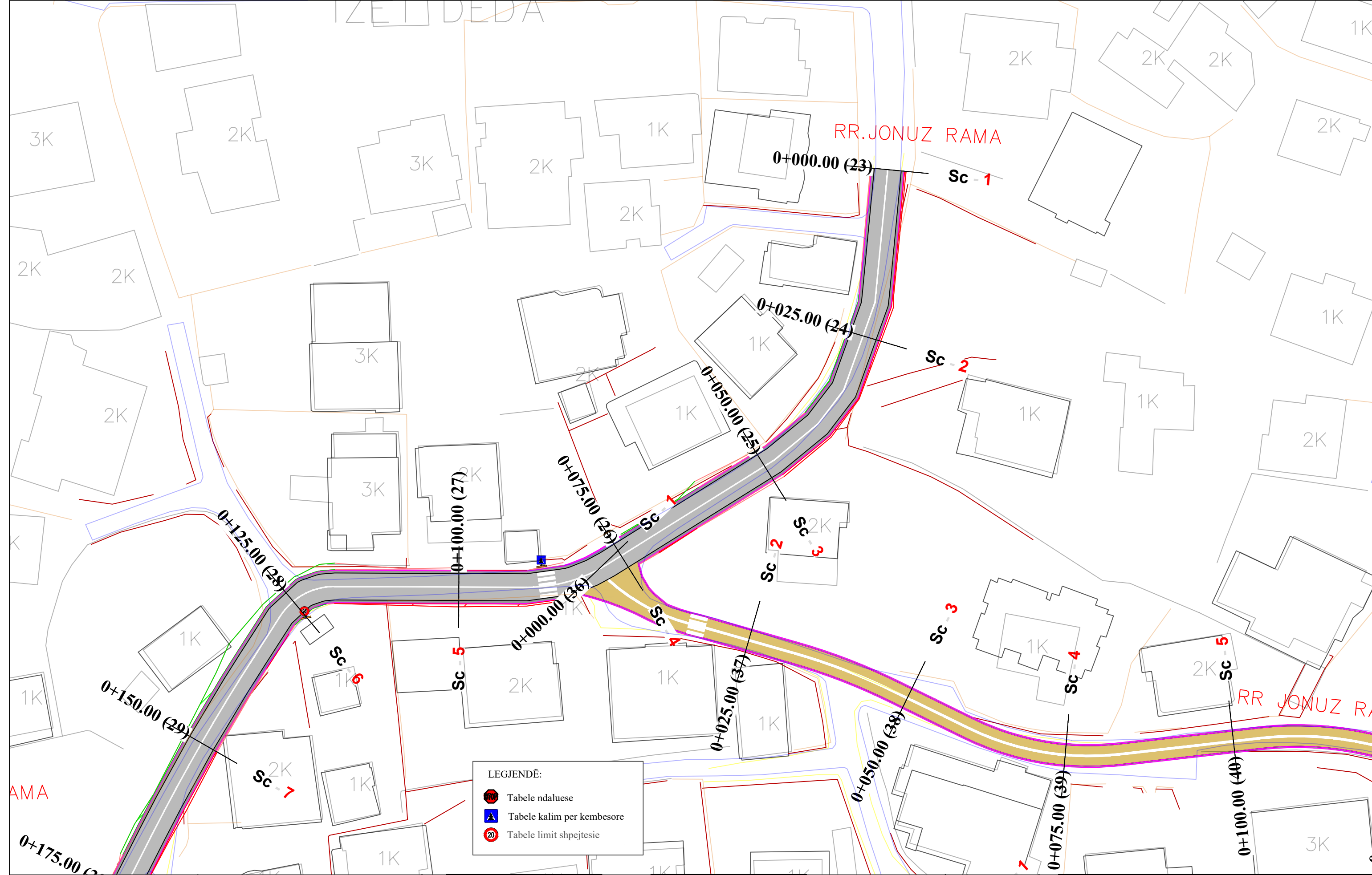

**LEGJENDË:**

- Tabele ndaluese
- Tabele kalim per kembesore
- Tabele limit shpejtesie



REPUBLIKA E SHQIPËRISË  
BASHKIA E TIRANËS

OBJEKTI: "RIKUALIFIKIMI URBAN I ZONËS INFORMALE QË KUFIZOHET NGA RRUGËT -SABAUDIN GABRANI -JONUZ RAMA-HAMDI CULLHAJ-DAMIAN HIMARIOTI-BARI ISHKA-VASFI SAMIMI-ALUSH ELMAZ TAKA."

Projektoi :  
Ing.A.JAKOVA Ark.M.DADO  
Ing.G.ISLAMI Ing.Gjeol.Xh.KASMI  
Ing.S.MYRSELI Ing.Mjedis.E.CALI  
Ing.P.SHKURTI Top.A.BECECI

Projektoi :  
**"S&L STUDIO SH.P.K"**  
Projektim-kupervizion-cosnulence  

FAZA  
DORËZIM

PROJEKT ZBATIMI  
1.0

PLANIMETRI  
RRUGA RR.JONUZ RAMA  
SHKALLA 1:500  
Nr. I FLETËS 001

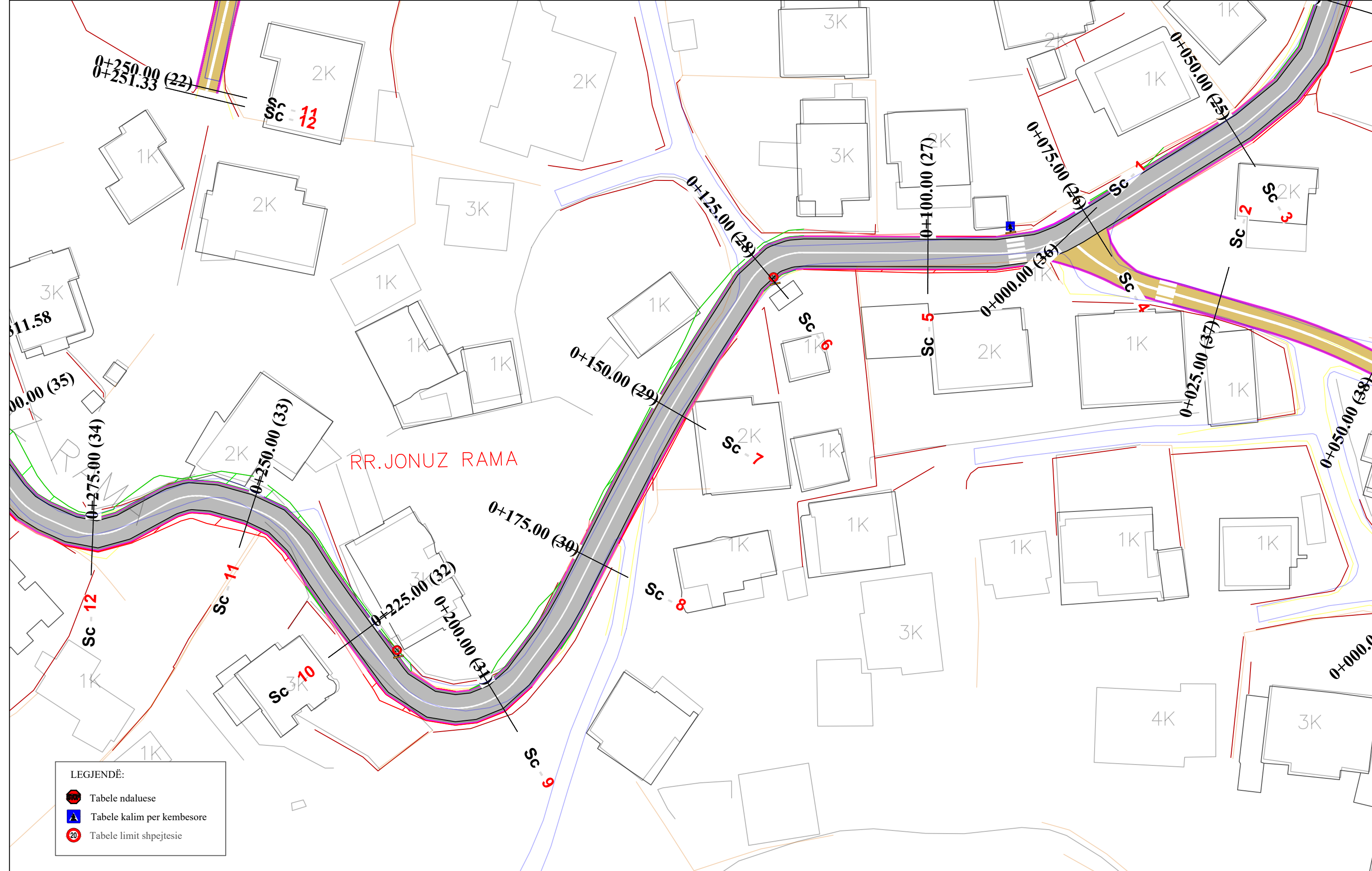

LEGJENDË:

|  |                            |
|--|----------------------------|
|  | Tabele ndaluese            |
|  | Tabele kalim per kembesore |
|  | Tabele limit shpejtesie    |



OBJEKTI: "RIKUALIFIKIMI URBAN I ZONËS INFORMALE QË KUFIZOHET NGA RRUGËT -SABAUDIN GABRANI -JONUZ RAMA-HAMDI CULLHAJ-DAMIAN HIMARIOTI-BARI ISHKA-VASFI SAMIMI-ALUSH ELMAZ TAKA."

Projektoi :  
Ing.A.JAKOVA  
Ing.G.ISLAMI  
Ing.S.MYRSELI  
Ing.P.SHKURTI

Ark.M.DADO  
Ing.Gjeol.Xh.KASMI  
Ing.Mjedis.E.CALI  
Top.A.BECECI

Projektoi :  
"S&L STUDIO SH.P.K"  
Projektim-kupervizion-cosnulence

PROJEKTIM DESIGN  
SUPERVISION KOLAUDIM

|         |                 |
|---------|-----------------|
| FAZA    | PROJEKT ZBATIMI |
| DORËZIM | 1.0             |

|                                   |       |
|-----------------------------------|-------|
| PLANIMETRI<br>RRUGA RR.JONUZ RAMA |       |
| SHKALLA                           | 1:500 |
| Nr. I FLETËS                      | 002   |

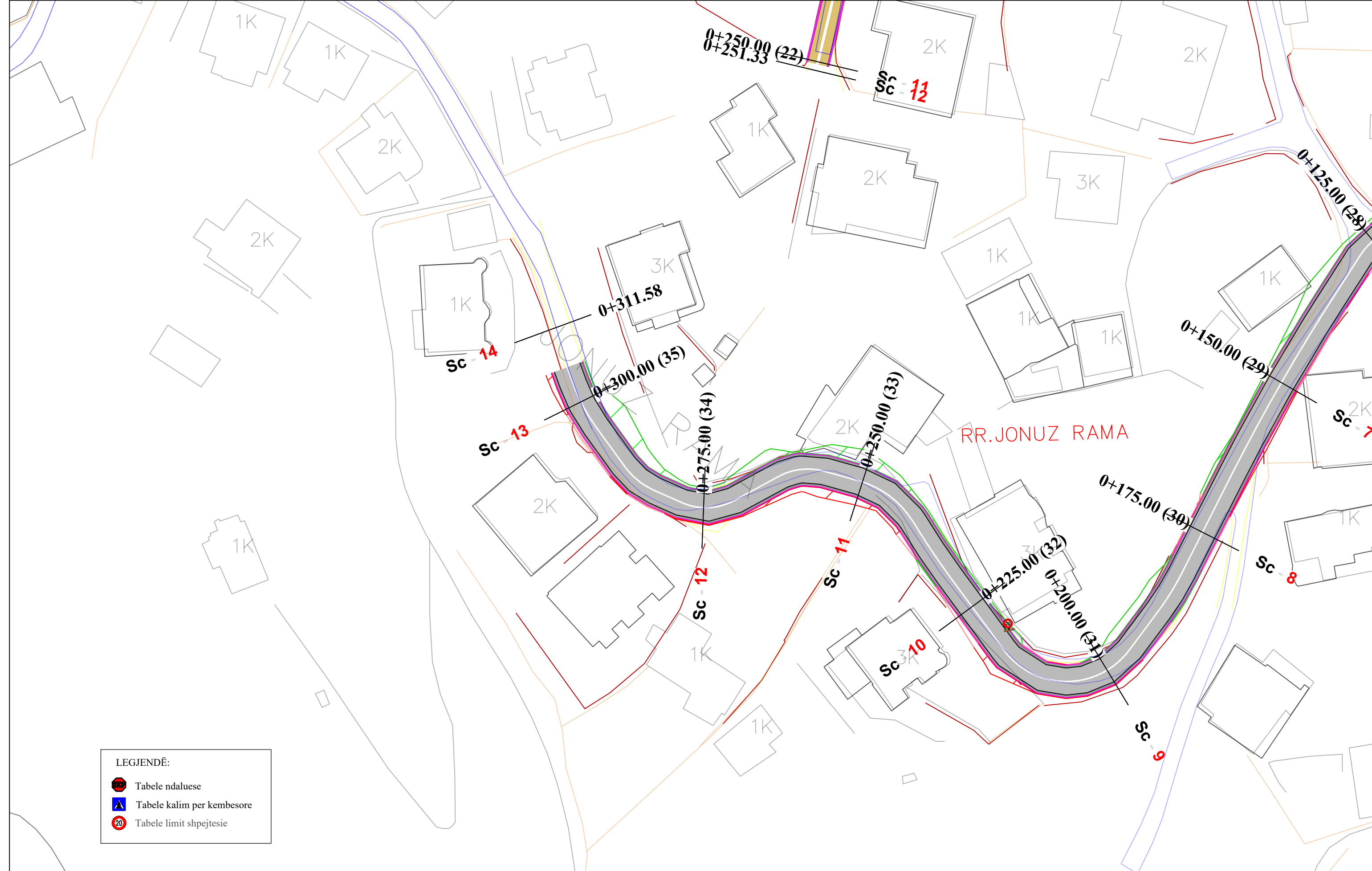

LEGJENDË:

|  |                            |
|--|----------------------------|
|  | Tabele ndaluese            |
|  | Tabele kalim per kembesore |
|  | Tabele limit shpejtesie    |



REPUBLIKA E SHQIPËRISË  
BASHKIA E TIRANËS

OBJEKTI: "RIKUALIFIKIMI URBAN I ZONËS INFORMALE QË KUFIZOHET NGA RRUGËT -SABAUDIN GABRANI -JONUZ RAMA-HAMDI CULLHAJ-DAMIAN HIMARIOTI-BARI ISHKA-VASFI SAMIMI-ALUSH ELMAZ TAKA."

Projektoi :  
Ing.A.JAKOVA  
Ing.G.ISLAMI  
Ing.S.MYRSELI  
Ing.P.SHKURTI

Ark.M.DADO  
Ing.Gjeol.Xh.KASMI  
Ing.Mjedis.E.CALI  
Top.A.BECECI

Projektoi :  
"S&L STUDIO SH.P.K"  
Projektim-kupervizion-cosnulence



PROJEKTIM DESIGN  
SUPERVISION KOLAUDIM

FAZA  
DORËZIM

PROJEKT ZBATIMI  
1.0

|                                   |       |
|-----------------------------------|-------|
| PLANIMETRI<br>RRUGA RR.JONUZ RAMA |       |
| SHKALLA                           | 1:500 |
| Nr. I FLETËS                      | 003   |

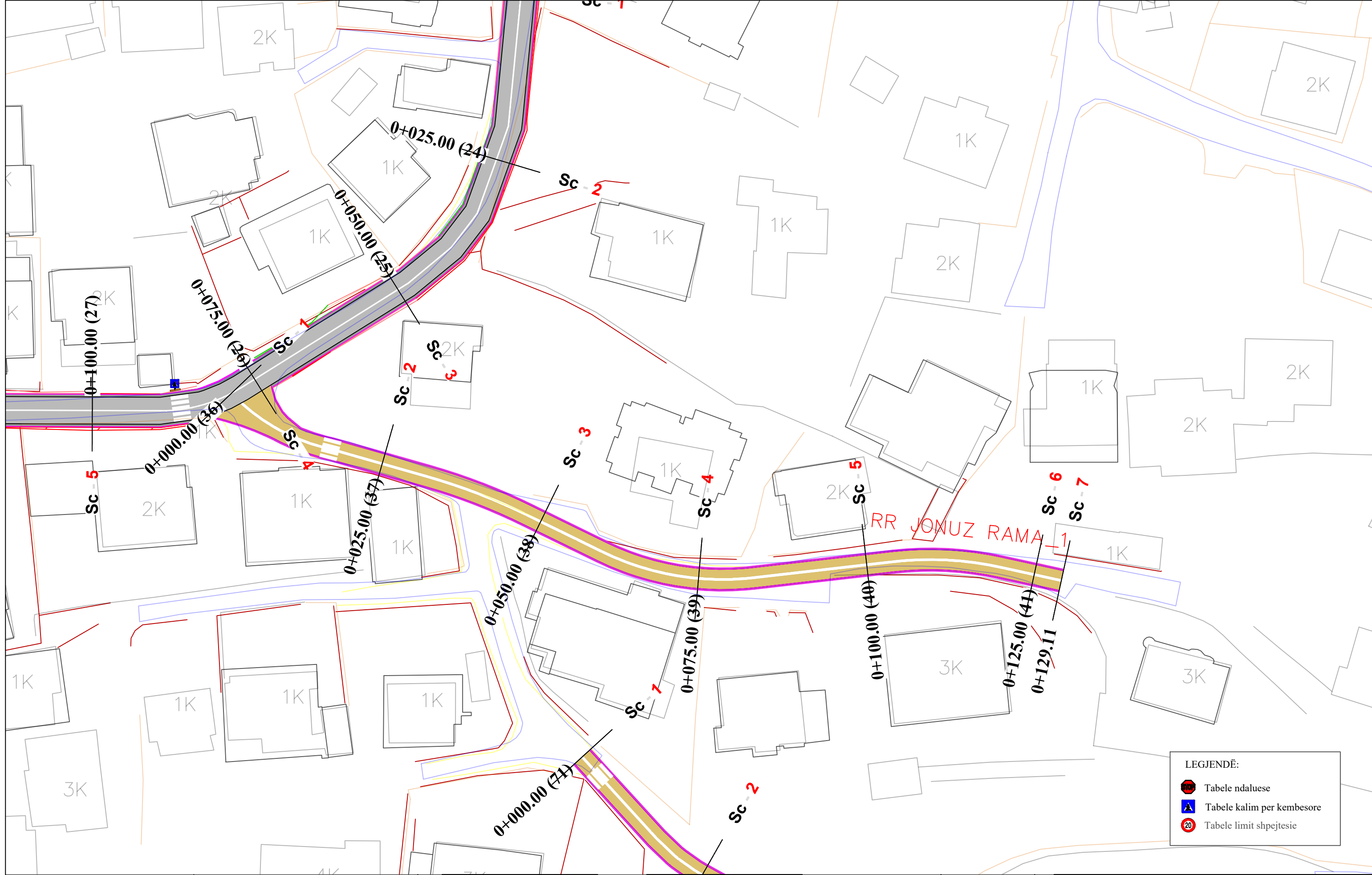

REPUBLIKA E SHQIPËRISË  
BASHKIA E TIRANËS

OBJEKTI: "RIKUALIFIKIMI URBAN I ZONËS INFORMALE QË KUFIZOHET NGA RRUGËT -SABAUDIN GABRANI -JONUZ RAMA-HAMDI CULLHAJ-DAMIAN HIMARIOTI-BARI ISHKA-VASFI SAMIMI-ALUSH ELMAZ TAKA."

Projektoi :

Ing.A.JAKOVA  
Ing.G.ISLAMI  
Ing.S.MYRSELI  
Ing.P.SHKURTI

Ark.M.DADO  
Ing.Gjeol.Xh.KASMI  
Ing.Mjedis.E.CALI  
Top.A.BECECI

Projektoi :  
"S&L STUDIO SH.P.K"

Projektim-kupervizion-cosnulence



FAZA

DORËZIM

PROJEKT ZBATIMI

1.0

PLANIMETRI  
RRUGA RR.JONUZ RAMA 1

SHKALLA 1:500

Nr. I FLETËS 001

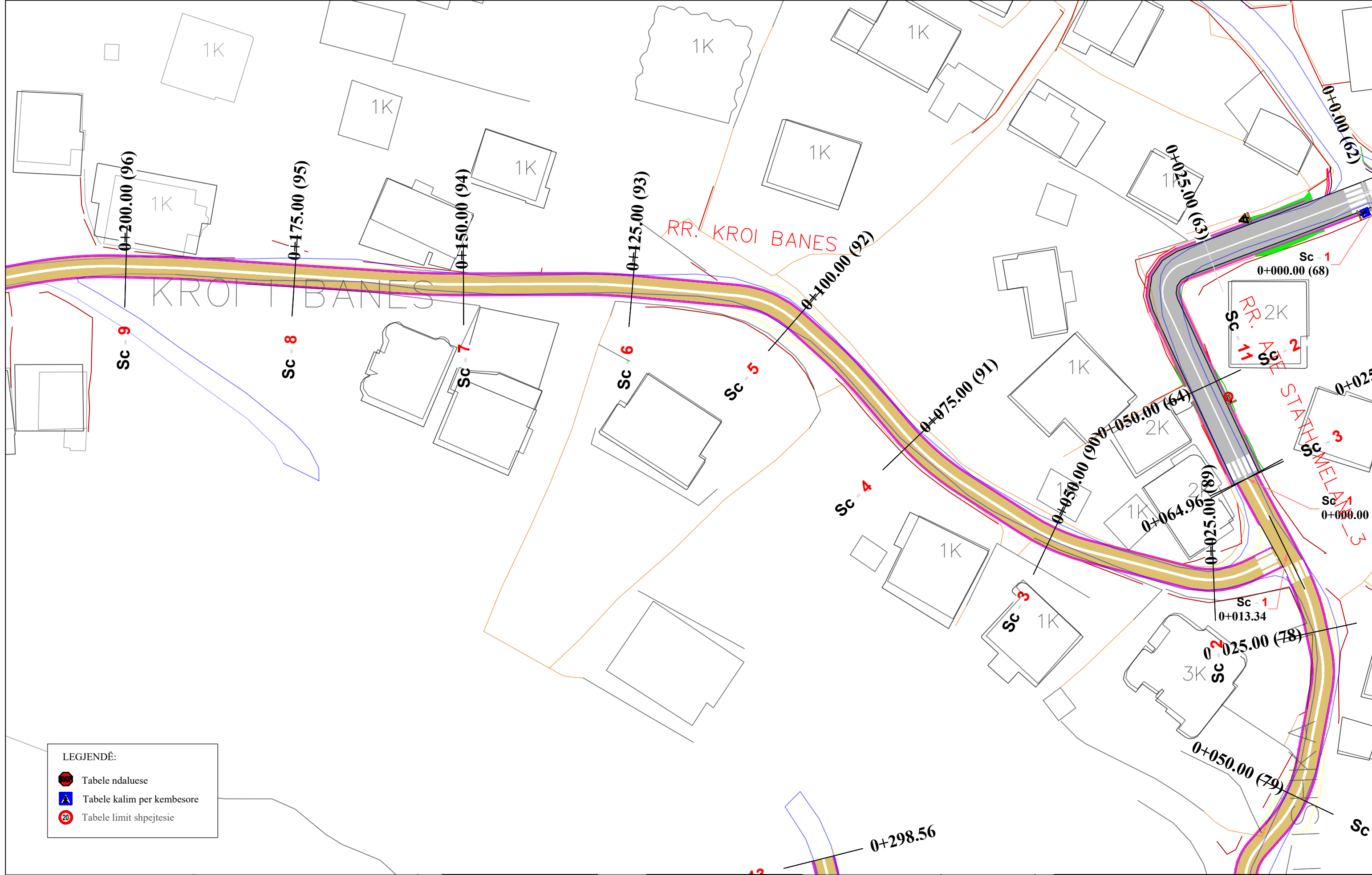

LEGJENDË:

|  |                            |
|--|----------------------------|
|  | Tabele ndaluese            |
|  | Tabele kalim per kembesore |
|  | Tabele limit shpejtesie    |

|   |  |   |  |         |                 |                                   |       |
|---|--|---|--|---------|-----------------|-----------------------------------|-------|
| <p>REPUBLIKA E SHQIPËRISË<br/>BASHKIA E TIRANËS</p> | <p>OBJEKTI: "RIKUALIFIKIMI URBAN I ZONËS INFORMALE QË KUFIZOHET NGA RRUGËT -SABAUDIN GABRANI -JONUZ RAMA-HAMDI CULLHAJ-DAMIAN HIMARIOTI-BARI ISHKA-VASFI SAMIMI-ALUSH ELMAZ TAKA."</p> | <p>Projektoi :</p> <p>Ing.A.JAKOVA<br/>Ing.G.ISLAMI<br/>Ing.S.MYRSELI<br/>Ing.P.SHKURTI</p> <p>Ark.M.DADO<br/>Ing.Gjeol.Xh.KASMI<br/>Ing.Mjedis.E.CALI<br/>Top.A.BECECI</p> | <p>Projektoi :</p> <p>"S&amp;L STUDIO SH.P.K"</p> <p>Projektim-kupervizion-cosnulence</p> <p>PROJEKTIM DESIGN<br/>SUPERVISION KOLAUDIM</p> | FAZA    | PROJEKT ZBATIMI | PLANIMETRI<br>RRUGA RR.KROI BANES |       |
|   |  |   |  | DORËZIM | 1.0             | SHKALLA                           | 1:500 |
|   |  |   |  |         |                 | Nr. I FLETËS                      | 001   |

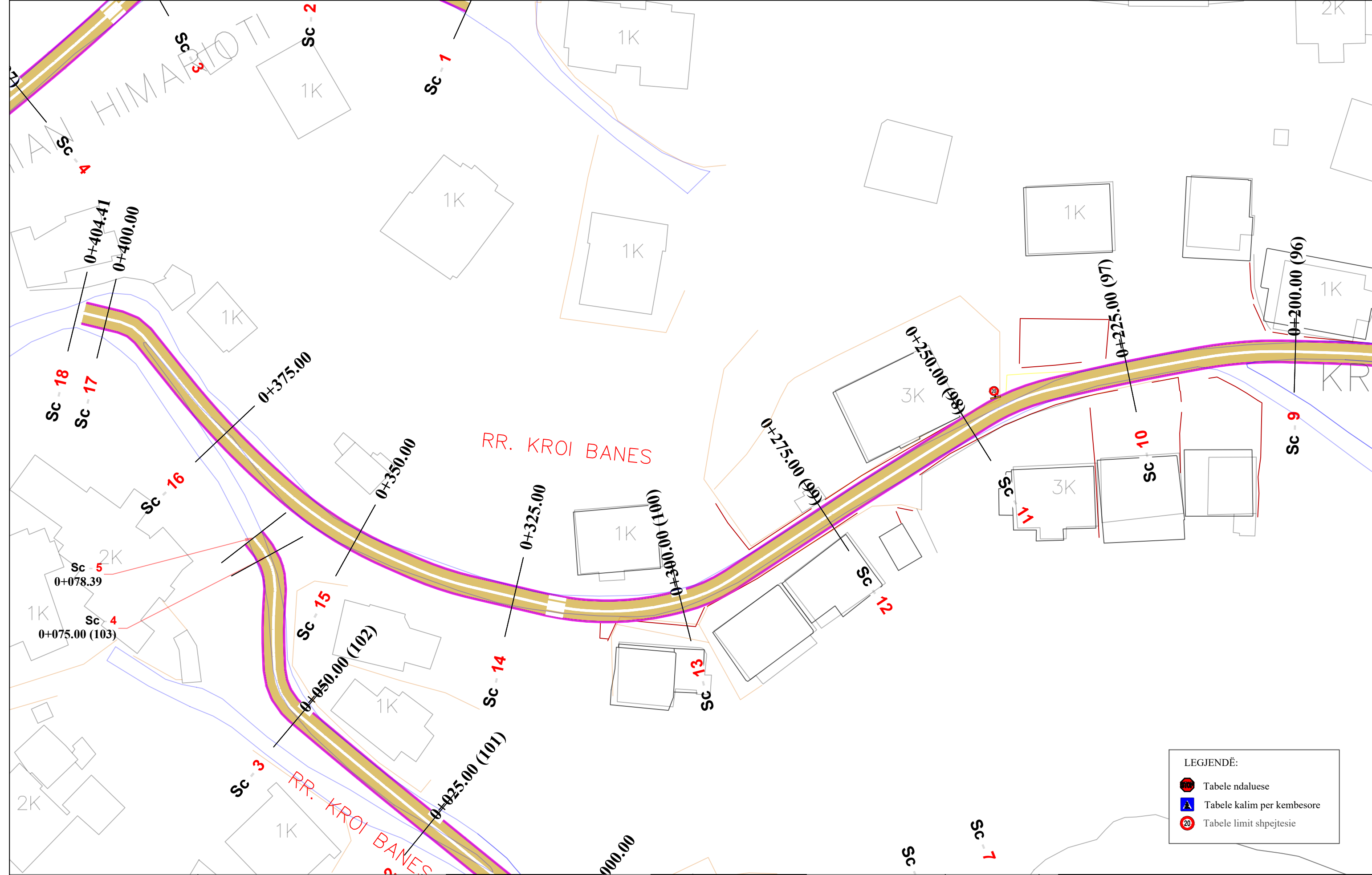

**LEGJENDË:**

- Tabele ndaluese
- Tabele kalim per kembesore
- Tabele limit shpejtesie



REPUBLIKA E SHQIPËRISË  
BASHKIA E TIRANËS

OBJEKTI: "RIKUALIFIKIMI URBAN I ZONËS INFORMALE QË KUFIZOHET NGA RRUGËT -SABAUDIN GABRANI -JONUZ RAMA-HAMDI CULLHAJ-DAMIAN HIMARIOTI-BARI ISHKA-VASFI SAMIMI-ALUSH ELMAZ TAKA."

Projektoi :  
Ing.A.JAKOVA  
Ing.G.ISLAMI  
Ing.S.MYRSELI  
Ing.P.SHKURTI

Ark.M.DADO  
Ing.Gjeol.Xh.KASMI  
Ing.Mjedis.E.CALI  
Top.A.BECECI

Projektoi :  
**"S&L STUDIO SH.P.K"**  
Projektim-kupervizion-cosnulence



PROJEKTIM DESIGN  
SUPERVISION KOLAUDIM

FAZA  
DORËZIM

PROJEKT ZBATIMI  
1.0

PLANIMETRI  
RRUGA RR.KROI BANES

|              |       |
|--------------|-------|
| SHKALLA      | 1:500 |
| Nr. I FLETËS | 002   |

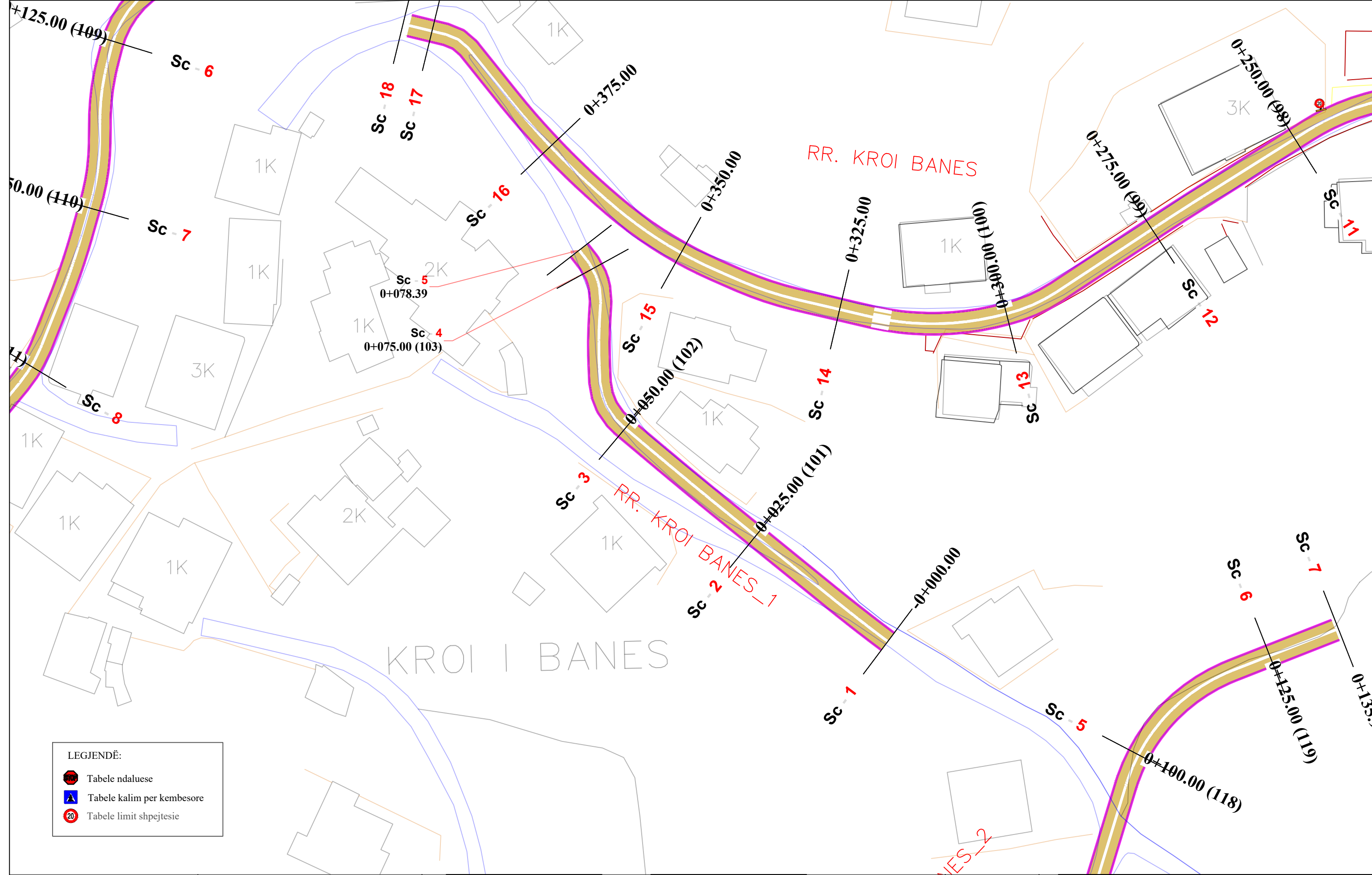

OBJEKTI: "RIKUALIFIKIMI URBAN I ZONËS INFORMALE QË KUFIZOHET NGA RRUGËT -SABAUDIN GABRANI -JONUZ RAMA-HAMDI CULLHAJ-DAMIAN HIMARIOTI-BARI ISHKA-VASFI SAMIMI-ALUSH ELMAZ TAKA."

Projekttoi :  
Ing.A.JAKOVA  
Ing.G.ISLAMI  
Ing.S.MYRSELI  
Ing.P.SHKURTI  
Ark.M.DADO  
Ing.Gjeol.Xh.KASMI  
Ing.Mjedis.E.CALI  
Top.A.BECECI

Projekttoi :  
"S&L STUDIO SH.P.K"  
Projektim-kupervizion-cosnulence  
**R A L D - G**  
PROJEKTIM DESIGN  
SUPERVISION KOLAUDIM

FAZA  
DORËZIM

PROJEKT ZBATIMI  
1.0

PLANIMETRI  
RRUGA RR.KROI BANES1  
SHKALLA 1:500  
Nr. I FLETËS 001

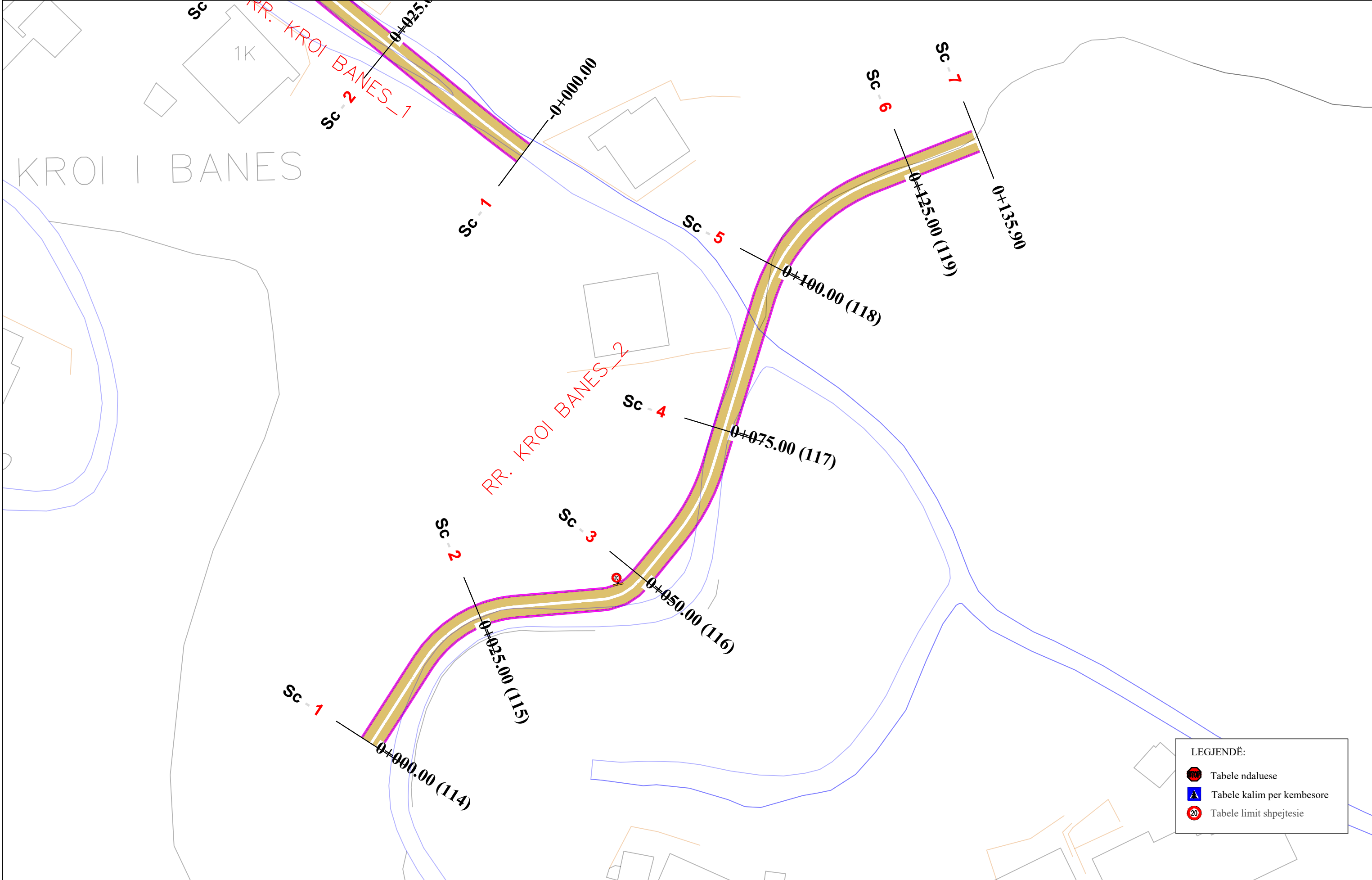

KROI I BANES



REPUBLIKA E SHQIPËRISË  
BASHKIA E TIRANËS

OBJEKTI: "RIKUALIFIKIMI URBAN I ZONËS INFORMALE QË KUFIZOHET NGA RRUGËT -SABAUDIN GABRANI -JONUZ RAMA-HAMDI CULLHAJ-DAMIAN HIMARIOTI-BARI ISHKA-VASFI SAMIMI-ALUSH ELMAZ TAKA."

Projektoi :  
Ing.A.JAKOVA  
Ing.G.ISLAMI  
Ing.S.MYRSELI  
Ing.P.SHKURTI

Ark.M.DADO  
Ing.Gjeol.Xh.KASMI  
Ing.Mjedis.E.CALI  
Top.A.BECECI

Projektoi :  
"S&L STUDIO SH.P.K"  
Projektim-kupervizion-cosnulence





PROJEKTIM DESIGN  
SUPERVISION KOLAUDIM

|         |                 |
|---------|-----------------|
| FAZA    | PROJEKT ZBATIMI |
| DORËZIM | 1.0             |

|                                    |       |
|------------------------------------|-------|
| PLANIMETRI<br>RRUGA RR.KROI BANES2 |       |
| SHKALLA                            | 1:500 |
| Nr. I FLETËS                       | 001   |

LEGJENDË:

-  Tabele ndaluese
-  Tabele kalim per kembesore
-  Tabele limit shpejtesie



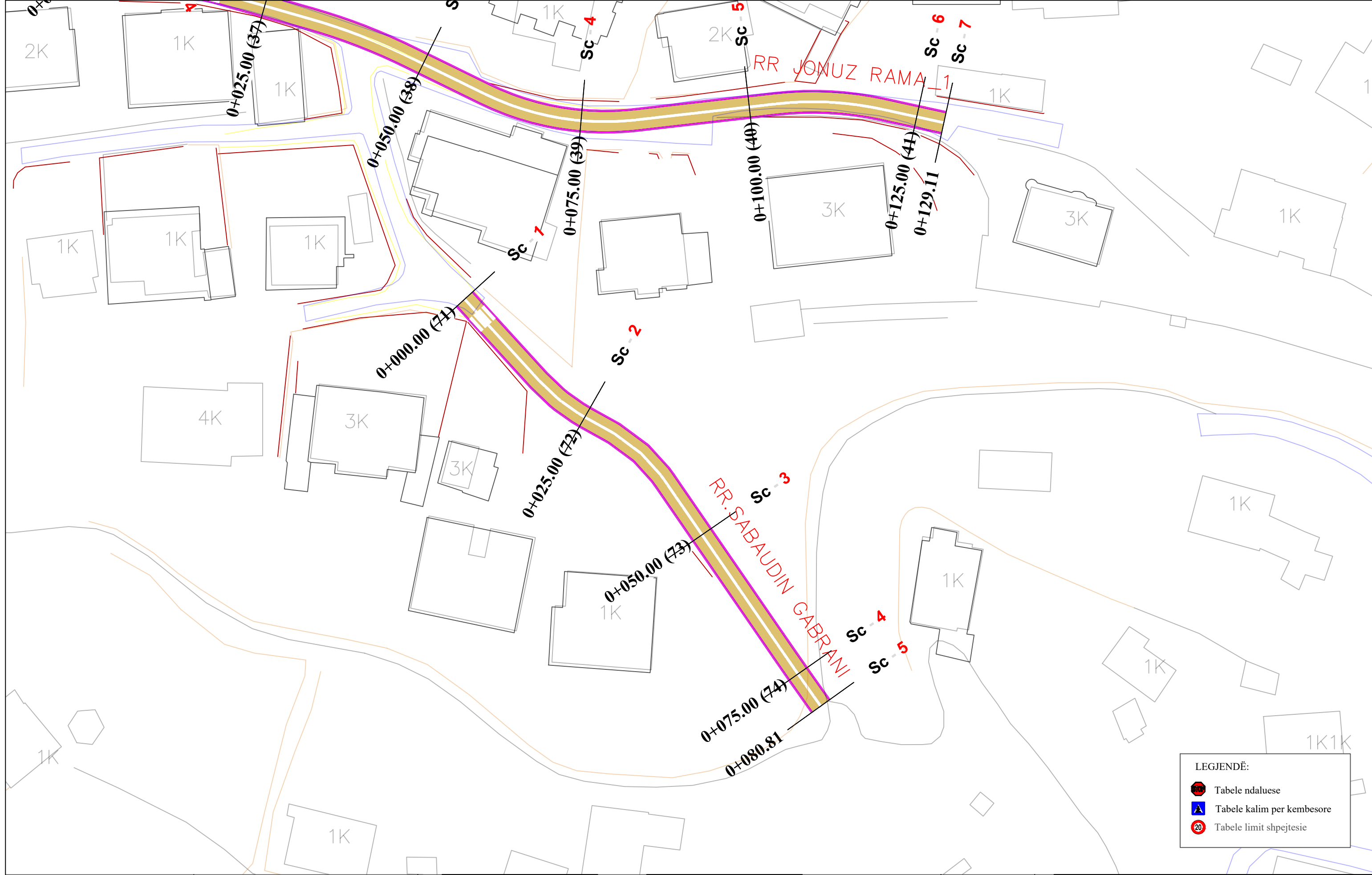

LEGJENDË:

- Tabele ndaluese
- Tabele kalim per kembesore
- Tabele limit shpejtesie



REPUBLIKA E SHQIPËRISË  
BASHKIA E TIRANËS

OBJEKTI: "RIKUALIFIKIMI URBAN I ZONËS INFORMALE QË KUFIZOHET NGA RRUGËT -SABAUDIN GABRANI -JONUZ RAMA-HAMDI CULLHAJ-DAMIAN HIMARIOTI-BARI ISHKA-VASFI SAMIMI-ALUSH ELMAZ TAKA."

Projektoi :  
Ing.A.JAKOVA  
Ing.G.ISLAMI  
Ing.S.MYRSELI  
Ing.P.SHKURTI

Ark.M.DADO  
Ing.Gjeol.Xh.KASMI  
Ing.Mjedis.E.CALI  
Top.A.BECECI

Projektoi :  
"S&L STUDIO SH.P.K"  
Projektim-kupervizion-cosnulence



PROJEKTIM DESIGN  
SUPERVISION KOLAUDIM

FAZA  
DORËZIM



PROJEKT ZBATIMI  
1.0

PLANIMETRI  
RRUGA RR.SABAUDIN GABRANI

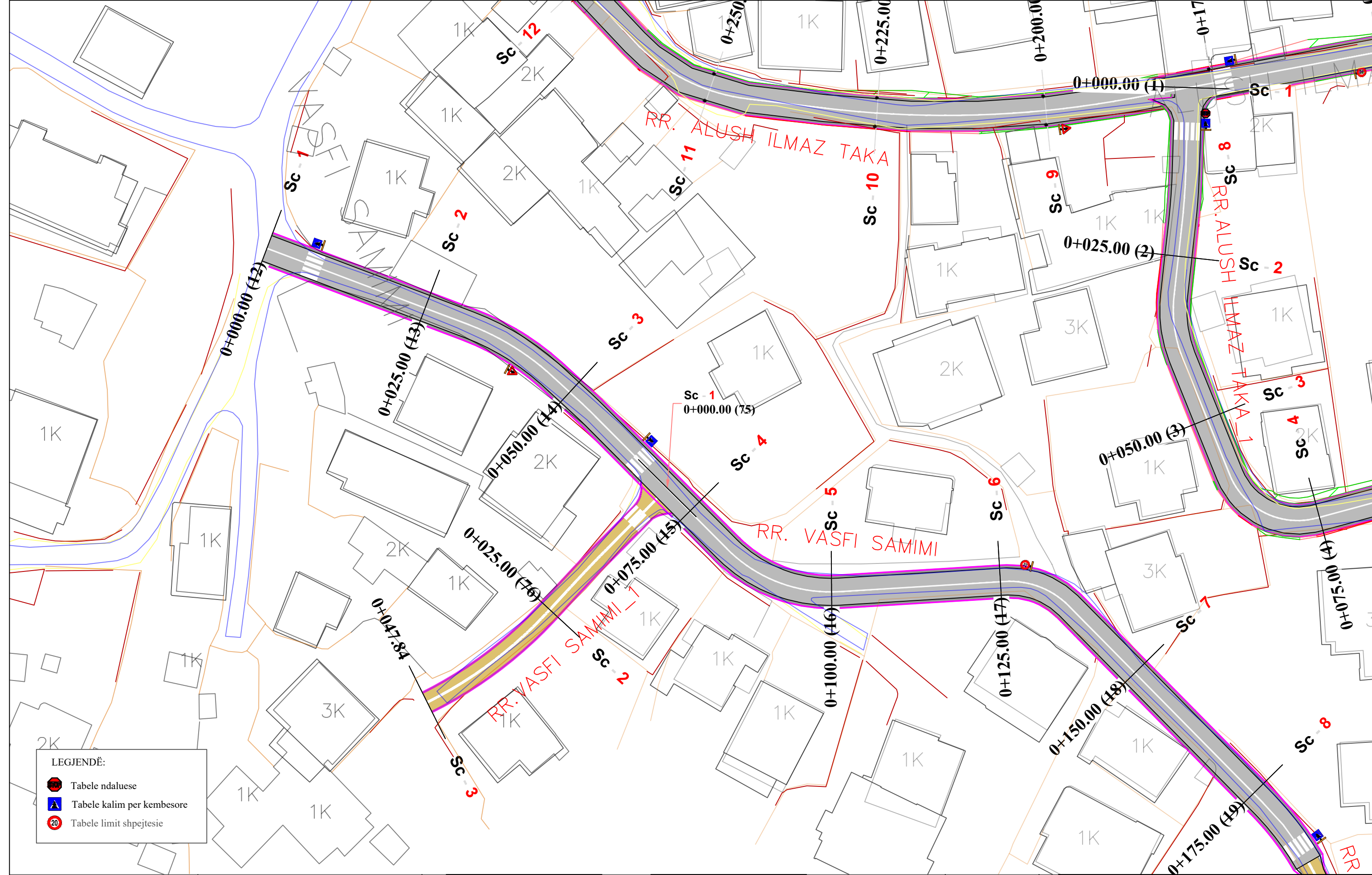
|              |       |
|--------------|-------|
| SHKALLA      | 1:500 |
| Nr. I FLETËS | 001   |



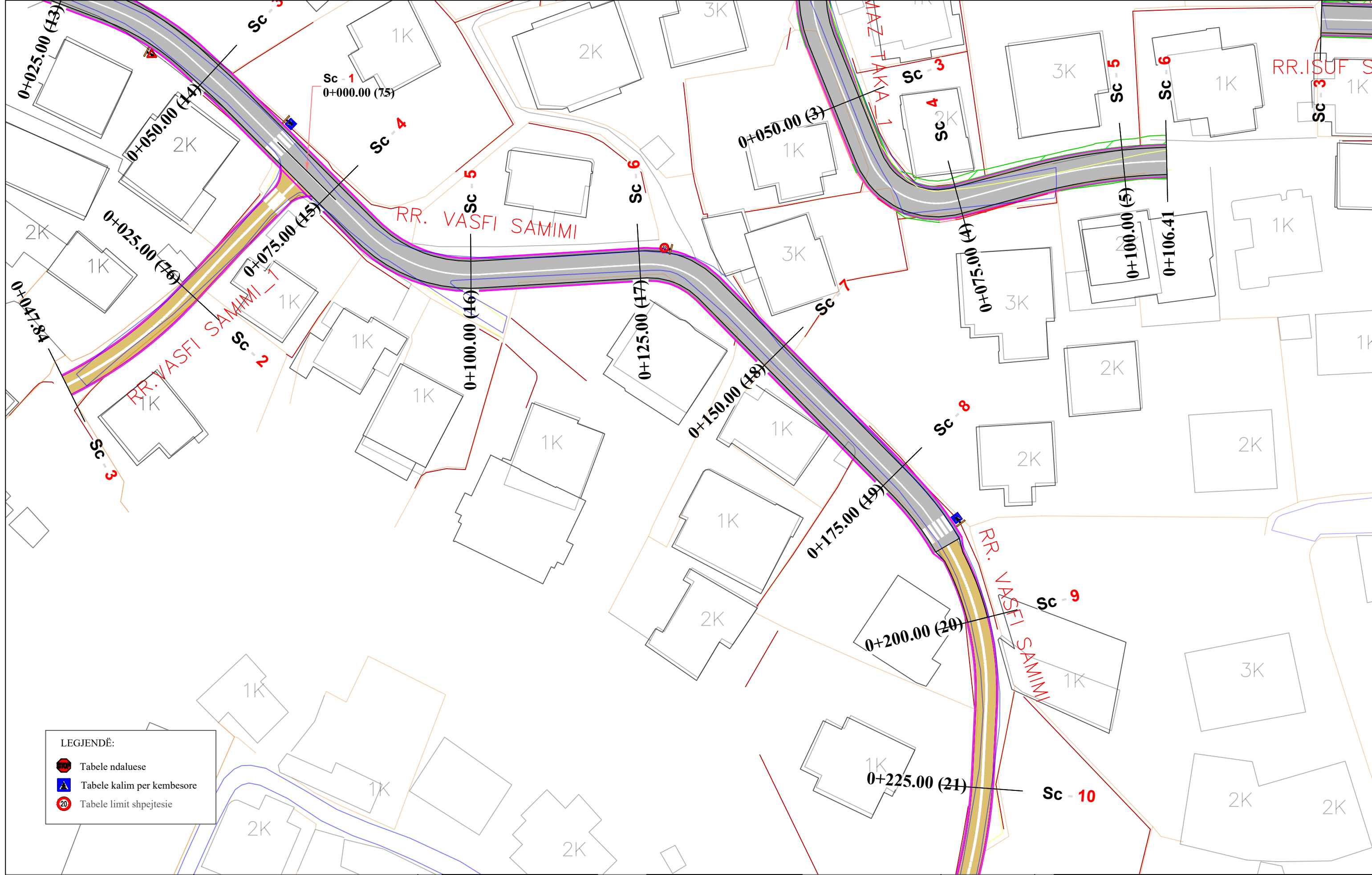

- LEGJENDË:
- Tabele ndaluese
  - Tabele kalim per kembesore
  - Tabele limit shpejtesie

|  |  |   |  |         |                 |                                     |       |
|--|--|---|--|---------|-----------------|-------------------------------------|-------|
|  <p>REPUBLIKA E SHQIPËRISË<br/>BASHKIA E TIRANËS</p> | <p>OBJEKTI: "RIKUALIFIKIMI URBAN I ZONËS INFORMALE QË KUFIZOHET NGA RRUGËT -SABAUDIN GABRANI -JONUZ RAMA-HAMDI CULLHAJ-DAMIAN HIMARIOTI-BARI ISHKA-VASFI SAMIMI-ALUSH ELMAZ TAKA."</p> | <p>Projektoi :</p> <p>Ing.A.JAKOVA<br/>Ing.G.ISLAMI<br/>Ing.S.MYRSELI<br/>Ing.P.SHKURTI</p> <p>Ark.M.DADO<br/>Ing.Gjeol.Xh.KASMI<br/>Ing.Mjedis.E.CALI<br/>Top.A.BECECI</p> | <p>Projektoi :</p> <p>"S&amp;L STUDIO SH.P.K"</p> <p>Projektim-kupervizion-cosnulence</p>  <p>PROJEKTIM DESIGN<br/>SUPERVISION KOLAUDIM</p> | FAZA    | PROJEKT ZBATIMI | PLANIMETRI<br>RRUGA RR.VASFI SAMIMI |       |
|  |  |   |  | DORËZIM | 1.0             | SHKALLA                             | 1:500 |
|  |  |   |  |         |                 | Nr. I FLETËS                        | 001   |



- LEGJENDË:**
- Tabele ndaluese
  - Tabele kalim per kembesore
  - Tabele limit shpejtesie

|   |   |   |  |   |                     |   |                 |                        |                                     |  |
|---|---|---|--|---|---------------------|---|-----------------|------------------------|-------------------------------------|--|
| <br>REPUBLIKA E SHQIPËRISË<br>BASHKIA E TIRANËS | OBJEKTI: "RIKUALIFIKIMI URBAN I ZONËS INFORMALE QË KUFIZOHET NGA RRUGËT -SABAUDIN GABRANI -JONUZ RAMA-HAMDI CULLHAJ-DAMIAN HIMARIOTI-BARI ISHKA-VASFI SAMIMI-ALUSH ELMAZ TAKA." | Projektoi :<br>Ing.A.JAKOVA<br>Ing.G.ISLAMI<br>Ing.S.MYRSELI<br>Ing.P.SHKURTI   |  | Ark.M.DADO<br>Ing.Gjeol.Xh.KASMI<br>Ing.Mjedis.E.CALI<br>Top.A.BECECI |                     | Projektoi :<br><b>"S&amp;L STUDIO SH.P.K"</b><br>Projektim-kupervizion-cosnulence | FAZA<br>DORËZIM | PROJEKT ZBATIMI<br>1.0 | PLANIMETRI<br>RRUGA RR.VAFSI SAMIMI |  |
|   |   | <br>PROJEKTIM DESIGN<br>SUPERVISION KOLAUDIM |  | SHKALLA<br>1:500  | Nr. I FLETËS<br>002 |   |                 |                        |                                     |  |
|   |   |   |  |   |                     |   |                 |                        |                                     |  |

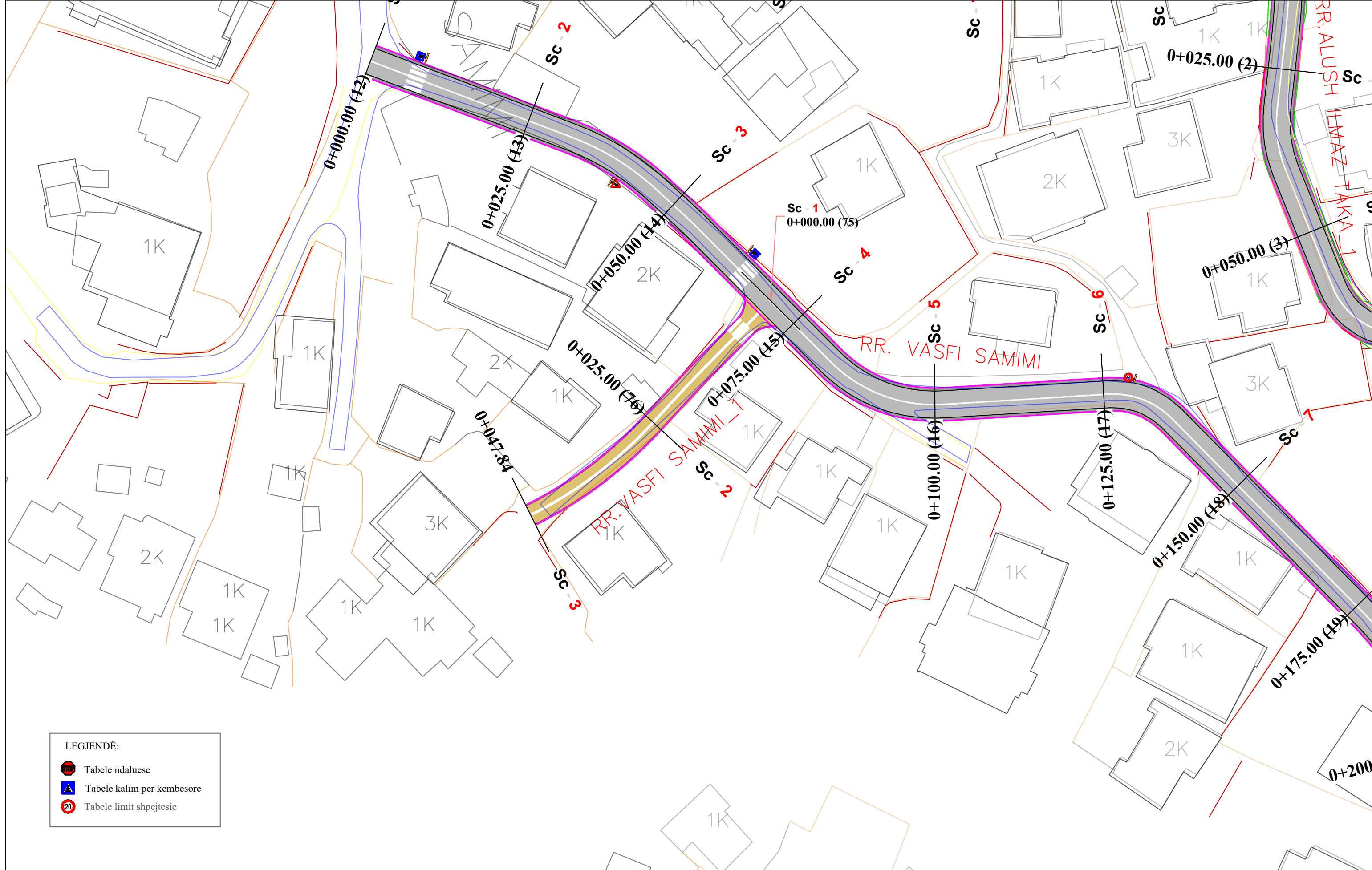

LEGJENDË:

|  |                            |
|--|----------------------------|
|  | Tabele ndaluese            |
|  | Tabele kalim per kembesore |
|  | Tabele limit shpejtesie    |



OBJEKTI: "RIKUALIFIKIMI URBAN I ZONËS INFORMALE QË KUFIZOHET NGA RRUGËT -SABAUDIN GABRANI -JONUZ RAMA-HAMDI CULLHAJ-DAMIAN HIMARIOTI-BARI ISHKA-VASFI SAMIMI-ALUSH ELMAZ TAKA."

Projektoi :  
 Ing.A.JAKOVA  
 Ing.G.ISLAMI  
 Ing.S.MYRSELI  
 Ing.P.SHKURTI  
 Ark.M.DADO  
 Ing.Gjeol.Xh.KASMI  
 Ing.Mjedis.E.CALI  
 Top.A.BECECI

Projektoi :  
**"S&L STUDIO SH.P.K"**  
 Projektim-kupervizion-cosnulence

FAZA  
DORËZIM

PROJEKT ZBATIMI  
1.0

PLANIMETRI  
RRUGA RR.VASFI SAMIMI  
SHKALLA 1:500  
Nr. I FLETËS 001

---



*08-PLANI ELEKTRIK*

---

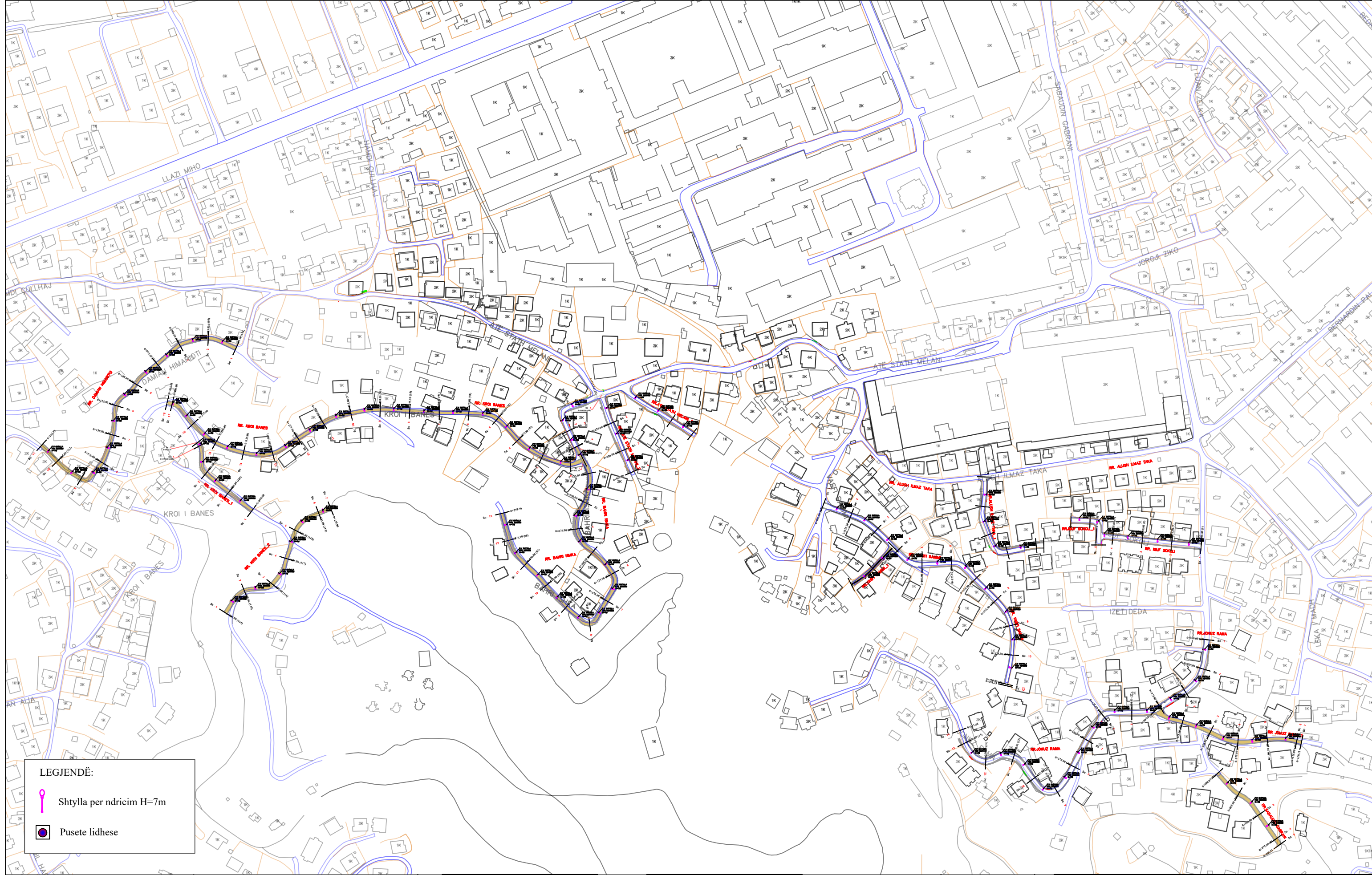
TIRANË 2023



**LEGJENDË:**

-  Shtylla per ndricim H=7m
-  Pusete lidhese



OBJEKTI: "RIKUALIFIKIMI URBAN I ZONËS INFORMALE QË KUFIZOHET NGA RRUGËT -SABAUDIN GABRANI -JONUZ RAMA-HAMDI CULLHAJ-DAMIAN HIMARIOTI-BARI ISHKA-VASFI SAMIMI-ALUSH ELMAZ TAKA."

Projektoi :

Ing.A.JAKOVA  
Ing.G.ISLAMI  
Ing.S.MYRSELI  
Ing.P.SHKURTI

Ark.M.DADO  
Ing.Gjeol.Xh.KASMI  
Ing.Mjedis.E.CALI  
Top.A.BECECI

Projektoi :

**"S&L STUDIO SH.P.K"**  
Projektim-kupervizion-cosnulence



PROJEKTIM DESIGN  
SUPERVISION KOLAUDIM

FAZA

DORËZIM

PROJEKT ZBATIMI

1.0

PLANIMETRI  
RRUGA RR.ATE STATH MELANI 3

SHKALLA 1:200

Nr. I FLETËS 002

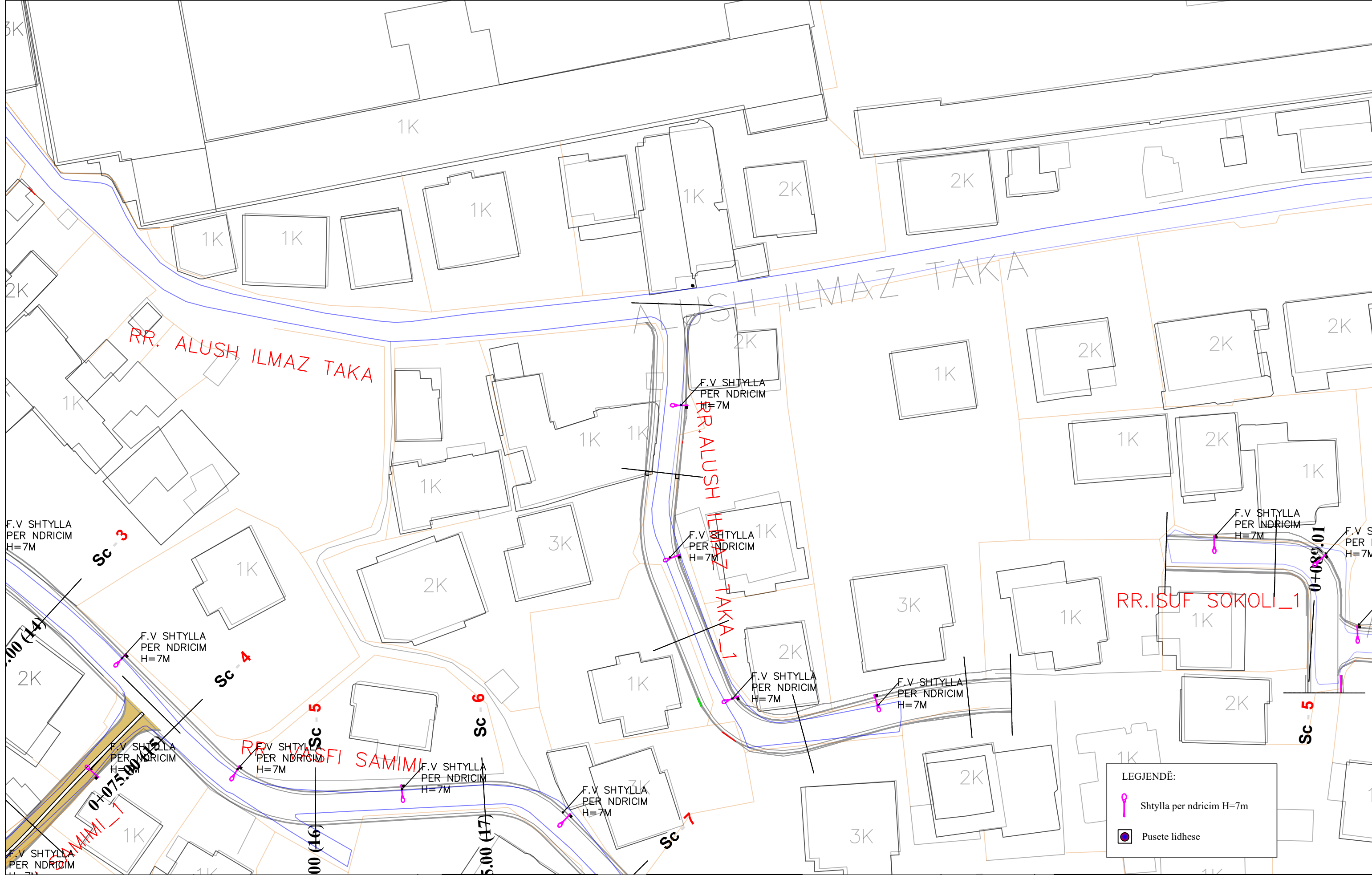

REPUBLIKA E SHQIPËRISË  
BASHKIA E TIRANËS

OBJEKTI: "RIKUALIFIKIMI URBAN I ZONËS INFORMALE QË KUFIZOHET NGA RRUGËT -SABAUDIN GABRANI -JONUZ RAMA-HAMDI CULLHAJ-DAMIAN HIMARIOTI-BARI ISHKA-VASFI SAMIMI-ALUSH ELMAZ TAKA."

Projektoi :

Ing.A.JAKOVA  
Ing.G.ISLAMI  
Ing.S.MYRSELI  
Ing.P.SHKURTI

Ark.M.DADO  
Ing.Gjeol.Xh.KASMI  
Ing.Mjedis.E.CALI  
Top.A.BECECI

Projektoi :  
"S&L STUDIO SH.P.K"

Projektim-kupervizion-cosnulence



FAZA

DORËZIM

PROJEKT ZBATIMI

1.0

PLANIMETRI  
RRUGA RR.ALUSH ILMAZ TAKA\_1

SHKALLA 1:500

Nr. I FLETËS 001

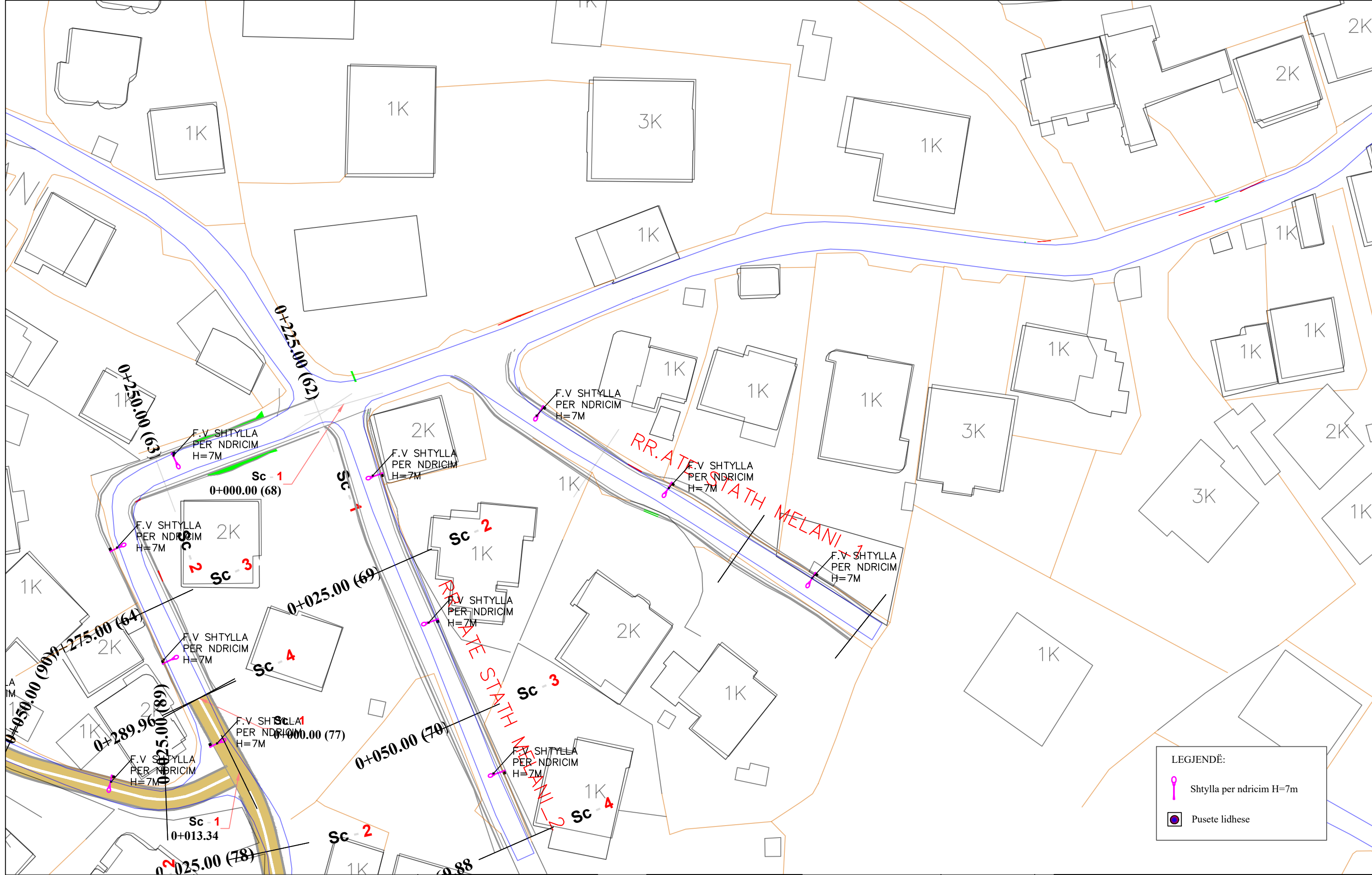

**LEGJENDË:**

- Shtylla per ndricim H=7m
- Pusete lidhese



OBJEKTI: "RIKUALIFIKIMI URBAN I ZONËS INFORMALE QË KUFIZOHET NGA RRUGËT -SABAUDIN GABRANI -JONUZ RAMA-HAMDI CULLHAJ-DAMIAN HIMARIOTI-BARI ISHKA-VASFI SAMIMI-ALUSH ELMAZ TAKA."

Projektoi :  
 Ing.A.JAKOVA Ark.M.DADO  
 Ing.G.ISLAMI Ing.Gjeol.Xh.KASMI  
 Ing.S.MYRSELI Ing.Mjedis.E.CALI  
 Ing.P.SHKURTI Top.A.BECECI

Projektoi :  
**"S&L STUDIO SH.P.K"**  
 Projektim-kupervizion-cosnulence  
 RALD-G  
 PROJEKTIM DESIGN SUPERVISION KOLAUDIM

|         |                 |
|---------|-----------------|
| FAZA    | PROJEKT ZBATIMI |
| DORËZIM | 1.0             |

|   |       |
|---|-------|
| PLANIMETRI<br>RRUGA RR.ATE STATH MELANI 1 |       |
| SHKALLA                                   | 1:500 |
| Nr. I FLETËS                              | 001   |



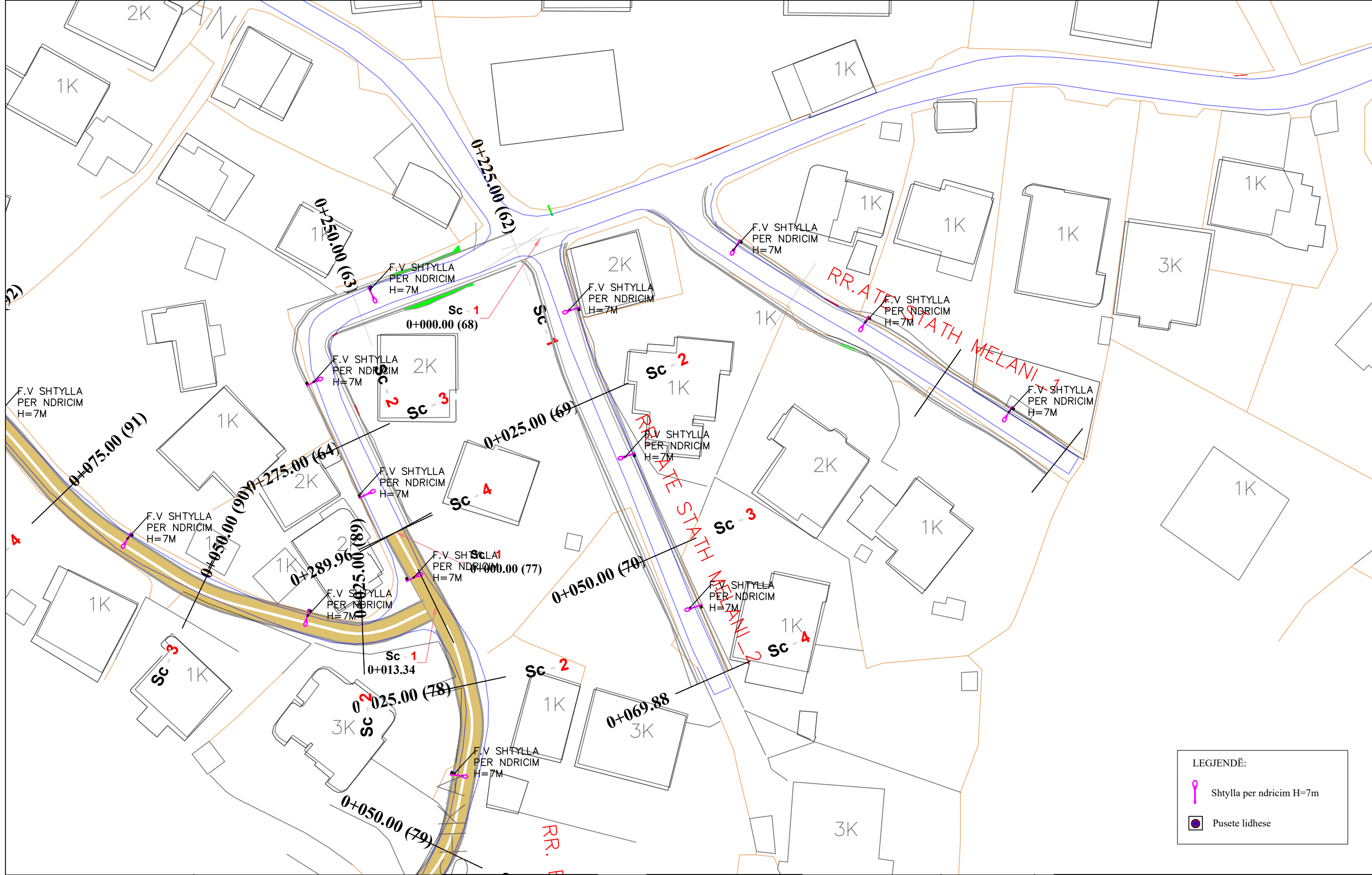

LEGJENDË:

|  |                          |
|--|--------------------------|
|  | Shtylla per ndricim H=7m |
|  | Pusete lidhese           |



REPUBLIKA E SHQIPËRISË  
BASHKIA E TIRANËS

OBJEKTI: "RIKUALIFIKIMI URBAN I ZONËS INFORMALE QË KUFIZOHET NGA RRUGËT -SABAUDIN GABRANI -JONUZ RAMA-HAMDI CULLHAJ-DAMIAN HIMARIOTI-BARI ISHKA-VASFI SAMIMI-ALUSH ELMAZ TAKA."

Projektoi :  
Ing.A.JAKOVA  
Ing.G.ISLAMI  
Ing.S.MYRSELI  
Ing.P.SHKURTI

Ark.M.DADO  
Ing.Gjeol.Xh.KASMI  
Ing.Mjedis.E.CALI  
Top.A.BECECI

Projektoi :  
**"S&L STUDIO SH.P.K"**  
Projektim-kupervizion-cosnulence



PROJEKTIM DESIGN  
SUPERVISION KOLAUDIM

|         |                 |
|---------|-----------------|
| FAZA    | PROJEKT ZBATIMI |
| DORËZIM | 1.0             |

|   |       |
|---|-------|
| PLANIMETRI<br>RRUGA RR.ATE STATH MELANI 2 |       |
| SHKALLA                                   | 1:500 |
| Nr. I FLETËS                              | 001   |

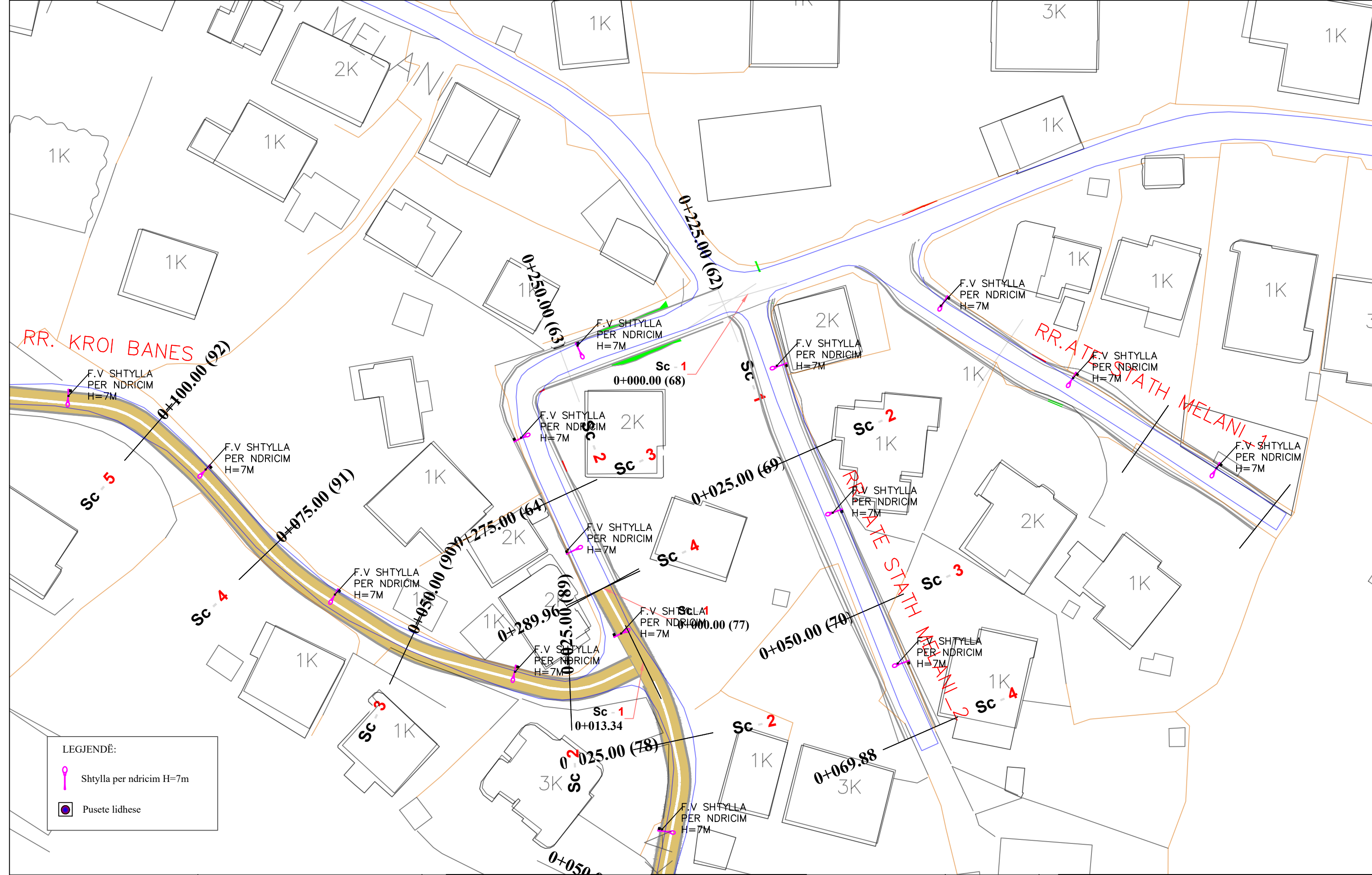

LEGJENDË:

- Shtylla per ndricim H=7m
- Pusete lidhese

  
 REPUBLIKA E SHQIPËRISË  
 BASHKIA E TIRANËS

OBJEKTI: "RIKUALIFIKIMI URBAN I ZONËS  
 INFORMALE QË KUFIZOHET NGA RRUGËT  
 -SABAUDIN GABRANI -JONUZ RAMA-HAMDI  
 CULLHAJ-DAMIAN HIMARIOTI-BARI  
 ISHKA-VASFI SAMIMI-ALUSH ELMAZ TAKA."

Projektoi :  
 Ing.A.JAKOVA Ark.M.DADO  
 Ing.G.ISLAMI Ing.Gjeol.Xh.KASMI  
 Ing.S.MYRSELI Ing.Mjedis.E.CALI  
 Ing.P.SHKURTI Top.A.BECECI

Projektoi :  
 "S&L STUDIO SH.P.K"  
 Projektim-kupervizion-cosnulence  

FAZA  
 DORËZIM

PROJEKT ZBATIMI  
 1.0

PLANIMETRI  
 RRUGA RR.ATE STATH MELANI 3  
 SHKALLA 1:500  
 Nr. I FLETËS 001

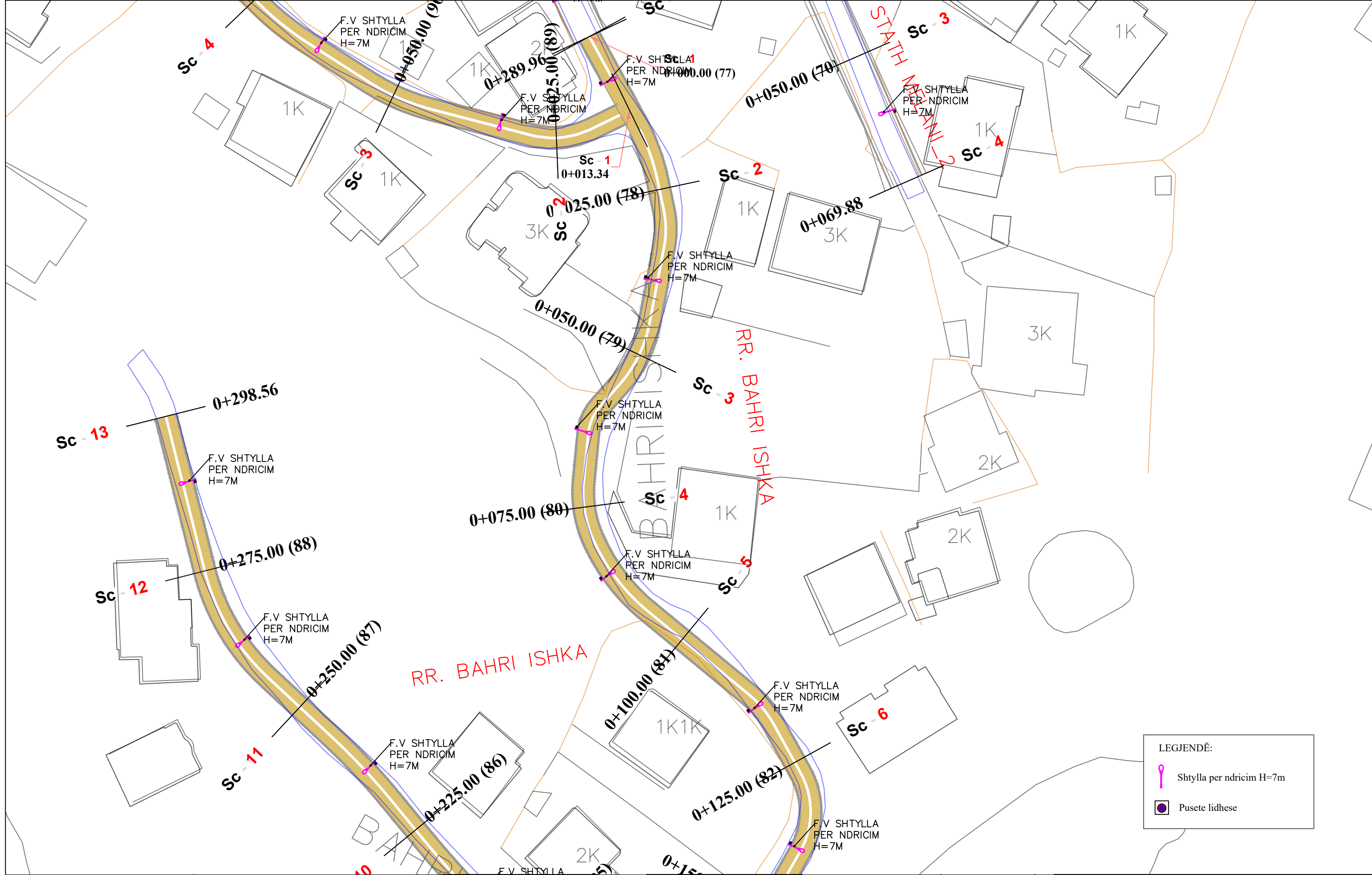

LEGJENDË:

|  |                          |
|--|--------------------------|
|  | Shtylla per ndricim H=7m |
|  | Pusete lidhese           |



REPUBLIKA E SHQIPËRISË  
BASHKIA E TIRANËS

OBJEKTI: "RIKUALIFIKIMI URBAN I ZONËS INFORMALE QË KUFIZOHET NGA RRUGËT -SABAUDIN GABRANI -JONUZ RAMA-HAMDI CULLHAJ-DAMIAN HIMARIOTI-BARI ISHKA-VASFI SAMIMI-ALUSH ELMAZ TAKA."

Projekttoi :  
Ing.A.JAKOVA  
Ing.G.ISLAMI  
Ing.S.MYRSELI  
Ing.P.SHKURTI

Ark.M.DADO  
Ing.Gjeol.Xh.KASMI  
Ing.Mjedis.E.CALI  
Top.A.BECECI

Projekttoi :  
"S&L STUDIO SH.P.K"  
Projektim-kupervizion-cosnulence



PROJEKTIM DESIGN  
SUPERVISION KOLAUDIM

FAZA  
DORËZIM

PROJEKT ZBATIMI  
1.0

|                                   |       |
|-----------------------------------|-------|
| PLANIMETRI<br>RRUGA RR.BARI ISHKA |       |
| SHKALLA                           | 1:500 |
| Nr. I FLETËS                      | 001   |

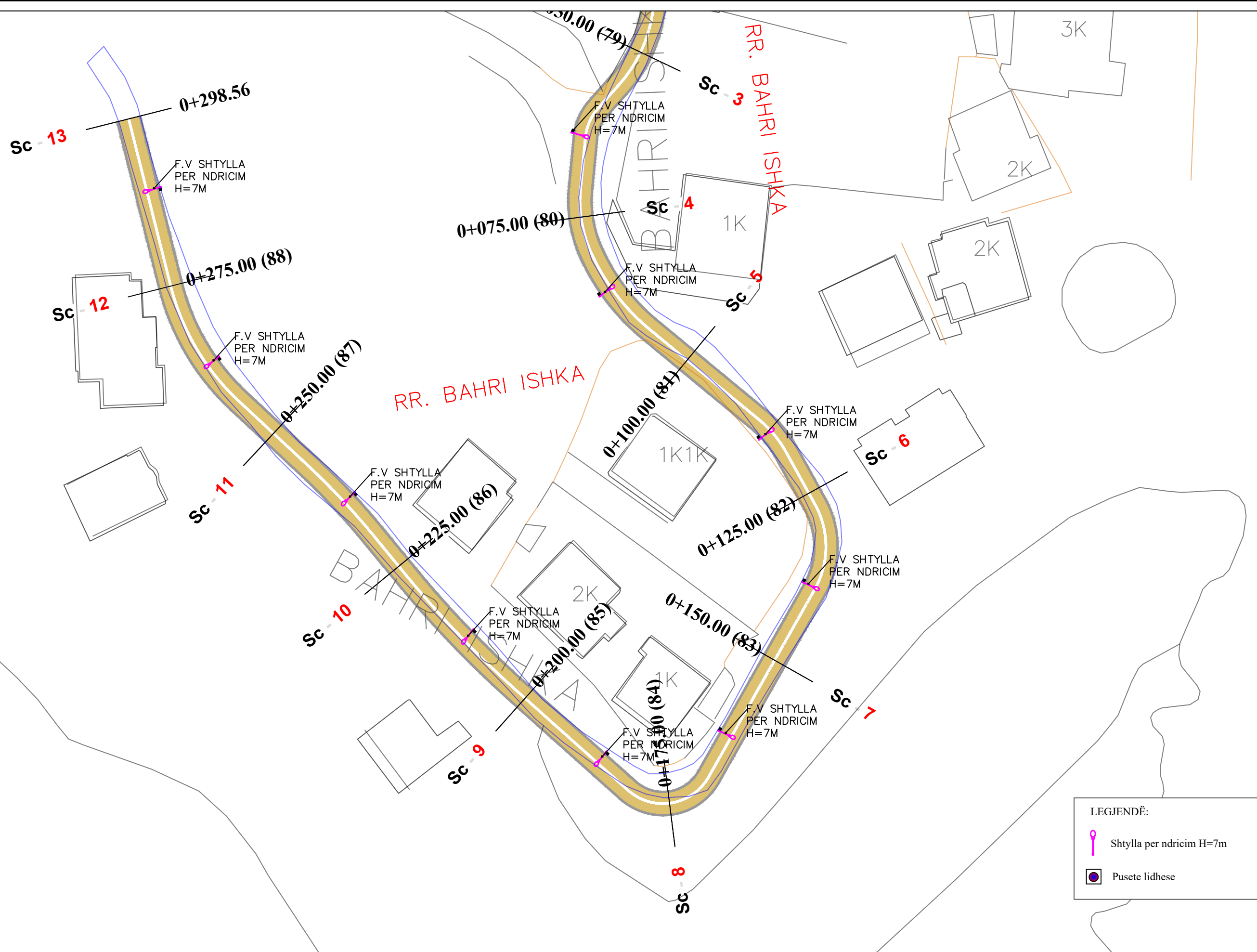

LEGJENDË:

|  |                          |
|--|--------------------------|
|  | Shtylla per ndricim H=7m |
|  | Pusete lidhese           |



REPUBLIKA E SHQIPËRISË  
BASHKIA E TIRANËS

OBJEKTI: "RIKUALIFIKIMI URBAN I ZONËS INFORMALE QË KUFIZOHET NGA RRUGËT -SABAUDIN GABRANI -JONUZ RAMA-HAMDI CULLHAJ-DAMIAN HIMARIOTI-BARI ISHKA-VASFI SAMIMI-ALUSH ELMAZ TAKA."

Projektoi :  
Ing.A.JAKOVA  
Ing.G.ISLAMI  
Ing.S.MYRSELI  
Ing.P.SHKURTI

Ark.M.DADO  
Ing.Gjeol.Xh.KASMI  
Ing.Mjedis.E.CALI  
Top.A.BECECI

Projektoi :  
"S&L STUDIO SH.P.K"  
Projektim-kupervizion-cosnulence



PROJEKTIM DESIGN  
SUPERVISION KOLAUDIM

FAZA  
DORËZIM

PROJEKT ZBATIMI  
1.0

|                                   |       |
|-----------------------------------|-------|
| PLANIMETRI<br>RRUGA RR.BARI ISHKA |       |
| SHKALLA                           | 1:500 |
| Nr. I FLETËS                      | 002   |

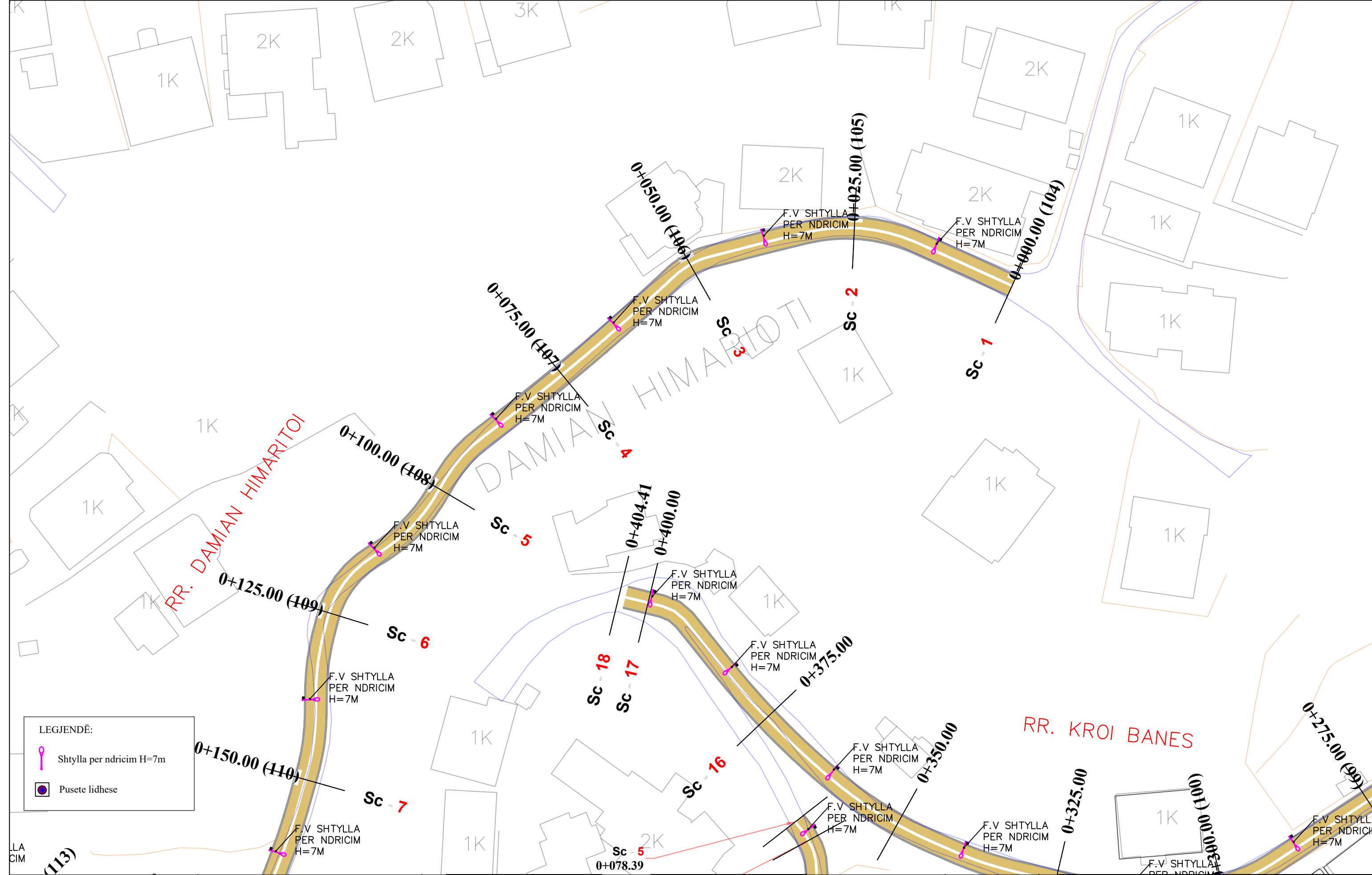

LEJENDË:

|  |                          |
|--|--------------------------|
|  | Shtylla per ndricim H=7m |
|  | Pusete lidhese           |



REPUBLIKA E SHQIPËRISË  
BASHKIA E TIRANËS

OBJEKTI: "RIKUALIFIKIMI URBAN I ZONËS INFORMALE QË KUFIZOHET NGA RRUGËT -SABAUDIN GABRANI -JONUZ RAMA-HAMDI CULLHAJ-DAMIAN HIMARIOTI-BARI ISHKA-VASFI SAMIMI-ALUSH ELMAZ TAKA."

Projektoi :  
Ing.A.JAKOVA Ark.M.DADO  
Ing.G.ISLAMI Ing.Gjeol.Xh.KASMI  
Ing.S.MYRSELI Ing.Mjedis.E.CALI  
Ing.P.SHKURTI Top.A.BECECI

Projektoi :  
**"S&L STUDIO SH.P.K"**  
Projektim-kupervizion-cosnulence  

|         |                 |
|---------|-----------------|
| FAZA    | PROJEKT ZBATIMI |
| DORËZIM | 1.0             |

|   |       |
|---|-------|
| PLANIMETRI<br>RRUGA RR.DAMIAN HIMARITOI |       |
| SHKALLA                                 | 1:500 |
| Nr. I FLETËS                            | 001   |

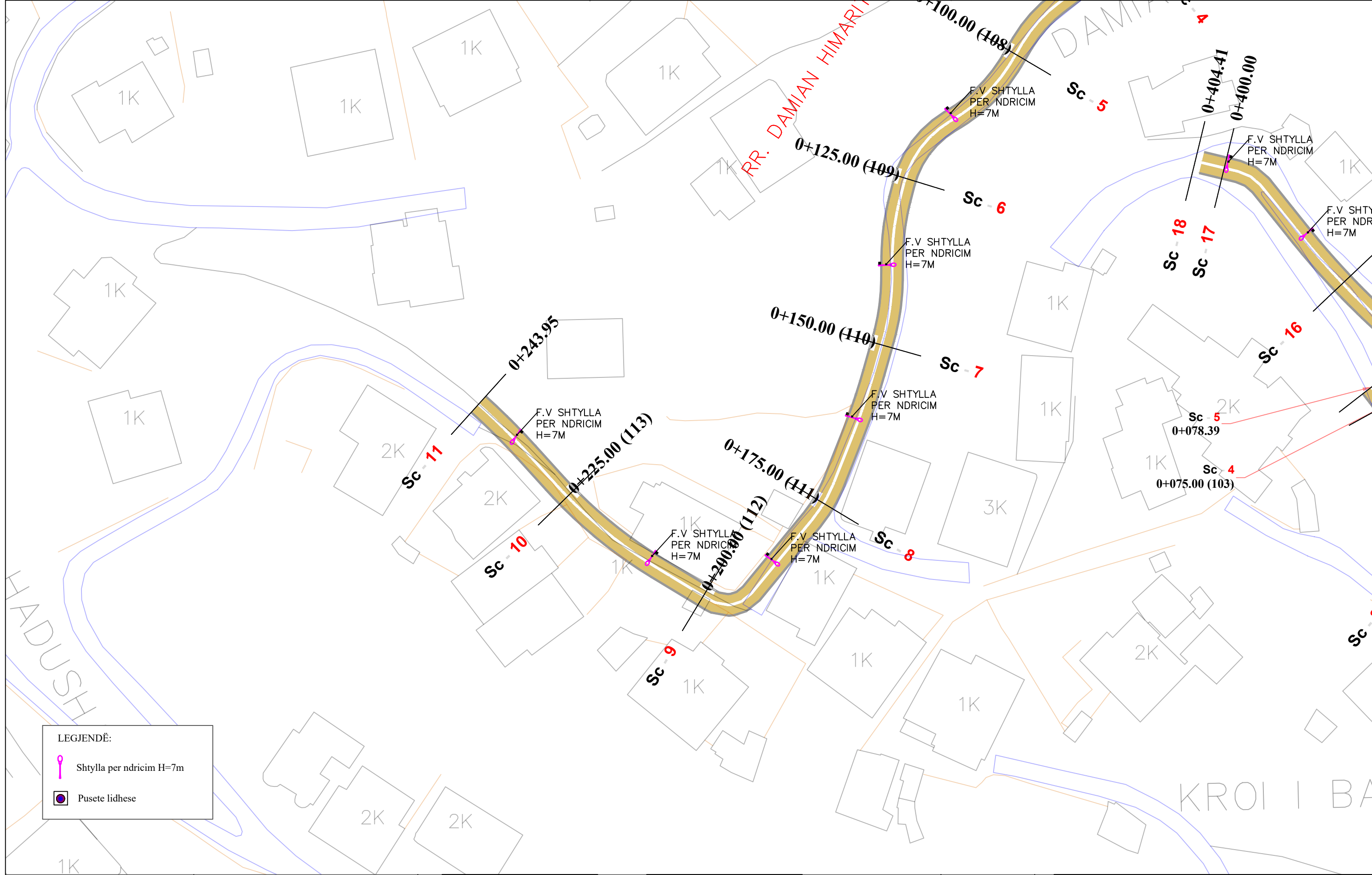

**LEGJENDË:**

|  |                          |
|--|--------------------------|
|  | Shtylla per ndricim H=7m |
|  | Pusete lidhese           |



REPUBLIKA E SHQIPËRISË  
BASHKIA E TIRANËS

OBJEKTI: "RIKUALIFIKIMI URBAN I ZONËS INFORMALE QË KUFIZOHET NGA RRUGËT -SABAUDIN GABRANI -JONUZ RAMA-HAMDI CULLHAJ-DAMIAN HIMARIOTI-BARI ISHKA-VASFI SAMIMI-ALUSH ELMAZ TAKA."

Projektoi :  
Ing.A.JAKOVA  
Ing.G.ISLAMI  
Ing.S.MYRSELI  
Ing.P.SHKURTI

Ark.M.DADO  
Ing.Gjeol.Xh.KASMI  
Ing.Mjedis.E.CALI  
Top.A.BECECI

Projektoi :  
**"S&L STUDIO SH.P.K"**  
Projektim-kupervizion-cosnulence



PROJEKTIM DESIGN  
SUPERVISION KOLAUDIM

|         |                 |
|---------|-----------------|
| FAZA    | PROJEKT ZBATIMI |
| DORËZIM | 1.0             |

|   |       |
|---|-------|
| PLANIMETRI<br>RRUGA RR.DAMIAN HIMARITOI |       |
| SHKALLA                                 | 1:500 |
| Nr. I FLETËS                            | 002   |

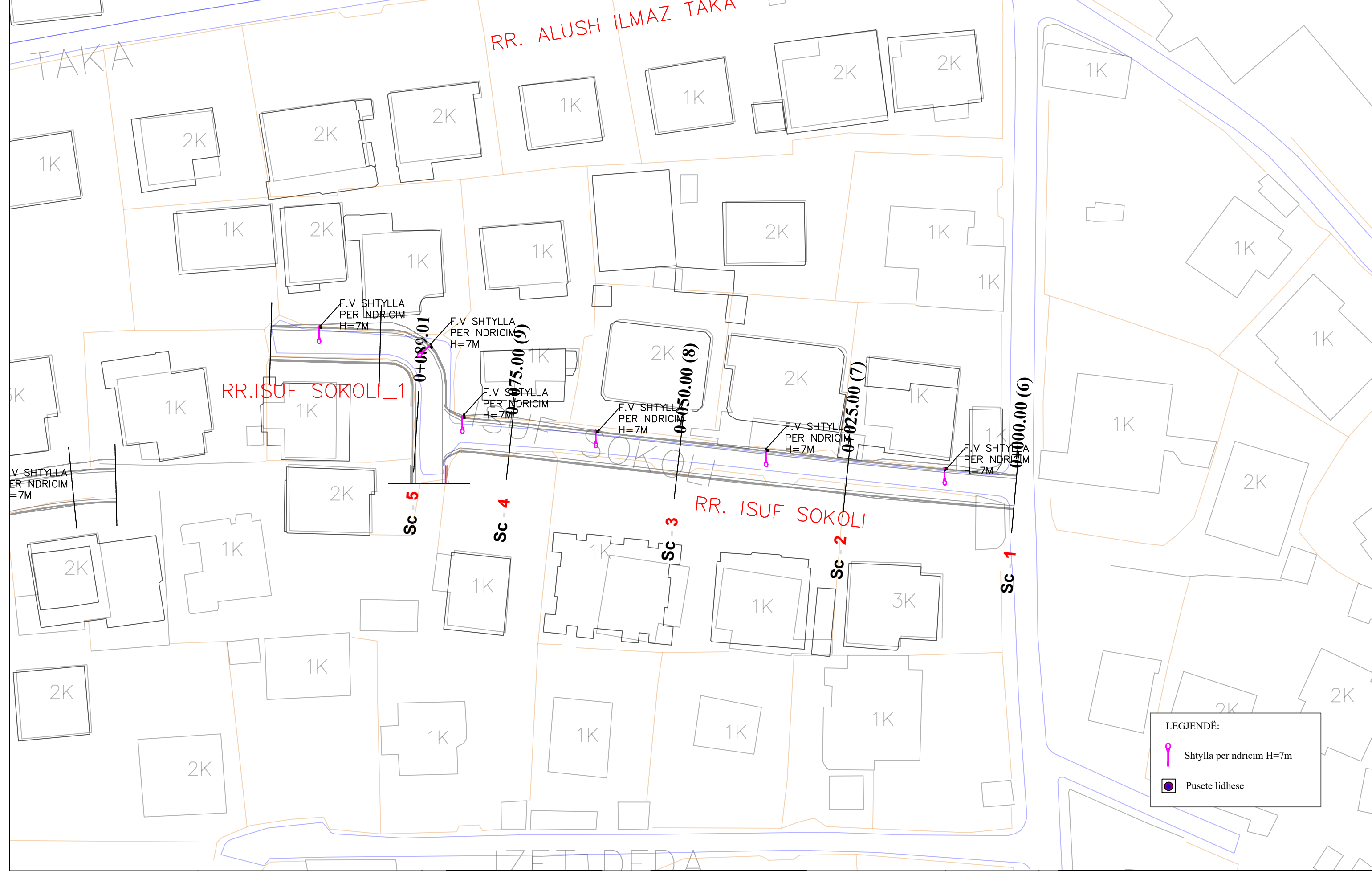

REPUBLIKA E SHQIPËRISË  
BASHKIA E TIRANËS

OBJEKTI: "RIKUALIFIKIMI URBAN I ZONËS INFORMALE QË KUFIZOHET NGA RRUGËT -SABAUDIN GABRANI -JONUZ RAMA-HAMDI CULLHAJ-DAMIAN HIMARIOTI-BARI ISHKA-VASFI SAMIMI-ALUSH ELMAZ TAKA."

Projektoi :  
Ing.A.JAKOVA  
Ing.G.ISLAMI  
Ing.S.MYRSELI  
Ing.P.SHKURTI  
Ark.M.DADO  
Ing.Gjeol.Xh.KASMI  
Ing.Mjedis.E.CALI  
Top.A.BECECI

Projektoi :  
"S&L STUDIO SH.P.K"  
Projektim-kupervizion-cosnulence  
**R A L D - G**  
PROJEKTIM DESIGN  
SUPERVISION KOLAUDIM

|         |                 |
|---------|-----------------|
| FAZA    | PROJEKT ZBATIMI |
| DORËZIM | 1.0             |

|                                    |       |
|------------------------------------|-------|
| PLANIMETRI<br>RRUGA RR.ISUF SOKOLI |       |
| SHKALLA                            | 1:500 |
| Nr. I FLETËS                       | 001   |

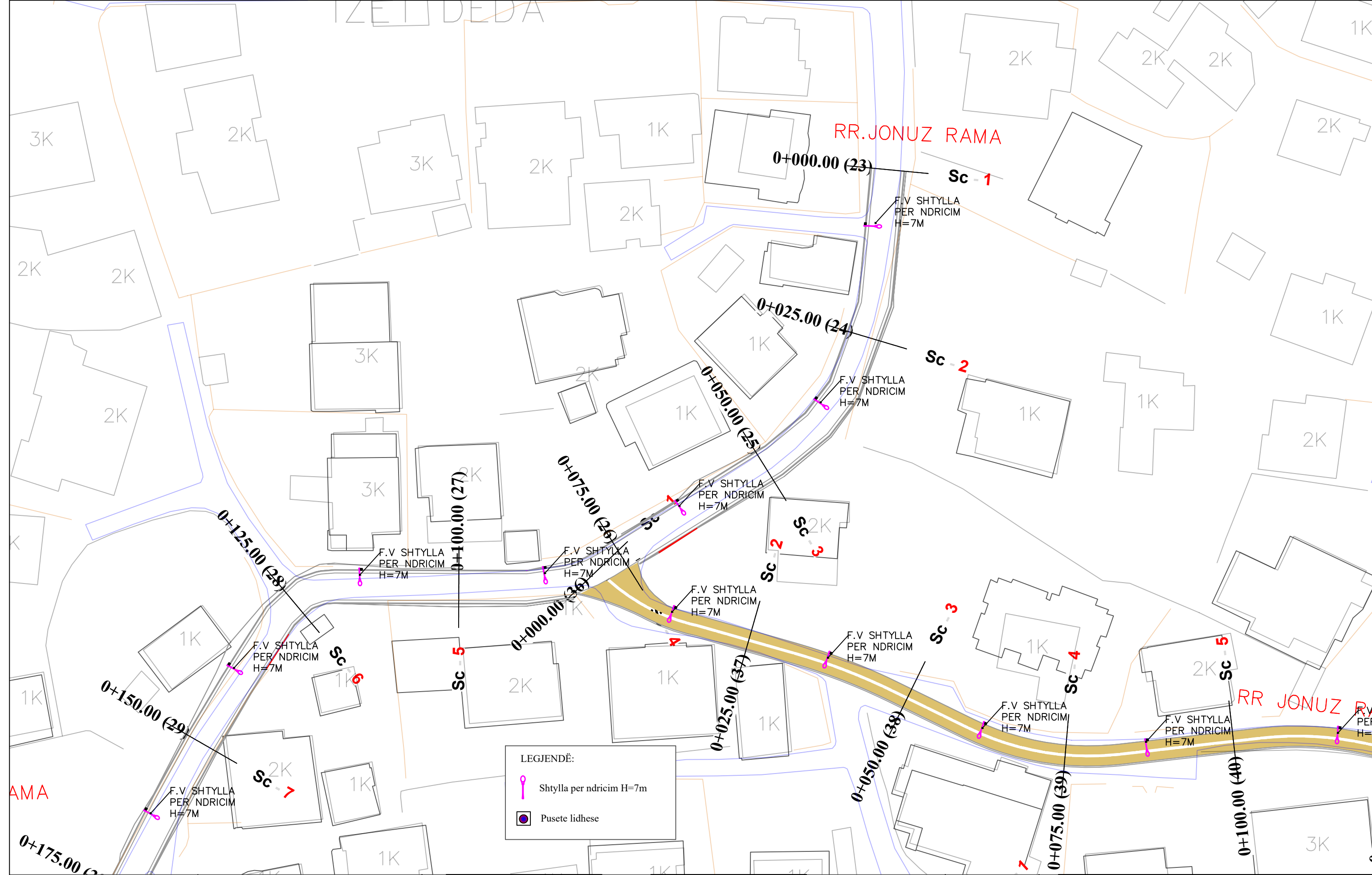

**LEGJENDË:**

- Shtylla per ndricim H=7m
- Pusete lidhese

REPUBLIKA E SHQIPËRISË  
BASHKIA E TIRANËS

OBJEKTI: "RIKUALIFIKIMI URBAN I ZONËS INFORMALE QË KUFIZOHET NGA RRUGËT -SABAUDIN GABRANI -JONUZ RAMA-HAMDI CULLHAJ-DAMIAN HIMARIOTI-BARI ISHKA-VASFI SAMIMI-ALUSH ELMAZ TAKA."

Projektoi :  
Ing.A.JAKOVA Ark.M.DADO  
Ing.G.ISLAMI Ing.Gjeol.Xh.KASMI  
Ing.S.MYRSELI Ing.Mjedis.E.CALI  
Ing.P.SHKURTI Top.A.BECECI

Projektoi :  
**"S&L STUDIO SH.P.K"**  
Projektim-kupervizion-cosnulence  
 PROJEKTIM DESIGN SUPERVISION KOLAUDIM

|         |                 |
|---------|-----------------|
| FAZA    | PROJEKT ZBATIMI |
| DORËZIM | 1.0             |



|                                |       |
|--------------------------------|-------|
| PLANIMETRI RRUGA RR.JONUZ RAMA |       |
| SHKALLA                        | 1:500 |
| Nr. I FLETËS                   | 001   |

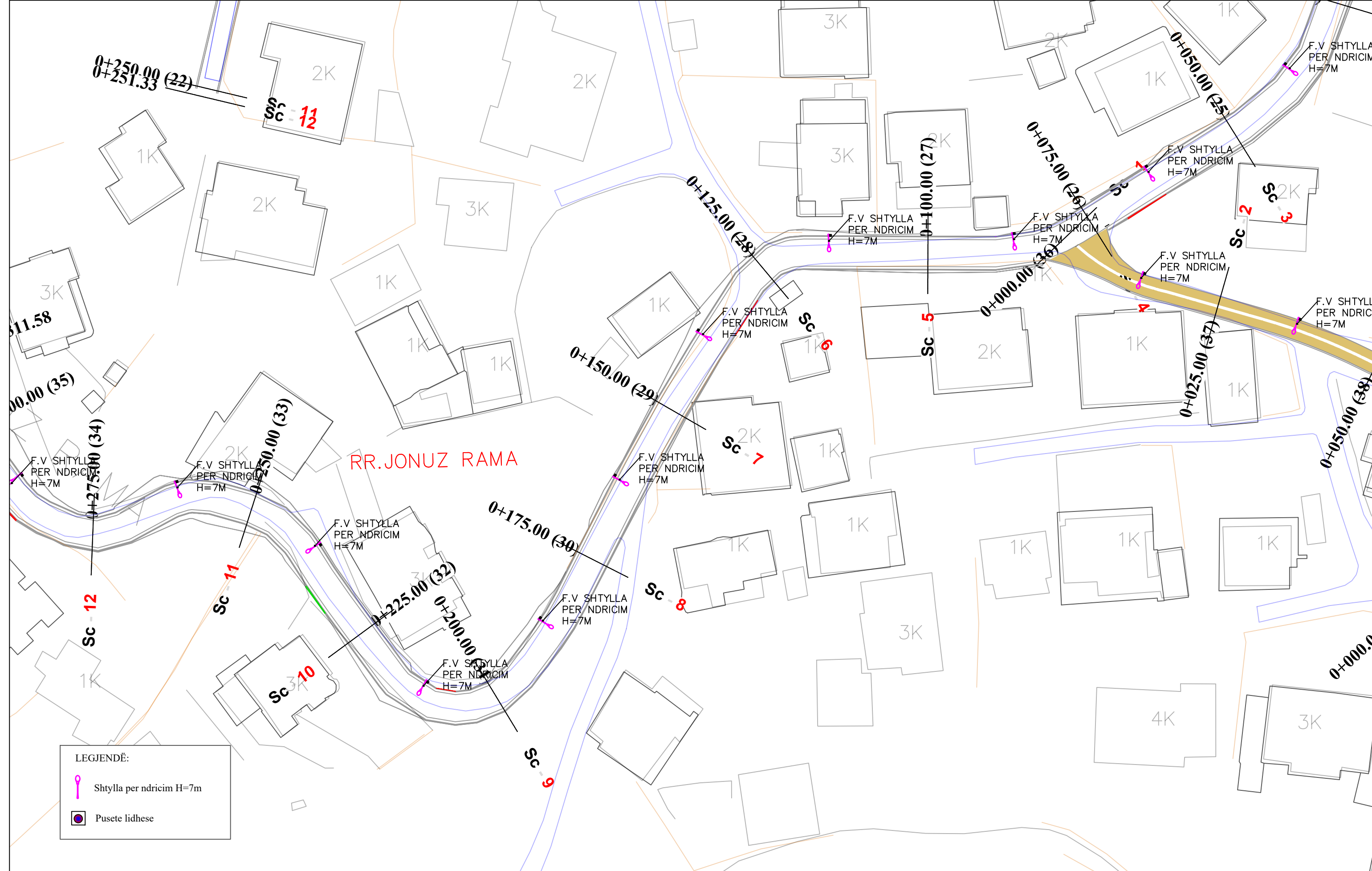



RR. JONUZ RAMA

LEGJENDË:

-  Shtylla per ndricim H=7m
-  Pusete lidhese



REPUBLIKA E SHQIPËRISË  
BASHKIA E TIRANËS

OBJEKTI: "RIKUALIFIKIMI URBAN I ZONËS INFORMALE QË KUFIZOHET NGA RRUGËT -SABAUDIN GABRANI -JONUZ RAMA-HAMDI CULLHAJ-DAMIAN HIMARIOTI-BARI ISHKA-VASFI SAMIMI-ALUSH ELMAZ TAKA."

Projektoi :  
Ing.A.JAKOVA  
Ing.G.ISLAMI  
Ing.S.MYRSELI  
Ing.P.SHKURTI  
Ark.M.DADO  
Ing.Gjeol.Xh.KASMI  
Ing.Mjedis.E.CALI  
Top.A.BECECI

Projektoi :  
"S&L STUDIO SH.P.K"  
Projektim-kupervizion-cosnulence  

|         |                 |
|---------|-----------------|
| FAZA    | PROJEKT ZBATIMI |
| DORËZIM | 1.0             |

|                                    |       |
|------------------------------------|-------|
| PLANIMETRI<br>RRUGA RR. JONUZ RAMA |       |
| SHKALLA                            | 1:500 |
| Nr. I FLETËS                       | 002   |

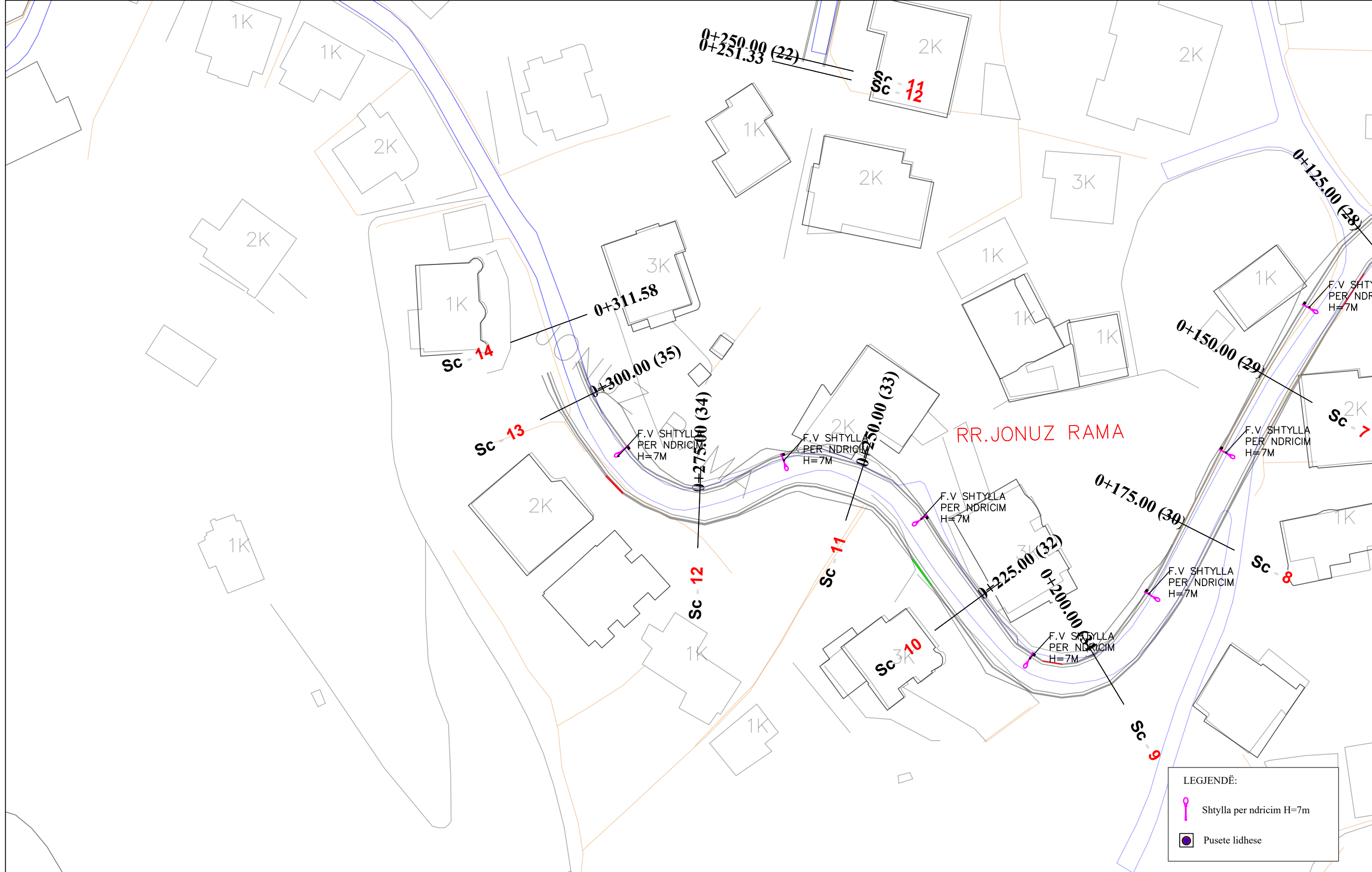

LEGJENDË:

|  |                          |
|--|--------------------------|
|  | Shtylla per ndricim H=7m |
|  | Pusete lidhese           |

REPUBLIKA E SHQIPËRISË  
BASHKIA E TIRANËS

OBJEKTI: "RIKUALIFIKIMI URBAN I ZONËS INFORMALE QË KUFIZOHET NGA RRUGËT -SABAUDIN GABRANI -JONUZ RAMA-HAMDI CULLHAJ-DAMIAN HIMARIOTI-BARI ISHKA-VASFI SAMIMI-ALUSH ELMAZ TAKA."

Projektoi :  
Ing.A.JAKOVA  
Ing.G.ISLAMI  
Ing.S.MYRSELI  
Ing.P.SHKURTI

Ark.M.DADO  
Ing.Gjeol.Xh.KASMI  
Ing.Mjedis.E.CALI  
Top.A.BECECI

Projektoi :  
"S&L STUDIO SH.P.K"  
Projektim-kupervizion-cosnulence

PROJEKTIM DESIGN  
SUPERVISION KOLAUDIM

FAZA  
DORËZIM

PROJEKT ZBATIMI  
1.0

PLANIMETRI  
RRUGA RR.JONUZ RAMA

|              |       |
|--------------|-------|
| SHKALLA      | 1:500 |
| Nr. I FLETËS | 003   |

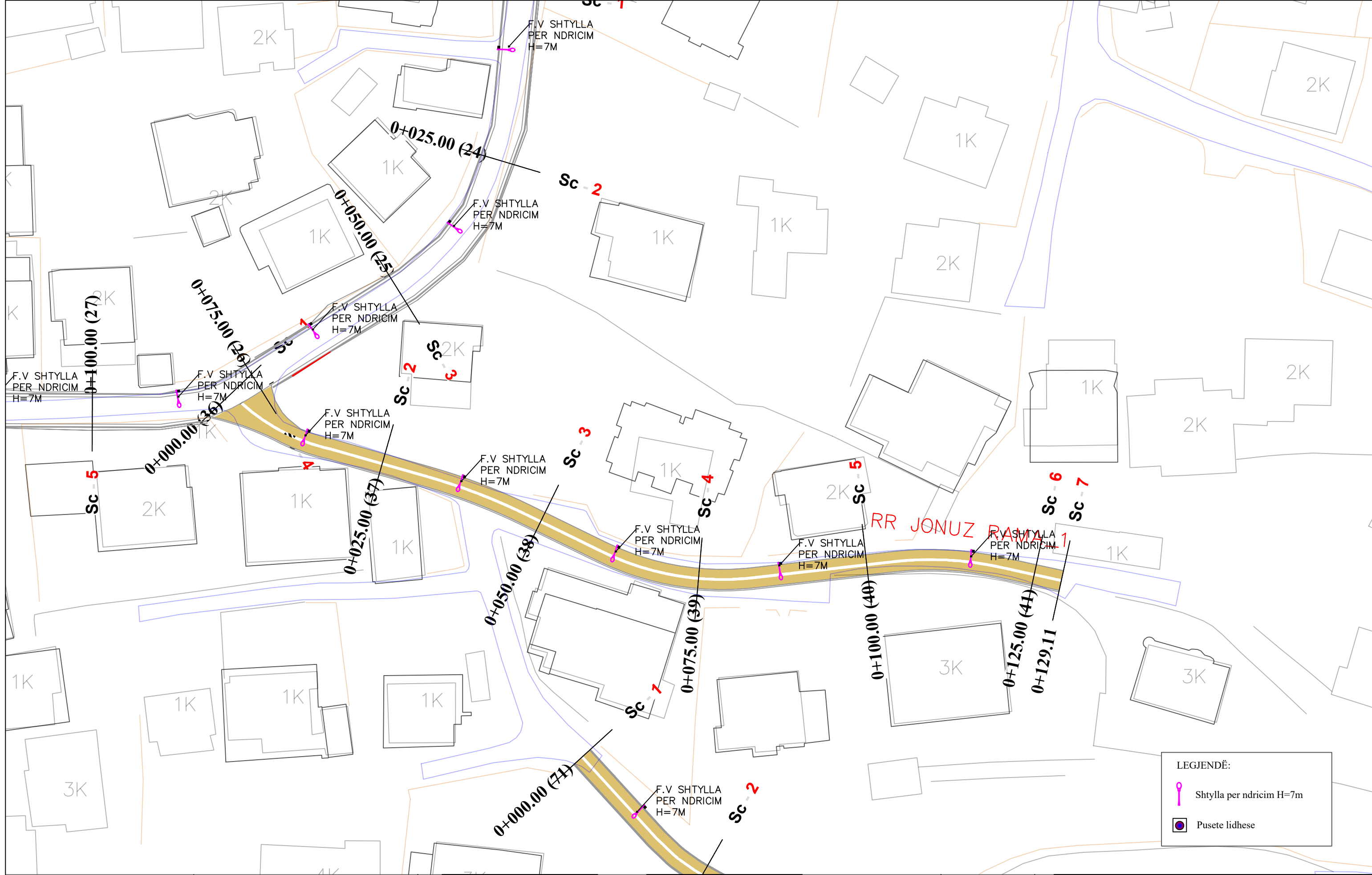

**LEGJENDË:**

- Shtylla per ndricim H=7m
- Pusete lidhese

REPUBLIKA E SHQIPËRISË  
BASHKIA E TIRANËS

OBJEKTI: "RIKUALIFIKIMI URBAN I ZONËS INFORMALE QË KUFIZOHET NGA RRUGËT -SABAUDIN GABRANI -JONUZ RAMA-HAMDI CULLHAJ-DAMIAN HIMARIOTI-BARI ISHKA-VASFI SAMIMI-ALUSH ELMAZ TAKA."

Projektoi :

Ing.A.JAKOVA  
Ing.G.ISLAMI  
Ing.S.MYRSELI  
Ing.P.SHKURTI

Ark.M.DADO  
Ing.Gjeol.Xh.KASMI  
Ing.Mjedis.E.CALI  
Top.A.BECECI

Projektoi :

**"S&L STUDIO SH.P.K"**  
Projektim-kupervizion-cosnulence

PROJEKTIM DESIGN  
SUPERVISION KOLAUDIM

FAZA

DORËZIM

PROJEKT ZBATIMI

1.0

PLANIMETRI  
RRUGA RR.JONUZ RAMA 1

|              |       |
|--------------|-------|
| SHKALLA      | 1:500 |
| Nr. I FLETËS | 001   |

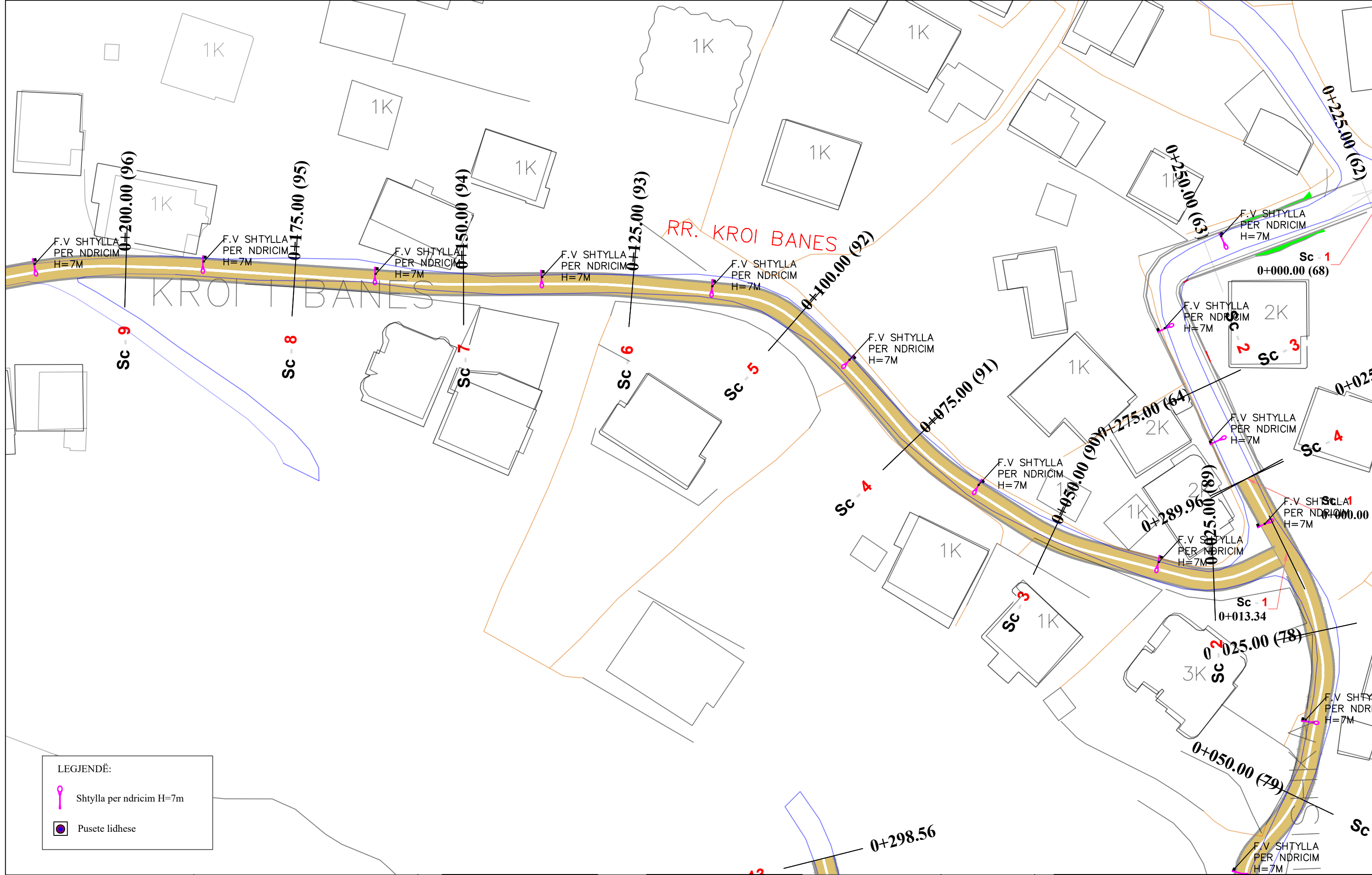



**LEGJENDË:**

- Shtylla per ndricim H=7m
- Pusete lidhese

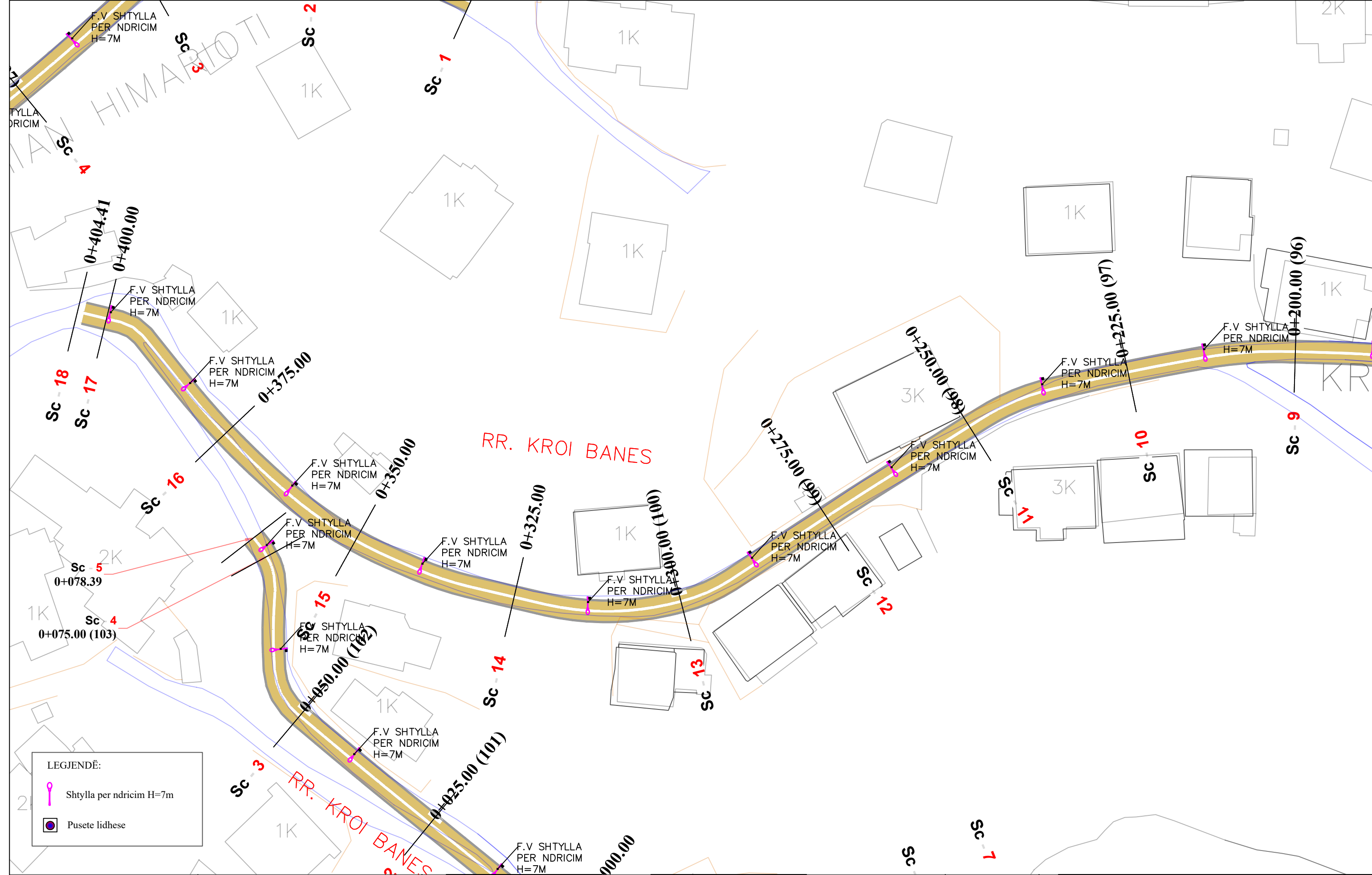
|   |   |   |  |   |  |   |                     |                            |                                   |  |
|---|---|---|--|---|--|---|---------------------|----------------------------|-----------------------------------|--|
| <br>REPUBLIKA E SHQIPËRISË<br>BASHKIA E TIRANËS | OBJEKTI: "RIKUALIFIKIMI URBAN I ZONËS INFORMALE QË KUFIZOHET NGA RRUGËT -SABAUDIN GABRANI -JONUZ RAMA-HAMDI CULLHAJ-DAMIAN HIMARIOTI-BARI ISHKA-VASFI SAMIMI-ALUSH ELMAZ TAKA." | Projektoi :<br>Ing.A.JAKOVA<br>Ing.G.ISLAMI<br>Ing.S.MYRSELI<br>Ing.P.SHKURTI |  | Ark.M.DADO<br>Ing.Gjeol.Xh.KASMI<br>Ing.Mjedis.E.CALI<br>Top.A.BECECI |  | Projektoi :<br><b>"S&amp;L STUDIO SH.P.K"</b><br>Projektim-kupervizion-cosnulence<br> | FAZA<br><br>DORËZIM | PROJEKT ZBATIMI<br><br>1.0 | PLANIMETRI<br>RRUGA RR.KROI BANES |  |
|   |   |   |  | SHKALLA<br>1:500  |  |   |                     |                            |                                   |  |
|   |   |   |  | Nr. I FLETËS<br>001   |  |   |                     |                            |                                   |  |



**LEGJENDË:**

-  Shtylla per ndricim H=7m
-  Pusete lidhese



REPUBLIKA E SHQIPËRISË  
BASHKIA E TIRANËS

OBJEKTI: "RIKUALIFIKIMI URBAN I ZONËS INFORMALE QË KUFIZOHET NGA RRUGËT -SABAUDIN GABRANI -JONUZ RAMA-HAMDI CULLHAJ-DAMIAN HIMARIOTI-BARI ISHKA-VASFI SAMIMI-ALUSH ELMAZ TAKA."

Projektoi :  
Ing.A.JAKOVA  
Ing.G.ISLAMI  
Ing.S.MYRSELI  
Ing.P.SHKURTI

Ark.M.DADO  
Ing.Gjeol.Xh.KASMI  
Ing.Mjedis.E.CALI  
Top.A.BECECI

Projektoi :  
**"S&L STUDIO SH.P.K"**  
Projektim-kupervizion-cosnulence



PROJEKTIM DESIGN  
SUPERVISION KOLAUDIM

FAZA  
DORËZIM

PROJEKT ZBATIMI  
1.0

PLANIMETRI  
RRUGA RR.KROI BANES

|              |       |
|--------------|-------|
| SHKALLA      | 1:500 |
| Nr. I FLETËS | 002   |

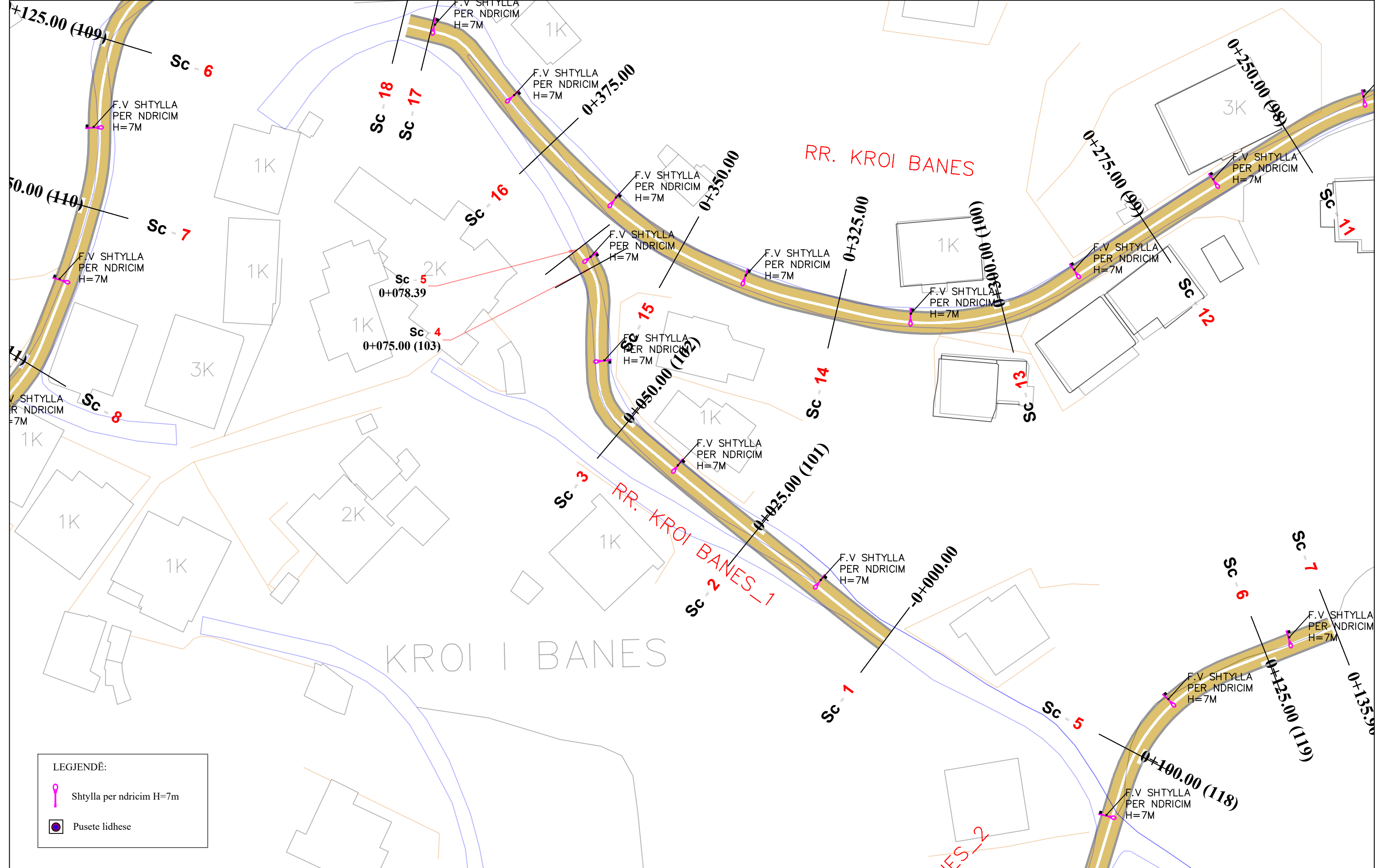

LEGJENDË:

|  |                          |
|--|--------------------------|
|  | Shtylla per ndricim H=7m |
|  | Pusete lidhese           |

REPUBLIKA E SHQIPËRISË  
BASHKIA E TIRANËS

OBJEKTI: "RIKUALIFIKIMI URBAN I ZONËS INFORMALE QË KUFIZOHET NGA RRUGËT -SABAUDIN GABRANI -JONUZ RAMA-HAMDI CULLHAJ-DAMIAN HIMARIOTI-BARI ISHKA-VASFI SAMIMI-ALUSH ELMAZ TAKA."

Projektoi :  
Ing.A.JAKOVA  
Ing.G.ISLAMI  
Ing.S.MYRSELI  
Ing.P.SHKURTI

Ark.M.DADO  
Ing.Gjeol.Xh.KASMI  
Ing.Mjedis.E.CALI  
Top.A.BECECI

Projektoi :  
"S&L STUDIO SH.P.K"  
Projektim-kupervizion-cosnulence

PROJEKTIM DESIGN  
SUPERVISION KOLAUDIM

FAZA  
DORËZIM

PROJEKT ZBATIMI  
1.0

|                                    |       |
|------------------------------------|-------|
| PLANIMETRI<br>RRUGA RR.KROI BANES1 |       |
| SHKALLA                            | 1:500 |
| Nr. I FLETËS                       | 001   |

# KROI I BANES

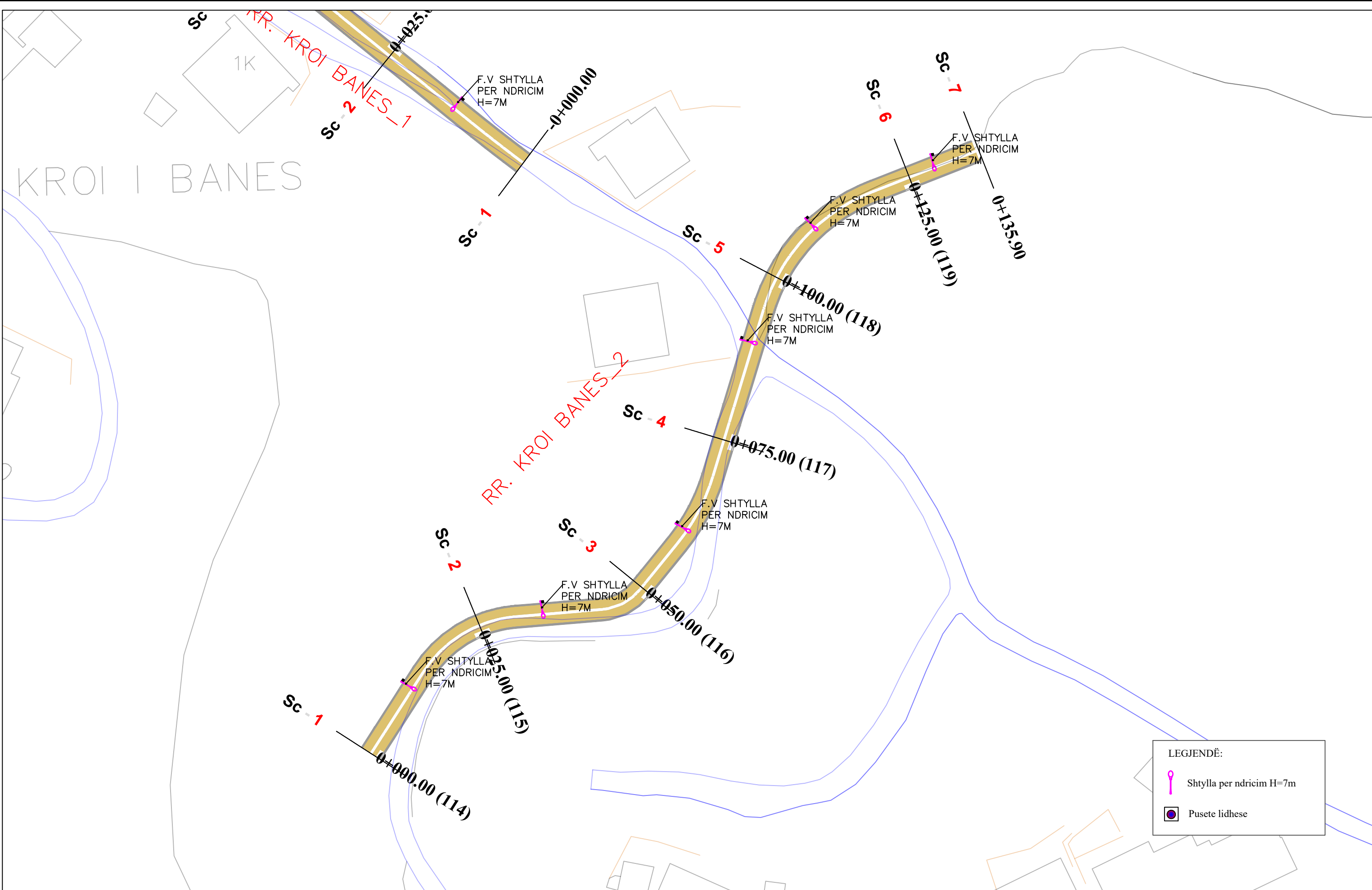

**LEGJENDË:**

- Shtylla per ndricim H=7m
- Pusete lidhese

REPUBLIKA E SHQIPËRISË  
BASHKIA E TIRANËS

OBJEKTI: "RIKUALIFIKIMI URBAN I ZONËS INFORMALE QË KUFIZOHET NGA RRUGËT -SABAUDIN GABRANI -JONUZ RAMA-HAMDI CULLHAJ-DAMIAN HIMARIOTI-BARI ISHKA-VASFI SAMIMI-ALUSH ELMAZ TAKA."

Projektoi :  
 Ing.A.JAKOVA  
 Ing.G.ISLAMI  
 Ing.S.MYRSELI  
 Ing.P.SHKURTI

Ark.M.DADO  
 Ing.Gjeol.Xh.KASMI  
 Ing.Mjedis.E.CALI  
 Top.A.BECECI

Projektoi :  
**"S&L STUDIO SH.P.K"**  
 Projektim-kupervizion-cosnulence

PROJEKTIM DESIGN  
SUPERVISION KOLAUDIM

|         |                 |
|---------|-----------------|
| FAZA    | PROJEKT ZBATIMI |
| DORËZIM | 1.0             |

|                                    |       |
|------------------------------------|-------|
| PLANIMETRI<br>RRUGA RR.KROI BANES2 |       |
| SHKALLA                            | 1:500 |
| Nr. I FLETËS                       | 001   |

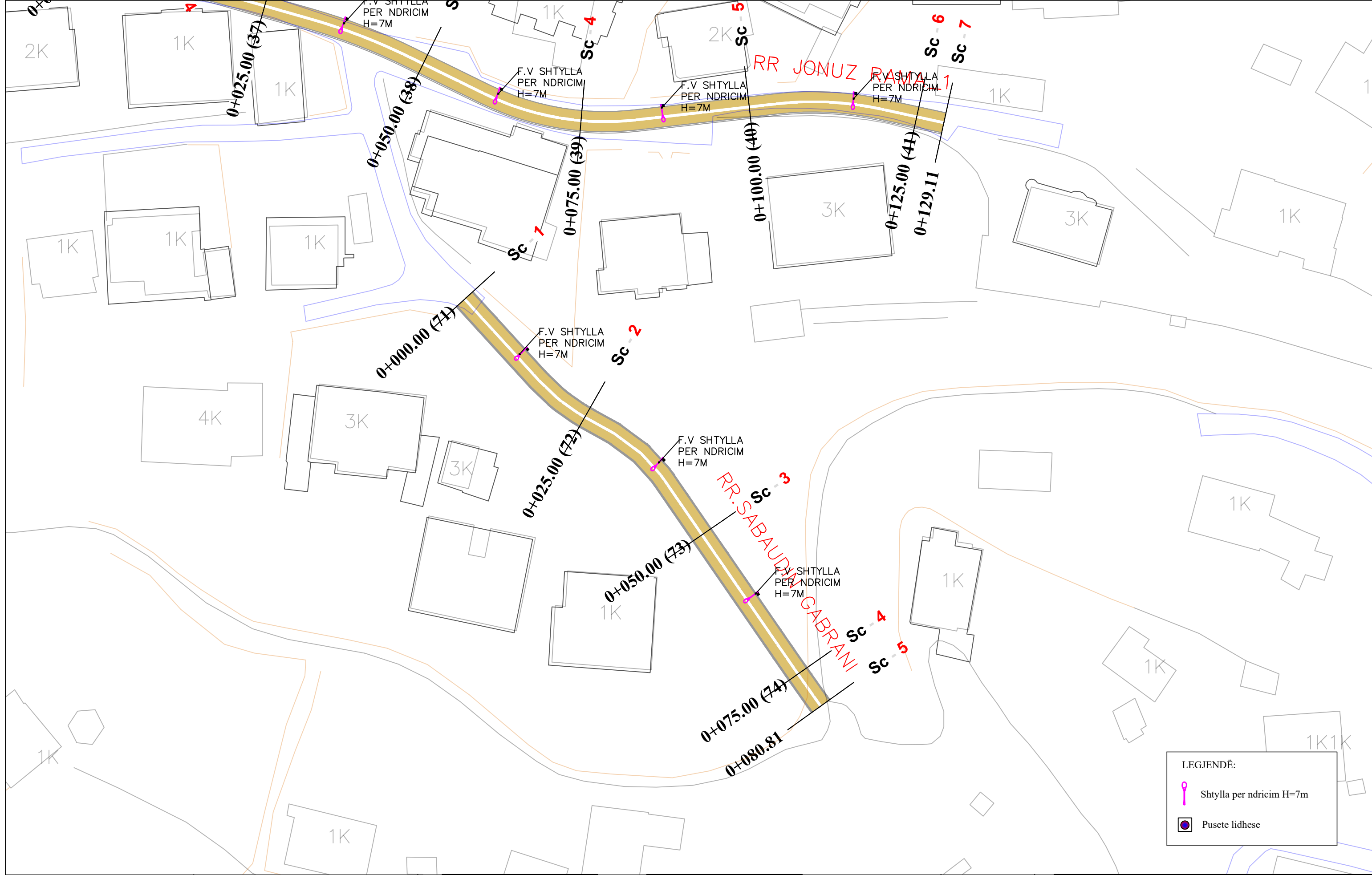

LEGJENDË:

|  |                          |
|--|--------------------------|
|  | Shtylla per ndricim H=7m |
|  | Pusete lidhese           |



REPUBLIKA E SHQIPËRISË  
BASHKIA E TIRANËS

OBJEKTI: "RIKUALIFIKIMI URBAN I ZONËS INFORMALE QË KUFIZOHET NGA RRUGËT -SABAUDIN GABRANI -JONUZ RAMA-HAMDI CULLHAJ-DAMIAN HIMARIOTI-BARI ISHKA-VASFI SAMIMI-ALUSH ELMAZ TAKA."

Projektoi :

|               |                    |
|---------------|--------------------|
| Ing.A.JAKOVA  | Ark.M.DADO         |
| Ing.G.ISLAMI  | Ing.Gjeol.Xh.KASMI |
| Ing.S.MYRSELI | Ing.Mjedis.E.CALI  |
| Ing.P.SHKURTI | Top.A.BECECI       |

Projektoi :

**"S&L STUDIO SH.P.K"**

Projektim-kupervizion-cosnulence



PROJEKTIM DESIGN SUPERVISION KOLAUDIM

|         |                 |
|---------|-----------------|
| FAZA    | PROJEKT ZBATIMI |
| DORËZIM | 1.0             |



|   |       |
|---|-------|
| PLANIMETRI<br>RRUGA RR.SABAUDIN GABRANI |       |
| SHKALLA                                 | 1:500 |
| Nr. I FLETËS                            | 001   |

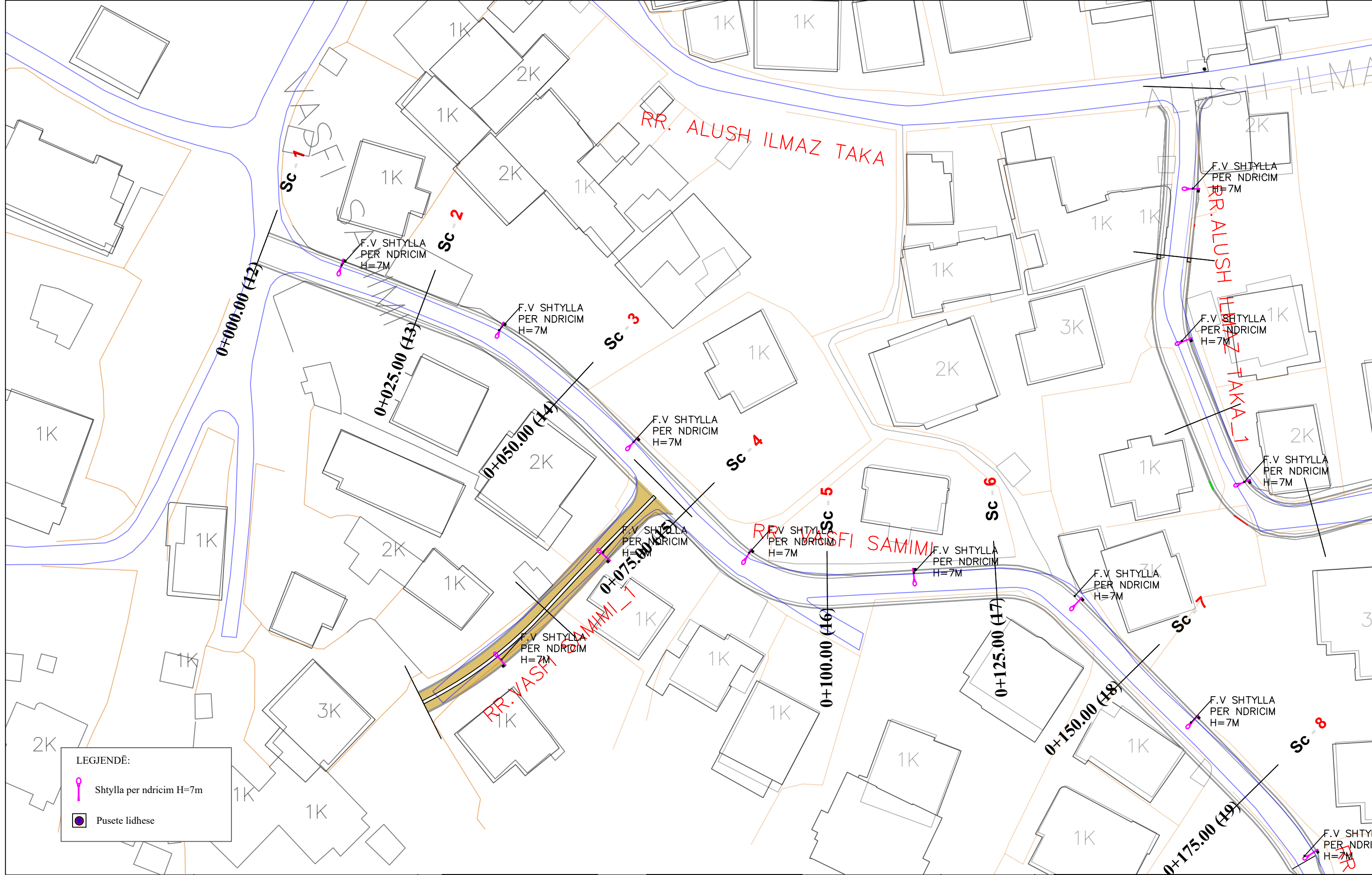



LEGJENDË:

- Shtylla per ndricim H=7m
- Pusete lidhese

|   |   |  |     |  |       |      |                 |                                     |  |
|---|---|--|-----|--|-------|------|-----------------|-------------------------------------|--|
| <br>REPUBLIKA E SHQIPËRISË<br>BASHKIA E TIRANËS | OBJEKTI: "RIKUALIFIKIMI URBAN I ZONËS INFORMALE QË KUFIZOHET NGA RRUGËT -SABAUDIN GABRANI -JONUZ RAMA-HAMDI CULLHAJ-DAMIAN HIMARIOTI-BARI ISHKA-VASFI SAMIMI-ALUSH ELMAZ TAKA." | Projektoi :<br>Ing.A.JAKOVA Ark.M.DADO<br>Ing.G.ISLAMI Ing.Gjeol.Xh.KASMI<br>Ing.S.MYRSELI Ing.Mjedis.E.CALI<br>Ing.P.SHKURTI Top.A.BECECI |     | Projektoi :<br><b>"S&amp;L STUDIO SH.P.K"</b><br>Projektim-kupervizion-cosnulence<br> |       | FAZA | PROJEKT ZBATIMI | PLANIMETRI<br>RRUGA RR.VASFI SAMIMI |  |
|   |   | DORËZIM  | 1.0 | SHKALLA  | 1:500 |      |                 |                                     |  |
|   |   | Nr. I FLETËS 001   |     |  |       |      |                 |                                     |  |

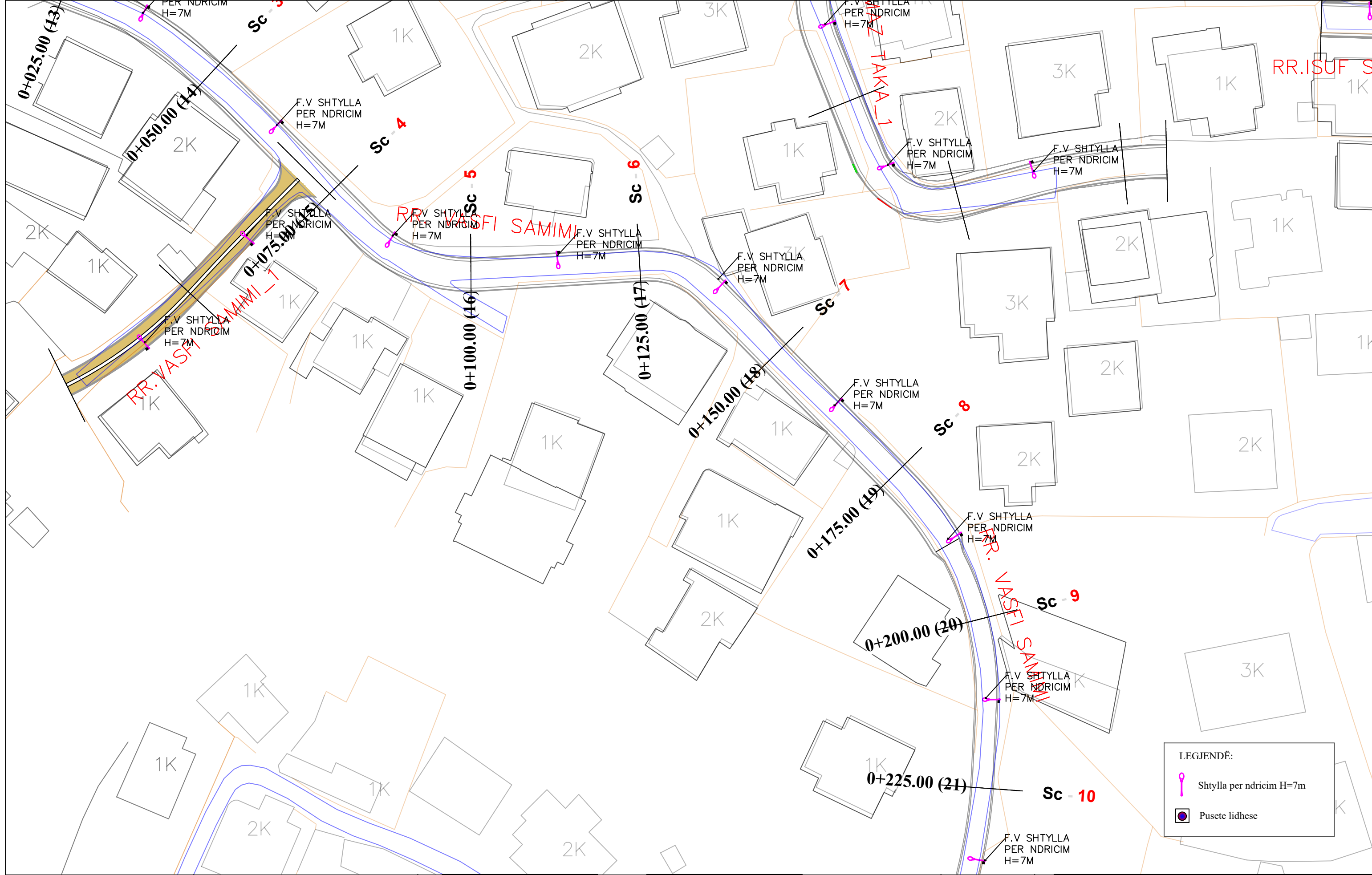

OBJEKTI: "RIKUALIFIKIMI URBAN I ZONËS INFORMALE QË KUFIZOHET NGA RRUGËT -SABAUDIN GABRANI -JONUZ RAMA-HAMDI CULLHAJ-DAMIAN HIMARIOTI-BARI ISHKA-VASFI SAMIMI-ALUSH ELMAZ TAKA."

Projektoi :  
Ing.A.JAKOVA  
Ing.G.ISLAMI  
Ing.S.MYRSELI  
Ing.P.SHKURTI

Ark.M.DADO  
Ing.Gjeol.Xh.KASMI  
Ing.Mjedis.E.CALI  
Top.A.BECECI

Projektoi :  
"S&L STUDIO SH.P.K"  
Projektim-kupervizion-cosnulence

PROJEKTIM DESIGN  
SUPERVISION KOLAUDIM

FAZA  
DORËZIM

PROJEKT ZBATIMI  
1.0

PLANIMETRI  
RRUGA RR.VASFI SAMIMI

|              |       |
|--------------|-------|
| SHKALLA      | 1:500 |
| Nr. I FLETËS | 002   |

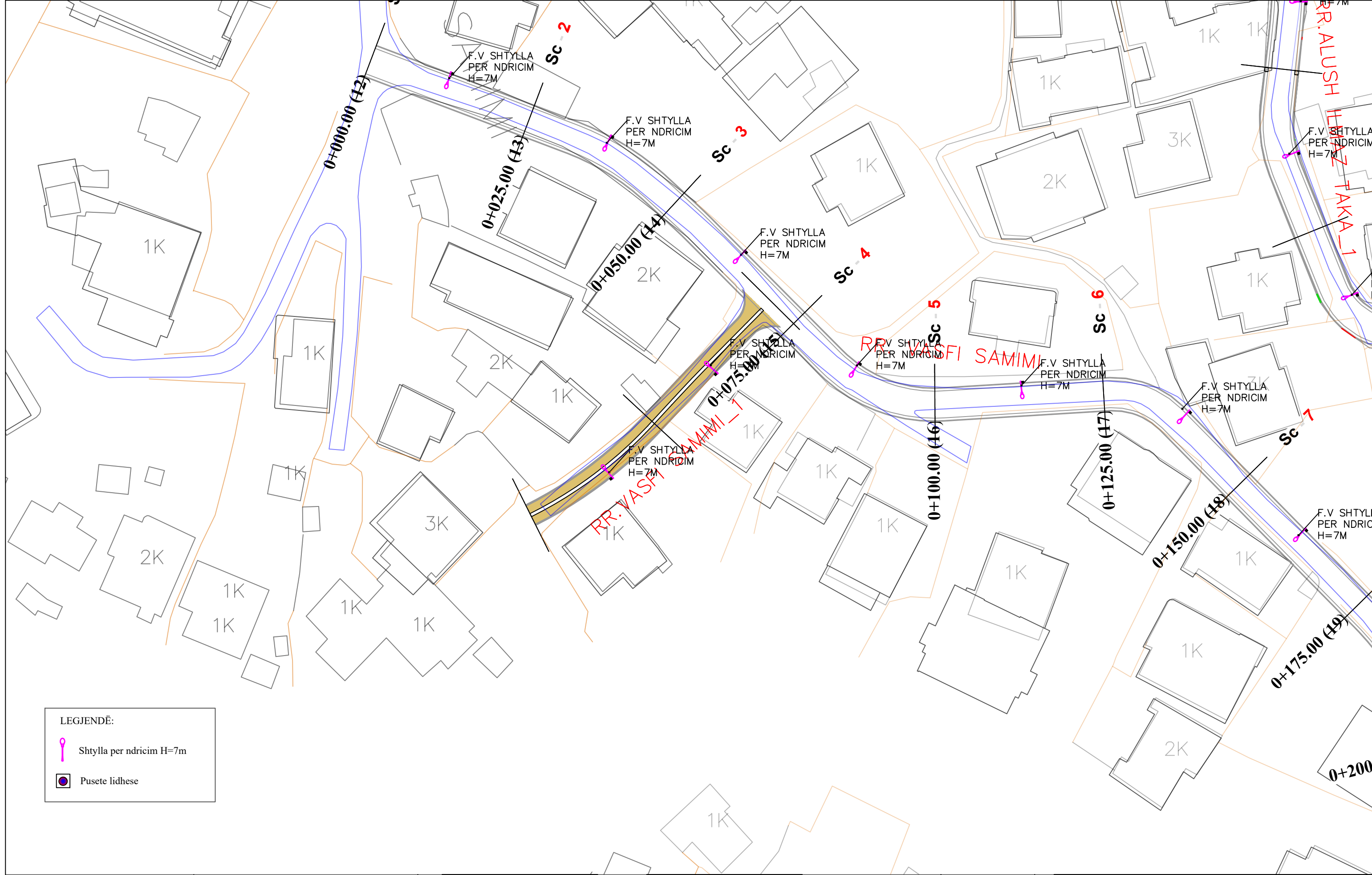

LEGJENDË:

|  |                          |
|--|--------------------------|
|  | Shtylla per ndricim H=7m |
|  | Pusete lidhese           |



REPUBLIKA E SHQIPËRISË  
BASHKIA E TIRANËS

OBJEKTI: "RIKUALIFIKIMI URBAN I ZONËS INFORMALE QË KUFIZOHET NGA RRUGËT -SABAUDIN GABRANI -JONUZ RAMA-HAMDI CULLHAJ-DAMIAN HIMARIOTI-BARI ISHKA-VASFI SAMIMI-ALUSH ELMAZ TAKA."

Projektoi :  
Ing.A.JAKOVA  
Ing.G.ISLAMI  
Ing.S.MYRSELI  
Ing.P.SHKURTI

Ark.M.DADO  
Ing.Gjeol.Xh.KASMI  
Ing.Mjedis.E.CALI  
Top.A.BECECI

Projektoi :  
**"S&L STUDIO SH.P.K"**  
Projektim-kupervizion-cosnulence



PROJEKTIM DESIGN  
SUPERVISION KOLAUDIM

FAZA  
DORËZIM

PROJEKT ZBATIMI  
1.0

|                                     |       |
|-------------------------------------|-------|
| PLANIMETRI<br>RRUGA RR.VASFI SAMIMI |       |
| SHKALLA                             | 1:500 |
| Nr. I FLETËS                        | 001   |

*09-PROFILA DHE DETAJE TIP (RRUGË DHE SINJALISTIKË)*

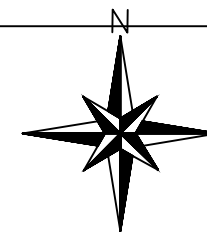

## PUSETE KONTROLLI D=1000 mm H=1500-2000 mm SHK 1:50

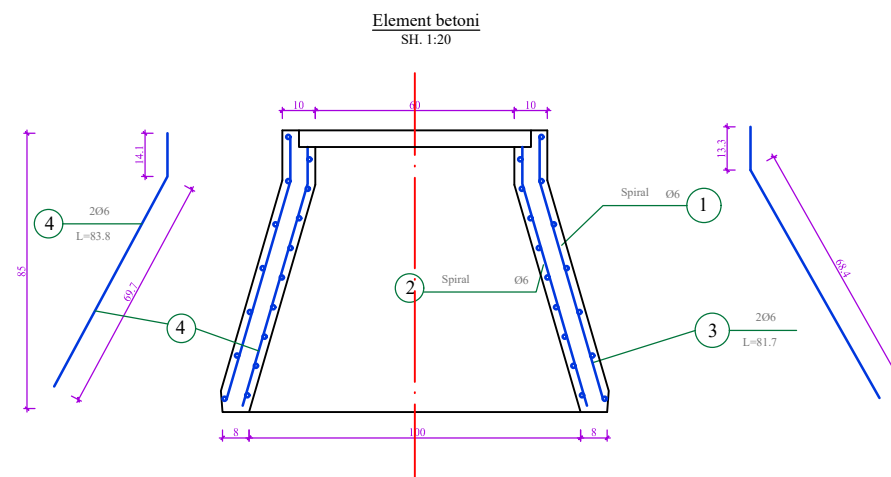
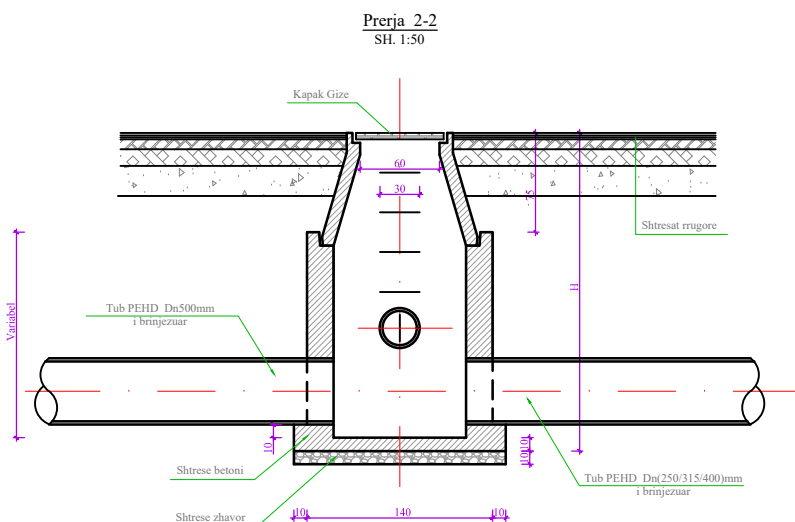
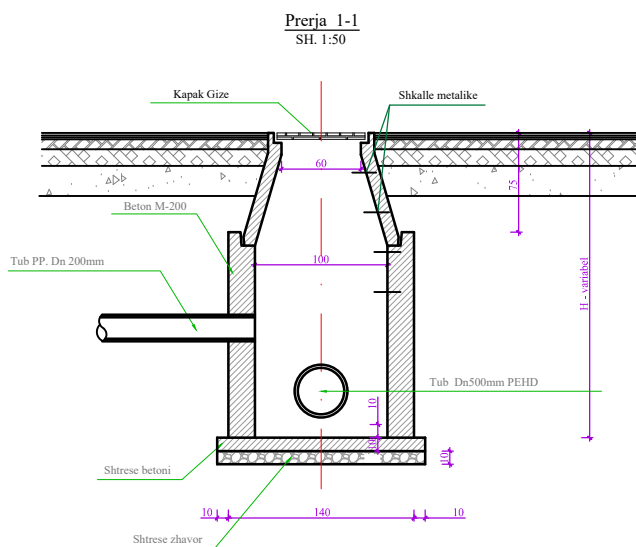

## PUSETE KONTROLLI 800x800 mm SHK 1:50

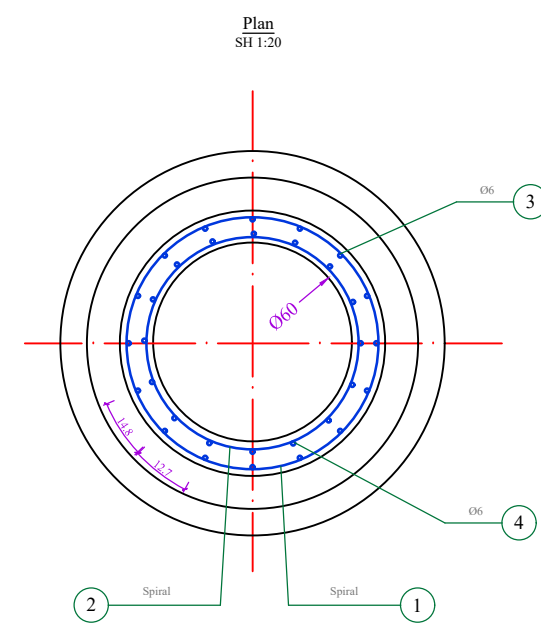
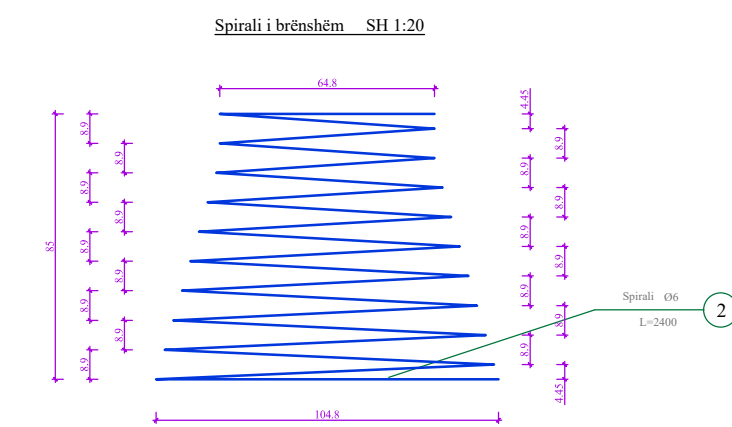
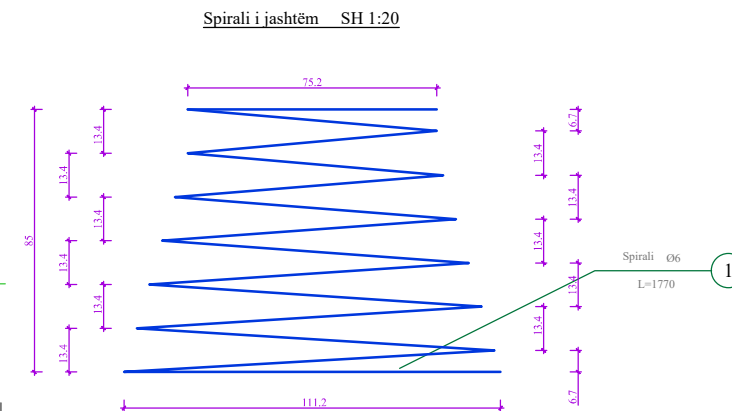
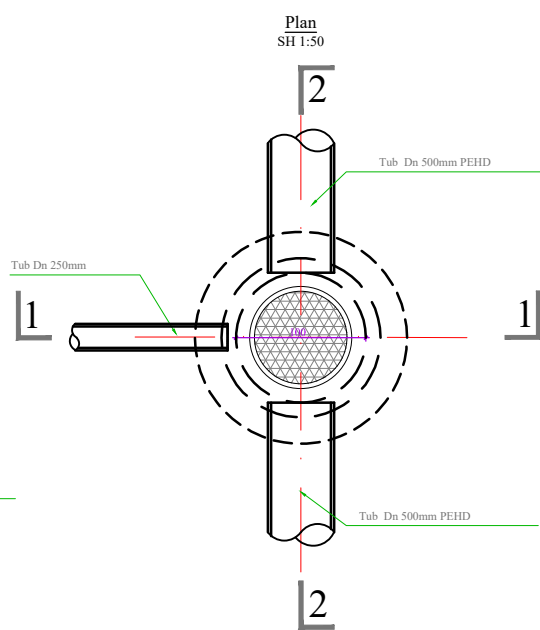
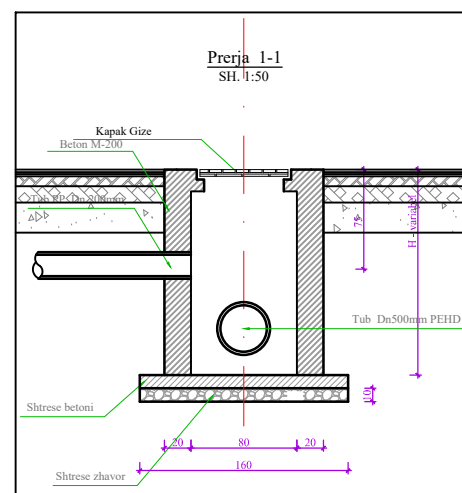

- SHËNIM:**
1. Numri i degëve të kolektorëve dhe pozicionimi i tyre do të merret sipas planimetrisë së rrjetit të K.U.Z.
  2. Lartësia e pusëtës do të merret sipas profilit gjatësor të K.U.Z.
  3. Për realizimin e pusëtës do të përdoret beton M-250.
  4. Poshtë pusëtës do të vendoset shtresë 10cm beton i varfër dhe nën të 10cm shtresë çakëll ose zhavor.
  5. Kapaku i gizës do të ketë diametër Ø60cm dhe do t'i rezistojë një ngarkese jo më të vogël se 15ton.
  6. Detajet janë vizatuar në cm.

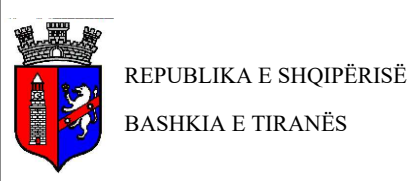

OBJEKTI: "RIKUALIFIKIMI URBAN I ZONËS INFORMALE QË KUFIZOHET NGA RRUGËT -SABAUDIN GABRANI -JONUJ RAMA-HAMDI CULLHAJ-DAMIAN HIMARIOTI-BARI ISHKA-VASFI SAMIMI-ALUSH ELMAZ TAKA."

Projektoi :  
Ing.A.JAKOVA  
Ing.G.ISLAMI  
Ing.S.MYRSELI  
Ing.P.SHKURTI  
Ark.M.DADO  
Ing.Gjeol.Xh.KASMI  
Ing.Mjedis.E.CALI  
Top.A.BECECI

Projektoi :  
"S&L STUDIO SH.P.K"  
Projektim-kupervizion-cosnulence  
**R A I D - G**  
PROJEKTIM DESIGN  
SUPERVISION KONTROLIMI

|         |                 |                  |
|---------|-----------------|------------------|
| FAZA    | PROJEKT ZBATIMI | PROFILI TIP      |
| DORËZIM | 1.0             | SHKALLA          |
|         |                 | Nr. I FLETËS 001 |