

**MIRATOI  
KRYETARI I BASHKISË  
ERISELDA SEFA**



## **PROJEKT ZBATIMI**

**Rindërtimi i shkollës 9-vjeçare "Hysen Xheka"  
KARBUNARË**

**DREJTORIA E PLANIFIKIMIT  
MIMOZA HAXHIU**



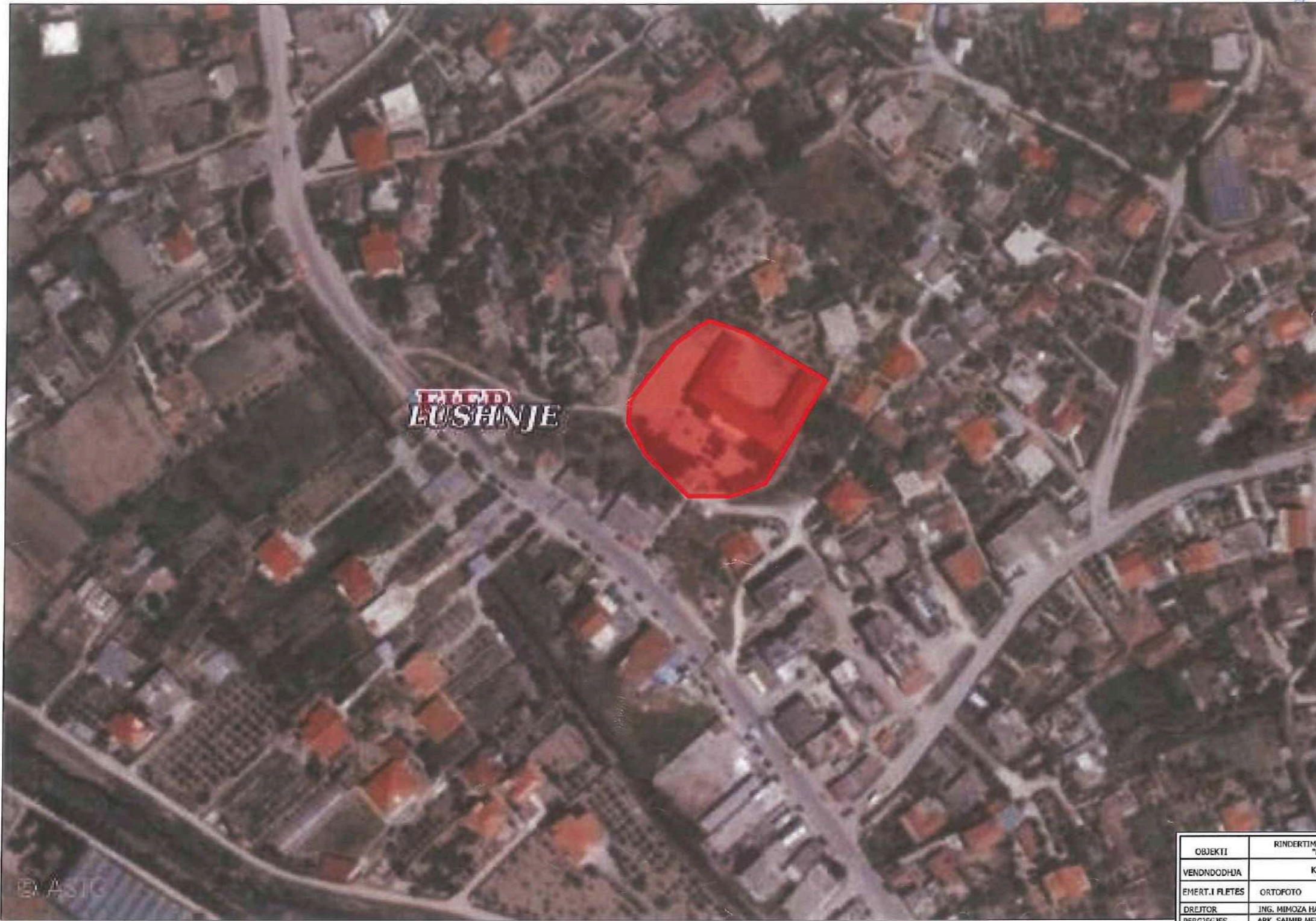

OBJEKTI	RINDERTIMI I SHKOLLËS 9-VJEÇARE "HYSEN XHIEKA"	NR.FLETES	A-01
VENDNDODHJA	KARBUNARE	FORMATI	420x297
EMERT.I FLETES	ORTOFOTO	SHKALLA	
DREJTOR	ING. MIMOZA HAXHIU		
PERGJEGJES	ARK. SAIMIR MEBELLI		
SPECIALIST	ARK. OKSANA BAKHO		
SPECIALIST	ORJALD DEBINA		
SPECIALIST	ING. ARTUR SINANI		
SPECIALIST	ING. ARBEN MUCA		
SPECIALIST	ING. MALDIN CELA		
SPECIALIST	ING. KLAJDI MYZEQARI		



LIDHJA E QENDRES SE QYTETIT TE LUSHNYES ME SHKOLLEN "HYSEN XHEKA", KARBUNARE - SH. 1:10000

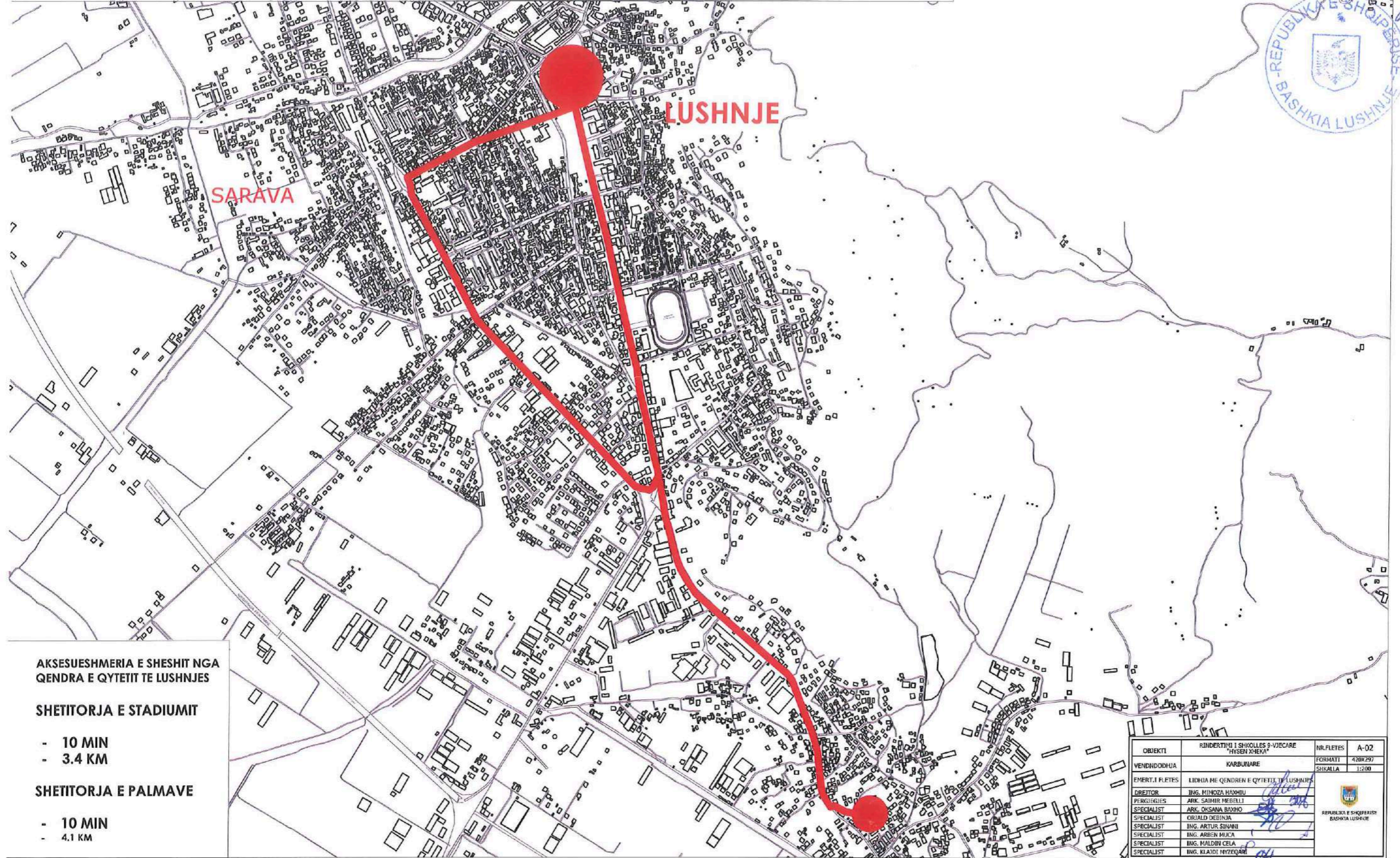

AKSESUESHMERIA E SHESHIT NGA QENDRA E QYTETIT TE LUSHNYES

SHETITORJA E STADIUMIT

- 10 MIN
- 3.4 KM

SHETITORJA E PALMAVE

- 10 MIN
- 4.1 KM

OBJEKTI	RINDERTIMI I SHKOLLES 8-VJECARE "HYSEN XHEKA"	NR.FLETES	A-02
VENDNDODHJA	KARBUNARE	FORMATI	420X297
EMERT.I FLETES	LIDHJA ME QENDREN E QYTETIT TE LUSHNYES	SHKALLA	1:200
DIREKTOR	ING. MIMOZA HAXHIU		
PERGJEGJES	ARK. SAHIR MEBELLI		
SPECIALIST	ARK. OKSANA BAXHO		
SPECIALIST	ORJALD DEBINJA		
SPECIALIST	ING. ARTUR SINANI		
SPECIALIST	ING. ARBEN MUJA		
SPECIALIST	ING. MALDIN CELA		
SPECIALIST	ING. KLADI NYZEQARI		





OBJEKTI	RINDERTIMI I SHKOLLES 9-VJECARE "HYSEN XHEKA"	NR.FLETES	A-03
VENDNDODHJA	KARBUNARE	FORMATI	420X297
EMERT.I FLETES	FOTO TE GIENDJES EKZISTUESE	SHKALLA	
DIREKTOR	ING. MIMOZA HAXHIU	 REPUBLIKA E SHQIPERISE BASHKIA LUSHNJE	
PERGJEGJES	ARK. SAJMIR MEBELLI		
SPECIALIST	ARK. OKSANA BAXHO		
SPECIALIST	ORJALD DEBINJA		
SPECIALIST	ING. ARTUR SINANI		
SPECIALIST	ING. ARBEN MUCA		
SPECIALIST	ING. MALDIN CELA		
SPECIALIST	ING. KLAJDI MYZEQARI		



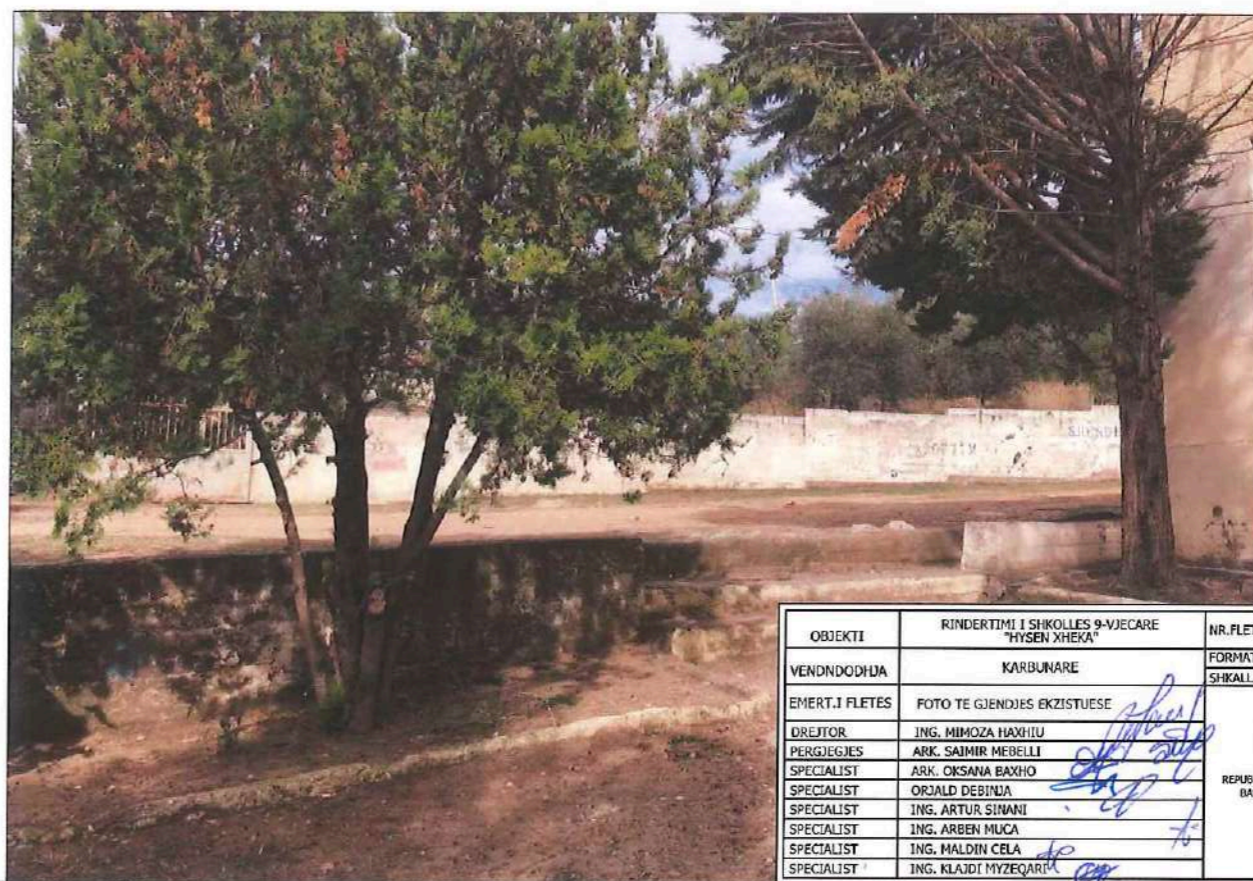

OBJEKTI	RINDERTIMI I SHKOLLËS 9-VJEÇARE "HYSEN XHEKA"	NR. FLETES	A-04
VENDNDODHJA	KARBUNARE	FORMATI	420X297
EMERT.I FLETES	FOTO TE GJENDJES EKZISTUESE	SHKALLA	
DREJTOR	ING. MIMOZA HAXHILU		
PERGJEGJES	ARK. SAIMIR MEBELLI		
SPECIALIST	ARK. OKSANA BAXHO		
SPECIALIST	ORJALD DEBINJA		
SPECIALIST	ING. ARTUR SINANI		
SPECIALIST	ING. ARBEN MUÇA		
SPECIALIST	ING. MALDIN CELA		
SPECIALIST	ING. KLADI MYZEQARI		



REPUBLIKA E SHQIPËRIE  
 BASHKIA E LUSHNJË



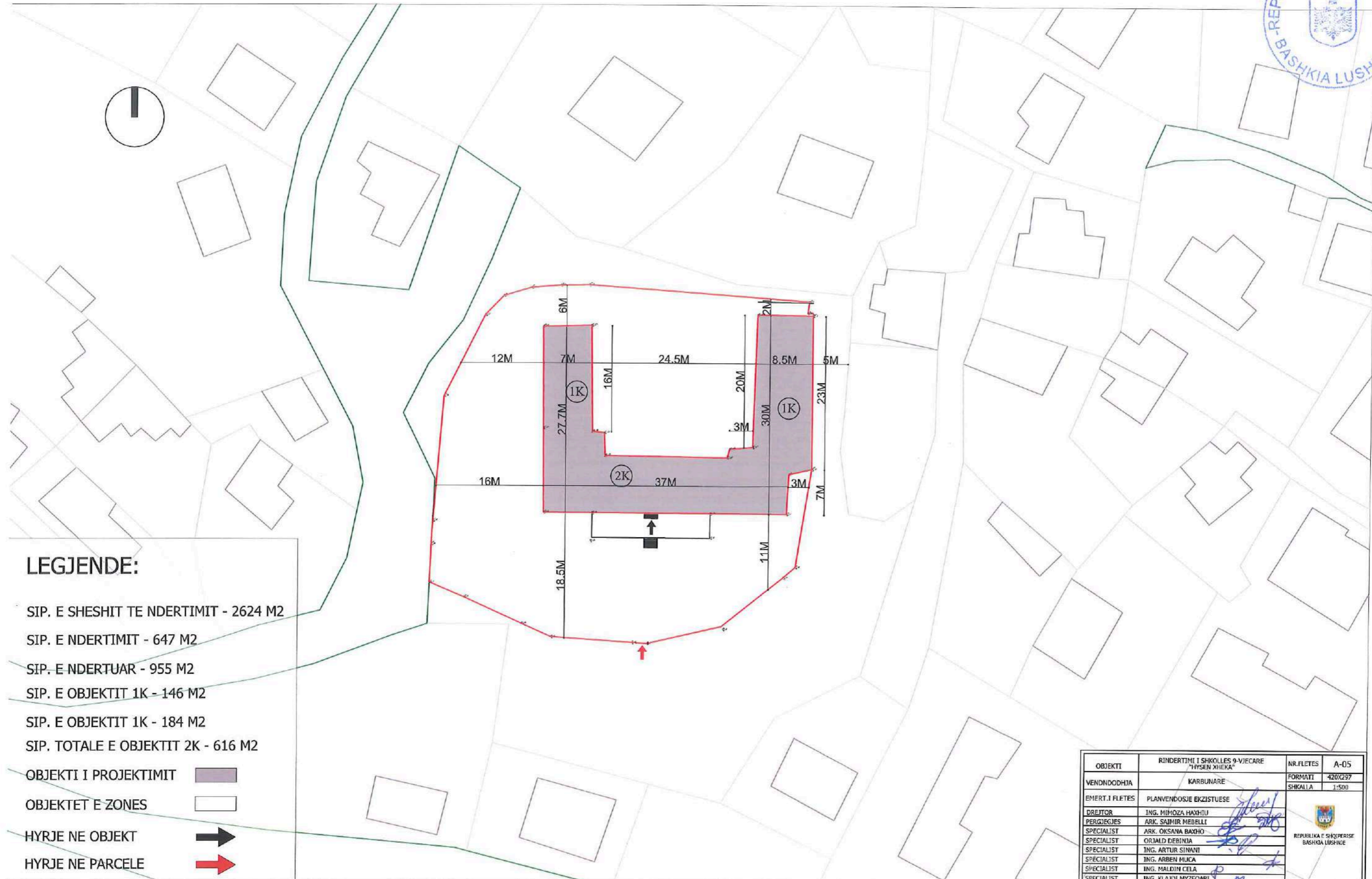
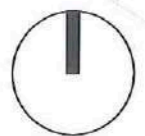

**LEGJENDE:**

- SIP. E SHESHIT TE NDERTIMIT - 2624 M2
- SIP. E NDERTIMIT - 647 M2
- SIP. E NDERTUAR - 955 M2
- SIP. E OBJEKTIT 1K - 146 M2
- SIP. E OBJEKTIT 1K - 184 M2
- SIP. TOTALE E OBJEKTIT 2K - 616 M2
- OBJEKTI I PROJEKTIMIT
- OBJEKTET E ZONES
- HYRJE NE OBJEKT
- HYRJE NE PARCELE

OBJEKTI	RINDERTIMI I SHKOLLES 9-VJECARE "HYSEN XHEKA"	NR. FLETES	A-05
VENDNDODHJA	KARBUNARE	FORMATI	420x297
EMERT. I FLETES	PLANVENDOSJE EKZISTUESE	SHKALLA	1:500
DREJTOR	ING. MIMOZA HAXHIU		
PERGJEGJES	ARK. SAJMIR MEBELLI		
SPECIALIST	ARK. OKSANA BAXHO		
SPECIALIST	ORJALD DEBINJA		
SPECIALIST	ING. ARTUR SINANI		
SPECIALIST	ING. ARBEN MUCA		
SPECIALIST	ING. MALDIN CELA		
SPECIALIST	ING. KLAUDI MYZEQARI		



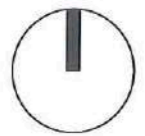

**LEGJENDE:**

- SIP. E SHESHIT TE NDERTIMIT - 2624 M2
- SIP. E NDERTUAR - 951 M2
- SIP. E NDERTIMIT - 640 M2
- SIP. E KATIT PERDHE - 640 M2
- SIP. E KATIT TE PARE - 311 M2
- OBJEKTI I PROJEKTIMIT
- OBJEKTET E ZONES
- HYRJE NE OBJEKT
- HYRJE NE PARCELE

OBJEKTI	RINDERTIMI I SHKOLLES 9-VJECARE "HYSEN XHEKA"	NR. FLETES	A-06
VENDNDODHJA	KARBUNARE	FORMATI	420X297
EMERT. I FLETES	PLANVENDOSJE E OBJEKTIT TE PROPOZUAR	SHKALLA	1:500
DREJTOR	ING. MIMOZA HAXHIU	REPUBLIKA E SHQIPERISE BASHKIA E LUSHNJE	
PERGJEGJES	ARK. SAJMIR MEBELLI		
SPECIALIST	ARK. OKSANA BASHO		
SPECIALIST	ORJALD DEBINJA		
SPECIALIST	ING. ARTUR SINANI		
SPECIALIST	ING. ARBEN MUCA		
SPECIALIST	ING. MALDIN CELA		
SPECIALIST	ING. KLAJDI MYZEQARI		



**LEGJENDE:**

SIP. E GJELBERIMIT - 512.8 M2

GJELBERIM I LARTE - PEME

GJELBERIM I ULET - SHKURRE

GJELBERIM I ULET - BAR

SHTRIM ME GURALEC

SHTRIM ME PLLAKE BETONI

SHTRIM ME MATERIAL GOMINE

STOLA

FUSHE SPORTIVE

LOJRA FEMIJESH

HYRJE NE OBJEKT

HYRJE NE PARCELE

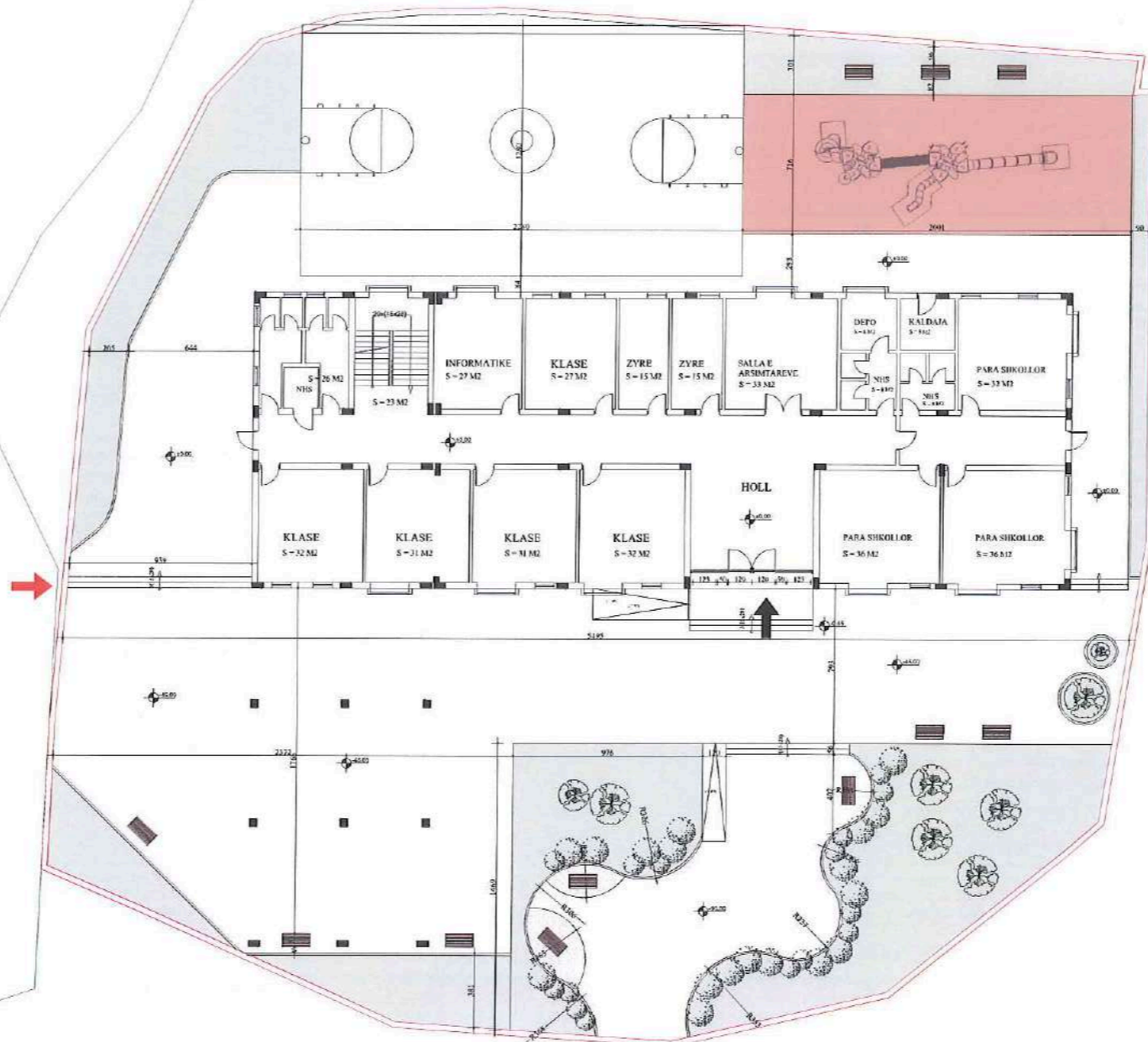
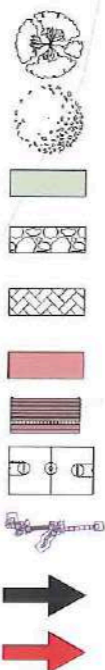

OBJEKTI	RINDERTIMI I SHKOLLES 9-VJECARE "HYSEN XHEKA"	NR.FLETES	A-07
VENDNDODHJA	KARBUNARE	FORMATI	420X297
EMERT. I FLETES	PLANSISTEMIN	SHKALLA	1:300
DREJTOR	ING. MIMOZA HAXHIU		
PERGJEGJES	ARK. SAJMIR MEBELLI		
SPECIALIST	ARK. OKSANA BAXHO		
SPECIALIST	ORJALD DEBINJA		
SPECIALIST	ING. ARTUR SINANI		
SPECIALIST	ING. ARBEN MUCA		
SPECIALIST	ING. MALDIN CELA		
SPECIALIST	ING. KLAJDI MYZEQARI		



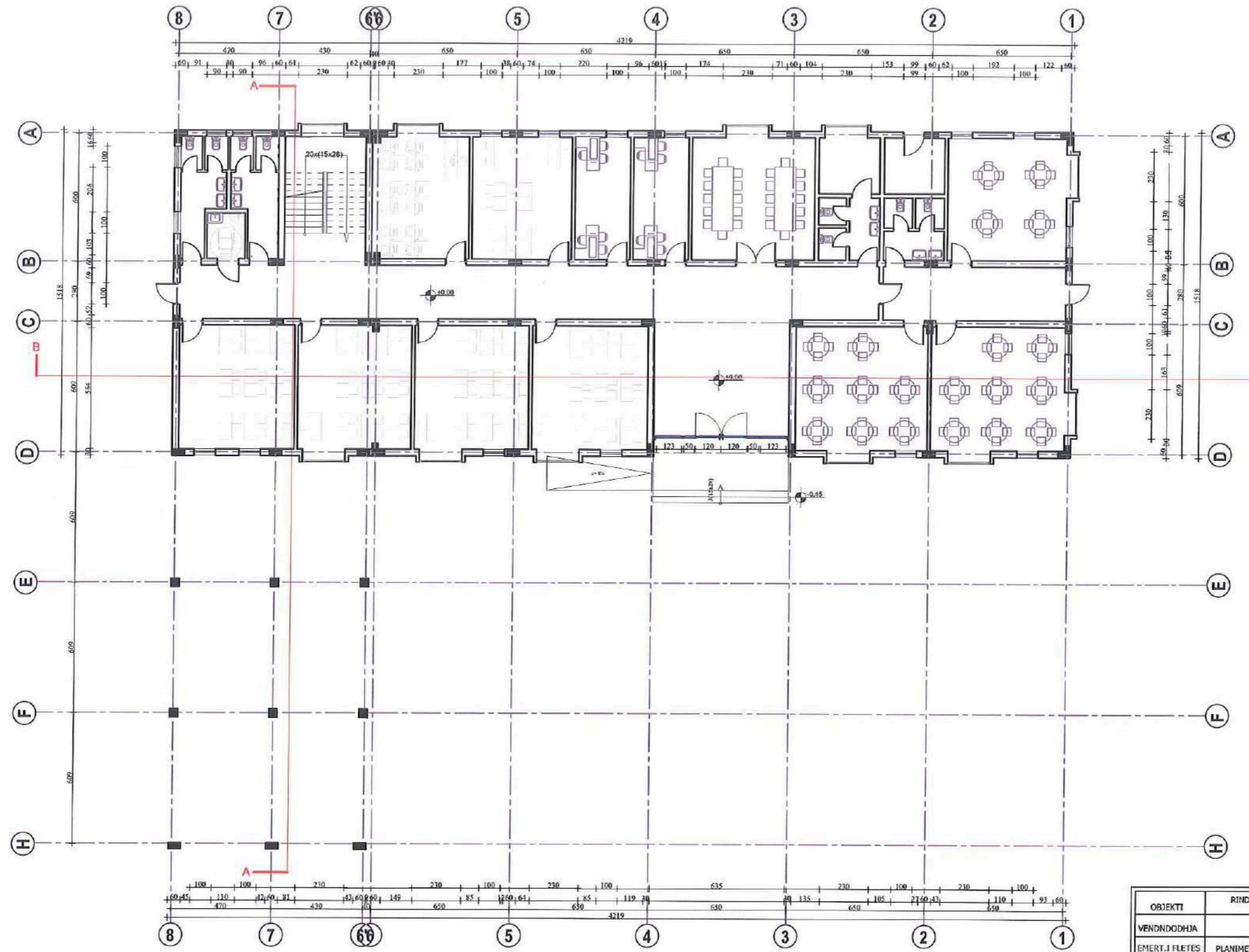
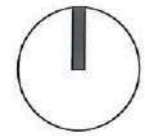

OBJEKTI	RINDERTIMI I SHKOLLËS 9-VJECARE "HYSEN XHEKA"	NR.FLETES	A-08
VENDNDODHJA	KARBUNARE	FORMATI	420x297
		SHKALLA	1:200
EMERT.I FLETES	PLANIMETRIA E KATIT PERDHE		
DREJTOR	ING. MIMOZA HAXHITU		
PERGJEGJES	ARK. SAHIR MEBELLI		
SPECIALIST	ARK. OKSANA BAXHO		
SPECIALIST	ORJALD DEBINIA		
SPECIALIST	ING. ARTUR SINANI		
SPECIALIST	ING. ARBEN MUCA		
SPECIALIST	ING. MALDIN CELA		
SPECIALIST	ING. KLAJDI MYZEQARI		



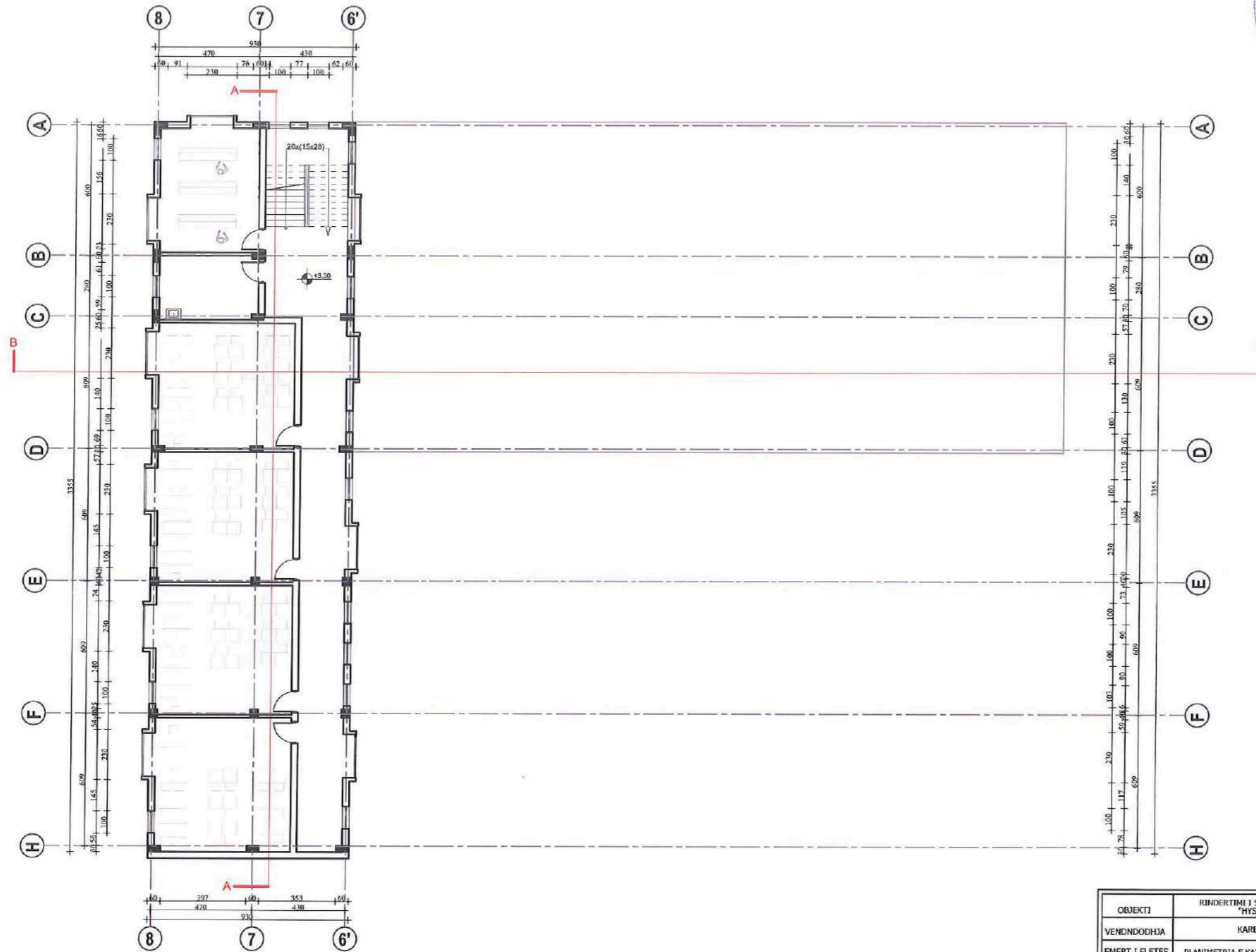
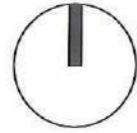

OBJEKTI	RINDERTIMI I SHKOLLES 9-VJECARE "HUSEN XHEKA"	NR.FLETES	A-09
VENDNDODHJA	KARBUNARE	FORMATI	420X297
EMERT. I FLETES	PLANIMETRIA E KATTI TE PARE	SHKALLA	1:200
DREJTOR	ING. MIMOZA HAXHIU		
PERGJEGJES	ARK. SAJMIR MEBELLI		
SPECIALIST	ARK. OKSANA BAKHO		
SPECIALIST	ORJALD DEBINJA		
SPECIALIST	ING. ARTUR SINANI		
SPECIALIST	ING. ARBEN MUCA		
SPECIALIST	ING. MALDIN CELA		
SPECIALIST	ING. KLAJDI MYZEQARI		



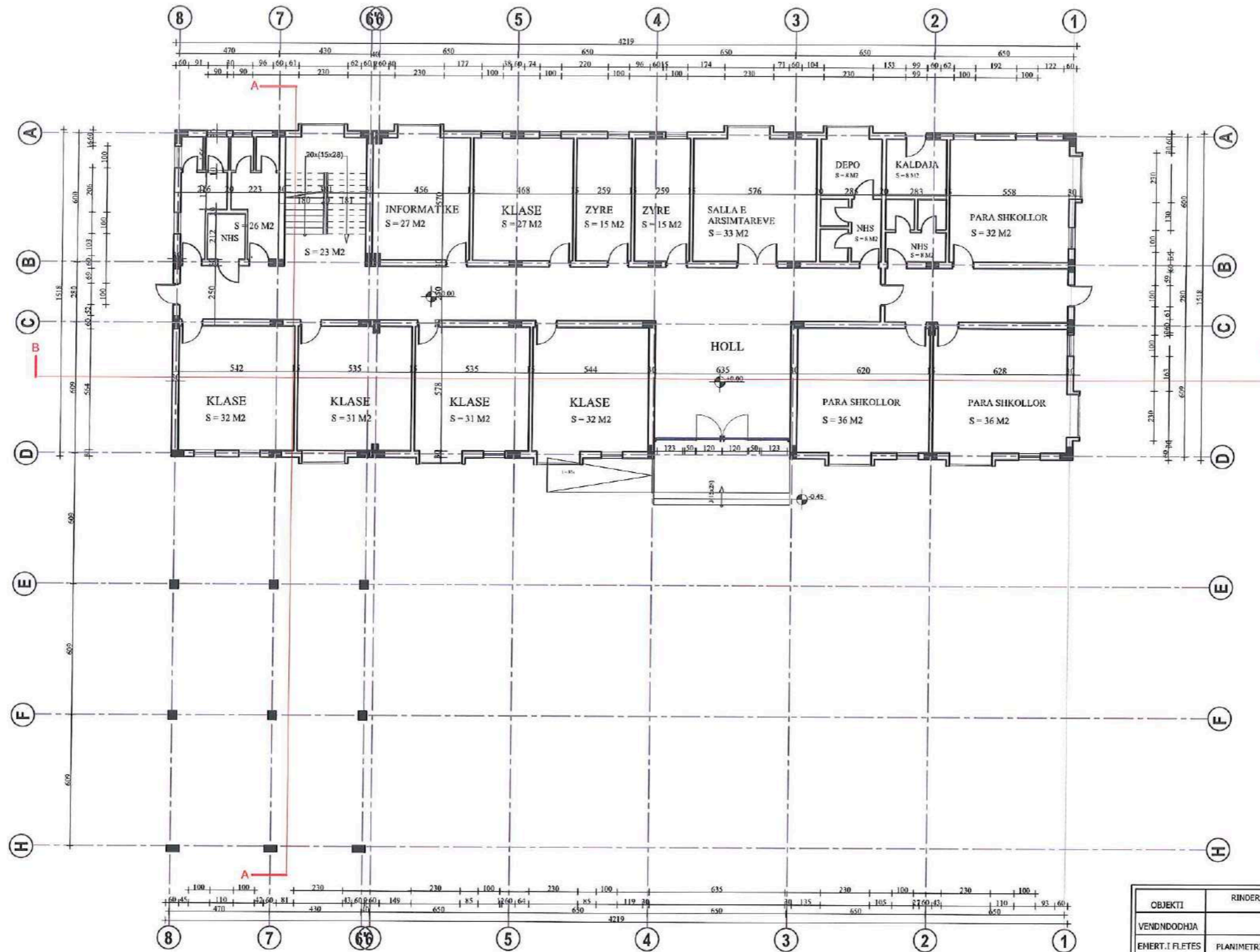
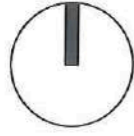

OBJEKTI	RINDERTIMI I SHKOLLES 9-VJECARE "HYSEN XHEKA"	NR.FLETES	A-10
VENDNDODHJA	KARBUNARE	FORMATI	420x297
EMERT.I FLETES	PLANIMETRIA TEKNIKE E KATIT PERDHE	SHKALLA	1:200
DREJTOR	ING. MIMOZA HAXHIU		
PERGJEGJES	ARK. SAIMIR MEBELLI		
SPECIALIST	ARK. OXSANA BAXHO		
SPECIALIST	ORJALD DEBINJA		
SPECIALIST	ING. ARTUR SINANI		
SPECIALIST	ING. ARBEN MUCA		
SPECIALIST	ING. MALDIN CELA		
SPECIALIST	ING. KLAUDI MYZEQARI		



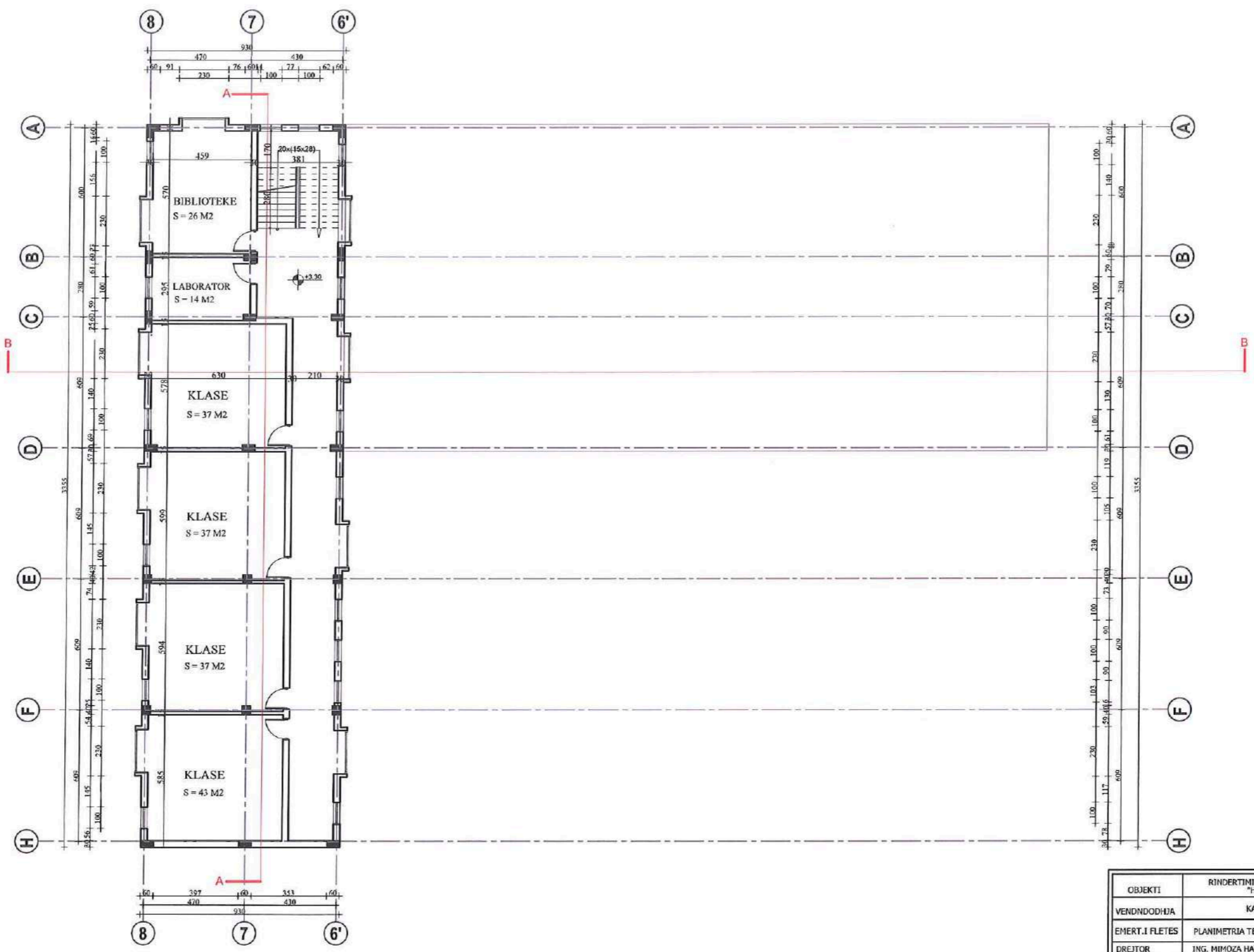

OBJEKTI	RINDERTIMI I SHKOLLËS 9-VJECARE "HYSEN XHEKA"	NR.FLETES	A-11
VENDNDODHJA	KARBUNARE	FORMATI	420X297
EMERT.I FLETES	PLANIMETRIA TEKNIKE E KATIT TE PARE	SHKALLA	1:200
DREJTOR	ING. MIMOZA HAXHIU		
PERGJEGJES	ARK. SAIMIR MEBELLI		
SPECIALIST	ARK. OKSANA BASHO		
SPECIALIST	ORJALD DEBINDA		
SPECIALIST	ING. ARTUR SIMANI		
SPECIALIST	ING. ARBEN MUCA		
SPECIALIST	ING. MALDIN CELA		
SPECIALIST	ING. KLAJDI MYZEQARI		



# PRERJE A-A

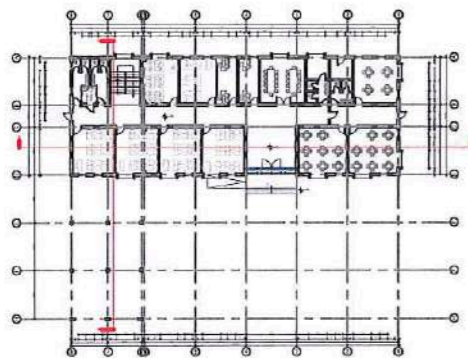
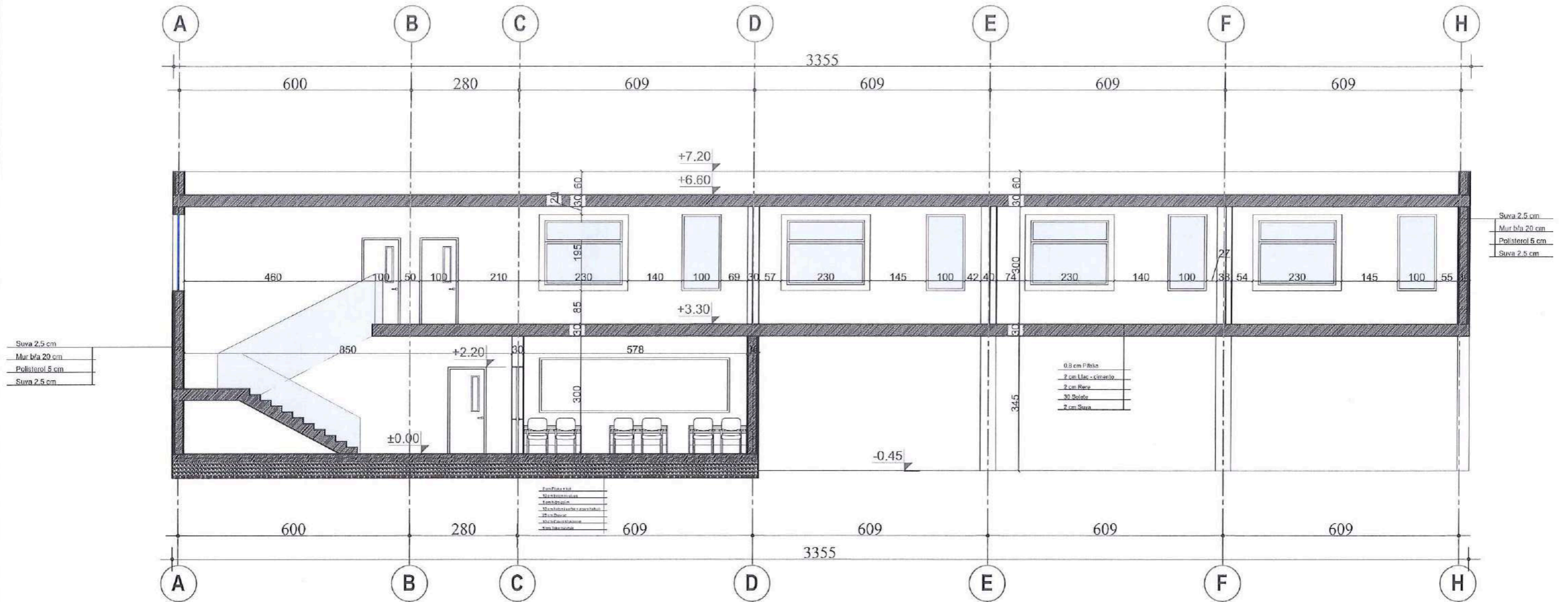

OBJEKTI	RINDERTIMI I SHKOLLËS 9-VJECARE "HYSEN XHEKA"	NR.FLETES	A-12
VENDNDODHJA	KARBUNARE	FORMATI	420X297
EMERT.I FLETES	PRERJE A-A	SHKALLA	1:100
DREJTOR	ING. MIMOZA HAXHIU	 REPUBLIKA E SHQIPËRIE BASHKIA E LUSHNJË	
PERGJEGJES	ARK. SAIMIR MEBELLI		
SPECIALIST	ARK. OKSANA BAXHO		
SPECIALIST	ORJALD DEBINJA		
SPECIALIST	ING. ARTUR SINANI		
SPECIALIST	ING. ARBEN MUCA		
SPECIALIST	ING. GANI MYZEQARI		
SPECIALIST	ING. KLAJDI MYZEQARI		



# PRERJE B-B

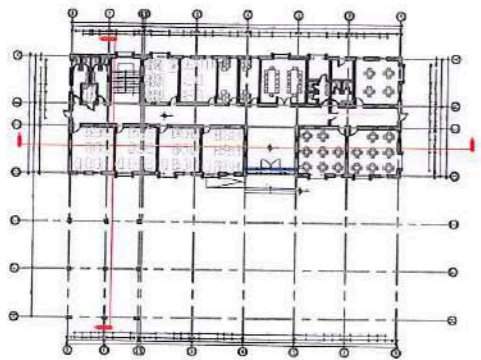
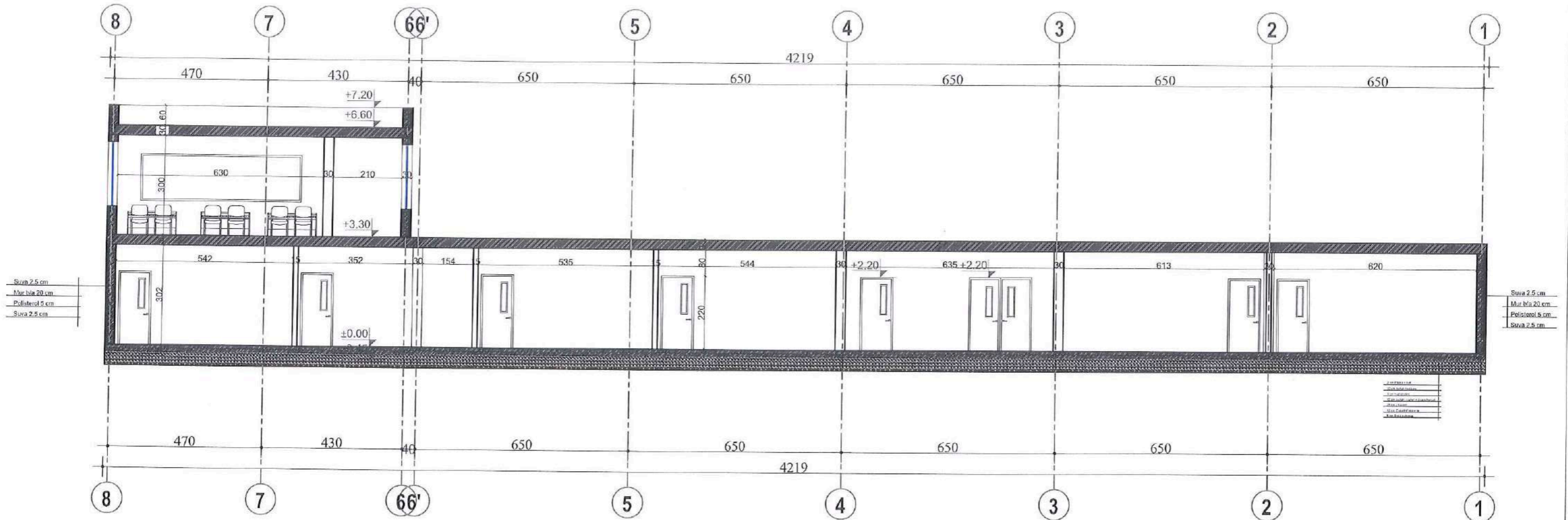

OBJEKTI	RINDERTIMI I SHKOLLES 9-VJECARE "HYSEN XHEKA"	NR.FLETES	A-13
VENDNDODHJA	KARBUNARE	FORMATI	420X297
EMERT.I FLETES	PRERJE B-B	SHKALLA	1:120
DREJTOR	ING. MIMOZA HAXHILI	 REPUBLIKA E SHQERISE BASHKIA E KARBUNARE	
PERGJEGJES	ARK. SAIMIR MEBELLI		
SPECIALIST	ARK. OKSANA BAXHO		
SPECIALIST	ORJALD DEBINJA		
SPECIALIST	ING. ARTUR SINANI		
SPECIALIST	ING. ARBEN MUCA		
SPECIALIST	ING. GANI MYZEQARI		
SPECIALIST	ING. KLAJDI MYZEQARI		



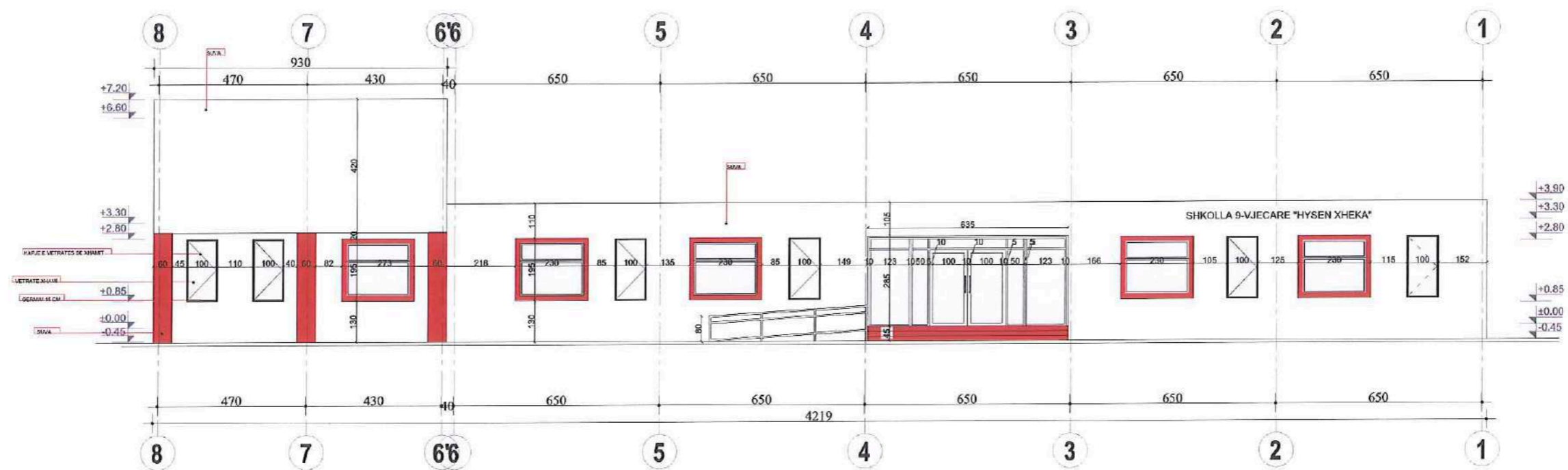

OBJEKTI	RINDERTIMI I SHKOLLËS 9-VJECARE "HYSEN XHEKA"	NR.FLETES	A-14
VENDNDODHJA	KARBUNARE	FORMATI	420X297
EMERT.I FLETES	FASADA JUGORE	SHKALLA	1:150
DREJTOR	ING. MIMOZA HAXHIU		
PERGJEGJES	ARK. SAIMIR MEBELLI		
SPECIALIST	ARK. OKSANA BAXHO		
SPECIALIST	ORJALD DEBINJA		
SPECIALIST	ING. ARTUR SINANI		
SPECIALIST	ING. ARBEN MUCA		
SPECIALIST	ING. MALDIN CELA		
SPECIALIST	ING. KLAJDI MYZEQARI		



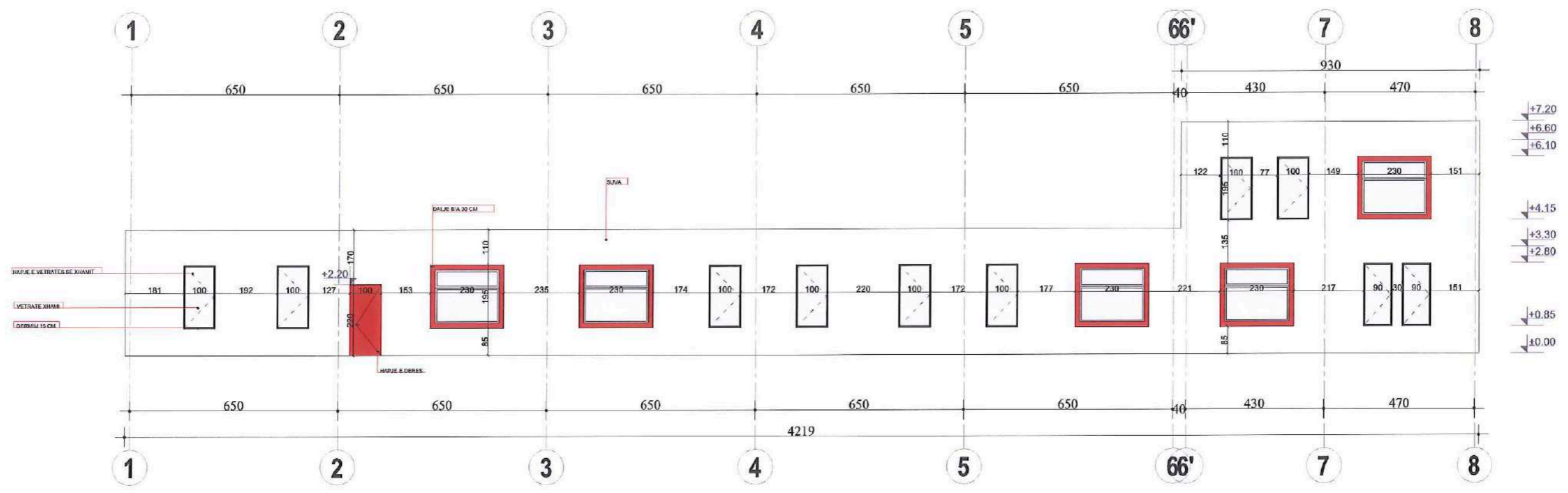

OBJEKTI	RINDERTIMI I SHKOLLËS 9-VJEÇARE "HYSEN XHEKA"	NR.FLETES	A-15
VENDNDODHJA	KARBUNARE	FORMATI	420x297
EMERT.I FLETES	FASADA VERIORE	SHKALLA	1:130
DREJTOR	ING. MIMOZA HAXHIU		
PERGJEGJES	ARK. SAHIR MEBELLI		
SPECIALIST	ARK. OKSANA BAXHO		
SPECIALIST	ORJALD DEBINJA		
SPECIALIST	ING. ARTUR SIMANI		
SPECIALIST	ING. ARDEN MUCA		
SPECIALIST	ING. MALDIN CELA		
SPECIALIST	ING. KLAJDI MYZEQARI		



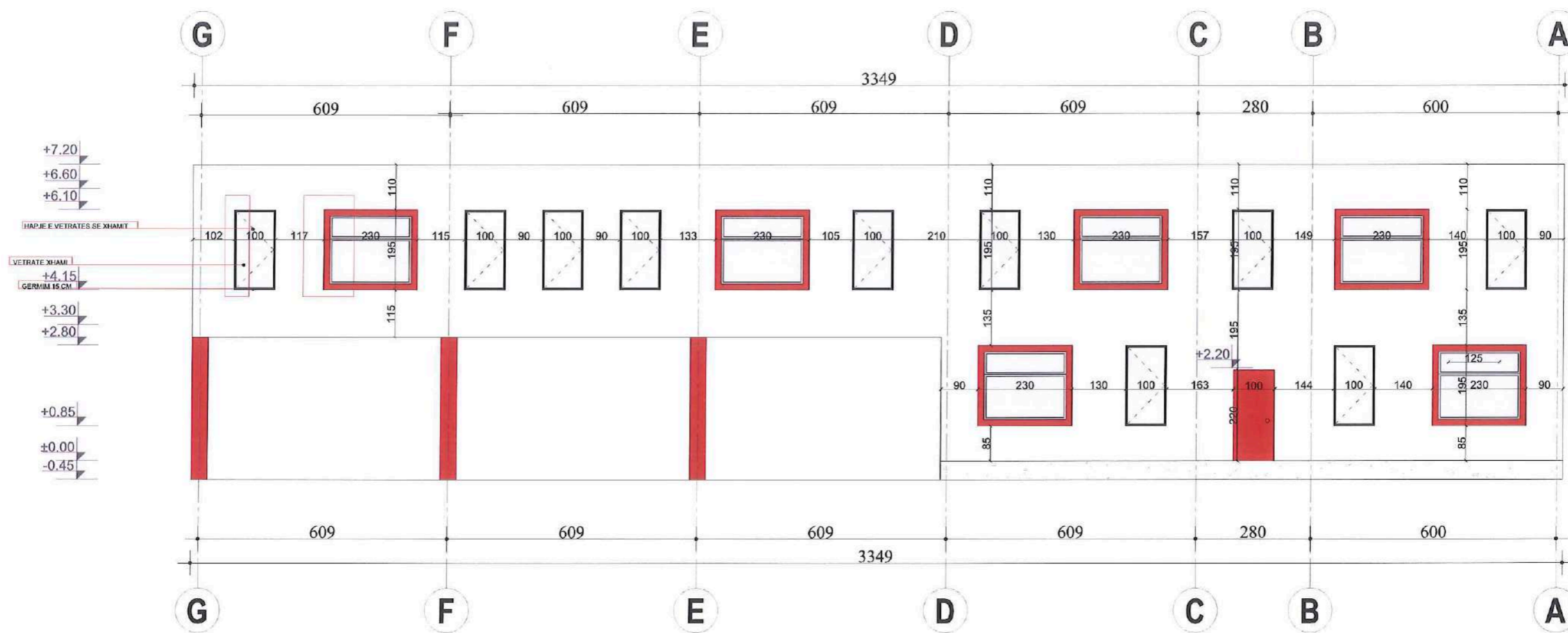

OBJEKTI	RINDERTIMI I SHKOLLËS 9-VJEÇARE "HYSEN XHEKA"	NR.FLETES	A-16
VENDNDODHJA	KARBUNARE	FORMATI	420X297
EMERT.I FLETES	FASADA LINDORE	SHKALLA	1:100
DREJTOR	ING. MIMOZA HAXHIU		
PERGJEGJES	ARK. SAIMIR MEBELLI		
SPECIALIST	ARK. OKSANA BAXHO		
SPECIALIST	ORJALD DEBINJA		
SPECIALIST	ING. ARTUR SINANI		
SPECIALIST	ING. ARBEN MUCA		
SPECIALIST	ING. MALDIN CELA		
SPECIALIST	ING. KLAUDI MYZEQARI		



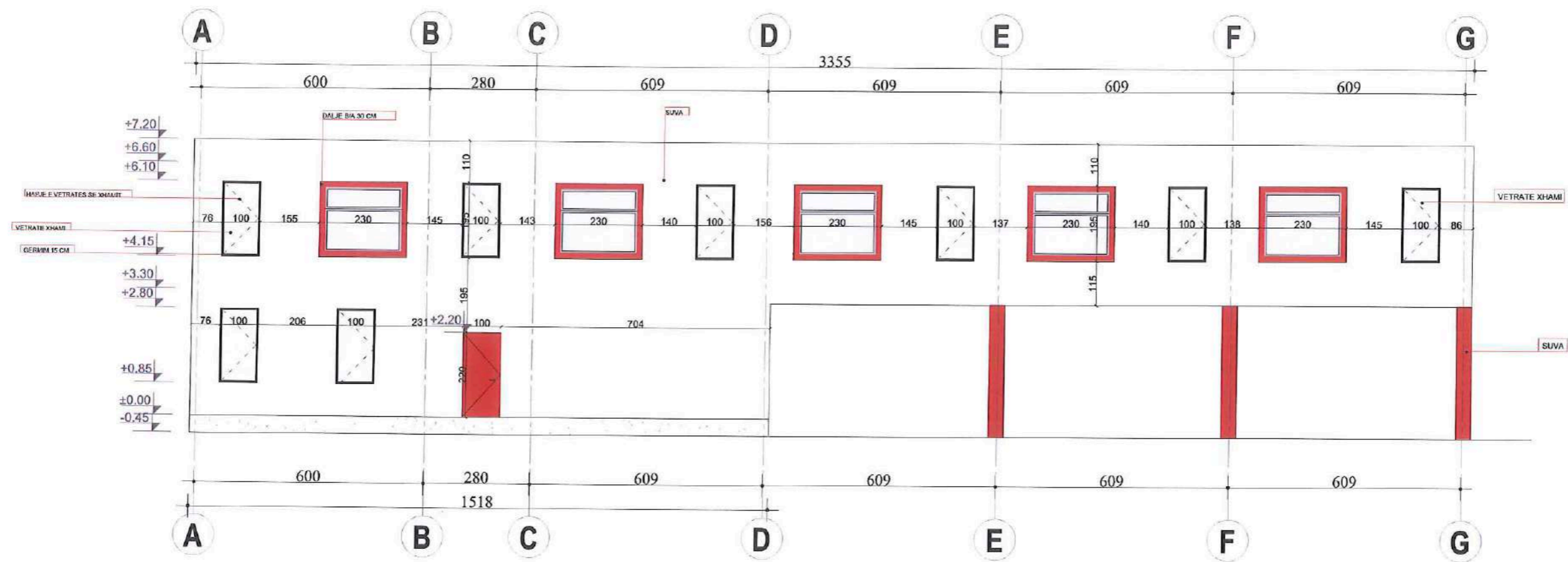

OBJEKTI	RINDERTIMI I SHKOLLES 9-VJEÇARE "HYSEN XHEKA"	NR.FLETES	A-18
VENDNDODHJA	KARBUNARE	FORMATI	420X297
EMERT.I FLETES	FASADA PERENDIMORE	SHKALLA	1:120
DIREKTOR	ING. MIMOZA HAXHILU		
PERGJEGJES	ARK. SAIMIR MEBELLI		
SPECIALIST	ARK. OKSANA BAXHO		
SPECIALIST	ORJALD DEBINA		
SPECIALIST	ING. ARTUR SIMANI		
SPECIALIST	ING. ARBEN MUCA		
SPECIALIST	ING. MALDIN CELA		
SPECIALIST	ING. KLAJDI MYZEQARI		



# PLANI I KATIT TE PARE

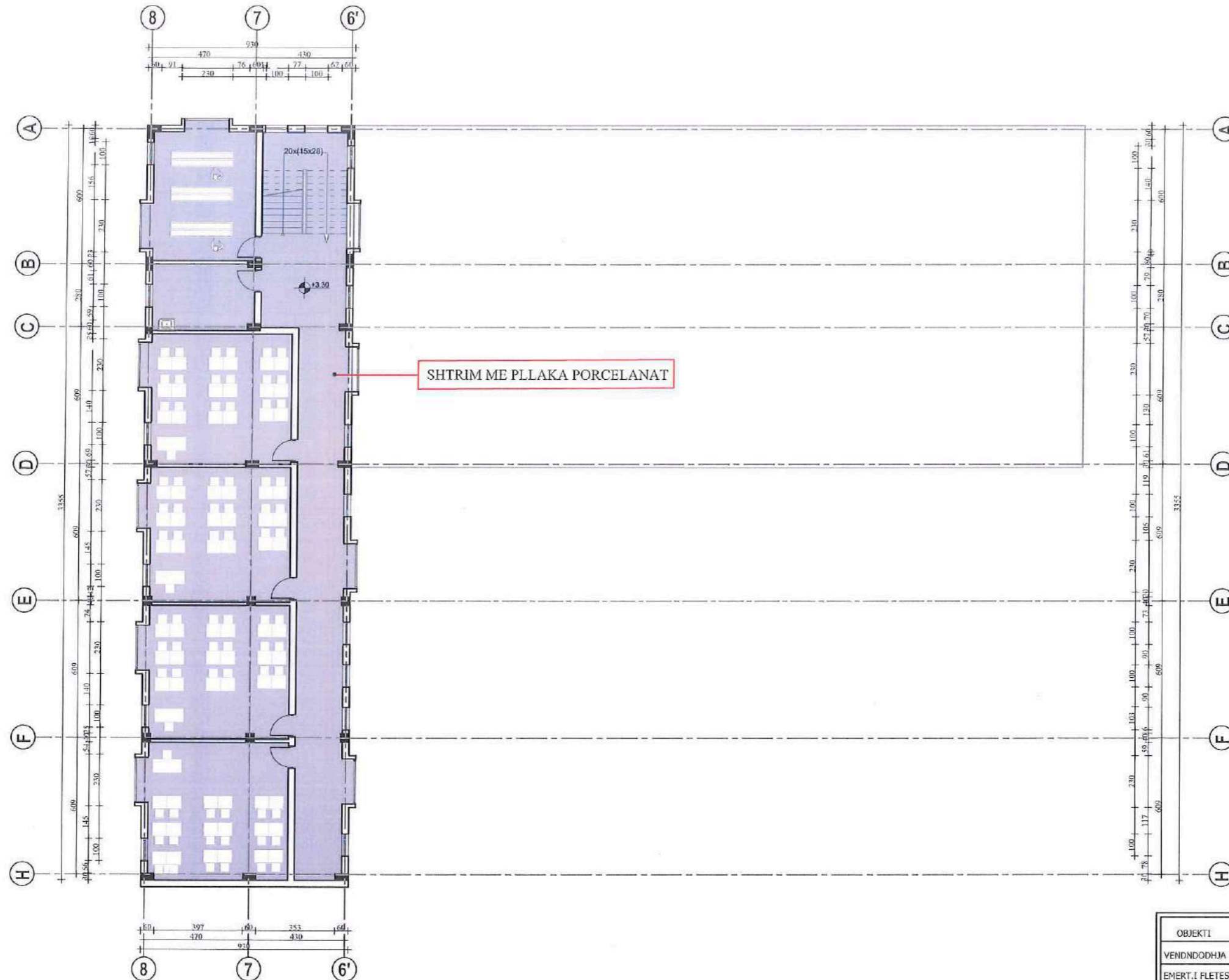

OBJEKTI	RINDERTIMI I SHKOLLES 9-VJECARE "HYSEN XHEKA"	NR.FLETES	A-01
VENDNDODHJA	KARBUNARE	FORMATI	420X297
EMERT.I FLETES	PLANI I DYSHEMISE - KATI I PARE	SHKALLA	
DREJTOR	ING. MIMOZA HAXHIU	 REPUBLIKA E SHQIPERISE BASHKIA LUSHNJE	
PERGJEGJES	ARK. SAIMIR MEBELLI		
SPECIALIST	ARK. OKSANA BAXHO		
SPECIALIST	ORJALD DEBINJA		
SPECIALIST	ING. ARTUR SINANI		
SPECIALIST	ING. ARBEN MUCA		
SPECIALIST	ING. GANI MYZEQARI		
SPECIALIST	ING. KLAJDI MYZEQARI		



# PLANI I DYSHEMESE - KATI PERDHE



OBJEKTI	RINDERTIMI I SHKOLLËS 9-VJECARE "HYSEN XHEKA"	NR.FLETES	A-01
VENDNDODHJA	KARBUNARE	FORMATI	420X297
EMERT.I FLETES	PLANI I DYSHEMESE - KATI PERDHE	SHKALLA	
DREJTOR	ING. MIMOZA HAXHIU	 REPUBLIKA E SHQIPERISE BASHKIA E LUSHNJE	
PERGJEGJES	ARK. SAHIMR MEBELLI		
SPECIALIST	ARK. OKSANA BAXHO		
SPECIALIST	ORJALD DEBINJA		
SPECIALIST	ING. ARTUR SINANI		
SPECIALIST	ING. ARBEN MUJA		
SPECIALIST	ING. GANI MYZEQARI		
SPECIALIST	ING. KLAIDI MYZEQARI		



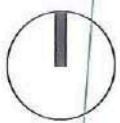

# PLANI I KULLIMIT SHKOLLA "HYSEN XHEKA" KARBUNARE



OBJEKTI	RINDERTIMI I SHKOLLES 9-VJECARE "HYSEN XHEKA"	NR.FLETES	A-01
VENDNDODHJA	KARBUNARE	FORHATI	420X297
EMERT,I FLETES	PLANI I DYSHEMESE - KATI PERDHE	SHKALLA	
DREJTOR	ING. MIMOZA HAXHIU	 REPUBLIKA E SHQIPERISE BASHKIA LUSHDE	
PERGJEGJES	ARK. SAIMIR MEBELLI		
SPECIALIST	ARK. OKSANA BAXHO		
SPECIALIST	ORJALD DEBINJA		
SPECIALIST	ING. ARTUR SINANI		
SPECIALIST	ING. ARBEN MUCA		
SPECIALIST	ING. GANI MYZEQARI		
SPECIALIST	ING. KLAJDI MYZEQARI		





OBJEKTI	RINDERTIMI I SHKOLLES 9-VJECARE "HYSEN XHEKA"	NR.FLETES	A-27
VENDNDODHJA	KARBUNARE	FORMATI	420X297
EMERT.I FLETES	PAMJE 3D	SHKALLA	
DREJTOR	ING. MIMOZA HAXHIU		
PERGJEGJES	ARK. SAJMIR MEBELLI		
SPECIALIST	ARK. OKSANA BASHO		
SPECIALIST	ORJALD DEBINJA		
SPECIALIST	ING. ARTUR SINANI		
SPECIALIST	ING. ARBEN HUCA		
SPECIALIST	ING. MALDIN CELA		
SPECIALIST	ING. KLAJDI MYZEQARI		





# PLANI I PIKETIMIT , SHKOLLA "HYSEN XHEKA" KARBUNARE

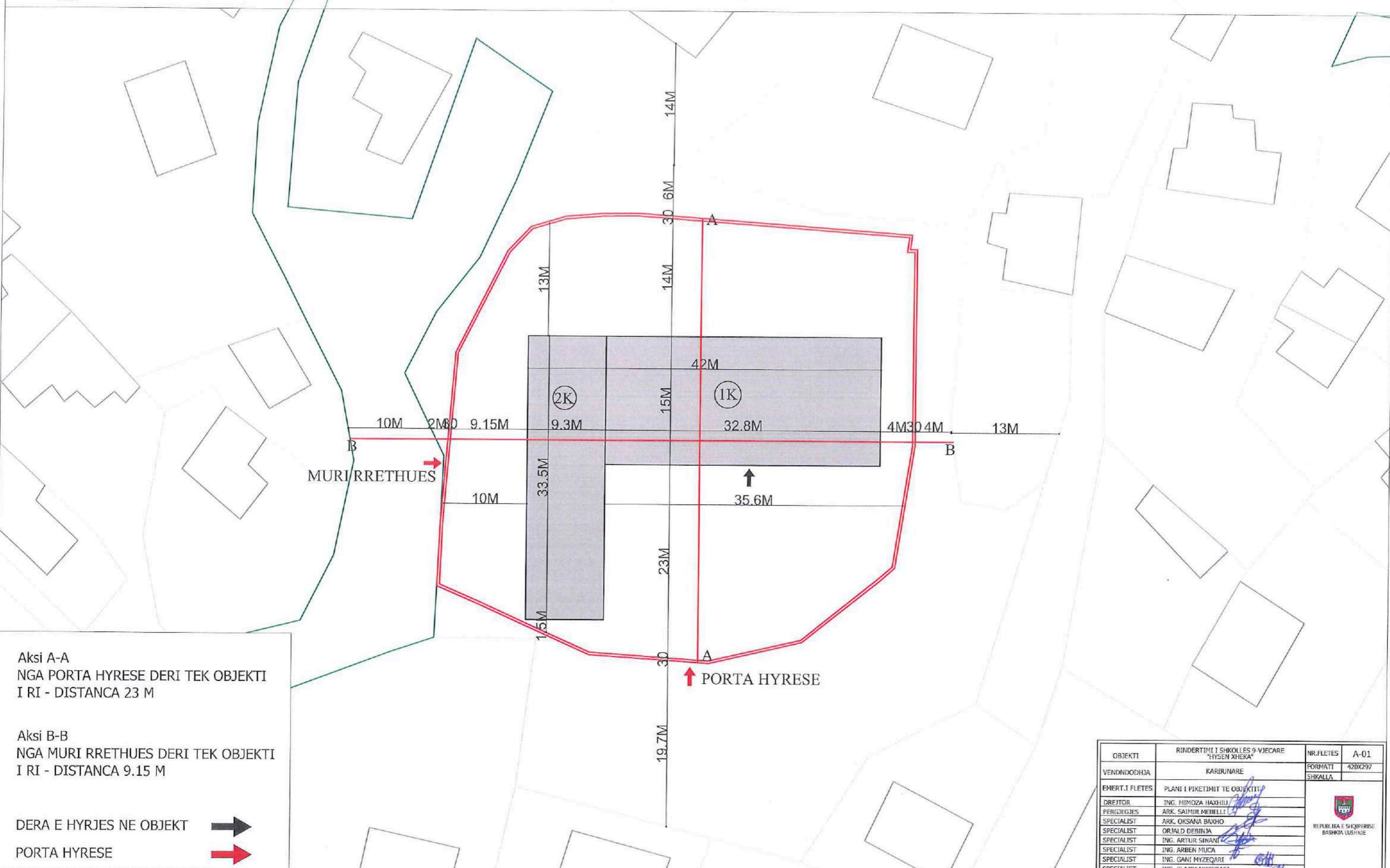

Aksi A-A  
NGA PORTA HYRESE DERI TEK OBJEKTI  
I RI - DISTANCA 23 M

Aksi B-B  
NGA MURI RRETHUES DERI TEK OBJEKTI  
I RI - DISTANCA 9.15 M

DERA E HYRJES NE OBJEKT →  
PORTA HYRESE →

OBJEKTI	RINDERTIMI I SHKOLLES 9-VJECARE "HYSEN XHEKA"	NR.FLETES	A-01
VENDNDODHJA	KARBUNARE	FORMATI	420x297
EMERT.I FLETES	PLANI I PIKETIMIT TE OBJEKTIT	SHKALLA	
DREJTOR	ING. MIMOZA HAXHILI	 REPUBLIKA E SHQPERISE BASHKIA LUSHNE	
PERGJEGJES	ARK. SAIMIR MEBELLI		
SPECIALIST	ARK. OKSANA BAXHO		
SPECIALIST	ORJALD DEBINJA		
SPECIALIST	ING. ARTUR SINANI		
SPECIALIST	ING. ARBEN MUCA		
SPECIALIST	ING. GANI MYZEQARI		
SPECIALIST	ING. KLAJDI MYZEQARI		



## ZONIM FUNKSIONAL - KATI PERDHE

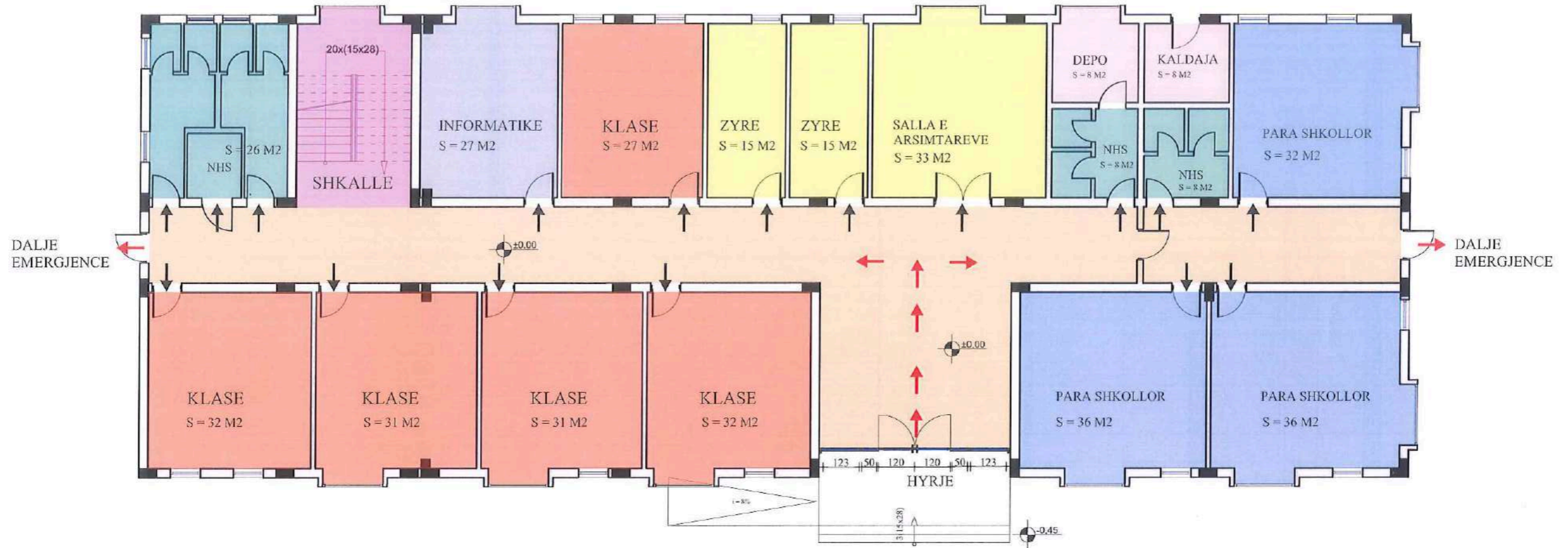

### LEGJENDE

- KORIDOR SHPERNDARES
- KLASE 9-VJECARE
- PARA-SHKOLLOR
- NYJE HIGJENOSANITARE
- SHKALLE
- DEPO
- ZYRA/SALLE ARSIMITAREVE
- LAB. INFORMATIKE

OBJEKTI	RINDERTIMI I SHKOLLËS 9-VJECARE "HYSEN XHEKA"	NR. FLETES	A-01
VENDNDODHJA	KARBUNARE	FORMATI	420X297
EMERT. I FLETES	ZONIM FUNKSIONAL - KATI PERDHE	SHKALLA	
DREJTOR	ING. MIMOZA HAXHIU		
PERGJEGJES	ARK. SAIMIR MEBELLI		
SPECIALIST	ARK. OKSANA BAXHO		
SPECIALIST	ORJALD DEBINJA		
SPECIALIST	ING. ARTUR SINANI		
SPECIALIST	ING. ARBEN MUCA		
SPECIALIST	ING. GANI MYZEQARI		
SPECIALIST	ING. KLADI MYZEQARI		



# ZONIM FUNKSIONAL - KATI I PARE

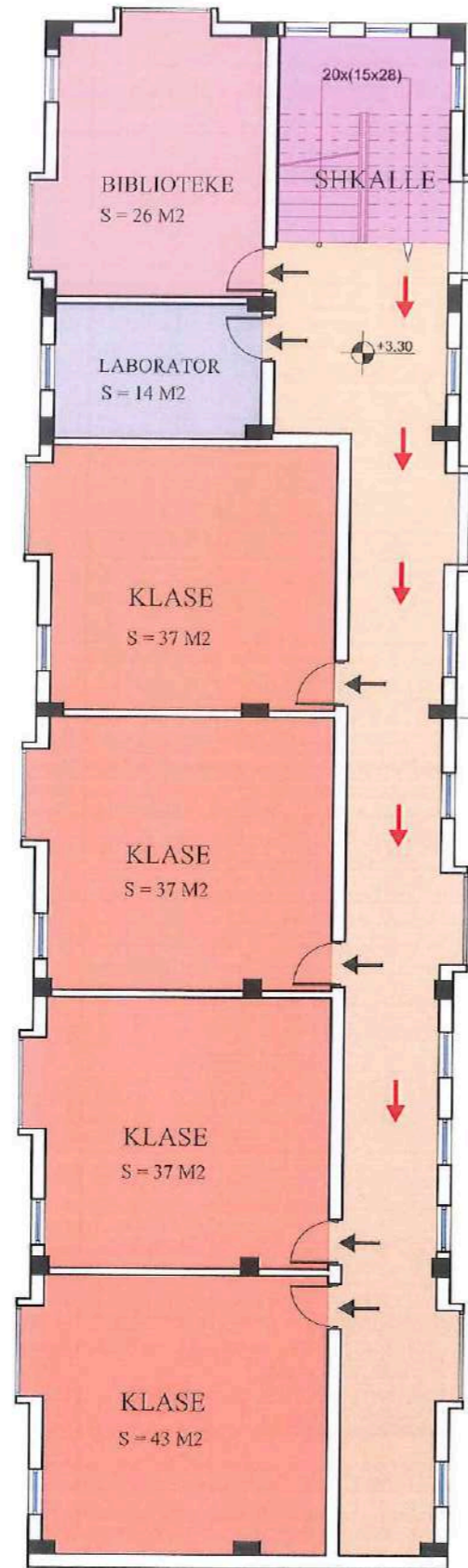

## LEGJENDE

- KORIDOR SHPERNDARES
- KLASE 9-VJECARE
- LABORATOR KIMI-FIZIKE
- BIBLIOTEKE
- SHKALLE

OBJEKTI	RINDERTIMI I SHKOLLES 9-VJECARE "HYSEN XHEKA"	NR.FLETES	A-01
VENDNDODHJA	KARBUNARE	FORMATI	420X297
EMERT.I FLETES	ZONIM FUNKSIONAL - KATI I PARE	SHKALLA	
DREJTOR	ING. MIMOZA HAXHIU	 REPUBLIKA E SHQIPERISE BASHKIA LUSHNJE	
PERGJEGJES	ARK. SAIMIR MEBELLI		
SPECIALIST	ARK. OKSANA BAXHO		
SPECIALIST	ORJALD DEBINJA		
SPECIALIST	ING. ARTUR SINANI		
SPECIALIST	ING. ARSEN MUCA		
SPECIALIST	ING. GANI MYZEQARI		
SPECIALIST	ING. KLAJDI MYZEQARI		





OBJEKTI	RINDERTIMI I SHKOLLES 9-VJECARE 'HYSEN XHEKA'	NR.FLETES	A-28
VENDNDODHJA	KARBUNARE	FORMATI	420X297
EMERT.I FLETES	PAMJE 3D	SHKALLA	
DREJTOR	ING. MIMOZA HAXHIU		
PERGJEGJES	ARK. SAJMIR MEBELLI		
SPECIALIST	ARK. OKSANA BAXHO		
SPECIALIST	ORJALD DEBINJA		
SPECIALIST	ING. ARTUR SINANI		
SPECIALIST	ING. ARBEN MUCA		
SPECIALIST	ING. MALDIN CELA		
SPECIALIST	ING. KLAJDI MYZEQARI		





OBJEKTI	RINDERTIMI I SHKOLLES 9-VJECARE "HYSEN XHIEKA"	NR.FLETES	A-29
VENDNDODHJA	KARBUNARE	FORMATI	420X297
EMERT.I FLETES	PAMJE 3D	SHKALLA	
DREJTOR	ING. MIMOZA HAXHIU	      	 REPUBLIKA E SHQIPERISE BASHKIA E KARBUENARE
PERGJEGJES	ARK. OKSANA BAXHO		
SPECIALIST	ORJALD DEBINJA		
SPECIALIST	ING. ARTUR SINANI		
SPECIALIST	ING. ARBEN MUCA		
SPECIALIST	ING. MALDIN CELA		
SPECIALIST	ING. KLAUDI MYZEQARI		



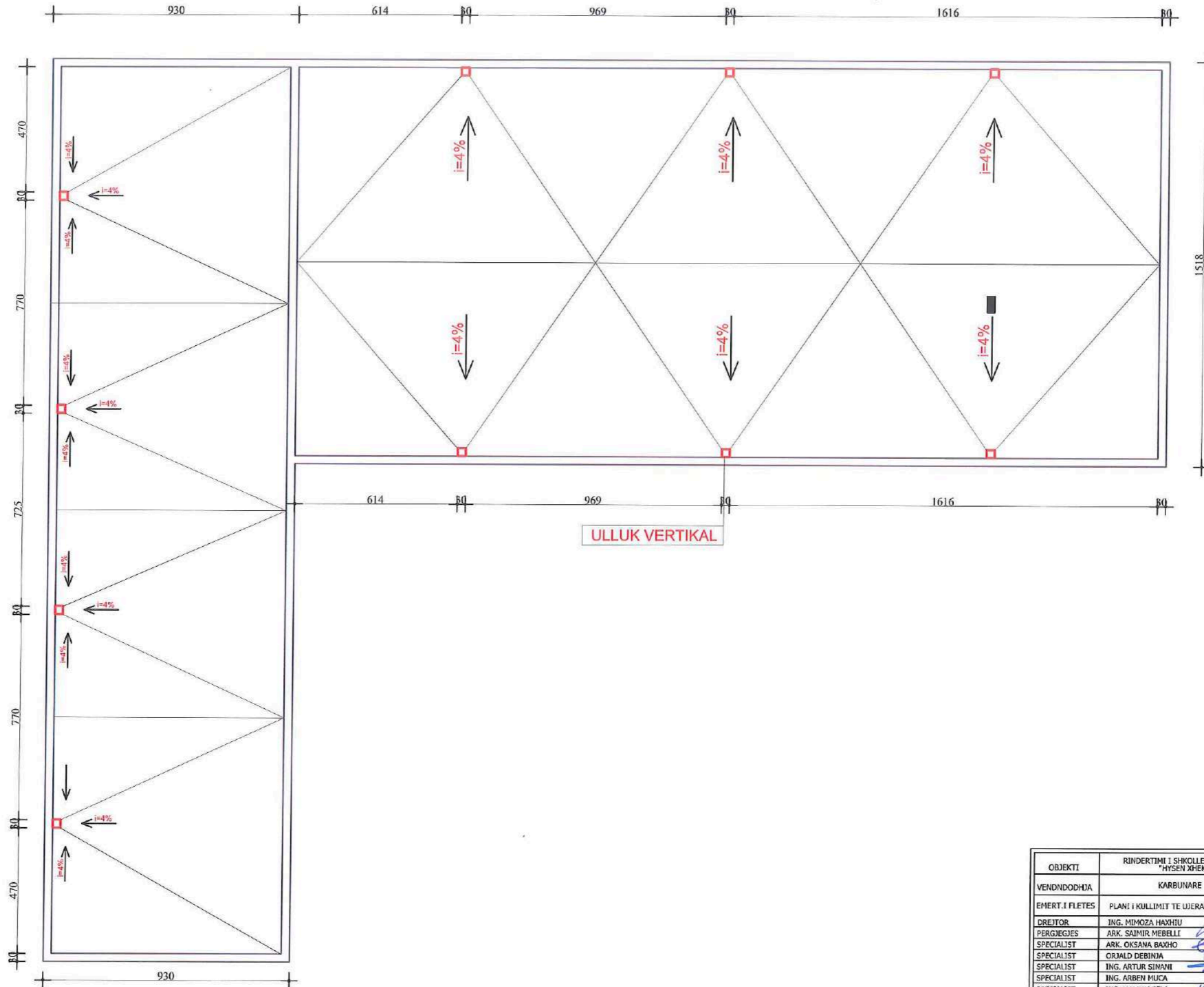

OBJEKTI	RINDERTIMI I SHKOLLES 9-VJECARE "HYSEN XHEKA"	NR.FLETES	A-01
VENDNDODHJA	KARBUNARE	FORMATI	420X297
EMERT.I FLETES	PLANI I KULLIMIT TE UJERAVE	SHKALLA	
DREJTOR	ING. MIMOZA HAXHIU		
PERGJEGJES	ARK. SAJMIR MEBELLI		
SPECIALIST	ARK. OKSANA BAXHO		
SPECIALIST	ORJALD DEBINJA		
SPECIALIST	ING. ARTUR SINANI		
SPECIALIST	ING. ARBEN MUCA		
SPECIALIST	ING. MALDIN CELA		
SPECIALIST	ING. KLAJDI MYZEQARI		



DETAJ I MURATURES SH - 1:12

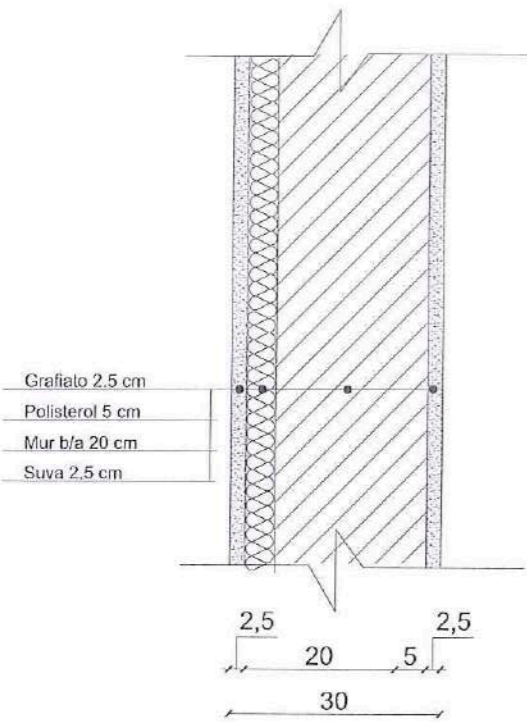

DETAJ I MURATURES + SOLETE - 1:12

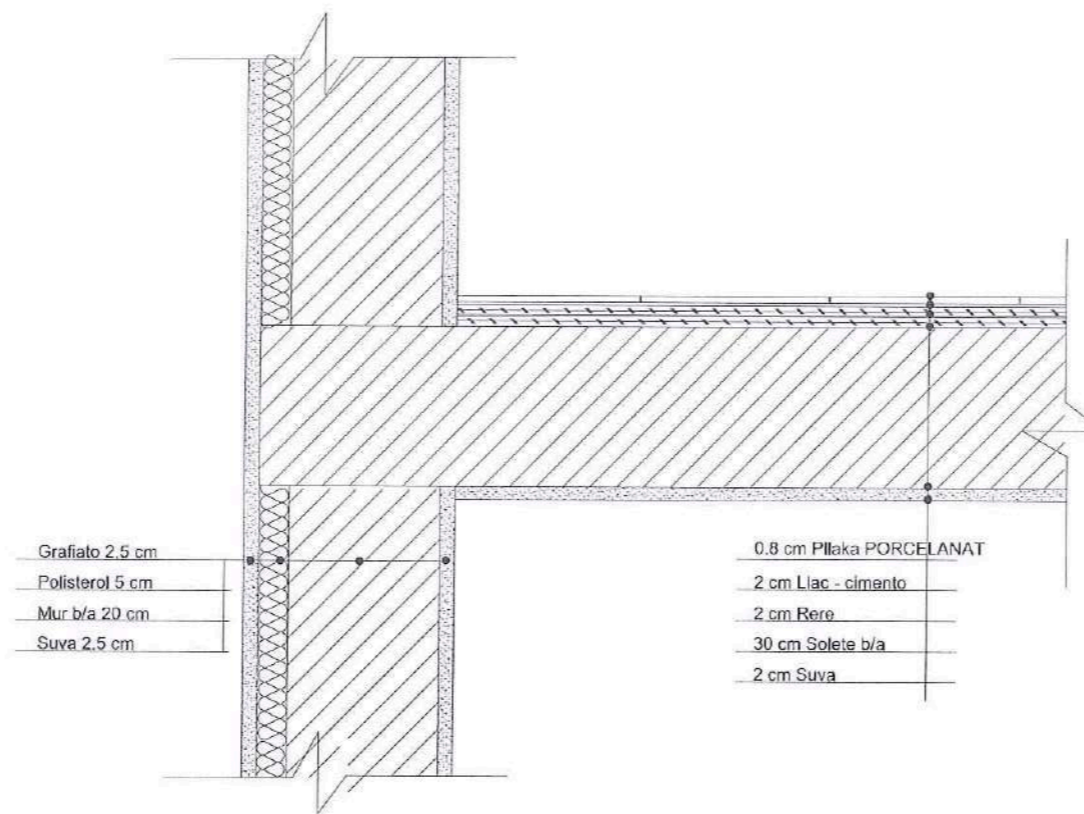

DETAJ I MURATURES + DRITARE - 1:12

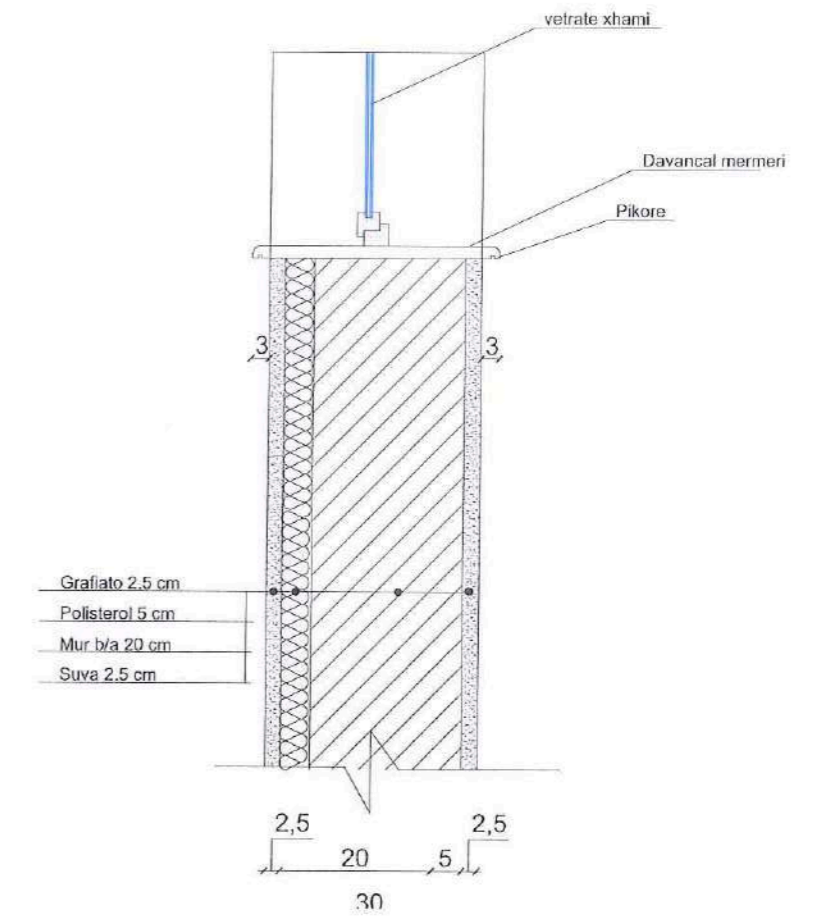

DETAJ I SOLETES NDERKAT

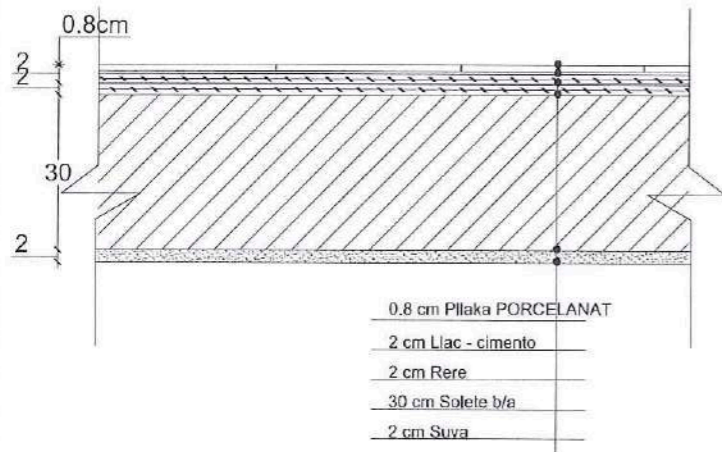

DETAJ I SOLETES KUOTA 0.00

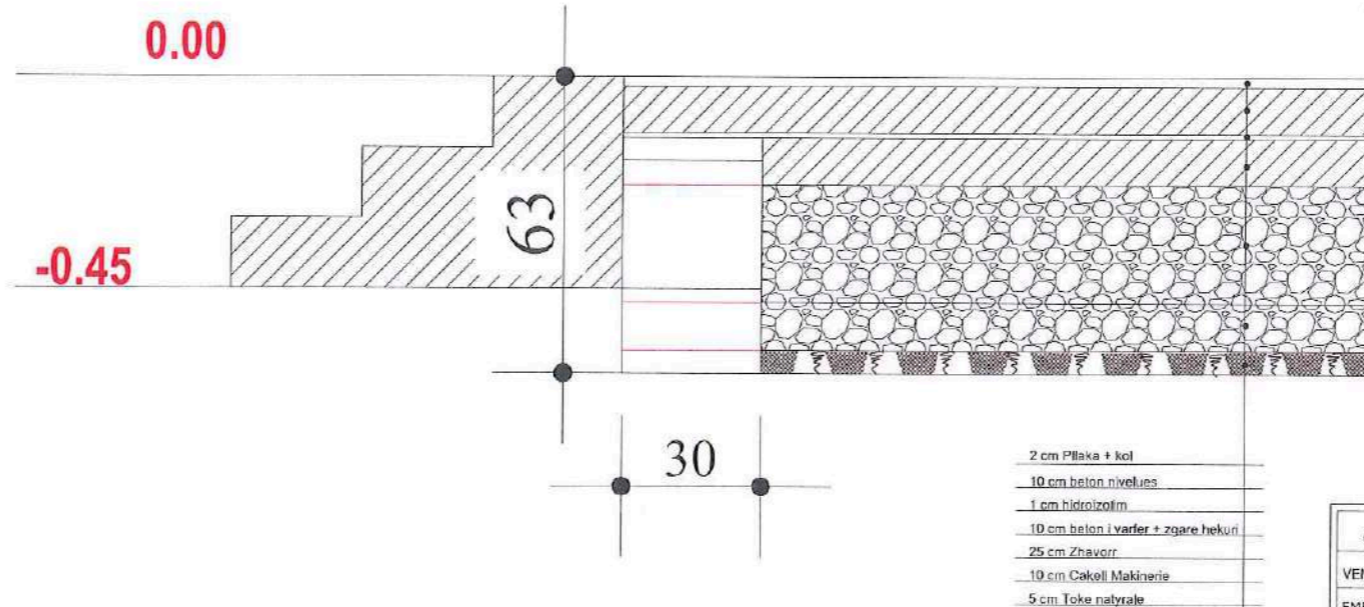

DETAJ I TAVANIT SH - 1:10

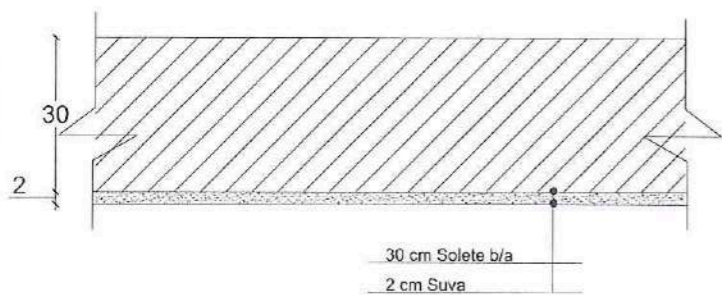

OBJEKTI	RINDERTIMI I SHKOLLES 9-VJECARE "HYSEN XHEKA"	NR. FLETES	A-01
VENDNDODHJA	KARBUNARE	FORMATI	420X297
EMERT.I FLETES	DETAJE TE SOLETES	SHKALLA	
DREJTOR	ING. MIHOZA HAXHIU		
PERGJEGJES	ARK. SAIMIR MEBELLI		
SPECIALIST	ARK. OKSANA BAXHO		
SPECIALIST	ORJALD DEBINJA		
SPECIALIST	ING. ARTUR SIMI		
SPECIALIST	ING. ARBEN MUCA		
SPECIALIST	ING. GANI MYZEQARI		
SPECIALIST	ING. KLADIT MYZEQARI		

REPUBLIKA E SHQIPERISE  
BASHKIA E LUSHNJE



PAMJE E DRITARES

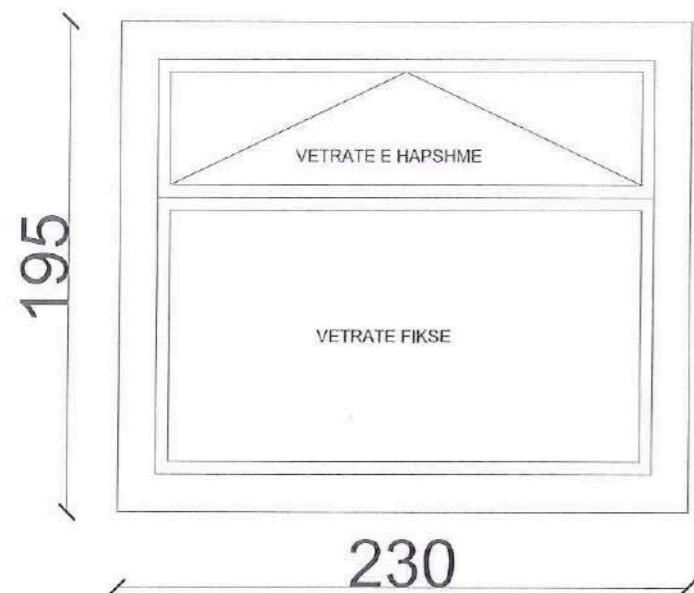

PRERJE E DRITARES



PAMJE E DRITARES



PRERJE E DRITARES

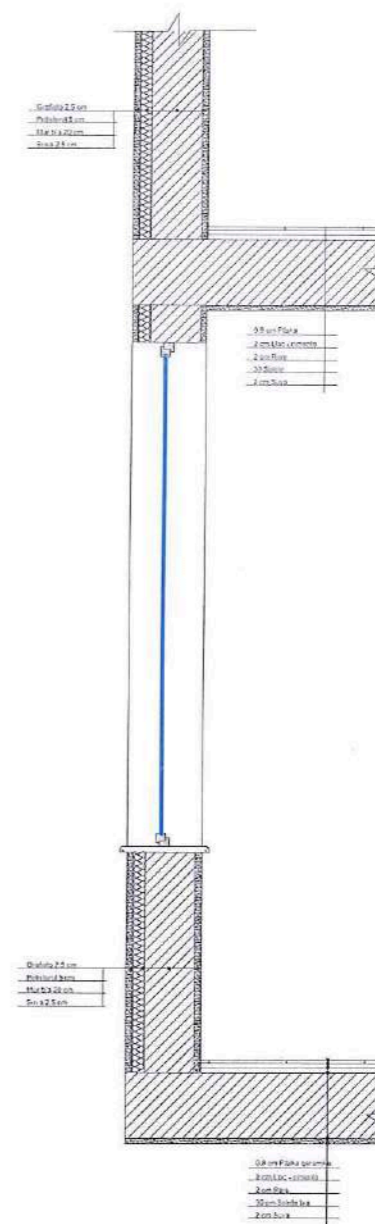

PLAN I DRITARES

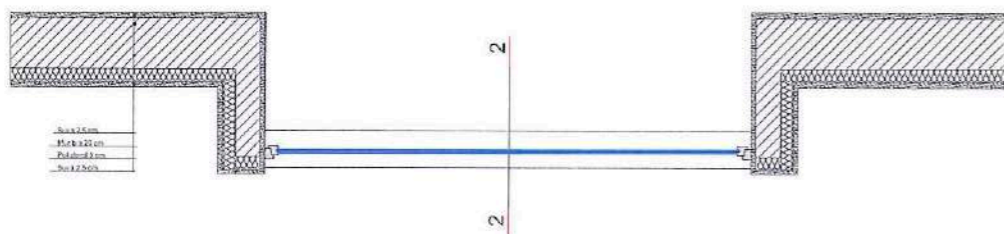

PLAN I DRITARES

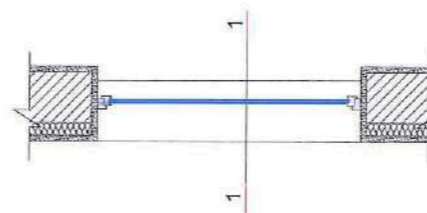

PRERJE E DERES

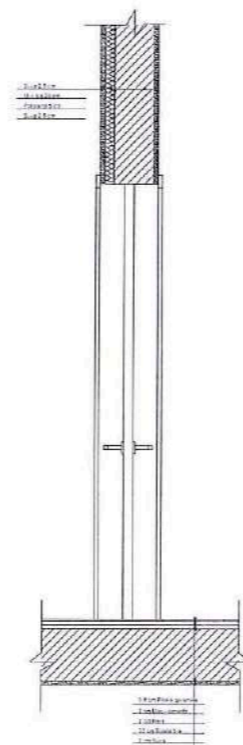

PAMJE E DERES

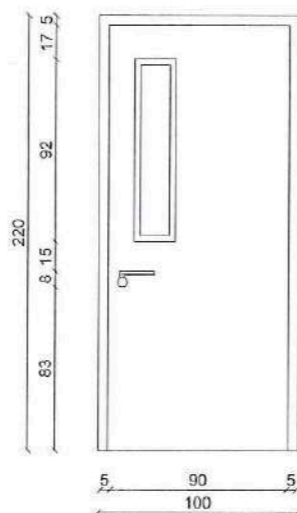

PLAN I DERES

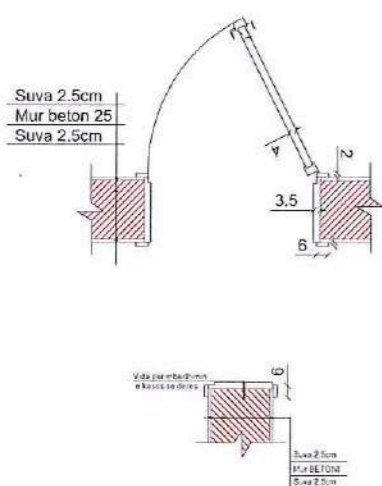

OBJEKTI	RINDERTIMI I SHKOLLES 9-VJECARE "HYSEN XHEKA"	NR.FLETES	A-01
VENDNDODHJA	KARBUNARE	FORMATI	420X297
EMERT.I FLETES	DETAJE TE DRITAREVE DHE DYRIVE	SHKALLA	
DREJTOR	ING. MIMOZA HAXHIU	 REPUBLIKA E SHQIPERISE BASHKIA E LUSHNJE	
PERGJEGJES	ARK. SAIMIR MEBELLI		
SPECIALIST	ARK. OKSANA BAXHO		
SPECIALIST	ORJALD DEBINJA		
SPECIALIST	ING. ARTUR SIMONI		
SPECIALIST	ING. ARBEN MUCA		
SPECIALIST	ING. GANI MYZEQARI		
SPECIALIST	ING. KLAJDI MYZEQARI		





# DETAJ I ARMIMIT TRAREVE KATIT PERDHE

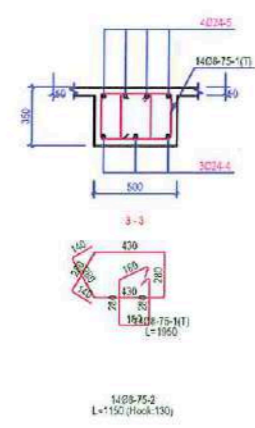
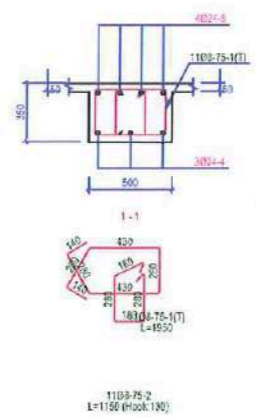
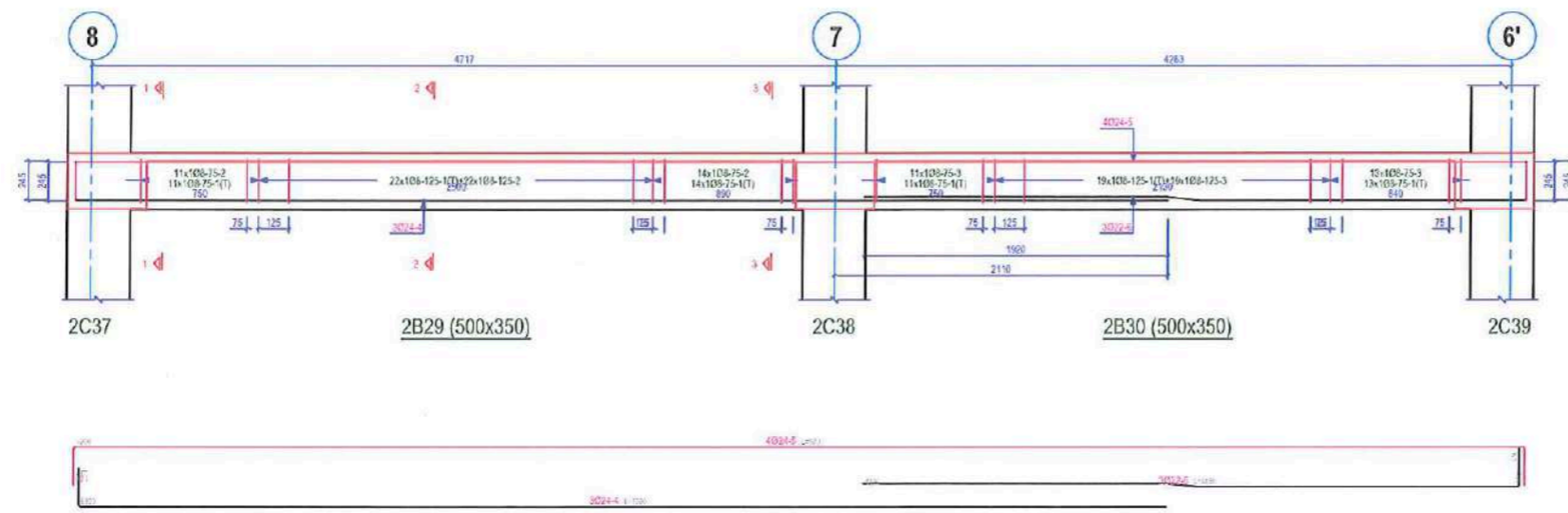

Quantity Table							
NO	SIZE	QUA	LENGTH (mm)	FORM	TOTAL LENGTH (m)		
					Q8	Q22	Q24
1	8	90	1950		175.50		
2	8	47	1150		54.65		
3	8	43	800		34.40		
4	24	3	7200				21.60
5	24	4	6700				26.80
6	22	3	4450			13.35	
TOTAL LENGTH (m)					263.95	13.35	60.40
UNIT WEIGHT (Kg/m)					0.40	2.99	3.52
WEIGHT (Kg)					104.3	39.9	214.8
T.WEIGHT (Kg)					359.0		

BEAM ELEVATIONS1

Scale: 1/120

OBJEKTI	RINDERTIMI I SHKOLLËS 9-VJEÇARE "HYSEN XHEKA"	NR.FLETES	A-05
VENDNDODHJA	KARBUNARE	FORMATI	420X297
EMERT.I FLETES	DETAJ I ARMIMIT TE TRAREVE KATI PERDHE	SHKALLA	1:500
DREJTOR	ING. MIMOZA HAXHIU		
PERGJEGJES	ARK. SAIMIR MEBELLI		
SPECIALIST	ARK. OKSANA BAXHO		
SPECIALIST	ORJALD DEGINJA		
SPECIALIST	ING. ARTUR SINANI		
SPECIALIST	ING. ARBEN MUCA		
SPECIALIST	ING. MALDIN CELA		
SPECIALIST	ING. KLAJDI MYZEQARI		





# DETAJ I ARMIMIT TRAREVE KATIT PERDHE

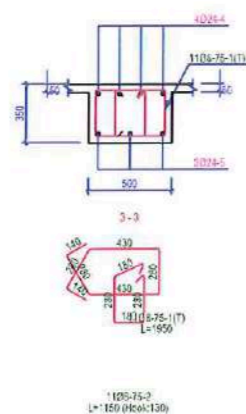
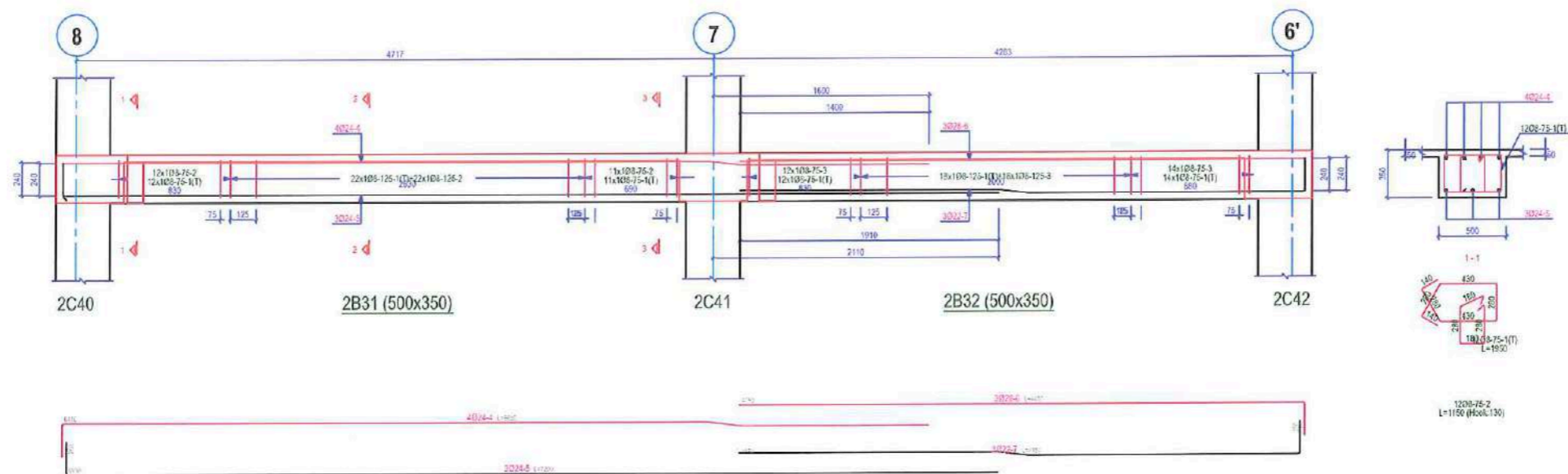

Quantity Table								
NO	SIZE	QUA	LENGTH (mm)	FORM	TOTAL LENGTH (m)			
					Ø8	Ø12	Ø14	Ø20
1	8	89	1950		173.55			
2	8	45	1150		51.75			
3	8	44	860		35.20			
4	24	4	6650				26.60	
5	24	3	7200				21.60	
6	20	3	6450					13.35
7	22	3	4450					13.35
TOTAL LENGTH (m)					260.50	13.35	48.20	13.35
UNIT WEIGHT (kg/m)					0.40	2.99	3.56	4.81
WEIGHT (kg)					102.9	39.9	171.4	64.0
T.WEIGHT (kg)					378.8			

BEAM ELEVATIONS1

Scale: 1/120

OBJEKTI	RINDERTIMI I SHKOLLES 9-VJECARE "HYSEN XHEKA"	NR.FLETES	A-05
VENDNDODHJA	KARBUNARE	FORMATI	420x297
EMERT.I FLETES	DETAJ I ARMIMIT TE TRAREVE KATI PERDHE	SHKALLA	1:500
DREJTOR	ING. MIMOZA HAXHIU		
PERGJEGJES	ARK. SAJMIR MEBELLI		
SPECIALIST	ARK. OKSANA BAVHO		
SPECIALIST	ORJALD DEBINJA		
SPECIALIST	ING. ARTUR SINANI		
SPECIALIST	ING. ARBEN MUCA		
SPECIALIST	ING. MALDIN CELA		
SPECIALIST	ING. KLAJDI MYZEQARI		





# DETAJ I ARMIMIT TRAREVE KATIT PERDHE

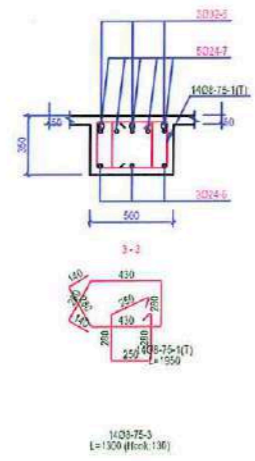
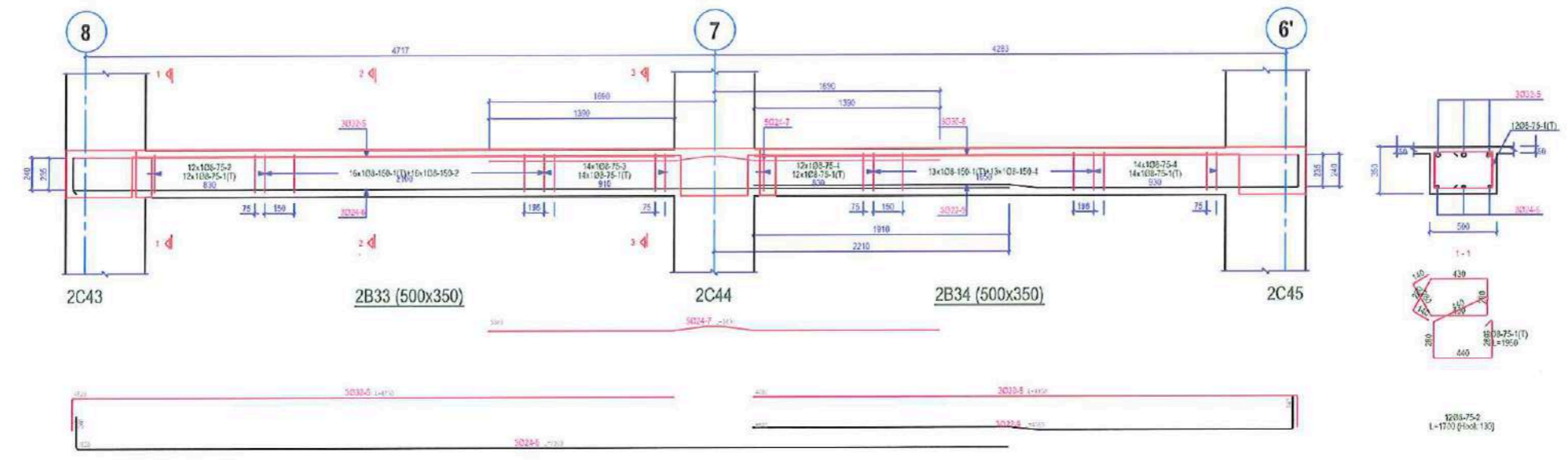

Quantity Table									
NO	SIZE	QJA	LENGTH (mm)	FORM	TOTAL LENGTH (m)				
					Ø8	Ø22	Ø24	Ø30	Ø32
1	8	81	1950		157.95				
2	8	78	1700		47.60				
3	8	14	1300		18.20				
4	8	39	800		31.20				
5	32	3	4750						14.25
6	24	3	7300				21.80		
7	24	5	3100				17.00		
8	30	3	4350						13.65
9	22	3	4350			13.05			
TOTAL LENGTH (m)					254.95	13.05	38.50	13.65	14.25
LIRIT WERKHT (kg/m)					0.40	2.59	3.56	6.55	6.32
WEIGHT (Kg)					100.7	39.0	138.3	72.5	90.1
T.WEIGHT (Kg)					440.6				

BEAM ELEVATIONS1 Scale: 1:120

OBJEKTI	RINDERTIMI I SHKOLLËS 9-VJECARE "HYSEN XHEKA"	NR.FLETES	A-05
VENDNDODHJA	KARBUNARE	FORMATI	420X297
EMERT I FLETES	DETAJ I ARMIMIT TE TRAREVE KATI PERDHE	SHKALLA	1:500
DREJTOR	ING. MIMOZA HAXHIU		
PERGJEGJES	ARK. SAJMIR MEBELLI		
SPECIALIST	ARK. OKSANA BAXHO		
SPECIALIST	ORJALD DEBINJA		
SPECIALIST	ING. ARTUR SINANI		
SPECIALIST	ING. ARBEN MUCA		
SPECIALIST	ING. MALDIN CELA		
SPECIALIST	ING. KLAJDI MYZEQARI		





# DETAJ I ARMIMIT TRAREVE KATIT PERDHE

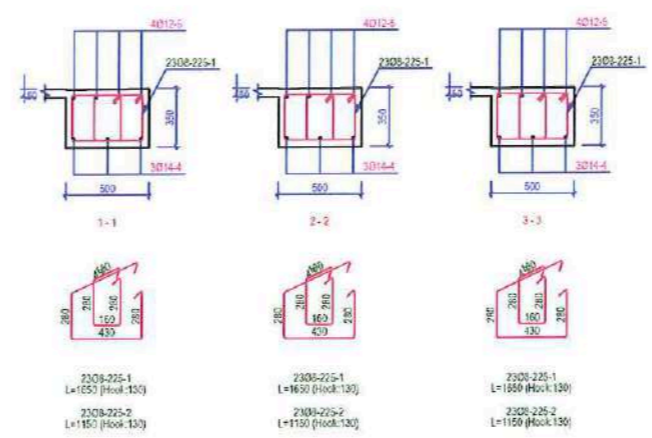
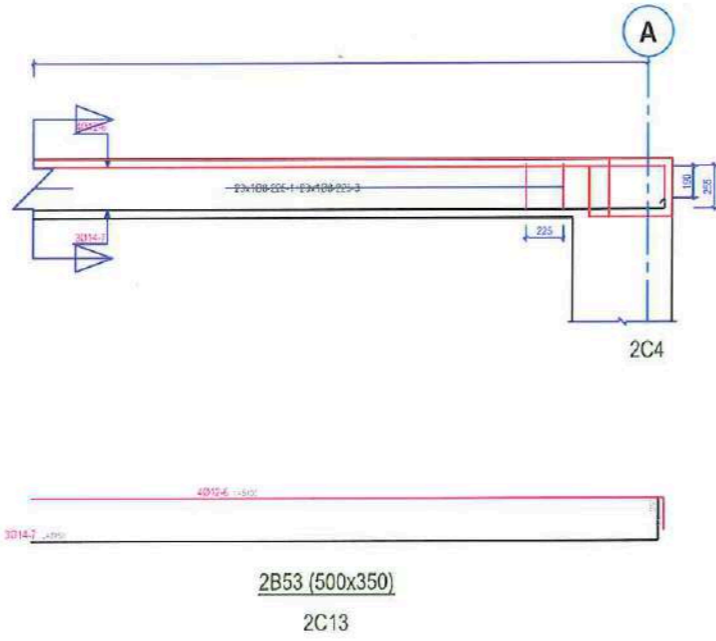
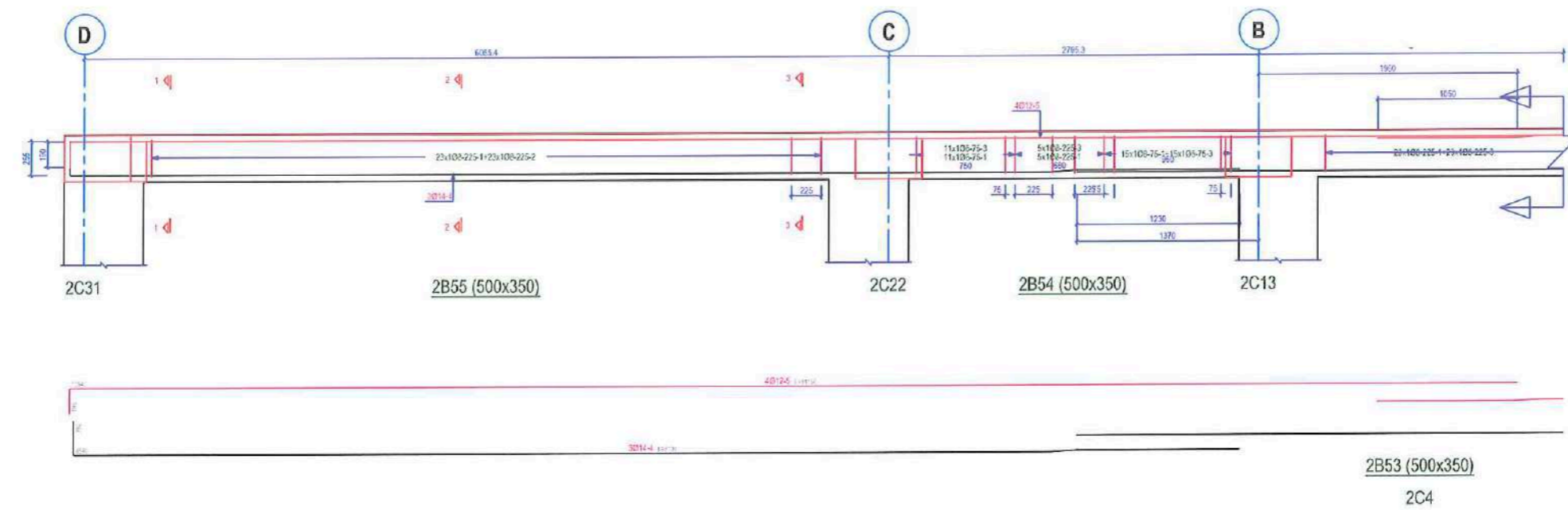

Quantity Table							
NO	SIZE	QUA	LENGTH (mm)	FORM	TOTAL LENGTH (m)		
					D8	D12	D14
1	8	77	1650		127.05		
2	8	23	1150		26.45		
3	8	54	800		43.20		
4	14	3	9100				27.30
5	12	4	11150				44.00
6	12	4	5400				21.20
7	14	3	7750				23.25
TOTAL LENGTH (m)					196.70	66.20	59.55
UNIT WEIGHT (kg/m)					0.40	0.89	1.21
WEIGHT (kg)					77.7	58.8	61.2
T.WEIGHT (kg)					197.7		

BEAM ELEVATIONS1 Scale: 1/120

OBJEKTI	RINDERTIMI I SHKOLLES 9-VJECARE "HYSEN XHEKA"	NR.FLETES	A-05
VENDNDODHJA	KARBUNARE	FORMATI	420x297
EMERT.I FLETES	DETAJ I ARMIMIT TE TRAREVE KATI PERDHE	SHKALLA	1:500
DREJTOR	ING. MIMOZA HAXHIU		
PERGJEGJES	ARK. SAIMIR MEBELLI		
SPECIALIST	ARK. OKSANA BAXHO		
SPECIALIST	DRJALD DEBINJA		
SPECIALIST	ING. ARTUR SINANI		
SPECIALIST	ING. ARBEN MUCA		
SPECIALIST	ING. MALDIN CELA		
SPECIALIST	ING. KLAJDI MYZEQARI		





# DETAJ I ARMIMIT TRAREVE KATIT PERDHE

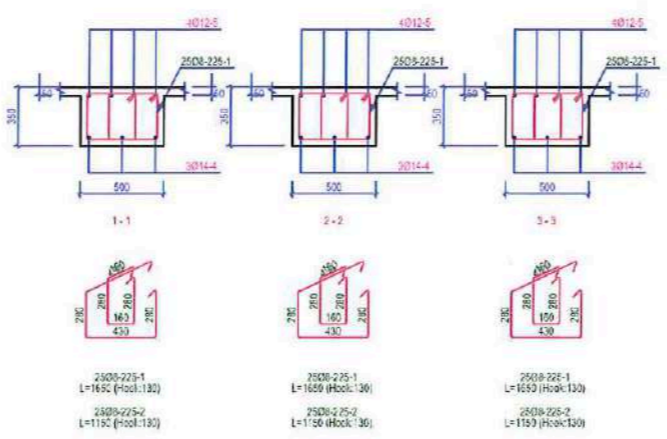
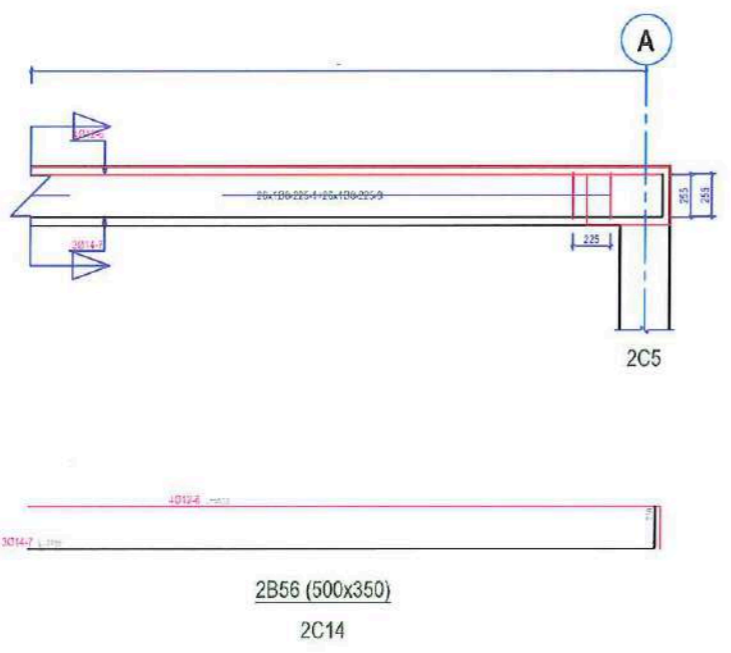
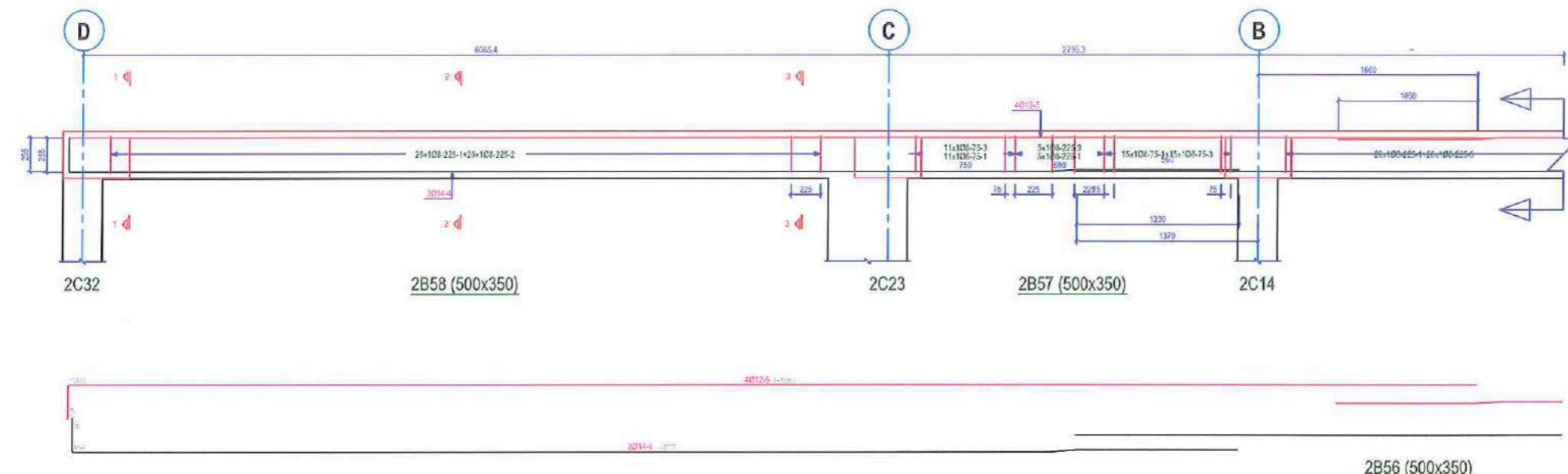

Quantity Table							
NO	SIZE	QVA	LENGTH (mm)	FORM	TOTAL LENGTH (m)		
					Ø8	Ø12	Ø14
1	8	82	1650		136.30		
2	8	25	1150		28.75		
3	8	57	500		45.60		
4	14	3	9100				27.30
5	12	4	10800				43.00
6	12	4	5800				23.20
7	14	3	7750				23.25
TOTAL LENGTH (m)					200.55	66.80	59.55
UNIT WEIGHT (kg/m)					0.40	0.89	1.21
WEIGHT (kg)					82.8	59.4	81.2
T.WEIGHT (kg)					203.4		

BEAM ELEVATIONS 1 Scale: 1:120

OBJEKTI	RINDERTIMI I SHKOLLËS 9-VJECARE "HYSEN XHEKA"	NR.FLETES	A-05
VENDNDODHJA	KARBUNARE	FORMATI	420X297
EMERT.I FLETES	DETAJ I ARMIMIT TE TRAREVE KATI PERDHE	SHKALLA	1:500
DREJTOR	ING. MIMOZA HAXHIU		
PERGJEGJES	ARK. SAJMIR MEBELLI		
SPECIALIST	ARK. OKSANA BAXHO		
SPECIALIST	DRJALD DEBINJA		
SPECIALIST	ING. ARTUR SINANI		
SPECIALIST	ING. ARBEN MUCA		
SPECIALIST	ING. MALDIN CELA		
SPECIALIST	ING. KLAJDI MYZEQARI		





# DETAJ I ARMIMIT TRAREVE KATIT PERDHE

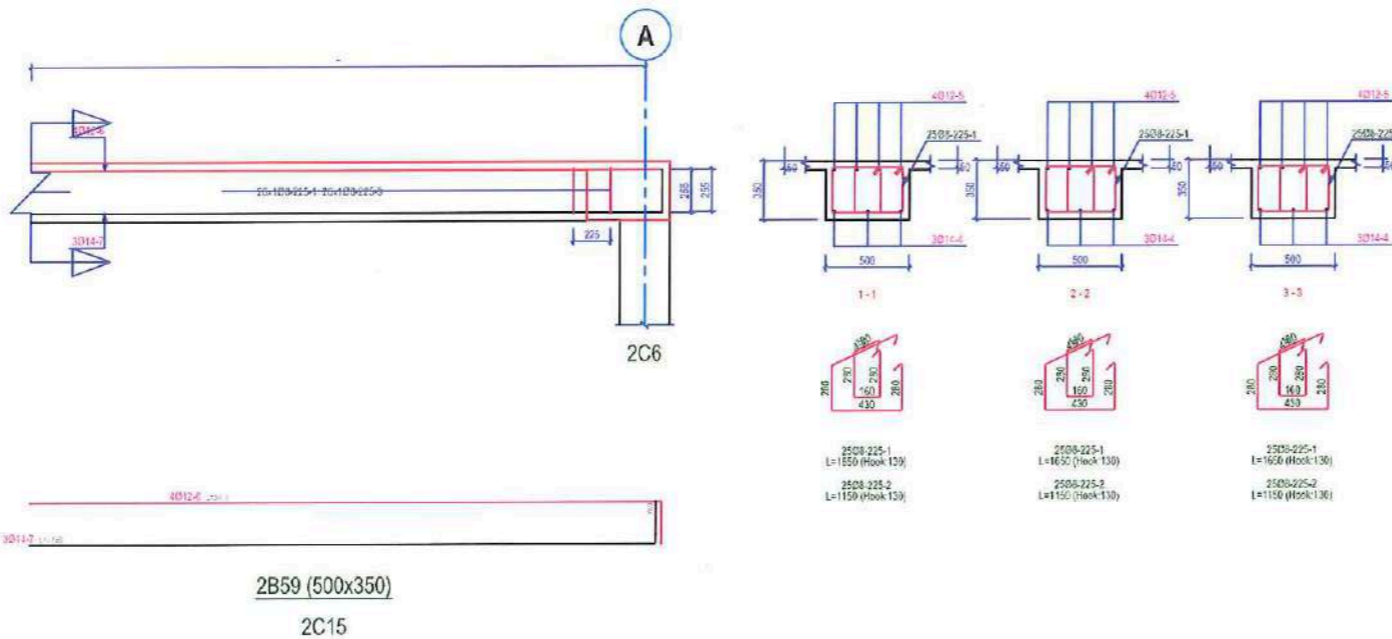
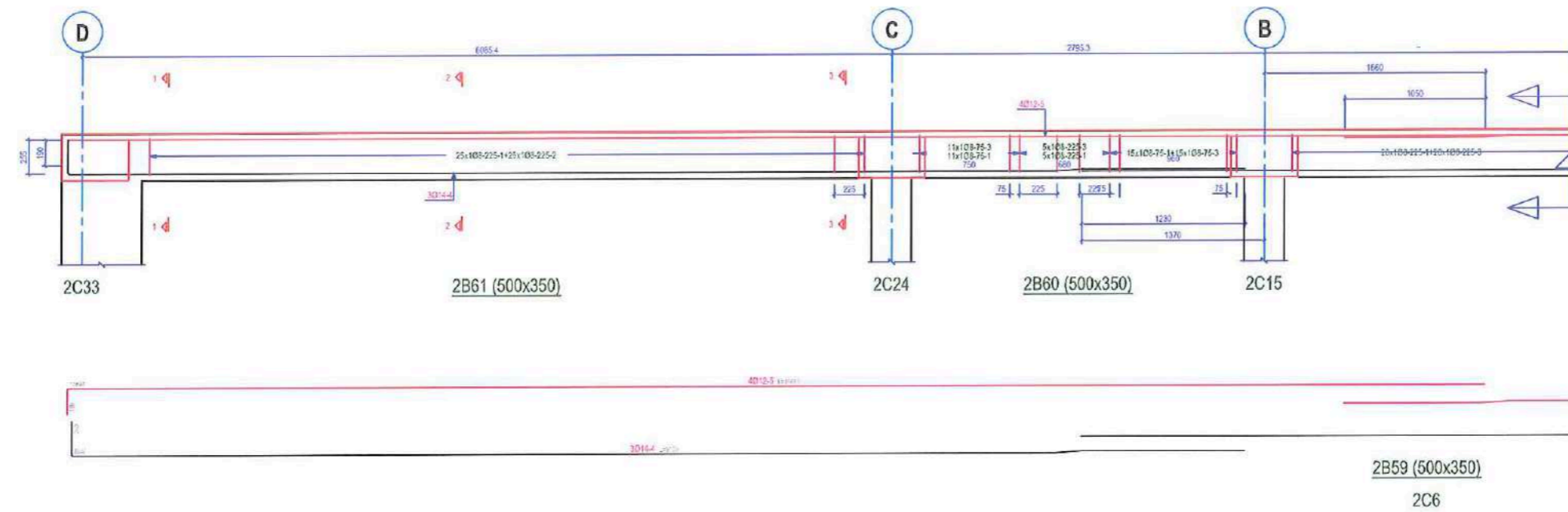

Quantity Table							
NO	SIZE	QUA	LENGTH (mm)	FORM	TOTAL LENGTH (m)		
					Ø8	Ø12	Ø14
1	8	82	1650		135.30		
2	8	25	1150		28.75		
3	8	57	800		45.60		
4	14	3	9160				27.53
5	12	4	16850				43.40
6	12	4	5000				23.20
7	14	3	7750				23.25
TOTAL LENGTH (m)					209.65	66.60	90.85
UNIT WEIGHT (kg/m)					0.40	0.85	1.21
WEIGHT (kg)					82.8	59.2	61.2
T.WEIGHT (kg)					203.2		

BEAM ELEVATIONS1

Scale: 1/120

OBJEKTI	RINDERTIMI I SHKOLLËS 9-VJECARE "HYSEN XHEKA"	NR.FLETES	A-05
VENDNDODHJA	KARBUNARE	FORMATI	420x297
EMERT.I FLETES	DETAJ I ARMIMIT TE TRAREVE KATI PERDHE	SHKALLA	1:500
DREJTOR	ING. MIMOZA HAXHIU		
PERGJEGJES	ARK. SAJMIR MEBELLI		
SPECIALIST	ARK. OKSANA BAXHO		
SPECIALIST	ORJALD DEBINJA		
SPECIALIST	ING. ARTUR SINANI		
SPECIALIST	ING. ARBEN MUCA		
SPECIALIST	ING. MALDIN CELA		
SPECIALIST	ING. KLAJDI MYZEQARI		





# DETAJ I ARMIMIT TRAREVE KATIT PERDHE

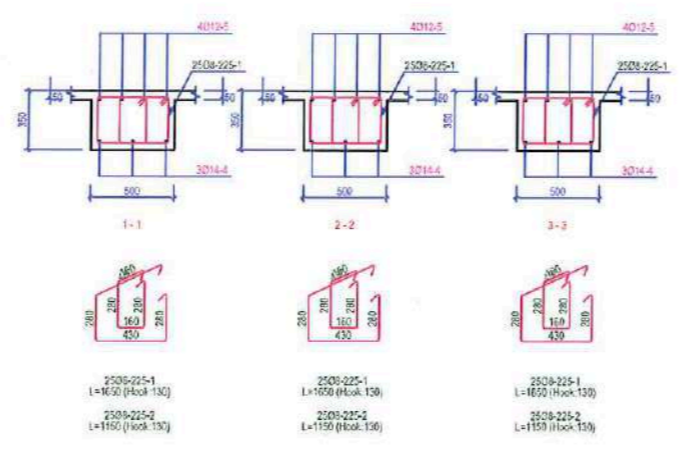
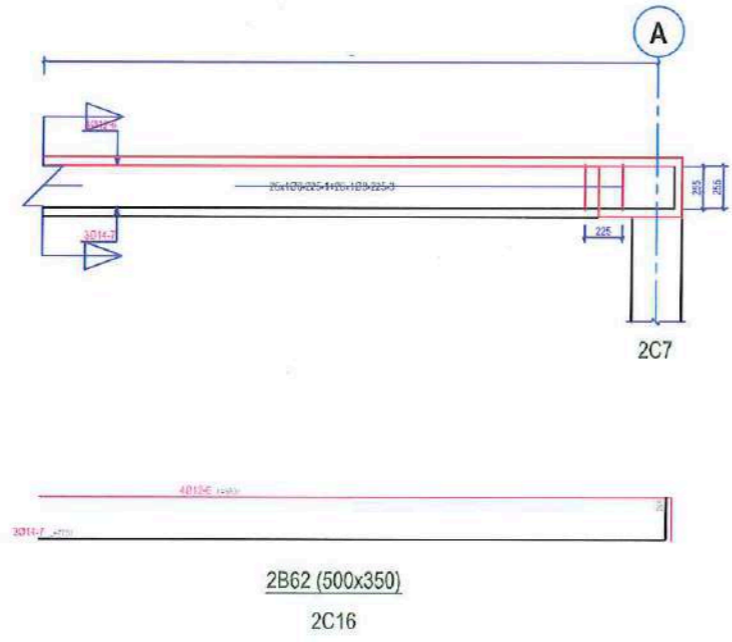
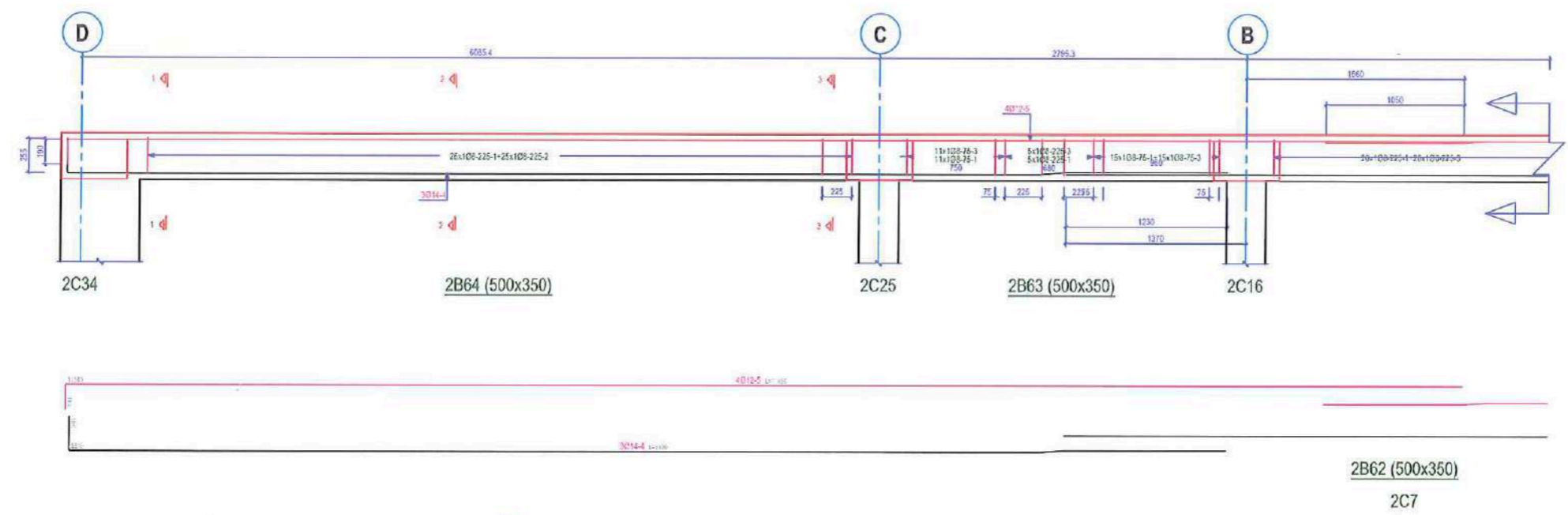

NO	SIZE	QMA	LENGTH (mm)	FORM	TOTAL LENGTH (m)		
					D8	D12	D14
1	8	82	1850	100	135.30		
2	8	25	1150	100	28.75		
3	8	57	800	100	45.60		
4	14	3	9100	100		27.30	
5	12	4	10650	100		43.40	
6	12	4	5800	100		23.20	
7	14	3	7750	100		23.25	
TOTAL LENGTH (m)					200.55	66.90	90.85
UNIT WEIGHT (kg/m)					0.40	0.89	1.21
WEIGHT (kg)					80.80	59.20	61.20
T.WEIGHT (kg)					201.20		

BEAM ELEVATIONS 1 Scale: 1:120

OBJEKTI	RINDERTIMI I SHKOLLËS 9-VJECARE "HYSEN XHEKA"	NR.FLETES	A-05
VENDNDODHJA	KARBUNARE	FORMATI	420x297
EMERT.I FLETES	DETAJ I ARMIMIT TE TRAREVE KATI PERDHE	SHKALLA	1:500
DIREKTOR	ING. MIMOZA HAXHIU		
PERGJEGJES	ARK. SAIMIR MEBELLI		
SPECIALIST	ARK. OKSANA BAXHO		
SPECIALIST	ORJALD DEBINJA		
SPECIALIST	ING. ARTUR SINANI		
SPECIALIST	ING. ARBEN MUCA		
SPECIALIST	ING. MALDIN CELA		
SPECIALIST	ING. KLAJDI MYZEQARI		





# DETAJ I ARMIMIT TRAREVE KATIT PERDHE

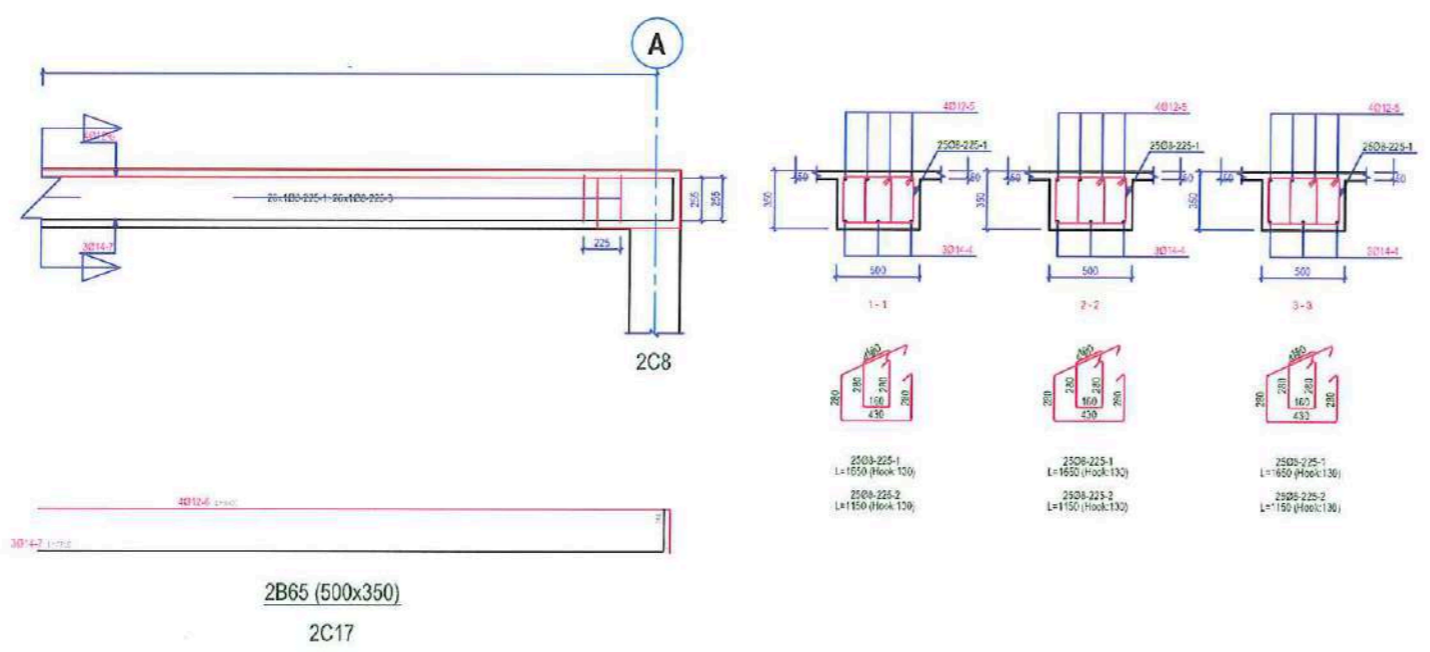
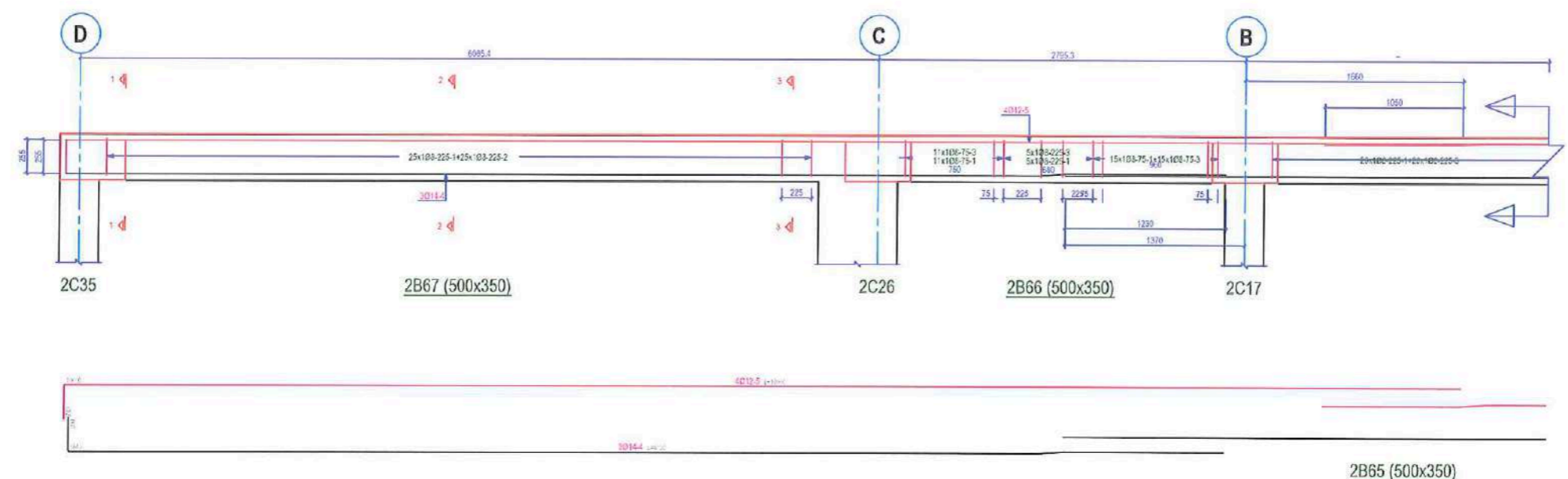

NO	SIZE	QUA	LENGTH (mm)	FORM	TOTAL LENGTH (m)		
					Ø8	Ø12	Ø14
1	8	82	1650		135.30		
2	8	25	1150		28.75		
3	8	57	800		45.60		
4	14	3	9100				27.30
5	12	4	10500				43.60
6	12	4	5000				23.20
7	14	3	7750				23.25
<b>TOTAL LENGTH (m)</b>					209.65	66.60	50.55
<b>UNIT WEIGHT (Kg/m)</b>					0.40	0.83	1.21
<b>WEIGHT (Kg)</b>					82.8	59.4	61.2
<b>T.WEIGHT (Kg)</b>					203.4		

BEAM ELEVATIONS1 Scale: 1/120

OBJEKTI	RINDERTIMI I SHKOLLES 9-VJECARE "HYSEN XHEKA"	NR.FLETES	A-05
VENDNDODHJA	KARBUNARE	FORMATI	420X297
EMERT.I FLETES	DETAJ I ARMIMIT TE TRAREVE KATI PERDHE	SHKALLA	1:500
DREJTOR	ING. NIMOZA HAXHIU		
PERGJEGJES	ARK. SAIMIR MEBELLI		
SPECIALIST	ARK. OKSANA BASHO		
SPECIALIST	ORJALD DEBINDA		
SPECIALIST	ING. ARTUR SINANI		
SPECIALIST	ING. ARBEN MUCA		
SPECIALIST	ING. MALDIN CELA		
SPECIALIST	ING. KLAJDI MYZEQARI		



# DETAJ I ARMIMIT TRAREVE KATIT PERDHE

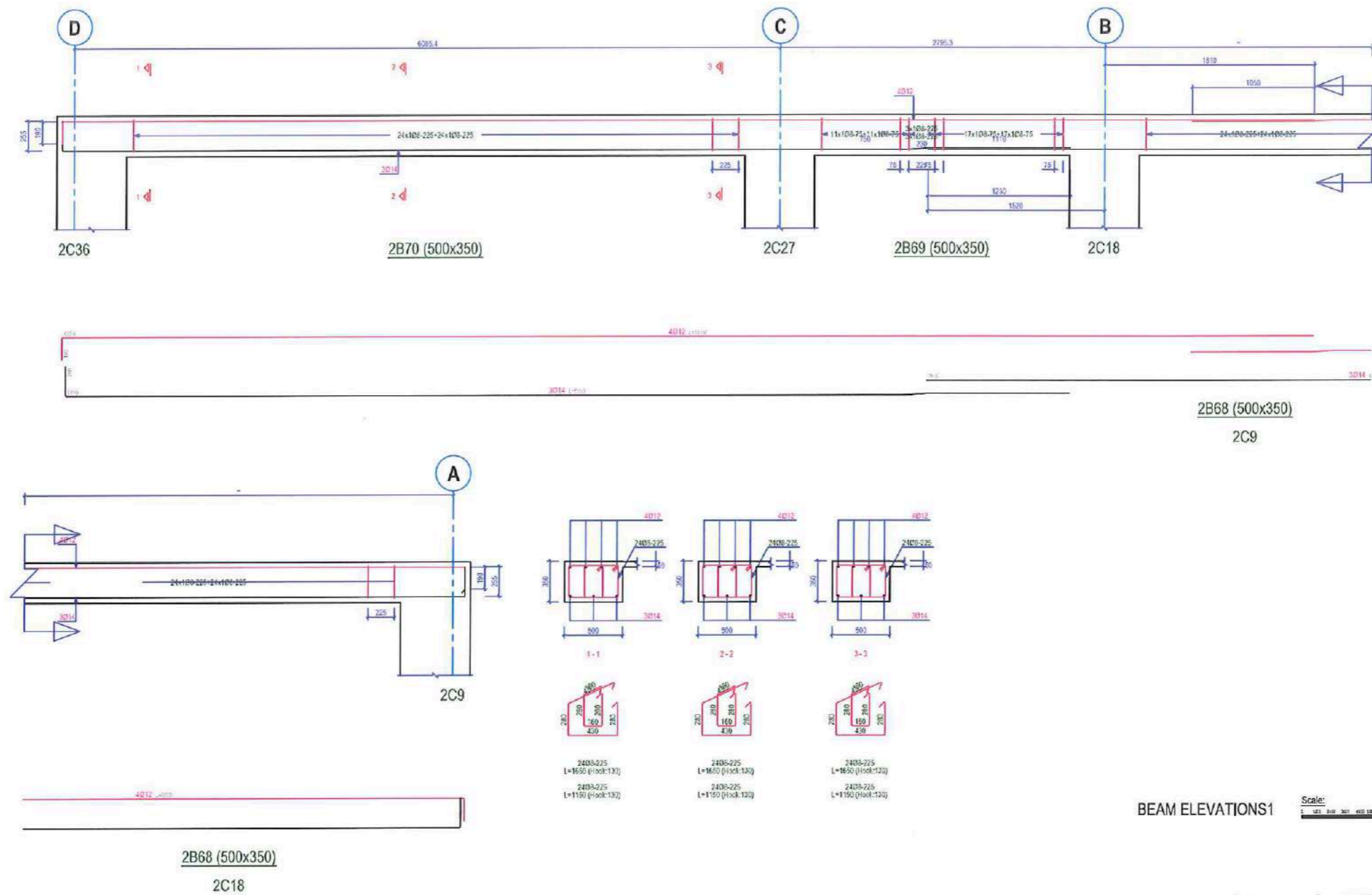

BEAM ELEVATIONS1

Scale: 1/120

OBJEKTI	RINDERTIMI I SHKOLLES 9-VJECARE "HYSEN XHEKA"	NR.FLETES	A-05
VENDNDODHJA	KARBUNARE	FORMATI	420X297
EMERT.I.FLETES	DETAJ I ARMIMIT TE TRAREVE KATI PERDHE	SHKALLA	1:500
DREJTOR	ING. NIMOZA HAXHIU	<p>REPUBLIKA E SHQIPERISE BASHKIA LUSHNJE</p>	
PERGJEGJES	ARK. SAIMIR MEBELI		
SPECIALIST	ARK. OKSANA BAKHO		
SPECIALIST	ORJALD DEBINJA		
SPECIALIST	ING. ARTUR SIRANI		
SPECIALIST	ING. ARBEN MUCA		
SPECIALIST	ING. MALDIN CELA		
SPECIALIST	ING. KLADI MYZEQARI		





# DETAJ I ARMIMIT TRAREVE KATIT PERDHE

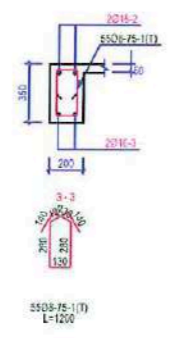
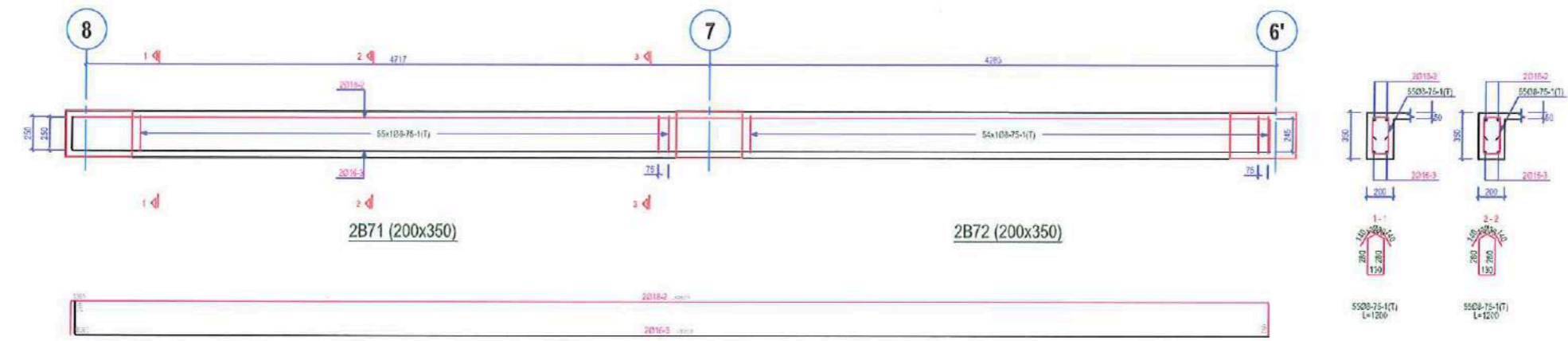

Quantity Table							
NO	SIZE	QUA	LENGTH (mm)	FORM	TOTAL LENGTH (m)		
					D15	D16	D18
1	8	100	1200		100.00		
2	16	2	9500			18.20	
3	16	2	9350			18.70	
TOTAL LENGTH (m)					130.00	18.70	18.20
UNIT WEIGHT (kg/m)					0.49	1.55	2.00
WEIGHT (kg)					51.7	29.5	38.4
T.WEIGHT (kg)					119.6		

BEAM ELEVATIONS1 Scale: 1:120

OBJEKTI	RINDERTIMI I SHKOLLES 9-VJECARE "HYSEN XHEKA"	NR.FLETES	A-05
VENDNDODHJA	KARBUNARE	FORMATI	420X297
EMERT.I FLETES	DETAJ I ARMIMIT TE TRAREVE KATI PERDHE	SHKALLA	1:500
DREJTOR	ING. MIMOZA HAXHIU		
PERGJEGJES	ARK. SAIMIR MEBELI		
SPECIALIST	ARK. OKSANA BASHO		
SPECIALIST	ORJALD DEBINA		
SPECIALIST	ING. ARTUR SINANI		
SPECIALIST	ING. ARBEN MUCA		
SPECIALIST	ING. MALDIN CELA		
SPECIALIST	ING. KLAJDI MYZEQARI		





# DETAJ I ARMIMIT TRAREVE KATIT PERDHE

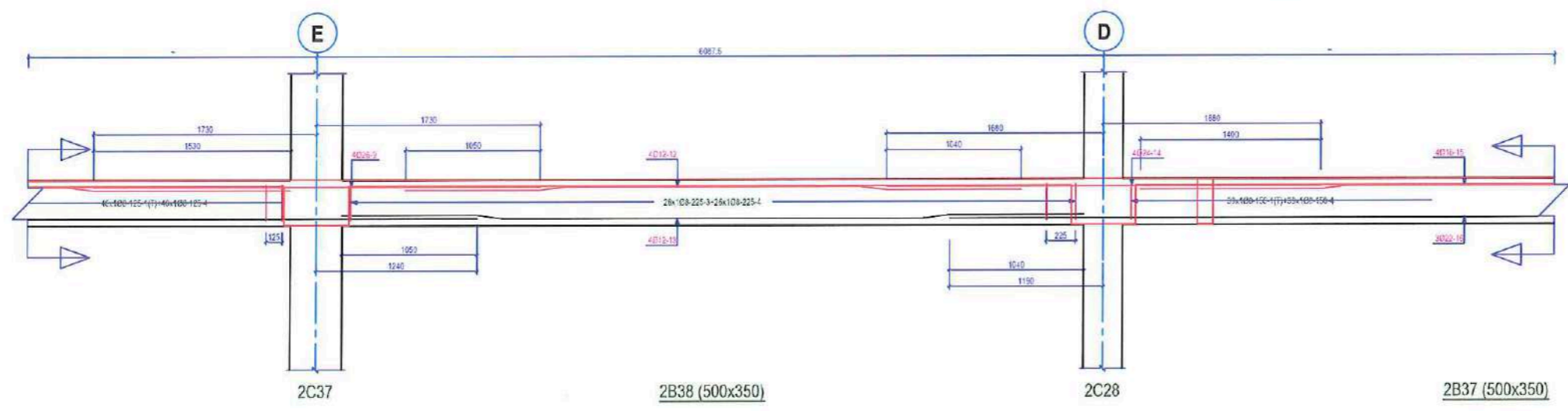
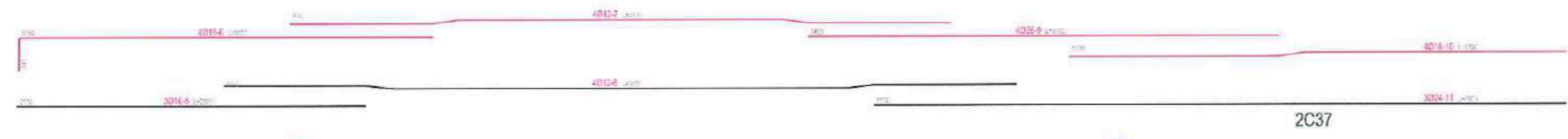
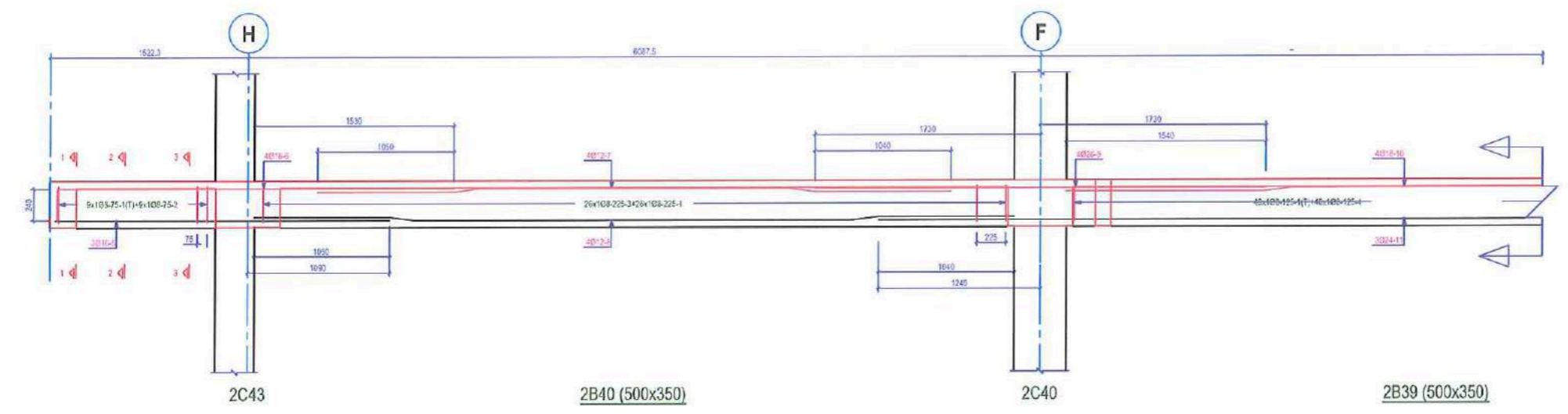

BEAM ELEVATIONS1 Scale: 1/120

OBJEKTI	RINDITIMI I SHKOLLES 9-VJECARE "HYSEN XHEKA"	NR.FLETES	A-05
VENDNDODHJA	KARBUNARE	FORMATI	420x297
EMERT I FLETES	DETAJ I ARMIMIT TE TRAREVE KATI PERDHE	SHKALLA	1:500
DREJTOR	ING. MIMOZA HAXHIU		
PERGJEGJES	ARK. SAJMIR MEBELLI		
SPECIALIST	ARK. OKSANA BASHO		
SPECIALIST	ORJALD DEBINJA		
SPECIALIST	ING. ARTUR SIMANI		
SPECIALIST	ING. ARBEN MUCA		
SPECIALIST	ING. MALDIN CELA		
SPECIALIST	ING. KLAJDI MYZEQARI		



# DETAJ I ARMIMIT TRAREVE KATIT PERDHE

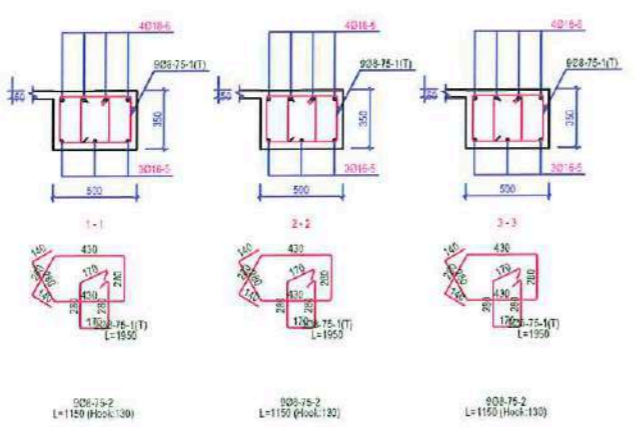
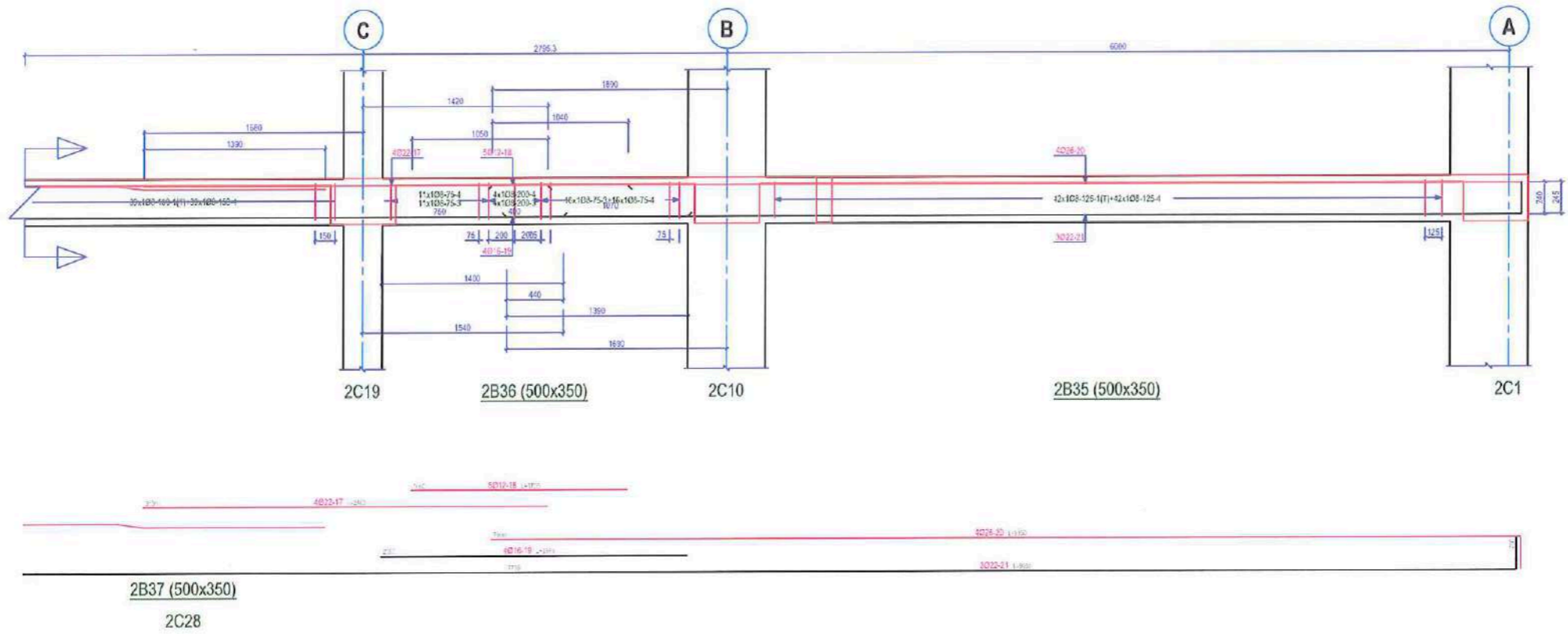

Quantity Table													
NO	SEE	QUA	LENGTH (mm)	FORM	TOTAL LENGTH (m)								
					Ø8	Ø12	Ø16	Ø18	Ø22	Ø24	Ø25		
1	8	130	1650	□	265.20								
2	8	9	1150	□	19.35								
3	8	83	1650	□	136.95								
4	8	210	800	□	168.00								
5	16	3	2500	□			7.80						
6	16	4	3300	□				13.20					
7	12	4	1900	□		15.60							
8	12	4	5550	□		23.40							
9	26	8	3000	□							25.00		
10	16	4	3700	□				22.80					
11	24	3	6500	□							25.80		
12	12	4	1800	□		16.20							
13	12	4	5750	□		23.00							
14	24	4	3400	□							13.60		
15	16	4	5550	□			22.20						
16	22	3	8250	□							26.55		
17	22	4	3100	□							12.40		
18	12	5	1700	□		8.50							
19	16	4	2350	□			5.40						
20	20	4	8150	□								32.60	
21	22	3	8050	□							24.15		
TOTAL LENGTH (m)					580.20	93.70	39.40	38.00	53.10	39.40	62.60		
UNIT WEIGHT (Kg/m)					0.40	0.89	1.58	2.00	2.99	3.56	4.17		
WEIGHT (Kg)					229.3	83.3	62.3	72.0	158.6	140.1	262.0		
T.WEIGHT (Kg)					1,028.4								

BEAM ELEVATIONS1      Scale: 1/120

OBJEKTI	RINDERTIMI I SHKOLLËS 9-VJECARE "HYSEN XHEKA"	NR.FLETES	A-05
VENDNDODHJA	KARBUNARE	FORMATI	420x297
EMERT I FLETES	DETAJ I ARMIMIT TE TRAREVE KATI PERDHE	SHKALLA	1:500
DREJTOR	ING. MIMOZA HAXHILU		
PERGJEGJES	ARK. SAIMIR MEBELLI		
SPECIALIST	ARK. OKSANA BAXHO		
SPECIALIST	ORJALD DEBINJA		
SPECIALIST	ING. ARTUR SINANI		
SPECIALIST	ING. ARBEN MUCA		
SPECIALIST	ING. MALDIN CELA		
SPECIALIST	ING. KLAJDI MYZEQARI		



# DETAJ I ARMIMIT TRAREVE KATIT PERDHE

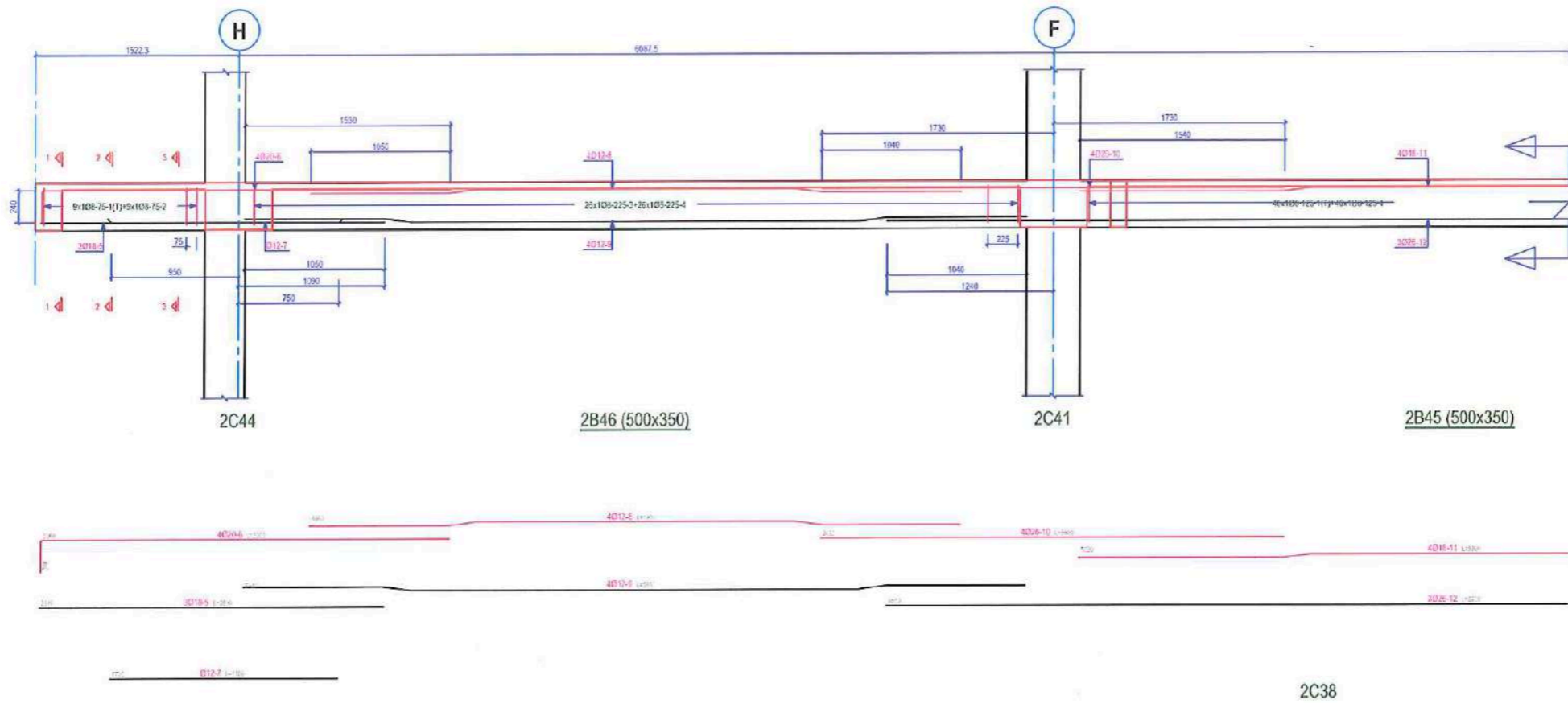

BEAM ELEVATIONS1 Scale: 1/120

OBJEKTI	RINDERTIMI I SHKOLLËS 9-VJECARE "HYSEN XHEKA"	NR.FLETES	A-05
VENDNDODHJA	KARBUNARE	FORMATI	420x297
EMERT I FLETES	DETAJ I ARMIMIT TE TRAREVE KATI PERDHE	SHKALLA	1:500
DREJTOR	ING. MIMOZA HAXHIU		
PERGJEGJES	ARK. SAJMIR MEBELI		
SPECIALIST	ARK. OKSANA BASHO		
SPECIALIST	ORJALD DEBINA		
SPECIALIST	ING. ARTUR SINANI		
SPECIALIST	ING. ARBEN MUCA		
SPECIALIST	ING. MALDIN CELA		
SPECIALIST	ING. KLAJDI MYZEQARI		







# DETAJ I ARMIMIT TRAREVE KATIT PERDHE

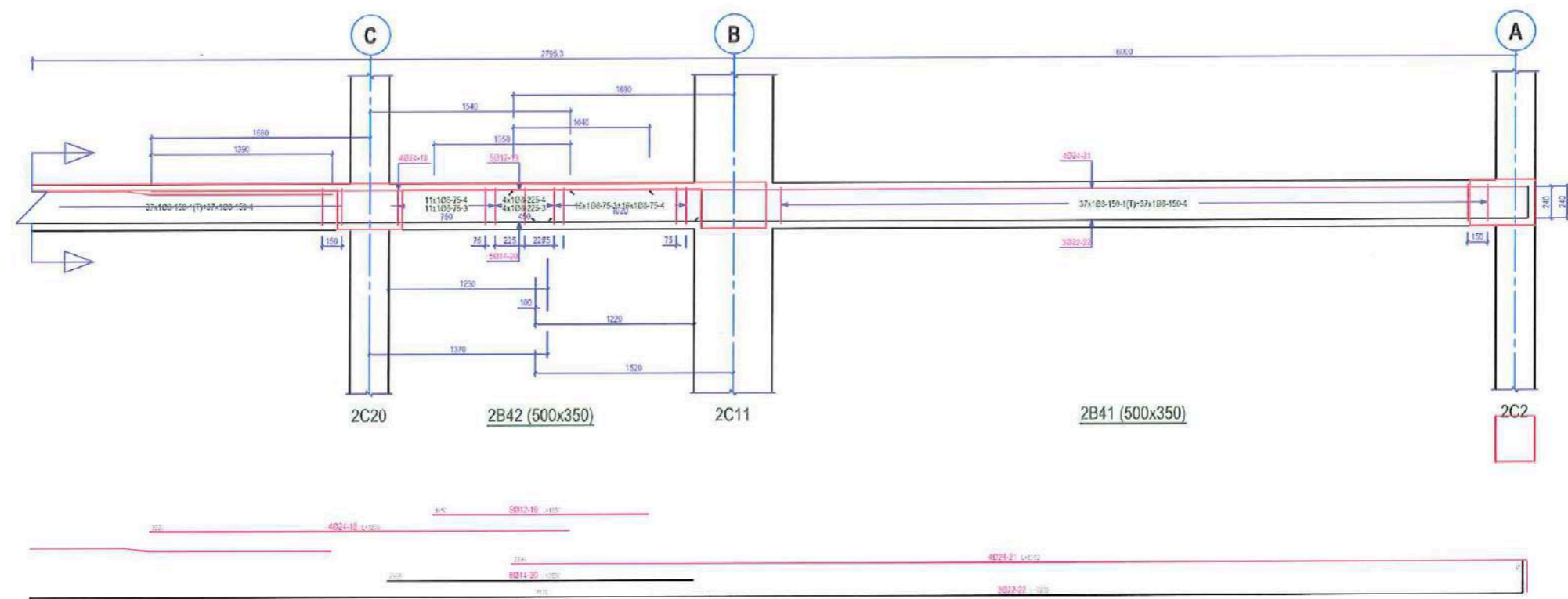

2B43 (500x350)  
2C29

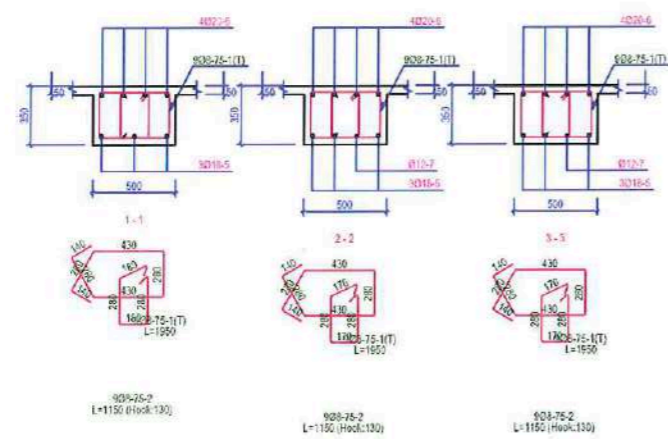

Quantity Table																				
NO	SIZE	QUA	LENGTH (m)	FORM	TOTAL LENGTH (m)															
					Ø8	Ø12	Ø14	Ø16	Ø18	Ø20	Ø22	Ø24	Ø26							
1	8	129	1050		251.55															
2	8	18	1150		20.70															
3	8	83	1550		136.95															
4	8	203	800		162.40															
5	18	3	2950							7.80										
6	20	4	3300								13.20									
7	12	1	1700			1.70														
8	12	4	4300			19.60														
9	12	4	5850			23.40														
10	20	8	3500																28.00	
11	18	4	5700							22.80										
12	26	3	8600																25.80	
13	12	4	4800			10.20														
14	12	4	5750			23.00														
15	20	4	3700																14.80	
16	16	4	5250						21.00											
17	22	3	6650															23.90		
18	24	4	3250																13.00	
19	12	5	1650		8.25															
20	14	5	2350			11.75														
21	24	4	8050																32.20	
22	22	3	7900																23.70	
TOTAL LENGTH (m)					671.60	95.45	11.75	21.00	30.60	13.20	49.65	45.20	65.00							
UNIT WEIGHT (Kg/m)					0.40	0.89	1.21	1.58	2.00	2.47	2.99	3.56	4.17							
WEIGHT (Kg)					225.8	84.8	14.2	33.2	61.2	32.6	149.3	160.7	268.3							
T.WEIGHT (Kg)					1.046.9															

BEAM ELEVATIONS1

Scale: 1:120

OBJEKTI	RINDERTIMI I SHKOLLËS 9-VJECARE "HYSEN XHEKA"	NR.FLETES	A-05
VENDNDODHJA	KARBUNARE	FORMATI	420X297
EMERT I FLETES	DETAJ I ARMIMIT TE TRAREVE KATI PERDHE	SHKALLA	1:500
DREJTOR	ING. MIMOZA HAXHIU		
PERGJEGJES	ARK. SAJMIR MEBELLI		
SPECIALIST	ARK. OKSANA BASHO		
SPECIALIST	ORJALD DEBINJA		
SPECIALIST	ING. ARTUR SINANI		
SPECIALIST	ING. ARBEN MUCA		
SPECIALIST	ING. MALDIN CELA		
SPECIALIST	ING. KLAJDI MYZEQARI		

# DETAJ I ARMIMIT TRAREVE KATIT PERDHE

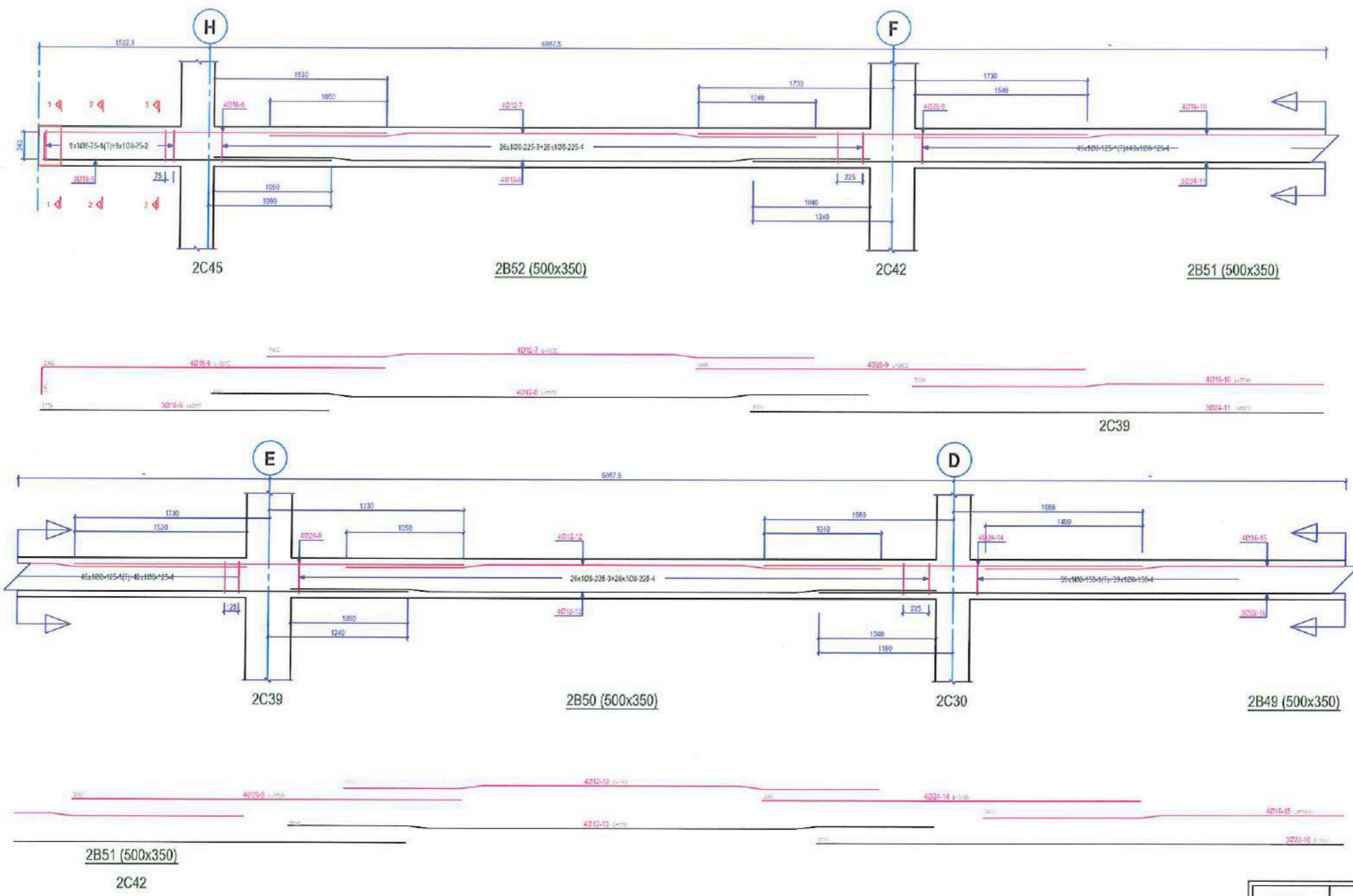

BEAM ELEVATIONS1

Scale: 1/120

OBJEKTI	RINDERTIMI I SHKOLLËS 9-VJEÇARE "HYSEN XHEKA"	NR.FLETES	A-05
VENDNDODHJA	KARBUNARE	FORMATI	420X297
EMERT.I FLETES	DETAJ I ARMIMIT TE TRAREVE KATI PERDHE	SHKALLA	1:500
DREJTOR	ING. MIMOZA HAXHIU		
PERGJEGJES	ARK. SAIMIR HEBELI		
SPECIALIST	ARK. OKSANA BASHO		
SPECIALIST	ORJALD DEBINA		
SPECIALIST	ING. ARTUR SINANI		
SPECIALIST	ING. ARBEN MUCA		
SPECIALIST	ING. MALDIN CELA		
SPECIALIST	ING. KLAJDI MYZEQARI		



# DETAJ I ARMIMIT TRAREVE KATIT PERDHE

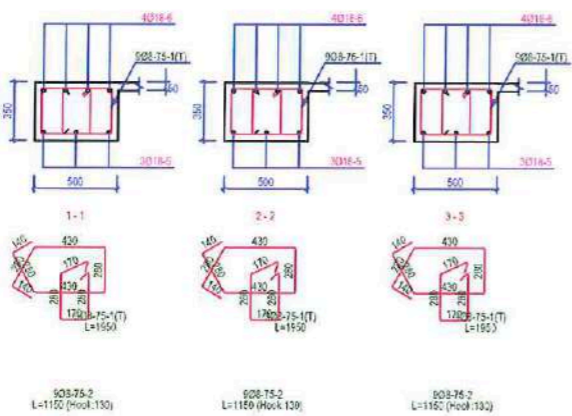
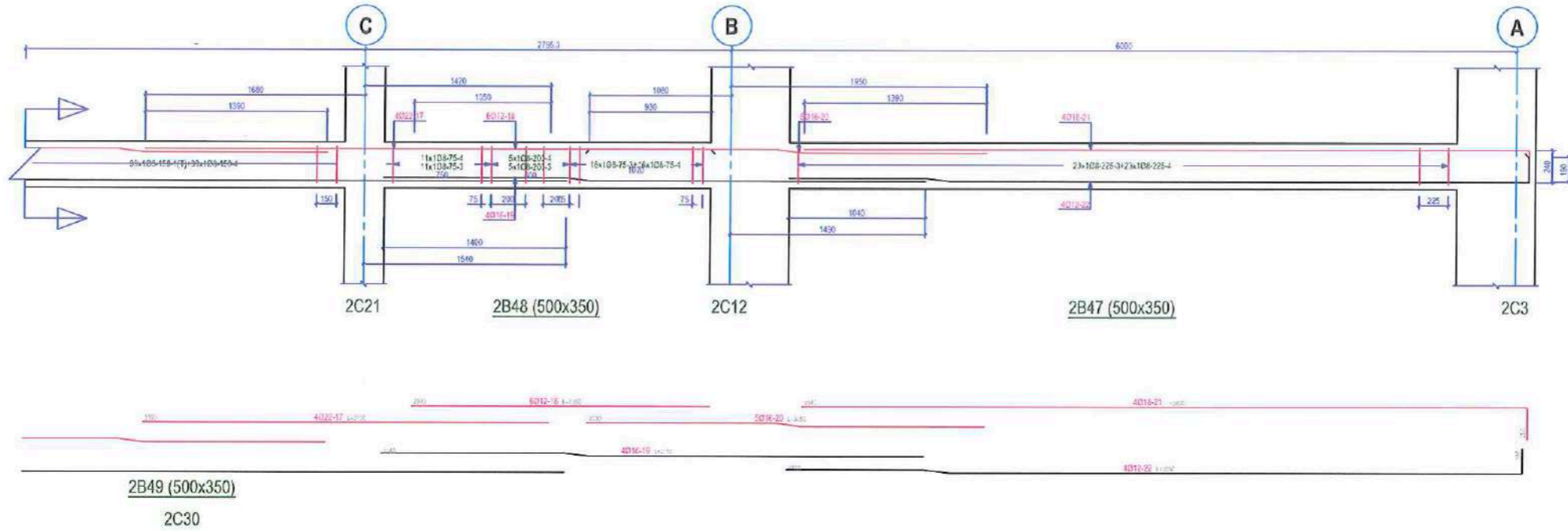

Quantity Table											
NO	SIZE	DUA	LENGTH (mm)	FORM	TOTAL LENGTH (m)						
					Ø8	Ø12	Ø16	Ø18	Ø22	Ø25	Ø28
1	8	Ø4	1950		183.50						
2	8	Ø9	1150		10.35						
3	8	Ø107	1650		176.55						
4	8	Ø192	600		153.60						
5	16	Ø3	2800					7.80			
6	16	Ø4	3900					13.20			
7	12	Ø4	4300			16.60					
8	12	Ø4	5850			23.40					
9	25	Ø8	3900							28.00	
10	15	Ø4	6700					22.80			
11	24	Ø3	8500							25.80	
12	12	Ø4	4800			15.20					
13	12	Ø4	5750			23.00					
14	24	Ø4	3400							13.60	
15	16	Ø4	5500				22.20				
16	22	Ø3	5850					26.55			
17	22	Ø4	3100					12.40			
18	12	Ø6	2300			13.80					
19	16	Ø4	4150			16.60					
20	16	Ø5	3650			15.25					
21	18	Ø4	5000				23.20				
22	12	Ø4	5850			23.40					
TOTAL LENGTH (m)					523.80	122.40	51.20	67.60	38.95	39.10	28.00
UNIT WEIGHT (kg/m)					0.49	0.89	1.58	2.00	2.99	3.56	4.17
WEIGHT (kg)					256.9	108.8	85.4	134.0	116.4	140.1	116.8
T.WEIGHT (kg)					968.4						

BEAM ELEVATIONS1 Scale: 1/120

OBJEKTI	RINDERTIMI I SHKOLLËS 9-VJECARE "HYSEN XHEKA"	NR.FLETES	A-05
VENDNDODHJA	KARBUNARE	FORMATI	420X297
EMERT.I FLETES	DETAJ I ARMIMIT TE TRAREVE KATI PERDHE	SHKALLA	1:500
DREJTOR	ING. NIMOZA HAXHIU		
PERGJEGJES	ARK. SAIMIR MEBELI		
SPECIALIST	ARK. OXSANA BAXHO		
SPECIALIST	ORJALD DEBINJA		
SPECIALIST	ING. ARTUR SINANI		
SPECIALIST	ING. ARBEN MUCA		
SPECIALIST	ING. MALDIN CELA		
SPECIALIST	ING. KLAJDI MYZEQARI		



# DETAJ I ARMIMIT TRAVETES NE SOLETEN KATIT PERDHE

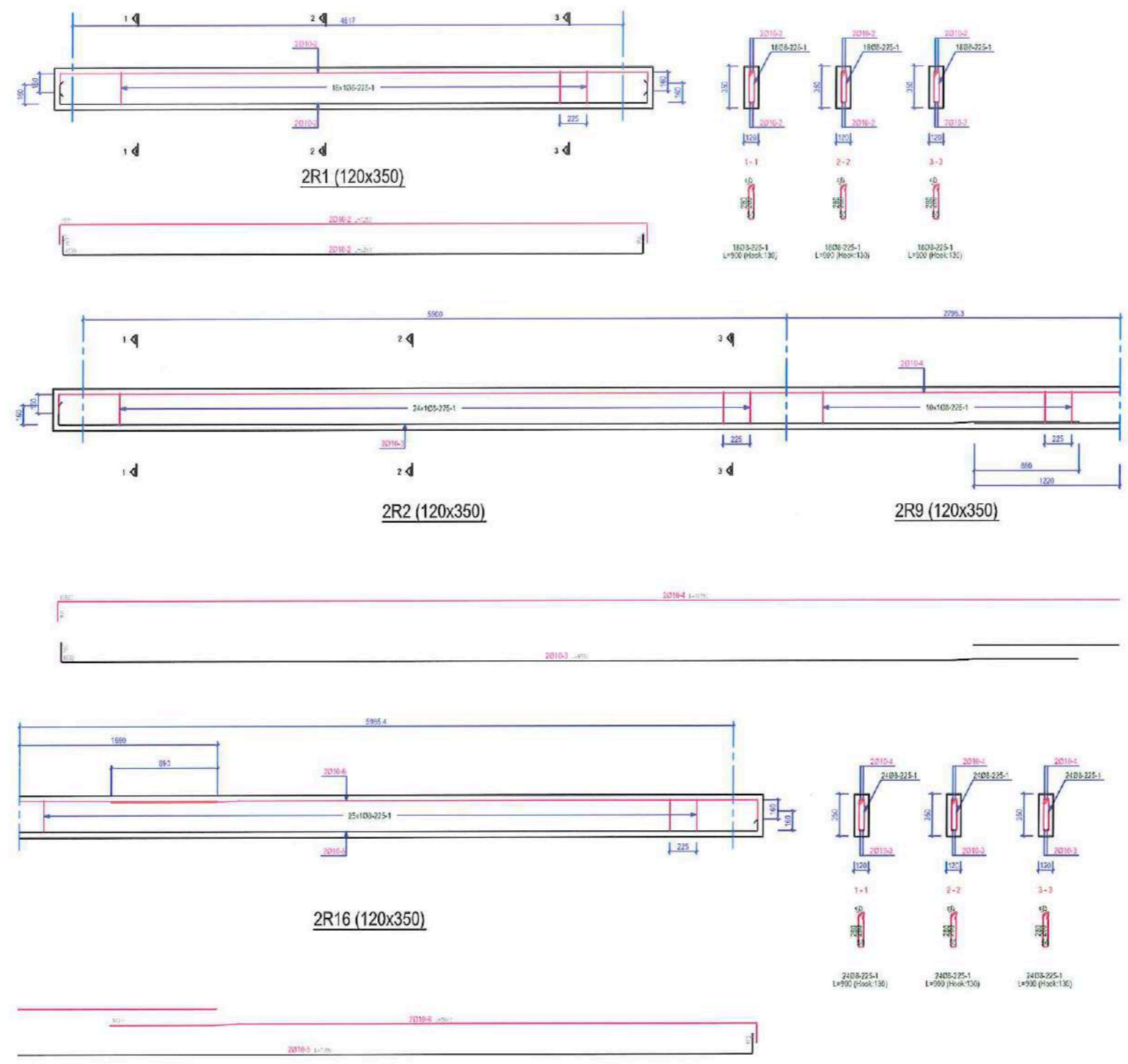

OBJEKTI	RINDERTIMI I SHKOLLËS 9-VJEÇARE "HYSEN XHEKA"	NR.FLETES	A-05
VENDNDODHJA	KARBUNARE	FORMATI	420X297
EMERT.I FLETES	DETAJ I ARMIMIT TE TRAVETES NE SOLETEN E K PERDHE	SHKALLA	1:500
DREJTOR	ING. MIMOZA HAXHIU		
PERGJEGJES	ARK. SAIMIR MEBELLI		
SPECIALIST	ARK. OKSANA BAXHO		
SPECIALIST	ORJALD DEBINJA		
SPECIALIST	ING. ARTUR SINANI		
SPECIALIST	ING. ARBEN MUCA		
SPECIALIST	ING. MALDIN CELA		
SPECIALIST	ING. KLAJDI MYZEQARI		



# DETAJ I ARMIMIT TRAVETES NE SOLETEN KATIT PERDHE

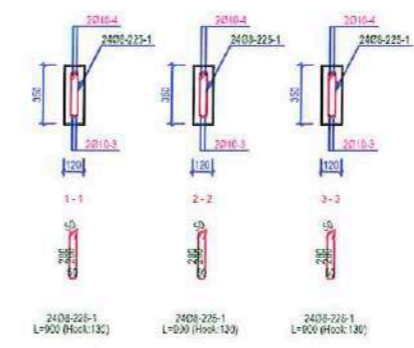
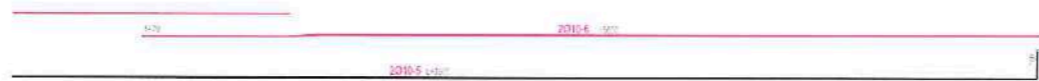
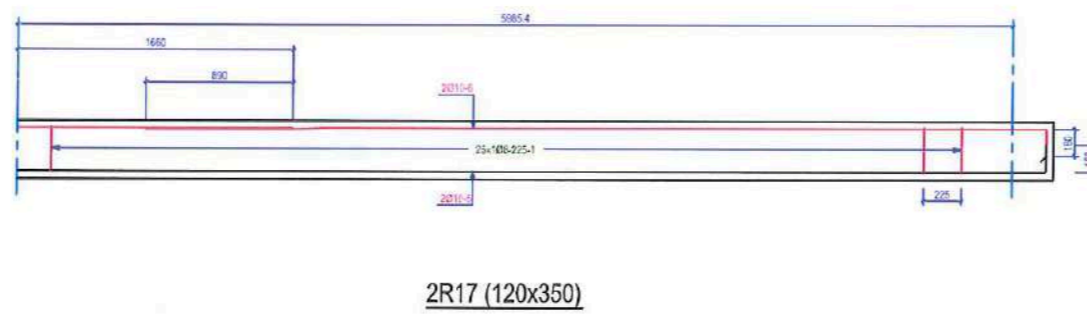
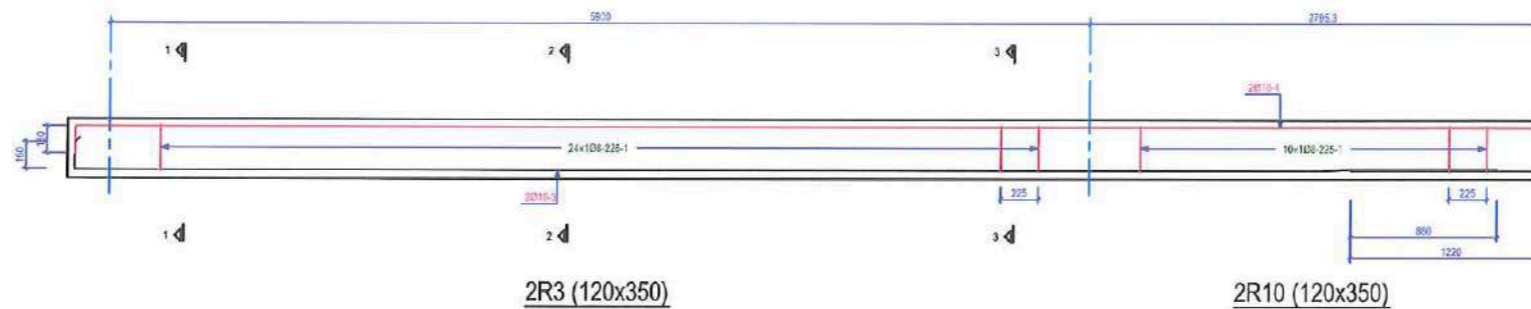

Scale: 1/120

OBJEKTI	RINDERTIMI I SHKOLLES 9-VJEÇARE "HYSEN XHEKA"	NR.FLETES	A-05
VENDNDODHJA	KARBUNARE	FORMATI	420X297
EMERT.I FLETES	DETAJ I ARMIMIT TE TRAVETES NE SOLETEN E K PERDHE	SHKALLA	1:500
DREJTOR	ING. MIMOZA HAXHIU	 REPUBLIKA E SHQIPERISE BASHKIA LUSHNJE	
PERGJEGJES	ARK. SAIMIR NEBELLI		
SPECIALIST	ARK. OKSANA BAXHO		
SPECIALIST	ORJALD DEBINIA		
SPECIALIST	ING. ARTUR SINANI		
SPECIALIST	ING. ARBEN MUCA		
SPECIALIST	ING. MALDIN CELA		
SPECIALIST	ING. KLAJDI MYZEQARI		





# DETAJ I ARMIMIT TRAVETES NE SOLETEN KATIT PERDHE

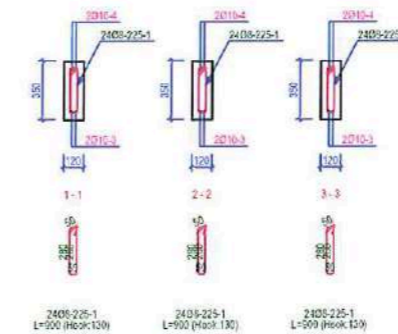
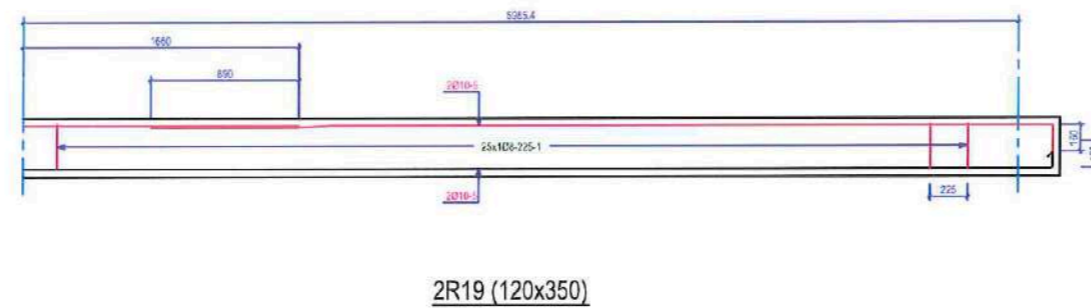
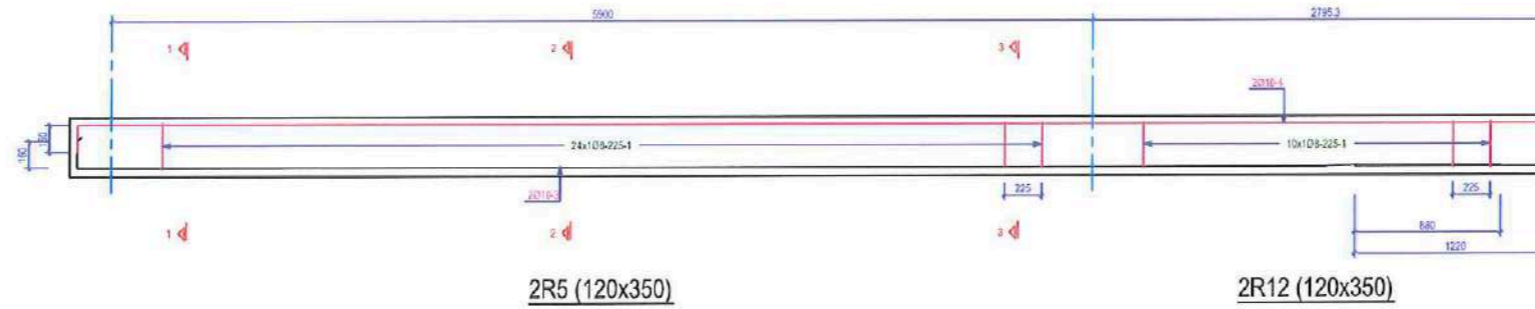

Scale: 1/120

OBJEKTI	RINDERTIMI I SHKOLLËS 9-VJEÇARE "HYSEN XHIEKA"	NR. FLETES	A-05
VENDNDODHJA	KARBUNARE	FORMATI	420x297
EMERT. I FLETES	DETAJ I ARMIMIT TE TRAVETES NE SOLETEN E K PERDHE	SHKALLA	1:500
DREJTOR	ING. MIMOZA HAXHIU		
PERGJEGJES	ARK. SAIMIR MERELLI		
SPECIALIST	ARK. OKSANA BASHO		
SPECIALIST	ORJALD DEBINJA		
SPECIALIST	ING. ARTUR SINANI		
SPECIALIST	ING. ARBEN MUCA		
SPECIALIST	ING. MALDIN CELA		
SPECIALIST	ING. KLAJDI MYZEQARI		



# DETAJ I ARMIMIT TRAVETES NE SOLETEN KATIT PERDHE

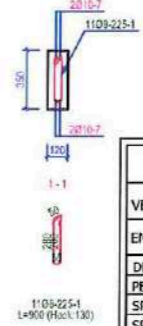
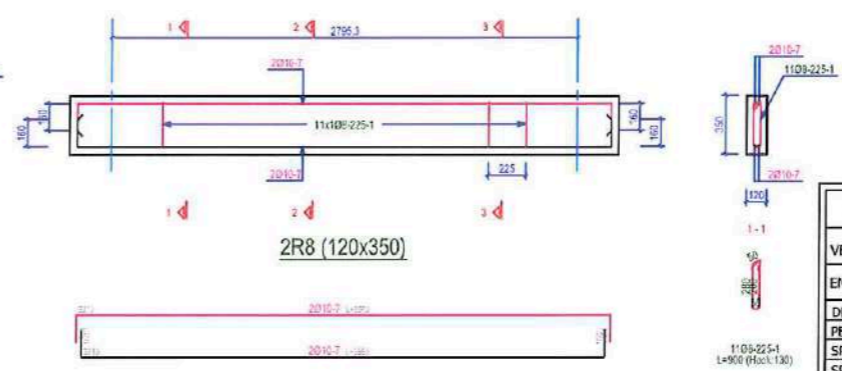
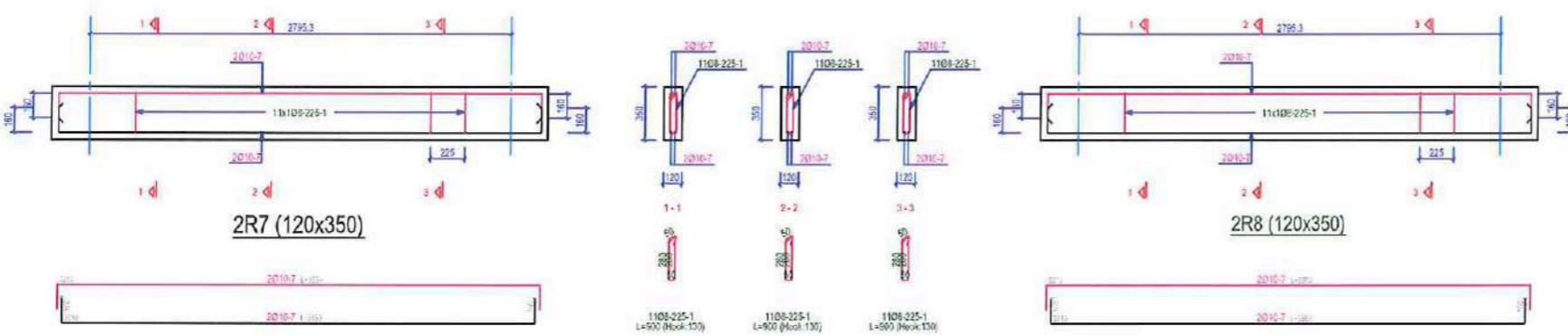
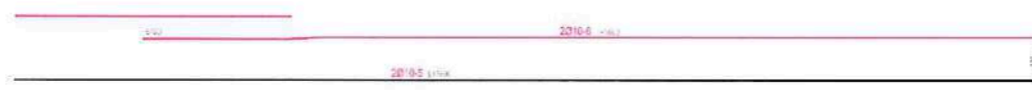
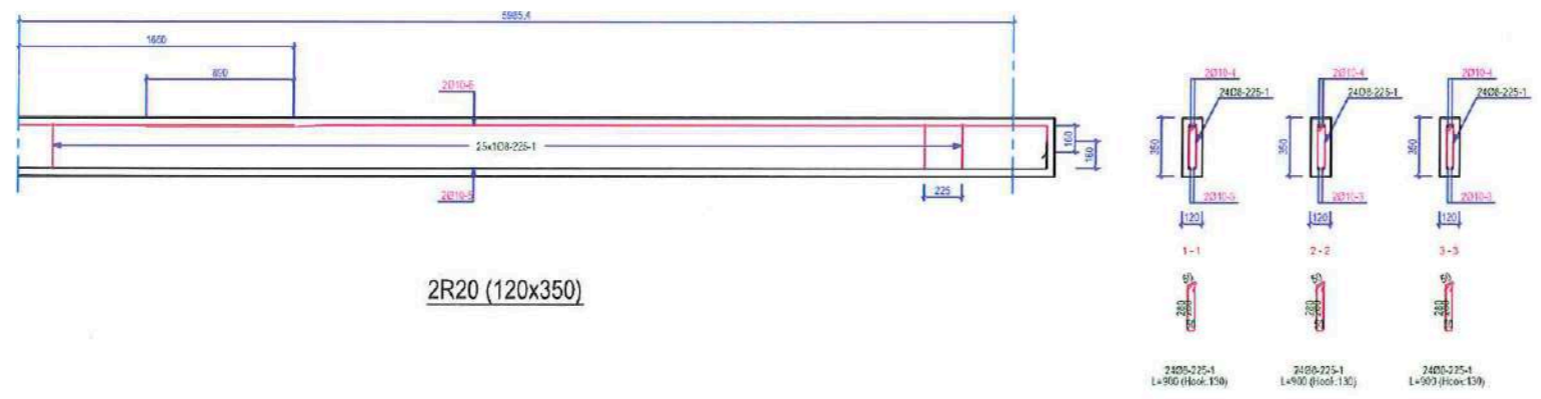
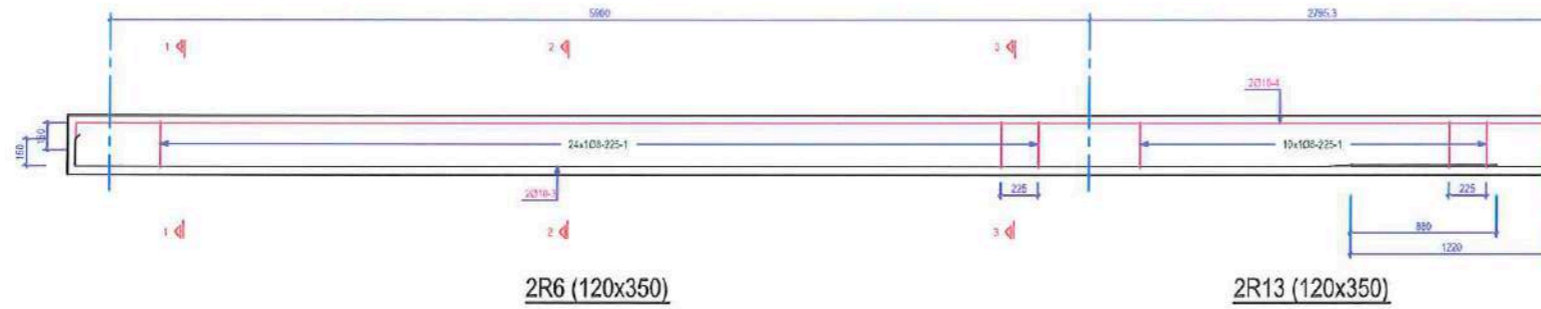

Scale: 1/120

OBJEKTI	RINDERTIMI I SHKOLLËS 9-VJEÇARE "HYSEN XHEKA"	NR.FLETES	A-05
VENDNDODHJA	KARBUNARE	FORMATI	420x297
EMERT.I FLETES	DETAJ I ARMIMIT TE TRAVETES NE SOLETEN E K. PERDHE	SHKALLA	1:500
DREJTOR	ING. MIMOZA HAXHIU		
PERGJEGJES	ARK. SAJMIR MEBELLI		
SPECIALIST	ARK. OKSANA BAXHO		
SPECIALIST	ORJALD DEBINA		
SPECIALIST	ING. ARTUR SINANI		
SPECIALIST	ING. ARBEN MUCA		
SPECIALIST	ING. MALDIN CELA		
SPECIALIST	ING. KLAJDI MYZEQARI		





# DETAJ I ARMIMIT TRAVETES NE SOLETEN KATIT PERDHE

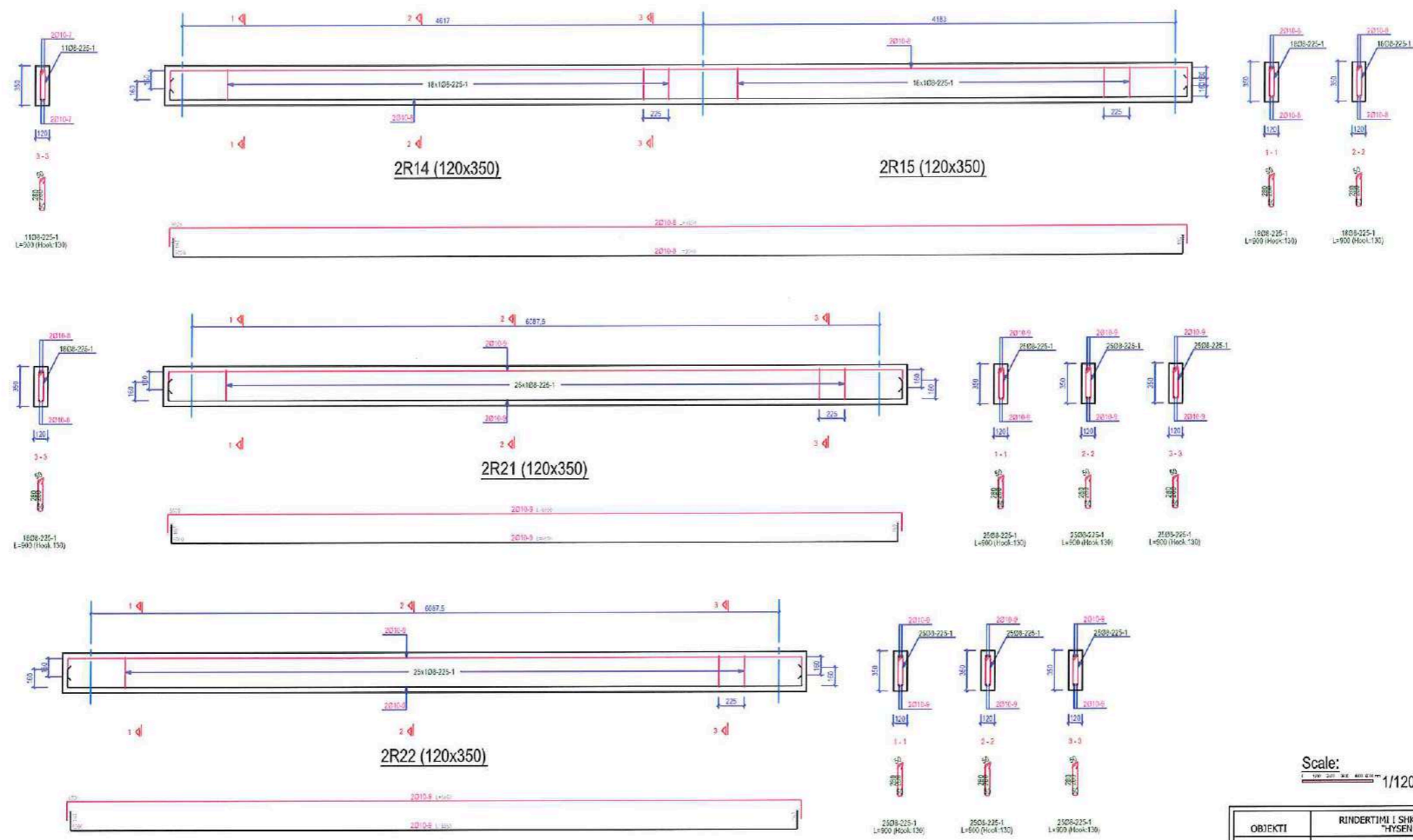

Scale: 1/120

OBJEKTI	RINDERTIMI I SHKOLLES 9-VJECARE "HYSEN XHEKA"	NR.FLETES	A-05
VENDNDODHJA	KARBUNARE	FORMATI	420x297
EMERT I FLETES	DETAJ I ARMIMIT TE TRAVETES NE SOLETEN E K PERDHE	SHKALLA	1:500
DREJTOR	ING. MIMOZA HAXHIU		
PERGJEGJES	ARK. SAJMIR MEBELLI		
SPECIALIST	ARK. OXIANA BAXHO		
SPECIALIST	ORJALD DEBINJA		
SPECIALIST	ING. ARTUR SINANI		
SPECIALIST	ING. ARBEN MUÇA		
SPECIALIST	ING. MALDIN CELA		
SPECIALIST	ING. KLAJDI MYZEQARI		



# DETAJ I ARMIMIT TRAVETES NE SOLETEN KATIT PERDHE

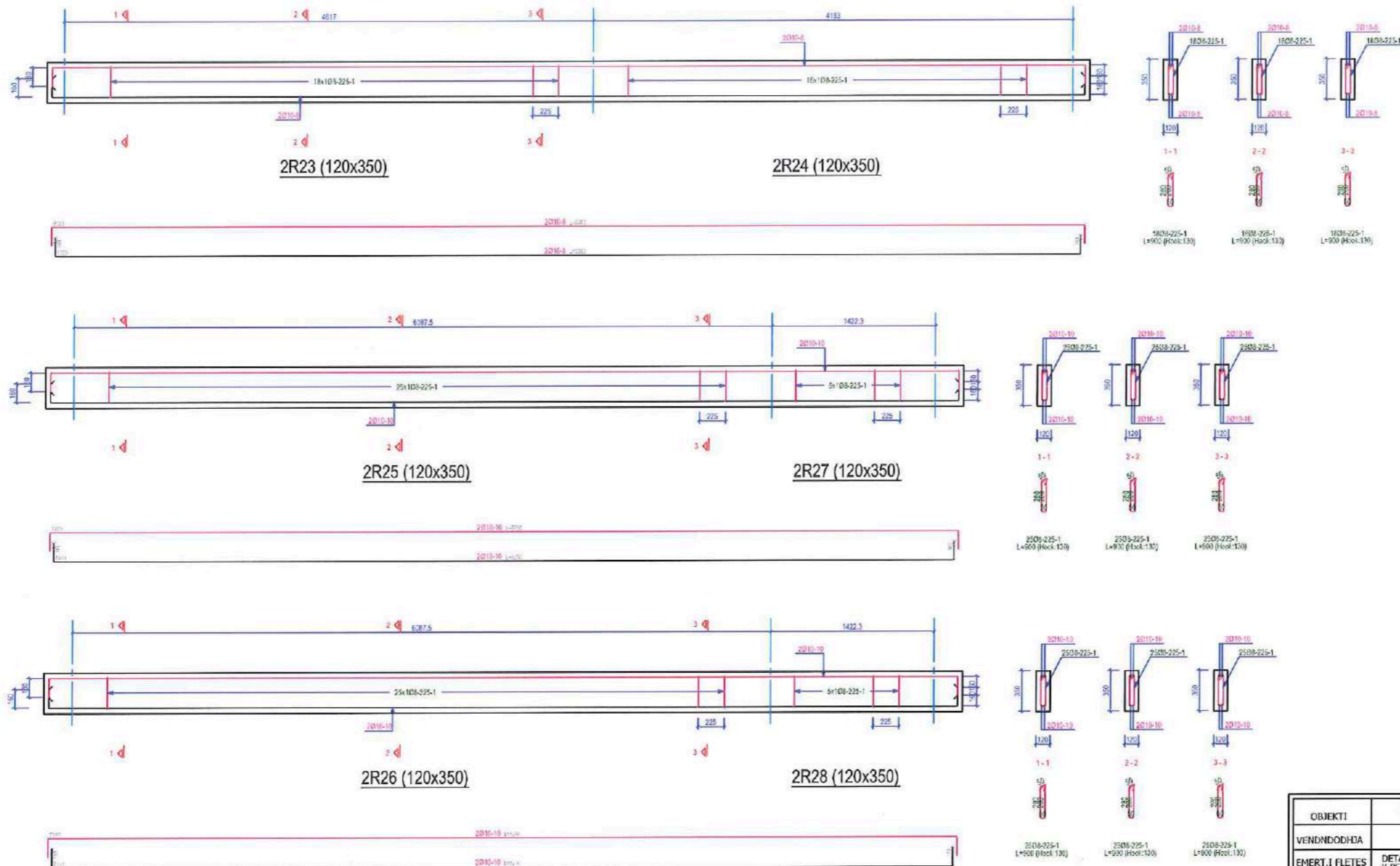

Scale: 1/120

OBJEKTI	RINDERTIMI I SHKOLLËS 9-VJECARE "HYSEN XHIEKA"	NR.FLETES	A-05
VENDNDODHJA	KARBUNARE	FORMATI	420x297
EMERT.I FLETES	DETAJ I ARMIMIT TE TRAVETES NE SOLETEN E K PERDHE	SHKALLA	1:500
DREJTOR	ING. MIMOZA HAXHIU	 REPUBLIKA E SHQIPERISE BASHKIA LUSHNJE	
PERGJEGJES	ARK. SAIMIR MEBELLY		
SPECIALIST	ARK. OKSANA BASHO		
SPECIALIST	ORJALD DEBINJA		
SPECIALIST	ING. ARTUR SIMANI		
SPECIALIST	ING. ARBEN MUCA		
SPECIALIST	ING. MALDIN CELA		
SPECIALIST	ING. KLADI MYZEQARI		



# DETAJ I ARMIMIT TRAVETES NE SOLETEN KATIT PERDHE

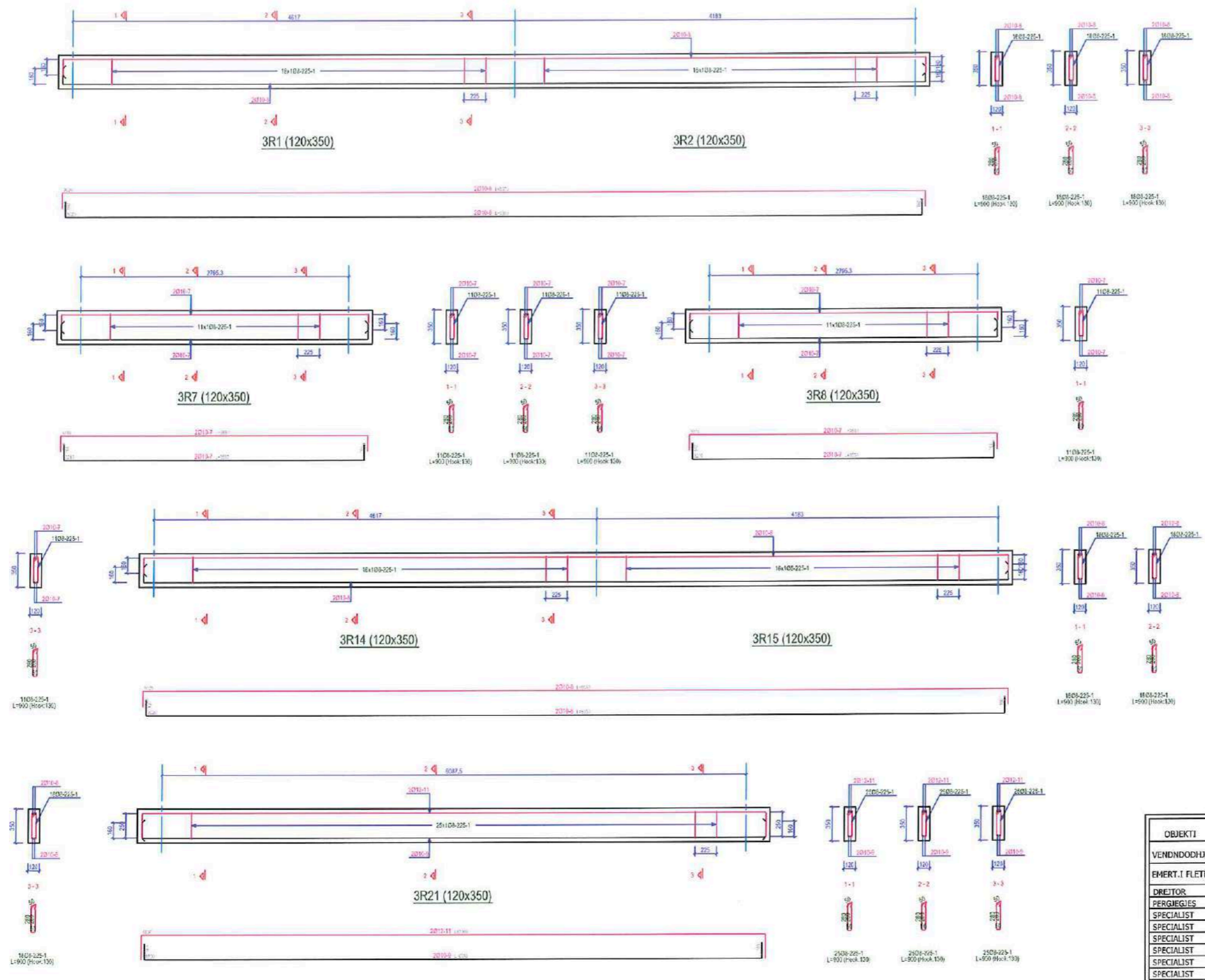

OBJEKTI	RINDERTIMI I SHKOLLES 9-VJECARE "HYSEN XHEKA"	NR.FLETES	A-05
VENDNDODHJA	KARBUNARE	FORMATI	420x297
EMERT.I FLETES	DETAJ I ARMIMIT TE TRAVETES NE SOLETEN E K PERDHE	SHKALLA	1:500
DREJTOR	ING. MIMOZA HAXHIU	 REPUBLIKA E SHQIPERISE BASHKIA LUSHNJE	
PERGJEGJES	ARK. SAIMIR MEBELLI		
SPECIALIST	ARK. OKSANA BAXHO		
SPECIALIST	ORJALD DERINJA		
SPECIALIST	ING. ARTUR SINANI		
SPECIALIST	ING. ARBEN MUCA		
SPECIALIST	ING. MALDIN CELA		
SPECIALIST	ING. KLAJDI MYZEQARI		

# DETAJ I ARMIMIT TRAVETES NE SOLETEN KATIT PERDHE

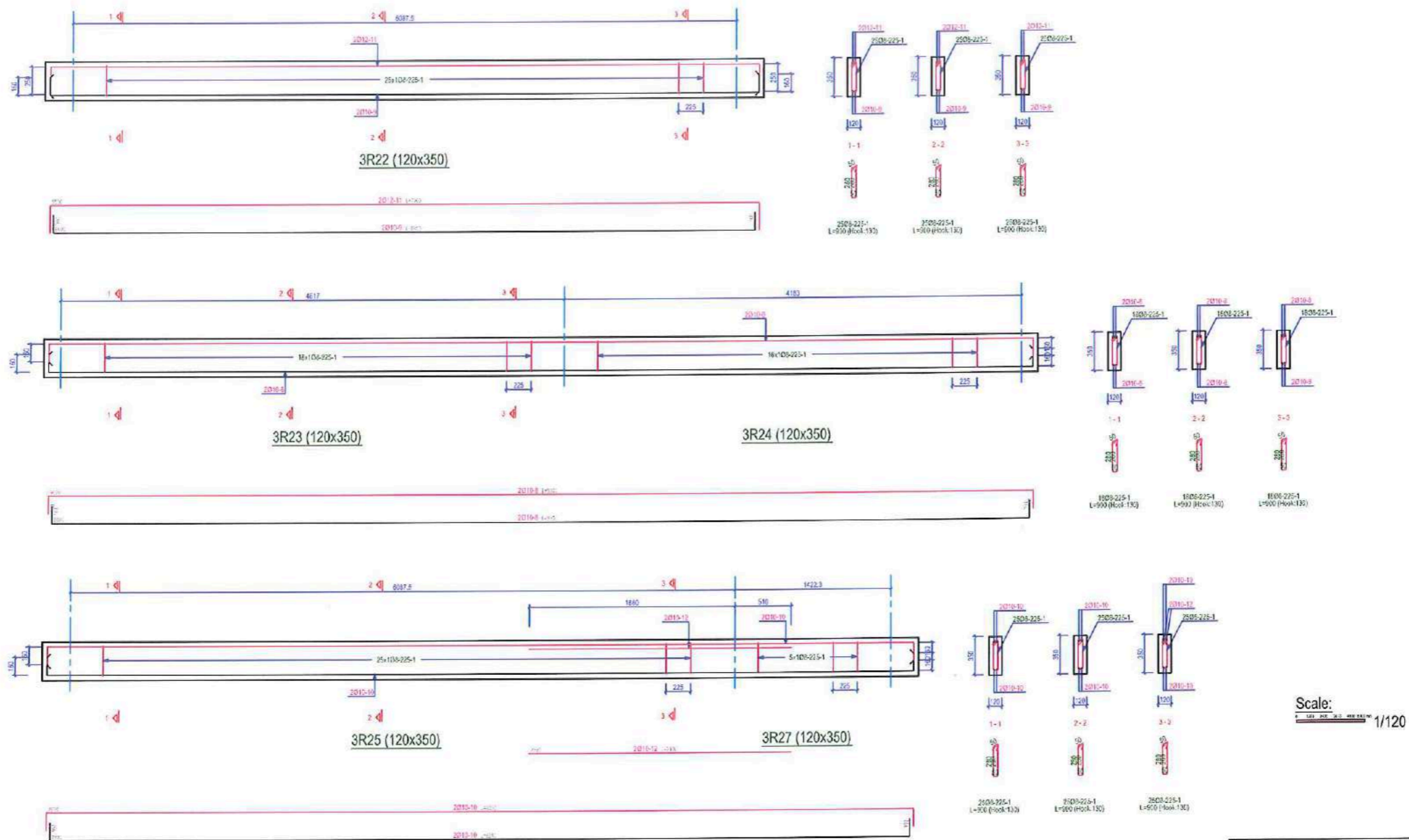

OBJEKTI	RINDERTIMI I SHKOLLES 9-VJECARE "HYSEN XHEKA"	NR. FLETES	A-05
VENDNDODHJA	KARBUNARE	FORMATI	420x297
EMERT. I FLETES	DETAJ I ARMIMIT TE TRAVETES NE SOLETEN E K. PERDHE	SHKALLA	1:500
DREJTOR	ING. MIMOZA HAXHIU	 REPUBLIKA E SHQIPERISE BASHKIA LUSHNJË	
PERGJEGJES	ARK. SAIMIR MEBELLY		
SPECIALIST	ARK. OKSANA BAXHO		
SPECIALIST	ORJALD DEBINJA		
SPECIALIST	ING. ARTUR SINANI		
SPECIALIST	ING. ARBEN MUCA		
SPECIALIST	ING. MALDIN CELA		
SPECIALIST	ING. KLAJDI MYZEQARI		





# DETAJ I ARMIMIT TRAVETES NE SOLETEN KATIT PERDHE

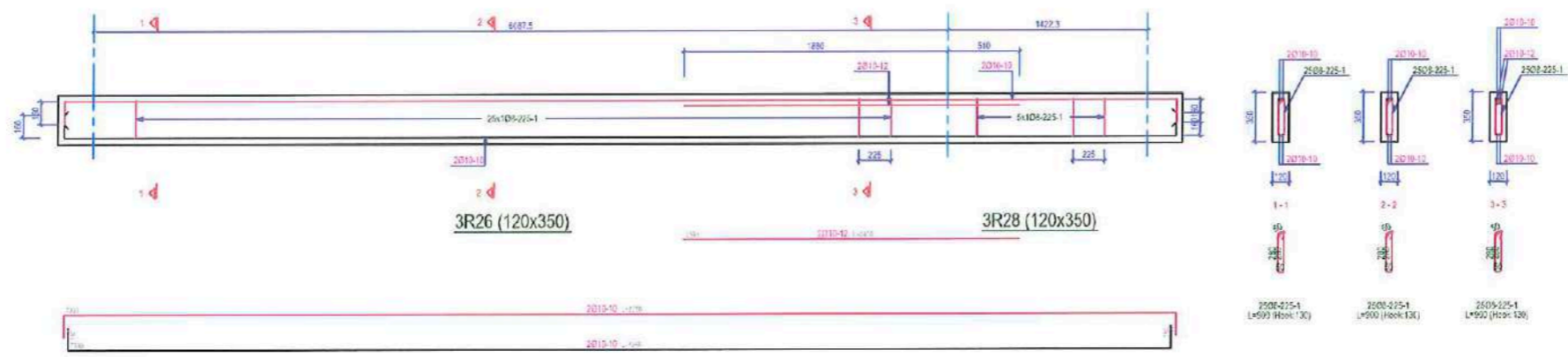

Quantity Table							
NO	SIZE	DIA	LENGTH (mm)	FORM	TOTAL LENGTH (m)		
					Ø8	Ø10	Ø12
1	8	747	900		672.30		
2	10	4	5250			21.00	
3	10	10	8750			37.50	
4	10	10	10750			107.50	
5	10	10	7600			76.00	
6	10	10	5600			56.00	
7	10	10	3500			35.00	
8	10	20	5100			187.00	
9	10	12	6800			82.20	
10	10	15	8100			132.00	
11	12	4	7000				28.00
12	10	4	2400			9.60	
TOTAL LENGTH (m)					672.30	815.60	28.00
UNIT WEIGHT (kg/m)					0.40	0.62	0.59
WEIGHT (kg)					269.6	503.5	24.9
T.WEIGHT (kg)					798.0		

Scale: 1/120

OBJEKTI	RINDERTIMI I SHKOLLËS 9-VJEÇARE "HYSEN XHIEKA"	NR.FLETES	A-05
VEPNDODHJA	KARBUNARE	FORMATI	420x297
EMERT.I FLETES	DETAJ I ARMIMIT TE TRAVETES NE SOLETEN E K.PERDHE	SHKALLA	1:500
DREJTOR	ING. MIMOZA HAXHIU		
PERGJEGJES	ARK. SAIMIR MEBELLI		
SPECIALIST	ARK. OKSANA BASHO		
SPECIALIST	ORJALD DEBINJA		
SPECIALIST	ING. ARTUR SINANI		
SPECIALIST	ING. ARBEN MUCA		
SPECIALIST	ING. MALDIN CELA		
SPECIALIST	ING. KLAJDI MYZEQARI		

# DETAJ I ARMIMIT TRAREVE THEMELEVE

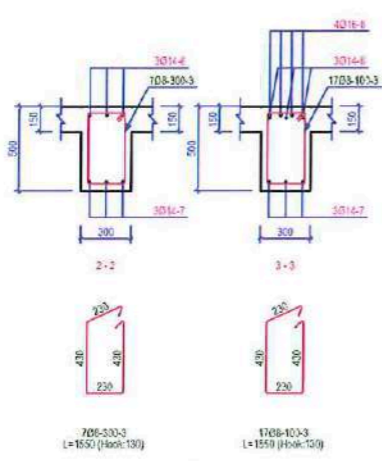
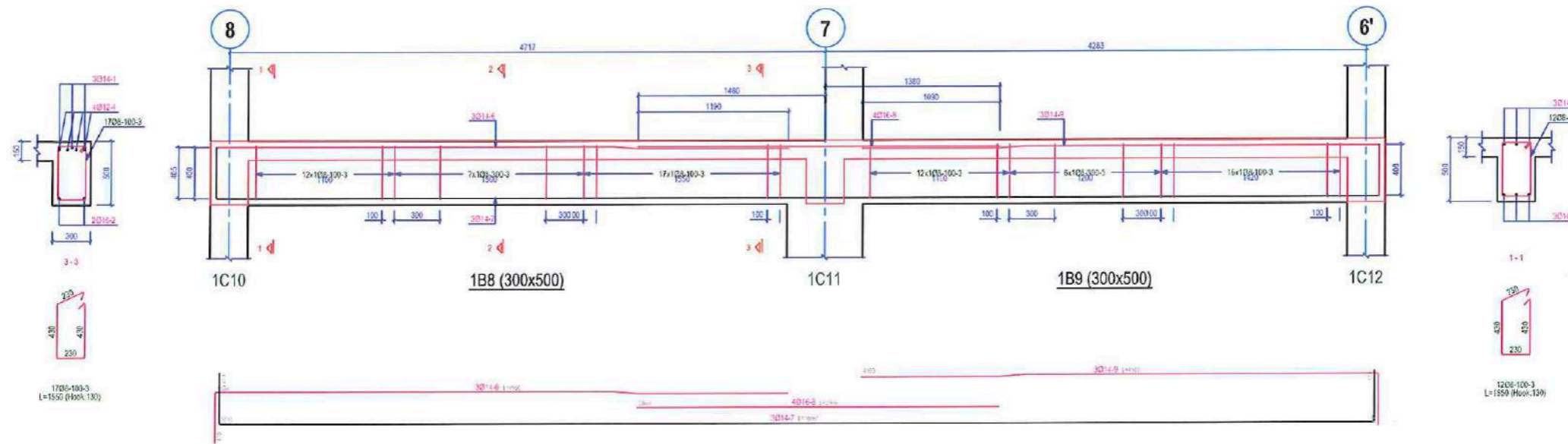
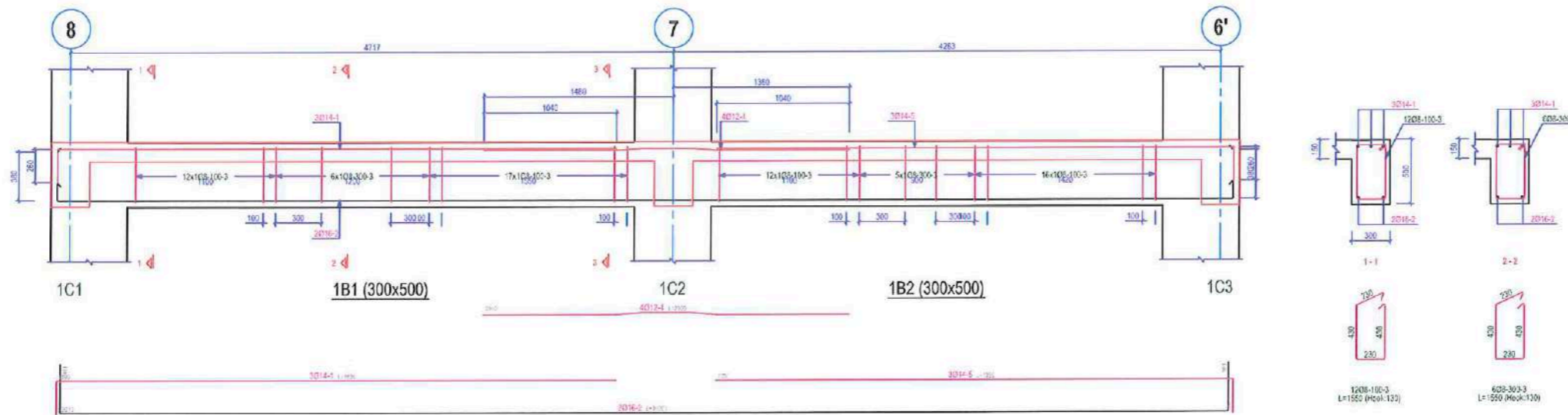

BEAM ELEVATIONS QUANTITY TAKE OFF - STOREYS - 1			
SIZE	UNIT WEIGHT (Kg/m)	LENGTH (m)	T.WEIGHT (Kg)
Ø8	0.46	213.9	84.5
Ø12	0.89	11.6	10.3
Ø14	1.21	65.5	80.4
Ø16	1.58	31.6	49.9
T.WEIGHT (Kg)			245.2

NO	SIZE	QUA	LENGTH (mm)	TOTAL	FORM
1	14	3	4650	13.95	14
2	16	2	10000	20.00	16
3	8	135	1550	213.90	8
4	12	4	2900	11.60	12
5	14	3	4350	13.05	14
6	14	3	4950	14.85	14
7	14	3	10050	30.15	14
8	16	4	2300	11.50	16
9	14	3	4500	13.95	14

BEAM ELEVATIONS1 Scale: 1:500

OBJEKTI	RINDERTIMI I SHKOLLES 9-VJECARE "HYSEN XHEKA"	NR.FLETES	A-05
VENDNDODHJA	KARBUNARE	FORMATI	420X297
EMERT.I FLETES	DETAJ I ARMIMIT TE TRAREVE TE THEMELEVE	SHKALLA	1:500
DREJTOR	ING. MIMOZA HAXHILU	<p>REPUBLIKA E SHQIPËRIE BASHKIA LUSHNJË</p>	
PERQJEGJES	ARK. SAIMIR MEBELI		
SPECIALIST	ARK. OKSANA BAXHO		
SPECIALIST	ORJALD DEBINJA		
SPECIALIST	ING. ARTUR SINANI		
SPECIALIST	ING. ARBEN MUCA		
SPECIALIST	ING. MALDIN CELA		
SPECIALIST	ING. KLAJDI MYZEQARI		





# DETAJ I ARMIMIT TRAREVE THEMELEVE

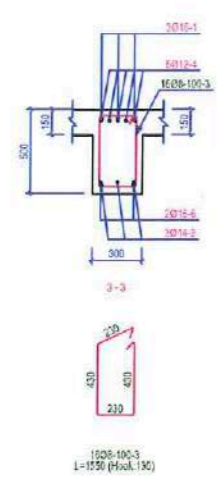
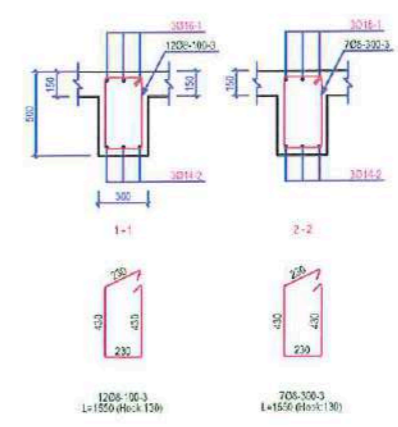
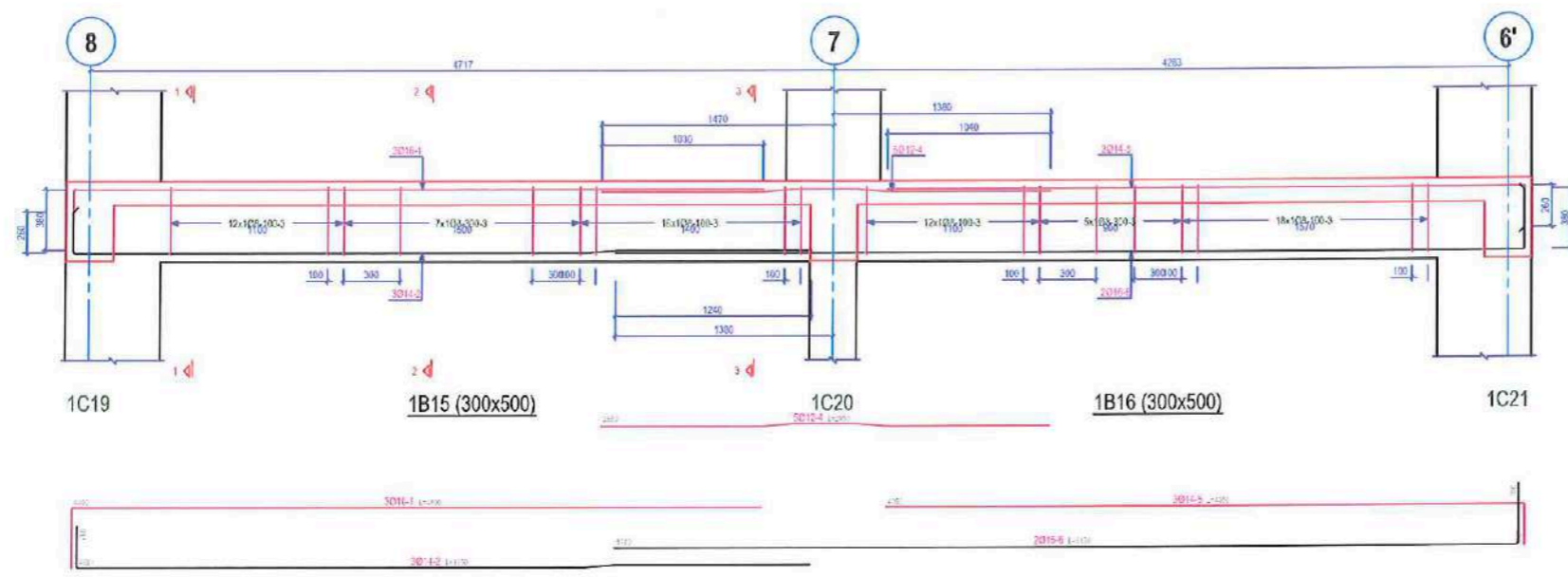

SIZE	UNIT WEIGHT (kg/m)	LENGTH (m)	T.WEIGHT (kg)
Ø8	0.40	105.5	42.2
Ø12	0.89	14.3	12.7
Ø14	1.21	27.9	33.8
Ø16	1.58	26.7	42.2
T.WEIGHT (kg)			131.5

NO	SIZE	QUA	LENGTH (m)	TOTAL	FORU
1	16	3	4900	14.40	16
2	14	3	4950	14.85	16
3	8	70	1550	108.50	16
4	12	5	2850	14.25	16
5	14	3	4350	13.05	16
6	16	2	6150	12.30	16

OBJEKTI	RINDERTIMI I SHKOLLES 9-VJECARE "HYSEN XHEKA"	NR.FLETES	A-05
VENDNDODHJA	KARBUNARE	FORMATI	420x297
EMERT.I FLETES	DETAJ I ARMIMIT TE TRAREVE TE THEMELEVE	SHKALLA	1:500
DREJTOR	ING. MIMOZA HAXHIIU		
PERGJEGJES			
SPECIALIST	ARK. OKSANA BASHO		
SPECIALIST	ORJALD DEBINJA		
SPECIALIST	ING. ARTUR SINANI		
SPECIALIST	ING. ARBEN MUCA		
SPECIALIST	ING. MALDIN CELA		
SPECIALIST	ING. KLAJDI MYZEQARI		

# DETAJ I ARMIMIT TRAREVE THEMELEVE

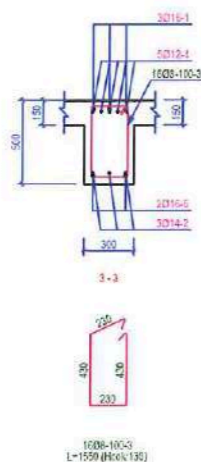
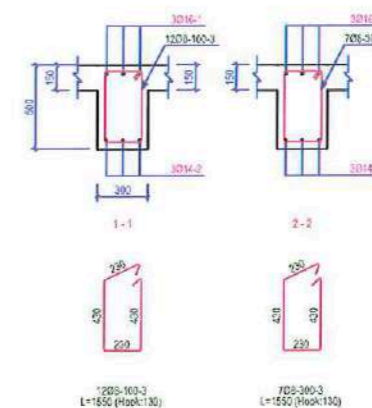
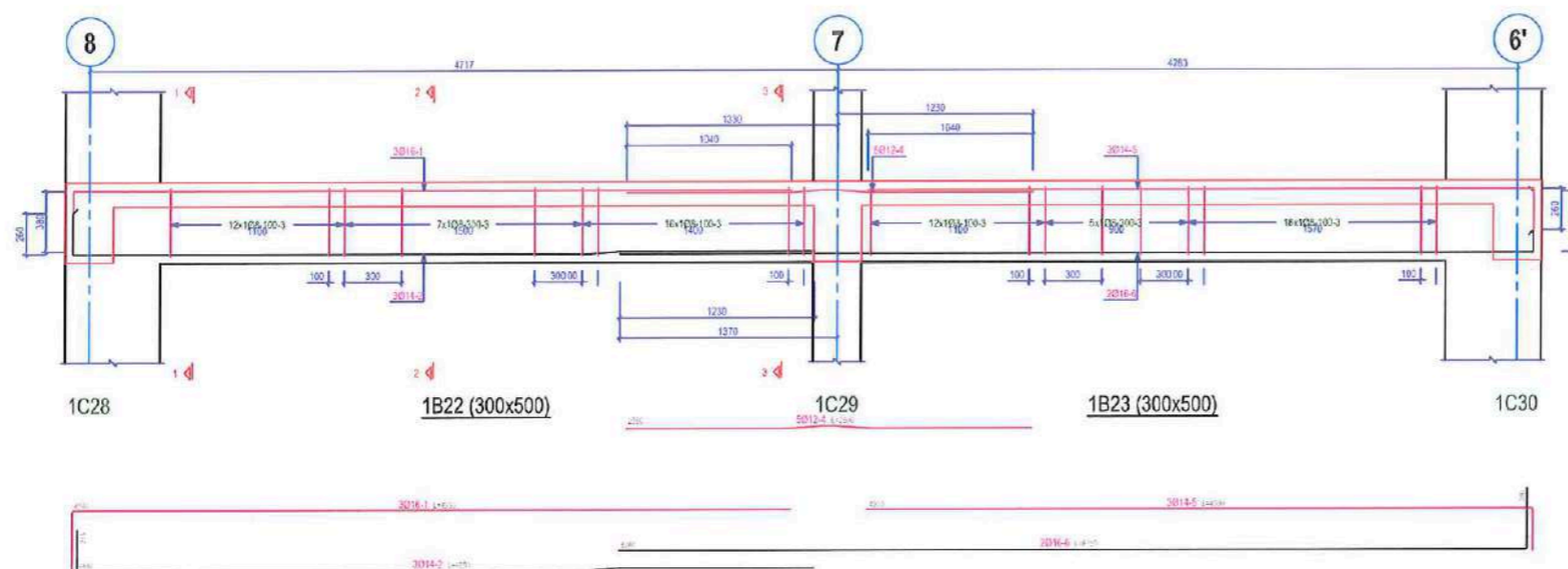

BEAM ELEVATIONS QUANTITY TAKE OFF - STOREYS - 1

SIZE	UNIT WEIGHT (Kg/m)	LENGTH (m)	T.WEIGHT (Kg)
Ø8	0.40	104.5	42.9
Ø12	0.80	13.0	11.6
Ø14	1.21	28.4	34.3
Ø16	1.58	27.2	42.9
T.WEIGHT (Kg)			131.6

NO	SIZE	QUA	LENGTH (mm)	TOTAL	FORM
1	16	3	4500	14.55	Ø16
2	14	3	4500	14.55	Ø14
3	8	70	1650	105.50	Ø8
4	12	5	2600	13.00	Ø12
5	14	3	4500	13.50	Ø14
6	16	2	6150	12.30	Ø16

Scale: 1/120

OBJEKTI	RINDERTIMI I SHKOLLËS 9-VJEÇARE "HYSEN XHEKA"	NR.FLETES	A-05
VENDNDODHJA	KARBUNARE	FORMATI	420X297
EMERT.I FLETES	DETAJ I ARMIMIT TE TRAREVE TE THEMELEVE	SHKALLA	1:500
DREJTOR	ING. MIMOZA HAXHIU		
PERGJEGJES			
SPECIALIST	ARK. OKSANA BAXHO		
SPECIALIST	ORJALD DEBINJA		
SPECIALIST	ING. ARTUR SINANI		
SPECIALIST	ING. ARBEN MUJA		
SPECIALIST	ING. MALDIN CELA		
SPECIALIST	ING. KLAJDI MYZEQARI		



# DETAJ I ARMIMIT TRAREVE THEMELEVE

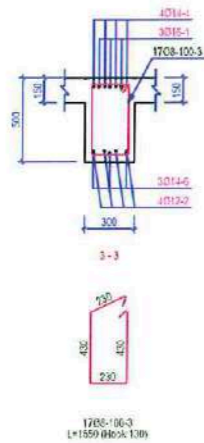
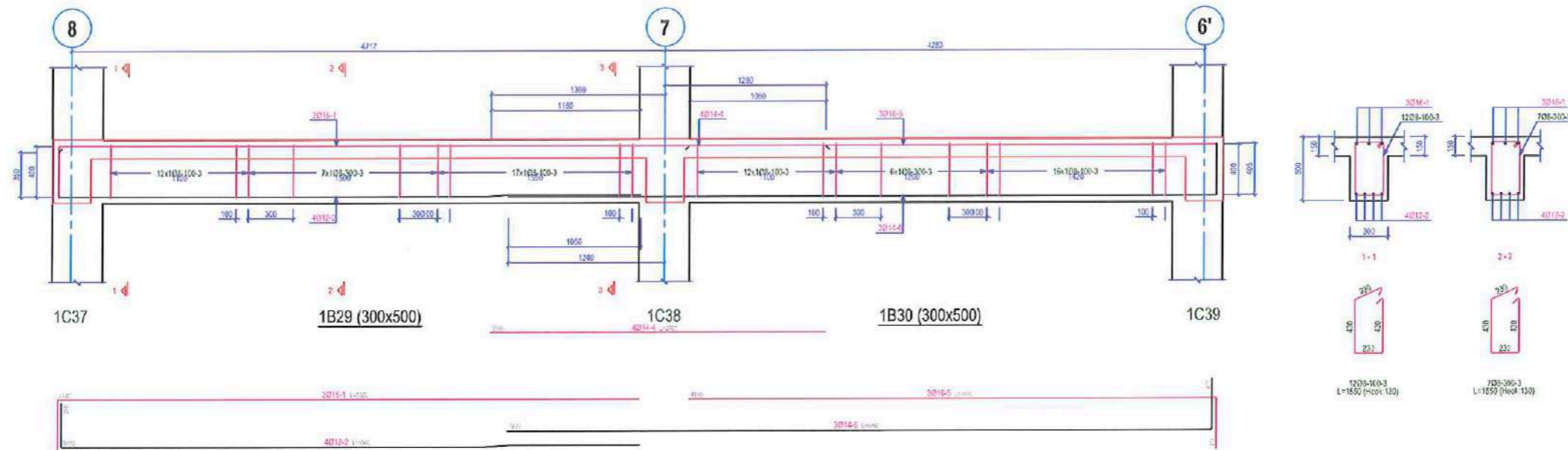

BEAM ELEVATIONS QUANTITY TAKE OFF - STOREYS - 1					
SIZE	UNIT WEIGHT (kg/m)	LENGTH (m)	T.WEIGHT (Kg)		
Ø8	0.40	168.5	42.9		
Ø12	0.89	23.0	17.8		
Ø14	1.21	29.0	35.0		
Ø16	1.58	28.0	45.7		
T.WEIGHT (kg)			141.4		
NO	SIZE	QUA	LENGTH (m)	TOTAL	FORM
1	16	3	5950	15.15	16
2	12	4	5900	20.03	16
3	8	70	1550	106.50	16
4	14	4	2700	10.80	16
5	16	3	4600	13.03	16
6	14	3	6950	16.15	16

BEAM ELEVATIONS1  
Scale: 1/120

OBJEKTI	RINDERTIMI I SHKOLLËS 9-VJECARE "HYSEN XHEKA"	NR.FLETES	A-05
VENDNDODHJA	KARBUNARE	FORMATI	420X297
EMERT.I FLETES	DETAJ I ARMIMIT TE TRAREVE TE THEMELEVE	SHKALLA	1:500
DREJTOR	ING. MIMOZA HAXHIU	 REPUBLIKA E SHQIPËRISE BASHKIA E LUSHNËS	
PERGJEGJES			
SPECIALIST	ARK. OKSANA BASHO		
SPECIALIST	ORJALD DEBINA		
SPECIALIST	ING. ARTUR SINANI		
SPECIALIST	ING. ARBEN MUCA		
SPECIALIST	ING. MALDIN CELA		
SPECIALIST	ING. KLAJDI MYZEQARI		

# DETAJ I ARMIMIT TRAREVE THEMELEVE

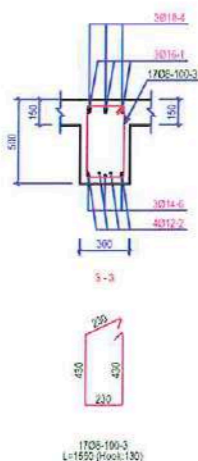
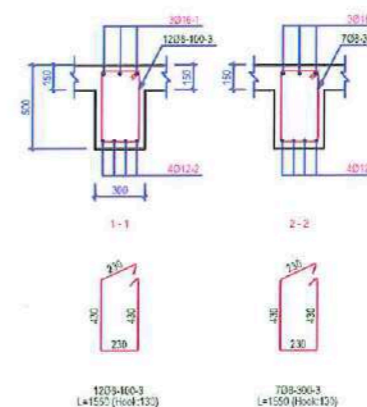
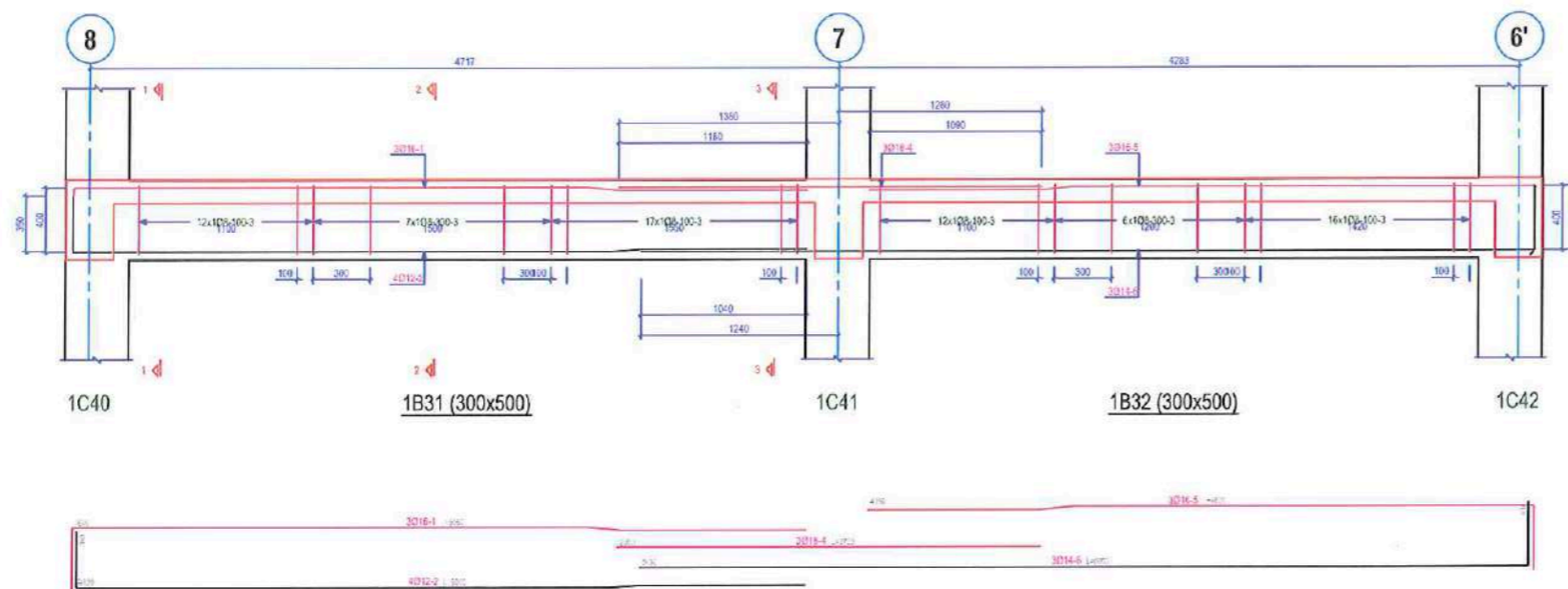

BEAM ELEVATIONS QUANTITY TAKE OFF - STOREYS - 1

SIZE	UNIT WEIGHT (kg/m)	LENGTH (m)	T.WEIGHT (kg)
Ø8	0.40	308.5	123.4
Ø12	0.89	20.0	17.8
Ø14	1.21	18.2	22.0
Ø16	1.58	29.0	45.7
Ø18	2.00	8.1	16.2
T.WEIGHT (kg)			145.1

NO	SIZE	QJA	LENGTH (m)	TOTAL	FORM
1	16	3	5650	15.15	
2	12	4	5000	20.00	
3	8	70	1550	106.50	
4	18	3	2790	8.10	
5	16	3	4600	13.80	
6	14	3	6050	18.15	

BEAM ELEVATIONS1

Scale: 1/120

OBJEKTI	RINDERTIMI I SHKOLLËS 9-VJECARE "HYSEN XHEKA"	NR.FLETES	A-05
VENDNDODHJA	KARBUNARE	FORMATI	420X297
EMERT.I FLETES	DETAJ I ARMIMIT TE TRAREVE TE THEMELEVE	SHKALLA	1:500
DREJTOR	ING. MIMOZA HAXHIU		
PERGJEGJES			
SPECIALIST	ARK. OKSANA BAXHO		
SPECIALIST	ORJALD DEBINJA		
SPECIALIST	ING. ARTUR SINANI		
SPECIALIST	ING. ARBEY MUCA		
SPECIALIST	ING. MALDIN CELA	REPUBLICA E SHQIPËRIE BASHKIA LUSHNJË	
SPECIALIST	ING. KLAJDI NYZEQARI		



# DETAJ I ARMIMIT TRAREVE THEMELEVE

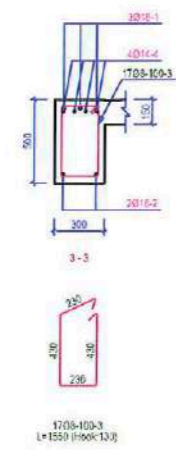
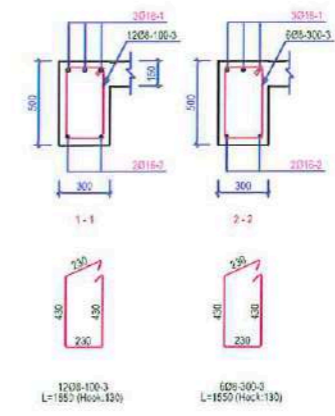
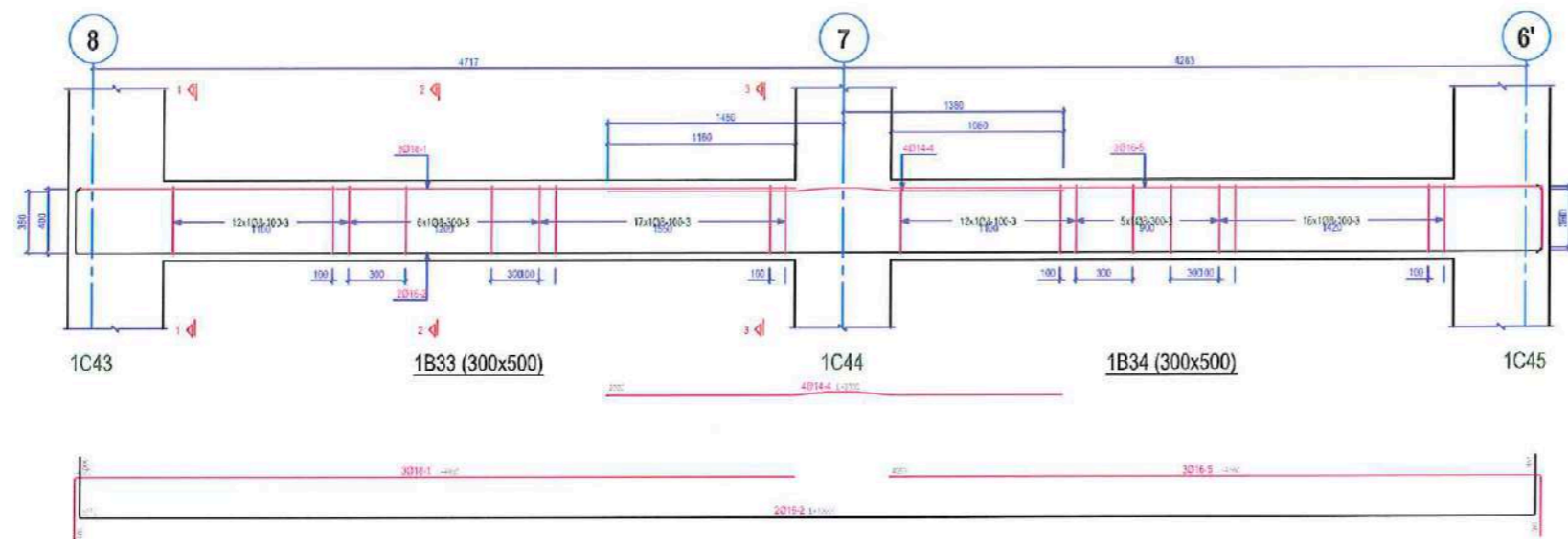

BEAM ELEVATIONS QUANTITY TAKE OFF - STOREYS - 1			
SIZE	UNIT WEIGHT (Kg/m)	LENGTH (m)	T.WEIGHT (Kg)
Ø8	0.40	195.4	41.8
Ø14	1.21	11.6	14.0
Ø16	1.58	33.5	52.9
Ø18	2.00	14.9	29.7
T.WEIGHT (Kg)			138.3

NO	SIZE	QUA	LENGTH (mm)	TOTAL	FORM
1	18	3	4950	14.85	Ø18
2	16	2	10000	20.00	Ø16
3	8	68	1550	105.40	Ø8
4	14	4	2900	11.60	Ø14
5	16	3	4500	13.50	Ø16

Scale: 1/120  
BEAM ELEVATIONS1

OBJEKTI	RINDERTIMI I SHKOLLES 9-VJECARE "HYSEN XHEKA"	NR.FLETES	A-05
VENDNDODHJA	KARBUNARE	FORMATI	420X297
EMERT.I FLETES	DETAJ I ARMIMIT TE TRAREVE TE THEMELEVE	SHKALLA	1:500
DREJTOR	ING. MIMOZA HAXHIU	 REPUBLIKA E SHQIPËRISE BASHKIA LUSHINJE	
PERGJEGJES			
SPECIALIST	ARK. OKSANA BAXHO		
SPECIALIST	ORJALO DEBINJA		
SPECIALIST	ING. ARTUR SINANI		
SPECIALIST	ING. ARBEN MUCA		
SPECIALIST	ING. MALDIN CELA		
SPECIALIST	ING. KLAJDI MYZEQARI		



## DETAJ I ARMIMIT TRAREVE THEMELEVE

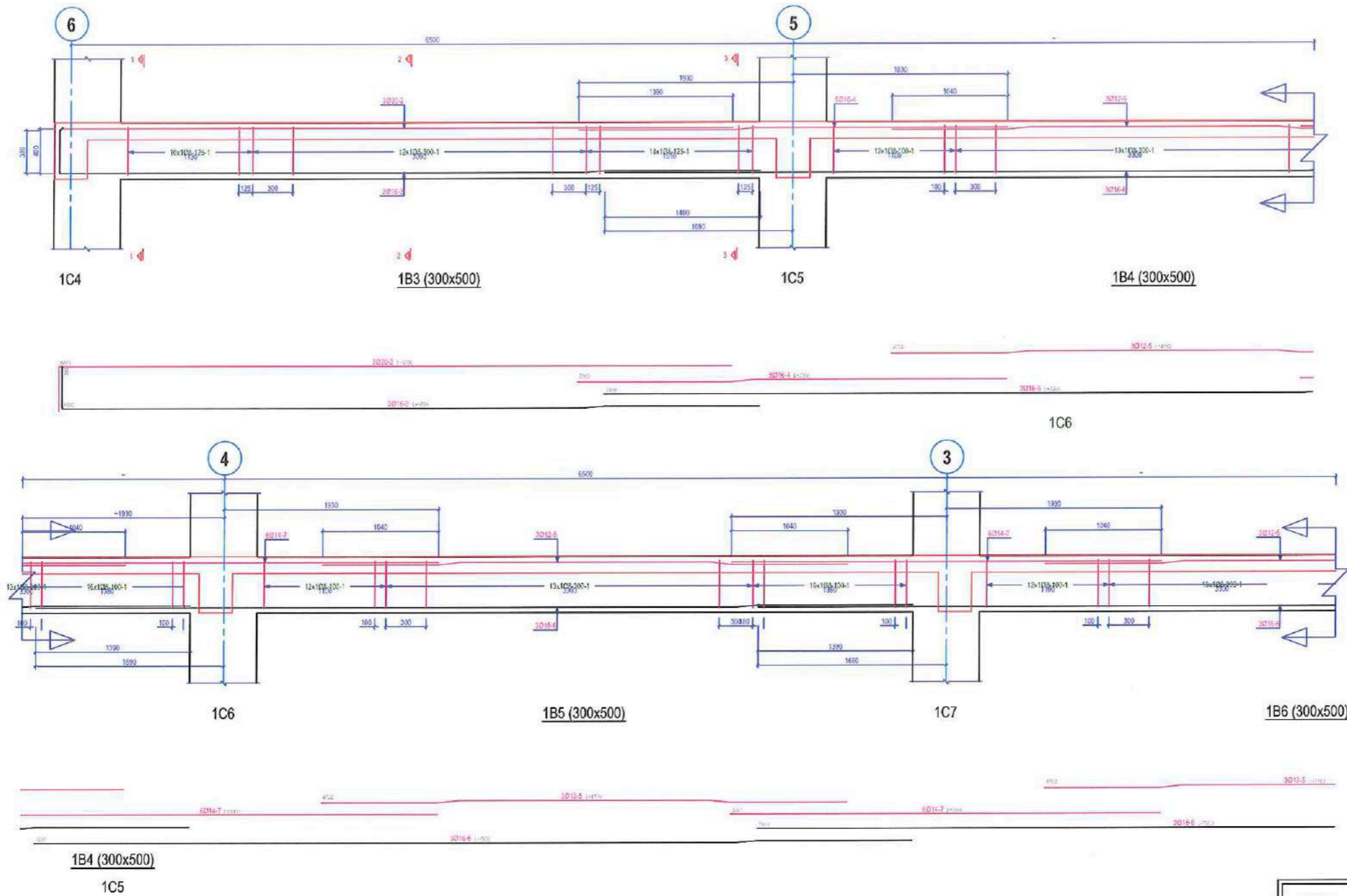

OBJEKTI	RINDERTIMI I SHKOLLËS 9-VJECARE "HYSEN XHEKA"	NR. FLETES	A-05
VENDNDODHJA	KARBUNARE	FORMATI	420X297
EMERT. I FLETES	DETAJ I ARMIMIT TE TRAREVE TE THEMELEVE	SHKALLA	1:500
DREJTOR	ING. MIMOZA HAXHIU	 REPUBLIKA E SHQIPËRISE BASHKIA E LUSHNJË	
PERGJEGJES			
SPECIALIST	ARK. OKSANA BAXHO		
SPECIALIST	ORJALD DEBINJA		
SPECIALIST	ING. ARTUR SINANI		
SPECIALIST	ING. ARBEN MUCA		
SPECIALIST	ING. MALDIN CELA		
SPECIALIST	ING. KLAJDI MYZEQARI		



# DETAJ I ARMIMIT TRAREVE THEMELEVE

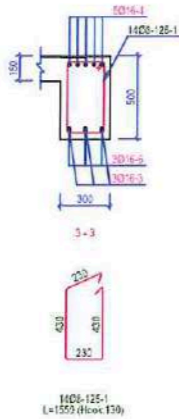
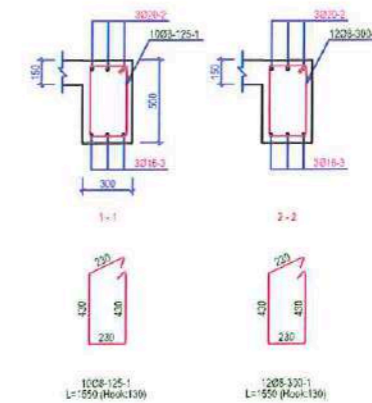
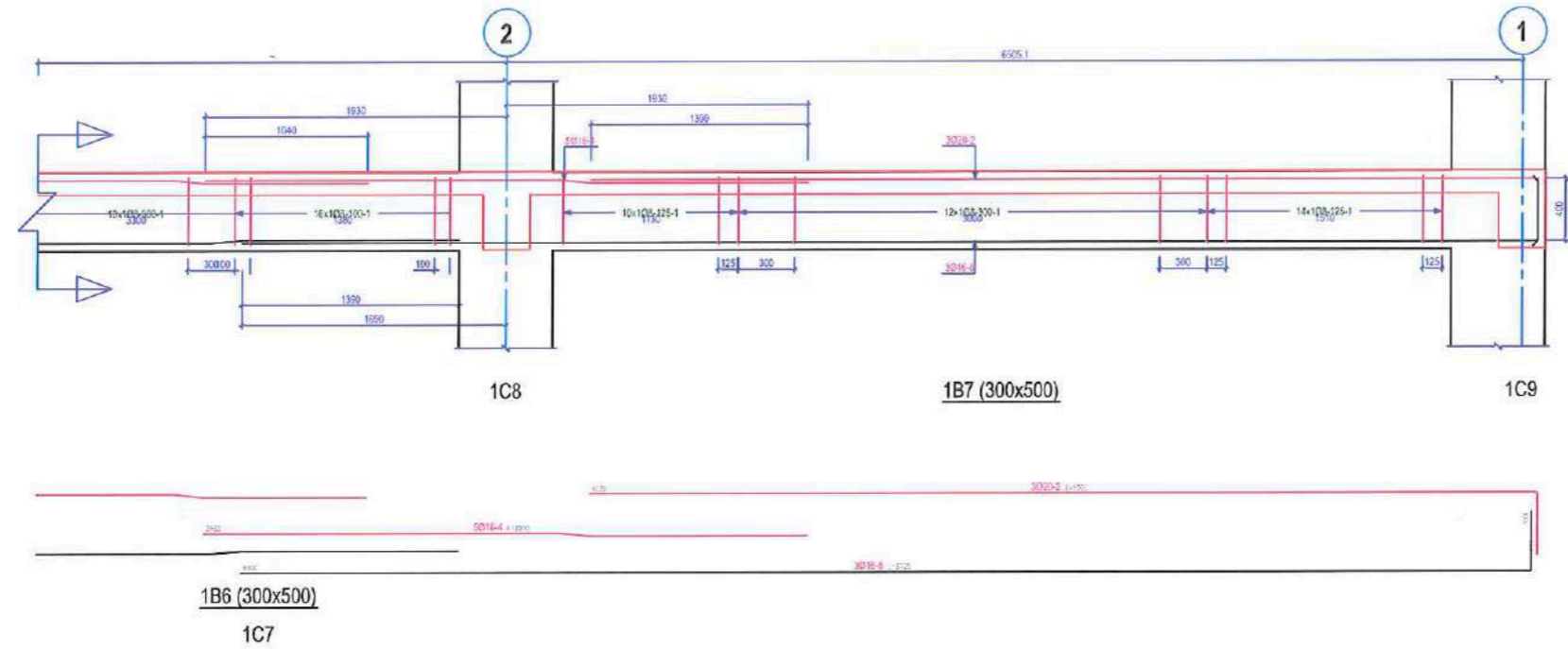

Quantity Table						TOTAL LENGTH (m)				
NO	S/E	QUA	LENGTH (mm)	FORM						
					Ø8	Ø12	Ø14	Ø16	Ø20	
1	8	150	1500	□	302.25					
2	20	6	6500	□					39.00	
3	16	3	6700	□				20.10		
4	16	10	3500	□				35.00		
5	12	9	4700	□		42.75				
6	16	9	7500	□				71.10		
7	14	12	3500	□				46.80		
8	16	3	8700	□				25.10		
TOTAL LENGTH (m)					302.25	42.75	46.80	166.30	39.00	
UNIT WEIGHT (kg/m)					0.40	0.69	1.21	1.58	2.47	
WEIGHT (kg)					119.4	38.0	56.6	247.6	96.3	
T.WEIGHT (kg)					557.3					

BEAM ELEVATIONS1

Scale: 1/120

OBJEKTI	RINDERTIMI I SHKOLLËS 9-VJECARE "HYSEN XHEKA"	NR.FLETES	A-05
VENDNDODHJA	KARBUNARE	FORMATI	420X297
EMERT.I FLETES	DETAJ I ARMIMIT TE TRAREVE TE THEMELEVE	SHKALLA	1:500
DREJTOR	ING. MIMOZA HAXHILU		
PERGJEGJES			
SPECIALIST	ARK. OKSANA BAXHO		
SPECIALIST	ORJALD DEBINJA		
SPECIALIST	ING. ARTUR SINANI		
SPECIALIST	ING. ARBEN MUCA		
SPECIALIST	ING. MALDIN CELA	REPUBLIKA E SHQIPERISE BASHKIA LUSHNJE	
SPECIALIST	ING. KLAJDI MYZEQARI		

## DETAJ I ARMIMIT TRAREVE THEMELEVE

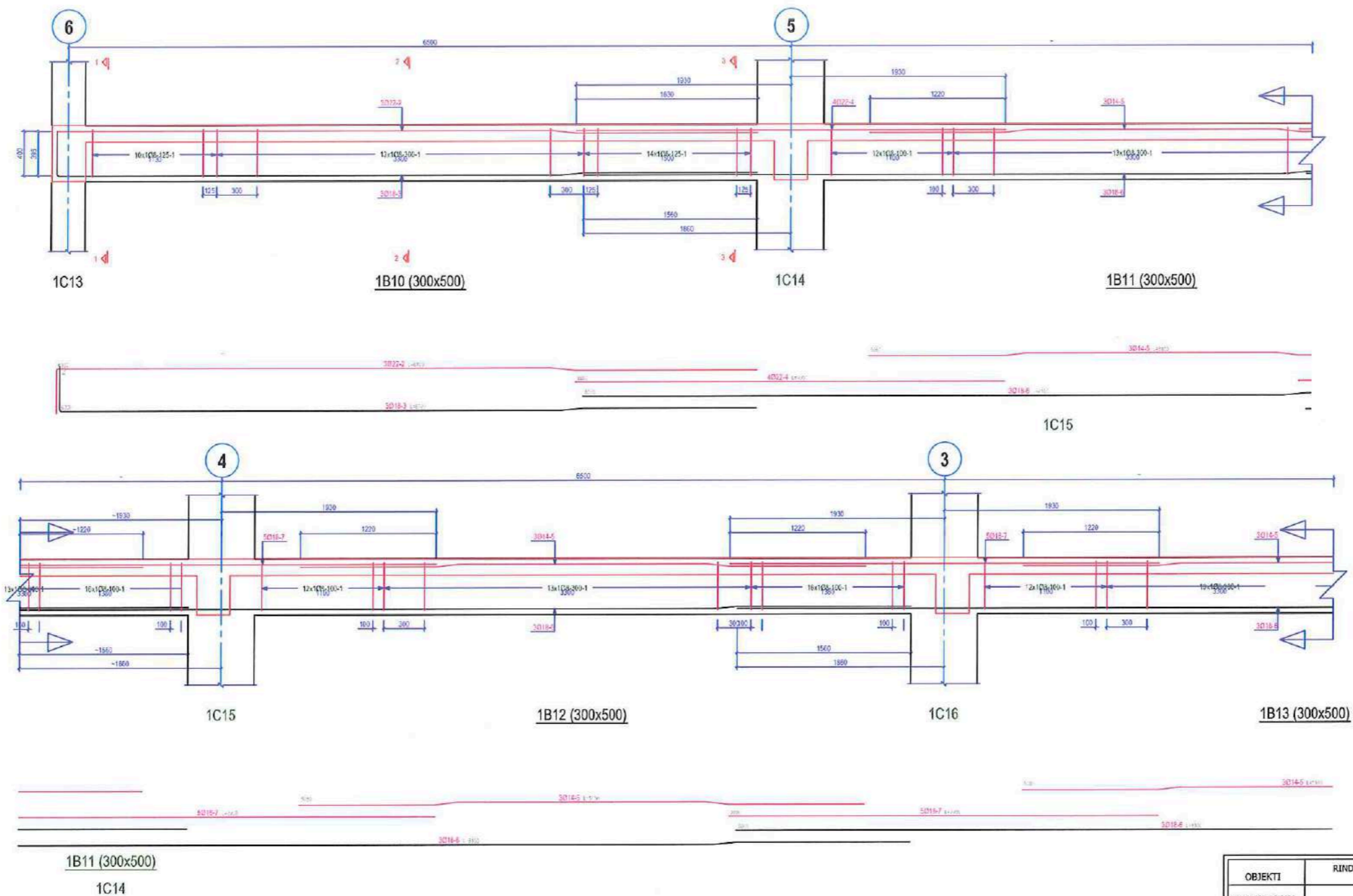

OBJEKTI	RINDERTIMI I SHKOLLËS 9-VJECARE "HYSEN XHEKA"	NR.FLETES	A-05
VENDNDODHJA	KARBUNARE	FORMATI	420x297
EMERT.I FLETES	DETAJ I ARMIMIT TE TRAREVE TE THEMELEVE	SHKALLA	1:500
DREJTOR	ING. MIMOZA HAXHIU	 REPUBLIKA E SHQIPËRISE BASHKIA LUSHNJË	
PERGJEGJES			
SPECIALIST	ARK. OKSANA BAXHO		
SPECIALIST	ORJALD DEBINJA		
SPECIALIST	ING. ARTUR SINANI		
SPECIALIST	ING. ARBEN MUJA		
SPECIALIST	ING. MALDIN CELA		
SPECIALIST	ING. KLAJDI MYZEQARI		





# DETAJ I ARMIMIT TRAREVE THEMELEVE

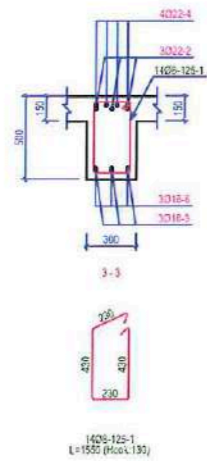
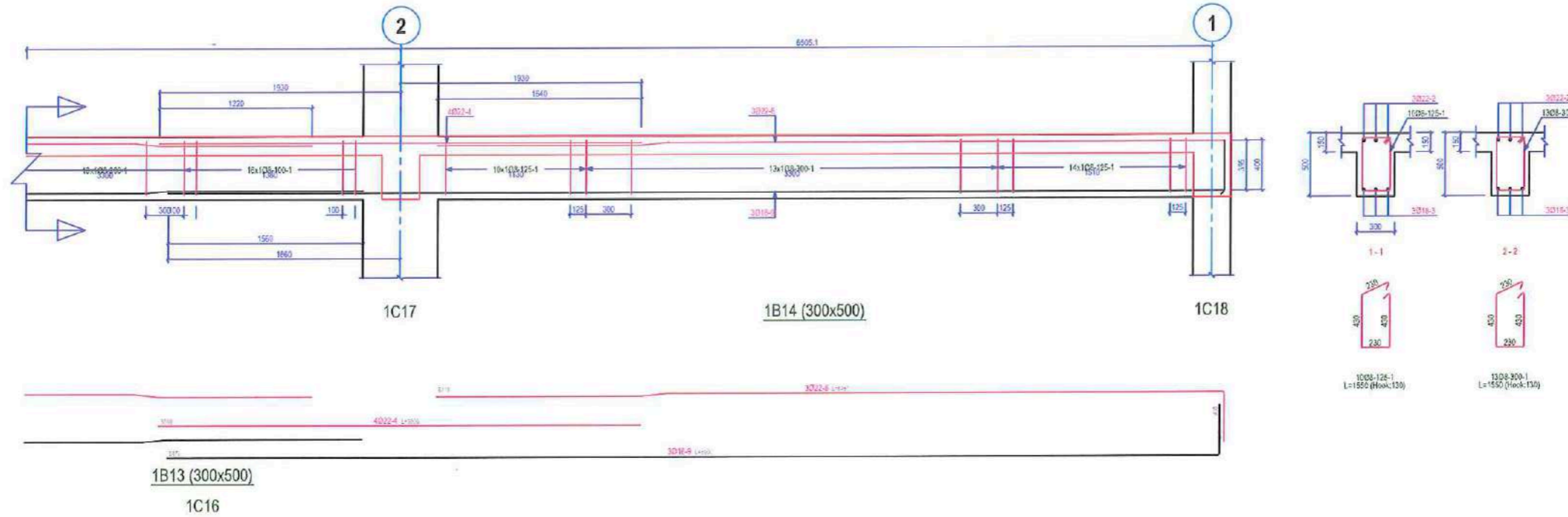

Quantity Table					TOTAL LENGTH (m)			
NO	SIZE	Q/IA	LENGTH (m)	FORM	Ø8	Ø14	Ø18	Ø22
					1	8	197	1550
2	22	3	6700	...				20.10
3	18	3	6700	...			20.10	
4	22	8	3900	...				31.20
5	14	9	8100	...		45.90		
6	18	9	8100	...			72.90	
7	18	10	3900	...			39.00	
8	22	3	6750	...				20.25
9	18	3	8900	...			28.70	
TOTAL LENGTH (m)					325.35	45.90	158.70	71.55
UNIT WEIGHT (kg/m)					0.48	1.21	2.00	2.99
WEIGHT (kg)					150.6	55.5	317.4	213.8
T.WEIGHT (kg)					707.3			

BEAM ELEVATIONS1

Scale: 1/120

OBJEKTI	RINDERTIMI I SHKOLLËS 9-VJEÇARE "HYSEN XHEKA"	NR.FLETES	A-05
VENDNDODHJA	KARBUNARE	FORMATI	420X297
EMERT.I FLETES	DETAJ I ARMIMIT TE TRAREVE TE THEMELEVE	SHKALLA	1:500
DREJTOR	ING. MIMOZA HAXHIU		
PERGJEGJES			
SPECIALIST	ARK. OKSANA BAXHO		
SPECIALIST	ORJALD DEBINJA		
SPECIALIST	ING. ARTUR SINANI		
SPECIALIST	ING. ARBEN MIKA		
SPECIALIST	ING. MALDIN CELA		
SPECIALIST	ING. KLAJDI MYZEQARI		

## DETAJ I ARMIMIT TRAREVE THEMELEVE

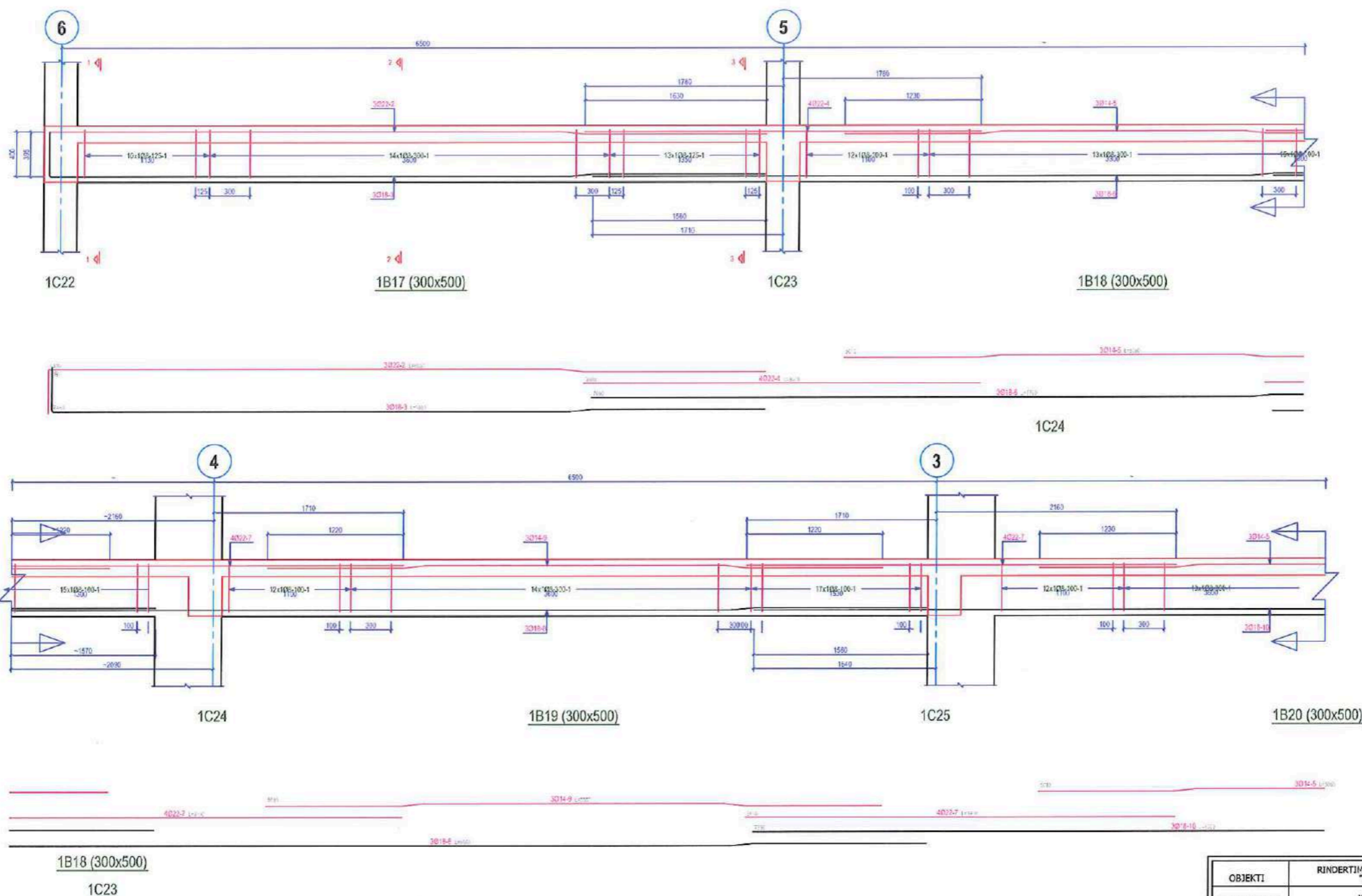

OBJEKTI	RINDERTIJA I SHKOLLES 9-VJECARE "HYSEN XHEKA"	NR.FLETES	A-05
VENDNDODHJA	KARBUNARE	FORMATI	420X297
EMERT.I FLETES	DETAJ I ARMIMIT TE TRAREVE TE THEMELEVE	SHKALLA	1:500
DREJTOR	ING. MIMOZA HAXHIU	 REPUBLIKA E SHQIPERISE BASHKIA E LUSHNJE	
PERGJEGJES			
SPECIALIST	ARK. OKSANA BAXHO		
SPECIALIST	ORJALD DEBINA		
SPECIALIST	ING. ARTUR SIMANI		
SPECIALIST	ING. ARBEN MUCA		
SPECIALIST	ING. MALDIN CELA		
SPECIALIST	ING. KLAJDI NYZEQARI		



# DETAJ I ARMIMIT TRAREVE THEMELEVE

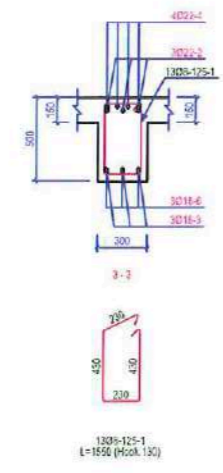
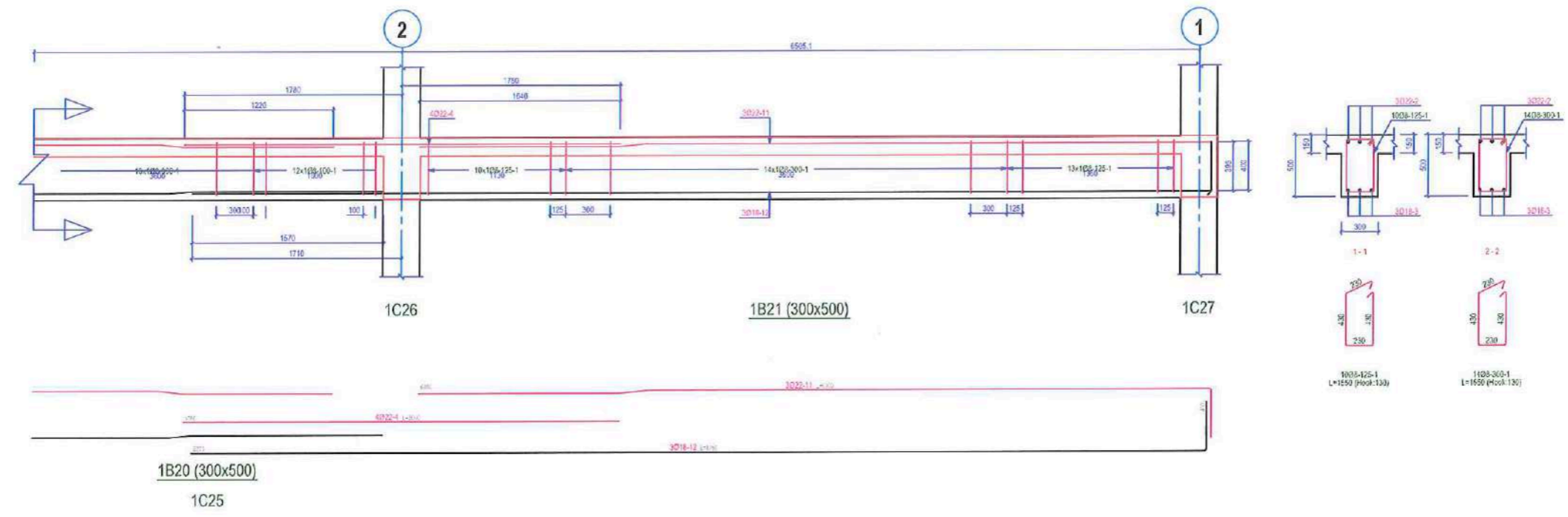

NO	SIZE	QVA	LENGTH (mm)	FORM	TOTAL LENGTH (m)			
					Ø8	Ø14	Ø18	Ø22
1	8	194	1550		300.70			
2	22	3	6850					20.55
3	18	3	6850					20.65
4	22	8	3000					28.80
5	14	6	5050			30.38		
6	18	3	7700				23.10	
7	22	8	3000					21.20
8	18	3	8550					25.65
9	14	3	5050			10.55		
10	18	3	8000					24.60
11	22	3	6900					20.70
12	18	3	8750					26.25
TOTAL LENGTH (m)					300.70	48.26	110.55	101.25
UNIT WEIGHT (kg/m)					0.40	1.21	2.00	2.99
WEIGHT (kg)					118.8	58.8	220.1	302.5
T.WEIGHT (kg)					717.2			

BEAM ELEVATIONS1

Scale: 1/120

OBJEKTI	RINDERTIMI I SHKOLLËS 9-VJECARE "HYSEN XHEKA"	NR.FLETES	A-05
VENDNDODHJA	KARBUNARE	FORMATI	420X297
EMERT.I FLETES	DETAJ I ARMIMIT TE TRAREVE TE THEMELEVE	SHKALLA	1:500
DREJTOR	ING. MIMOZA HAXHIU		
PERQJESUES			
SPECIALIST	ARK. OKSANA BAXHO		
SPECIALIST	ORJALD DEBINJA		
SPECIALIST	ING. ARTUR SINANI		
SPECIALIST	ING. ARBEN MIKA		
SPECIALIST	ING. MALDIN CELA	REPUBLICA E SHQIPERISE BASHKIA LUSHINJE	
SPECIALIST	ING. KLAJDI MYZEQARI		



## DETAJ I ARMIMIT TRAREVE THEMELEVE

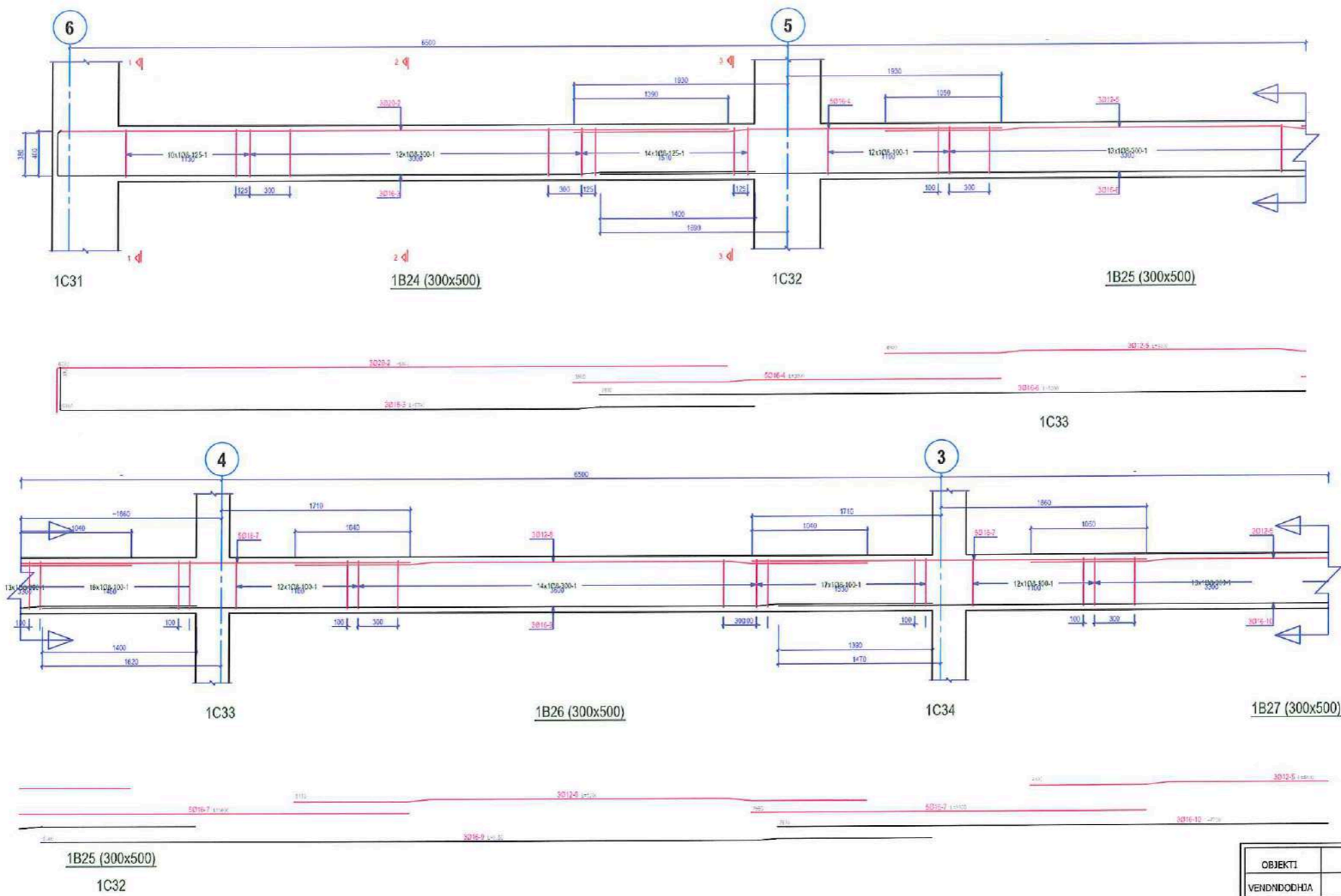

OBJEKTI	RINDERTIMI I SHKOLLËS 9-VJECARE "HYSEN XHEKA"	NR.FLETES	A-05
VENDNDODHJA	KARBUNARE	FORMATI	420X297
EMERT.I FLETES	DETAJ I ARMIMIT TE TRAREVE TE THEMELEVE	SHKALLA	1:500
DREJTOR	ING. MIMOZA HAXHUU		
PERGJEGJES			
SPECIALIST	ARK. OKSANA BAXHO		
SPECIALIST	ORJALD DEBINJA		
SPECIALIST	ING. ARTUR SINANI		
SPECIALIST	ING. ARBEN MUCA		
SPECIALIST	ING. MALDIN CELA		
SPECIALIST	ING. KLAJDI MYZEQARI		



# DETAJ I ARMIMIT TRAREVE THEMELEVE

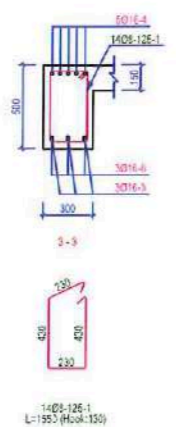
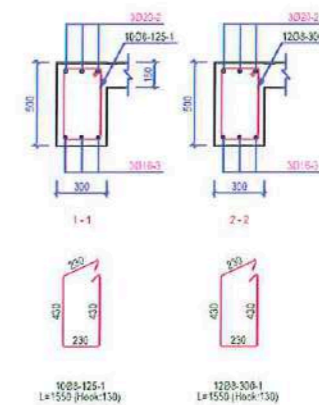
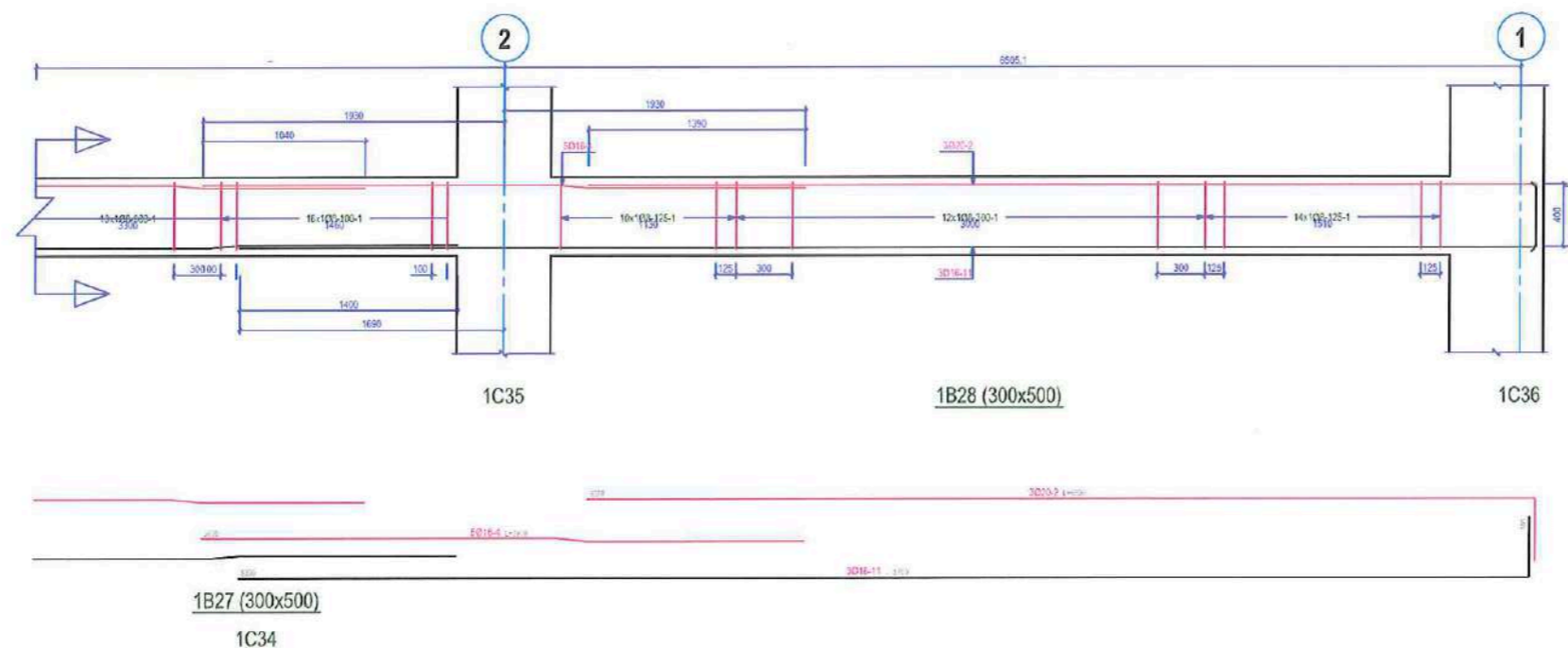

Quantity Table								
NO	SIZE	QUA	LENGTH (mm)	FORMI	TOTAL LENGTH (m)			
					Ø5	Ø12	Ø16	Ø20
1	8	157	1500		395.35			
2	20	6	6500					39.00
3	16	3	6700				20.10	
4	16	10	3900				39.00	
5	12	6	4800			28.60		
6	16	3	8700				24.00	
7	16	10	3600				36.00	
8	12	3	5200			15.60		
9	16	3	8050				24.15	
10	16	3	7700				23.10	
11	16	3	8700				25.10	
TOTAL LENGTH (m)					395.35	44.40	152.45	39.00
UNIT WEIGHT (kg/m)					0.49	0.86	1.58	2.47
WEIGHT (kg)					120.6	32.5	301.1	96.3
T.WEIGHT (kg)					560.5			

OBJEKTI	RINDERTIPI I SHKOLLËS 9-VJECARE "HYSEN XHEKA"	NR.FLETES	A-05
VENDNDODHJA	KARBUNARE	FORMATI	420X297
EMERT.I FLETES	DETAJ I ARMIMIT TE TRAREVE TE THEMELEVE	SHKALLA	1:500
DREJTOR	ING. MIMOZA HAXHIU		
PERGJEGJES			
SPECIALIST	ARK. OKSANA BASHO		
SPECIALIST	ORJALD DEBINJA		
SPECIALIST	ING. ARTUR SINANI		
SPECIALIST	ING. ARBEN MUCA		
SPECIALIST	ING. MALDIN CELA		
SPECIALIST	ING. KLAJDI MYZEQARI		



# DETAJ I ARMIMIT TRAREVE THEMELEVE

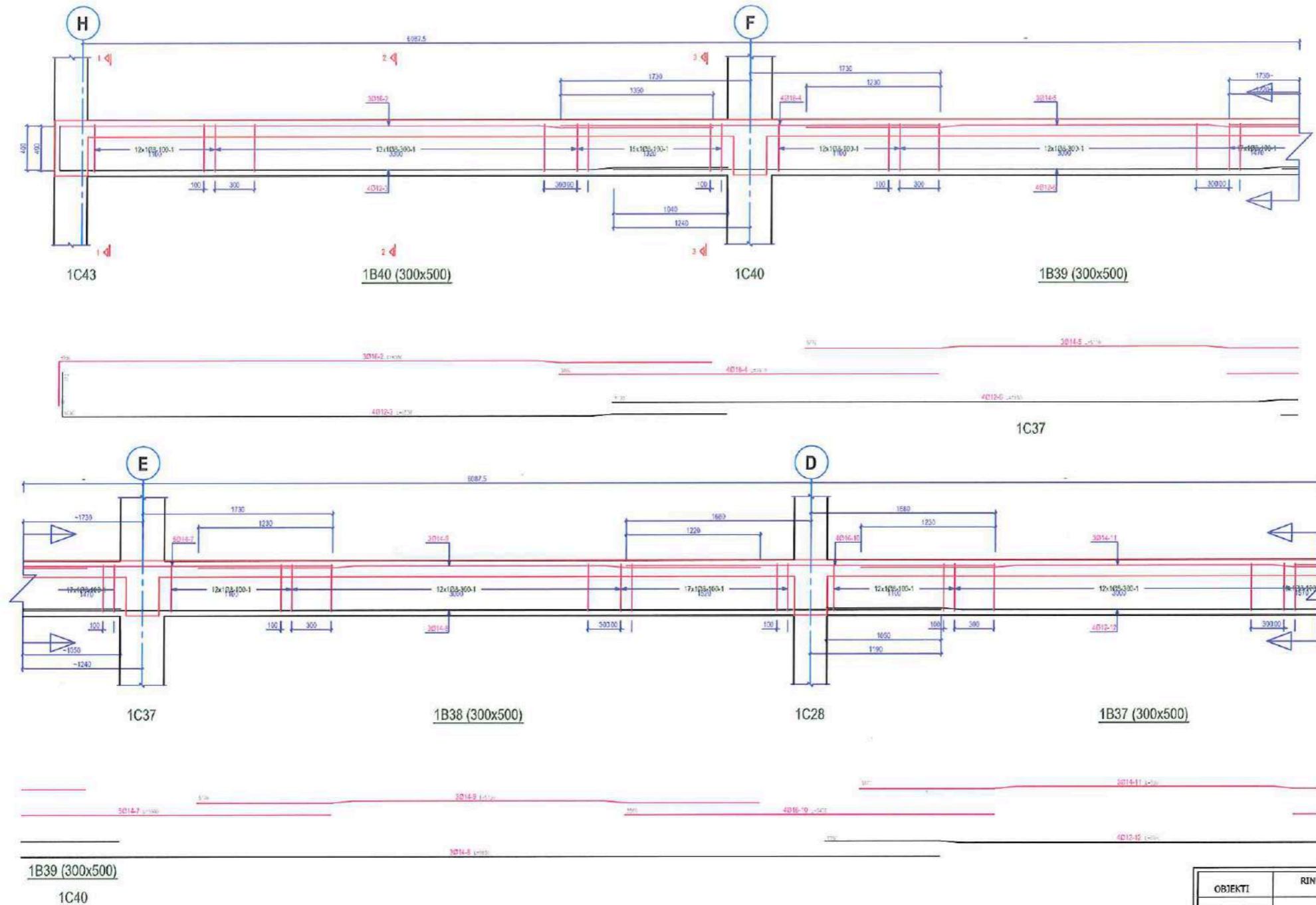

OBJEKTI	RINDERTIJA I SHKOLLES 9-VJECARE "HYSEN XHEKA"	NR.FLETES	A-05
VENDNDODHJA	KARBUNARE	FORMATI	420x297
EMERT.I FLETES	DETAJ I ARMIMIT TE TRAREVE TE THEMELEVE	SHKALLA	1:500
DREJTOR	ING. MIMOZA HAXHIU		
PERGJEGJES			
SPECIALIST	ARK. OKSANA BAXHO		
SPECIALIST	ORJALD DEBINJA		
SPECIALIST	ING. ARTUR SIMANI		
SPECIALIST	ING. ARBEN MIKA		
SPECIALIST	ING. MALDIN CELA		
SPECIALIST	ING. KLAJDI MYZEQARI		



# DETAJ I ARMIMIT TRAREVE THEMELEVE

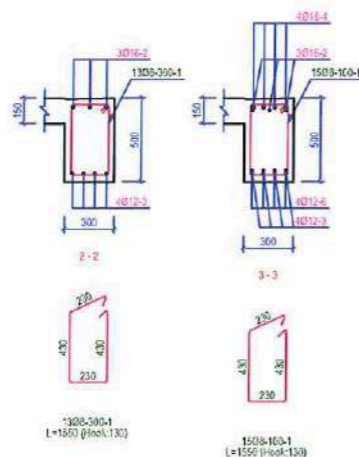
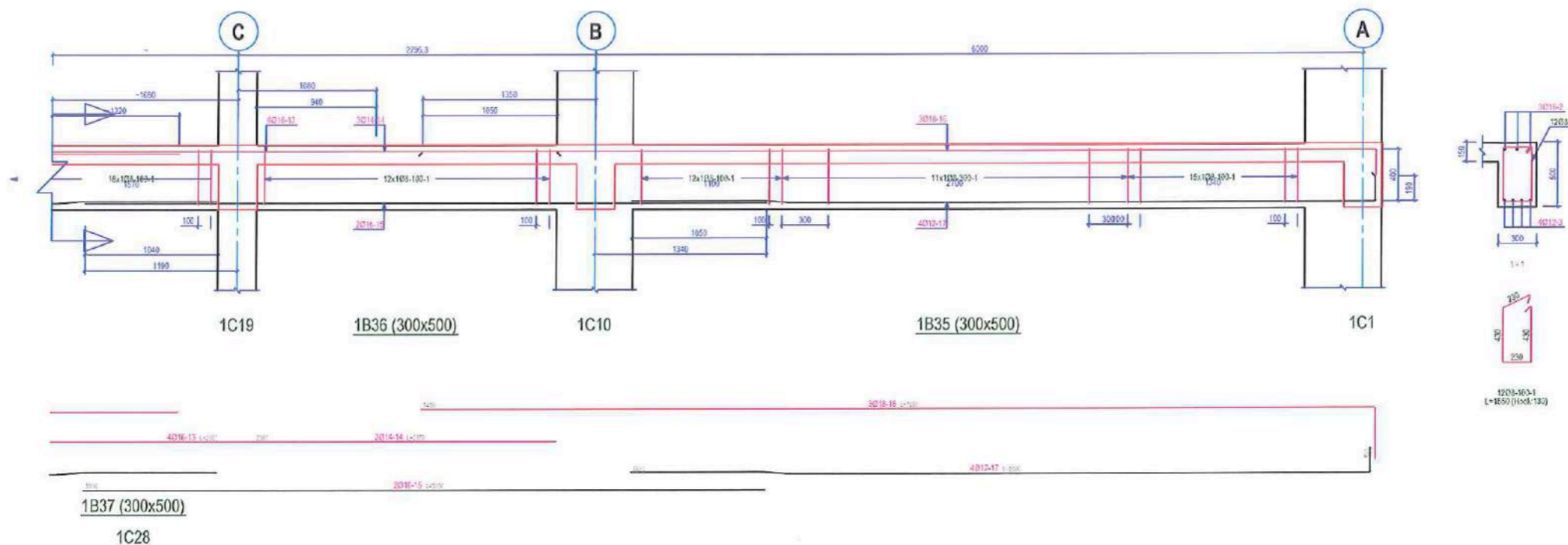

Quantity Table											
NO	SIZE	QUA.	LENGTH (mm)	FORM	TOTAL LENGTH (m)						
					Ø8	Ø12	Ø14	Ø16	Ø18		
1	8	214	1550		331.70						
2	16	3	6350					19.05			
3	12	4	6500			28.00					
4	18	4	3500						14.00		
5	14	3	5100				15.30				
6	12	4	7150			28.60					
7	14	5	3500				17.50				
8	14	3	8550				25.65				
9	14	3	5150				15.45				
10	18	4	2400						13.60		
11	14	3	5200				15.60				
12	12	4	5800			23.20					
13	18	4	2800						11.20		
14	14	3	2350				7.05				
15	18	2	5350						10.70		
16	18	3	7850						23.55		
17	12	4	6000			24.00					
TOTAL LENGTH (m)					331.70	161.80	96.65	54.55	37.55		
UNIT WEIGHT (kg/m)					0.49	0.89	1.21	1.58	2.00		
WEIGHT (kg)					131.6	90.5	116.8	86.2	75.1		
TOTAL WEIGHT (kg)					499.6						

OBJEKTI	RINDERTIMI I SHKOLLËS 9-VJECARE "HYSEN XHEKA"	NR.FLETES	A-05
VENDNDODHJA	KARBUNARE	FORMATI	420X297
EMERT.I FLETES	DETAJ I ARMIMIT TE TRAREVE TE THEMELEVE	SHKALLA	1:500
DREJTOR	ING. MIMOZA HAXHBU		
PERGJEGJES			
SPECIALIST	ARK. OKSANA BAXHO		
SPECIALIST	ORJALD DEBINJA		
SPECIALIST	ING. ARTUR SINANI		
SPECIALIST	ING. ARBEN MUCA		
SPECIALIST	ING. MALDIN CELA	REPUBLIKA E SHQIPËRIE BASHKIA LUSHNJE	
SPECIALIST	ING. KLAJDI NYZEQARI		



# DETAJ I ARMIMIT TRAREVE THEMELEVE

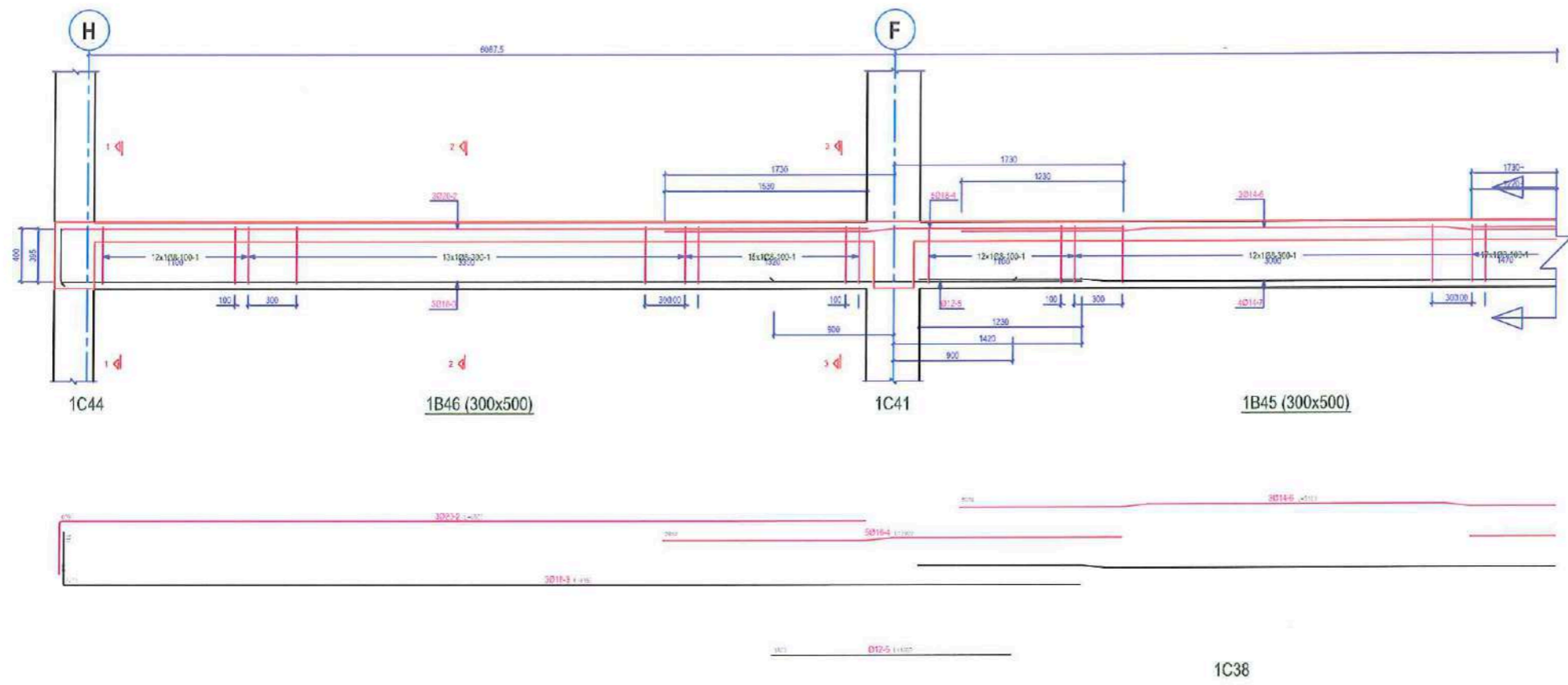

BEAM ELEVATIONS1 Scale: 1/120

OBJEKTI	RINDERTIMI I SHKOLLËS 9-VJEÇARE "HYSEN XHEKA"	NR.FLETES	A-05
VENDNDODHJA	KARBUNARE	FORMATI	420X297
EMERT.I FLETES	DETAJ I ARMIMIT TE TRAREVE TE THEMELEVE	SHKALLA	1:500
DREJTOR	ING. MIMOZA HAXHIU	 REPUBLIKA E SHQIPËRIE BASHKIA LUSHNJE	
PERGJEGJES			
SPECIALIST	ARK. OKSANA BAXHO		
SPECIALIST	ORJALD DEBINJA		
SPECIALIST	ING. ARTUR SINANI		
SPECIALIST	ING. ARBEN MUCA		
SPECIALIST	ING. HALDIN CELA		
SPECIALIST	ING. KLAJDI MYZEQARI		



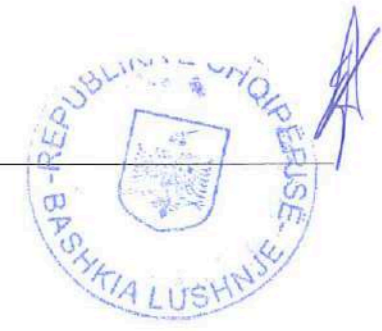

# DETAJ I ARMIMIT TRAREVE THEMELEVE

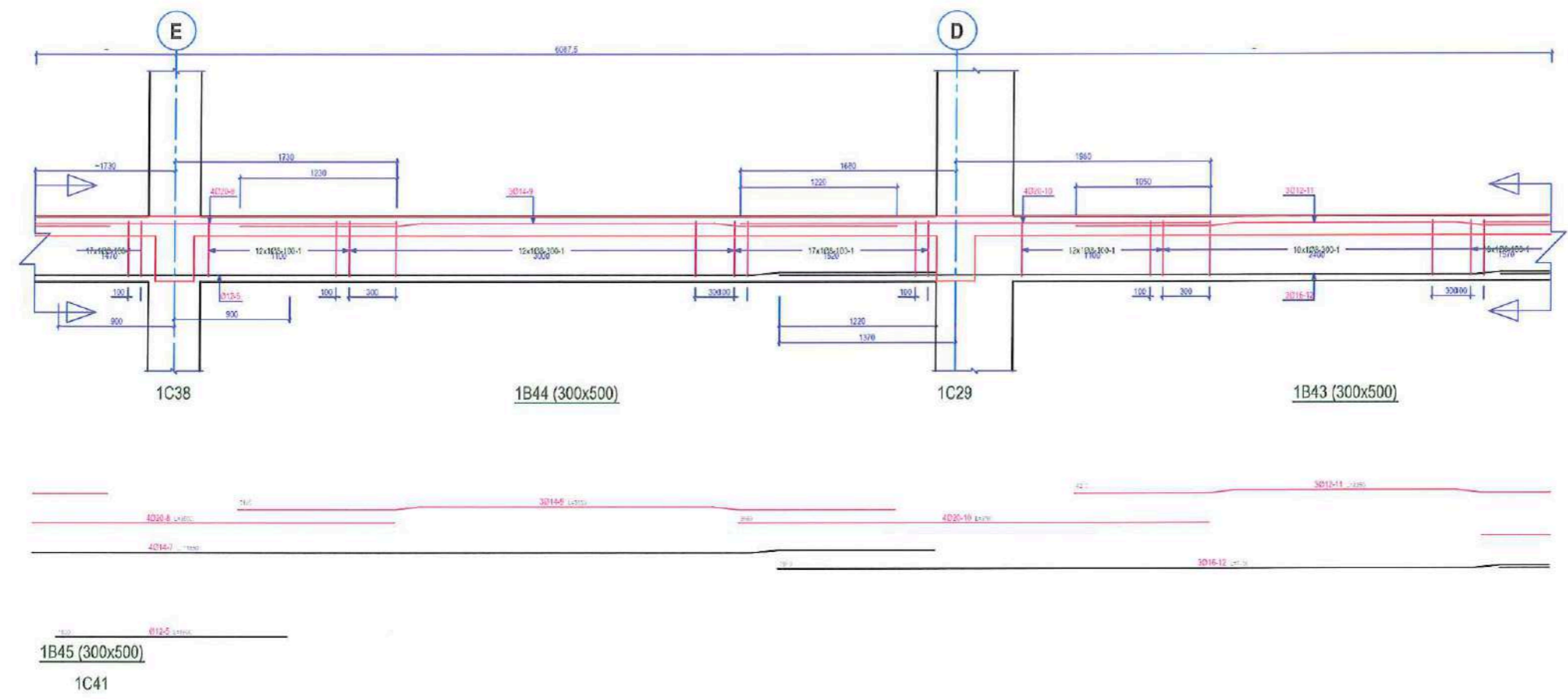

BEAM ELEVATIONS1 Scale: 1/120

OBJEKTI	RINDERTIMI I SHKOLLES 9-VJECARE "HYSEN XHEKA"	NR.FLETES	A-05
VENDNDODHJA	KARBUNARE	FORMATI	420X297
EMERT.I FLETES	DETAJ I ARMIMIT TE TRAREVE TE THEMELEVE	SHKALLA	1:500
DREJTOR	ING. MIMOZA HAXHBU	 REPUBLIKA E SHQIPERISE BASHKIA LUSHNJE	
PERGJEGJES			
SPECIALIST	ARK. OXSANA BAXHO		
SPECIALIST	ORJALD DEBINJA		
SPECIALIST	ING. ARTUR SINANI		
SPECIALIST	ING. ARBEN MUCA		
SPECIALIST	ING. MALDIN CELA		
SPECIALIST	ING. KLADJI NYZEFQARI		



# DETAJ I ARMIMIT TRAREVE THEMELEVE

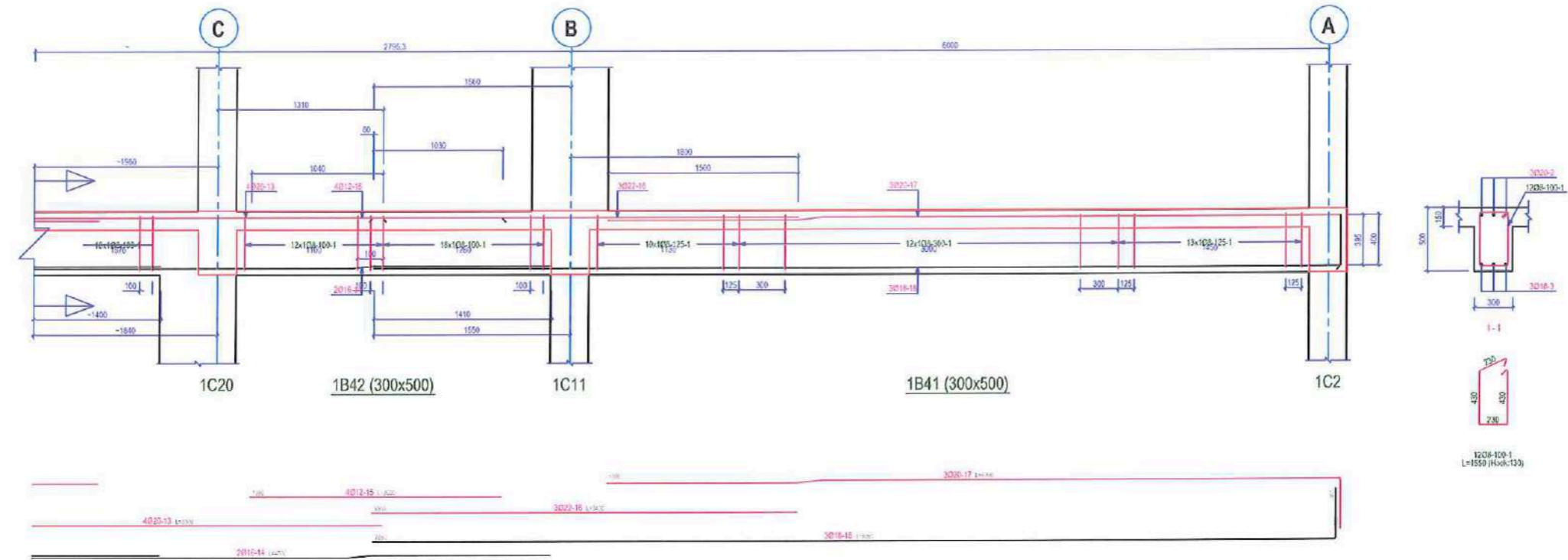

1B43 (300x500)  
1C29

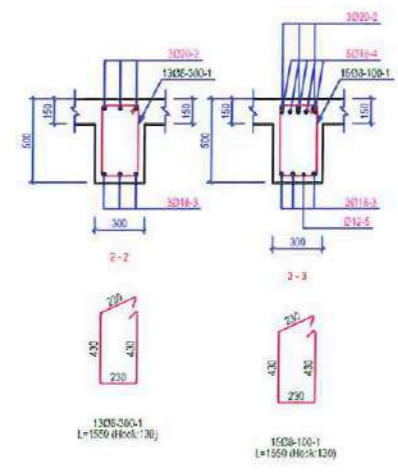

Quantity Table													
NO	SIZE	QJA	LENGTH (mm)	FORM	TOTAL LENGTH (m)								
					Ø8	Ø12	Ø14	Ø16	Ø18	Ø20	Ø22		
1	8	220	1550		353.40								
2	20	3	5520								16.50		
3	18	3	8190							24.45			
4	18	5	3520							17.50			
5	12	2	1620		3.60								
6	14	3	5120				15.20						
7	14	4	11850				47.40						
8	20	4	3520							14.00			
9	14	3	5150				15.45						
10	20	4	3700							14.80			
11	12	3	4250			12.75							
12	16	3	7050					21.15					
13	20	4	3300							13.20			
14	16	2	4500				9.00						
15	12	4	2020		8.00								
16	22	3	3400							10.20			
17	20	3	6200							18.60			
18	16	3	8050						24.15				
TOTAL LENGTH (m)					353.40	24.25	78.15	50.15	66.10	89.30	10.20		
UNIT WEIGHT (kg/m)					0.40	0.89	1.21	1.58	2.00	2.47	2.90		
WEIGHT (kg)					139.6	21.6	94.6	47.5	132.2	197.8	30.5		
TOTAL WEIGHT (kg)					663.9								

BEAM ELEVATIONS1

Scale: 1/120

OBJEKTI	RINDERTIMI I SHKOLLES 9-VJECARE "HYSEN XHEKA"	NR. FLETES	A-05
VENDNDODHJA	KARBUNARE	FORMATI	420X297
EMERT. I FLETES	DETAJ I ARMIMIT TE TRAREVE TE THEMELEVE	SHKALLA	1:500
DIREKTOR	ING. MIMOZA HAXHIBU		
PERGJEGJES			
SPECIALIST	ARK. OKSANA BAXHO		
SPECIALIST	ORJALD DEBINJA		
SPECIALIST	ING. ARTUR SINANI		
SPECIALIST	ING. ARBEN MUCA		
SPECIALIST	ING. MALDIN CELA	REPUBLIKA E SHQIPERISE BASHKIA LUSHNJE	
SPECIALIST	ING. KLAJDI MYZEQARI		



# DETAJ I ARMIMIT TRAREVE THEMELEVE

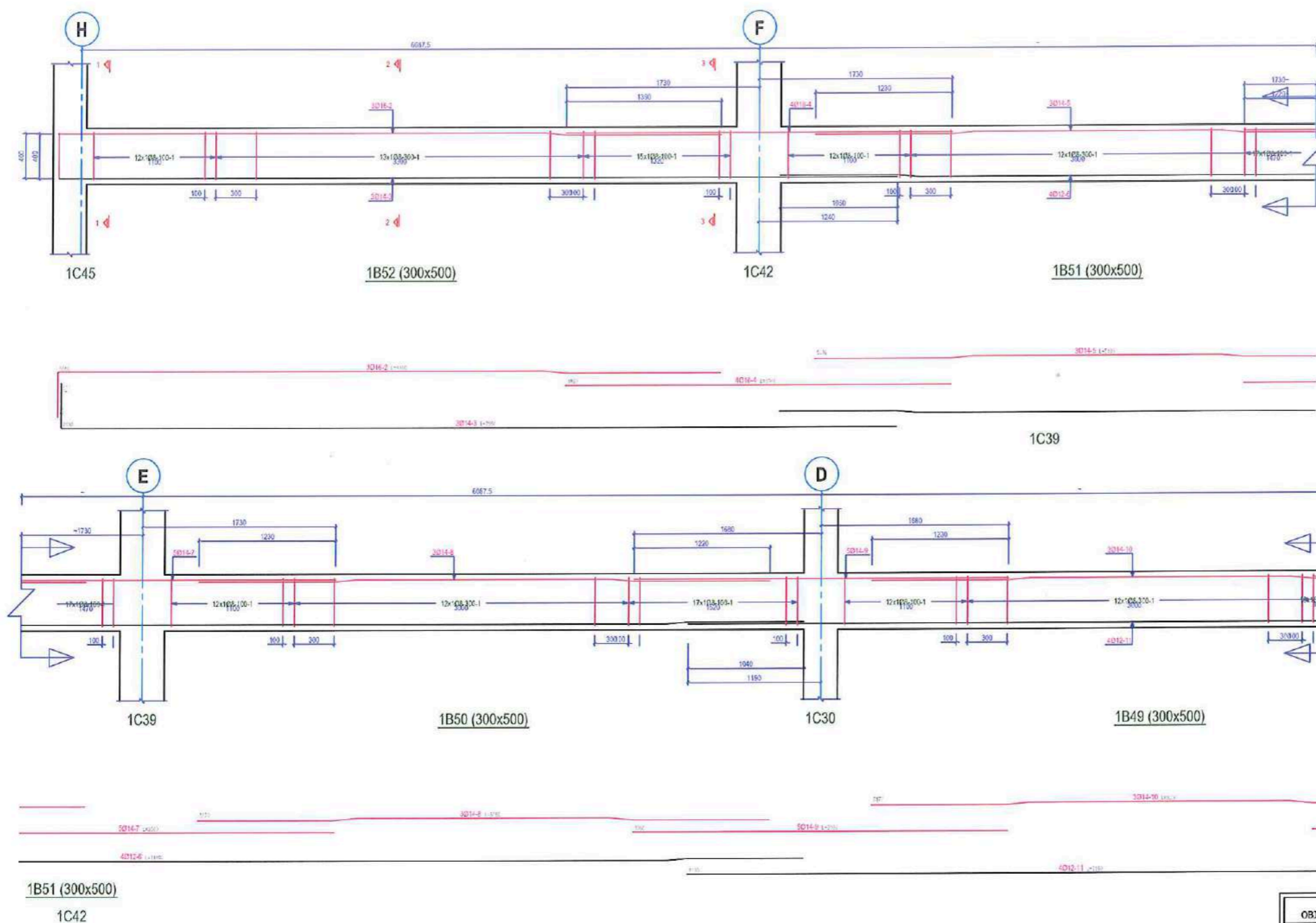

OBJEKTI	RINDERTIMI I SHKOLLES 9-VJECARE "HYSEN XHEKA"	NR.FLETES	A-05
VENDNDODHJA	KARBUNARE	FORMATI	420X297
EMERTI FLETES	DETAJ I ARMIMIT TE TRAREVE TE THEMELEVE	SHKALLA	1:500
DREJTOR	ING. MINOZA HAXHIU	 REPUBLIKA E SHQIPERISE BASHKIA LUSHNJE	
PERGJEGJES			
SPECIALIST	ARK. OKSANA BAXHO		
SPECIALIST	ORJALD DEBINA		
SPECIALIST	ING. ARTUR SINANI		
SPECIALIST	ING. ARBEN MUCA		
SPECIALIST	ING. MALDIN CELA		
SPECIALIST	ING. KLAUDI MYZEQARI		



# DETAJ I ARMIMIT TRAREVE THEMELEVE

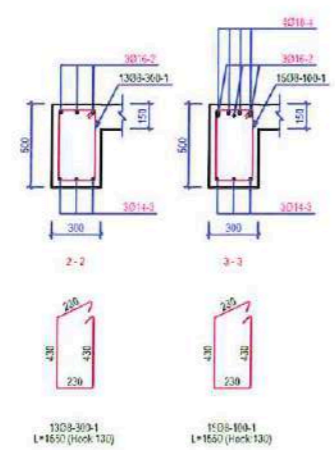
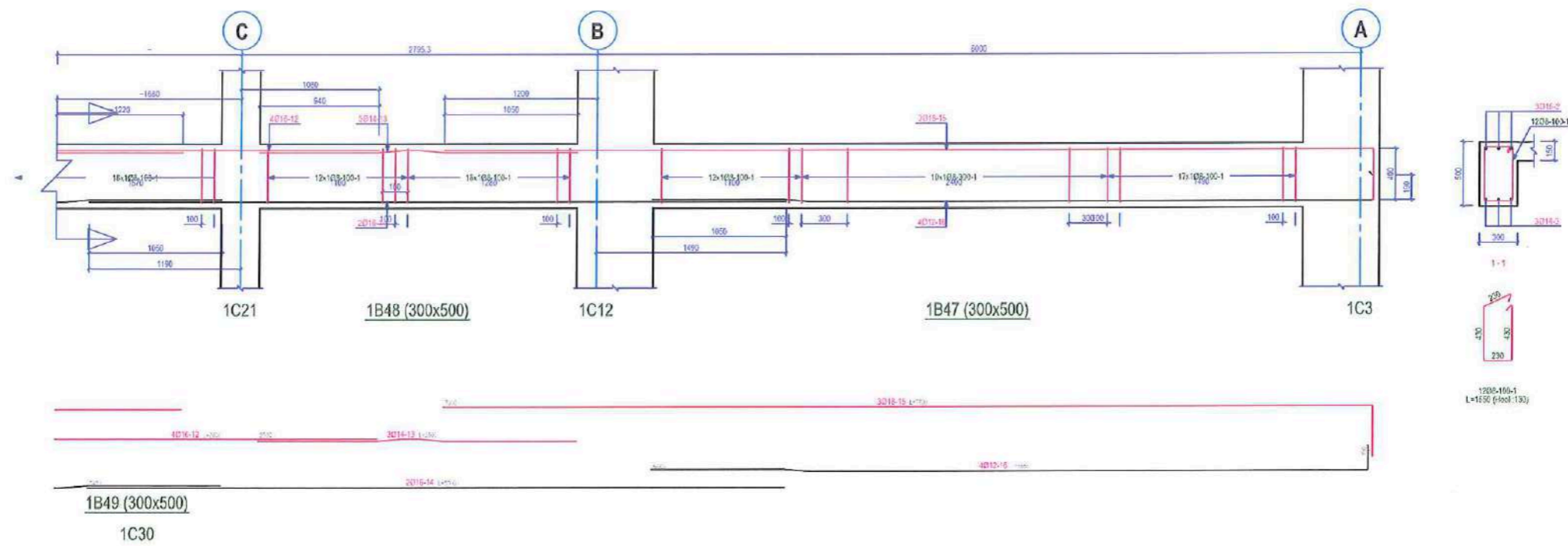

Quantity Table									
NO	SIZE	QUA	LENGTH (mm)	FORM	TOTAL LENGTH (m)				
					Ø8	Ø12	Ø14	Ø16	Ø18
1	8	234	1550	3016-2	362.70				
2	16	3	6350	3016-2				19.05	
3	14	3	7950	3016-2			23.85		
4	16	4	5500	3016-2					14.00
5	14	3	5100	3016-2			15.30		
6	12	4	11850	3016-2		47.40			
7	14	5	3500	3016-2			17.50		
8	14	3	5150	3016-2			15.45		
9	14	5	3400	3016-2			17.00		
10	14	3	5200	3016-2			15.60		
11	12	4	7150	3016-2		28.60			
12	10	4	2800	3016-2				11.20	
13	14	3	2500	3016-2			7.50		
14	16	2	5500	3016-2				11.00	
15	18	3	7700	3016-2					23.10
16	12	4	5850	3016-2		23.40			
TOTAL LENGTH (m)					362.70	96.40	112.20	61.25	37.16
UNIT WEIGHT (kg/m)					0.40	0.89	1.21	1.58	2.00
WEIGHT (kg)					143.3	88.4	135.7	95.2	74.2
T.WEIGHT (kg)					596.8				

OBJEKTI	RINDERTIMI I SHKOLLES 9-VJECARE "HYSEN XHEKA"	NR.FLETES	A-05
VENDNDODHJA	KARBUNARE	FORMATI	420x297
EMERT.I FLETES	DETAJ I ARMIMIT TE TRAREVE TE THEMELEVE	SHKALLA	1:500
DREJTOR	ING. MIMOZA HAXHIU		
PERGJEGJES			
SPECIALIST	ARK. OKSANA BAXHO		
SPECIALIST	ORJALD DEBINJA		
SPECIALIST	ING. ARTUR SINANI		
SPECIALIST	ING. ARBEN MUCA		
SPECIALIST	ING. HALDIN CELA	REPUBLICA E SHQIPERISE BASHKIA LUSHINE	
SPECIALIST	ING. KLAJDI MYZEQARI		



# DETAJ I ARMIMIT TRAREVE THEMELEVE

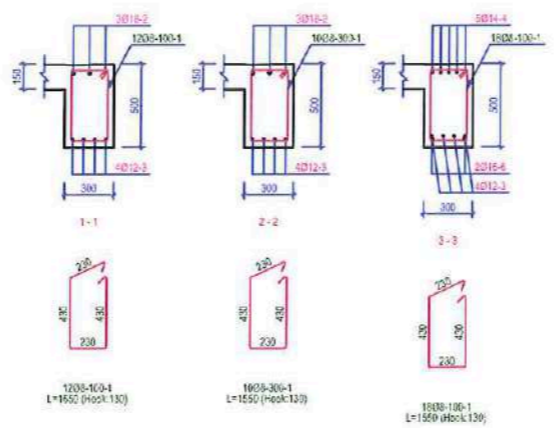
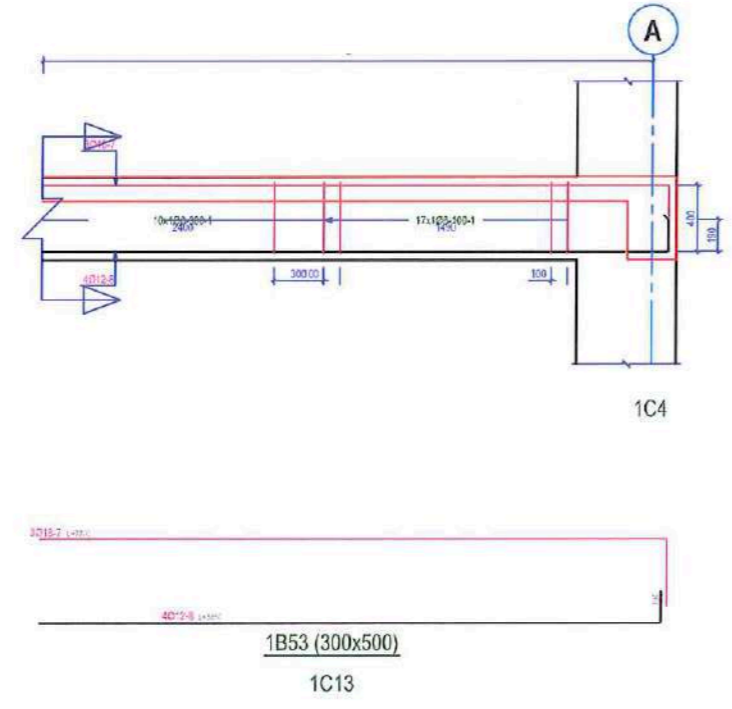
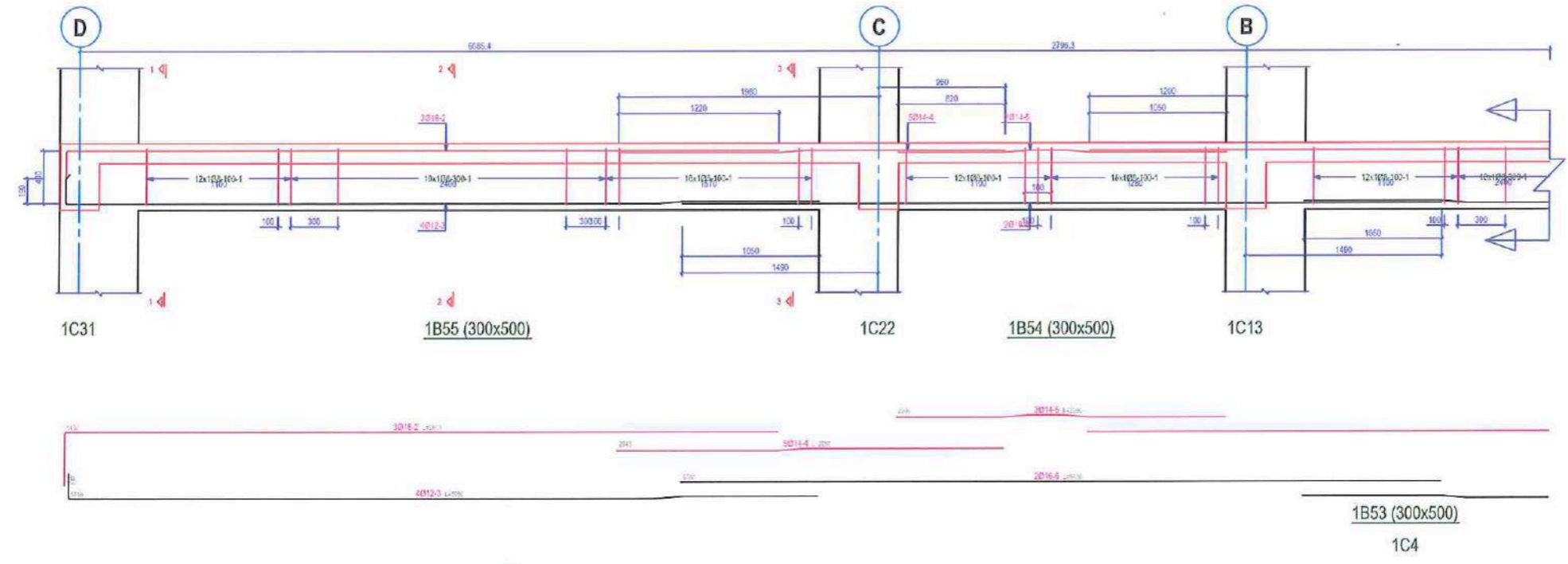

NO	SIZE	QMA	LENGTH (mm)	FORM	TOTAL LENGTH (m)				
					Ø8	Ø12	Ø14	Ø16	Ø18
1	8	110	1559	□	170.50				
2	16	3	8809	□					17.55
3	12	4	5259	□		23.80			
4	14	5	2259	□			14.75		
5	14	3	2500	□			7.50		
6	16	2	5900	□				11.50	
7	18	3	2700	□					23.10
8	12	4	5850	□		23.40			
TOTAL LENGTH (m)					170.50	47.20	22.25	11.50	40.65
UNIT WEIGHT (kg/m)					0.40	0.98	1.21	1.58	2.00
WEIGHT (Kg)					67.4	42.0	25.9	18.3	81.3
T.WEIGHT (Kg)					233.9				

OBJEKTI	RINDERTIMI I SHKOLLES 9-VJECARE "HYSEN XHEKA"	NR.FLETES	A-05
VENDNDODHJA	KARBUNARE	FORMATI	420X297
EMERT.I FLETES	DETAJ I ARMIMIT TE TRAREVE TE THEMELEVE	SHKALLA	1:500
DREJTOR	ING. MIMOZA HAXHBU		
PERGJEGJES			
SPECIALIST	ARK. OKSANA BAXHO		
SPECIALIST	ORJALD DEBINJA		
SPECIALIST	ING. ARTUR SINANI		
SPECIALIST	ING. ARBEN MUJA	REPUBLICA E SHQIPËRIE BASHKIA E LUSHNË	
SPECIALIST	ING. MALDIN CELA		
SPECIALIST	ING. KLAJDI MYZEQARI		



# DETAJ I ARMIMIT TRAREVE THEMELEVE

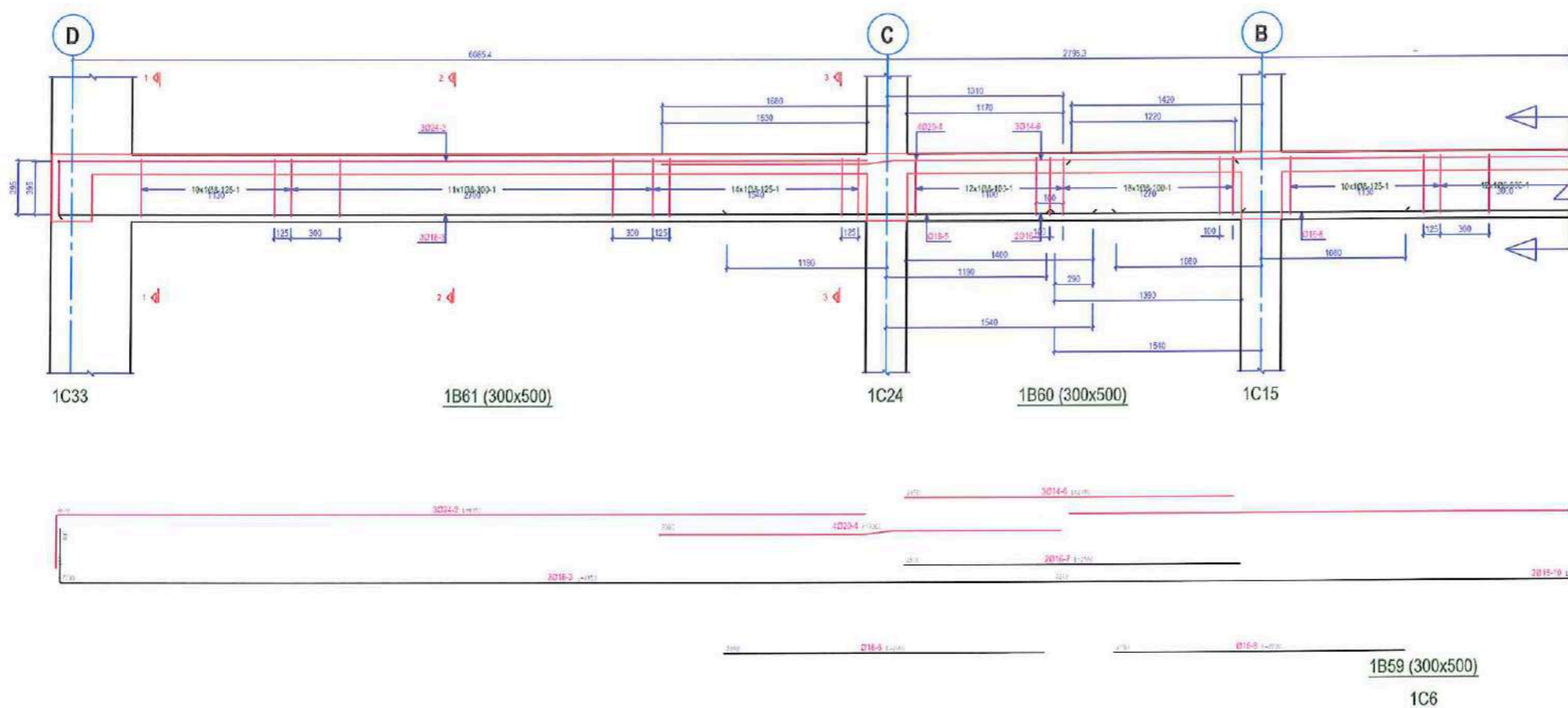

OBJEKTI	RINDERTIMI I SHKOLLES 9-VJECARE "HYSEN XHEKA"	NR.FLETES	A-05
VENDNDODHJA	KARBUNARE	FORMATI	420X297
EMERT.I FLETES	DETAJ I ARMIMIT TE TRAREVE TE THEMELEVE	SHKALLA	1:500
DREJTOR	ING. MIMOZA HAXHILU		
PERGJEGJES			
SPECIALIST	ARK. OKSANA BAXHO		
SPECIALIST	ORJALD DEBINJA		
SPECIALIST	ING. ARTUR SINANI		
SPECIALIST	ING. ARBEN MUCA		
SPECIALIST	ING. MALDIN CELA	REPUBLICA E SHQIPERISE	
SPECIALIST	ING. KLAIDI MYZEQARI	BASHKIA E LUSHNJE	



# DETAJ I ARMIMIT TRAREVE THEMELEVE

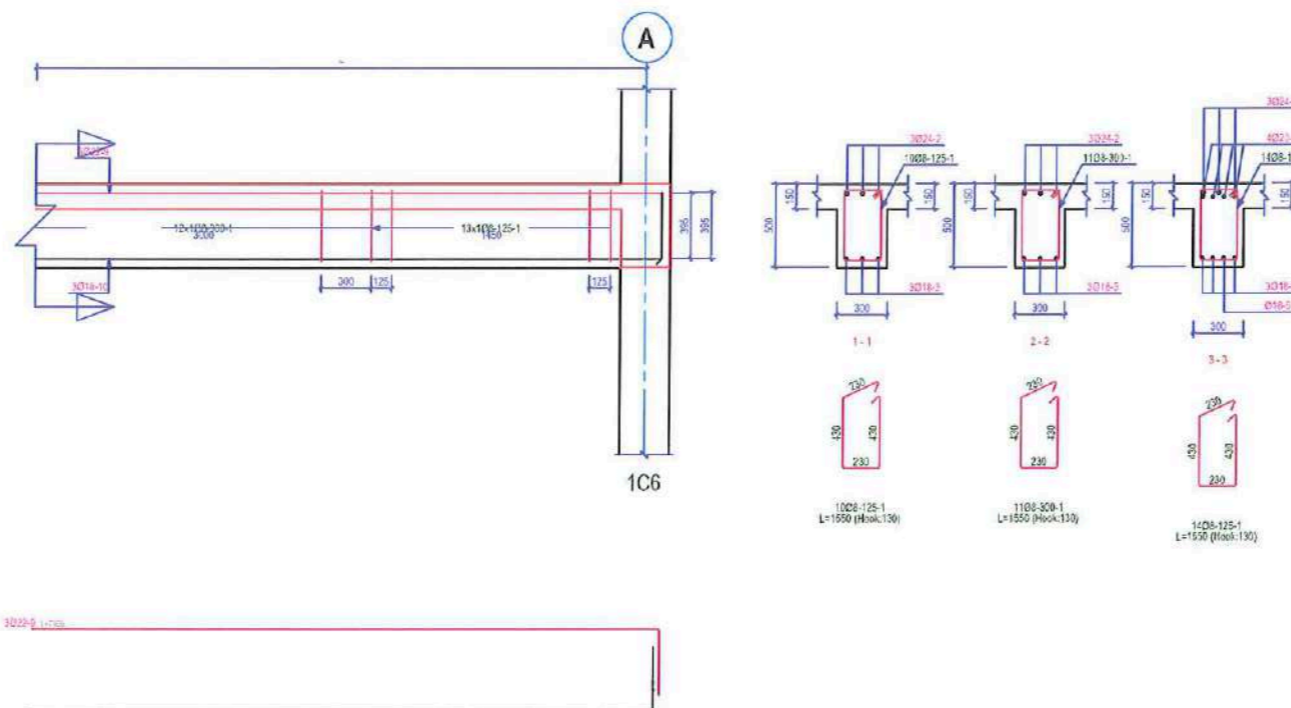

1B59 (300x500)  
1C15

Quantity Table												
NO	SIZE	QJA	LENGTH (mm)	FORM	TOTAL LENGTH (m)							
					Ø8	Ø14	Ø16	Ø18	Ø20	Ø22	Ø24	
1	8	101	1550		155.55							
2	24	3	6450									19.35
3	18	3	8120					24.45				
4	20	4	3000							12.00		
5	18	1	2400					2.40				
6	14	3	2450		7.35							
7	16	2	2500				5.00					
8	16	1	2200				2.20					
9	22	3	7850								23.85	
10	18	3	8650					24.15				
TOTAL LENGTH (m)					196.55	7.35	7.20	51.00	12.00	23.85	19.35	
UNIT WEIGHT (kg/m)					0.46	1.21	1.50	2.00	2.47	2.99	3.56	
WEIGHT (kg)					61.8	8.9	11.4	102.9	29.6	71.3	68.8	
T.WEIGHT (kg)					353.8							

OBJEKTI	RINDERTIMI I SHKOLLËS 9-VJECARE "HYSEN XHEKA"	NR.FLETES	A-05
VENDNDODHJA	KARBUNARE	FORMATI	420X297
EMERT.I FLETES	DETAJ I ARMIMIT TE TRAREVE TE THEMELEVE	SHKALLA	1:500
DREJTOR	ING. MIMOZA HAXHIBU	 REPUBLIKA E SHQIPËRISE BASHKIA LUSHNJË	
PERGJEGJES			
SPECIALIST	ARK. OKSANA BAXHO		
SPECIALIST	ORJALD DEBINJA		
SPECIALIST	ING. ARTUR SINANI		
SPECIALIST	ING. ARBEN MUCA		
SPECIALIST	ING. MALDIN CELA		
SPECIALIST	ING. KLADI MYZEQARI		



# DETAJ I ARMIMIT TRAREVE THEMELEVE

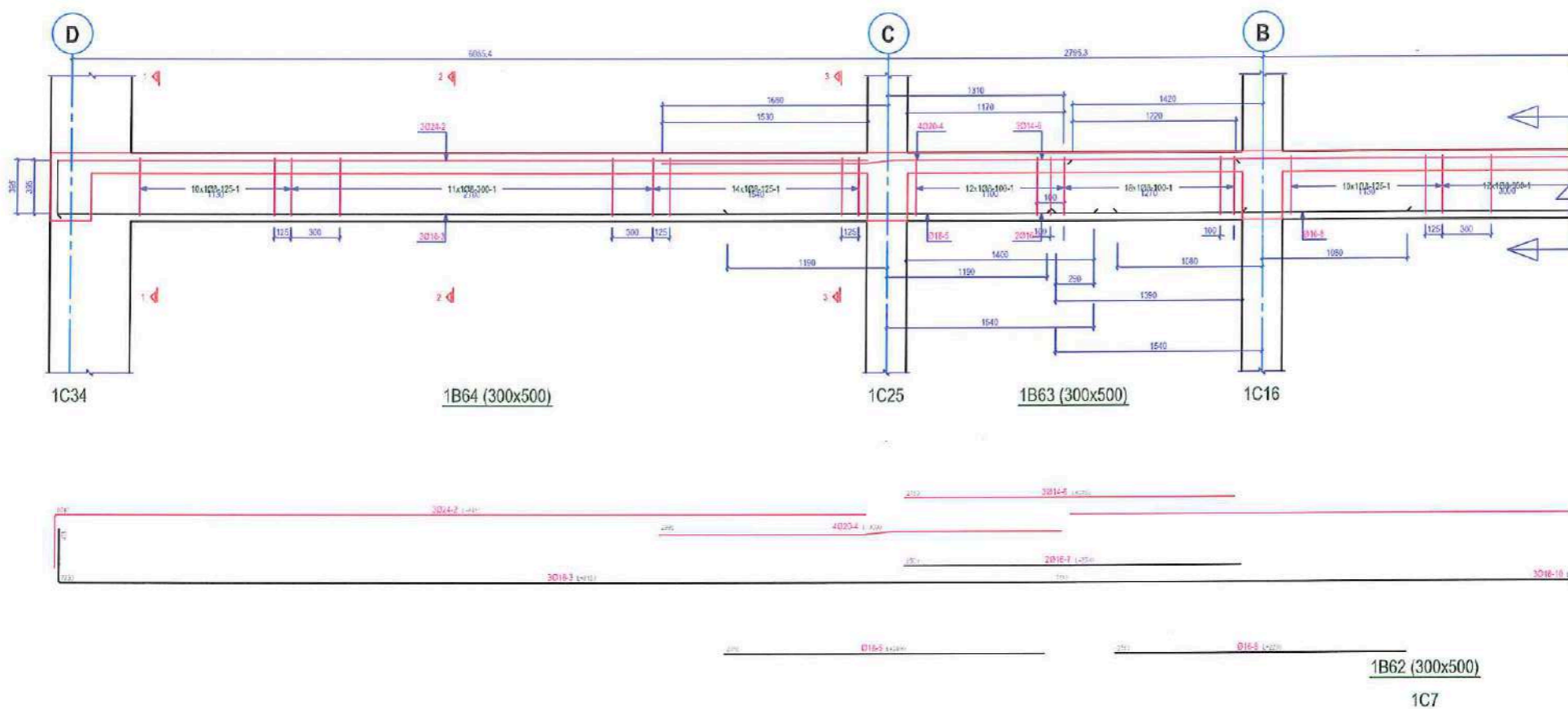

OBJEKTI	RINDERTIMI I SHKOLLES 9-VJECARE "HYSEN XHEKA"	NR.FLETES	A-05
VENDNDODHJA	KARBUNARE	FORMATI	420x297
EMERT.I FLETES	DETAJ I ARMIMIT TE TRAREVE TE THEMELEVE	SHKALLA	1:500
DREJTOR	ING. MIMOZA HAXHILI	 REPUBLIKA E SHQIPERISE BASHKIA E LUSHITES	
PERGJEGJES			
SPECIALIST	ARK. OKSANA BAXHO		
SPECIALIST	ORJALD DEBINJA		
SPECIALIST	ING. ARTUR SINANI		
SPECIALIST	ING. ARBEN MUCA		
SPECIALIST	ING. MALDIN CELA		
SPECIALIST	ING. KLADJI MYZEQARI		



# DETAJ I ARMIMIT TRAREVE THEMELEVE

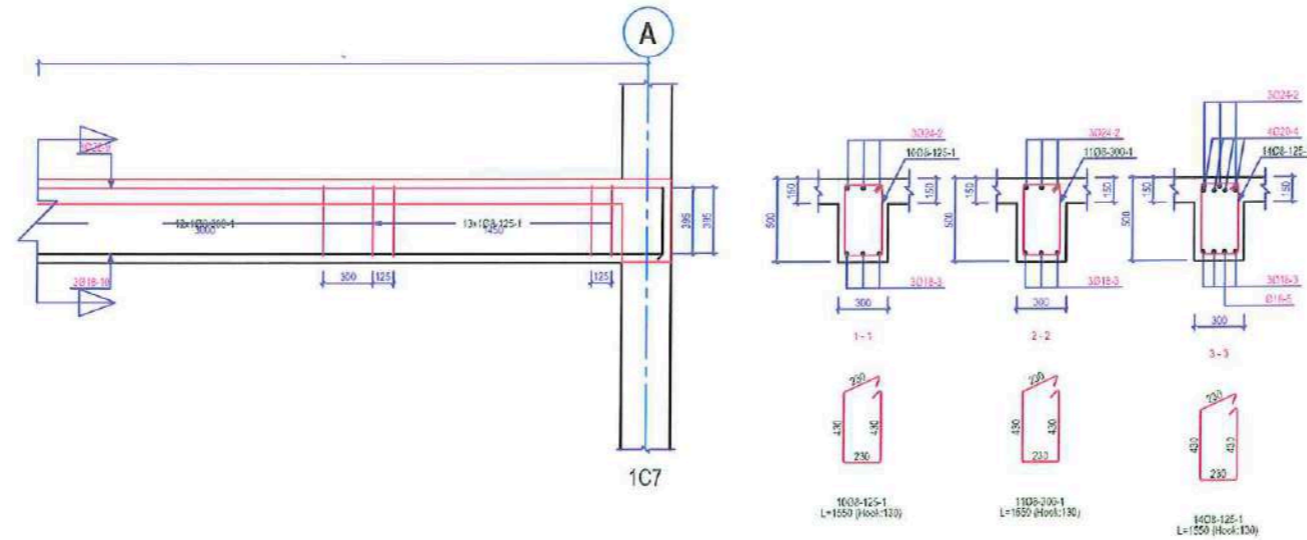

1B62 (300x500)  
1C16

Quantity Table					TOTAL LENGTH (m)						
NO	SIZE	QJA	LENGTH (mm)	FORM	Ø8	Ø14	Ø16	Ø18	Ø20	Ø22	Ø24
1	8	101	1650	1008-125-1	166.55						
2	21	3	6450	1608-125-1							19.35
3	18	3	8150	1708-200-1				24.45			
4	20	4	3000	1408-125-1					12.00		
5	18	1	2400	3024-2				2.40			
6	14	3	2450	4020-4		7.35					
7	18	2	2500	3016-3			5.00				
8	16	1	2200	01-6-5			2.20				
9	22	3	7650	1408-125-1						23.85	
10	18	3	8650	3016-3				24.15			
TOTAL LENGTH (m)					166.55	7.35	7.20	51.00	12.00	23.85	10.25
UNIT WEIGHT (kg/m)					0.40	1.21	1.58	2.00	2.47	2.99	3.55
WEIGHT (kg)					51.8	8.9	11.4	102.0	29.6	71.3	68.8
T.WEIGHT (kg)					353.8						

Scale: 1/120

OBJEKTI	RINDERTIMI I SHKOLLES 9-VJECARE "HYSEN XHEKA"	NR.FLETES	A-05
VENDNDODHJA	KARBUNARE	FORMATI	420x297
EMERT.I FLETES	DETAJ I ARMIMIT TE TRAREVE TE THEMELEVE	SHKALLA	1:500
DIREKTOR	ING. MIMOZA HAXHILU		
PERGJEGJES			
SPECIALIST	ARK. OKSANA BAXHO		
SPECIALIST	ORJALD DEBINJA		
SPECIALIST	ING. ARTUR SINANI		
SPECIALIST	ING. ARBEN MUCA		
SPECIALIST	ING. MALDIN CELA	REPUBLIKA E SHQIPËRIE BASHKICIA LUSHNJE	
SPECIALIST	ING. KLAJDI MYZEQARI		





# DETAJ I ARMIMIT TRAREVE THEMELEVE

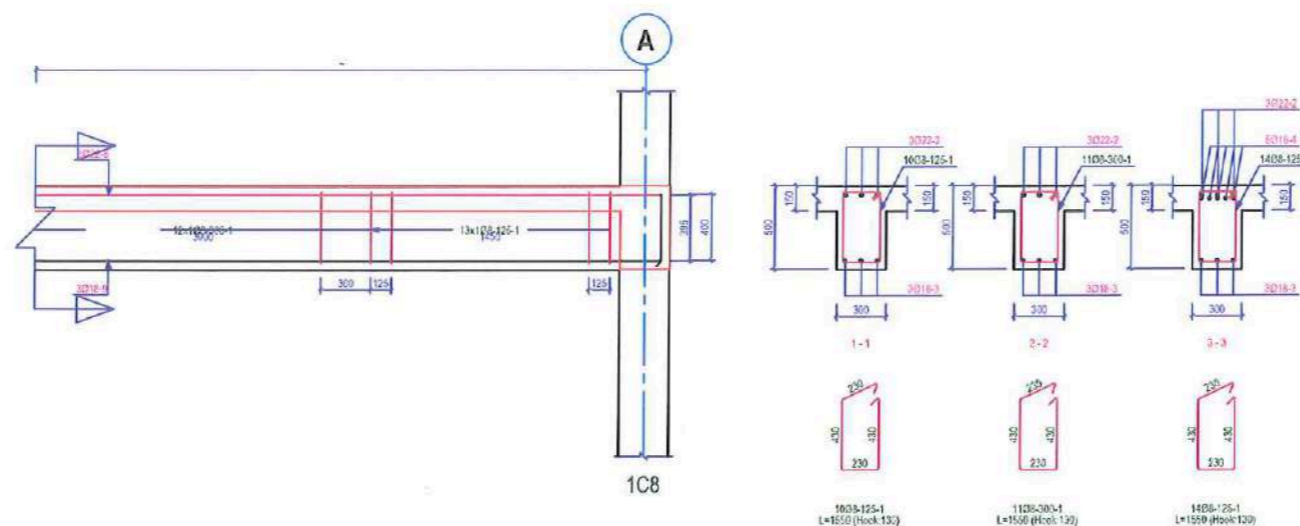

1B65 (300x500)

1C17

Quantity Table						TOTAL LENGTH (m)					
NO	SIZE	QUA	LENGTH (mm)	FORM							
					Ø8	Ø14	Ø16	Ø18	Ø22		
1	8	101	1850	1000x125	156,56						
2	22	3	6150	1100x300					18,45		
3	18	3	8150	1400x125					24,45		
4	18	5	3200	1100x300					16,00		
5	14	3	2450	1100x300		7,35					
6	16	2	2800	1100x300			5,00				
7	16	1	2200	1100x300			2,20				
8	22	3	7950	1400x125					23,85		
9	18	3	3050	1400x125					24,15		
TOTAL LENGTH (m)					156,56	7,35	7,20	64,60	42,30		
UNIT WEIGHT (Kg/m)					0,40	1,21	1,58	2,00	2,09		
WEIGHT (Kg)					61,8	5,9	11,4	129,2	125,4		
T.WEIGHT (Kg)					337,7						

Scale: 1/120

OBJEKTI	RINDERTIMI I SHKOLLES 9-VJECARE "HYSEN XHEKA"	NR.FLETES	A-05
VENDNDODHJA	KARBUNARE	FORMATI	420X297
EMERTI FLETES	DETAJ I ARMIMIT TE TRAREVE TE THEMELEVE	SHKALLA	1:500
DRETTOR	ING. MIMOZA HAXHIU		
PERGJEGJES			
SPECIALIST	ARK. OKSANA BASHO		
SPECIALIST	ORJALD DEBINA		
SPECIALIST	ING. ARTUR SINANI		
SPECIALIST	ING. ARBEN MUCA		
SPECIALIST	ING. MALDIN CELA		
SPECIALIST	ING. KLAIDI MYZEQARI		



# DETAJ I ARMIMIT TRAREVE THEMELEVE

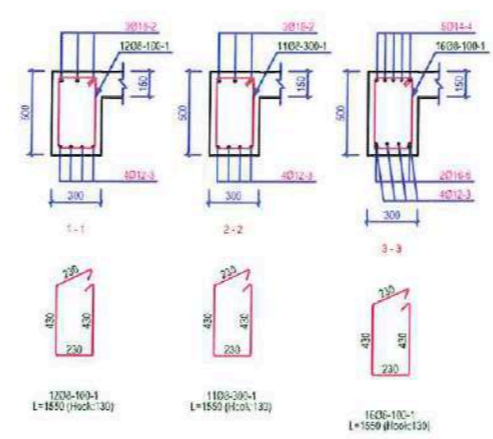
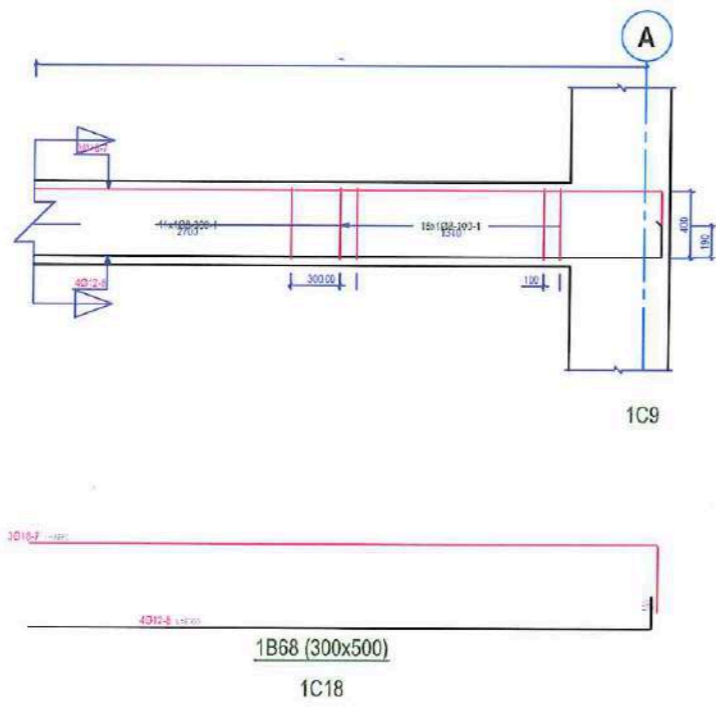
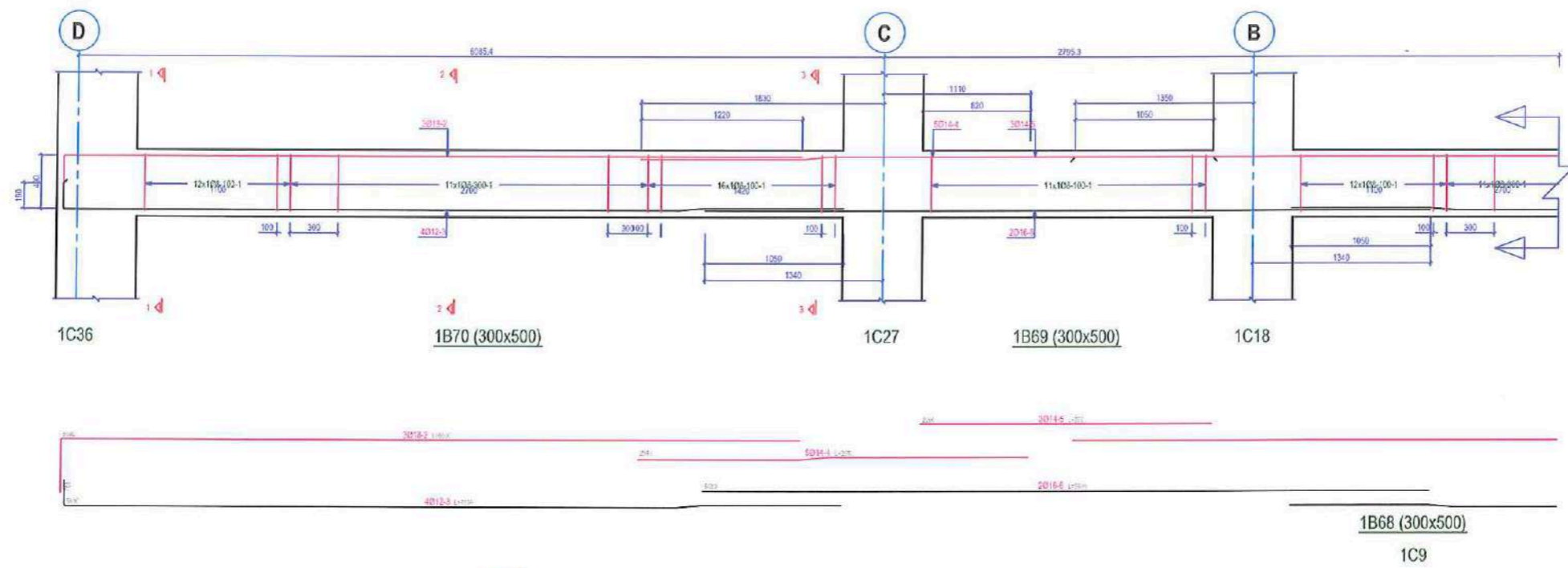

Quantity Table									
NO	SIZE	QVA	LENGTH (mm)	FORU	TOTAL LENGTH (m)				
					Ø8	Ø12	Ø14	Ø16	Ø18
1	8	85	1550	136.40					
2	18	3	6000					18.00	
3	12	4	6100	24.40					
4	14	5	2950			14.75			
5	14	3	2200			6.60			
6	15	2	5500					11.00	
7	18	3	7850						23.55
8	12	4	6000			24.00			
TOTAL LENGTH (m)					136.40	48.40	21.35	11.00	41.55
UNIT WEIGHT (kg/m)					9.40	0.59	1.21	1.58	2.00
WEIGHT (kg)					63.0	43.0	25.8	17.4	83.1
T.WEIGHT (kg)					229.2				

OBJEKTI	RINDERTIMI I SHKOLLËS 9-VJECARE "HYSEN XHEKA"	NR.FLETES	A-05
VENDNDODHJA	KARBUNARE	FORMATI	420X297
EMERT.I FLETES	DETAJ I ARMIMIT TE TRAREVE TE THEMELEVE	SHKALLA	1:500
DREJTOR	ING. MIMOZA HAXHIU		
PERGJEGJES			
SPECIALIST	ARK. OKSANA BAXHO		
SPECIALIST	ORJALD DEBINJA		
SPECIALIST	ING. ARTUR SINANI		
SPECIALIST	ING. ARBEN MUCA		
SPECIALIST	ING. MALDIN CELA		
SPECIALIST	ING. KLAJDI MYZEQARI		





# DETAJ I ARMIMIT TRAREVE KATIT PERDHE

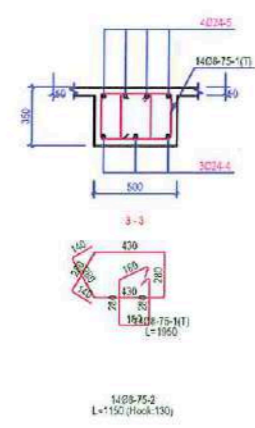
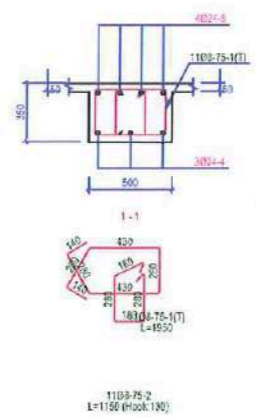
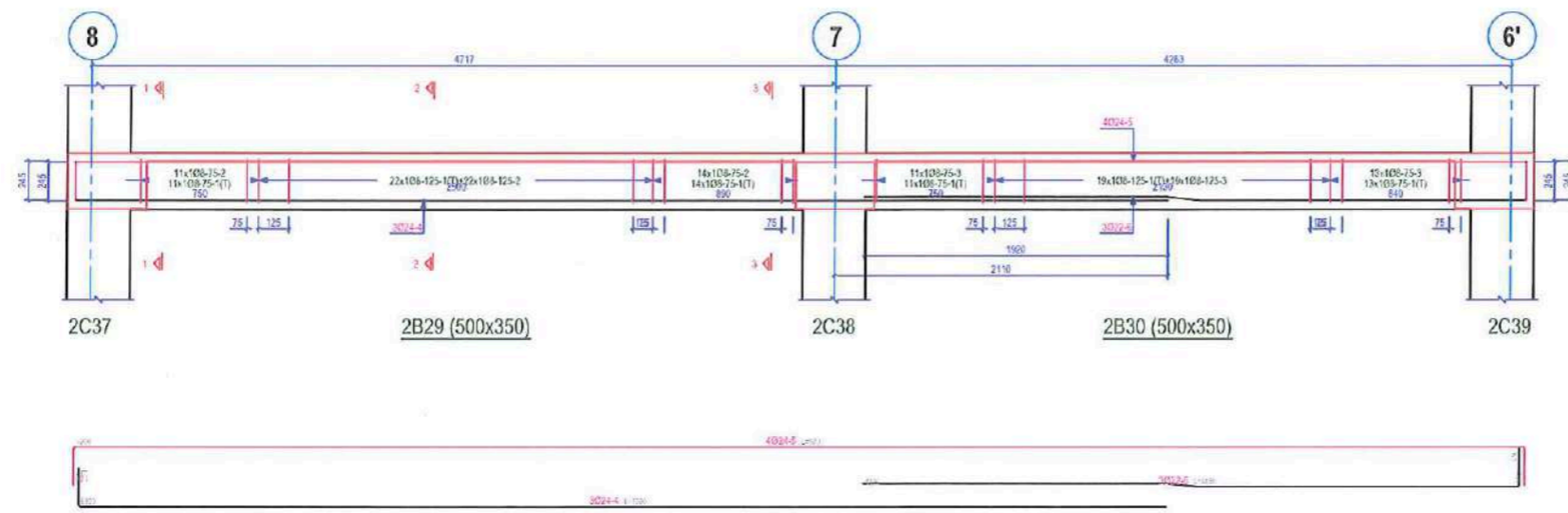

Quantity Table							
NO	SIZE	QUA	LENGTH (mm)	FORM	TOTAL LENGTH (m)		
					Q8	Q22	Q24
1	8	90	1950		175.50		
2	8	47	1150		54.65		
3	8	43	800		34.40		
4	24	3	7200				21.60
5	24	4	6700				26.80
6	22	3	4450			13.35	
TOTAL LENGTH (m)					263.95	13.35	60.40
UNIT WEIGHT (Kg/m)					0.40	2.99	3.52
WEIGHT (Kg)					104.3	39.9	214.8
T.WEIGHT (KG)					359.0		

BEAM ELEVATIONS1

Scale: 1/120

OBJEKTI	RINDERTIMI I SHKOLLËS 9-VJEÇARE "HYSEN XHEKA"	NR.FLETES	A-05
VENDNDODHJA	KARBUNARE	FORMATI	420X297
EMERT.I FLETES	DETAJ I ARMIMIT TE TRAREVE KATI PERDHE	SHKALLA	1:500
DREJTOR	ING. MIMOZA HAXHIU		
PERGJEGJES	ARK. SAIMIR MEBELLI		
SPECIALIST	ARK. OKSANA BAXHO		
SPECIALIST	ORJALD DEGINJA		
SPECIALIST	ING. ARTUR SINANI		
SPECIALIST	ING. ARBEN MUCA		
SPECIALIST	ING. MALDIN CELA		
SPECIALIST	ING. KLAJDI MYZEQARI		



# DETAJ I ARMIMIT TRAREVE KATIT PERDHE

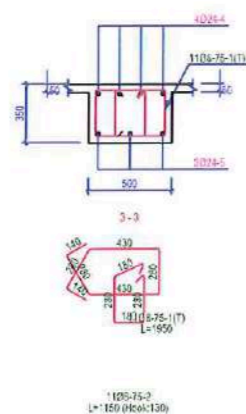
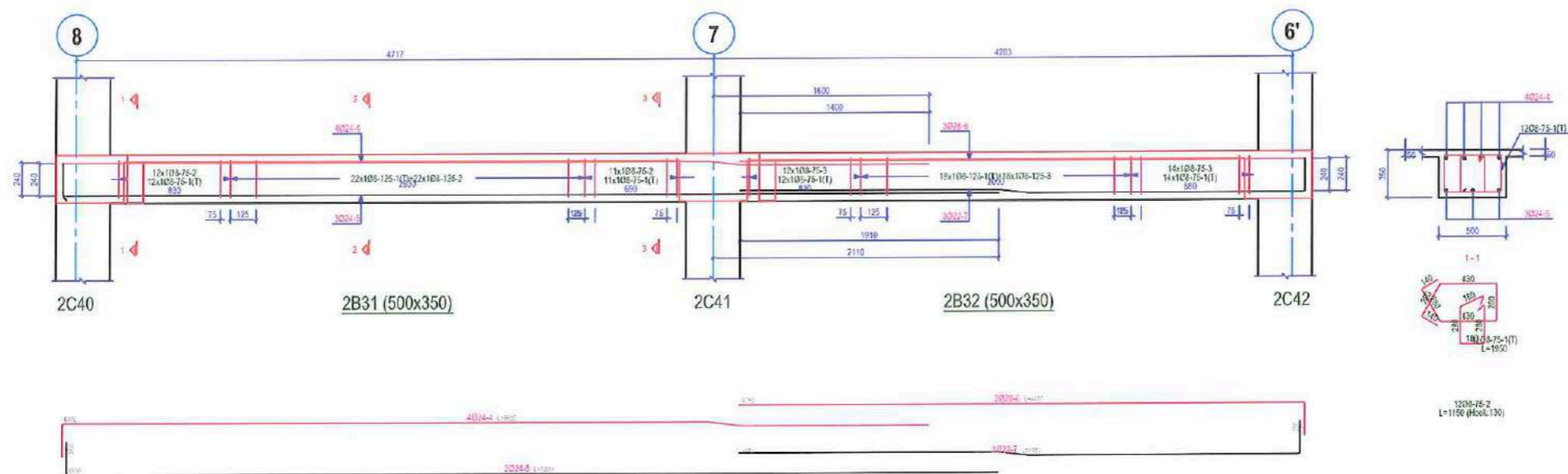

Quantity Table								
NO	SIZE	QUA	LENGTH (mm)	FORM	TOTAL LENGTH (m)			
					Ø8	Ø12	Ø14	Ø20
1	8	89	1950		173.55			
2	8	45	1150		51.75			
3	8	44	860		35.20			
4	24	4	6650				26.60	
5	24	3	7200				21.60	
6	20	3	6450					13.35
7	22	3	4450					13.35
TOTAL LENGTH (m)					260.50	13.35	48.20	13.35
UNIT WEIGHT (kg/m)					0.40	2.99	3.56	4.81
WEIGHT (kg)					102.9	39.9	171.4	64.0
T.WEIGHT (kg)					378.8			

BEAM ELEVATIONS1

Scale: 1/120

OBJEKTI	RINDERTIMI I SHKOLLES 9-VJECARE HYSEN XHEKA	NR.FLETES	A-05
VENDNDODHJA	KARBUNARE	FORMATI	420x297
EMERT.I FLETES	DETAJ I ARMIMIT TE TRAREVE KATI PERDHE	SHKALLA	1:500
DREJTOR	ING. MIMOZA HAXHIU		
PERGJEGJES	ARK. SAJMIR MEBELLI		
SPECIALIST	ARK. OKSANA BAVHO		
SPECIALIST	ORJALD DEBINJA		
SPECIALIST	ING. ARTUR SINANI		
SPECIALIST	ING. ARBEN MUCA		
SPECIALIST	ING. MALDIN CELA		
SPECIALIST	ING. KLAJDI MYZEQARI		





# DETAJ I ARMIMIT TRAREVE KATIT PERDHE

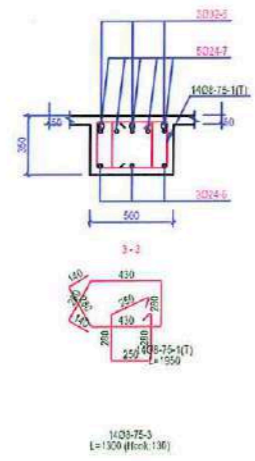
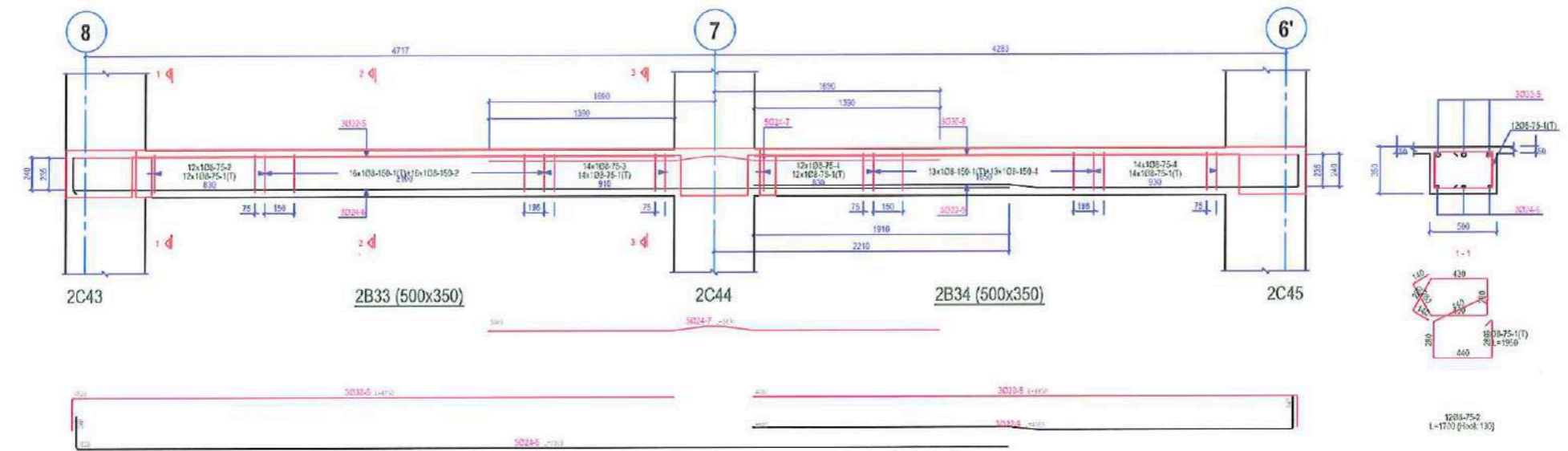

Quantity Table									
NO	SIZE	QUA	LENGTH (mm)	FORM	TOTAL LENGTH (m)				
					Ø8	Ø22	Ø24	Ø30	Ø32
1	8	81	1950		157.95				
2	8	78	1700		47.60				
3	8	14	1300		18.20				
4	8	39	800		31.20				
5	32	3	4750						14.25
6	24	3	7300				21.90		
7	24	5	3400				17.00		
8	30	3	4350						13.05
9	22	3	4350				13.05		
TOTAL LENGTH (m)					254.95	13.05	38.90	13.65	14.25
LIRIT WERKHT (kg/m)					0.40	2.59	3.56	6.56	6.32
WEIGHT (Kg)					100.7	39.0	138.3	72.5	90.1
T.WEIGHT (Kg)					440.6				

BEAM ELEVATIONS1 Scale: 1:120

OBJEKTI	RINDERTIMI I SHKOLLËS 9-VJECARE "HYSEN XHEKA"	NR.FLETES	A-05
VENDNDODHJA	KARBUNARE	FORMATI	420X297
EMERT I FLETES	DETAJ I ARMIMIT TE TRAREVE KATI PERDHE	SHKALLA	1:500
DREJTOR	ING. MIMOZA HAXHIU		
PERGJEGJES	ARK. SAIMIR MEBELLI		
SPECIALIST	ARK. OKSANA BAXHO		
SPECIALIST	ORJALD DEBINJA		
SPECIALIST	ING. ARTUR SINANI		
SPECIALIST	ING. ARBEN MUCA		
SPECIALIST	ING. MALDIN CELA		
SPECIALIST	ING. KLAJDI MYZEQARI		



# DETAJ I ARMIMIT TRAREVE KATIT PERDHE

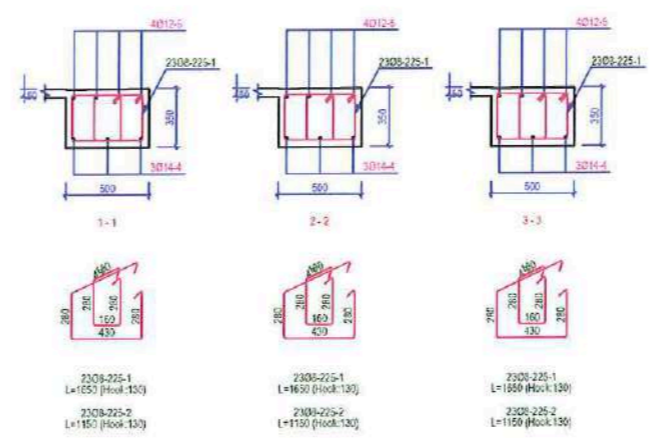
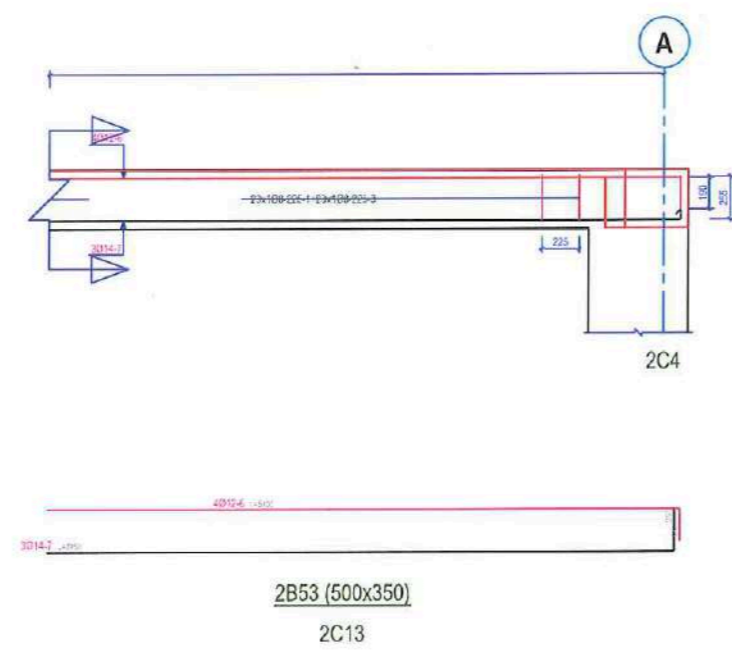
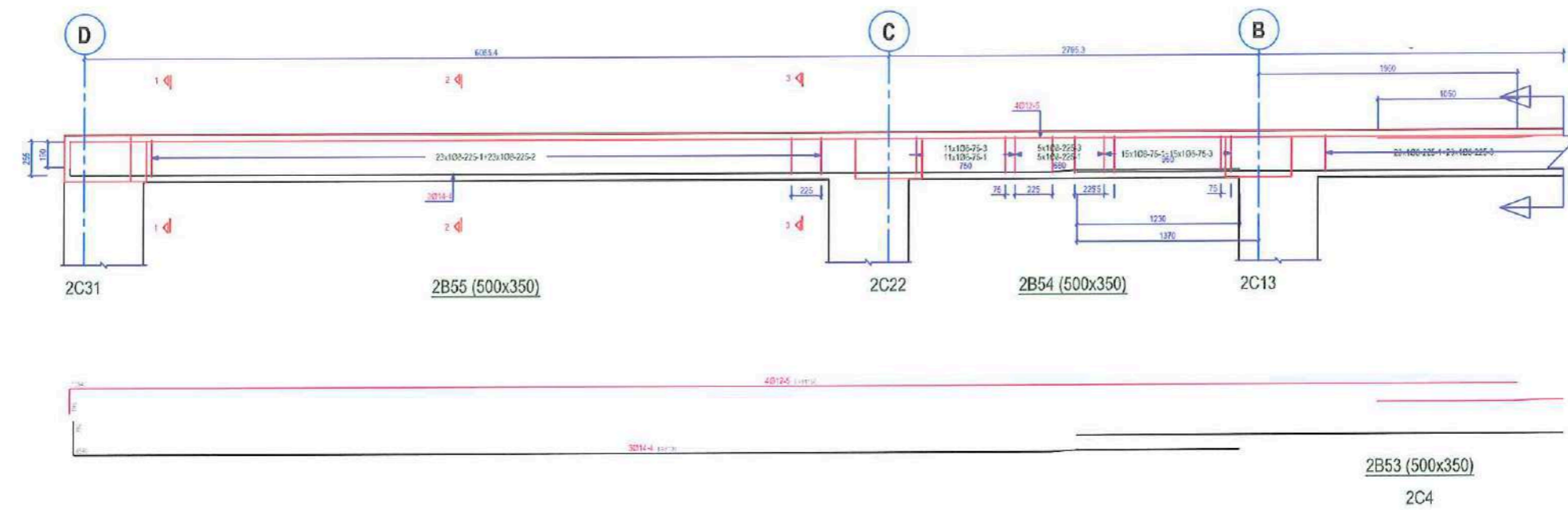

Quantity Table							
NO	SIZE	QUA	LENGTH (mm)	FORM	TOTAL LENGTH (m)		
					D8	D12	D14
1	8	77	1650		127.05		
2	8	23	1150		26.45		
3	8	54	800		43.20		
4	14	3	9100				27.30
5	12	4	11150				44.00
6	12	4	8400				21.00
7	14	3	7750				23.25
TOTAL LENGTH (m)					196.70	66.20	59.55
UNIT WEIGHT (kg/m)					0.40	0.89	1.21
WEIGHT (kg)					77.7	58.8	61.2
T.WEIGHT (kg)					197.7		

BEAM ELEVATIONS1 Scale: 1/120

OBJEKTI	RINDERTIMI I SHKOLLES 9-VJECARE "HYSEN XHEKA"	NR.FLETES	A-05
VENDNDODHJA	KARBUNARE	FORMATI	420x297
EMERT.I FLETES	DETAJ I ARMIMIT TE TRAREVE KATI PERDHE	SHKALLA	1:500
DREJTOR	ING. MIMOZA HAXHIU		
PERGJEGJES	ARK. SAIMIR MEBELLI		
SPECIALIST	ARK. OKSANA BAXHO		
SPECIALIST	DR.JALD DEBINJA		
SPECIALIST	ING. ARTUR SINANI		
SPECIALIST	ING. ARBEN MUCA		
SPECIALIST	ING. MALDIN CELA		
SPECIALIST	ING. KLAJDI MYZEQARI		





# DETAJ I ARMIMIT TRAREVE KATIT PERDHE

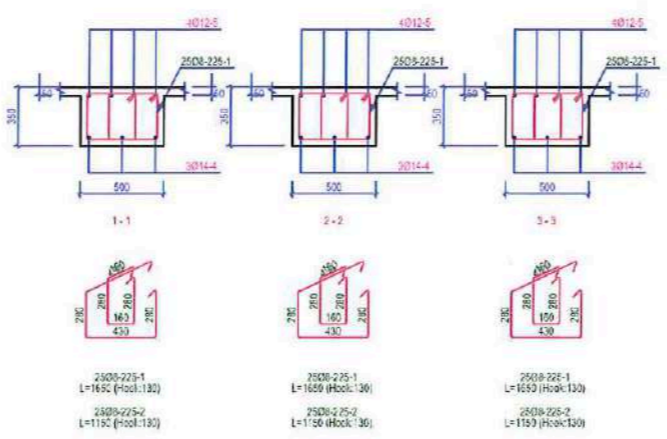
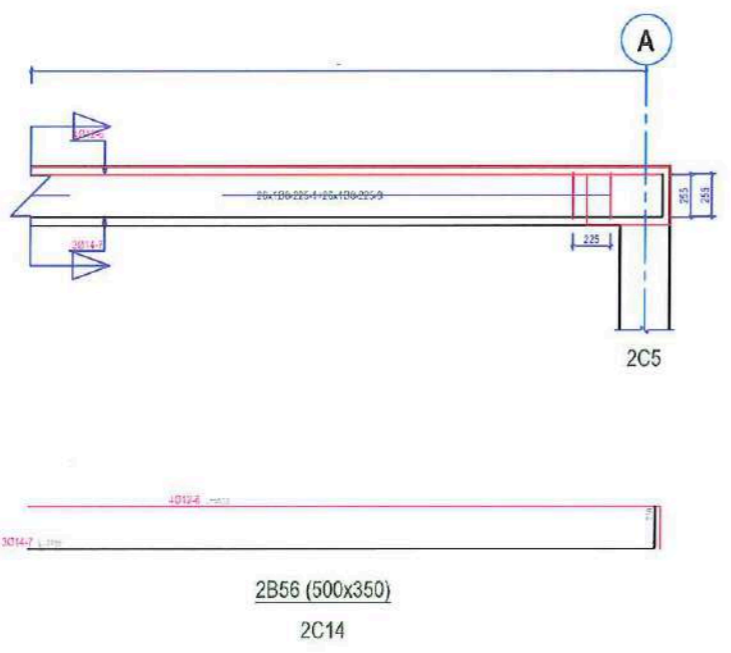
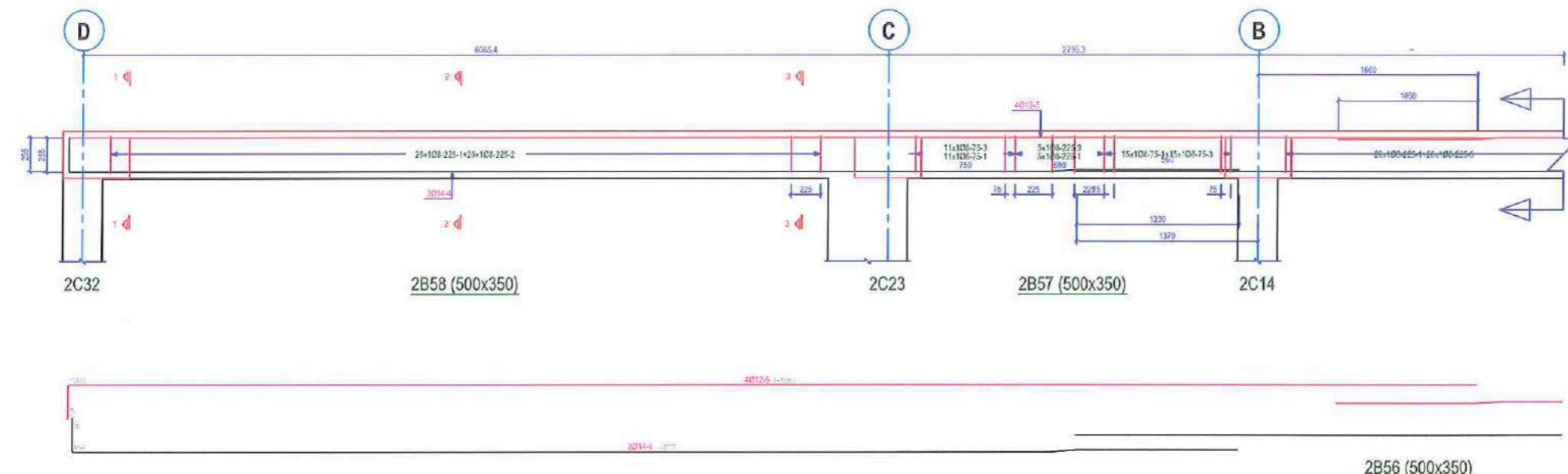

Quantity Table							
NO	SIZE	QJA	LENGTH (mm)	FORM	TOTAL LENGTH (m)		
					Ø8	Ø12	Ø14
1	8	82	1650		136.30		
2	8	25	1150		28.75		
3	8	57	500		45.60		
4	14	3	9100				27.30
5	12	4	10800				43.00
6	12	4	5800				23.20
7	14	3	7750				23.25
TOTAL LENGTH (m)					200.55	66.80	50.55
UNIT WEIGHT (kg/m)					0.40	0.89	1.21
WEIGHT (kg)					82.8	58.4	61.2
T.WEIGHT (kg)					202.4		

BEAM ELEVATIONS 1 Scale: 1:120

OBJEKTI	RINDERTIMI I SHKOLLËS 9-VJECARE "HYSEN XHEKA"	NR.FLETES	A-05
VENDNDODHJA	KARBUNARE	FORMATI	420X297
EMERT.I FLETES	DETAJ I ARMIMIT TE TRAREVE KATI PERDHE	SHKALLA	1:500
DREJTOR	ING. MIMOZA HAXHIU		
PERGJEGJES	ARK. SAJMIR MEBELLI		
SPECIALIST	ARK. OKSANA BAXHO		
SPECIALIST	ORJALD DEBINJA		
SPECIALIST	ING. ARTUR SINANI		
SPECIALIST	ING. ARBEN MUCA		
SPECIALIST	ING. MALDIN CELA		
SPECIALIST	ING. KLAJDI MYZEQARI		



# DETAJ I ARMIMIT TRAREVE KATIT PERDHE

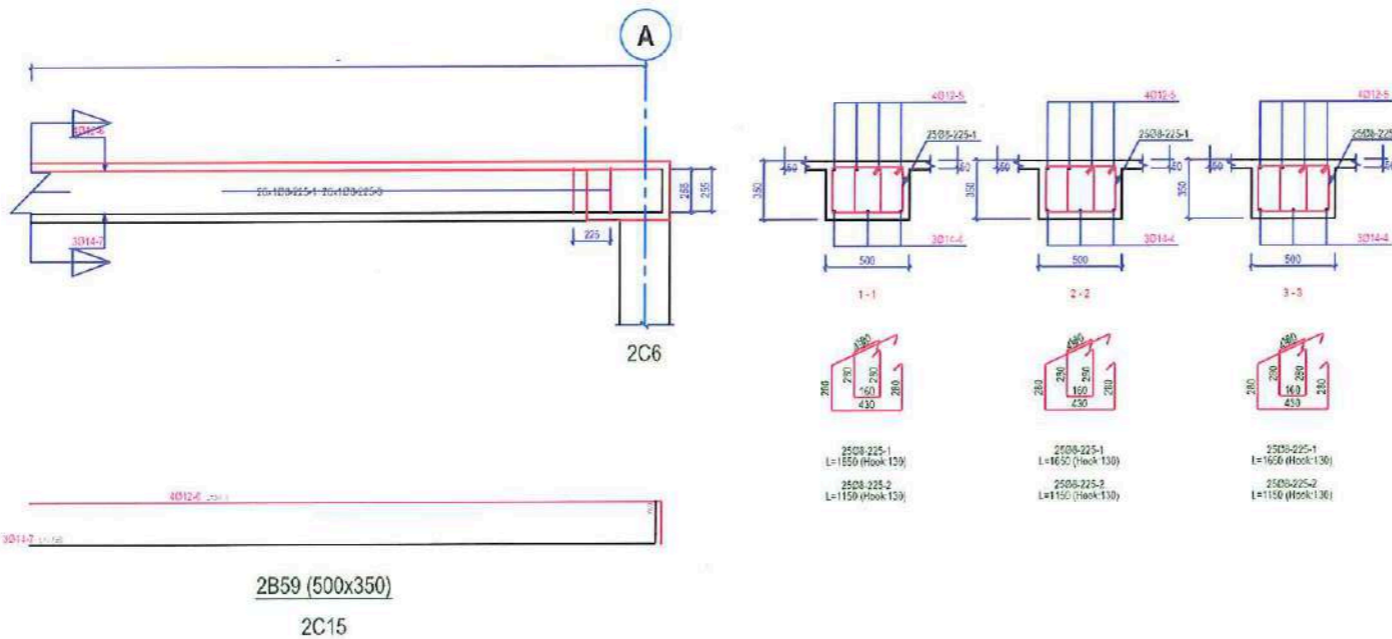
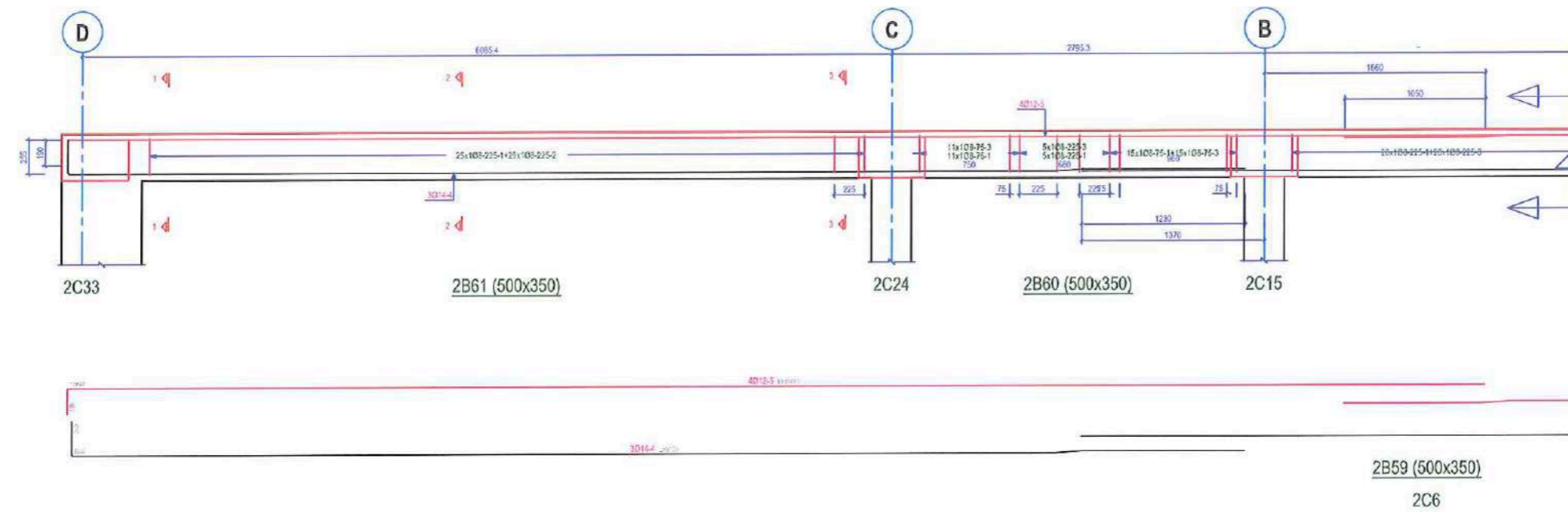

Quantity Table							
NO	SIZE	QUA	LENGTH (mm)	FORM	TOTAL LENGTH (m)		
					Ø8	Ø12	Ø14
1	8	82	1650		135.30		
2	8	25	1150		28.75		
3	8	57	800		45.60		
4	14	3	9160				27.53
5	12	4	16850				43.40
6	12	4	5000				23.20
7	14	3	7750				23.25
TOTAL LENGTH (m)					209.65	66.60	90.65
UNIT WEIGHT (kg/m)					0.40	0.85	1.21
WEIGHT (kg)					82.8	59.2	61.2
T.WEIGHT (kg)					203.2		

BEAM ELEVATIONS1

Scale: 1/120

OBJEKTI	RINDERTIMI I SHKOLLËS 9-VJECARE "HYSEN XHEKA"	NR.FLETES	A-05
VENDNDODHJA	KARBUNARE	FORMATI	420x297
EMERT.I FLETES	DETAJ I ARMIMIT TE TRAREVE KATI PERDHE	SHKALLA	1:500
DREJTOR	ING. MIMOZA HAXHIU		
PERGJEGJES	ARK. SAJMIR MEBELLI		
SPECIALIST	ARK. OXIANA BAXHO		
SPECIALIST	ORJALD DEBINJA		
SPECIALIST	ING. ARTUR SINANI		
SPECIALIST	ING. ARBEN MUCA		
SPECIALIST	ING. MALDIN CELA		
SPECIALIST	ING. KLAJDI MYZEQARI		





# DETAJ I ARMIMIT TRAREVE KATIT PERDHE

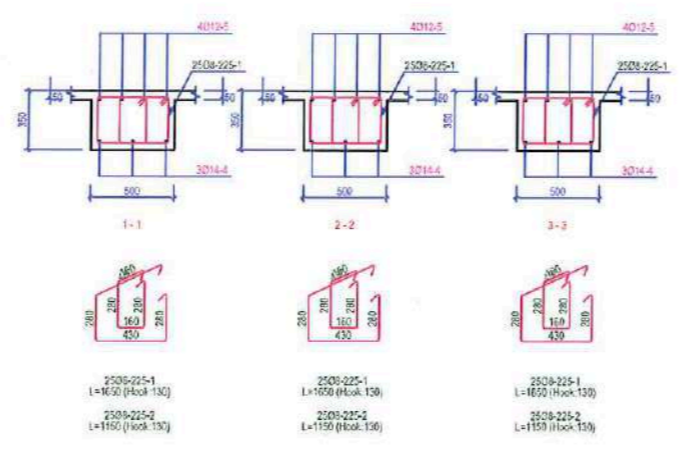
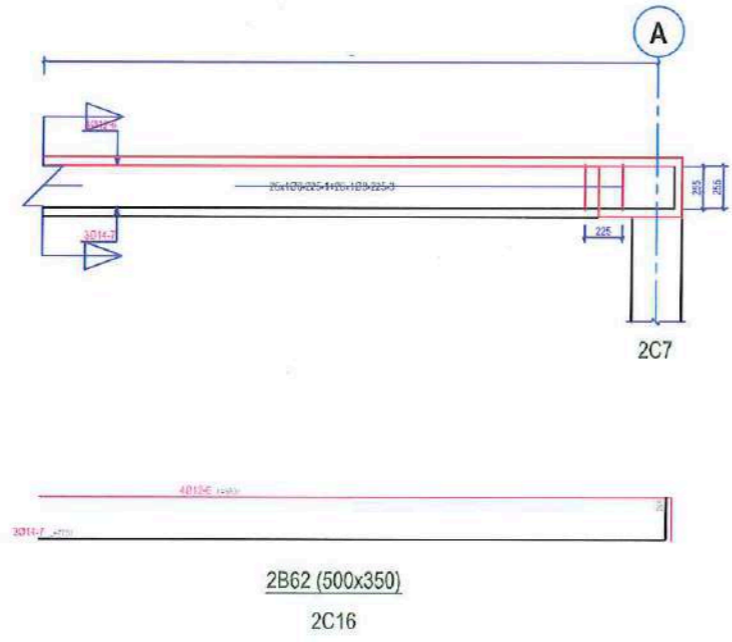
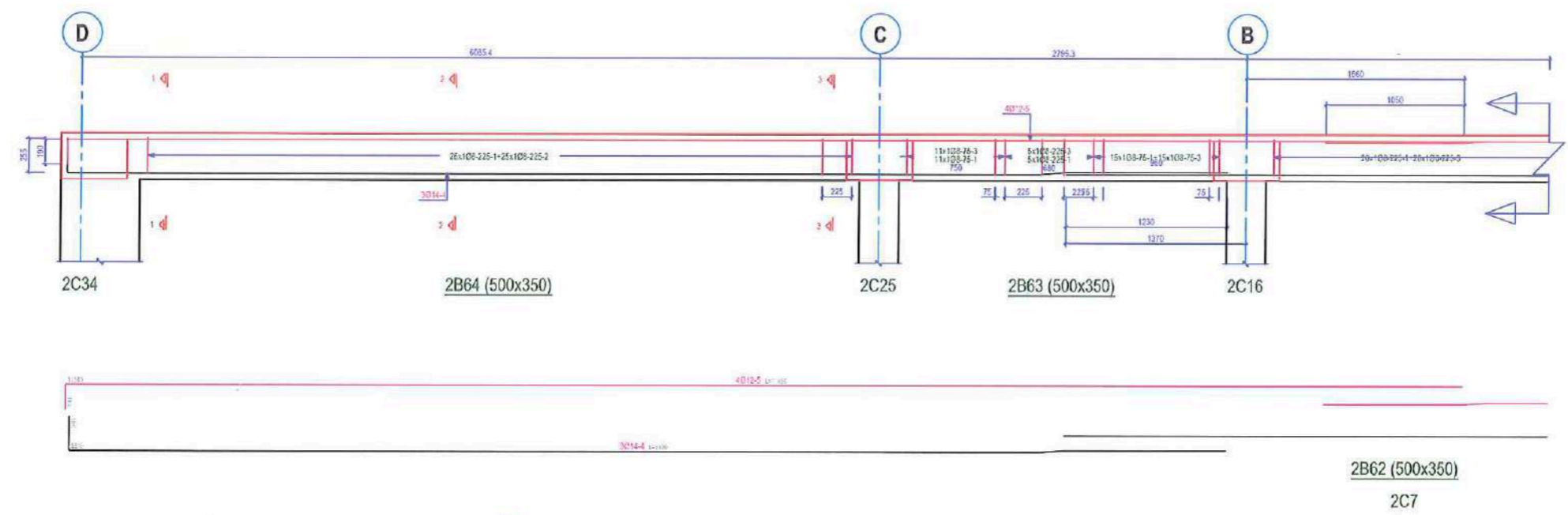

Quantity Table								
NO	SIZE	QMA	LENGTH (mm)	FORM	TOTAL LENGTH (m)			
					Ø8	Ø12	Ø14	
1	8	82	1850	100	135.30			
2	8	25	1150	100	28.75			
3	8	57	800	100	45.60			
4	14	3	9100	100		27.30		
5	12	4	10650	100		43.40		
6	12	4	5800	100		23.20		
7	14	3	7750	100			23.25	
TOTAL LENGTH (m)						200.55	66.90	60.85
UNIT WEIGHT (kg/m)						0.40	0.89	1.21
WEIGHT (kg)						82.8	59.2	61.2
T.WEIGHT (kg)								203.2

BEAM ELEVATIONS 1 Scale: 1:120

OBJEKTI	RINDERTIMI I SHKOLLËS 9-VJECARE "HYSEN XHEKA"	NR.FLETES	A-05
VENDNDODHJA	KARBUNARE	FORMATI	420x297
EMERT.I FLETES	DETAJ I ARMIMIT TE TRAREVE KATI PERDHE	SHKALLA	1:500
DIREKTOR	ING. MIMOZA HAXHIU		
PERGJEGJES	ARK. SAIMIR MEBELLI		
SPECIALIST	ARK. OKSANA BAXHO		
SPECIALIST	ORJALD DEBINJA		
SPECIALIST	ING. ARTUR SINANI		
SPECIALIST	ING. ARBEN MUCA		
SPECIALIST	ING. MALDIN CELA		
SPECIALIST	ING. KLAJDI MYZEQARI		



# DETAJ I ARMIMIT TRAREVE KATIT PERDHE

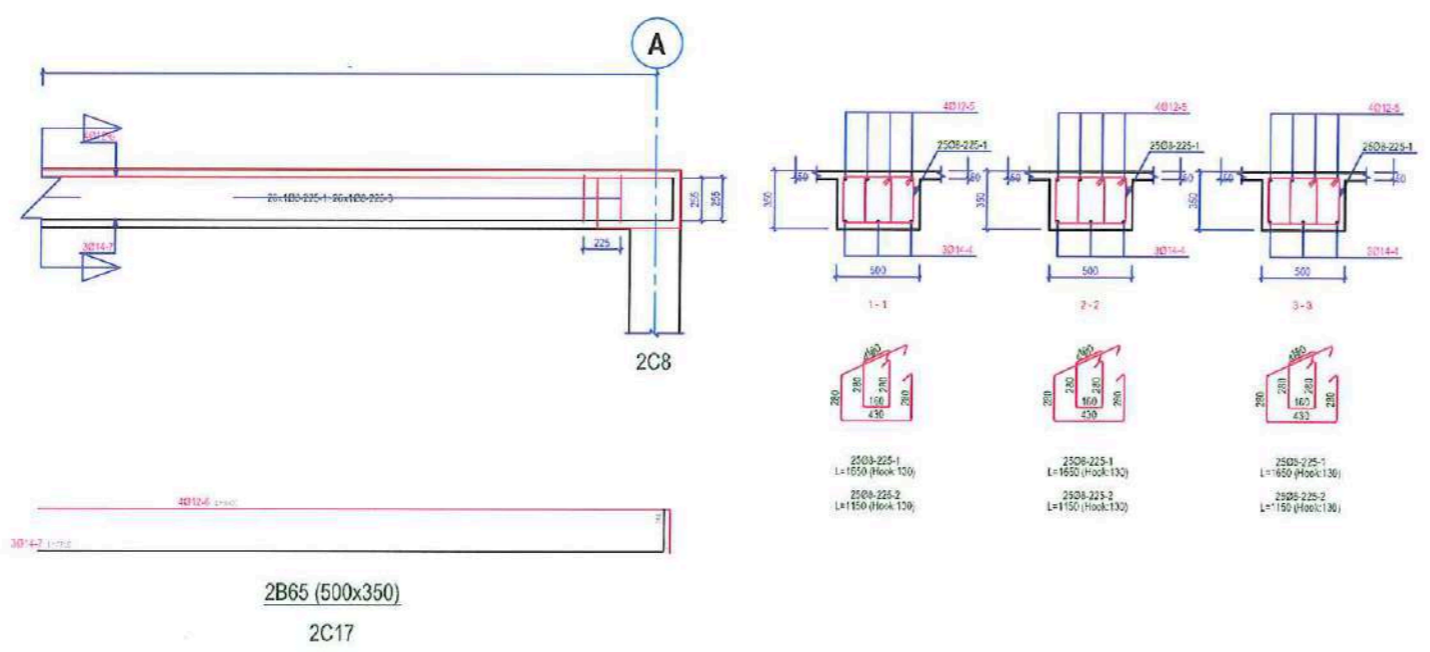
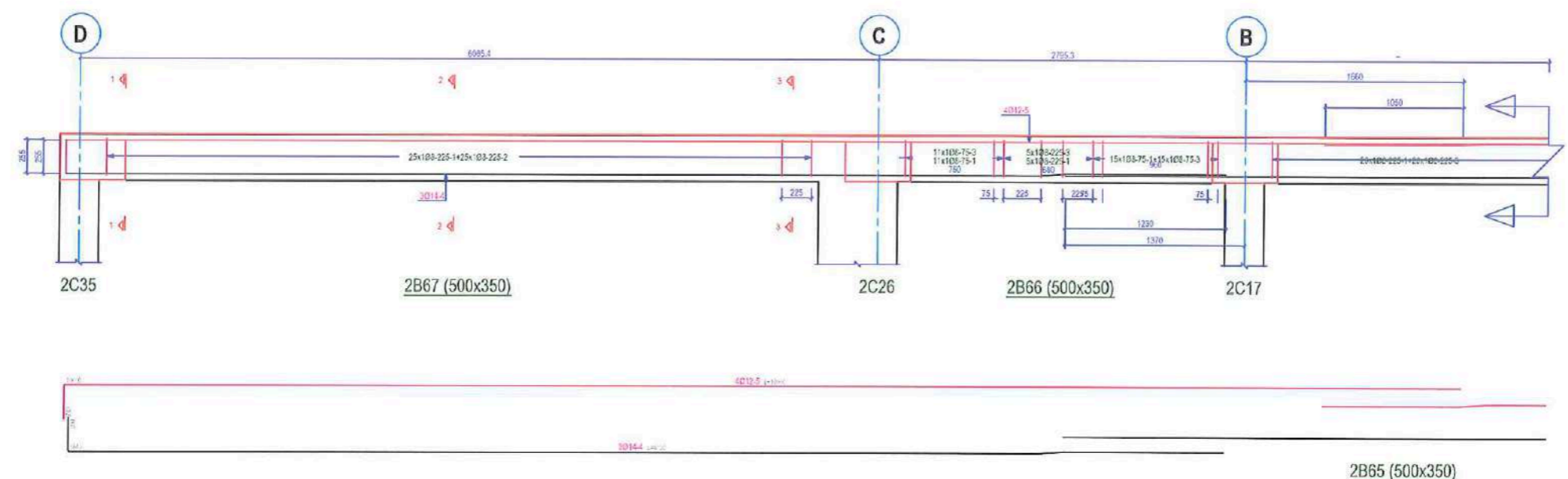

NO	SIZE	QUA	LENGTH (mm)	FORM	TOTAL LENGTH (m)		
					Ø8	Ø12	Ø14
1	8	82	1650		135.30		
2	8	25	1150		28.75		
3	8	57	800		45.60		
4	14	3	9100				27.30
5	12	4	16500				43.60
6	12	4	5000				23.20
7	14	3	7750				23.25
<b>TOTAL LENGTH (m)</b>					209.65	66.60	50.55
<b>UNIT WEIGHT (Kg/m)</b>					0.40	0.83	1.21
<b>WEIGHT (Kg)</b>					82.8	53.4	61.2
<b>T.WEIGHT (Kg)</b>					197.4		

BEAM ELEVATIONS1 Scale: 1/120

OBJEKTI	RINDERTIMI I SHKOLLES 9-VJECARE "HYSEN XHEKA"	NR.FLETES	A-05
VENDNDODHJA	KARBUNARE	FORMATI	420X297
EMERT.I FLETES	DETAJ I ARMIMIT TE TRAREVE KATI PERDHE	SHKALLA	1:500
DREJTOR	ING. NIMOZA HAXHIU		
PERGJEGJES	ARK. SAIMIR MEBELLI		
SPECIALIST	ARK. OKSANA BASHO		
SPECIALIST	ORJALD DEBINDA		
SPECIALIST	ING. ARTUR SINANI		
SPECIALIST	ING. ARBEN MUCA		
SPECIALIST	ING. MALDIN CELA		
SPECIALIST	ING. KLAJDI MYZEQARI		



# DETAJ I ARMIMIT TRAREVE KATIT PERDHE

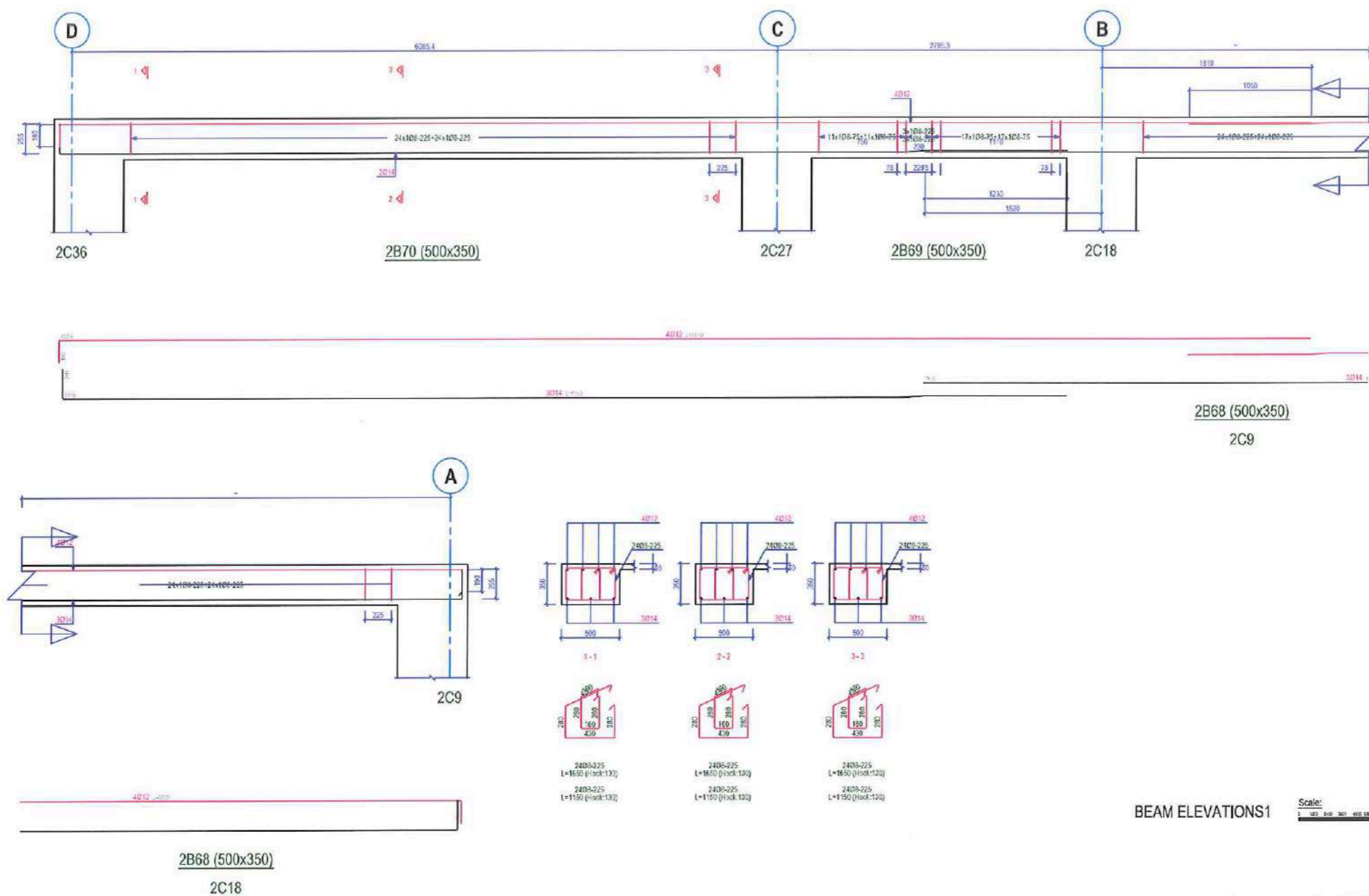

BEAM ELEVATIONS1

Scale: 1:120

OBJEKTI	RINDERTIMI I SHKOLLES 9-VJECARE "HYSEN XHEKA"	NR.FLETES	A-05
VENDNDODHJA	KARBUNARE	FORMATI	420X297
EMERT.I.FLETES	DETAJ I ARMIMIT TE TRAREVE KATI PERDHE	SHKALLA	1:500
DREJTOR	ING. NIMOZA HAXHIU	 REPUBLIKA E SHQIPERISE BASHKIA LUSHNJE	
PERGJEGJES	ARK. SAIMIR MEBELI		
SPECIALIST	ARK. OKSANA BAKHO		
SPECIALIST	ORJALD DERINJA		
SPECIALIST	ING. ARTUR SIRANI		
SPECIALIST	ING. ARBEN MUCA		
SPECIALIST	ING. MALDIN CELA		
SPECIALIST	ING. KLADI MYZEQARI		



# DETAJ I ARMIMIT TRAREVE KATIT PERDHE

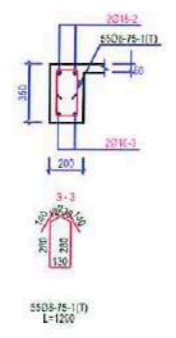
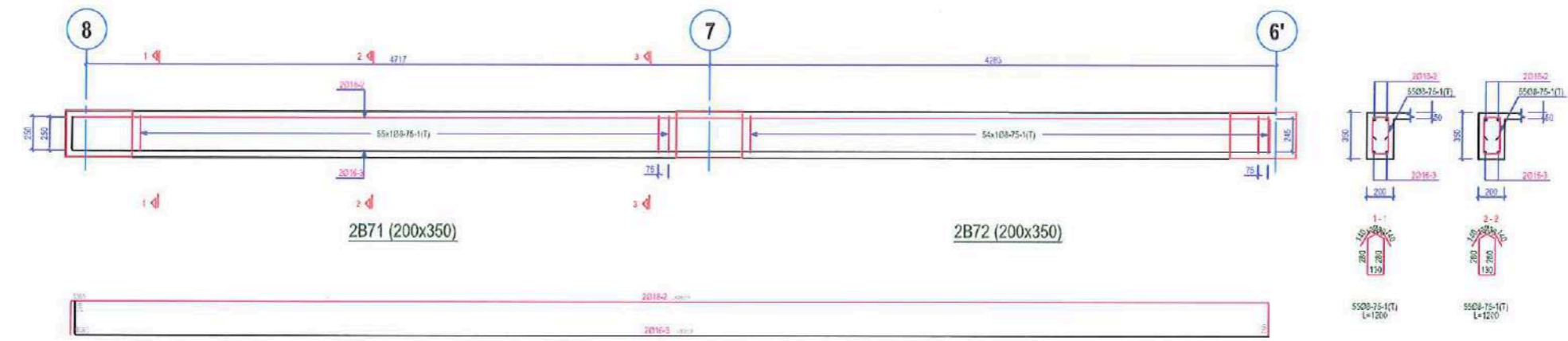

Quantity Table							
NO	SIZE	QUA	LENGTH (mm)	FORM	TOTAL LENGTH (m)		
					D15	D16	D18
1	8	100	1200		100.00		
2	16	2	9500			18.20	
3	16	2	9350			18.70	
TOTAL LENGTH (m)					130.00	18.70	18.20
UNIT WEIGHT (kg/m)					0.49	1.98	2.00
WEIGHT (kg)					51.7	29.5	38.4
T.WEIGHT (kg)					119.6		

BEAM ELEVATIONS1 Scale: 1:120

OBJEKTI	RINDERTIMI I SHKOLLES 9-VJECARE "HYSEN XHEKA"	NR.FLETES	A-05
VENDNDODHJA	KARBUNARE	FORMATI	420X297
EMERT.I FLETES	DETAJ I ARMIMIT TE TRAREVE KATI PERDHE	SHKALLA	1:500
DREJTOR	ING. MIMOZA HAXHIU		
PERGJEGJES	ARK. SAIMIR MEBELI		
SPECIALIST	ARK. OKSANA BASHO		
SPECIALIST	ORJALD DEBINA		
SPECIALIST	ING. ARTUR SINANI		
SPECIALIST	ING. ARBEN MUCA		
SPECIALIST	ING. MALDIN CELA		
SPECIALIST	ING. KLAJDI MYZEQARI		





# DETAJ I ARMIMIT TRAREVE KATIT PERDHE

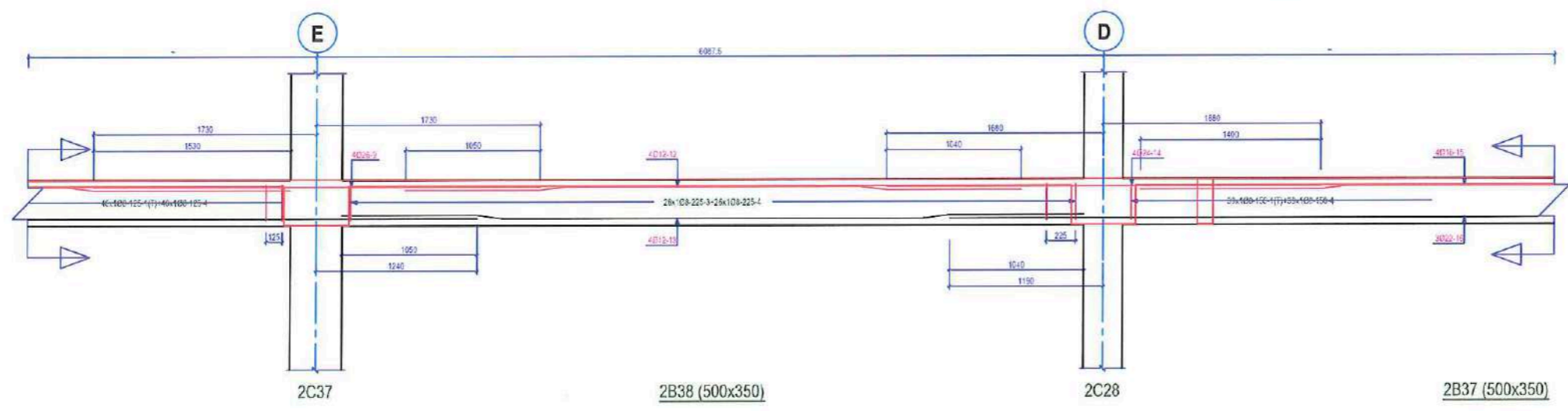
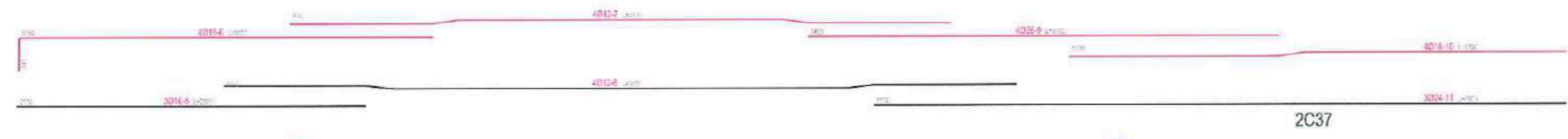
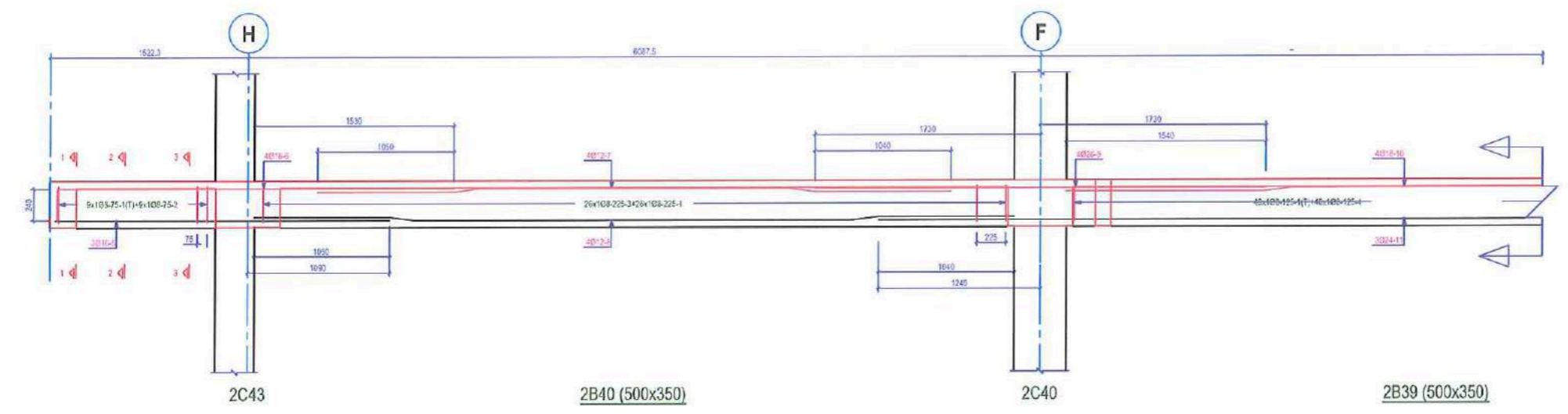

BEAM ELEVATIONS1 Scale: 1/120

OBJEKTI	RINDITIMI I SHKOLLES 9-VJECARE "HYSEN XHEKA"	NR.FLETES	A-05
VENDNDODHJA	KARBUNARE	FORMATI	420x297
EMERT I FLETES	DETAJ I ARMIMIT TE TRAREVE KATI PERDHE	SHKALLA	1:500
DREJTOR	ING. MIMOZA HAXHUU		
PERGJEGJES	ARK. SAJMIK MEBELLI		
SPECIALIST	ARK. OKSANA BASHO		
SPECIALIST	ORJALD DEBINJA		
SPECIALIST	ING. ARTUR SIMANI		
SPECIALIST	ING. ARBEN MUCA		
SPECIALIST	ING. MALDIN CELA		
SPECIALIST	ING. KLAJDI MYZEQARI		



# DETAJ I ARMIMIT TRAREVE KATIT PERDHE

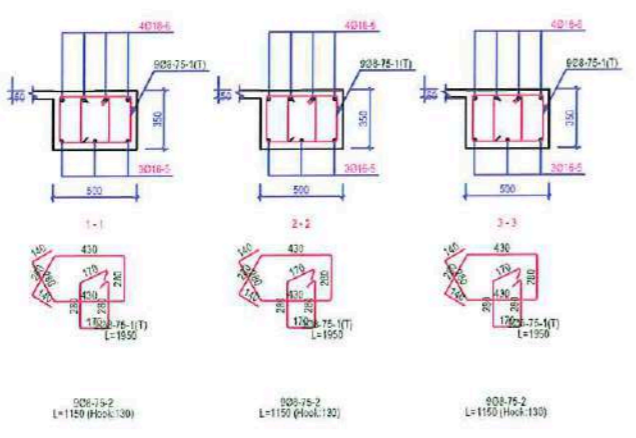
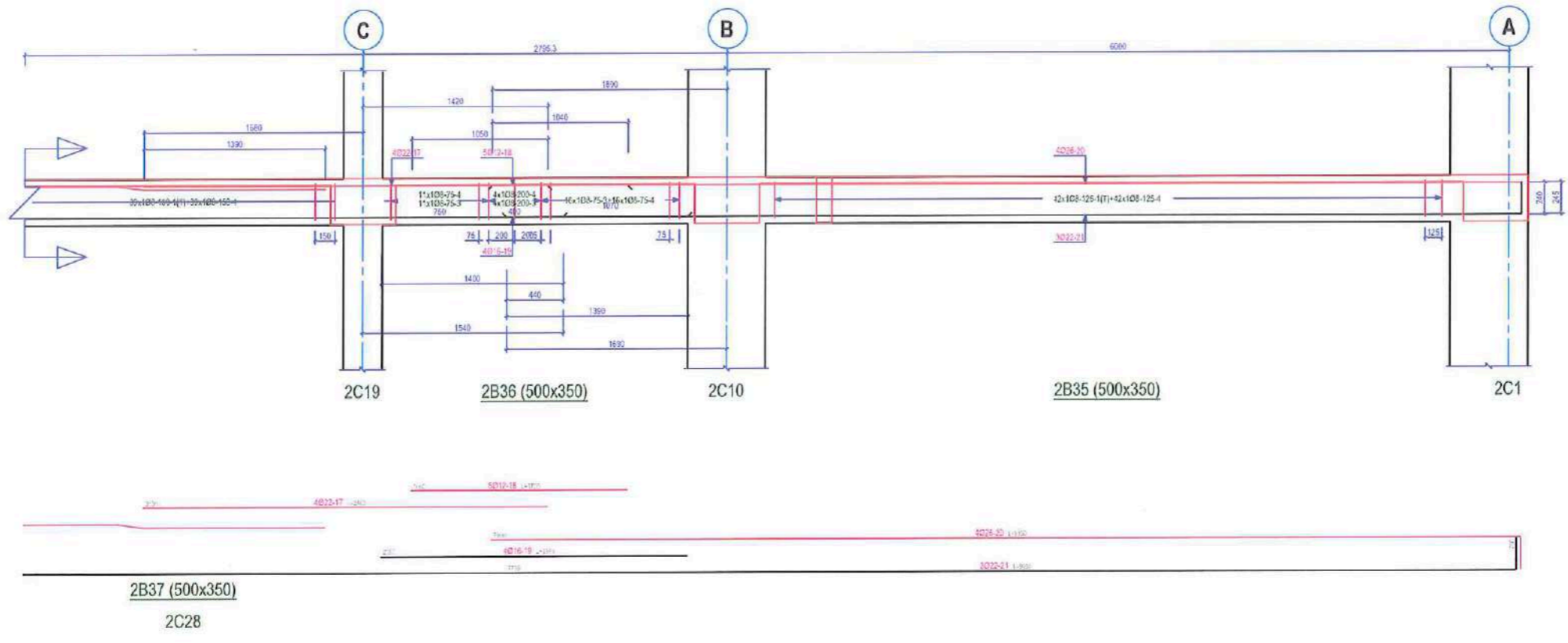

Quantity Table											
NO	SEE	QUA	LENGTH (mm)	FORM	TOTAL LENGTH (m)						
					Ø8	Ø12	Ø16	Ø18	Ø22	Ø24	Ø25
1	8	130	1650	Ø8	265.20						
2	8	9	1150	Ø8	19.35						
3	8	83	1650	Ø8	136.95						
4	8	210	800	Ø8	168.00						
5	16	3	2500	Ø16			7.80				
6	16	4	3300	Ø16				13.20			
7	12	4	1900	Ø12		15.60					
8	12	4	5550	Ø12		23.40					
9	26	8	3000	Ø26							25.00
10	18	4	3700	Ø18				22.80			
11	24	3	6500	Ø24							25.60
12	12	4	1800	Ø12		15.20					
13	12	4	5750	Ø12		23.00					
14	24	4	3400	Ø24						13.60	
15	16	4	5550	Ø16			22.20				
16	22	3	8250	Ø22						26.55	
17	22	4	3100	Ø22						12.40	
18	12	5	1700	Ø12		8.50					
19	16	4	2350	Ø16			5.40				
20	20	4	8150	Ø20							32.60
21	22	3	8050	Ø22						24.15	
TOTAL LENGTH (m)					580.20	93.70	39.40	38.00	53.10	39.40	62.60
UNIT WEIGHT (Kg/m)					0.40	0.89	1.58	2.00	2.99	3.56	4.17
WEIGHT (Kg)					229.3	83.3	62.3	72.0	158.6	140.1	262.0
TOTAL WEIGHT (Kg)					1,028.4						

BEAM ELEVATIONS1 Scale: 1/120

OBJEKTI	RINDERTIMI I SHKOLLËS 9-VJECARE "HYSEN XHEKA"	NR.FLETES	A-05
VENDNDODHJA	KARBUNARE	FORMATI	420x297
EMERT I FLETES	DETAJ I ARMIMIT TE TRAREVE KATI PERDHE	SHKALLA	1:500
DREJTOR	ING. MIMOZA HAXHILU		
PERGJEGJES	ARK. SAJMIR MEBELLI		
SPECIALIST	ARK. OKSANA BAXHO		
SPECIALIST	ORJALD DEBINJA		
SPECIALIST	ING. ARTUR SINANI		
SPECIALIST	ING. ARBEN MUCA		
SPECIALIST	ING. MALDIN CELA		
SPECIALIST	ING. KLAJDI MYZEQARI		



# DETAJ I ARMIMIT TRAREVE KATIT PERDHE

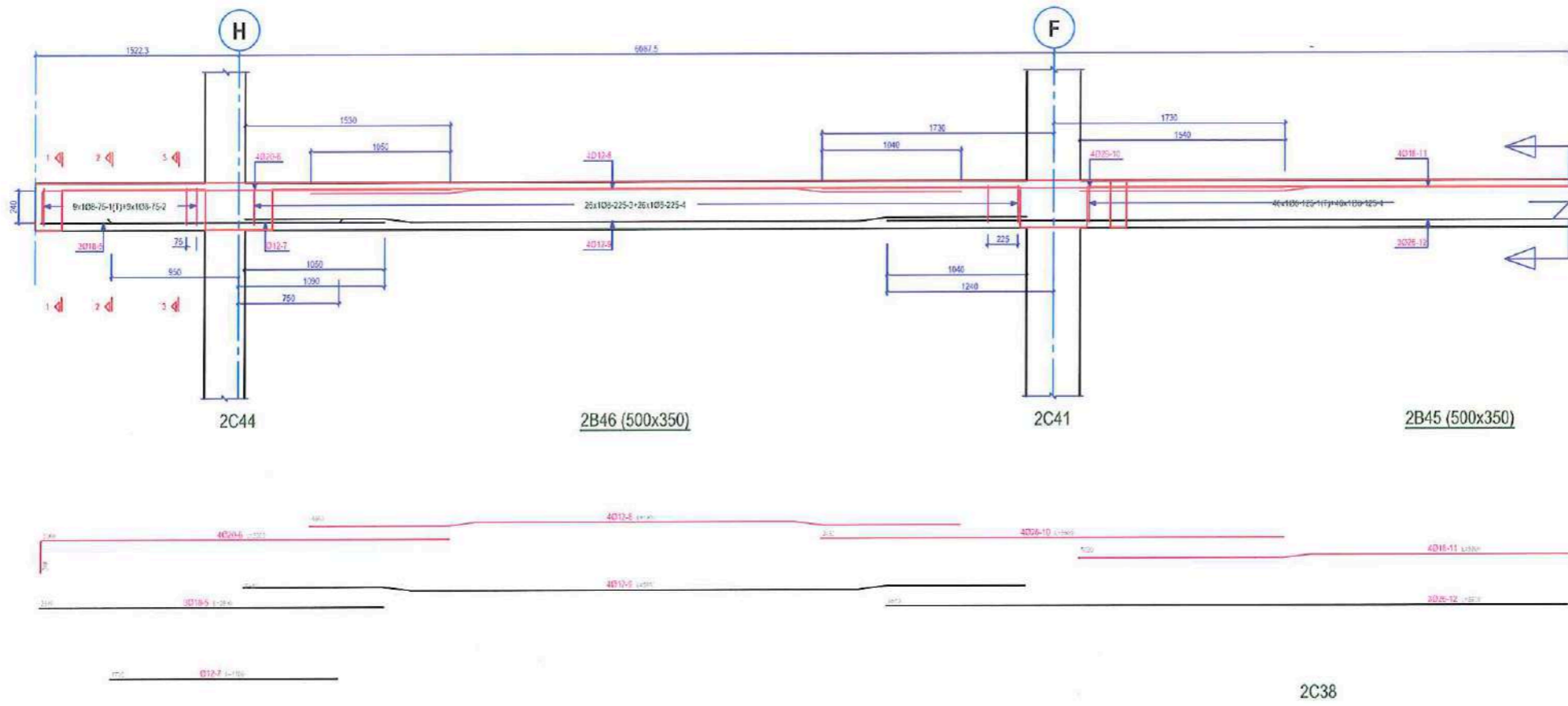

BEAM ELEVATIONS1 Scale: 1/120

OBJEKTI	RINDERTIMI I SHKOLLËS 9-VJECARE "HYSEN XHEKA"	NR.FLETES	A-05
VENDNDODHJA	KARBUNARE	FORMATI	420x297
EMERT I FLETES	DETAJ I ARMIMIT TE TRAREVE KATI PERDHE	SHKALLA	1:500
DREJTOR	ING. MIMOZA HAXHIU		
PERGJEGJES	ARK. SAJMIR MEBELI		
SPECIALIST	ARK. OKSANA BASHO		
SPECIALIST	ORJALD DEBINA		
SPECIALIST	ING. ARTUR SINANI		
SPECIALIST	ING. ARBEN MUCA		
SPECIALIST	ING. MALDIN CELA		
SPECIALIST	ING. KLAJDI MYZEQARI		







# DETAJ I ARMIMIT TRAREVE KATIT PERDHE

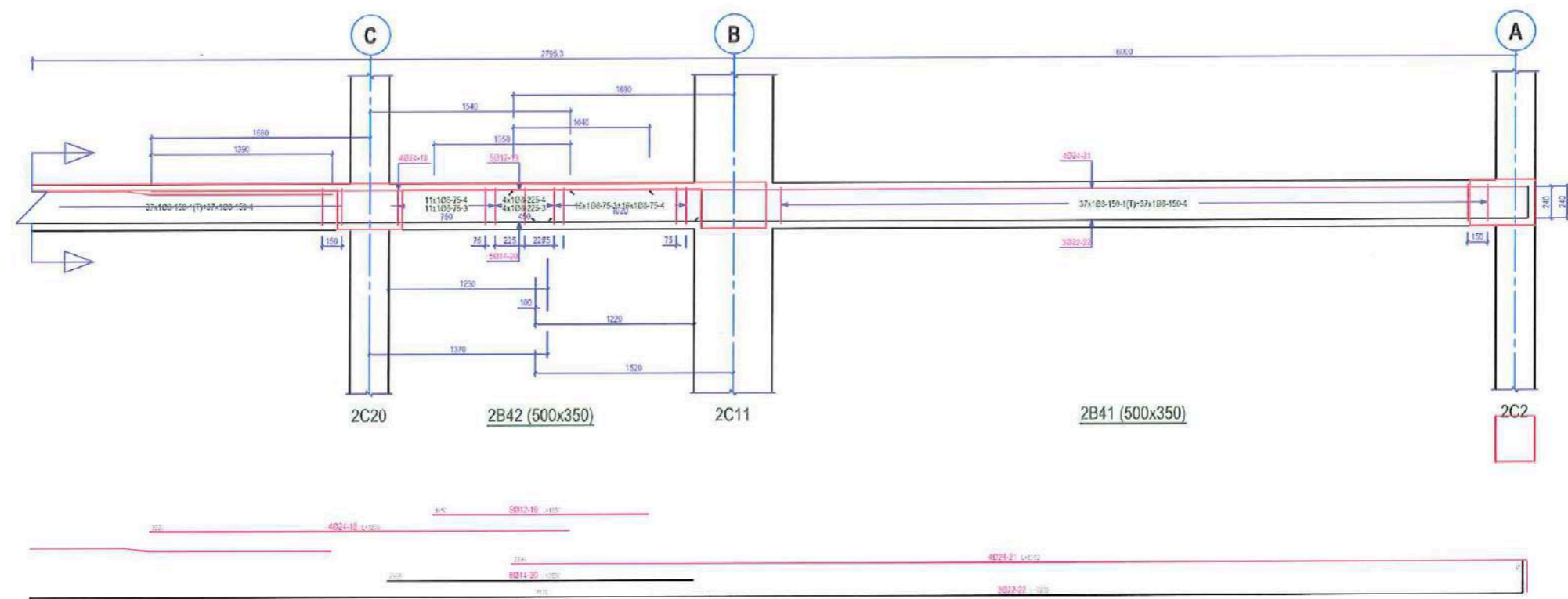

2B43 (500x350)  
2C29

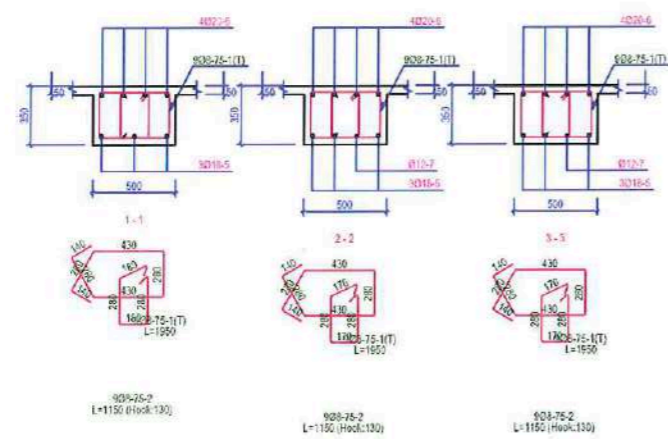

Quantity Table																				
NO	SIZE	QUA	LENGTH (m)	FORM	TOTAL LENGTH (m)															
					Ø8	Ø12	Ø14	Ø16	Ø18	Ø20	Ø22	Ø24	Ø26							
1	8	129	1050		251.55															
2	8	18	1150		20.70															
3	8	83	1550		136.95															
4	8	203	800		162.40															
5	18	3	2950							7.80										
6	20	4	3300								13.20									
7	12	1	1700			1.70														
8	12	4	4300			19.60														
9	12	4	5850			23.40														
10	20	8	3500																28.00	
11	18	4	5700							22.80										
12	26	3	8600																25.80	
13	12	4	4800			10.20														
14	12	4	5750			23.00														
15	20	4	3700																14.80	
16	16	4	5250						21.00											
17	22	3	6650															23.90		
18	24	4	3250																13.00	
19	12	5	1650		8.25															
20	14	5	2350			11.75														
21	24	4	8050																32.20	
22	22	3	7900																23.70	
TOTAL LENGTH (m)					671.60	95.45	11.75	21.00	30.60	13.20	49.65	45.20	65.00							
UNIT WEIGHT (Kg/m)					0.40	0.69	1.21	1.58	2.00	2.47	2.99	3.56	4.17							
WEIGHT (Kg)					225.8	66.6	14.2	33.2	61.2	32.6	149.3	160.7	266.3							
T.WEIGHT (Kg)					1,046.9															

BEAM ELEVATIONS1

Scale: 1:120

OBJEKTI	RINDERTIMI I SHKOLLËS 9-VJECARE "HYSEN XHEKA"	NR.FLETES	A-05
VENDNDODHJA	KARBUNARE	FORMATI	420X297
		SHKALLA	1:500
EMERT I FLETES	DETAJ I ARMIMIT TE TRAREVE KATI PERDHE		
DREJTOR	ING. MIMOZA HAXHIU		
PERGJEGJES	ARK. SAJMIR MEBELLI		
SPECIALIST	ARK. OKSANA BASHO		
SPECIALIST	ORJALD DEBINJA		
SPECIALIST	ING. ARTUR SINANI		
SPECIALIST	ING. ARBEN MUCA		
SPECIALIST	ING. MALDIN CELA		
SPECIALIST	ING. KLAJDI MYZEQARI		



# DETAJ I ARMIMIT TRAREVE KATIT PERDHE

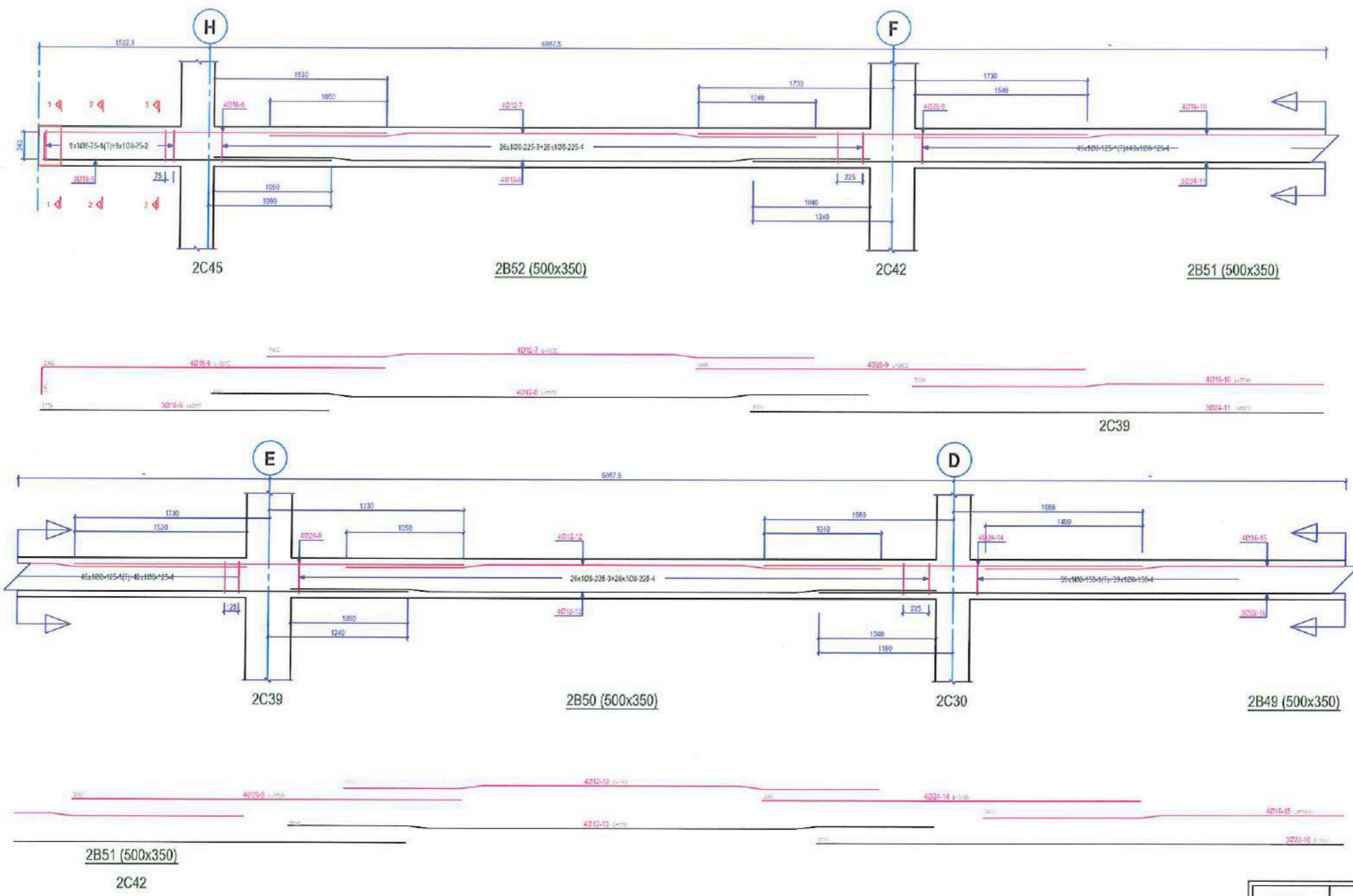

BEAM ELEVATIONS1

Scale: 1/120

OBJEKTI	RINDERTIMI I SHKOLLES 9-VJEKARE "HYSEN XHEKA"	NR.FLETES	A-05
VENDNDODHJA	KARBUNARE	FORMATI	420X297
EMERT.I FLETES	DETAJ I ARMIMIT TE TRAREVE KATI PERDHE	SHKALLA	1:500
DREJTOR	ING. MIMOZA HAXHIU		
PERGJEGJES	ARK. SAIMIR HEBELI		
SPECIALIST	ARK. OKSANA BASHO		
SPECIALIST	ORJALD DEBINA		
SPECIALIST	ING. ARTUR SINANI		
SPECIALIST	ING. ARBEN MUCA		
SPECIALIST	ING. MALDIN CELA		
SPECIALIST	ING. KLAJDI MYZEQARI		



# DETAJ I ARMIMIT TRAREVE KATIT PERDHE

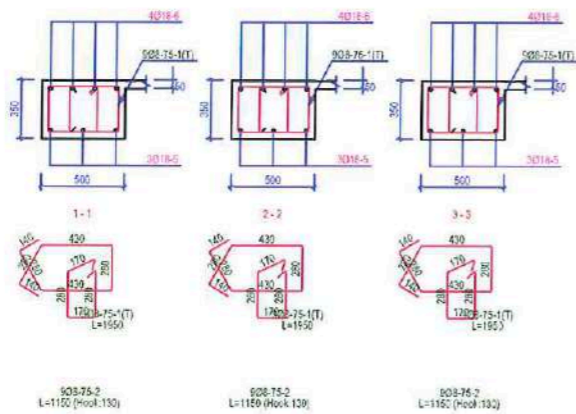
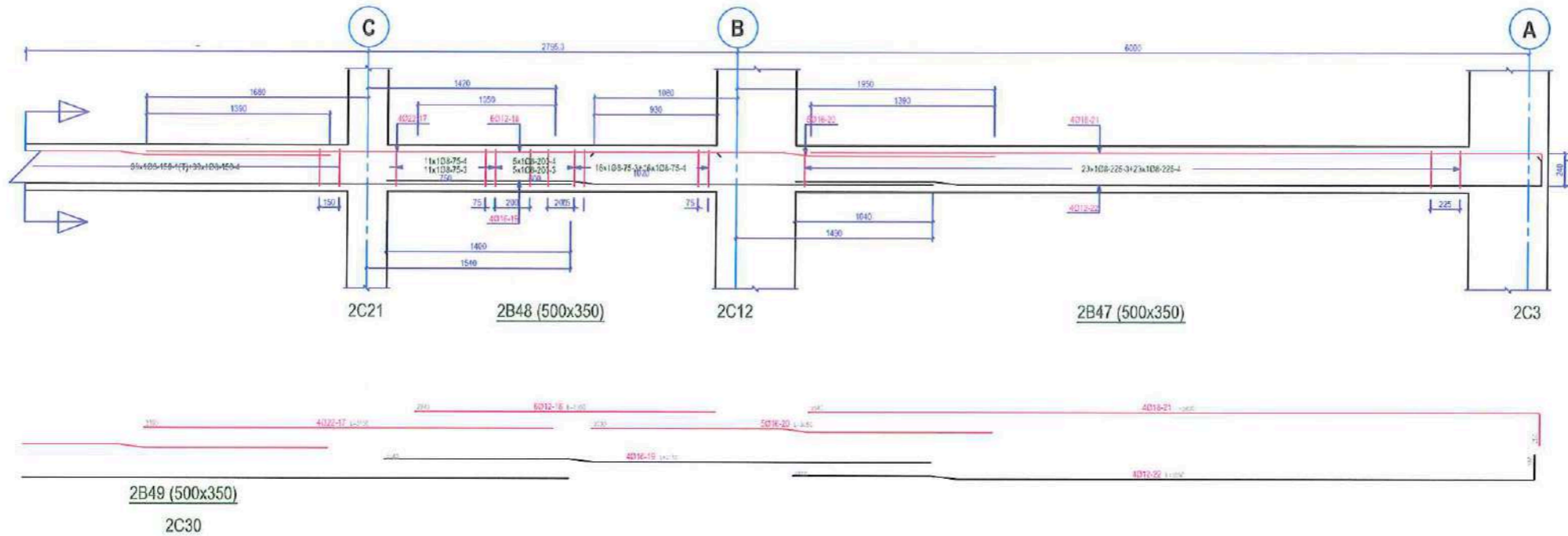

Quantity Table											
NO	SIZE	DUA	LENGTH (mm)	FORM	TOTAL LENGTH (m)						
					Ø8	Ø12	Ø16	Ø18	Ø22	Ø25	Ø28
1	8	Ø4	1950		183.50						
2	8	Ø9	1150		10.35						
3	8	Ø107	1650		176.55						
4	8	Ø12	600		153.60						
5	16	Ø3	2800					7.80			
6	16	Ø4	3900					13.20			
7	12	Ø4	4300			16.60					
8	12	Ø4	5850			23.40					
9	25	Ø8	3900							28.00	
10	16	Ø4	6700					22.80			
11	24	Ø3	8500							25.80	
12	12	Ø4	4800			15.20					
13	12	Ø4	5750			23.00					
14	24	Ø4	3400							13.60	
15	16	Ø4	5500				22.20				
16	22	Ø3	5850					26.55			
17	22	Ø4	3100					12.40			
18	12	Ø6	2300			13.80					
19	16	Ø4	4150			16.60					
20	16	Ø5	3650			15.25					
21	18	Ø4	5000				23.20				
22	12	Ø4	5850			23.40					
TOTAL LENGTH (m)					523.80	122.40	51.20	67.60	38.95	39.10	28.00
UNIT WEIGHT (kg/m)					0.49	0.83	1.58	2.00	2.99	3.56	4.17
WEIGHT (kg)					256.9	103.8	85.4	134.0	116.4	140.1	116.8
T.WEIGHT (kg)					968.4						

BEAM ELEVATIONS1 Scale: 1/120

OBJEKTI	RINDERTIMI I SHKOLLËS 9-VJECARE "HYSEN XHEKA"	NR.FLETES	A-05
VENDNDODHJA	KARBUNARE	FORMATI	420X297
EMERT.I FLETES	DETAJ I ARMIMIT TE TRAREVE KATI PERDHE	SHKALLA	1:500
DREJTOR	ING. NIMOZA HAXHIU		
PERGJEGJES	ARK. SAIMIR MEBELLI		
SPECIALIST	ARK. OXSANA BAXHO		
SPECIALIST	ORJALD DEBINJA		
SPECIALIST	ING. ARTUR SINANI		
SPECIALIST	ING. ARBEN MUCA		
SPECIALIST	ING. MALDIN CELA		
SPECIALIST	ING. KLAJDI MYZEQARI		



# DETAJ I ARMIMIT TRAVETES NE SOLETEN KATIT PERDHE

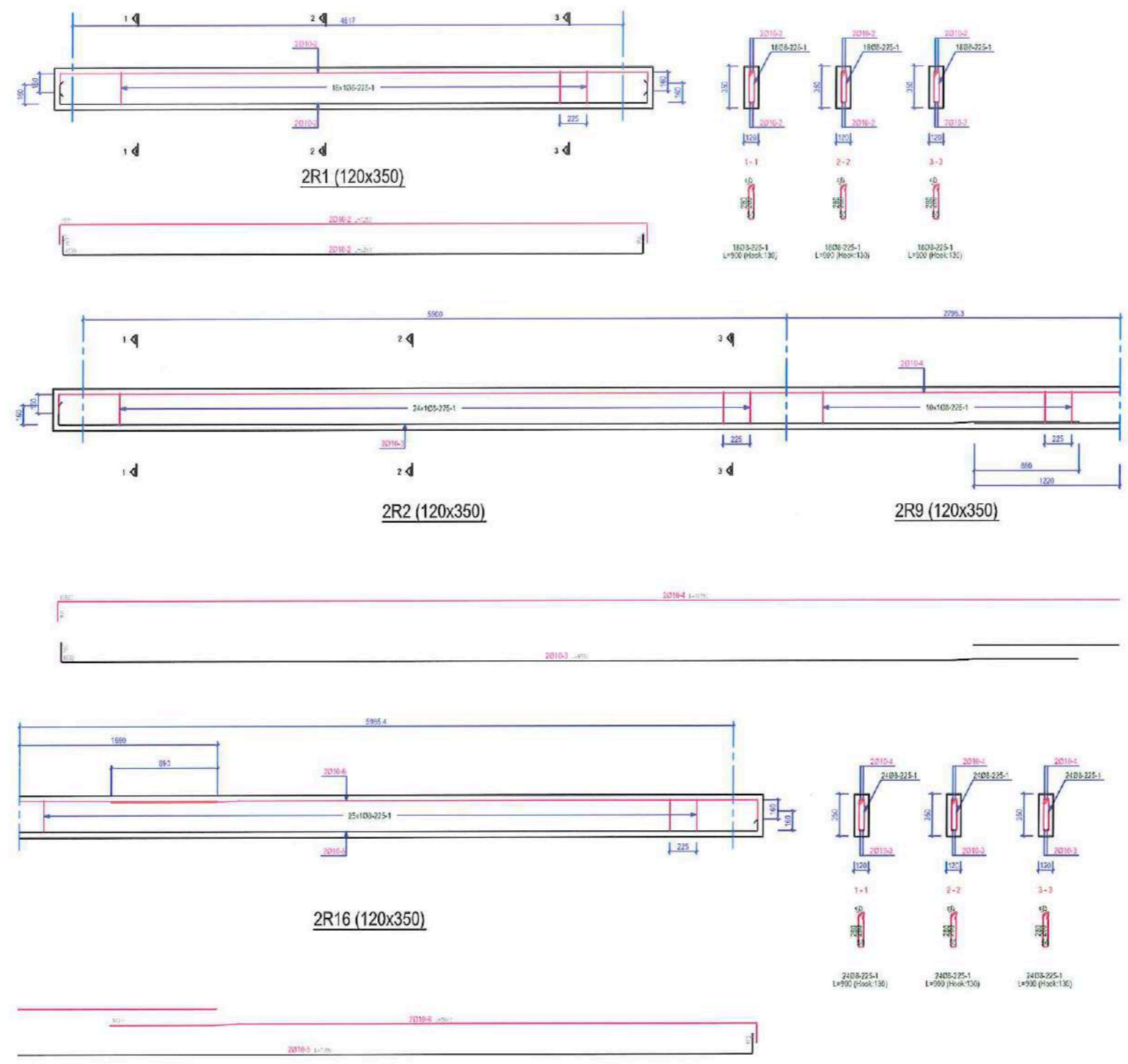

OBJEKTI	RINDERTIMI I SHKOLLËS 9-VJEÇARE "HYSEN XHEKA"	NR.FLETES	A-05
VENDNDODHJA	KARBUNARE	FORMATI	420X297
EMERT.I FLETES	DETAJ I ARMIMIT TE TRAVETES NE SOLETEN E K PERDHE	SHKALLA	1:500
DREJTOR	ING. MIMOZA HAXHIU		
PERGJEGJES	ARK. SAIMIR MEBELLI		
SPECIALIST	ARK. OKSANA BAXHIO		
SPECIALIST	ORJALD DEBINJA		
SPECIALIST	ING. ARTUR SINANI		
SPECIALIST	ING. ARBEN MUCA		
SPECIALIST	ING. MALDIN CELA		
SPECIALIST	ING. KLAJDI MYZEQARI		



# DETAJ I ARMIMIT TRAVETES NE SOLETEN KATIT PERDHE

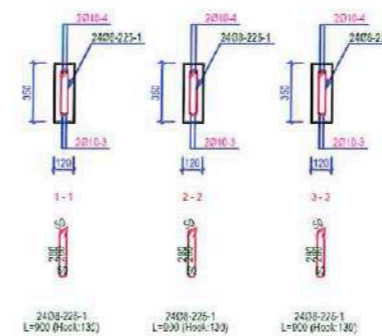
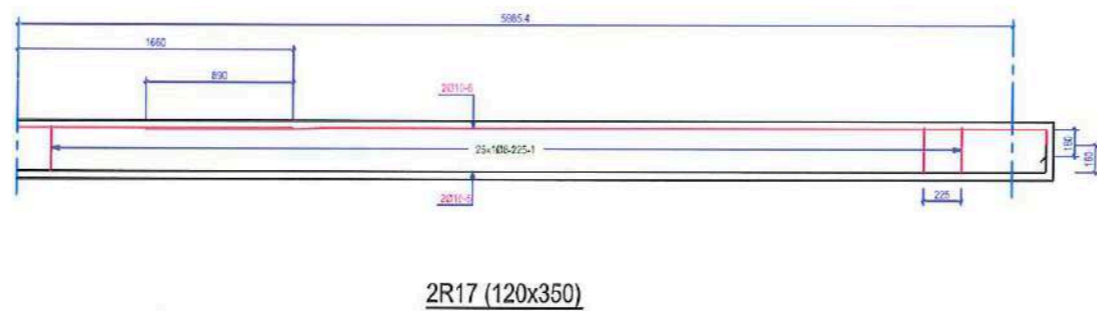
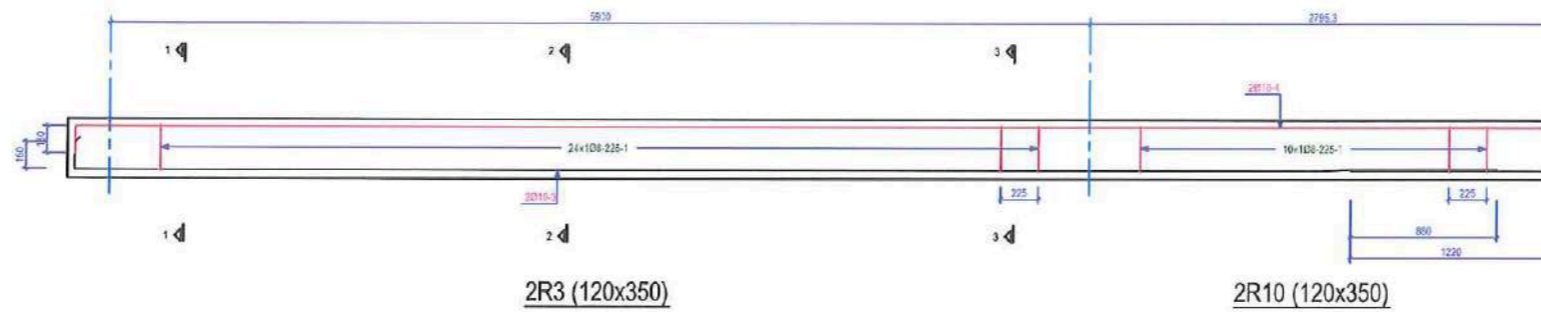

Scale: 1/120

OBJEKTI	RINDERTIMI I SHKOLLES 9-VJEÇARE "HYSEN XHEKA"	NR.FLETES	A-05
VENDNDODHJA	KARBUNARE	FORMATI	420X297
EMERT.I FLETES	DETAJ I ARMIMIT TE TRAVETES NE SOLETEN E K PERDHE	SHKALLA	1:500
DREJTOR	ING. MIMOZA HAXHIU		
PERGJEGJES	ARK. SAIMIR NEBELLI		
SPECIALIST	ARK. OKSANA BAXHO		
SPECIALIST	ORJALD DEBINIA		
SPECIALIST	ING. ARTUR SINANI		
SPECIALIST	ING. ARBEN MUCA		
SPECIALIST	ING. MALDIN CELA		
SPECIALIST	ING. KLAJDI MYZEQARI		

# DETAJ I ARMIMIT TRAVETES NE SOLETEN KATIT PERDHE

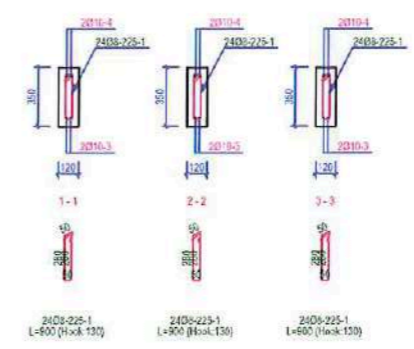
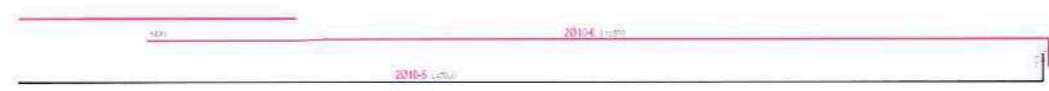
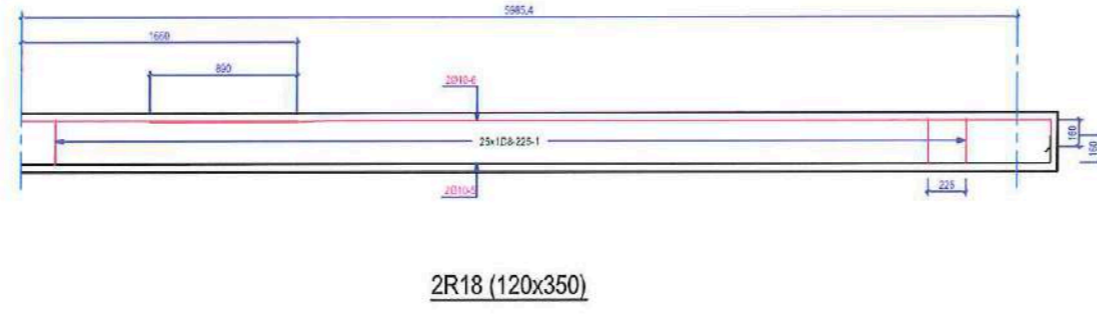
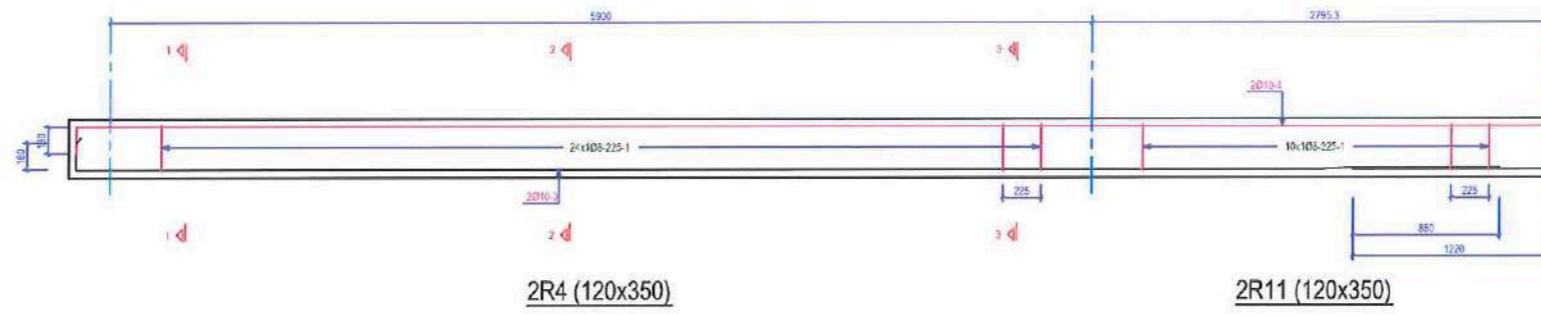

Scale: 1/120

OBJEKTI	RINDERTIMI I SHKOLLES 9-VJECARE "HYSEN XHEKA"	NR. FLETES	A-05
VENDNDODHJA	KARBUNARE	FORMATI	420X297
EMERT. I FLETES	DETAJ I ARMIMIT TE TRAVETES NE SOLETEN E K PERDHE	SHKALLA	1:500
DREJTOR	ING. MIMOZA HAXHIU		
PERGJEGJES	ARK. SAIMIR MEBELLI		
SPECIALIST	ARK. OKSANA BAXHO		
SPECIALIST	ORJALD DEBINJA		
SPECIALIST	ING. ARTUR SINANI		
SPECIALIST	ING. ARBEN MUCA		
SPECIALIST	ING. MALDIN CELA		
SPECIALIST	ING. KLAJDI MYZEQARI		



# DETAJ I ARMIMIT TRAVETES NE SOLETEN KATIT PERDHE

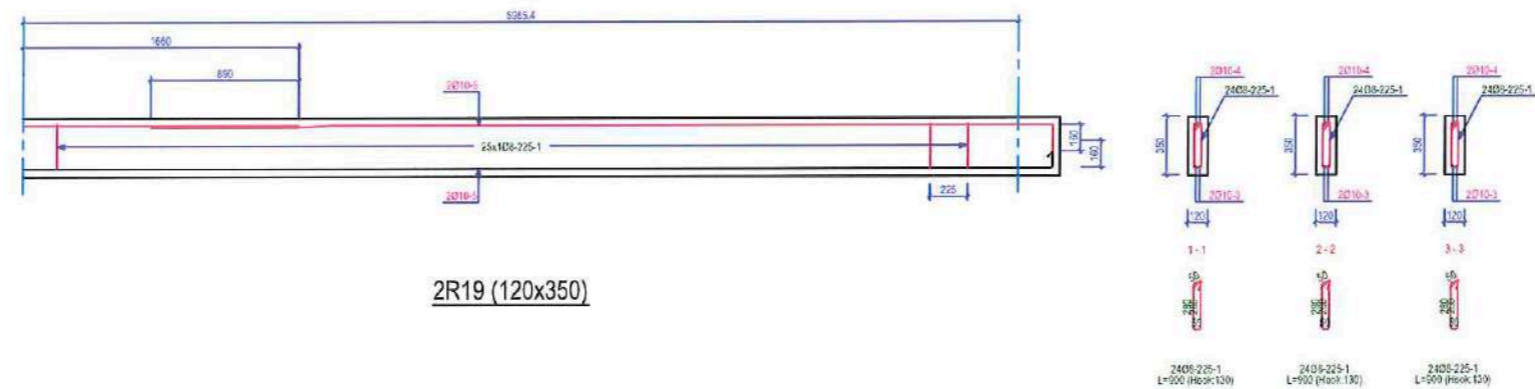
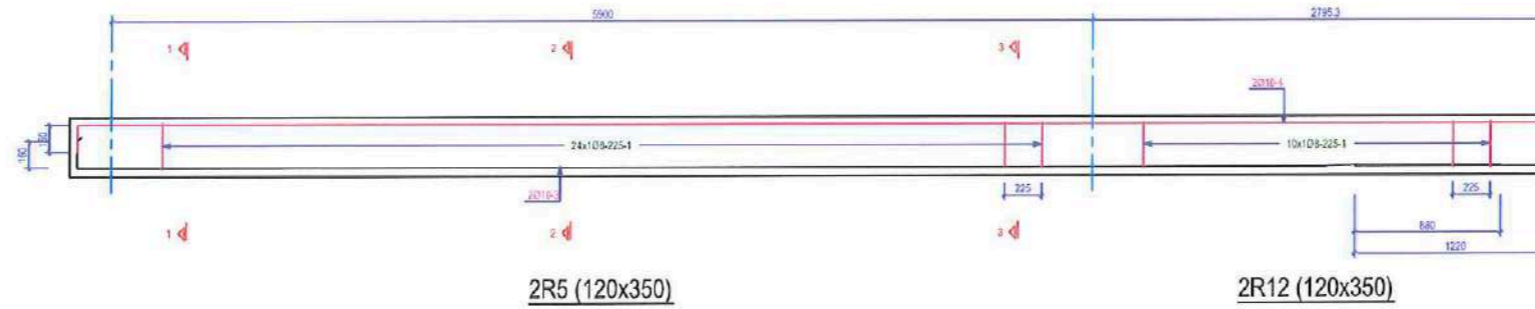

Scale: 1/120

OBJEKTI	RINDERTIMI I SHKOLLËS 9-VJECARE "HYSEN XHIEKA"	NR. FLETES	A-05
VENDNDODHJA	KARBUNARE	FORMATI	420x297
EMERT. I FLETES	DETAJ I ARMIMIT TE TRAVETES NE SOLETEN E K PERDHE	SHKALLA	1:500
DREJTOR	ING. MIMOZA HAXHIU		
PERGJEGJES	ARK. SAIMIR MERELLI		
SPECIALIST	ARK. OKSANA BAXHO		
SPECIALIST	ORJALD DEBINJA		
SPECIALIST	ING. ARTUR SINANI		
SPECIALIST	ING. ARBEN MUCA		
SPECIALIST	ING. MALDIN CELA		
SPECIALIST	ING. KLAJDI MYZEQARI		



# DETAJ I ARMIMIT TRAVETES NE SOLETEN KATIT PERDHE

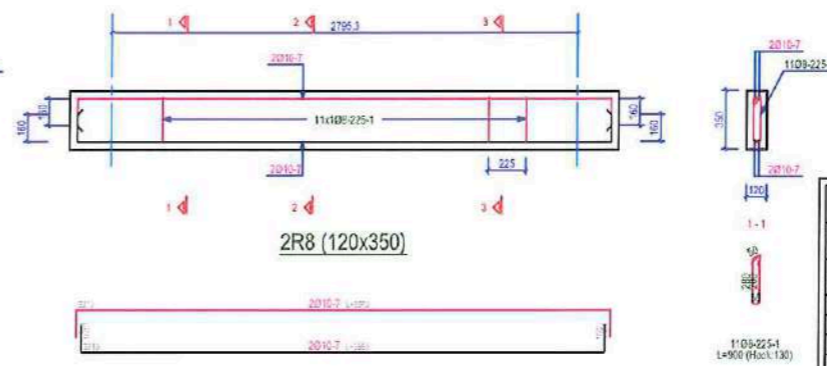
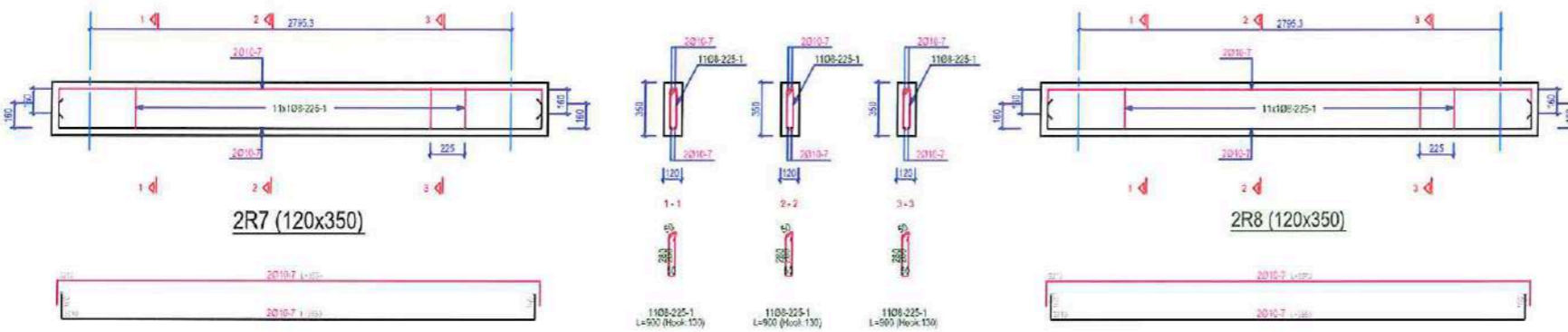
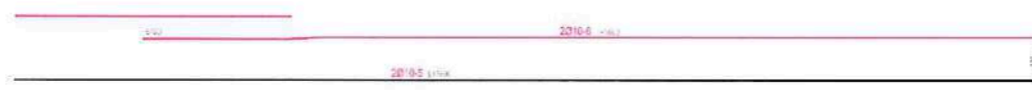
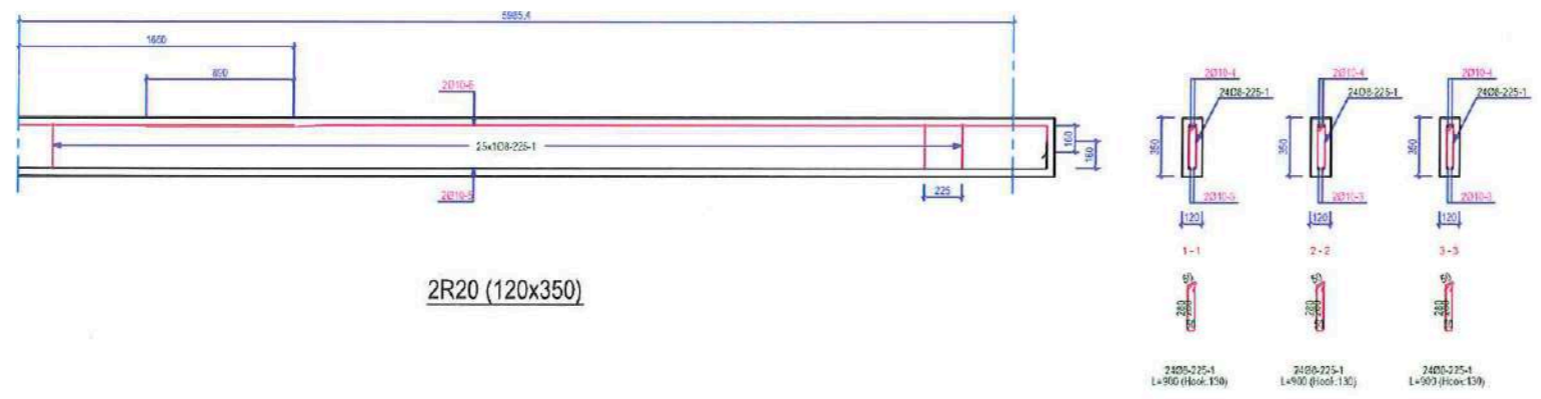
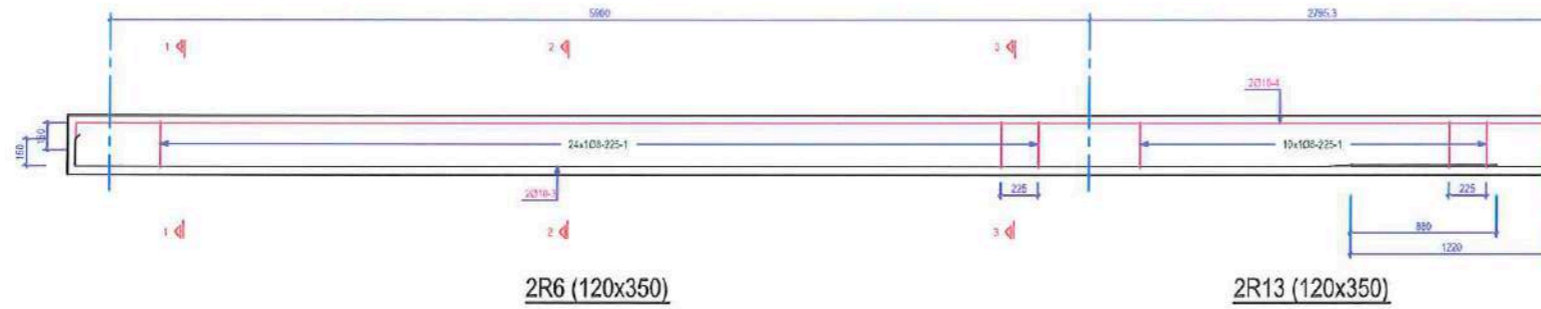

Scale: 1/120

OBJEKTI	RINDERTIMI I SHKOLLËS 9-VJEÇARE "HYSEN XHEKA"	NR.FLETES	A-05
VENDNDODHJA	KARBUNARE	FORMATI	420x297
EMERT.I FLETES	DETAJ I ARMIMIT TE TRAVETES NE SOLETEN E K. PERDHE	SHKALLA	1:500
DREJTOR	ING. MIMOZA HAXHIU		
PERGJEGJES	ARK. SAJMIR MEBELLI		
SPECIALIST	ARK. OKSANA BAXHO		
SPECIALIST	ORJALD DEBINA		
SPECIALIST	ING. ARTUR SINANI		
SPECIALIST	ING. ARBEN MUCA		
SPECIALIST	ING. MALDIN CELA		
SPECIALIST	ING. KLAJDI MYZEQARI		





# DETAJ I ARMIMIT TRAVETES NE SOLETEN KATIT PERDHE

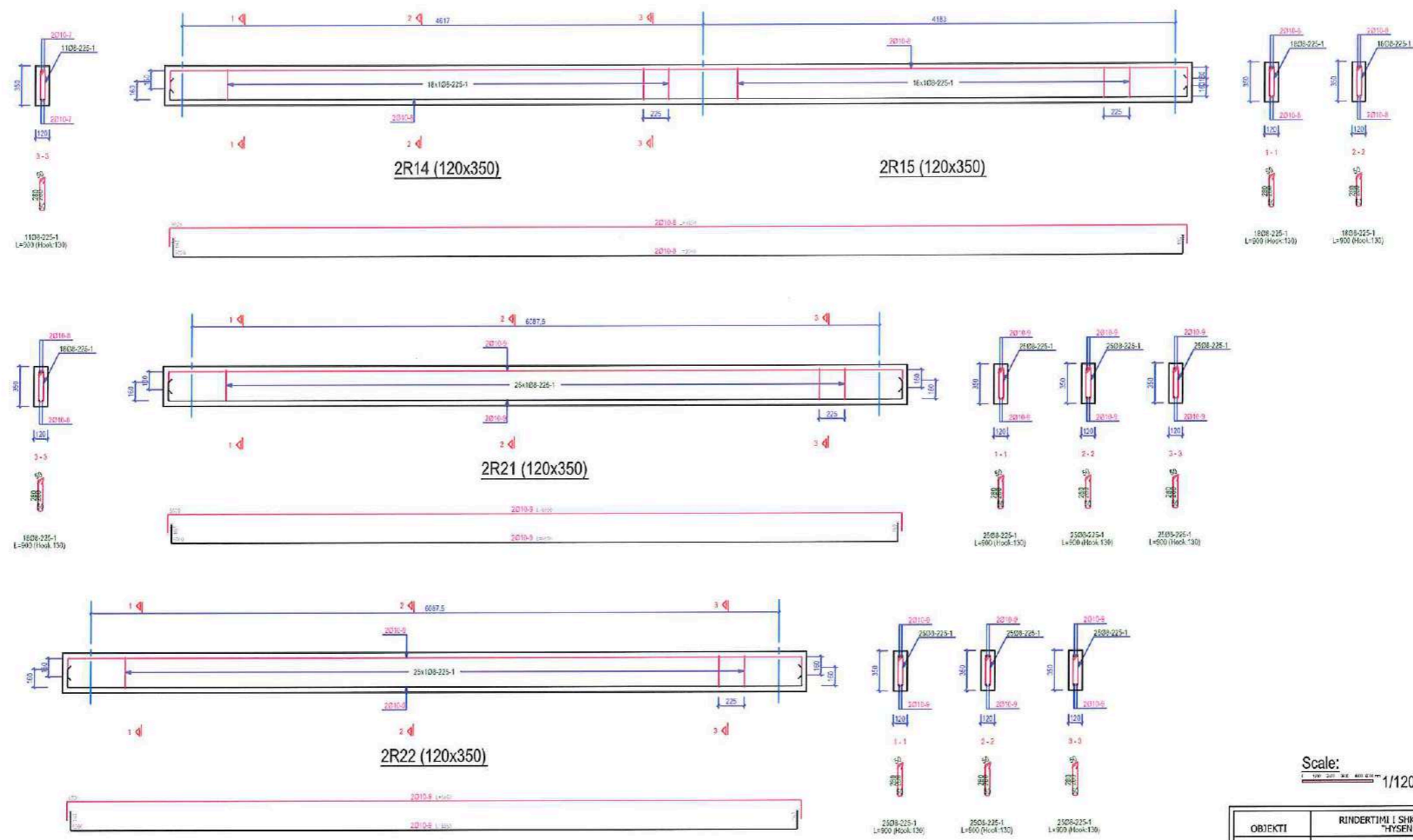

Scale: 1/120

OBJEKTI	RINDERTIMI I SHKOLLES 9-VJECARE "HYSEN XHEKA"	NR.FLETES	A-05
VENDNDODHJA	KARBUNARE	FORMATI	420x297
EMERT I FLETES	DETAJ I ARMIMIT TE TRAVETES NE SOLETEN E K PERDHE	SHKALLA	1:500
DREJTOR	ING. MIMOZA HAXHIU		
PERGJEGJES	ARK. SAJMIH MEBELLI		
SPECIALIST	ARK. OXIANA BAXHO		
SPECIALIST	ORJALD DEBINJA		
SPECIALIST	ING. ARTUR SINANI		
SPECIALIST	ING. ARBEN MUÇA		
SPECIALIST	ING. MALDIN CELA		
SPECIALIST	ING. KLAJDI MYZEQARI		



# DETAJ I ARMIMIT TRAVETES NE SOLETEN KATIT PERDHE

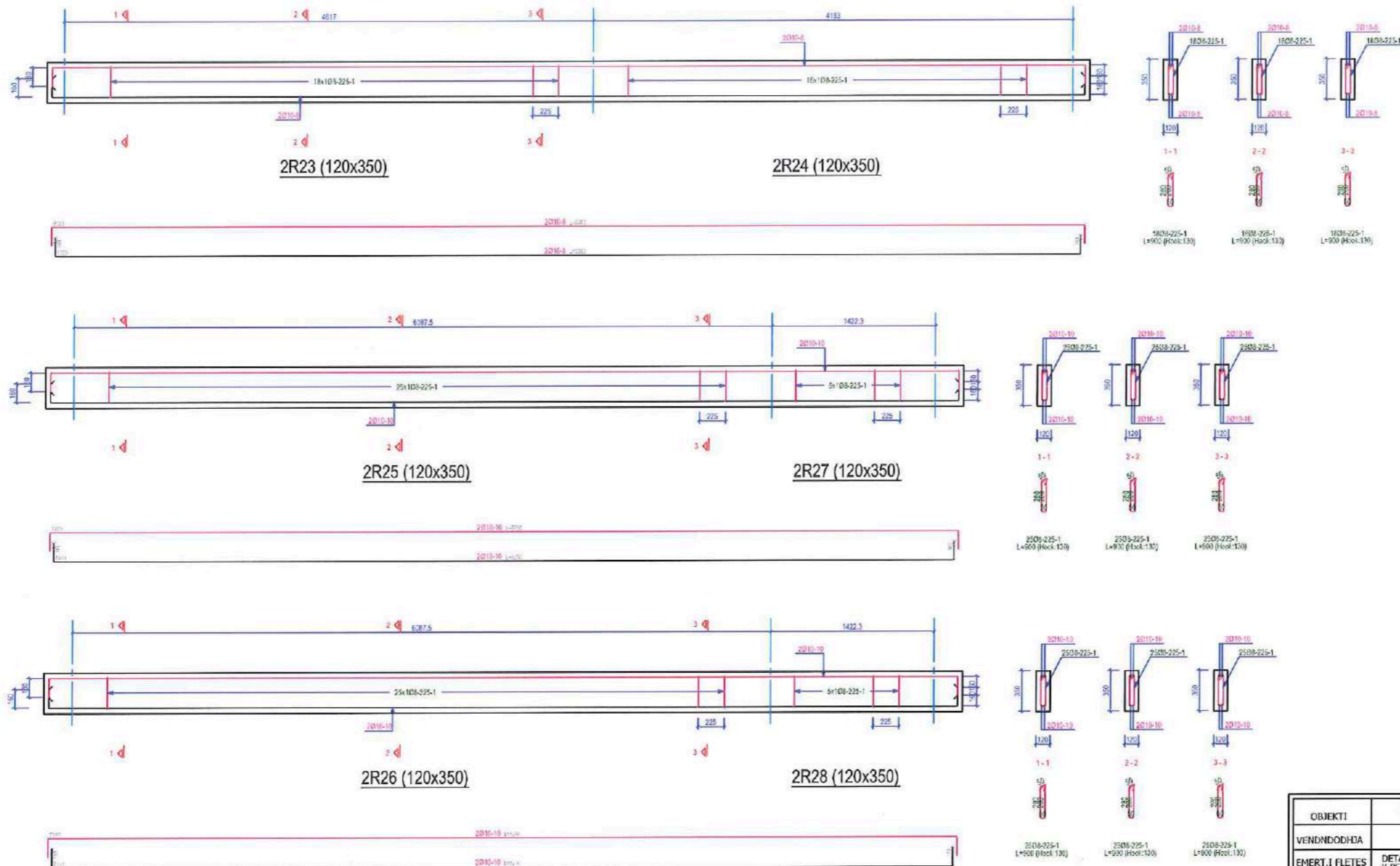

Scale: 1/120

OBJEKTI	RINDERTIMI I SHKOLLËS 9-VJECARE "HYSEN XHIEKA"	NR.FLETES	A-05
VENDNDODHJA	KARBUNARE	FORMATI	420x297
EMERT.I FLETES	DETAJ I ARMIMIT TE TRAVETES NE SOLETEN E K PERDHE	SHKALLA	1:500
DREJTOR	ING. MIMOZA HAXHIU	 REPUBLIKA E SHQIPERISE BASHKIA LUSHNJE	
PERGJEGJES	ARK. SAIMIR MEBELLY		
SPECIALIST	ARK. OKSANA BASHO		
SPECIALIST	ORJALD DEBINJA		
SPECIALIST	ING. ARTUR SIMANI		
SPECIALIST	ING. ARBEN MUCA		
SPECIALIST	ING. MALDIN CELA		
SPECIALIST	ING. KLADI MYZEQARI		



# DETAJ I ARMIMIT TRAVETES NE SOLETEN KATIT PERDHE

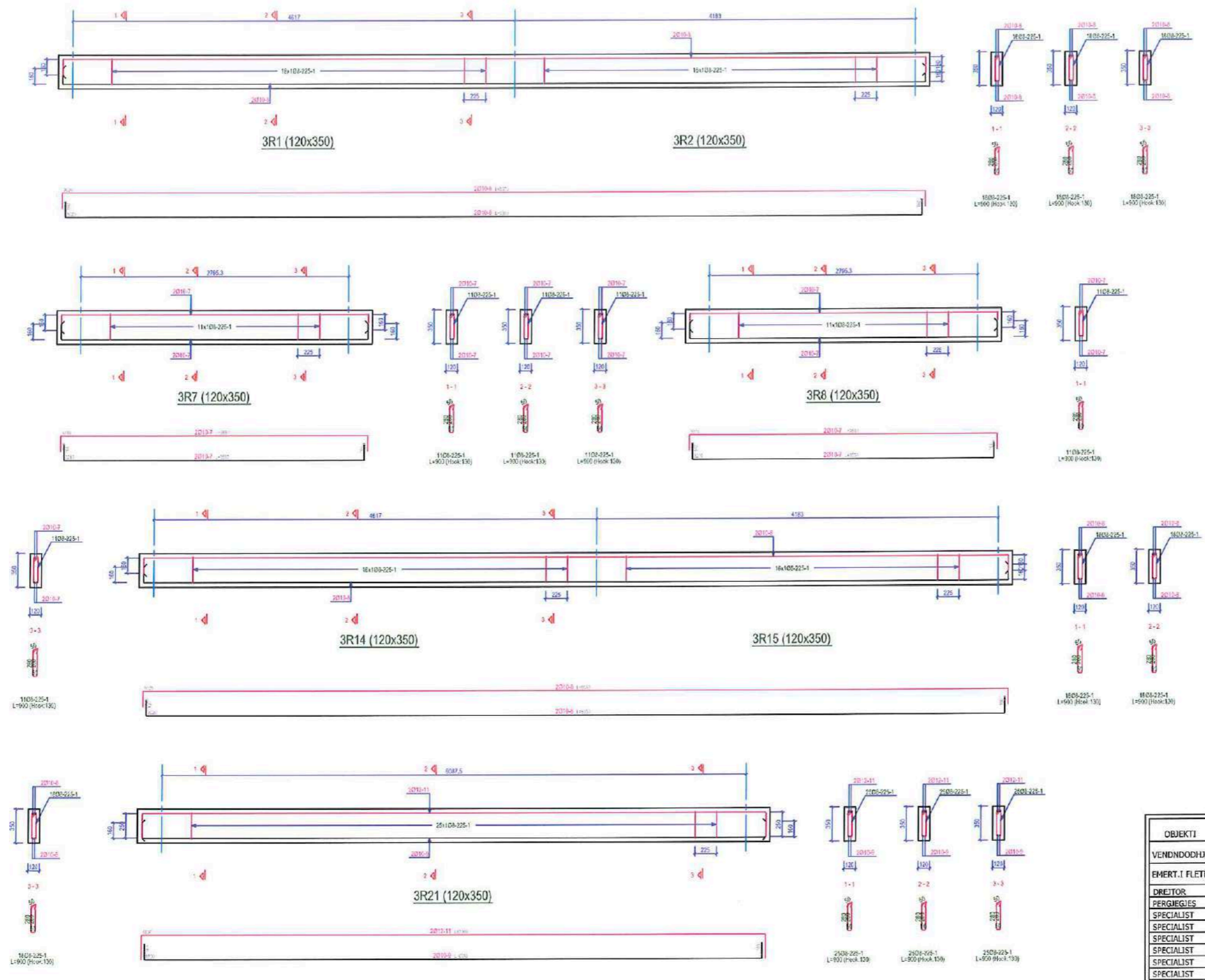

OBJEKTI	RINDERTIMI I SHKOLLËS 9-VJECARE "HYSEN XHEKA"	NR.FLETES	A-05
VENDNDODHJA	KARBUNARE	FORMATI	420x297
EMERT.I FLETES	DETAJ I ARMIMIT TE TRAVETES NE SOLETEN E K PERDHE	SHKALLA	1:500
DREJTOR	ING. MIMOZA HAXHIU	 REPUBLIKA E SHQIPERISE BASHKIA LUSHNJË	
PERGJEGJES	ARK. SAIMIR MEBELLI		
SPECIALIST	ARK. OKSANA BAXHO		
SPECIALIST	ORJALD DERINJA		
SPECIALIST	ING. ARTUR SINANI		
SPECIALIST	ING. ARBEN MUCA		
SPECIALIST	ING. MALDIN CELA		
SPECIALIST	ING. KLAJDI MYZEQARI		

# DETAJ I ARMIMIT TRAVETES NE SOLETEN KATIT PERDHE

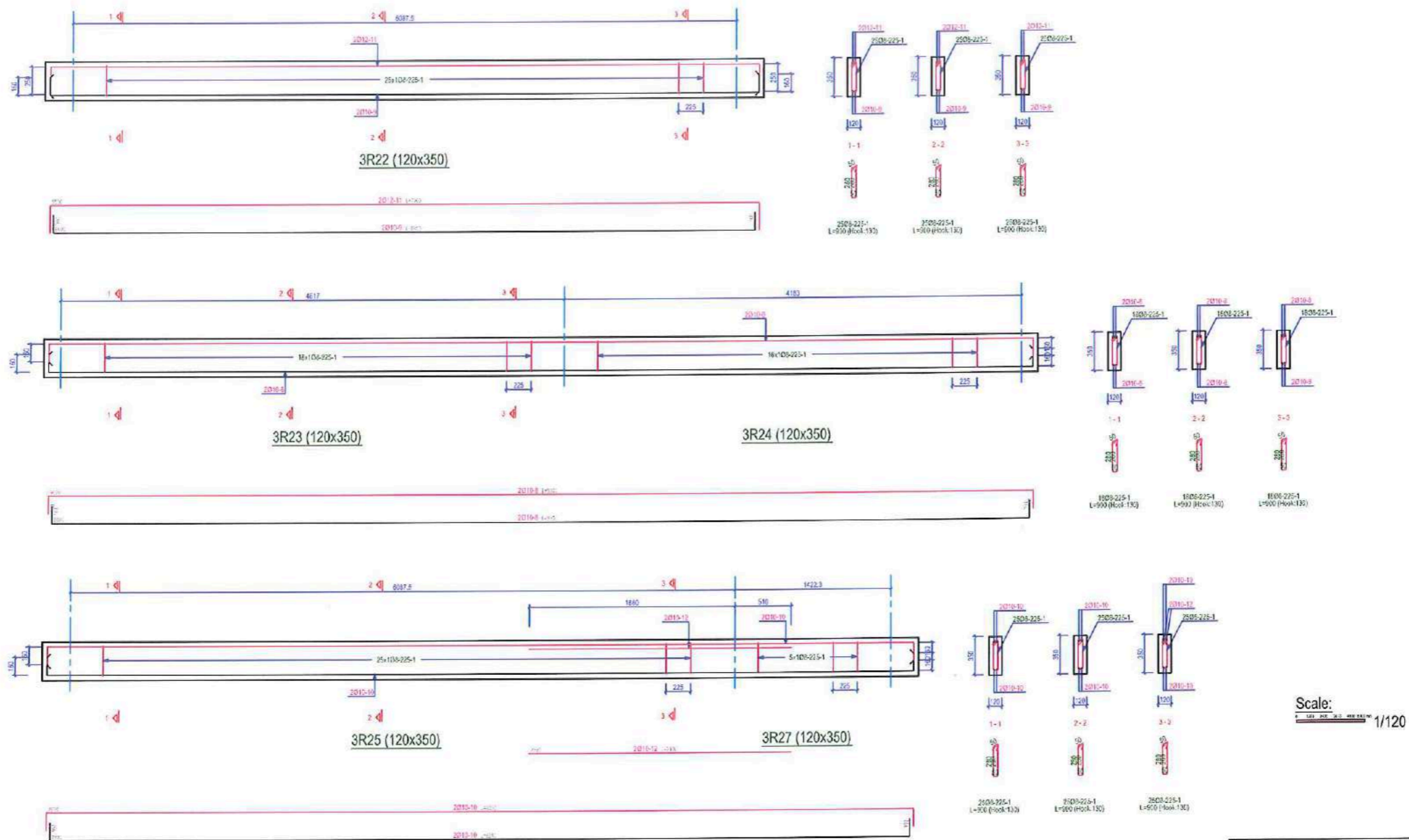

OBJEKTI	RINDERTIMI I SHKOLLES 9-VJECARE "HYSEN XHEKA"	NR. FLETES	A-05
VENDNDODHJA	KARBUNARE	FORMATI	420x297
EMERT. I FLETES	DETAJ I ARMIMIT TE TRAVETES NE SOLETEN E K. PERDHE	SHKALLA	1:500
DREJTOR	ING. MIMOZA HAXHIU	 REPUBLIKA E SHQIPERISE BASHKIA LUSHNJË	
PERGJEGJES	ARK. SAIMIR MEBELLY		
SPECIALIST	ARK. OKSANA BAXHO		
SPECIALIST	ORJALD DEBINJA		
SPECIALIST	ING. ARTUR SINANI		
SPECIALIST	ING. ARBEN MUCA		
SPECIALIST	ING. MALDIN CELA		
SPECIALIST	ING. KLAJDI MYZEQARI		



# DETAJ I ARMIMIT TRAVETES NE SOLETEN KATIT PERDHE

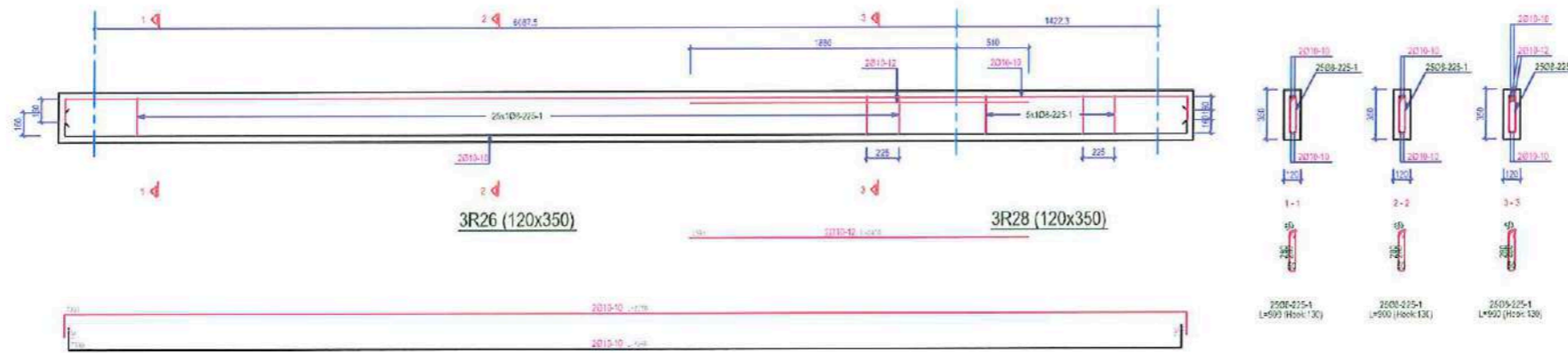

Quantity Table							
NO	SIZE	DUA	LENGTH (mm)	FORM	TOTAL LENGTH (m)		
					Ø8	Ø10	Ø12
1	8	747	900		672.30		
2	10	4	5250			21.00	
3	10	10	8750			37.50	
4	10	10	10750			107.50	
5	10	10	7600			76.00	
6	10	10	5600			56.00	
7	10	10	3550			35.50	
8	10	20	5150			187.00	
9	10	12	6800			82.20	
10	10	15	8150			132.00	
11	12	4	7000				28.00
12	10	4	2400			9.60	
TOTAL LENGTH (m)					672.30	815.60	28.00
UNIT WEIGHT (kg/m)					0.40	0.62	0.59
WEIGHT (kg)					269.6	503.5	24.9
T.WEIGHT (kg)					798.0		

Scale: 1/120

OBJEKTI	RINDERTIMI I SHKOLLËS 9-VJEÇARE "HYSEN XHIEKA"	NR.FLETES	A-05
VEPNDODHJA	KARBUNARE	FORMATI	420x297
EMERT.I FLETES	DETAJ I ARMIMIT TE TRAVETES NE SOLETEN E K.PERDHE	SHKALLA	1:500
DREJTOR	ING. MIMOZA HAXHIU		
PERGJEGJES	ARK. SAIMIR MEBELLI		
SPECIALIST	ARK. OKSANA BASHO		
SPECIALIST	ORJALD DEBINJA		
SPECIALIST	ING. ARTUR SINANI		
SPECIALIST	ING. ARBEN MUCA		
SPECIALIST	ING. MALDIN CELA		
SPECIALIST	ING. KLAJDI MYZEQARI		

# DETAJ I ARMIMIT TRAREVE THEMELEVE

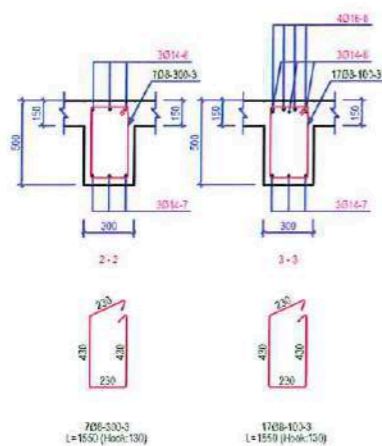
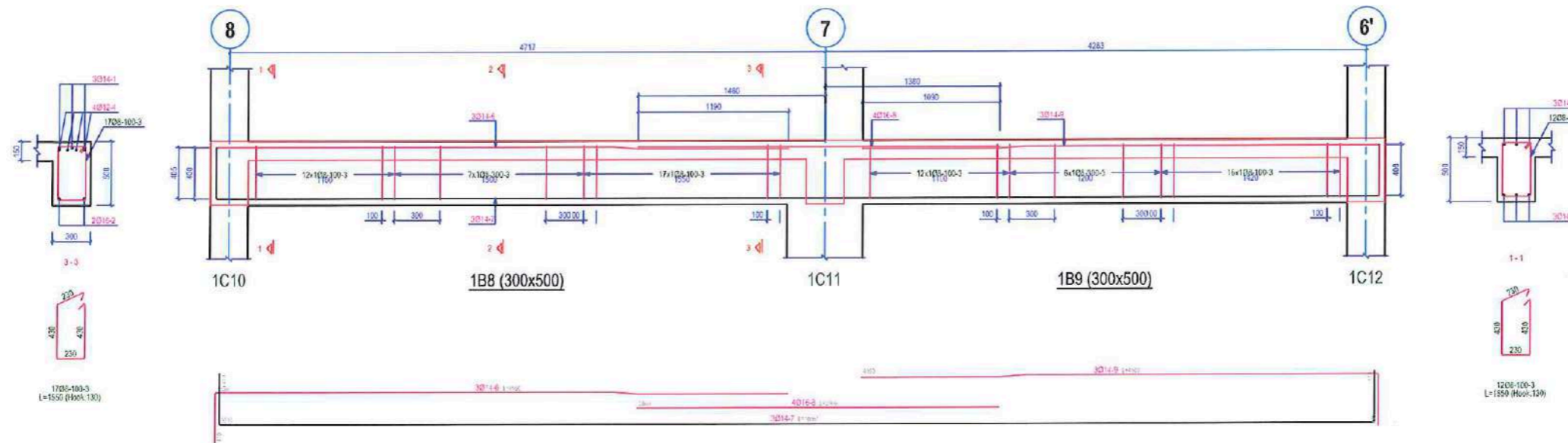
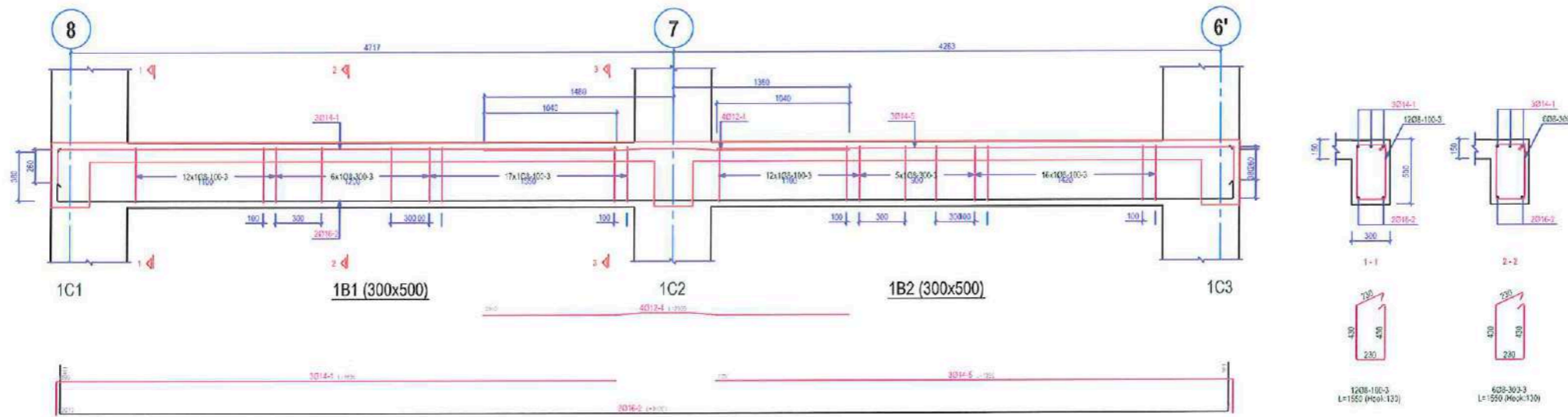

BEAM ELEVATIONS QUANTITY TAKE OFF - STOREYS - 1			
Ø	UNIT WEIGHT (Kg/m)	LENGTH (m)	T.WEIGHT (Kg)
Ø8	0.46	213.9	84.5
Ø12	0.89	11.6	10.3
Ø14	1.21	65.5	80.4
Ø16	1.58	31.6	49.9
T.WEIGHT (Kg)			214.2

NO	SIZE	QUA	LENGTH (mm)	TOTAL	FORM
1	14	3	4650	13.95	14
2	16	2	10000	20.00	16
3	8	135	1550	213.90	14
4	12	4	2900	11.60	12
5	14	3	4350	13.05	14
6	14	3	4950	14.85	14
7	14	3	10050	30.15	14
8	16	4	2300	11.50	16
9	14	3	4500	13.90	14

BEAM ELEVATIONS1 Scale: 1:500

OBJEKTI	RINDERTIMI I SHKOLLES 9-VJECARE "HYSEN XHEKA"	NR.FLETES	A-05
VENDNDODHJA	KARBUNARE	FORMATI	420X297
EMERT.I FLETES	DETAJ I ARMIMIT TE TRAREVE TE THEMELEVE	SHKALLA	1:500
DREJTOR	ING. MIMOZA HAXHILU	<p>REPUBLIKA E SHQIPËRIE BASHKIA LUSHNJE</p>	
PERQJEGJES	ARK. SAIMIR MEBELI		
SPECIALIST	ARK. OKSANA BAXHO		
SPECIALIST	ORJALD DEBINJA		
SPECIALIST	ING. ARTUR SINANI		
SPECIALIST	ING. ARBEN MUCA		
SPECIALIST	ING. MALDIN CELA		
SPECIALIST	ING. KLAJDI MYZEQARI		





# DETAJ I ARMIMIT TRAREVE THEMELEVE

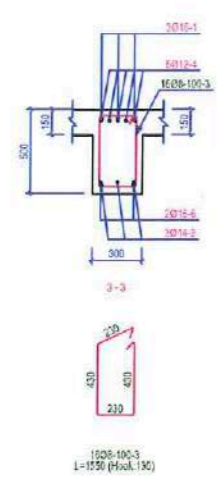
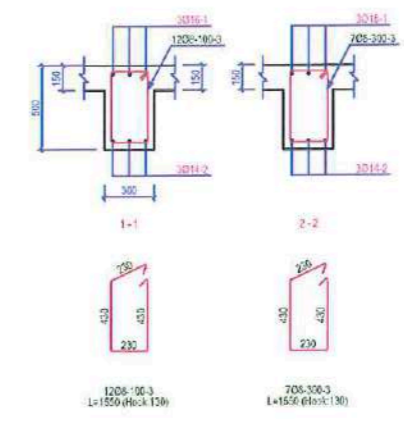
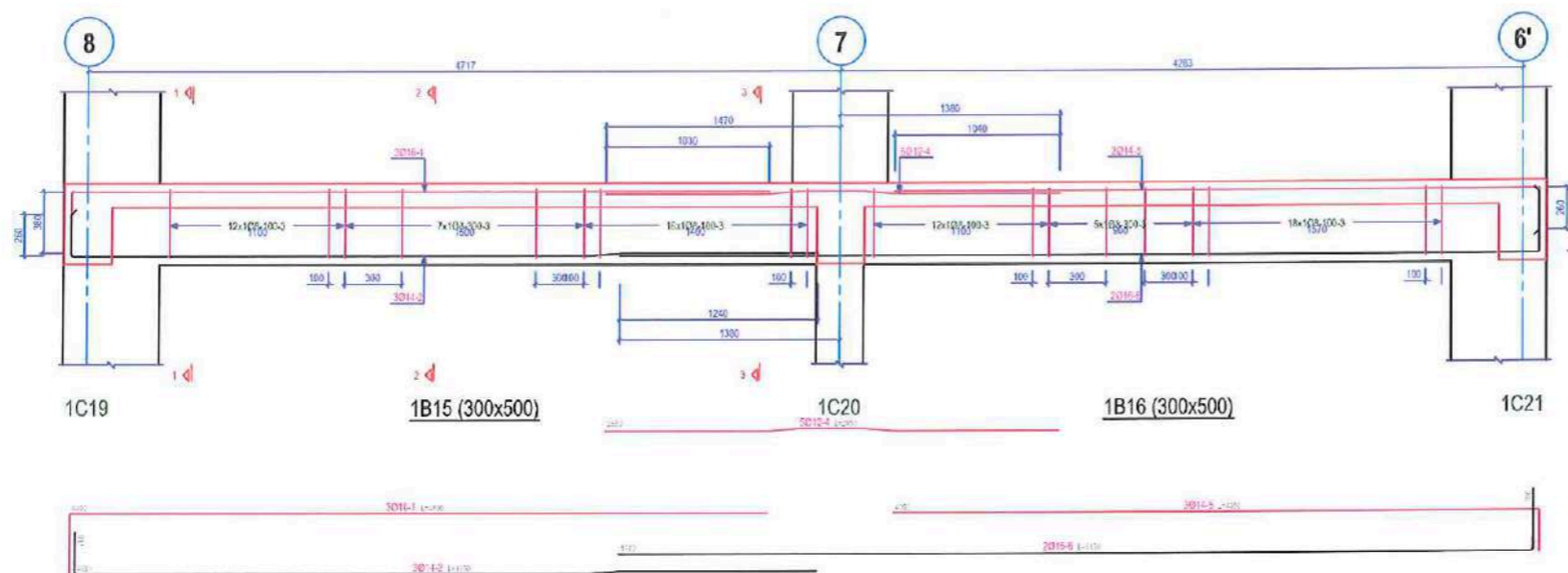

BEAM ELEVATIONS QUANTITY TAKE OFF - STOREYS + 1			
SIZE	UNIT WEIGHT (kg/m)	LENGTH (m)	T.WEIGHT (kg)
Ø8	0.40	105.5	42.2
Ø12	0.89	14.3	12.7
Ø14	1.21	27.9	33.8
Ø16	1.58	26.7	42.2
T.WEIGHT (kg)			131.5

NO	SIZE	QUA	LENGTH (m)	TOTAL	FORU
1	16	3	4900	14.40	100%
2	14	3	4950	14.85	100%
3	8	70	1550	108.50	100%
4	12	5	2850	14.25	100%
5	14	3	4350	13.05	100%
6	16	2	6150	12.30	100%

OBJEKTI	RINDERTIMI I SHKOLLES 9-VJECARE "HYSEN XHEKA"	NR.FLETES	A-05
VENDNDODHJA	KARBUNARE	FORMATI	420x297
EMERT.I FLETES	DETAJ I ARMIMIT TE TRAREVE TE THEMELEVE	SHKALLA	1:500
DREJTOR	ING. MIMOZA HAXHIIU		
PERGJEGJES			
SPECIALIST	ARK. OKSANA BASHO		
SPECIALIST	ORJALD DEBINJA		
SPECIALIST	ING. ARTUR SINANI		
SPECIALIST	ING. ARBEN MUCA		
SPECIALIST	ING. MALDIN CELA		
SPECIALIST	ING. KLAJDI MYZEQARI		

# DETAJ I ARMIMIT TRAREVE THEMELEVE

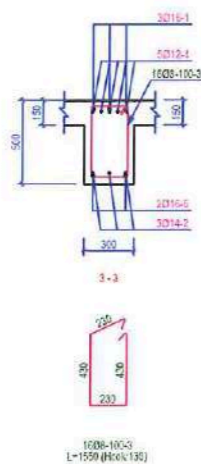
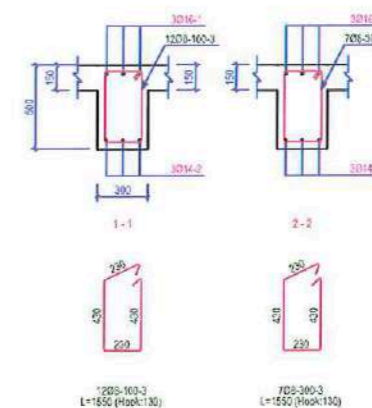
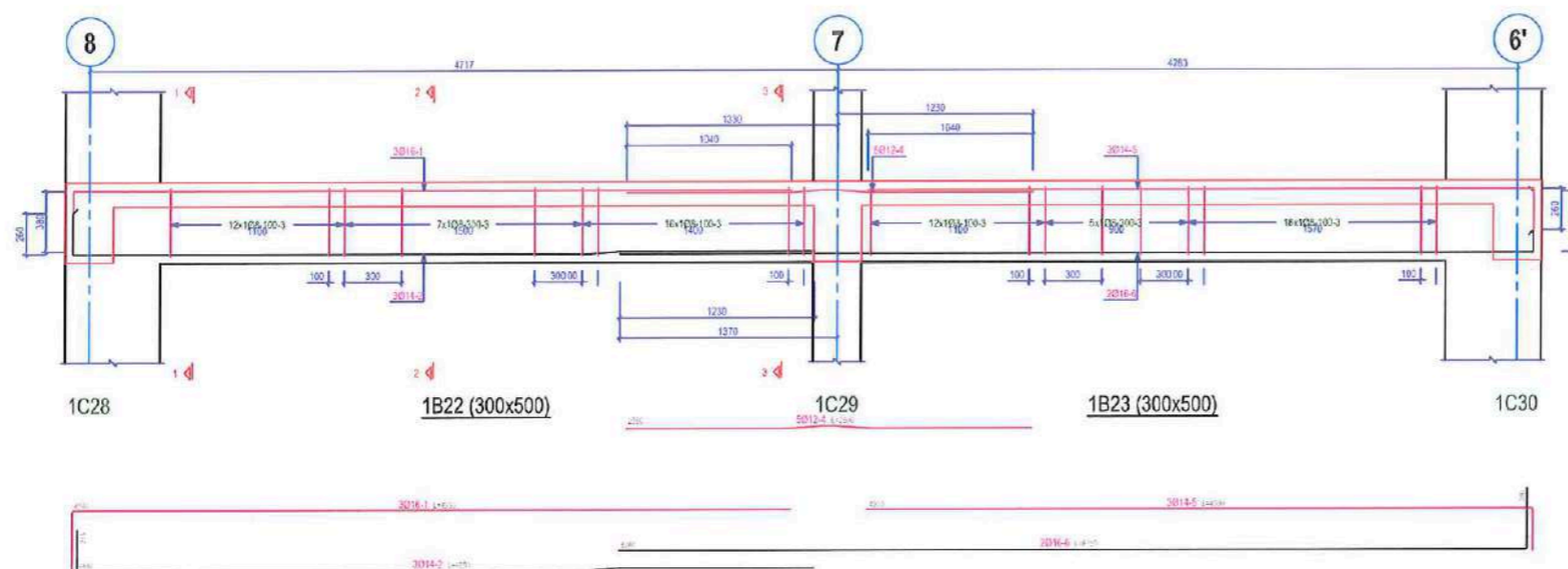

BEAM ELEVATIONS QUANTITY TAKE OFF - STOREYS - 1

SIZE	UNIT WEIGHT (Kg/m)	LENGTH (m)	T.WEIGHT (Kg)
Ø8	0.40	104.5	42.9
Ø12	0.80	13.0	11.6
Ø14	1.21	28.4	34.3
Ø16	1.58	27.2	42.9
T.WEIGHT (Kg)			131.6

NO	SIZE	QUA	LENGTH (mm)	TOTAL	FORM
1	16	3	4590	14.55	16
2	14	3	4590	14.55	14
3	8	70	1650	105.50	8
4	12	5	2600	13.00	12
5	14	3	4590	13.50	14
6	16	2	6150	12.30	16

Scale: 1/120

OBJEKTI	RINDERTIMI I SHKOLLËS 9-VJECARE "HYSEN XHEKA"	NR.FLETES	A-05
VENDNDODHJA	KARBUNARE	FORMATI	420X297
EMERT.I FLETES	DETAJ I ARMIMIT TE TRAREVE TE THEMELEVE	SHKALLA	1:500
DREJTOR	ING. MIMOZA HAXHIU	 REPUBLIKA E SHQIPËRISE BASHKIA LUSHNË	
PERGJEGJES			
SPECIALIST	ARK. OKSANA BAXHO		
SPECIALIST	ORJALD DEBINJA		
SPECIALIST	ING. ARTUR SINANI		
SPECIALIST	ING. ARBEN MUJA		
SPECIALIST	ING. MALDIN CELA		
SPECIALIST	ING. KLAJDI MYZEQARI		



# DETAJ I ARMIMIT TRAREVE THEMELEVE

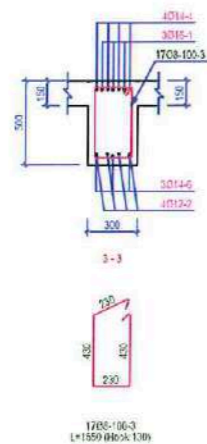
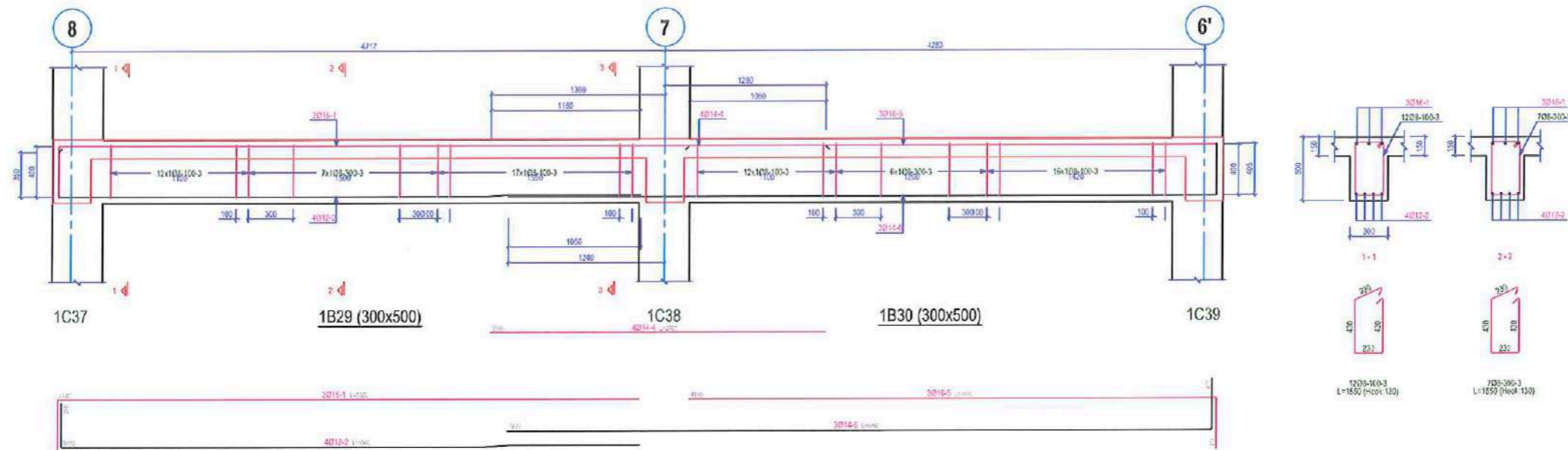

BEAM ELEVATIONS QUANTITY TAKE OFF - STOREYS - 1					
SIZE	UNIT WEIGHT (kg/m)	LENGTH (m)	T.WEIGHT (Kg)		
Ø8	0.40	168.5	42.9		
Ø12	0.89	23.0	17.8		
Ø14	1.21	29.0	35.0		
Ø16	1.58	28.0	45.7		
T.WEIGHT (kg)			141.4		
NO	SIZE	QUA	LENGTH (m)	TOTAL	FORM
1	16	3	5950	15.15	16
2	12	4	5900	20.03	16
3	8	70	1550	106.50	16
4	14	4	2700	10.80	16
5	16	3	4600	13.03	16
6	14	3	6950	16.15	16

BEAM ELEVATIONS1



OBJEKTI	RINDERTIMI I SHKOLLËS 9-VJECARE "HYSEN XHEKA"	NR.FLETES	A-05
VENDNDODHJA	KARBUNARE	FORMATI	420X297
EMERT.I FLETES	DETAJ I ARMIMIT TE TRAREVE TE THEMELEVE	SHKALLA	1:500
DREJTOR	ING. MIMOZA HAXHIU	 REPUBLIKA E SHQIPËRISE BASHKIA E LUSHNËS	
PERGJEGJES			
SPECIALIST	ARK. OKSANA BASHO		
SPECIALIST	ORJALD DEBINA		
SPECIALIST	ING. ARTUR SINANI		
SPECIALIST	ING. ARBEN MUCA		
SPECIALIST	ING. MALDIN CELA		
SPECIALIST	ING. KLAJDI MYZEQARI		





# DETAJ I ARMIMIT TRAREVE THEMELEVE

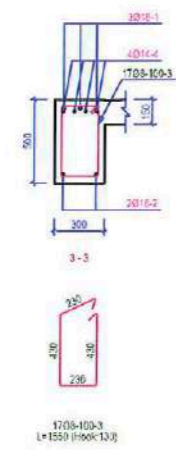
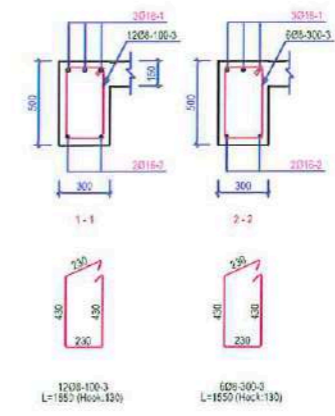
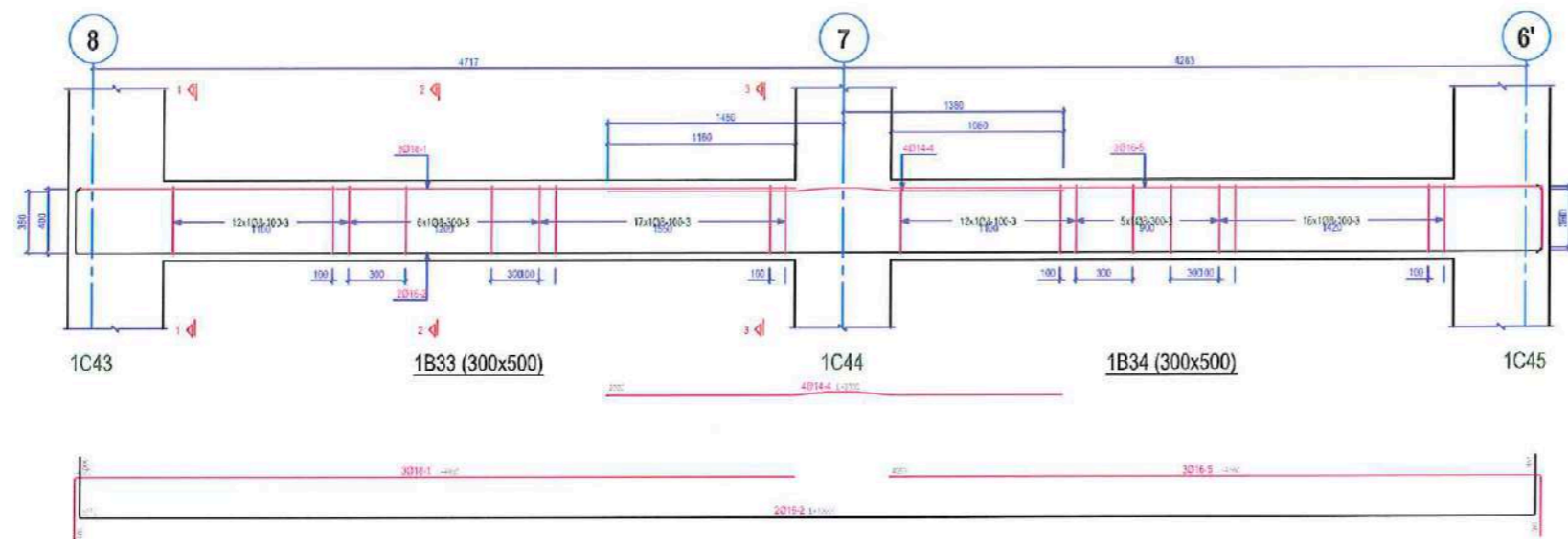

BEAM ELEVATIONS QUANTITY TAKE OFF - STOREYS - 1			
SIZE	UNIT WEIGHT (Kg/m)	LENGTH (m)	T.WEIGHT (Kg)
Ø8	0.40	195.4	41.8
Ø14	1.21	11.6	14.0
Ø16	1.58	33.5	52.9
Ø18	2.00	14.9	29.7
T.WEIGHT (Kg)			138.3

NO	SIZE	QUA	LENGTH (mm)	TOTAL	FORM
1	18	3	4950	14.85	Ø18
2	16	2	10000	20.00	Ø16
3	8	68	1550	105.40	Ø8
4	14	4	2900	11.60	Ø14
5	16	3	4500	13.50	Ø16

BEAM ELEVATIONS1 Scale: 1/120

OBJEKTI	RINDERTIMI I SHKOLLES 9-VJECARE "HYSEN XHEKA"	NR.FLETES	A-05
VENDNDODHJA	KARBUNARE	FORMATI	420X297
EMERT.I FLETES	DETAJ I ARMIMIT TE TRAREVE TE THEMELEVE	SHKALLA	1:500
DREJTOR	ING. MIMOZA HAXHIU		
PERGJEGJES			
SPECIALIST	ARK. OKSANA BAXHO		
SPECIALIST	ORJALO DEBINJA		
SPECIALIST	ING. ARTUR SINANI		
SPECIALIST	ING. ARBEN MUCA		
SPECIALIST	ING. MALDIN CELA	REPUBLICA E SHQIPËRISE BASHKIA LUSHINJE	
SPECIALIST	ING. KLAJDI MYZEQARI		



## DETAJ I ARMIMIT TRAREVE THEMELEVE

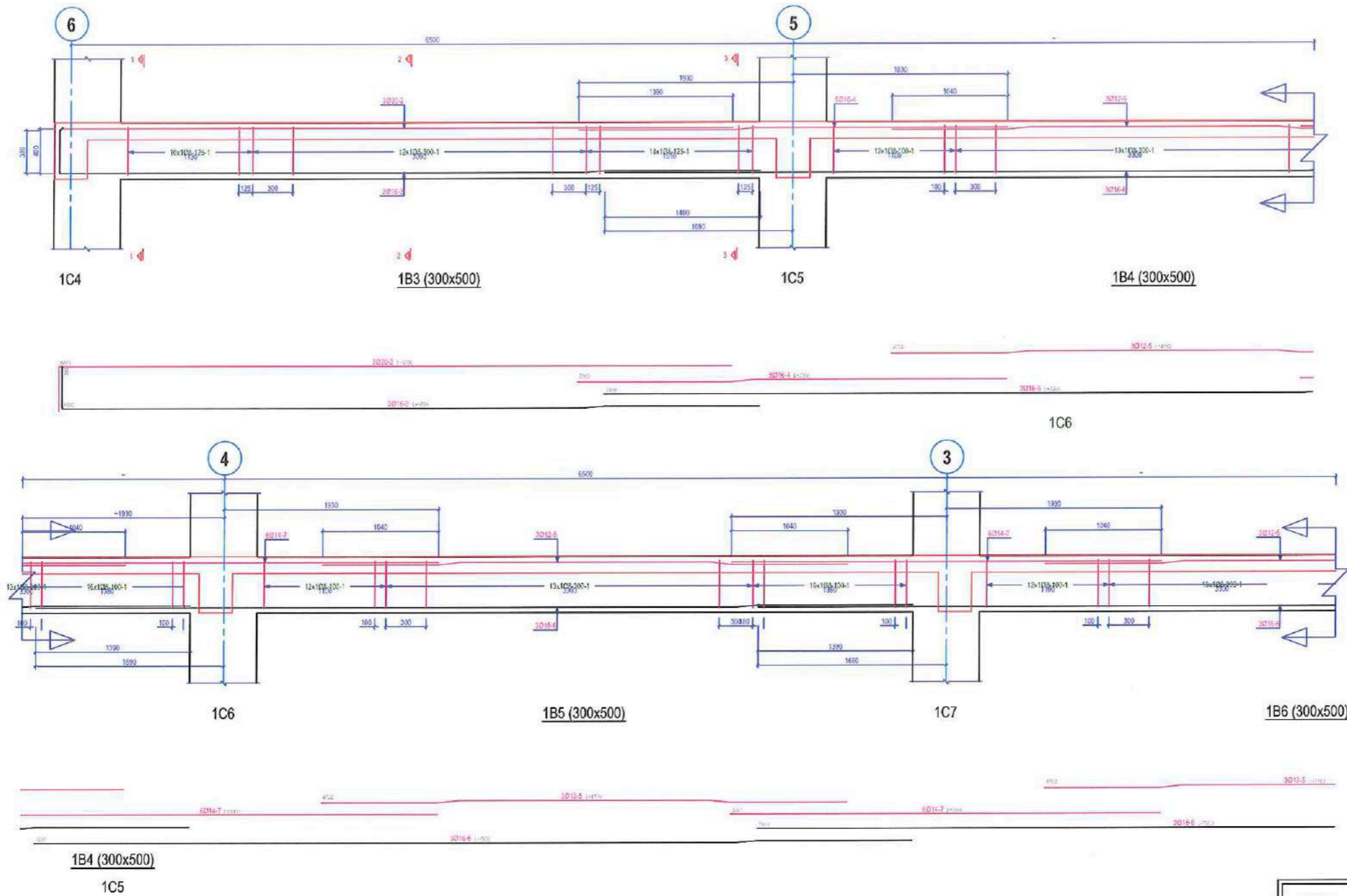

OBJEKTI	RINDERTIMI I SHKOLLËS 9-VJECARE "HYSEN XHEKA"	NR.FLETES	A-05
VENDNDODHJA	KARBUNARE	FORMATI	420X297
EMERT.I FLETES	DETAJ I ARMIMIT TE TRAREVE TE THEMELEVE	SHKALLA	1:500
DREJTOR	ING. MIMOZA HAXHIU	 REPUBLIKA E SHQIPËRISE BASHKIA E LUSHNJË	
PERGJEGJES			
SPECIALIST	ARK. OKSANA BAXHO		
SPECIALIST	ORJALD DEBINJA		
SPECIALIST	ING. ARTUR SINANI		
SPECIALIST	ING. ARBEN MUCA		
SPECIALIST	ING. MALDIN CELA		
SPECIALIST	ING. KLAJDI MYZEQARI		



# DETAJ I ARMIMIT TRAREVE THEMELEVE

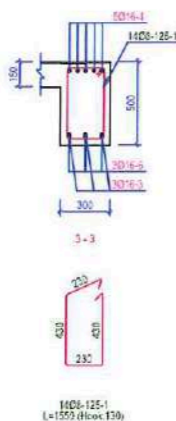
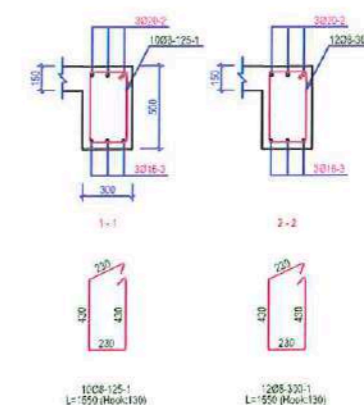
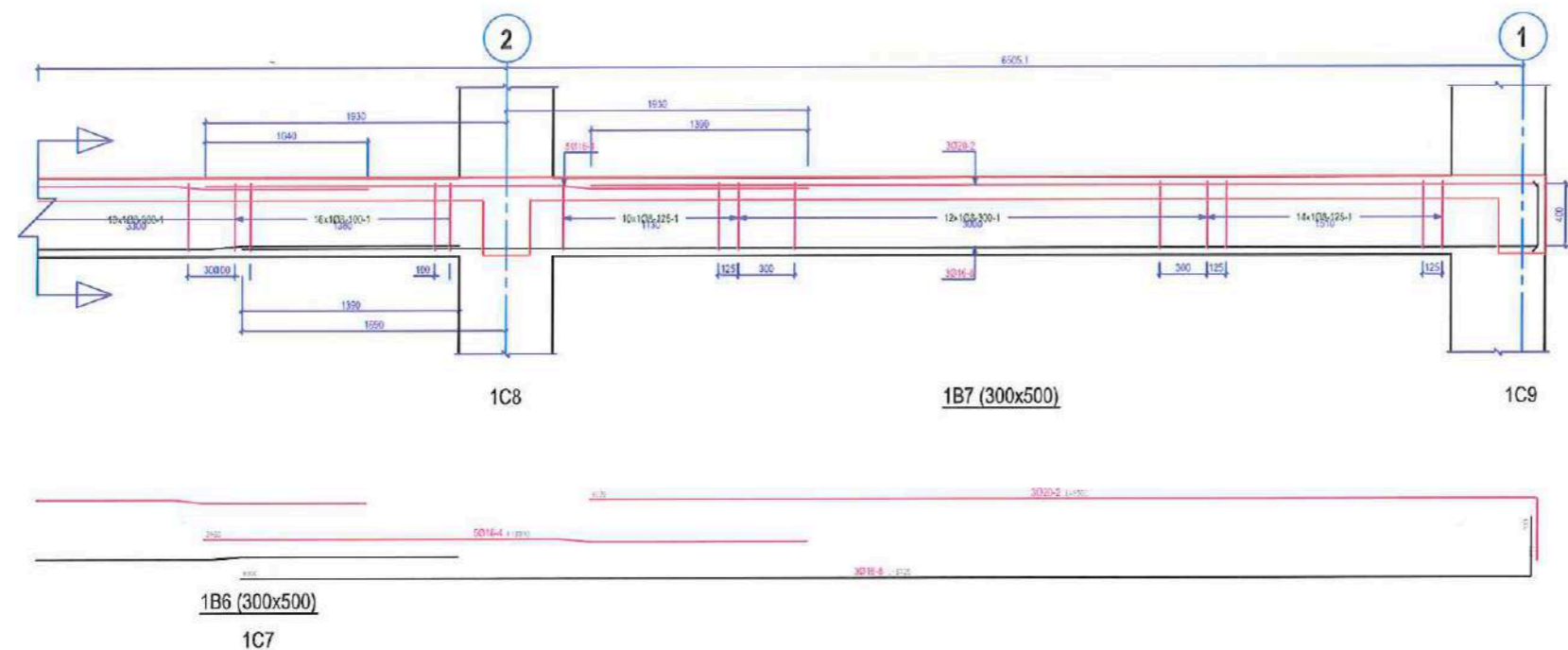

Quantity Table										
NO	S/E	QUA	LENGTH (mm)	FORM	TOTAL LENGTH (m)					
					Ø8	Ø12	Ø14	Ø16	Ø20	
1	8	150	1500	302.25						
2	20	6	6500					39.00		
3	16	3	6700					20.10		
4	16	10	3900					39.00		
5	12	9	4700			42.75				
6	16	9	7500					71.10		
7	14	12	3500					46.80		
8	16	3	8700					26.10		
TOTAL LENGTH (m)					302.25	42.75	46.80	166.30	39.00	
UNIT WEIGHT (kg/m)					0.40	0.69	1.21	1.58	2.47	
WEIGHT (kg)					119.4	38.0	56.6	247.6	96.3	
T.WEIGHT (kg)					557.3					

BEAM ELEVATIONS1

Scale: 1/120

OBJEKTI	RINDERTIMI I SHKOLLËS 9-VJECARE "HYSEN XHEKA"	NR.FLETES	A-05
VENDNDODHJA	KARBUNARE	FORMATI	420X297
EMERT.I FLETES	DETAJ I ARMIMIT TE TRAREVE TE THEMELEVE	SHKALLA	1:500
DREJTOR	ING. MIMOZA HAXHILU		
PERGJEGJES			
SPECIALIST	ARK. OKSANA BAXHO		
SPECIALIST	ORJALD DEBINJA		
SPECIALIST	ING. ARTUR SINANI		
SPECIALIST	ING. ARBEN MUCA		
SPECIALIST	ING. MALDIN CELA	REPUBLIKA E SHQIPERISE BASHKIA LUSHNJE	
SPECIALIST	ING. KLAJDI MYZEQARI		

## DETAJ I ARMIMIT TRAREVE THEMELEVE

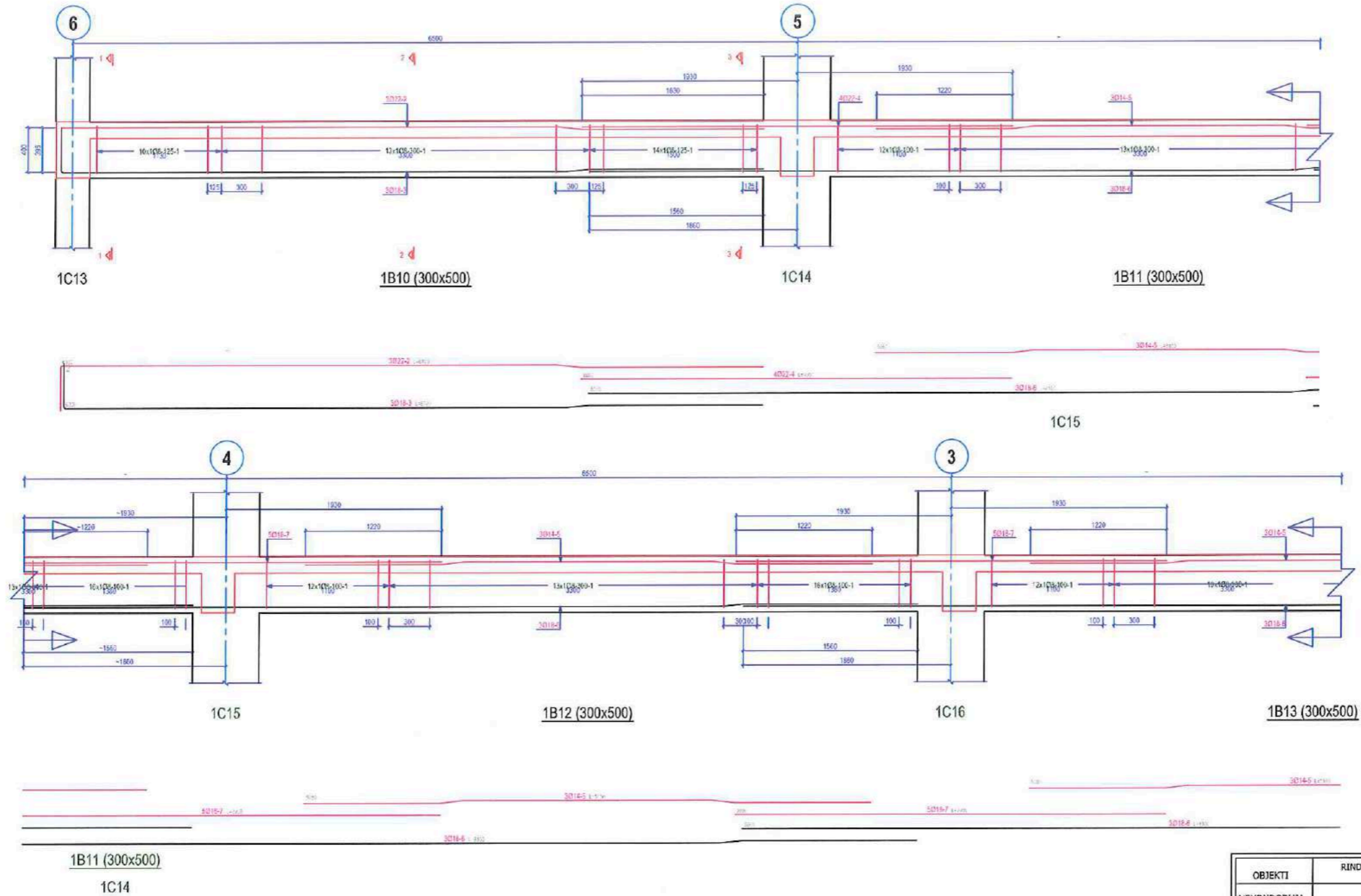

OBJEKTI	RINDERTIMI I SHKOLLËS 9-VJECARE "HYSEN XHEKA"	NR.FLETES	A-05
VENDNDODHJA	KARBUNARE	FORMATI	420x297
EMERT.I FLETES	DETAJ I ARMIMIT TE TRAREVE TE THEMELEVE	SHKALLA	1:500
DREJTOR	ING. MIMOZA HAXHIU	 REPUBLIKA E SHQIPËRISË BASHKIA LUSHNJË	
PERGJEGJES			
SPECIALIST	ARK. OKSANA BAXHO		
SPECIALIST	ORJALD DEBINJA		
SPECIALIST	ING. ARTUR SINANI		
SPECIALIST	ING. ARBEN MUJA		
SPECIALIST	ING. MALDIN CELA		
SPECIALIST	ING. KLAJDI MYZEQARI		





# DETAJ I ARMIMIT TRAREVE THEMELEVE

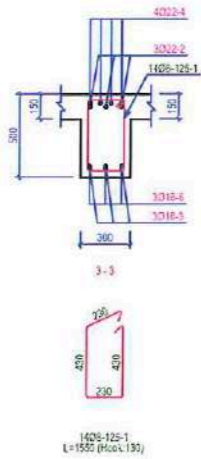
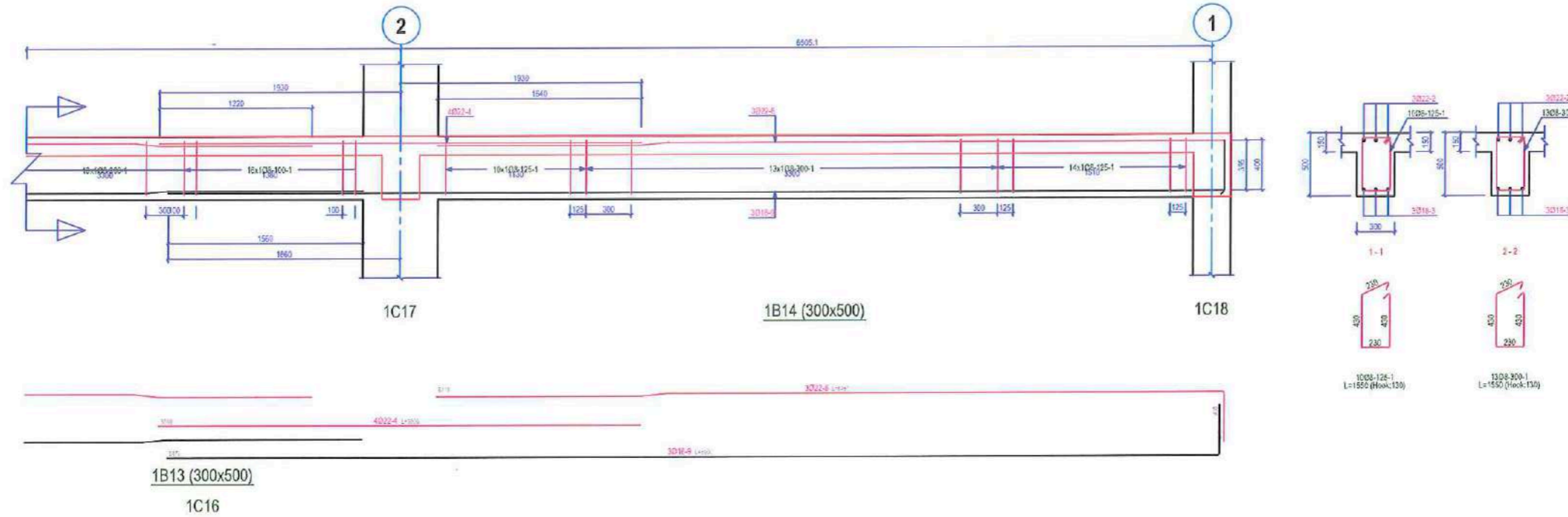

Quantity Table					TOTAL LENGTH (m)			
NO	SIZE	Q/IA	LENGTH (m)	FORM	Ø8	Ø14	Ø18	Ø22
					1	8	197	1550
2	22	3	6700				20.10	
3	18	3	6700			20.10		
4	22	8	3900				31.20	
5	14	9	8100		45.90			
6	18	9	8100			72.90		
7	18	10	3900			39.00		
8	22	3	6750				20.25	
9	18	3	8900			28.70		
TOTAL LENGTH (m)					325.35	45.90	158.70	71.55
UNIT WEIGHT (kg/m)					0.48	1.21	2.00	2.99
WEIGHT (kg)					150.6	55.5	317.4	213.8
T.WEIGHT (kg)					707.3			

BEAM ELEVATIONS1

Scale: 1/120

OBJEKTI	RINDERTIMI I SHKOLLËS 9-VJEÇARE "HYSEN XHEKA"	NR.FLETES	A-05
VENDNDODHJA	KARBUNARE	FORMATI	420X297
EMERT.I FLETES	DETAJ I ARMIMIT TE TRAREVE TE THEMELEVE	SHKALLA	1:500
DREJTOR	ING. MIMOZA HAXHIU		
PERGJEGJES			
SPECIALIST	ARK. OKSANA BAXHO		
SPECIALIST	ORJALD DEBINJA		
SPECIALIST	ING. ARTUR SINANI		
SPECIALIST	ING. ARBEN MIKA		
SPECIALIST	ING. MALDIN CELA		
SPECIALIST	ING. KLAJDI MYZEQARI		

## DETAJ I ARMIMIT TRAREVE THEMELEVE

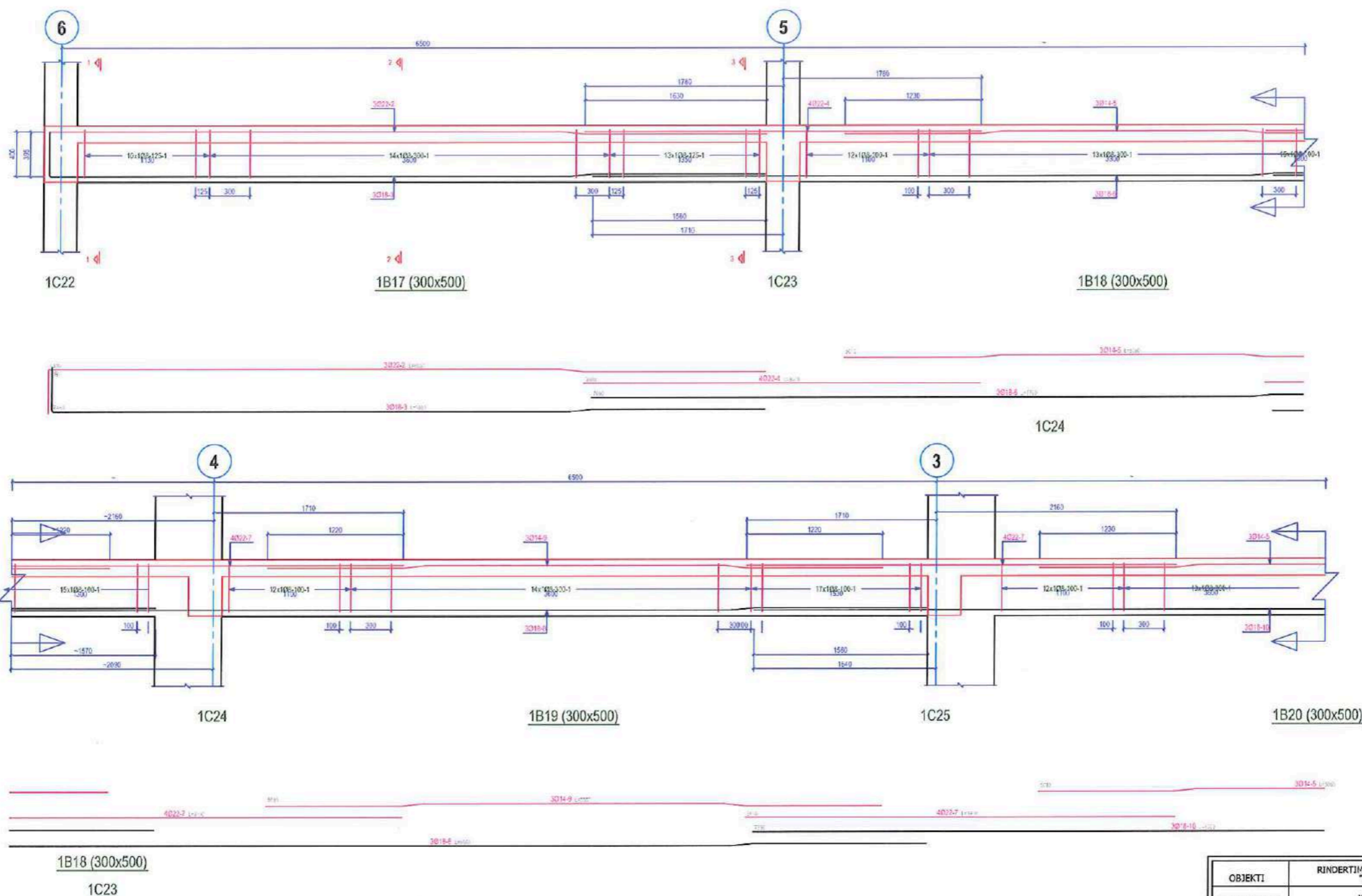

OBJEKTI	RINDERTIJA I SHKOLLES 9-VJECARE "HYSEN XHEKA"	NR.FLETES	A-05
VENDNDODHJA	KARBUNARE	FORMATI	420X297
EMERT.I FLETES	DETAJ I ARMIMIT TE TRAREVE TE THEMELEVE	SHKALLA	1:500
DREJTOR	ING. MIMOZA HAXHIU	 REPUBLIKA E SHQIPERISE BASHKIA E LUSHNJE	
PERGJEGJES			
SPECIALIST	ARK. OKSANA BAXHO		
SPECIALIST	ORJALD DEBINA		
SPECIALIST	ING. ARTUR SIMANI		
SPECIALIST	ING. ARBEN MUCA		
SPECIALIST	ING. MALDIN CELA		
SPECIALIST	ING. KLAJDI NYZEQARI		



# DETAJ I ARMIMIT TRAREVE THEMELEVE

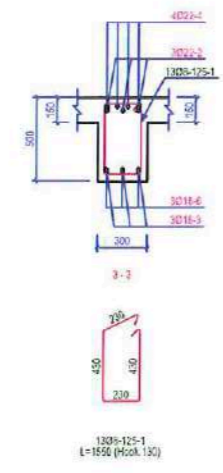
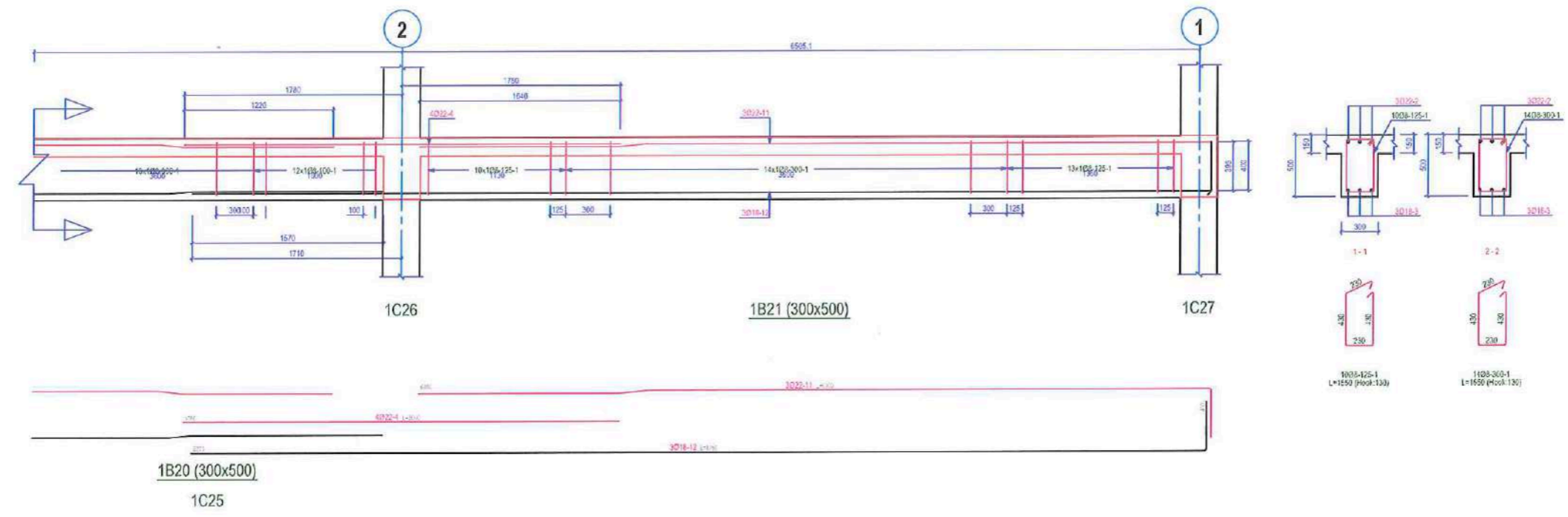

Quantity Table								
NO	SIZE	QVA	LENGTH (mm)	FORM	TOTAL LENGTH (m)			
					Ø8	Ø14	Ø18	Ø22
1	8	194	1550		300.70			
2	22	3	6850					20.55
3	18	3	6850					20.55
4	22	8	3000					28.80
5	14	6	5050			30.30		
6	18	3	7700				23.10	
7	22	8	3000					21.20
8	18	3	8550					25.65
9	14	3	5050			10.55		
10	18	3	8000					24.60
11	22	3	6900					20.70
12	18	3	8750					26.25
TOTAL LENGTH (m)					300.70	48.26	110.55	101.25
UNIT WEIGHT (kg/m)					0.40	1.21	2.00	2.99
WEIGHT (kg)					118.8	58.8	220.1	302.5
T.WEIGHT (kg)					717.2			

BEAM ELEVATIONS1

Scale: 1/120

OBJEKTI	RINDERTIMI I SHKOLLES 9-VJECARE "HYSEN XHEKA"	NR.FLETES	A-05
VENDNDODHJA	KARBUNARE	FORMATI	420X297
EMERT.I FLETES	DETAJ I ARMIMIT TE TRAREVE TE THEMELEVE	SHKALLA	1:500
DREJTOR	ING. MIMOZA HAXHIU		
PERQJES			
SPECIALIST	ARK. OKSANA BAXHO		
SPECIALIST	ORJALD DEBINJA		
SPECIALIST	ING. ARTUR SINANI		
SPECIALIST	ING. ARBEN MIKA		
SPECIALIST	ING. MALDIN CELA		
SPECIALIST	ING. KLAJDI MYZEQARI		



## DETAJ I ARMIMIT TRAREVE THEMELEVE

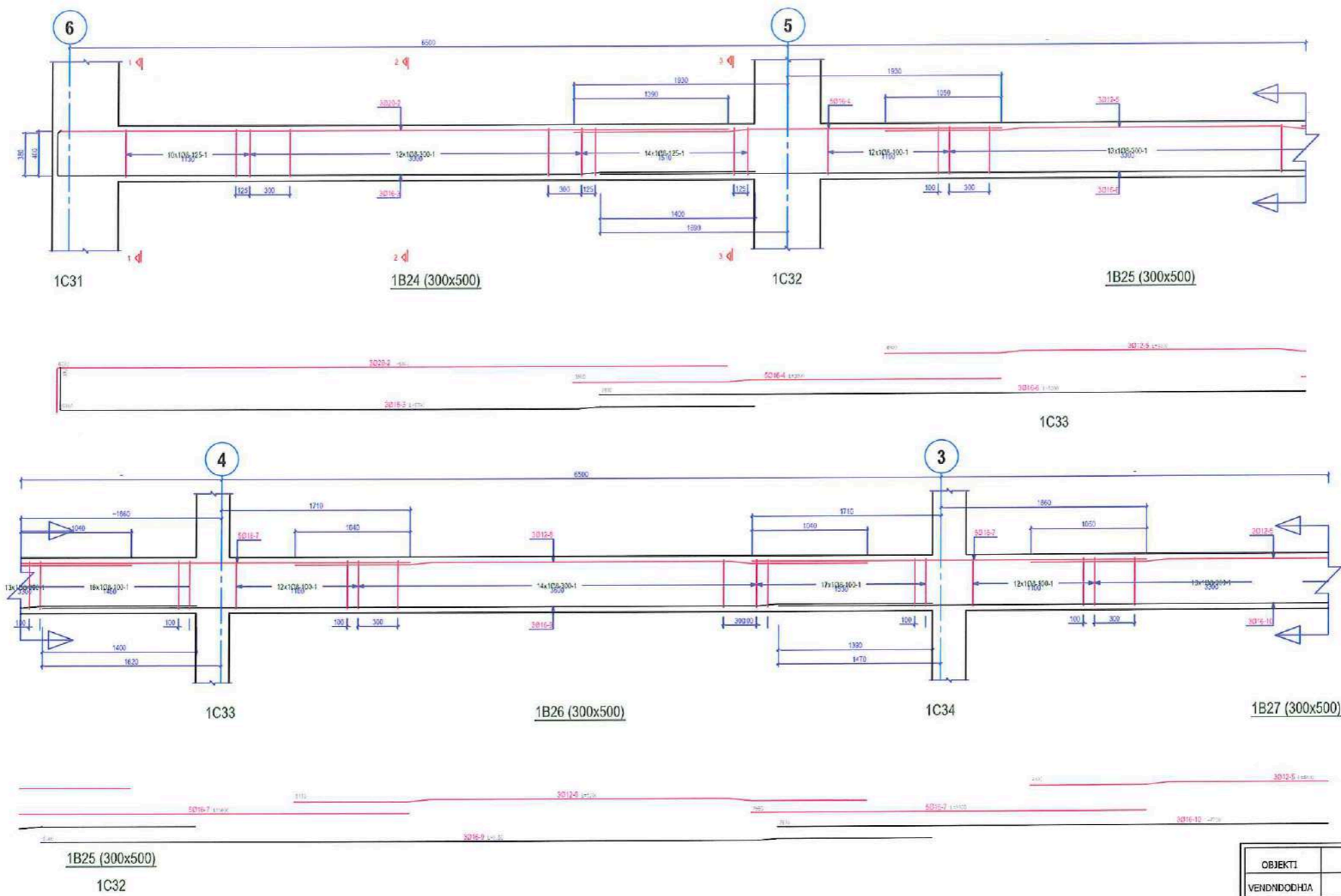

OBJEKTI	RINDERTIMI I SHKOLLËS 9-VJECARE "HYSEN XHEKA"	NR.FLETES	A-05
VENDNDODHJA	KARBUNARE	FORMATI	420X297
EMERT.I FLETES	DETAJ I ARMIMIT TE TRAREVE TE THEMELEVE	SHKALLA	1:500
DREJTOR	ING. MIMOZA HAXHUU		
PERGJEGJES			
SPECIALIST	ARK. OKSANA BAXHO		
SPECIALIST	ORJALD DEBINJA		
SPECIALIST	ING. ARTUR SINANI		
SPECIALIST	ING. ARBEN MUCA		
SPECIALIST	ING. MALDIN CELA		
SPECIALIST	ING. KLAJDI MYZEQARI		



# DETAJ I ARMIMIT TRAREVE THEMELEVE

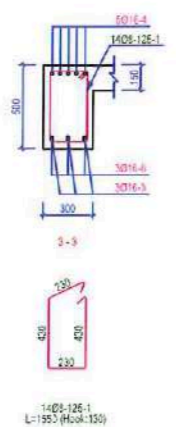
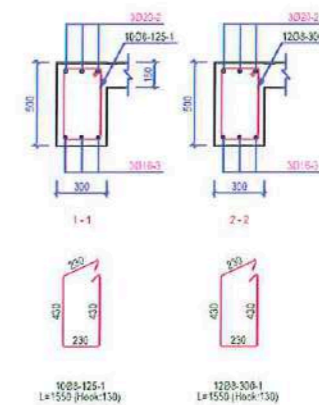
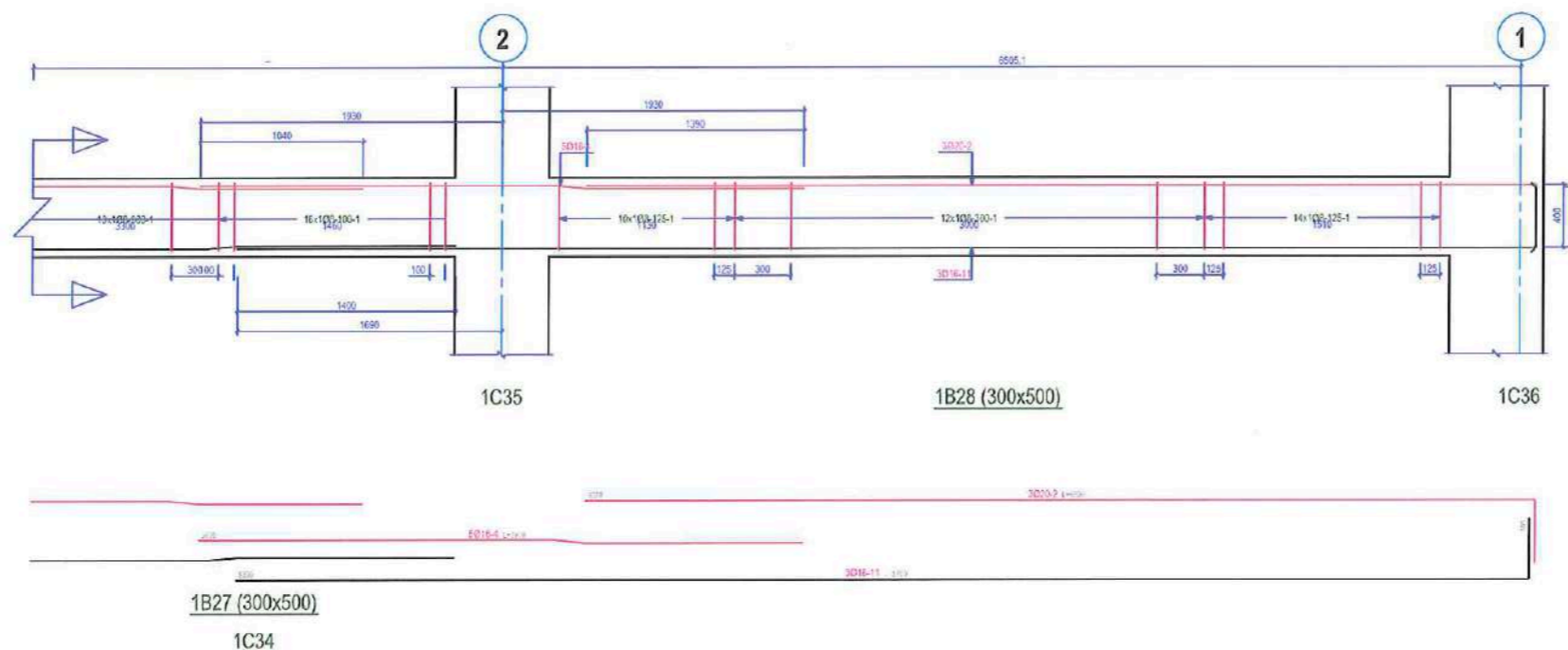

Quantity Table								
NO	SIZE	QUA	LENGTH (mm)	FORM	TOTAL LENGTH (m)			
					Ø5	Ø12	Ø16	Ø20
1	8	157	1500		395.35			
2	20	6	6500					39.00
3	16	3	6700				20.10	
4	16	10	3900				39.00	
5	12	6	4800			28.60		
6	16	3	8700				24.00	
7	16	10	3500				35.00	
8	12	3	5200			15.60		
9	16	3	8050				24.15	
10	16	3	7700				23.10	
11	16	3	8700				25.10	
TOTAL LENGTH (m)					395.35	44.40	152.45	39.00
UNIT WEIGHT (kg/m)					0.49	0.85	1.58	2.47
WEIGHT (kg)					120.6	32.5	301.1	96.3
T.WEIGHT (kg)					560.5			

OBJEKTI	RINDERTIPI I SHKOLLËS 9-VJECARE "HYSEN XHEKA"	NR.FLETES	A-05
VENDNDODHJA	KARBUNARE	FORMATI	420X297
EMERT I FLETES	DETAJ I ARMIMIT TE TRAREVE TE THEMELEVE	SHKALLA	1:500
DREJTOR	ING. MIMOZA HAXHIU		
PERGJEGJES			
SPECIALIST	ARK. OKSANA BASHO		
SPECIALIST	ORJALD DEBINJA		
SPECIALIST	ING. ARTUR SINANI		
SPECIALIST	ING. ARBEN MUCA		
SPECIALIST	ING. MALDIN CELA		
SPECIALIST	ING. KLAJDI MYZEQARI		



# DETAJ I ARMIMIT TRAREVE THEMELEVE

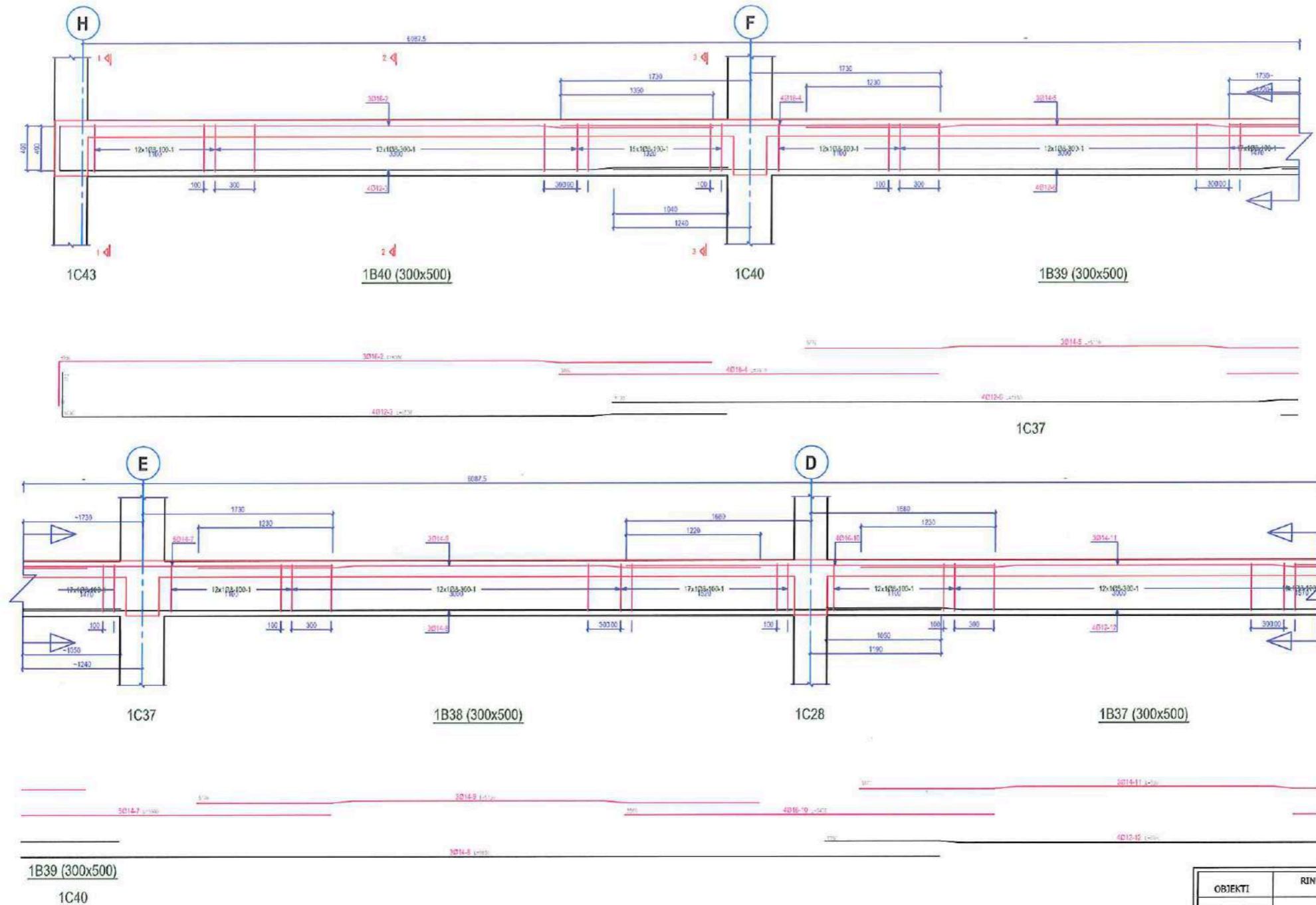

OBJEKTI	RINDERTIJA I SHKOLLES 9-VJECARE "HYSEN XHEKA"	NR.FLETES	A-05
VENDNDODHJA	KARBUNARE	FORMATI	420x297
EMERT.I FLETES	DETAJ I ARMIMIT TE TRAREVE TE THEMELEVE	SHKALLA	1:500
DREJTOR	ING. MIMOZA HAXHIU		
PERGJEGJES			
SPECIALIST	ARK. OKSANA BAXHO		
SPECIALIST	ORJALD DEBINJA		
SPECIALIST	ING. ARTUR SIMANI		
SPECIALIST	ING. ARBEN MIKA		
SPECIALIST	ING. MALDIN CELA		
SPECIALIST	ING. KLAJDI MYZEQARI		



# DETAJ I ARMIMIT TRAREVE THEMELEVE

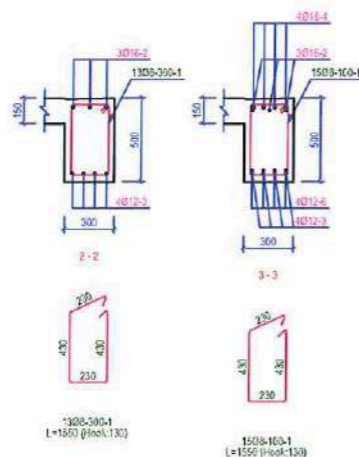
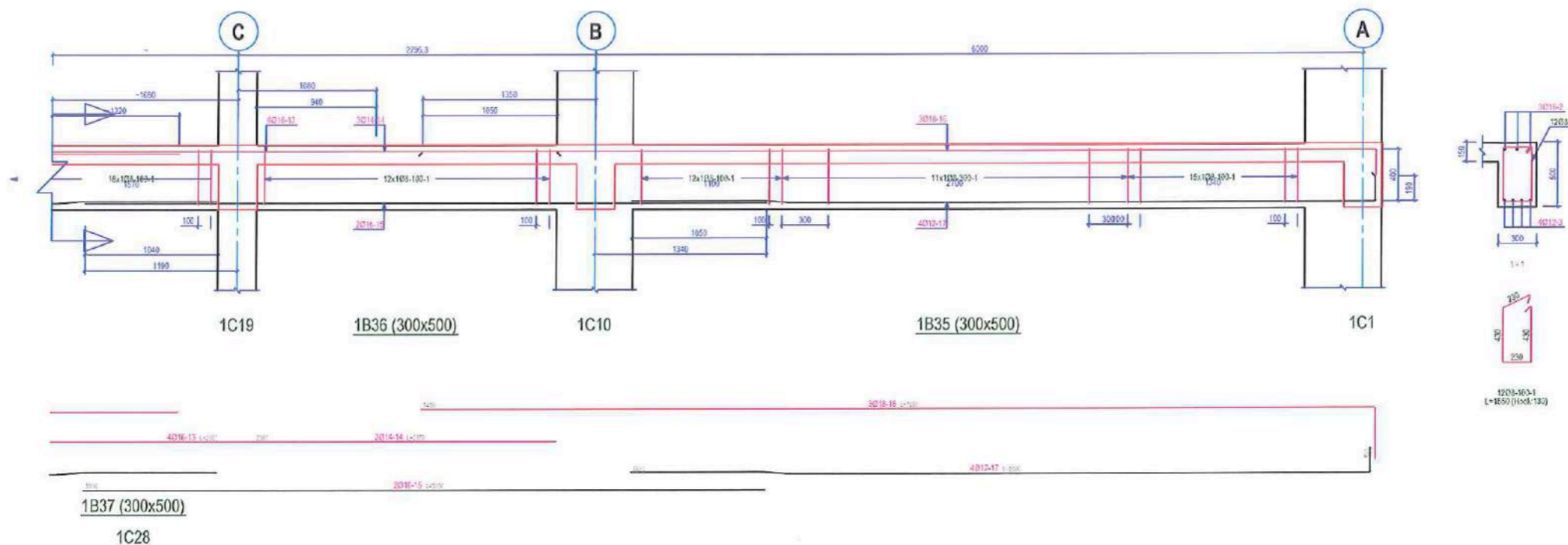

Quantity Table											
NO	SIZE	QUA.	LENGTH (mm)	FORM	TOTAL LENGTH (m)						
					Ø8	Ø12	Ø14	Ø16	Ø18		
1	8	214	1550		331.70						
2	16	3	6350					19.05			
3	12	4	6500			20.00					
4	18	4	3500						14.00		
5	14	3	5100				15.30				
6	12	4	7150			28.60					
7	14	5	3500				17.50				
8	14	3	8550				25.65				
9	14	3	5150				15.45				
10	18	4	2400						13.60		
11	14	3	5200				15.60				
12	12	4	5800			23.20					
13	18	4	2800						11.20		
14	14	3	2350				7.05				
15	18	2	5350						10.70		
16	18	3	7850						23.55		
17	12	4	6000			24.00					
TOTAL LENGTH (m)					331.70	161.85	96.65	54.55	37.55		
UNIT WEIGHT (kg/m)					0.49	0.89	1.21	1.58	2.00		
WEIGHT (kg)					131.6	90.5	116.8	86.2	75.1		
TOTAL WEIGHT (kg)					499.6						

OBJEKTI	RINDERTIMI I SHKOLLËS 9-VJECARE "HYSEN XHEKA"	NR.FLETES	A-05
VENDNDODHJA	KARBUNARE	FORMATI	420X297
EMERT.I FLETES	DETAJ I ARMIMIT TE TRAREVE TE THEMELEVE	SHKALLA	1:500
DREJTOR	ING. MIMOZA HAXHIU	 REPUBLIKA E SHQIPËRIE BASHKIA LUSHNJE	
PERGJEGJES			
SPECIALIST	ARK. OKSANA BAXHO		
SPECIALIST	ORJALD DEBINJA		
SPECIALIST	ING. ARTUR SINANI		
SPECIALIST	ING. ARBEN MUCA		
SPECIALIST	ING. MALDIN CELA		
SPECIALIST	ING. KLAJDI NYZEQARI		



# DETAJ I ARMIMIT TRAREVE THEMELEVE

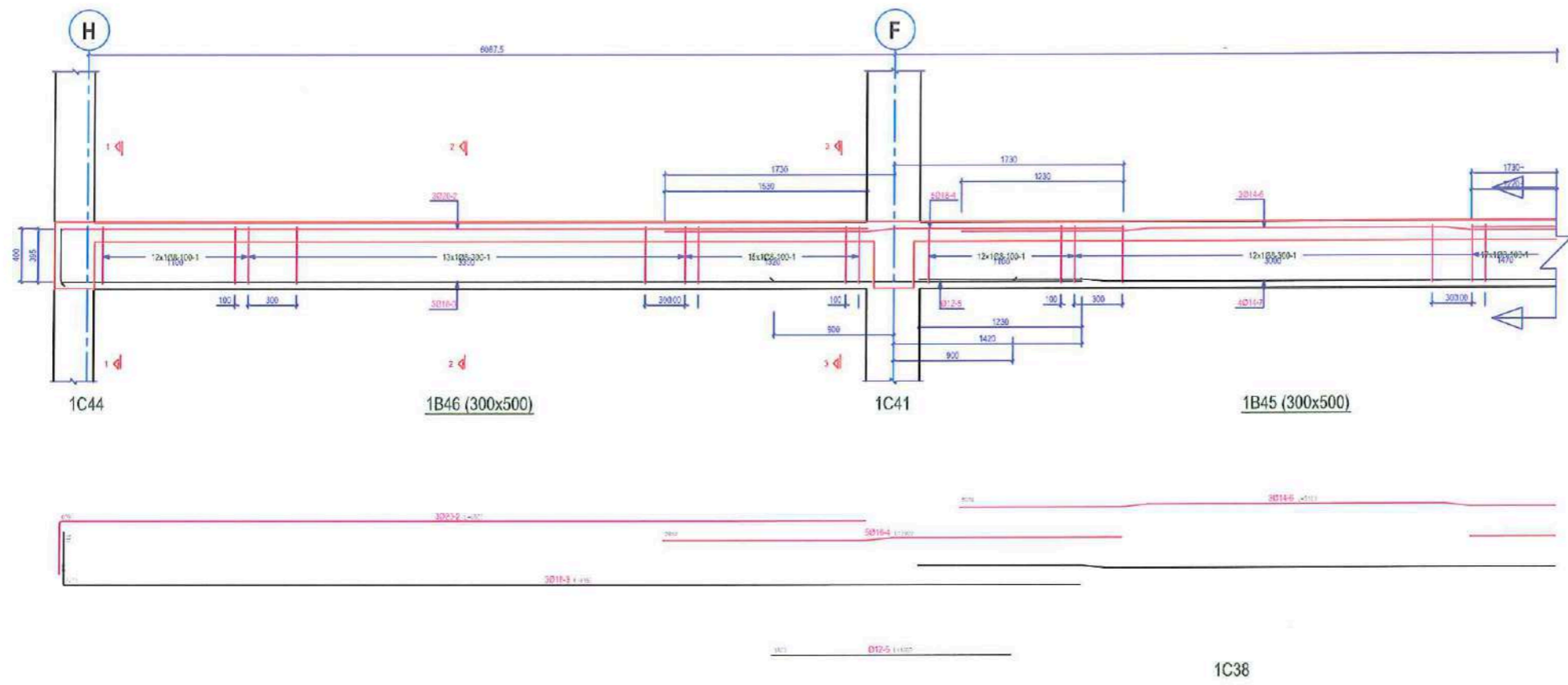

BEAM ELEVATIONS1 Scale: 1/120

OBJEKTI	RINDERTIMI I SHKOLLËS 9-VJEÇARE "HYSEN XHEKA"	NR.FLETES	A-05
VENDNDODHJA	KARBUNARE	FORMATI	420X297
EMERT.I FLETES	DETAJ I ARMIMIT TE TRAREVE TE THEMELEVE	SHKALLA	1:500
DREJTOR	ING. MIMOZA HAXHIU	 REPUBLIKA E SHQIPËRIE BASHKIA LUSHNJE	
PERGJEGJES			
SPECIALIST	ARK. OKSANA BAXHO		
SPECIALIST	ORJALD DEBINJA		
SPECIALIST	ING. ARTUR SINANI		
SPECIALIST	ING. ARBEN MUCA		
SPECIALIST	ING. HALDIN CELA		
SPECIALIST	ING. KLAJDI MYZEQARI		



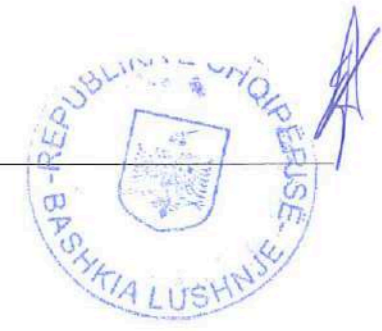

# DETAJ I ARMIMIT TRAREVE THEMELEVE

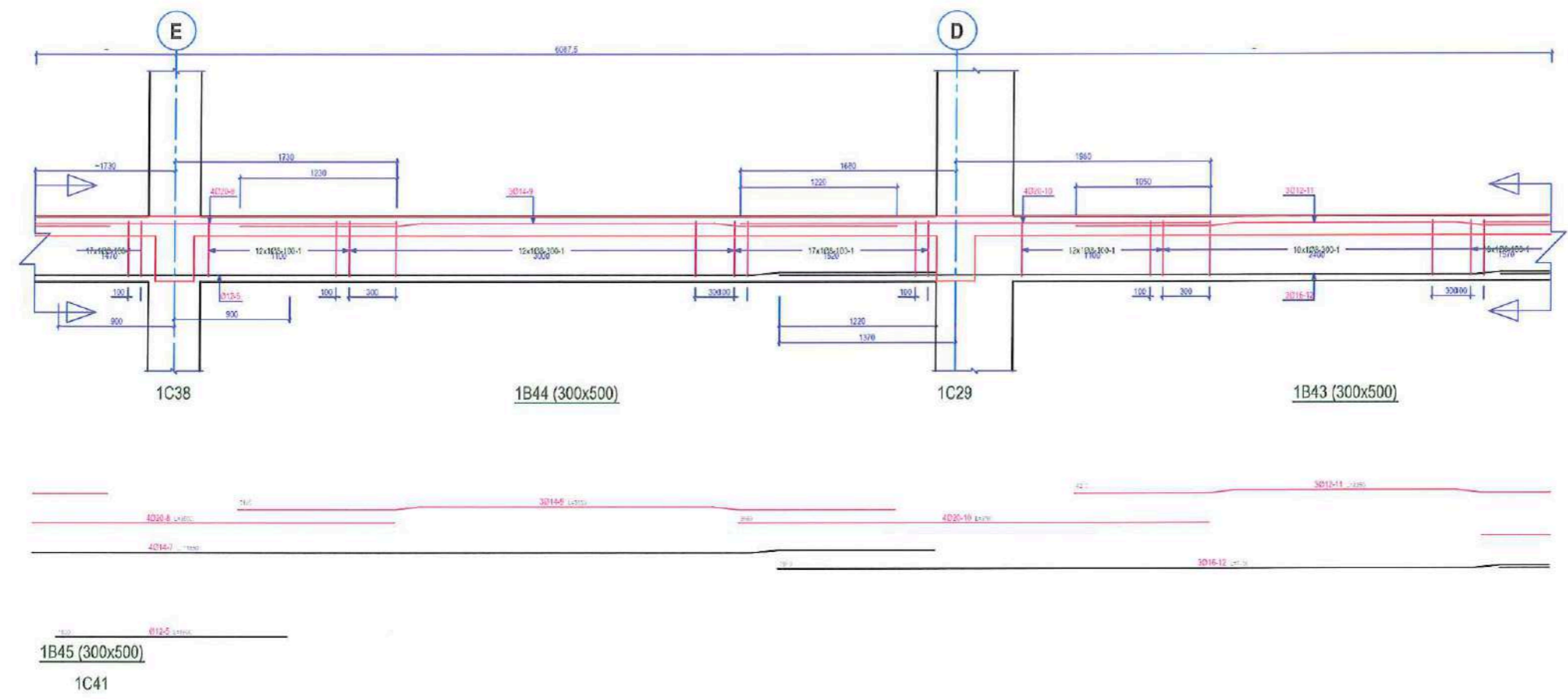

BEAM ELEVATIONS1

Scale: 1/120

OBJEKTI	RINDERTIMI I SHKOLLES 9-VJECARE "HYSEN XHEKA"	NR.FLETES	A-05
VENDNDODHJA	KARBUNARE	FORMATI	420X297
EMERT.I FLETES	DETAJ I ARMIMIT TE TRAREVE TE THEMELEVE	SHKALLA	1:500
DREJTOR	ING. MIMOZA HAXHBU	 REPUBLIKA E SHQIPERISE BASHKIA LUSHNJE	
PERGJEGJES			
SPECIALIST	ARK. OXSANA BAXHO		
SPECIALIST	ORJALD DEBINJA		
SPECIALIST	ING. ARTUR SINANI		
SPECIALIST	ING. ARBEN MUCA		
SPECIALIST	ING. MALDIN CELA		
SPECIALIST	ING. KLADI MYZEQARI		



# DETAJ I ARMIMIT TRAREVE THEMELEVE

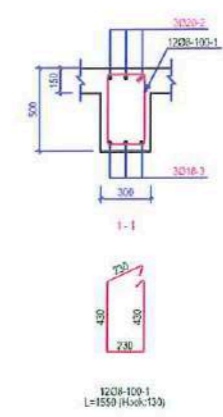
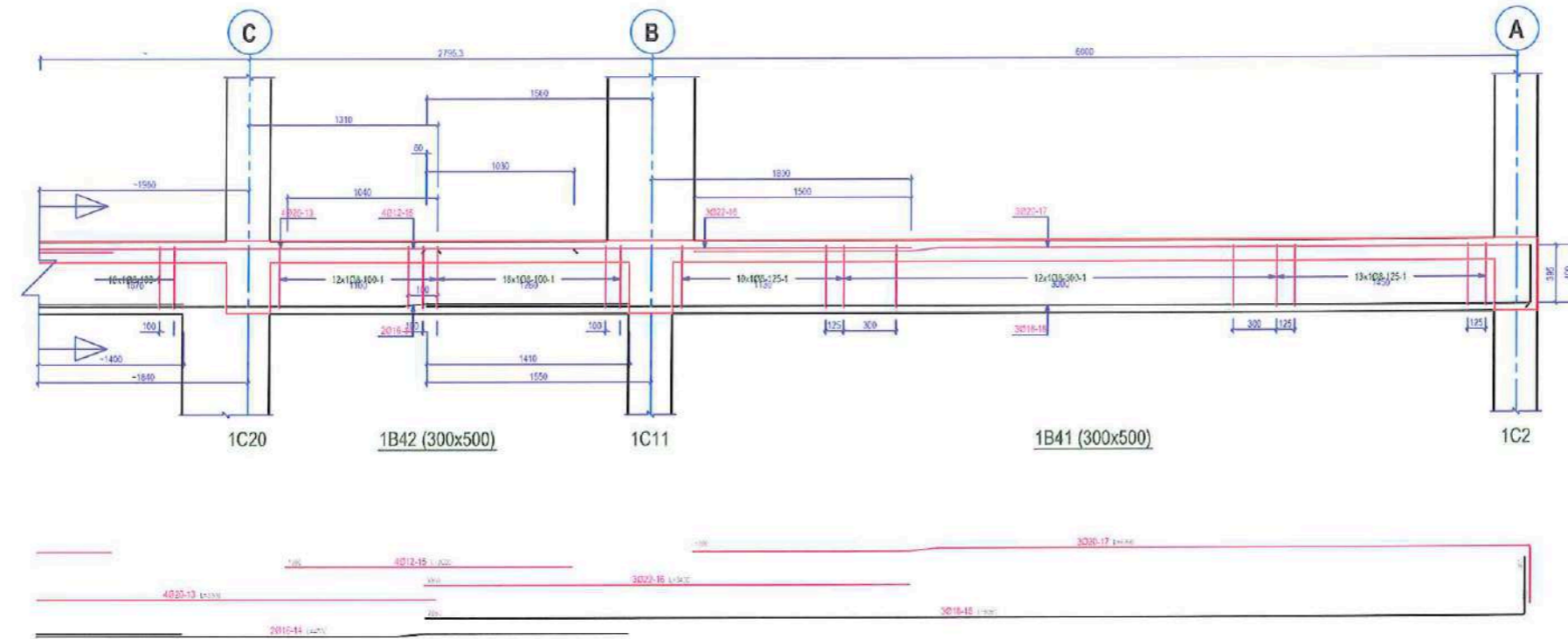

1B43 (300x500)  
1C29

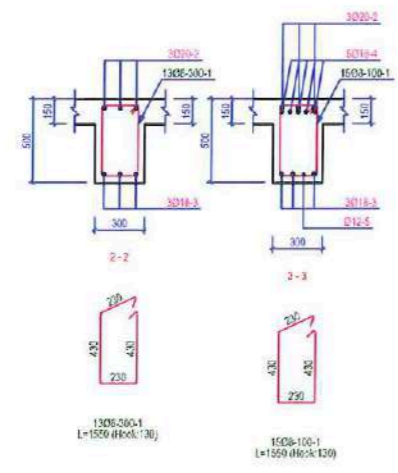

Quantity Table													
NO	SIZE	QJA	LENGTH (mm)	FORM	TOTAL LENGTH (m)								
					Ø8	Ø12	Ø14	Ø16	Ø18	Ø20	Ø22		
1	8	220	1550	□	353.40								
2	20	3	5520	□							16.50		
3	18	3	8190	□						24.45			
4	18	5	3520	□						17.50			
5	12	2	1620	□	3.60								
6	14	3	5120	□			15.30						
7	14	4	11850	□			47.40						
8	20	4	3620	□						14.00			
9	14	3	5150	□			15.45						
10	20	4	3700	□						14.80			
11	12	3	4250	□		12.75							
12	16	3	7050	□				21.15					
13	20	4	3300	□						13.20			
14	16	2	4500	□				9.00					
15	12	4	2020	□		8.00							
16	22	3	3400	□							10.20		
17	20	3	6200	□						18.60			
18	16	3	8050	□					24.15				
TOTAL LENGTH (m)					353.40	24.25	78.15	30.15	66.10	89.30	10.20		
UNIT WEIGHT (kg/m)					0.40	0.89	1.21	1.58	2.00	2.47	2.90		
WEIGHT (kg)					139.6	21.6	94.6	47.5	132.2	197.8	30.5		
T.WEIGHT (kg)					663.9								

BEAM ELEVATIONS1

Scale: 1/120

OBJEKTI	RINDERTIMI I SHKOLLES 9-VJECARE "HYSEN XHEKA"	NR.FLETES	A-05
VENDNDODHJA	KARBUNARE	FORMATI	420X297
EMERT.I FLETES	DETAJ I ARMIMIT TRAREVE TE THEMELEVE	SHKALLA	1:500
DIREKTOR	ING. MIMOZA HAXHIBU		
PERGJEGJES			
SPECIALIST	ARK. OKSANA BASHO		
SPECIALIST	ORJALD DEBINJA		
SPECIALIST	ING. ARTUR SINANI		
SPECIALIST	ING. ARBEN MUCA		
SPECIALIST	ING. MALDIN CELA	REPUBLIKA E SHQIPERISE BASHKIA LUSHNJE	
SPECIALIST	ING. KLAJDI MYZEQARI		



# DETAJ I ARMIMIT TRAREVE THEMELEVE

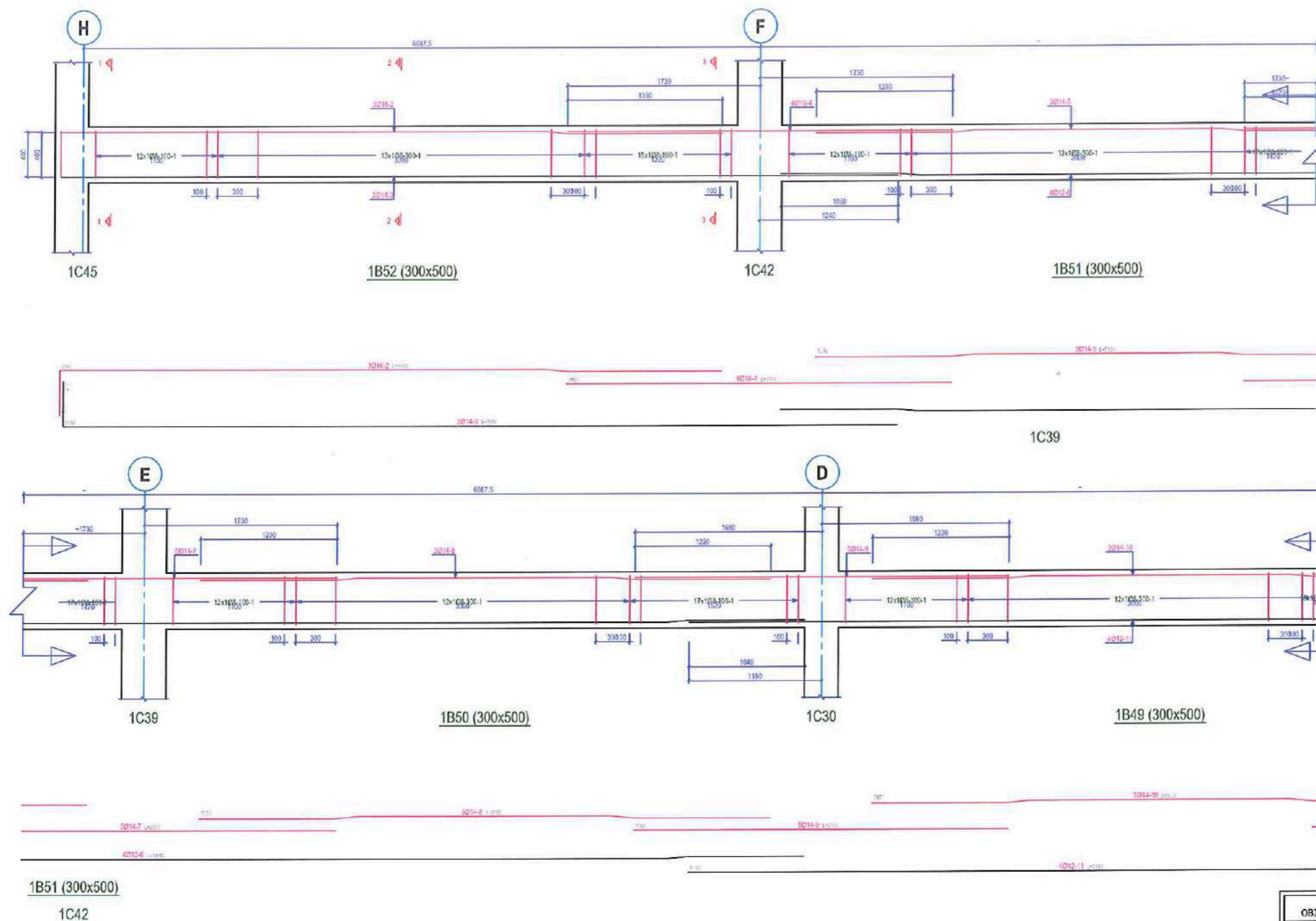

OBJEKTI	RINDERTIMI I SHKOLLES 9-VJECARE "HYSEN XHEKA"	NR.FLETES	A-05
VENDNDODHJA	KARBUNARE	FORMATI	420X297
EMERTI FLETES	DETAJ I ARMIMIT TE TRAREVE TE THEMELEVE	SHKALLA	1:500
DREJTOR	ING. MINOZA HAXHIU	 REPUBLIKA E SHQIPERISE BASHKIA LUSHNJE	
PERGJEGJES			
SPECIALIST	ARK. OKSANA BAXHO		
SPECIALIST	ORJALD DEBINA		
SPECIALIST	ING. ARTUR SINANI		
SPECIALIST	ING. ARBEN MUCA		
SPECIALIST	ING. MALDIN CELA		
SPECIALIST	ING. KLAUDI MYZEQARI		



# DETAJ I ARMIMIT TRAREVE THEMELEVE

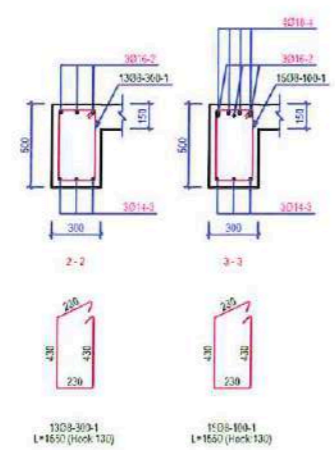
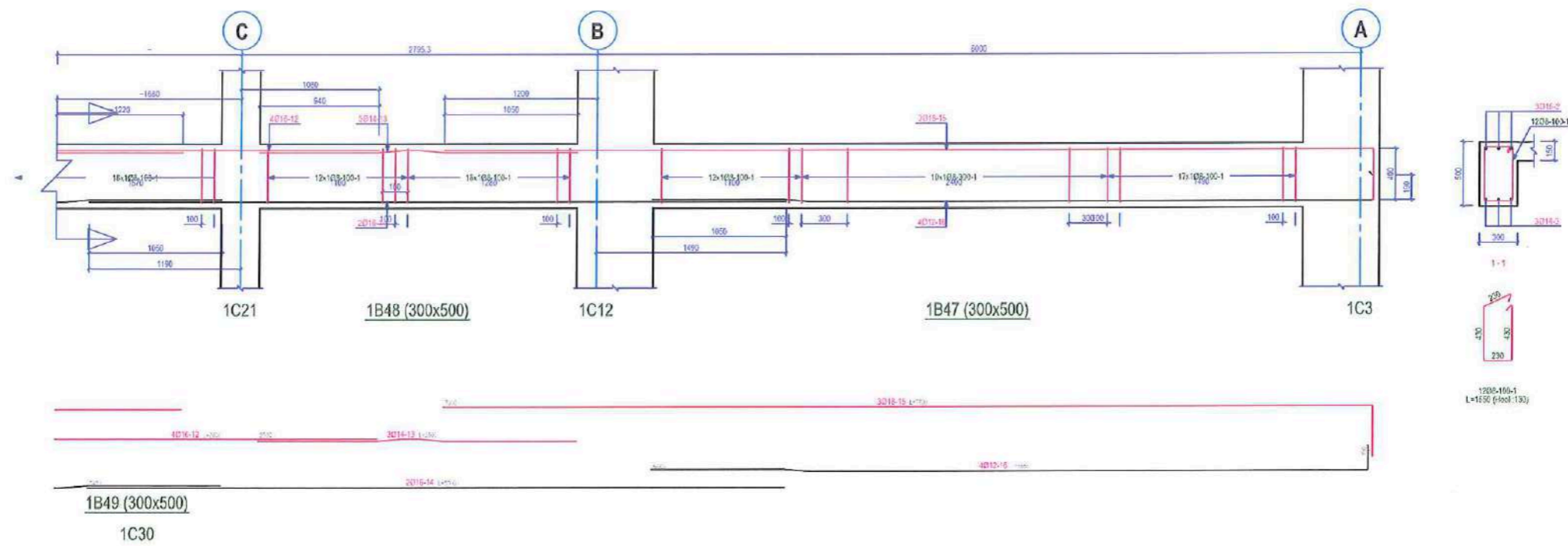

Quantity Table									
NO	SIZE	QUA	LENGTH (mm)	FORM	TOTAL LENGTH (m)				
					Ø8	Ø12	Ø14	Ø16	Ø18
1	8	234	1550	16	362.70				
2	16	3	6350	16				19.05	
3	14	3	7950	16			23.85		
4	16	4	5500	16					14.00
5	14	3	5100	16			15.30		
6	12	4	11850	16		47.40			
7	14	5	3500	16			17.50		
8	14	3	5150	16			15.45		
9	14	5	3400	16			17.00		
10	14	3	5200	16			15.60		
11	12	4	7150	16		28.60			
12	10	4	2800	16				11.20	
13	14	3	2500	16			7.50		
14	16	2	5500	16				11.00	
15	18	3	7700	16					23.10
16	12	4	5850	16		23.40			
TOTAL LENGTH (m)					362.70	96.40	112.20	61.25	37.16
UNIT WEIGHT (kg/m)					0.40	0.89	1.21	1.58	2.00
WEIGHT (kg)					143.3	88.4	135.7	95.2	74.2
T.WEIGHT (kg)					596.8				

OBJEKTI	RINDERTIMI I SHKOLLES 9-VJECARE "HYSEN XHEKA"	NR.FLETES	A-05
VENDNDODHJA	KARBUNARE	FORMATI	420x297
EMERT.I FLETES	DETAJ I ARMIMIT TE TRAREVE TE THEMELEVE	SHKALLA	1:500
DREJTOR	ING. MIMOZA HAXHIU		
PERGJEGJES			
SPECIALIST	ARK. OKSANA BAXHO		
SPECIALIST	ORJALD DEBINJA		
SPECIALIST	ING. ARTUR SINANI		
SPECIALIST	ING. ARBEN MUCA		
SPECIALIST	ING. HALDIN CELA	REPUBLICA E SHQIPERISE BASHKIA LUSHINE	
SPECIALIST	ING. KLAJDI MYZEQARI		



# DETAJ I ARMIMIT TRAREVE THEMELEVE

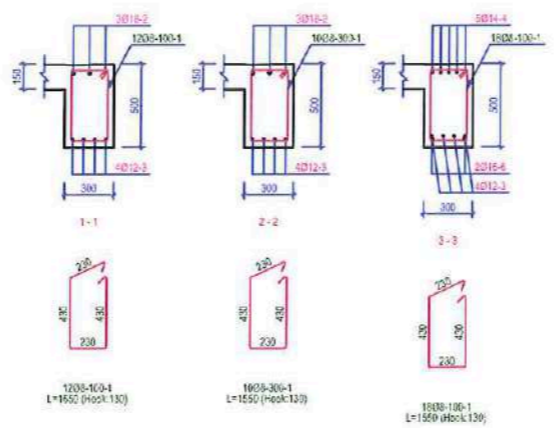
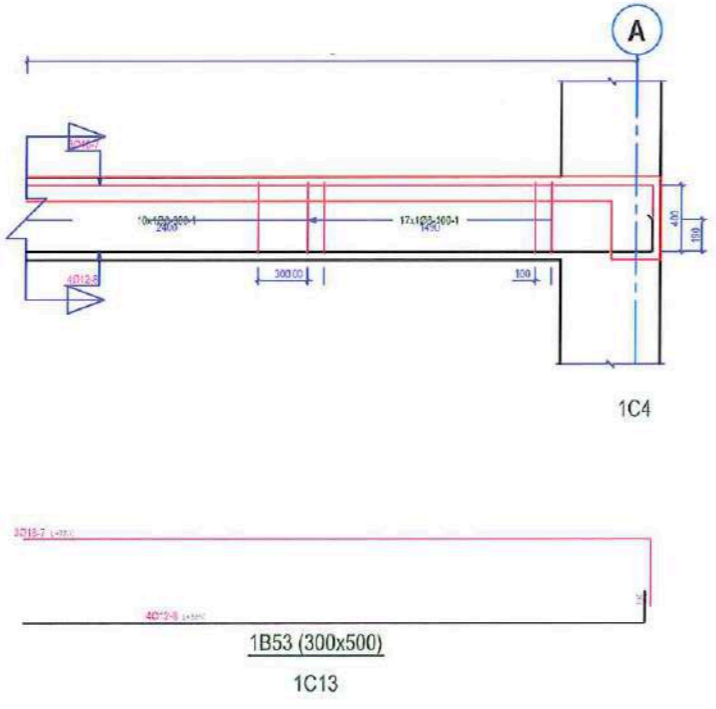
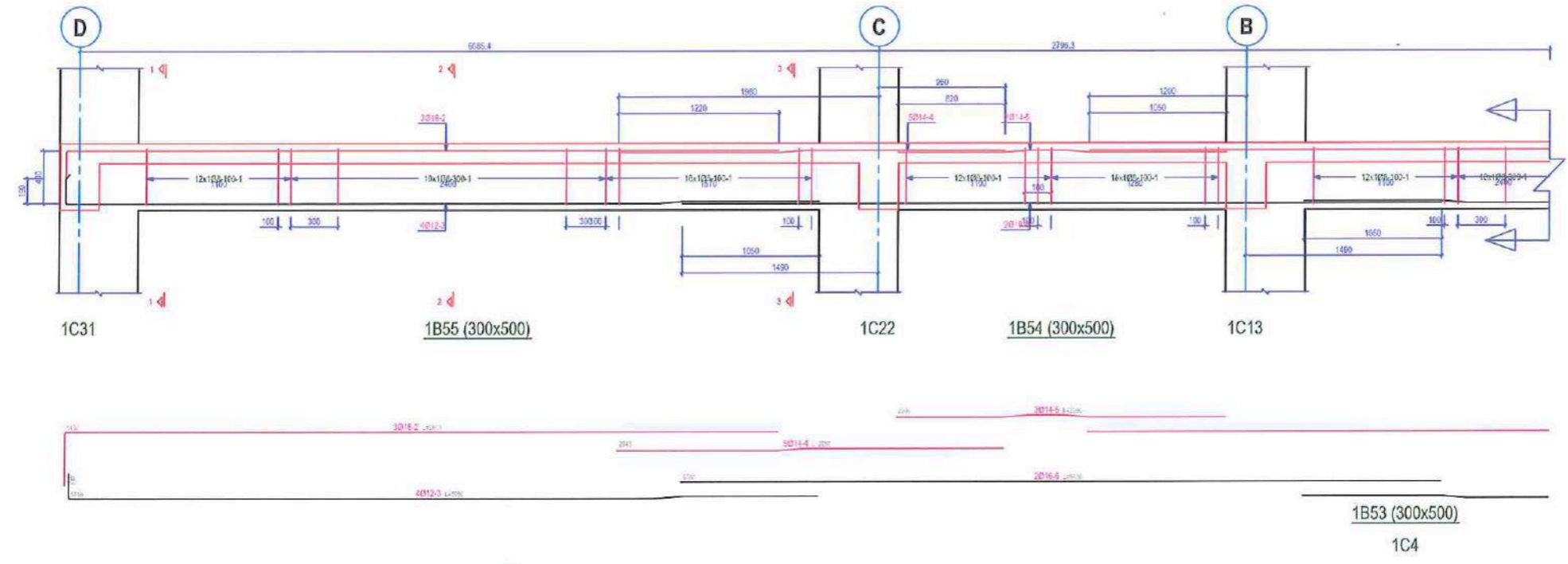

Quantity Table										
NO	SIZE	QMA	LENGTH (mm)	FORM	TOTAL LENGTH (m)					
					Ø8	Ø12	Ø14	Ø16	Ø18	
1	8	110	1559	□	170.50					
2	16	3	6809	□					17.55	
3	12	4	5259	□		23.80				
4	14	5	2259	□			14.75			
5	14	3	2500	□			7.50			
6	16	2	5900	□				11.50		
7	18	3	2700	□					23.10	
8	12	4	5850	□		23.40				
TOTAL LENGTH (m)					170.50	47.20	22.25	11.50	40.65	
UNIT WEIGHT (kg/m)					0.40	0.98	1.21	1.58	2.00	
WEIGHT (kg)					67.4	42.0	25.9	18.3	81.3	
T.WEIGHT (kg)					235.9					

OBJEKTI	RINDERTIMI I SHKOLLES 9-VJECARE "HYSEN XHEKA"	NR.FLETES	A-05
VENDNDODHJA	KARBUNARE	FORMATI	420X297
EMERT.I FLETES	DETAJ I ARMIMIT TE TRAREVE TE THEMELEVE	SHKALLA	1:500
DREJTOR	ING. MIMOZA HAXHBU		
PERGJEGJES			
SPECIALIST	ARK. OKSANA BAXHO		
SPECIALIST	ORJALD DEBINJA		
SPECIALIST	ING. ARTUR SINANI		
SPECIALIST	ING. ARBEN MUJA		
SPECIALIST	ING. MALDIN CELA		
SPECIALIST	ING. KLAJDI MYZEQARI		



# DETAJ I ARMIMIT TRAREVE THEMELEVE

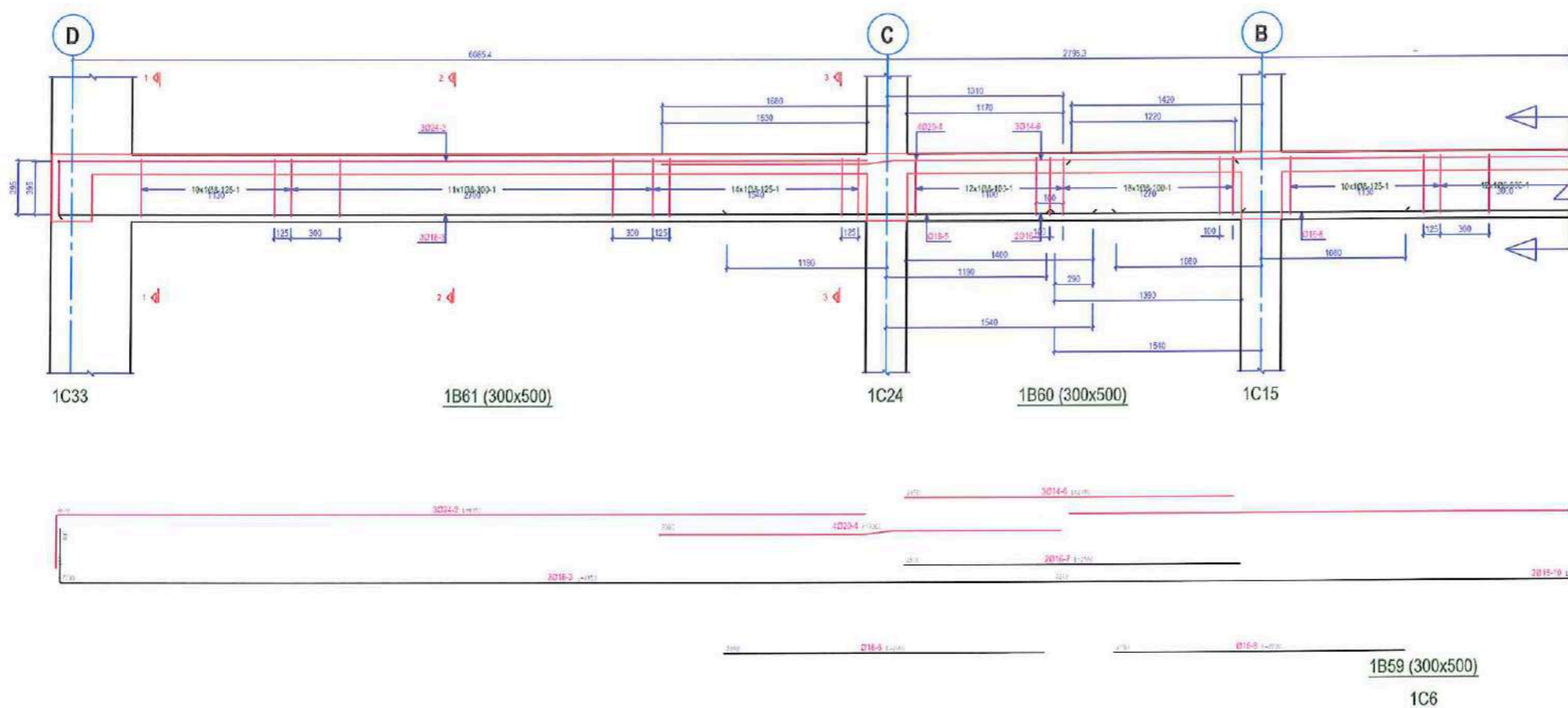

OBJEKTI	RINDERTIMI I SHKOLLES 9-VJECARE "HYSEN XHEKA"	NR.FLETES	A-05
VENDNDODHJA	KARBUNARE	FORMATI	420X297
EMERT.I FLETES	DETAJ I ARMIMIT TE TRAREVE TE THEMELEVE	SHKALLA	1:500
DREJTOR	ING. MIMOZA HAXHIU	 REPUBLIKA E SHQIPERISE BASHKIA E LUSHNJE	
PERGJEGJES			
SPECIALIST	ARK. OKSANA BAXHO		
SPECIALIST	ORJALD DEBINJA		
SPECIALIST	ING. ARTUR SINANI		
SPECIALIST	ING. ARBEN MUCA		
SPECIALIST	ING. MALDIN CELA		
SPECIALIST	ING. KLAIDI MYZEQARI		



# DETAJ I ARMIMIT TRAREVE THEMELEVE

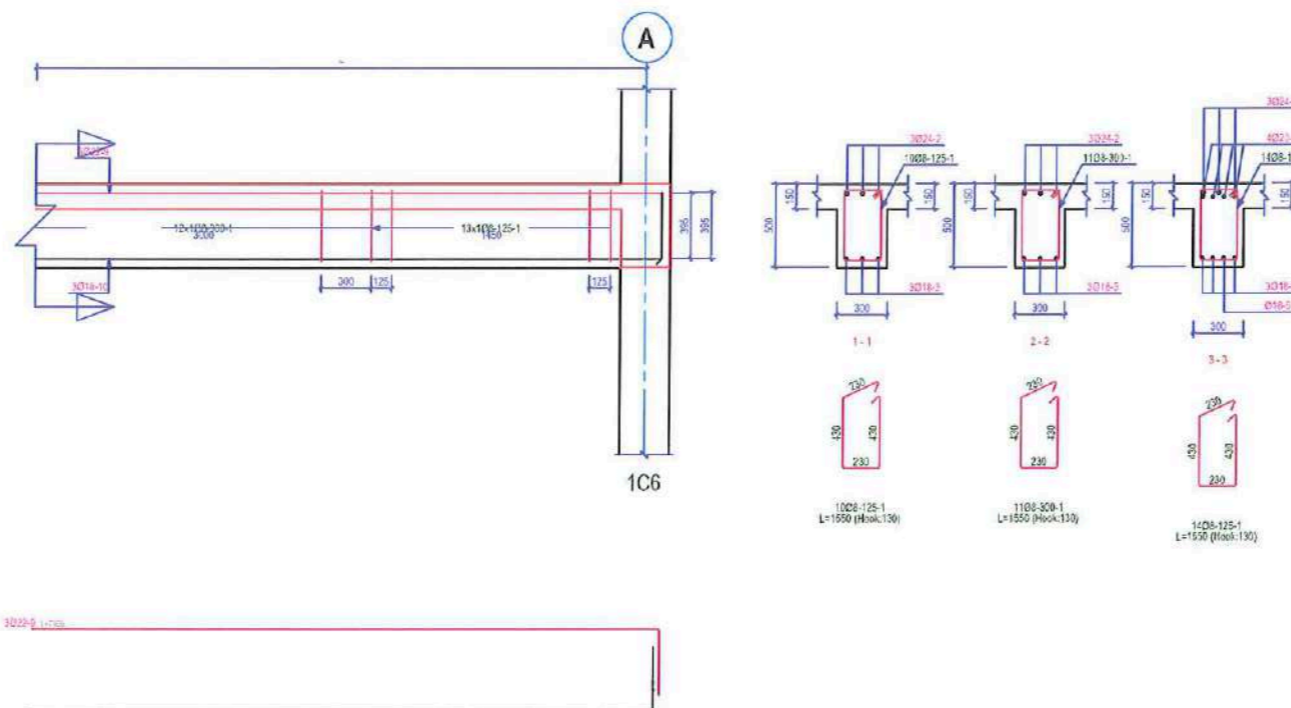

1B59 (300x500)  
1C15

Quantity Table												
NO	SIZE	QVA	LENGTH (mm)	FORM	TOTAL LENGTH (m)							
					Ø8	Ø14	Ø16	Ø18	Ø20	Ø22	Ø24	
1	8	101	1550		155.55							
2	24	3	6450									19.35
3	18	3	8120					24.45				
4	20	4	3000							12.00		
5	18	1	2400					2.40				
6	14	3	2450		7.35							
7	16	2	2500				5.00					
8	16	1	2200				2.20					
9	22	3	7850								23.85	
10	18	3	8650					24.15				
TOTAL LENGTH (m)					196.55	7.35	7.20	51.00	12.00	23.85	19.35	
UNIT WEIGHT (kg/m)					0.46	1.21	1.50	2.00	2.47	2.99	3.56	
WEIGHT (kg)					61.8	8.9	11.4	102.0	29.6	71.3	68.8	
T.WEIGHT (kg)					353.8							

OBJEKTI	RINDERTIMI I SHKOLLËS 9-VJECARE "HYSEN XHEKA"	NR.FLETES	A-05
VENDNDODHJA	KARBUNARE	FORMATI	420X297
EMERT.I FLETES	DETAJ I ARMIMIT TE TRAREVE TE THEMELEVE	SHKALLA	1:500
DREJTOR	ING. MIMOZA HAXHIBU	 REPUBLIKA E SHQIPËRISE BASHKIA LUSHNJË	
PERGJEGJES			
SPECIALIST	ARK. OKSANA BAXHO		
SPECIALIST	ORJALD DEBINJA		
SPECIALIST	ING. ARTUR SINANI		
SPECIALIST	ING. ARBEN MUCA		
SPECIALIST	ING. MALDIN CELA		
SPECIALIST	ING. KLADI MYZEQARI		



# DETAJ I ARMIMIT TRAREVE THEMELEVE

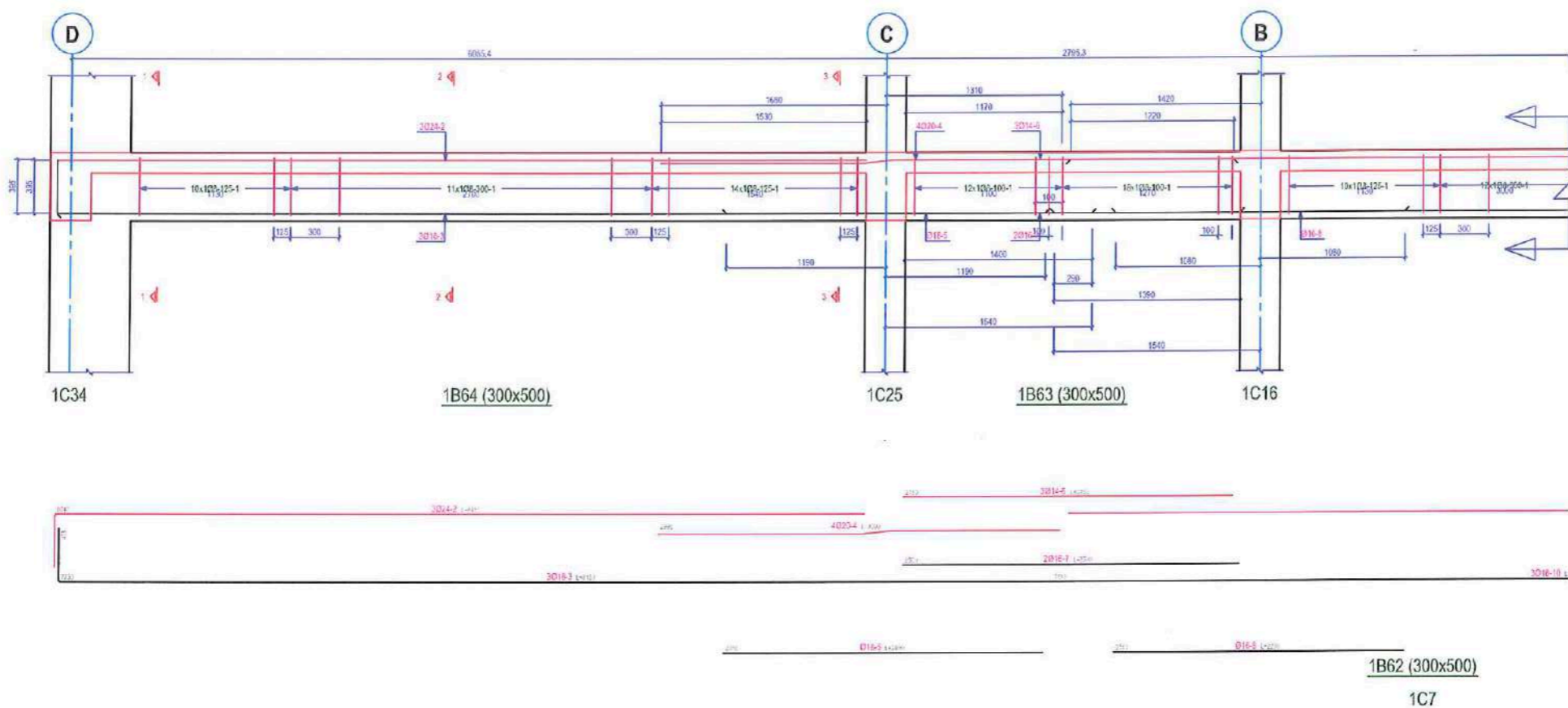

OBJEKTI	RINDERTIMI I SHKOLLES 9-VJECARE "HYSEN XHEKA"	NR.FLETES	A-05
VENDNDODHJA	KARBUNARE	FORMATI	420x297
EMERT.I FLETES	DETAJ I ARMIMIT TE TRAREVE TE THEMELEVE	SHKALLA	1:500
DREJTOR	ING. MIMOZA HAXHILI		
PERGJEGJES			
SPECIALIST	ARK. OKSANA BAXHO		
SPECIALIST	ORJALD DEBINJA		
SPECIALIST	ING. ARTUR SINANI		
SPECIALIST	ING. ARBEN MUCA		
SPECIALIST	ING. MALDIN CELA		
SPECIALIST	ING. KLADIM MYZEQARI		



# DETAJ I ARMIMIT TRAREVE THEMELEVE

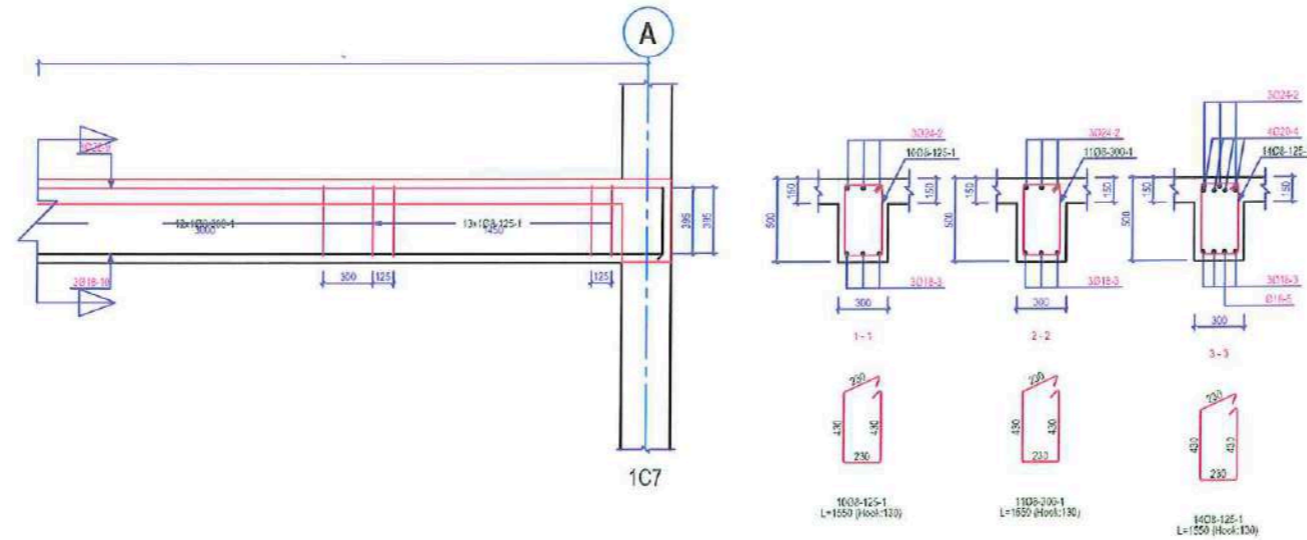

1B62 (300x500)  
1C16

Quantity Table					TOTAL LENGTH (m)						
NO	SIZE	QJA	LENGTH (mm)	FORM	Ø8	Ø14	Ø16	Ø18	Ø20	Ø22	Ø24
1	8	101	1650	1608-125-1	166.55						
2	21	3	6450	1608-125-1							19.35
3	18	3	8150	1703-200-1				24.45			
4	20	4	3000	1703-200-1					12.00		
5	18	1	2400	1408-125-1				2.40			
6	14	3	2450	1408-125-1		7.35					
7	18	2	2500	1408-125-1			5.00				
8	16	1	2200	1408-125-1			2.20				
9	22	3	7650	1408-125-1						23.85	
10	18	3	8650	1408-125-1				24.15			
TOTAL LENGTH (m)					166.55	7.35	7.20	51.00	12.00	23.85	18.25
UNIT WEIGHT (kg/m)					0.40	1.21	1.58	2.00	2.47	2.99	3.55
WEIGHT (kg)					51.8	8.9	11.4	102.0	29.6	71.3	68.8
T.WEIGHT (kg)					353.8						

Scale: 1/120

OBJEKTI	RINDERTIMI I SHKOLLES 9-VJECARE "HYSEN XHEKA"	NR.FLETES	A-05
VENDNDODHJA	KARBUNARE	FORMATI	420x297
EMERT.I FLETES	DETAJ I ARMIMIT TE TRAREVE TE THEMELEVE	SHKALLA	1:500
DIREKTOR	ING. MIMOZA HAXHILU		
PERGJEGJES			
SPECIALIST	ARK. OKSANA BAXHO		
SPECIALIST	ORJALD DEBINJA		
SPECIALIST	ING. ARTUR SINANI		
SPECIALIST	ING. ARBEN MUCA		
SPECIALIST	ING. MALDIN CELA		
SPECIALIST	ING. KLAJDI MYZEQARI		





# DETAJ I ARMIMIT TRAREVE THEMELEVE

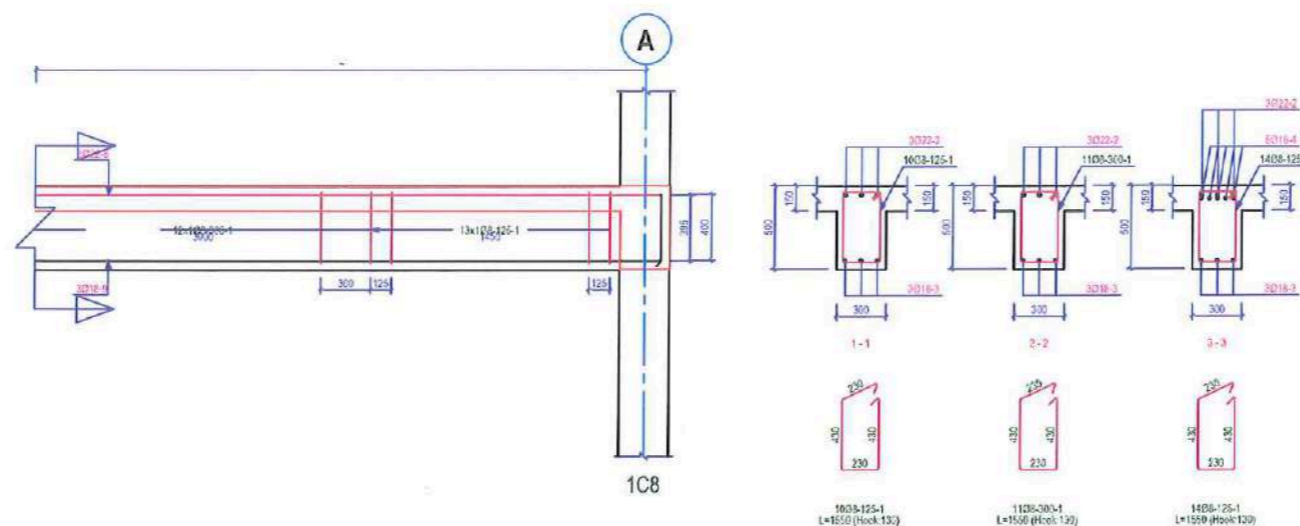

1B65 (300x500)

1C17

Quantity Table						TOTAL LENGTH (m)				
NO	SIZE	QUA	LENGTH (mm)	FORM						
					Ø8	Ø14	Ø16	Ø18	Ø22	
1	8	101	1650	1000x125	156,56					
2	22	3	6150	1100x300					18,45	
3	18	3	8150	1400x125					24,45	
4	18	5	3200	1100x300					16,00	
5	14	3	2450	1100x300		7,35				
6	16	2	2800	1100x300			6,00			
7	16	1	2200	1100x300			2,20			
8	22	3	7950	1400x125					23,85	
9	18	3	3050	1400x125					24,15	
TOTAL LENGTH (m)					156,56	7,35	7,20	64,60	42,30	
UNIT WEIGHT (Kg/m)					0,40	1,21	1,58	2,00	2,09	
WEIGHT (Kg)					61,8	5,9	11,4	129,2	125,4	
T.WEIGHT (Kg)					337,7					

Scale: 1/120

OBJEKTI	RINDERTIMI I SHKOLLES 9-VJECARE "HYSEN XHEKA"	NR.FLETES	A-05
VENDNDODHJA	KARBUNARE	FORMATI	420X297
EMERTI FLETES	DETAJ I ARMIMIT TE TRAREVE TE THEMELEVE	SHKALLA	1:500
DRETTOR	ING. MIMOZA HAXHIU		
PERGJEGJES			
SPECIALIST	ARK. OKSANA BASHO		
SPECIALIST	ORJALD DEBINA		
SPECIALIST	ING. ARTUR SINANI		
SPECIALIST	ING. ARBEN MUCA		
SPECIALIST	ING. MALDIN CELA		
SPECIALIST	ING. KLAIDI MYZEQARI		



# DETAJ I ARMIMIT TRAREVE THEMELEVE

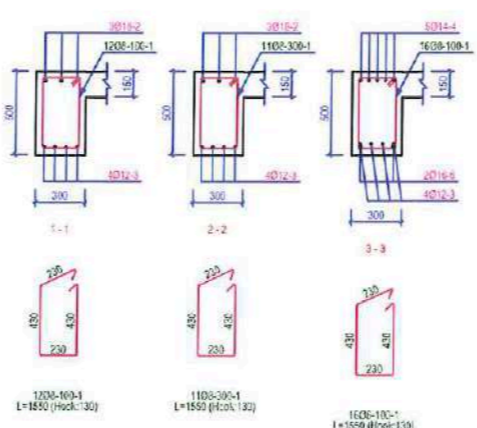
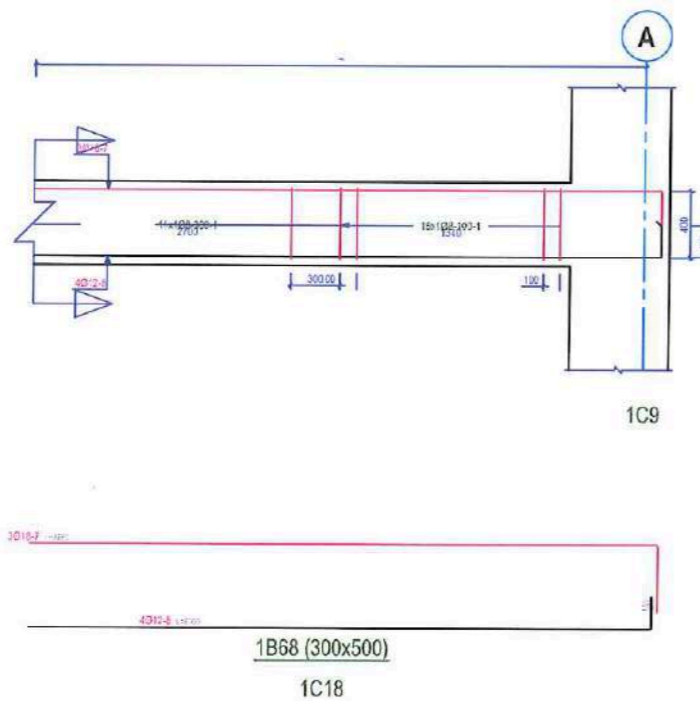
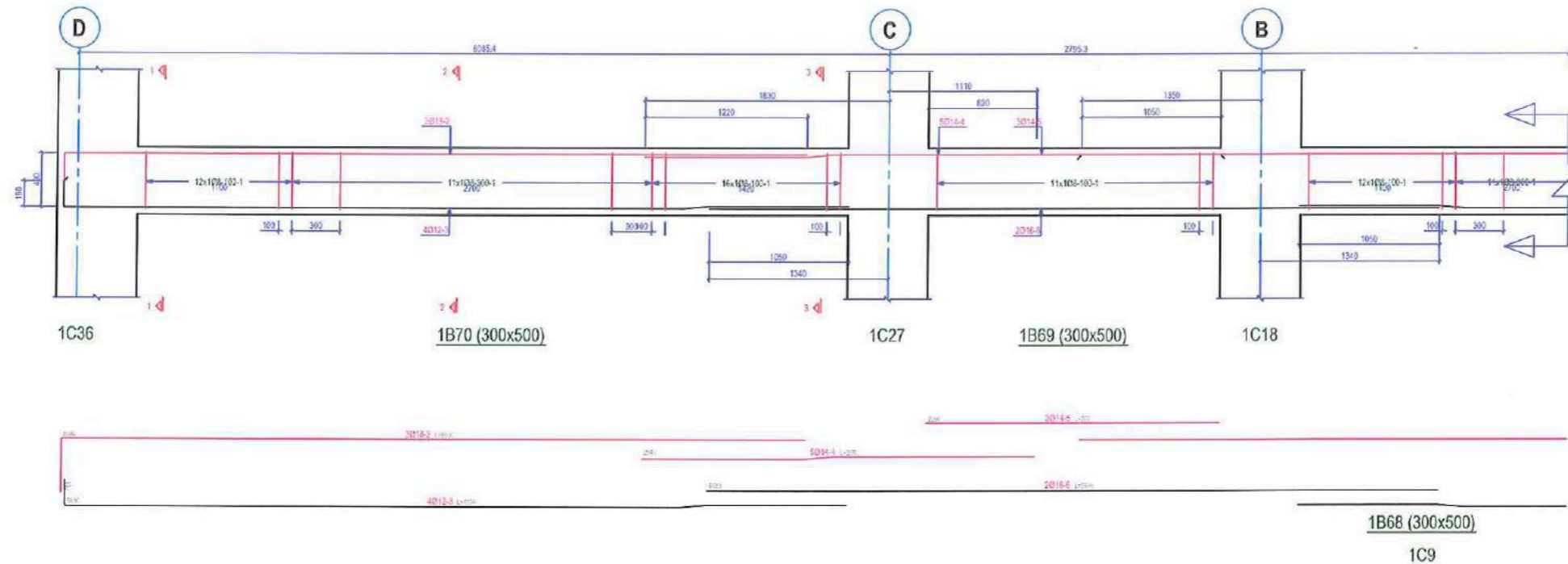

Quantity Table										
NO	SIZE	QVA	LENGTH (mm)	FORU	TOTAL LENGTH (m)					
					Ø8	Ø12	Ø14	Ø16	Ø18	
1	8	85	1550	136.40						
2	18	3	6000					18.00		
3	12	4	6100		24.40					
4	14	5	2950			14.75				
5	14	3	2200			6.60				
6	15	2	5500				11.00			
7	18	3	7850					23.55		
8	12	4	6000		24.00					
TOTAL LENGTH (m)					136.40	48.40	21.35	11.00	41.55	
UNIT WEIGHT (kg/m)					9.40	0.89	1.21	1.88	2.00	
WEIGHT (kg)					63.0	43.0	25.8	17.4	83.1	
T.WEIGHT (kg)					229.2					

OBJEKTI	RINDERTIMI I SHKOLLËS 9-VJEÇARE "HYSEN XHEKA"	NR.FLETES	A-05
VENDNDODHJA	KARBUNARE	FORMATI	420X297
EMERT.I FLETES	DETAJ I ARMIMIT TE TRAREVE TE THEMELEVE	SHKALLA	1:500
DREJTOR	ING. MIMOZA HAXHIU		
PERGJEGJES			
SPECIALIST	ARK. OKSANA BAXHO		
SPECIALIST	ORJALD DEBINJA		
SPECIALIST	ING. ARTUR SINANI		
SPECIALIST	ING. ARBEN MUCA		
SPECIALIST	ING. MALDIN CELA		
SPECIALIST	ING. KLAJDI MYZEQARI		



**MIRATOI  
KRYETARI I BASHKISË  
ERISELDA SEFA**



**PROJEKT ZBATIMI  
I ENERGJISË ELEKTRIKE**

**DREJTORIA E PLANIFIKIMIT  
MIMOZA HAXHIU**

A handwritten signature in blue ink, appearing to read "Mimoza Haxhiu", is written below the printed name.

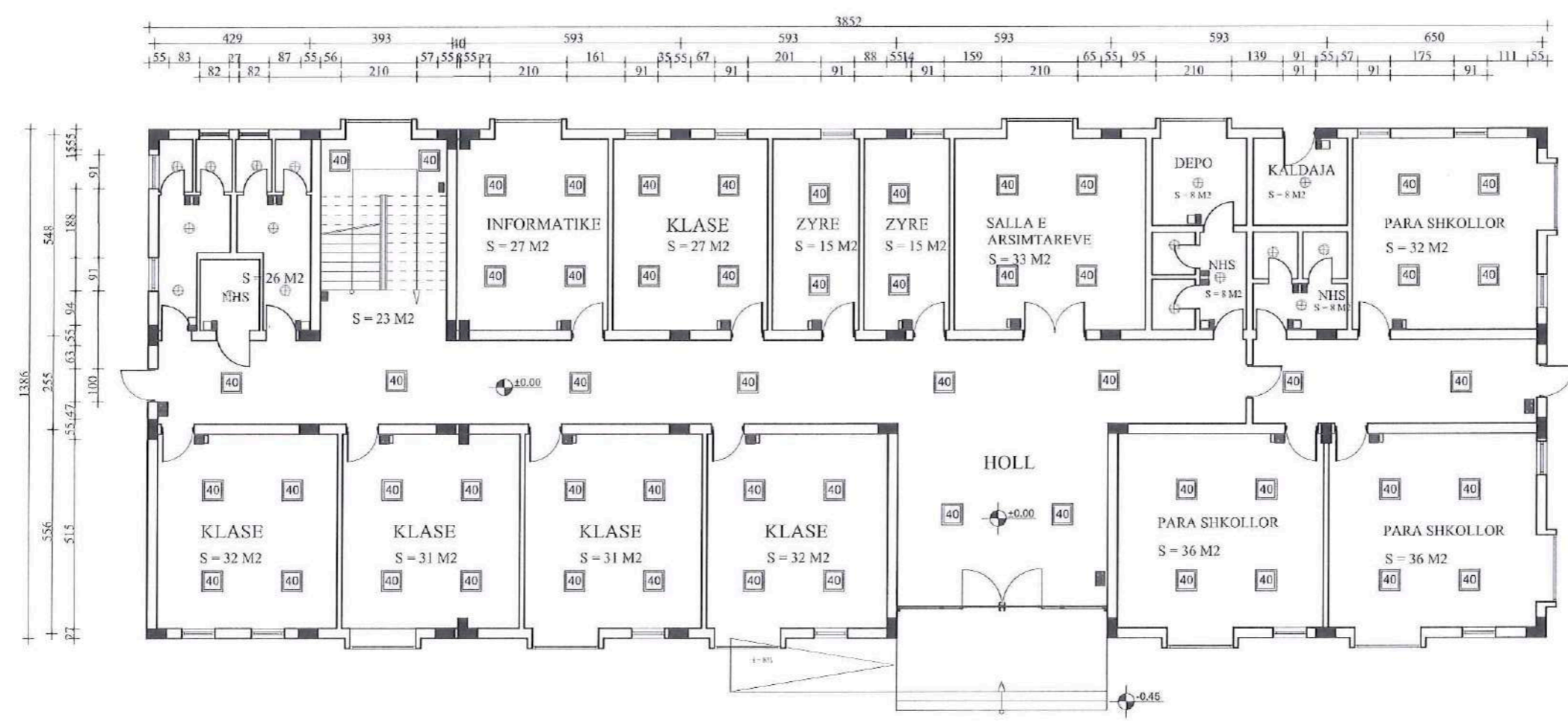
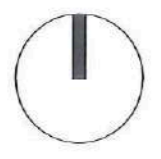

- ⊕ Ndricues Tip Spot LED
- Ndricues Tip Spot LED 1
- Çetes 1P I=10A,U=250V,h=1.1m
- Çetes doviat 1P I=10A,U=250V,h=1.1m
- Çetes inverltor 2P,I=10A,U=250V,h=1.1m
- Pulsant
- Ndricues emergjence
- Kuti 3M
- Kuti shperndarese
- Panel LED 60x60

OBJEKTI	RINDERTIMI I SHKOLLES 9-VJECARE "HYSEN XHEKA"	NR.FLETES	A-01
VENDNDODHJA	KARBUNARE	FORMATI	420X297
EMERT.I FLETES	PLANI EKETRIK I KATIT PERDHE	SHKALLA	
DREJTOR	ING. MIMOZA HAXHIU		
PERQEGJES	ARK. SAIMIR MEBELLI		
SPECIALIST	ARK. OKSANA BAXHO		
SPECIALIST	ORJALD DEBINJA		
SPECIALIST	ING. ARTUR SINANI		
SPECIALIST	ING. ARBEN MUCA		
SPECIALIST	ING. GARNI MYZEQARI		
SPECIALIST	ING. KLADJI MYZEQARI		



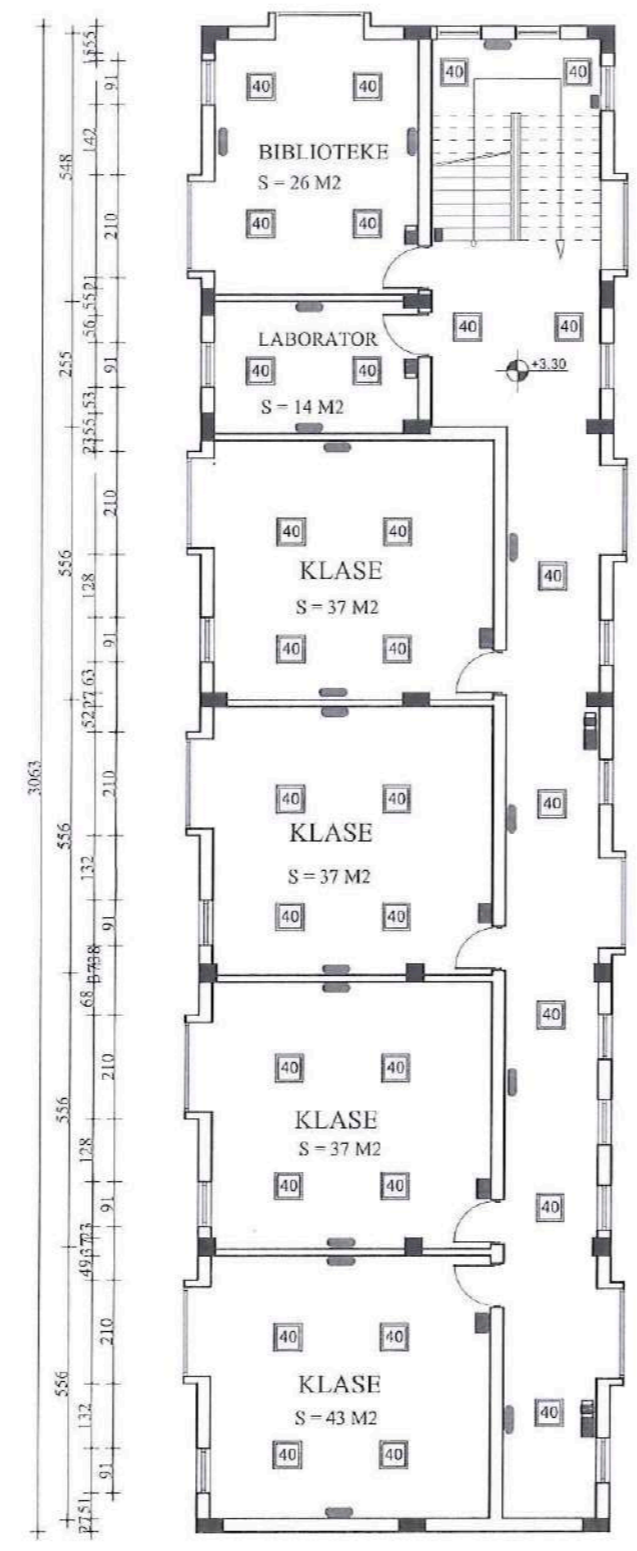
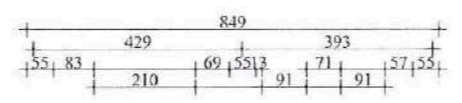
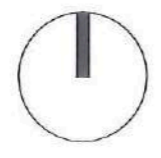

- ⊕ Ndricues Tip Spot LED
- Ndricues Tip Spot LED 1
- Çeles 1P I=10A,U=250V,h=1.1m
- Çeles deviat 1P I=10A,U=250V,h=1.1m
- Çeles invertitor 2P,I=10A,U=250V,h=1.1m
- Pulsant
- Ndricues emergjence
- Kuti 3M
- Kuti shperndarese
- 40 Panel LED 60x60

OBJEKTI	RINDERTIMI I SHKOLLES 9-VJECARE "HYSEN XHEKA"	NR.FLETES	A-01
VENDNDODHJA	KARBUNARE	FORMATI	420X297
EMERT.I FLETES	PLANI EKETRËK I KATIT TE PARE	SHKALLA	
DREJTOR	ING. MIMOZA HAXHILU		
PERGJEGJES	ARK. SAIMIR MEBELLI		
SPECIALIST	ARK. OKSANA BAXHO		
SPECIALIST	ORJALD DEBINJA		
SPECIALIST	ING. ARTUR SINANI		
SPECIALIST	ING. ARBEN MUÇA		
SPECIALIST	ING. GARNI MYZEQARI		
SPECIALIST	ING. KLAJDI MYZEQARI		

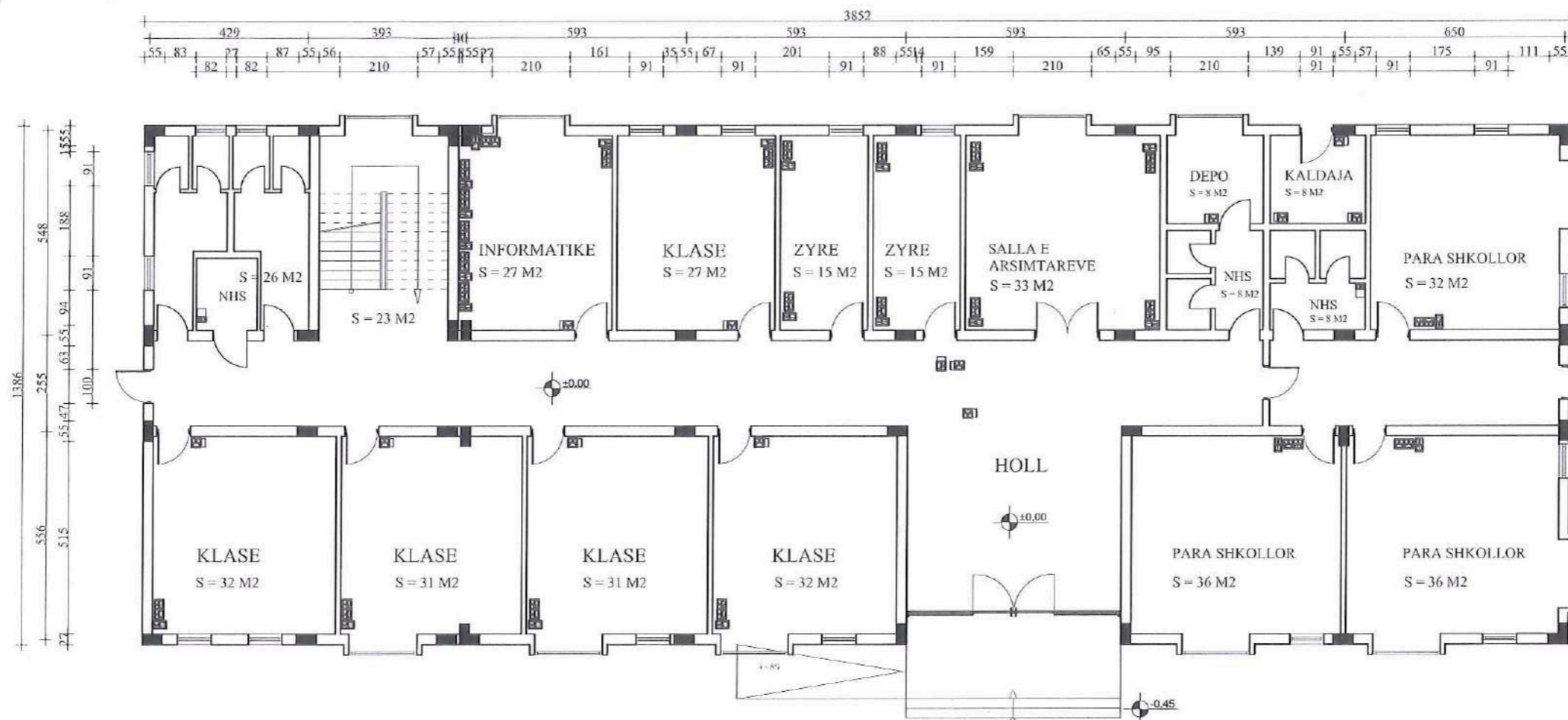
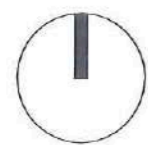

- Prize interneti
- Prize shuko universale 2p+1, I=16A, U=250V, I=1, 1m
- Prize bivalente 2p+1, I=16A, U=250V, I=1, 1m
- Kuti 3M
- Kuti 4M
- Kuti shpendarese
- ▬ Panel Elektrik

OBJEKTI	RINDERTIMI I SH-KOLLES 9-VJECARE "HYSEN XHEKA"	NR.FLETES	A-01
VENDNDODHJA	KARBUNARE	FORMATI	420X297
EMERTI J. FLETES	PLANI EKETRIK I KATIT PERDIHE	SHKALLA	
DIREKTOR	ING. MIMOZA HAXHIU		
PERQJEGJES	ARK. SAJMIR MEBELLI		
SPECIALIST	ARK. OKSANA BAXHO		
SPECIALIST	ORJALD DEBINJA		
SPECIALIST	ING. ARTUR SINANI		
SPECIALIST	ING. ARBEN MUCA		
SPECIALIST	ING. GARNI MYZEQARI		
SPECIALIST	ING. KLAJDI MYZEQARI		



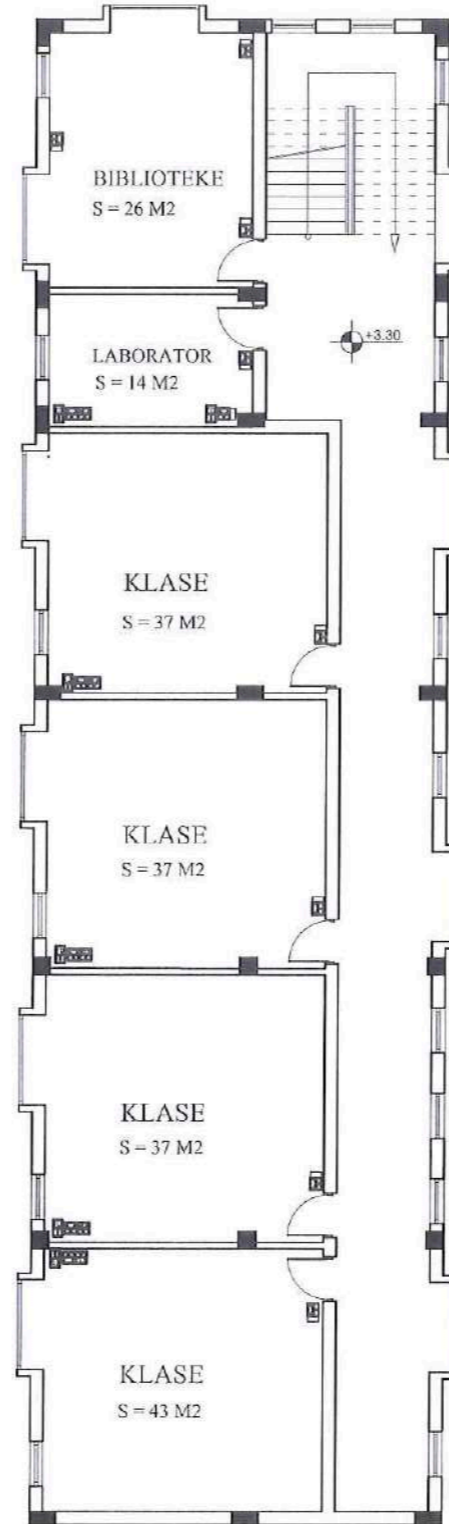
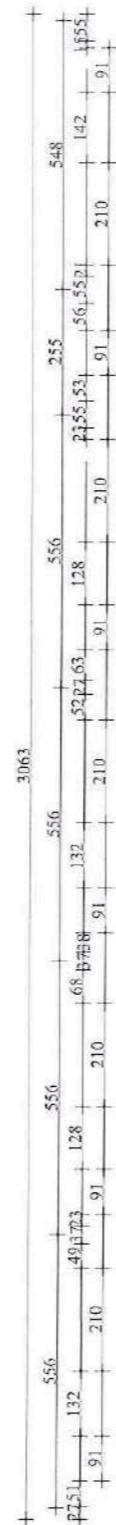
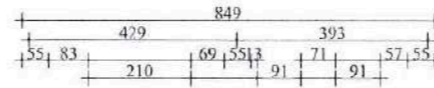
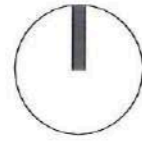

- Prizo interneti
- Prizo shuko universal 2p+1, I=16A, U=250V, h=1.1m
- Prizo bivalente 2p+1, I=16A, U=250V, h=1.1m
- Kuti 3M
- Kuti 4M
- Kuti shpërndarëse
- Panel Elektrik

OBJEKTI	RINDERTIMI I SHKOLLES 9-VJECARE "HYSEN XHEKA"	NR. FLETES	A-01
VENDNDODHJA	KARBUNARE	FORMATI	420X297
EMERT.I FLETES	PLANI EKETRIK I KATIT TE PARE	SHKALLA	
DREJTOR	ING. MIPOZA HAXHIU		
PERGJEGJES	ARK. SAJMIR MEBELLI		
SPECIALIST	ARK. OKSANA BAXHO		
SPECIALIST	ORJALD DEBINJA		
SPECIALIST	ING. ARTUR SINANI		
SPECIALIST	ING. ARBEN MUCA		
SPECIALIST	ING. GARNI MYZEQARI		
SPECIALIST	ING. KLAUDI MYZEQARI		



## SKEMA ELEKTRIKE E KUADRIT

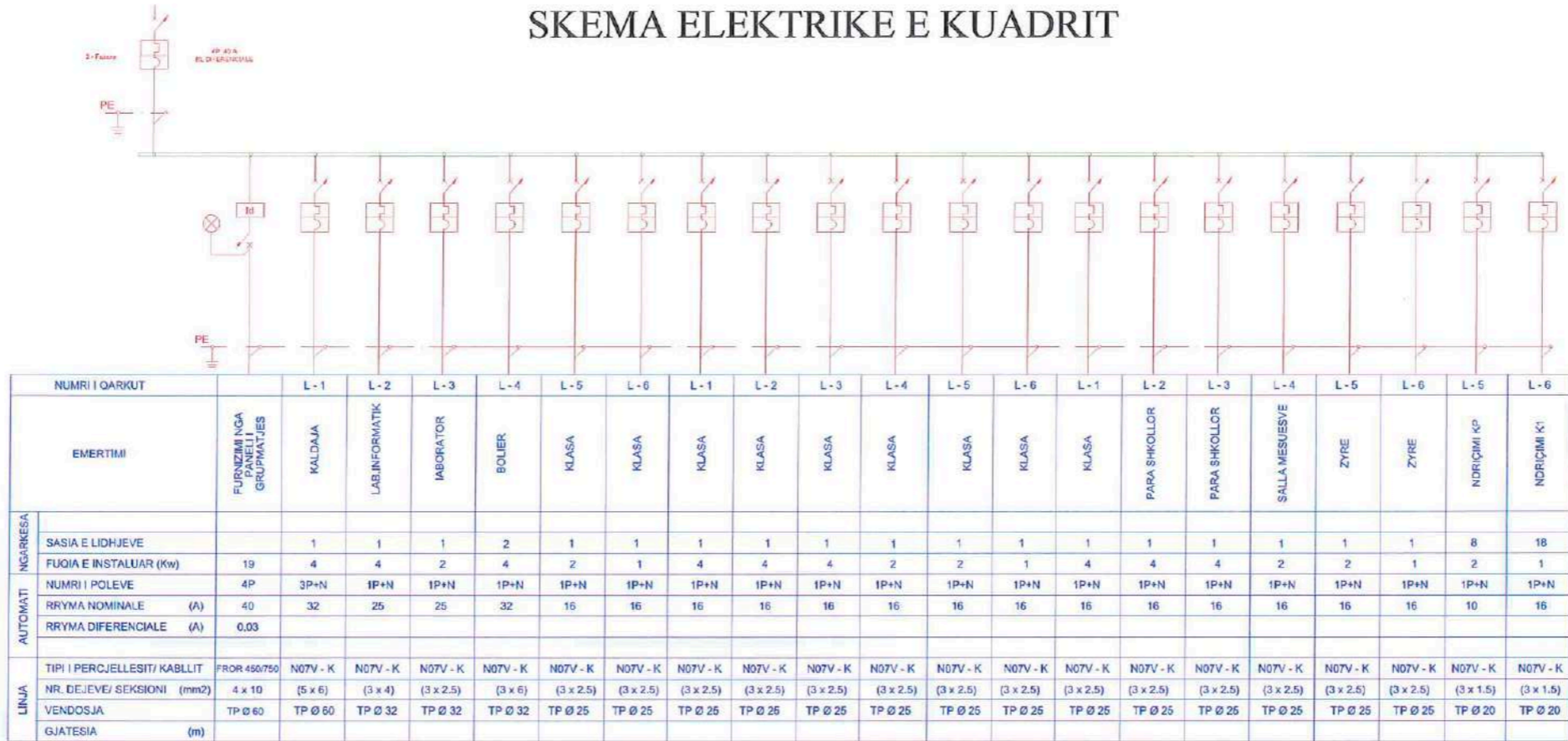

## TOKEZIMI MBROJTES I PAISJEVE ELEKTRIKE

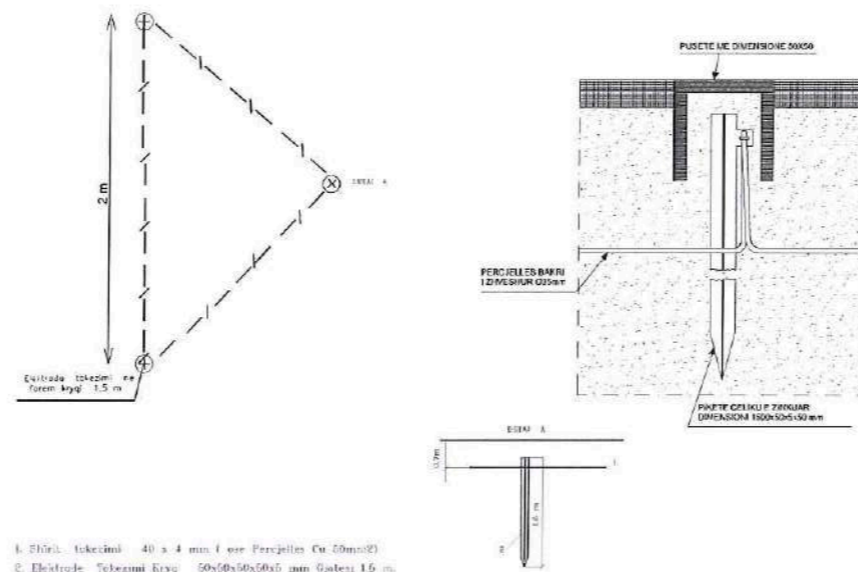

1. Tipi i tokesimit: 40 x 4 mm i qerë Perçjellës Cu 50mmØ  
 2. Elektrode: Tokesimi kështu: 50x50x50mm diam Gjatesi 1.5 m.

REZISTENCA E TOKEZIMIT DUHET TE JETE  $R_t \leq 4\Omega$

OBJEKTI	RINDERTIMI I SHKOLLËS 9-VJECARE "HYSEN XHEKA"	NR.FLETES	A-01
VENDNDODHJA	KARBUNARE	FORMATI	420X297
EMERT. I FLETES	DETAJE ELEKTRIKE	SHKALLA	
DREJTOR	ING. MIMOZA HAXHBU		
PERGJEGJES	ARK. SAIMIR MEBELLI		
SPECIALIST	ARK. OKSANA BAXHO		
SPECIALIST	ORJALD DEBINJA		
SPECIALIST	ING. ARTUR SINANI		
SPECIALIST	ING. ARBEN MUCA		
SPECIALIST	ING. MALDIN CELA		
SPECIALIST	ING. KLAUDI MYZEQARI		





**MIRATOI  
KRYETARI I BASHKISË  
ERISELDA SEFA**



**PROJEKT ZBATIMI  
I FURNIZIMIT ME UJË**

**DREJTORIA E PLANIFIKIMIT  
MIMOZA HAXHIU**

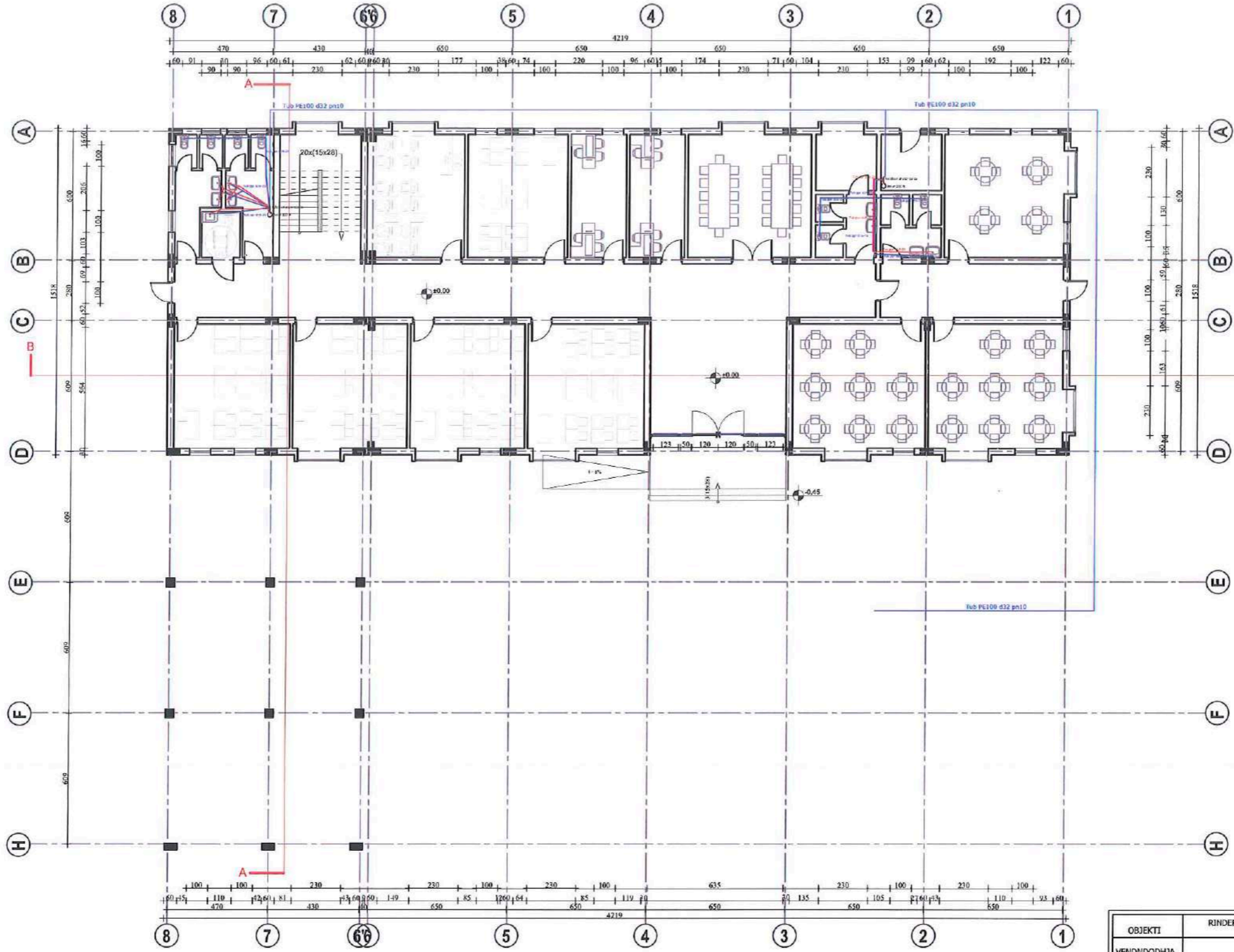
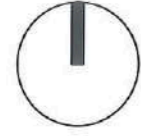

OBJEKTI	RINDERTIMI I SHKOLLES 9-VJECARE "HYSEN XHEKA"	NR.FLETES	A-18
VENDNDODHJA	KARBUNARE	FORMATI	420X297
EMERT.I FLETES	PLANIMETRIA E FURNIZIMIT ME UJE	SHKALLA	1:200
DREJTOR	ING. MIMOZA HAXHIU	 REPUBLIKA E SHQIPERISE BASHKIA LUSHNJE	
PERQJEGJES	ARK. SAIMIR MEBELLI		
SPECIALIST	ARK. OKSANA BASHO		
SPECIALIST	ORJALD DEBINDA		
SPECIALIST	ING. ARTUR SIMANI		
SPECIALIST	ING. ARBEN MUCA		
SPECIALIST	ING. MALDIN CELA		
SPECIALIST	ING. KLAJDI MYZEQARI		



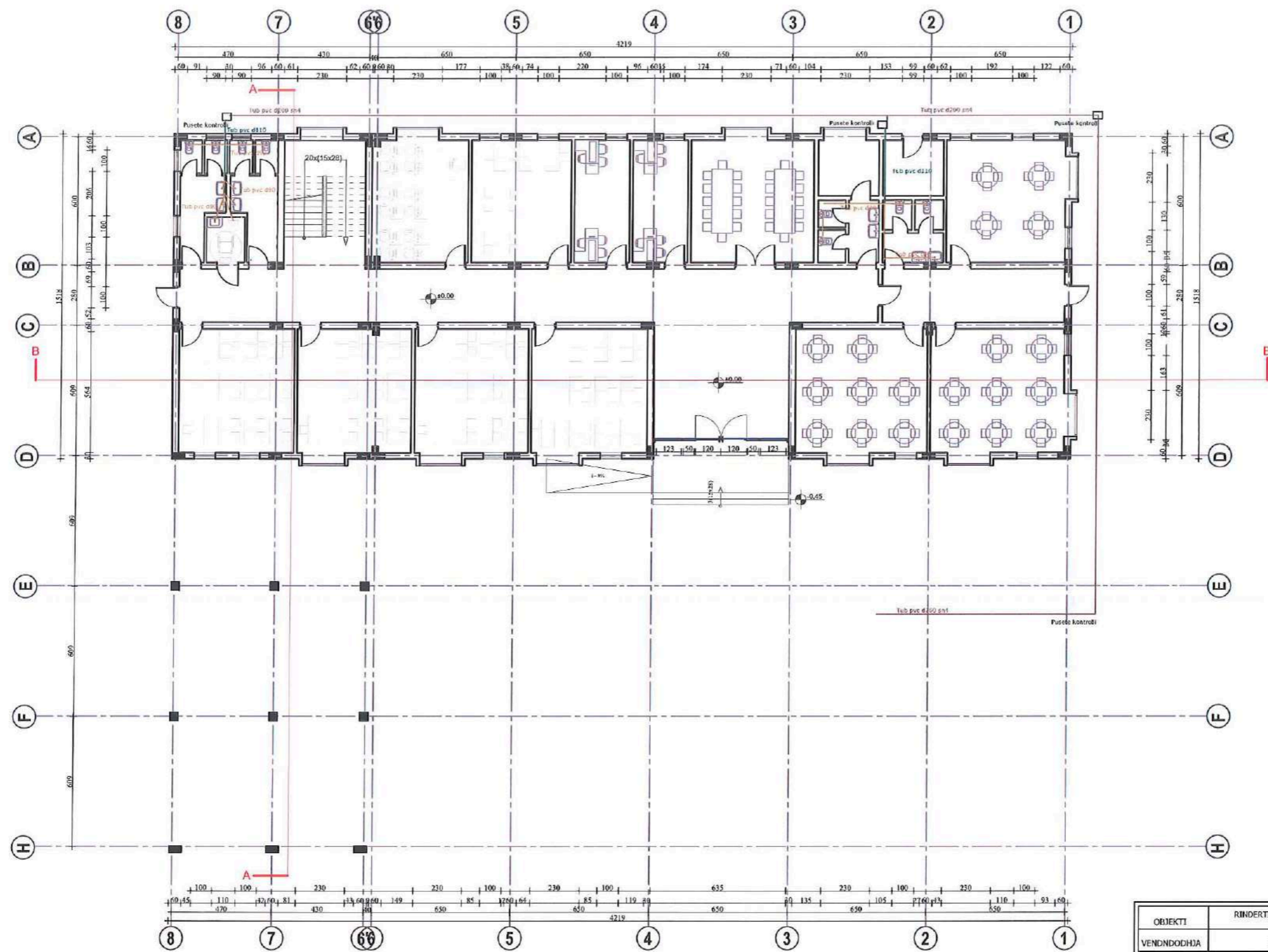
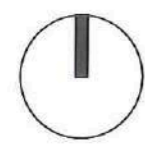

OBJEKTI	RINDERTIMI I SHKOLLES 9-VJECARE "HYSEN XHEKA"	NR.FLETES	A-19
VENDNDODHJA	KARBUNARE	FORMATI	A20X297
EMERT.I FLETES	PLANI I KATIT PERDHE - K.U.Z	SHKALLA	1:200
DREJTOR	ING. MIMOZA HAXHTU		
PERGJEGJES	ARK. SAIMIR MEBELI		
SPECIALIST	ARK. OXSANA BAXHO		
SPECIALIST	ORJALD DEBINJA		
SPECIALIST	ING. ARTUR SINANI		
SPECIALIST	ING. ARBEN MUCA		
SPECIALIST	ING. MALDIN CELA		
SPECIALIST	ING. KLAJDI MYZEQARI		

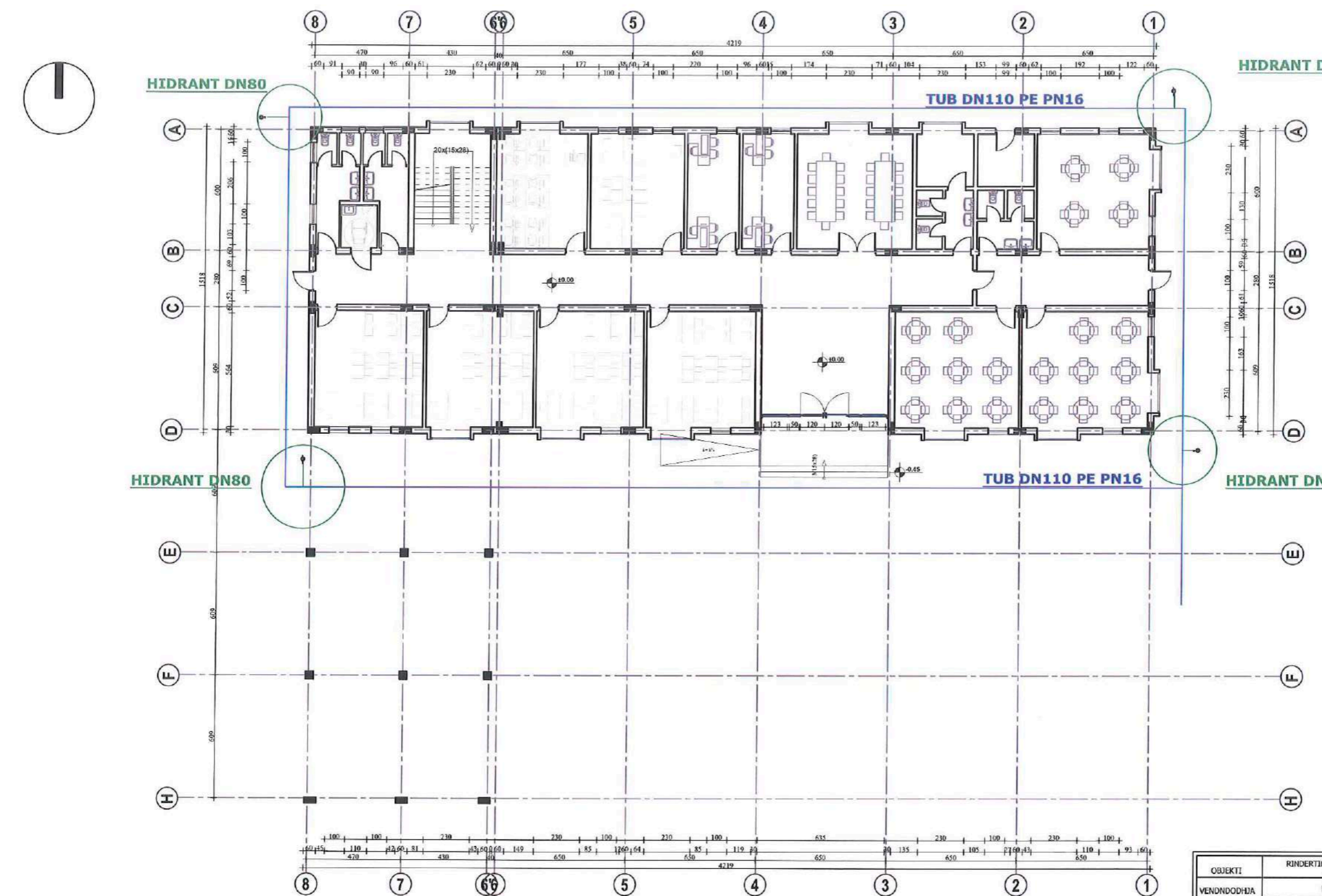

OBJEKTI	RINDERTIMI I SHKOLLES 9-VJECARE "HYSEN XHEKA"	NR.FLETES	A-20
VENDNDODHJA	KARBUNARE	FORMATI	420x297
EMERT.I FLETES	PLANIMETRIA E VENDOSJES SE HIDRANTEVE	SHKALLA	1:200
DREJTOR	ING. MIMOZA HAXHILU	 REPUBLIKA E SHQIPERISE BASHKIA LUSHNJE	
PERGJEGJES	ARK. SAIMIR MEDELLI		
SPECIALIST	ARK. OKSANA BASHO		
SPECIALIST	ORJALD DEBINJA		
SPECIALIST	ING. ARTUR SINANI		
SPECIALIST	ING. ARBEN MUCA		
SPECIALIST	ING. MALDIN CELA		
SPECIALIST	ING. KLAJDI MYZEQARI		



**MIRATOI  
KRYETARI I BASHKISË  
ERISELDA SEFA**



**PROJEKT ZBATIMI  
I MBROJTJES NGA ZJARRI**

**DREJTORIA E PLANIFIKIMIT  
MIMOZA HAXHIU**

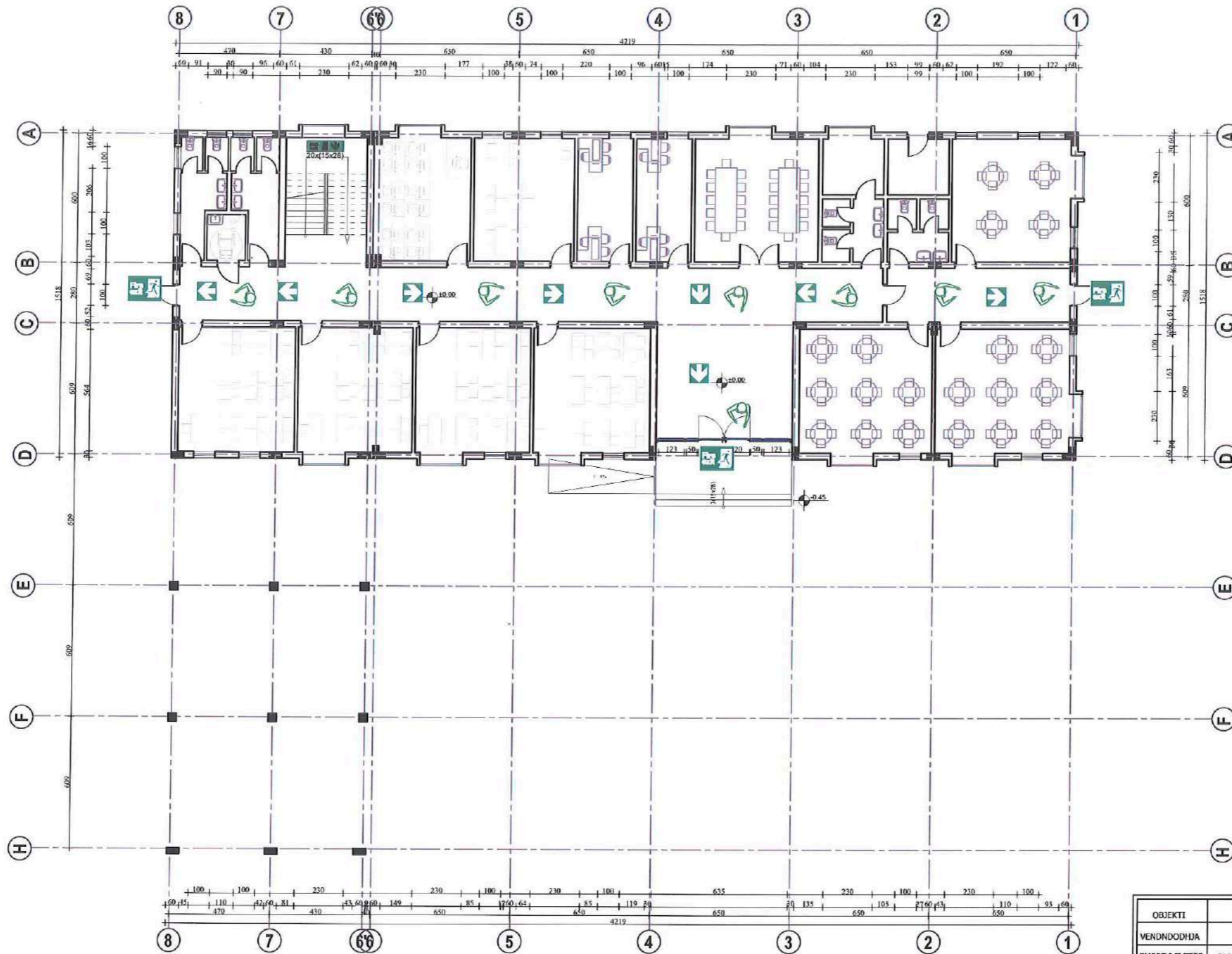
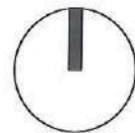

OBJEKTI	RINDERTIMI I SHKOLLËS 9-VJEÇARE "HYSEN XHEKA"	NR.FLETES	A-22
VENDNDODHJA	KARBUNARE	FORMATI	420X297
EMERT.I FLETES	PLANI I EVAKUIMIT TE KATIT PERDHE	SHKALLA	1:200
DREJTOR	ING. MIMOZA HAXHITU	 REPUBLIKA E SHQIPËRIE BASHKIA E LUSHNJË	
PERGJEGJES	ARK. SAIMIR MEBELLI		
SPECIALIST	ARK. OKSANA BASHO		
SPECIALIST	ORJALD DEBINJA		
SPECIALIST	ING. ARTUR SINANI		
SPECIALIST	ING. ARBEN MUCA		
SPECIALIST	ING. MALDIN CELA		
SPECIALIST	ING. KLAJDI MYZEQARI		



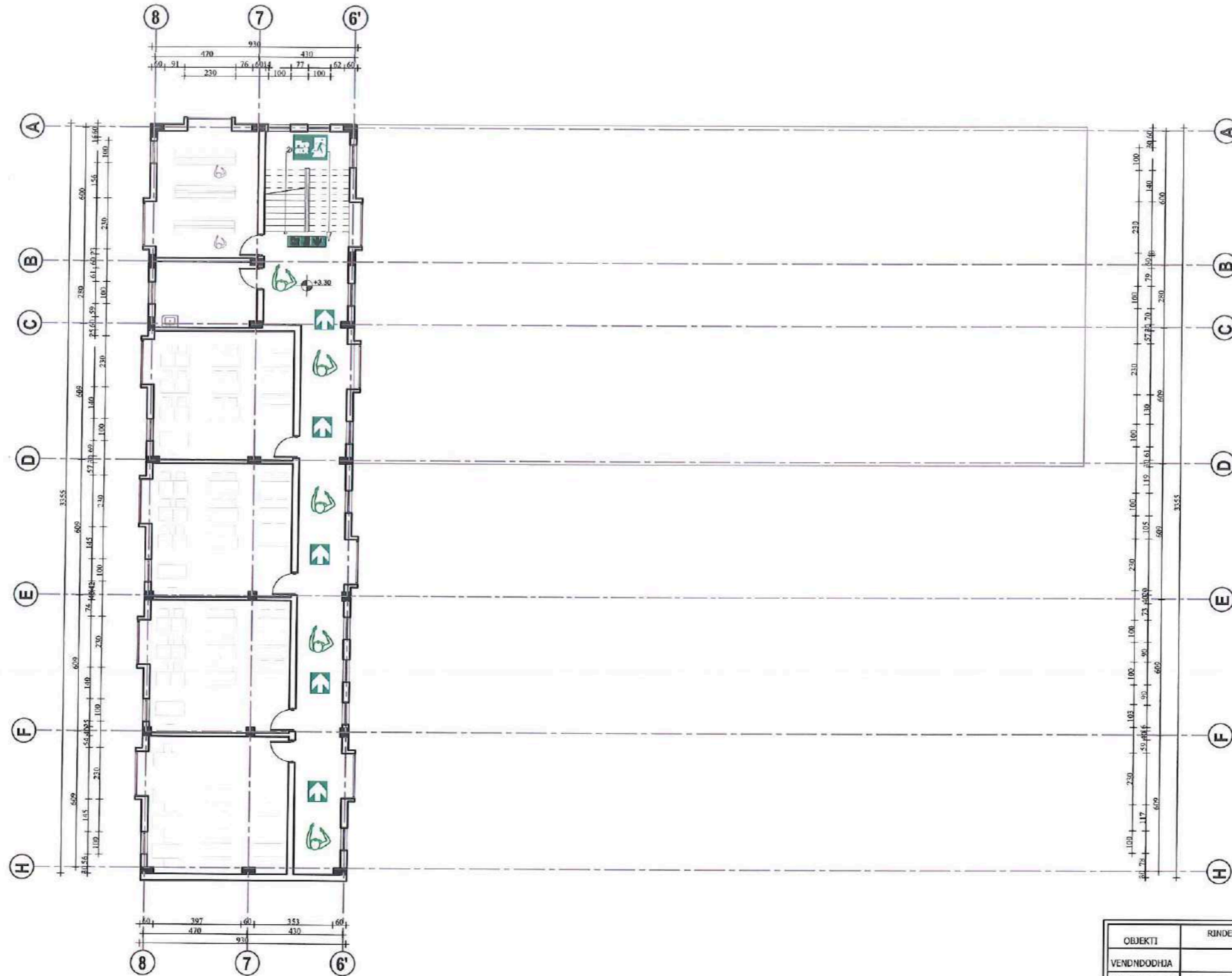
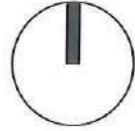

OBJEKTI	RINDERTIMI I SHKOLLËS 9-VJEÇARE "HUSEN XHEKA"	NR.FLETES	A-21
VENDNDODHJA	KARBUNARE	FORMATI	420X297
EMERT.I FLETES	PLANI I EVAKUIMIT TE KATIT TE PARE	SHKALLA	1:200
DREJTOR	ING. MIMOZA HAXHIU		
PERGJEGJES	ARK. SAIMIR MEBELLI		
SPECIALIST	ARK. OXSANA BAXHO		
SPECIALIST	ORJALD DEBINJA		
SPECIALIST	ING. ARTUR SINANI		
SPECIALIST	ING. ARBEN MUCA		
SPECIALIST	ING. MALDIN CELA		
SPECIALIST	ING. KLAIDI MYZEQARI		

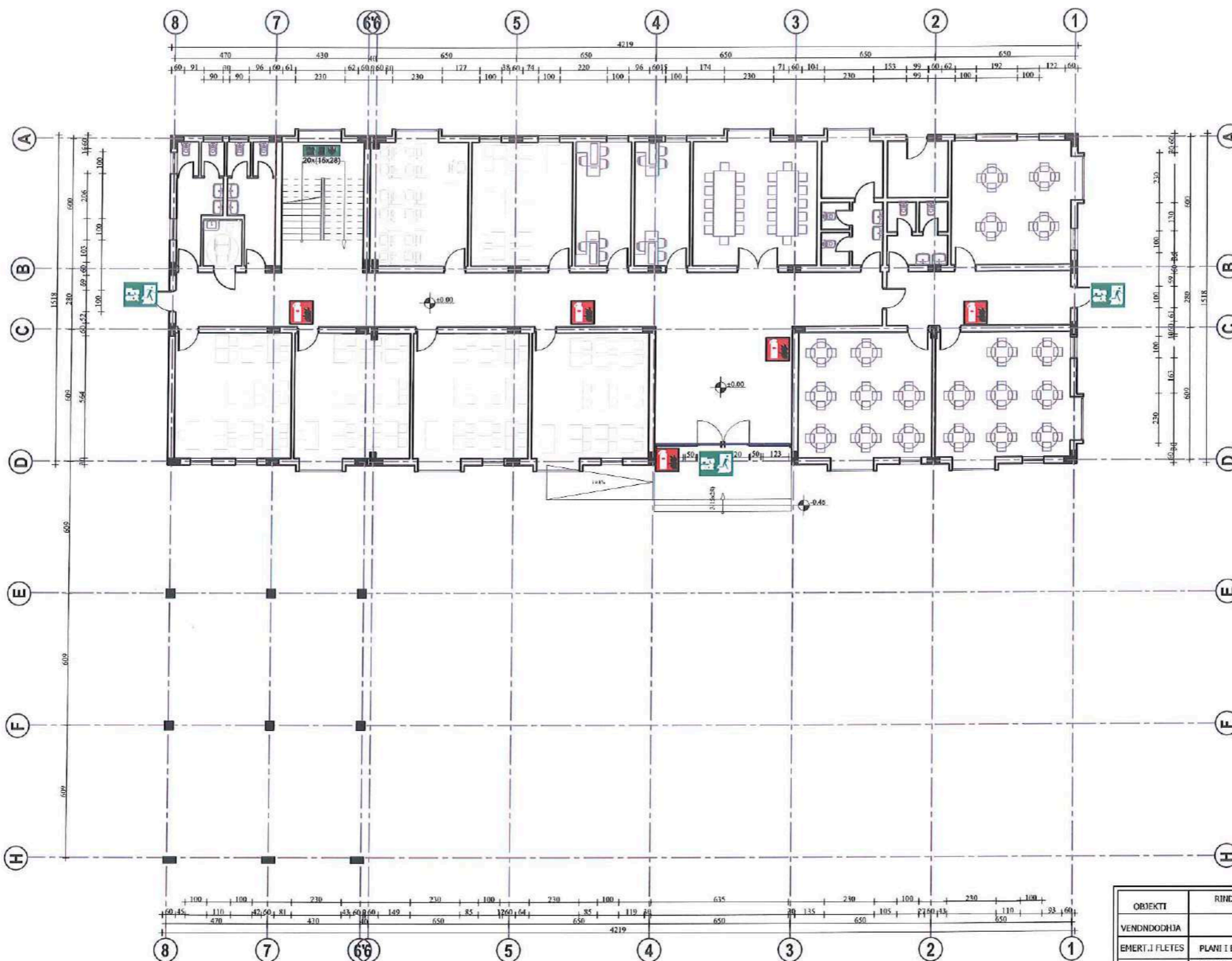
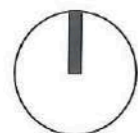

OBJEKTI	RINDERTIMI I SHKOLLËS 9-VJECARE "HYSEN XHEKA"	NR. FLETES	A-23
VENDNDODHJA	KARBUNARE	FORMATI	420x297
EMERT. I FLETES	PLANI I BOMBULAVE CO2 TE KATIT PERDHE	SHKALLA	1:200
DREJTOR	ING. MIMOZA HAXHIU		
PERGJEGJES	ARK. SAIMIR MEBELLI		
SPECIALIST	ARK. OKSANA BAXHO		
SPECIALIST	ORJALD DEBINJA		
SPECIALIST	ING. ARTUR SINANI		
SPECIALIST	ING. ARBEN MUCA		
SPECIALIST	ING. MALDIN CELA		
SPECIALIST	ING. KLAJDI MYZEQARI		



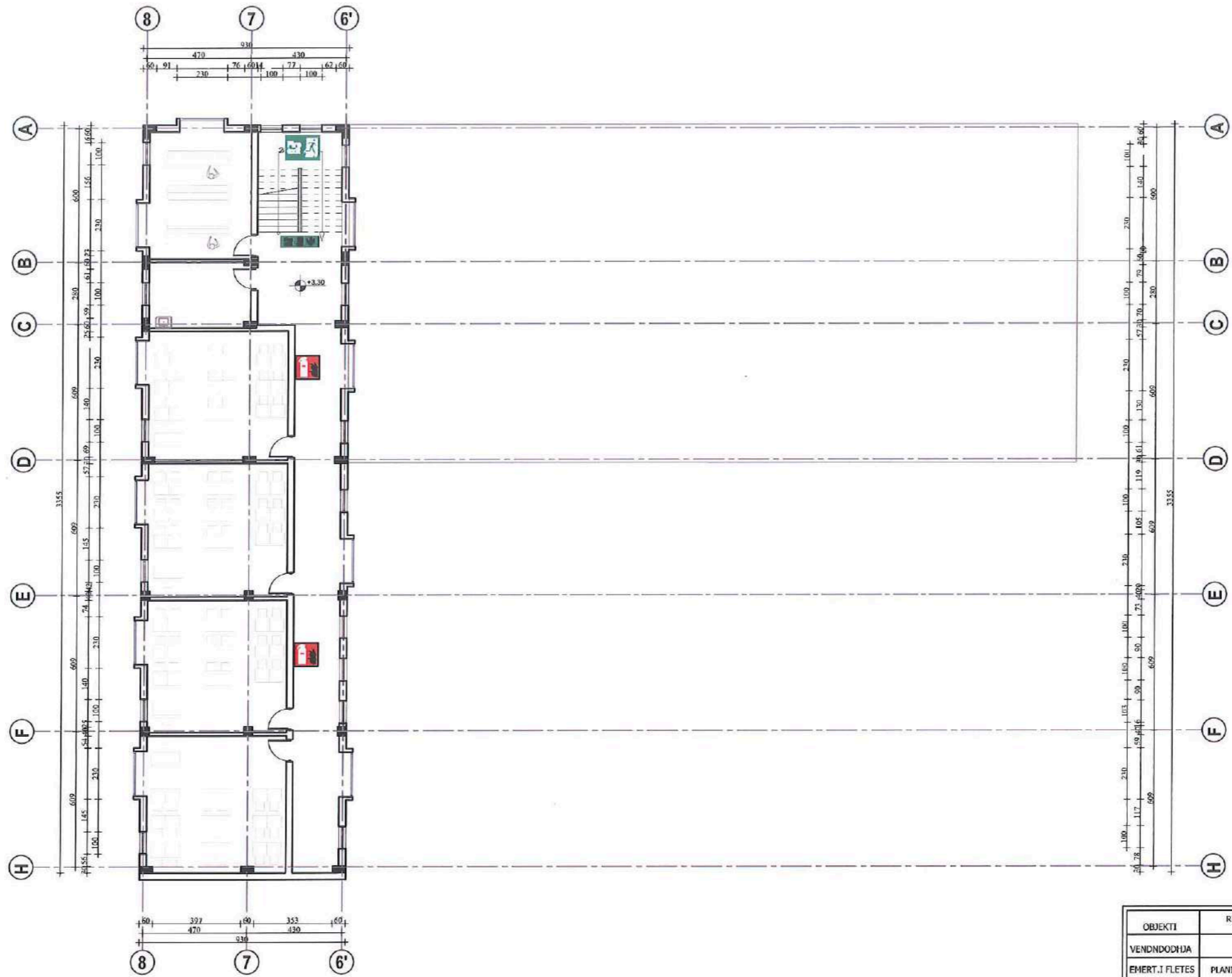
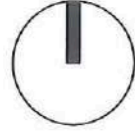

OBJEKTI	RINDERTIMI I SHKOLLËS 9-VJECARE "HYSEN XHEKA"	NR.FLETES	A-24
VENDNDODHJA	KARBUNARE	FORMATI	420X297
EMERT.I FLETES	PLANI I BOMBULAVE CO2 TE KATIT TE PARE	SHKALLA	1:200
DREJTOR	ING. NIMOZA HAXHIU		
PERGJEGJES	ARK. SAIMIR MEBELLI		
SPECIALIST	ARK. OKSANA BAXHO		
SPECIALIST	ORJALD DEBINJA		
SPECIALIST	ING. ARTUR SINANI		
SPECIALIST	ING. ARDEN MUCA		
SPECIALIST	ING. MALDIN CELA		
SPECIALIST	ING. KLAJDI MYZEQARI		



# INSTALIMI TIP PER BOMBUL FIKSE ZJARRI CO2

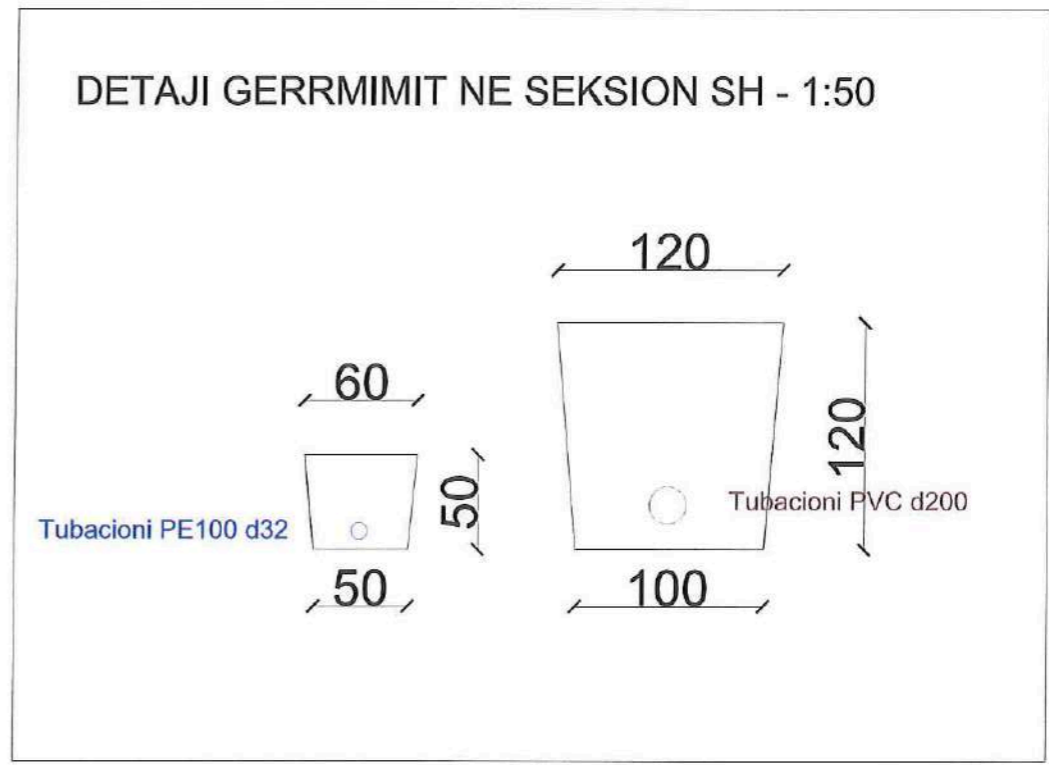
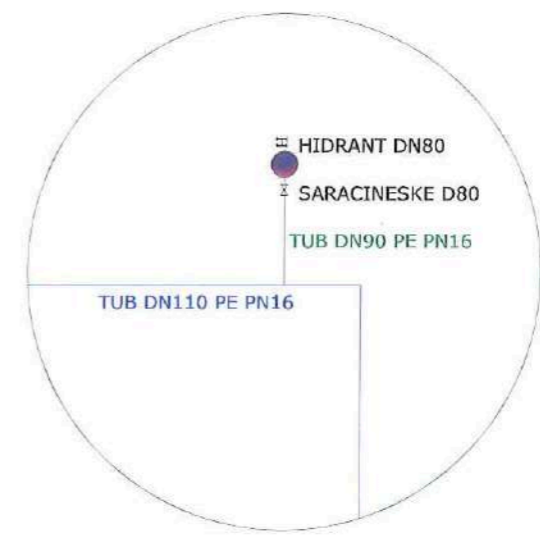
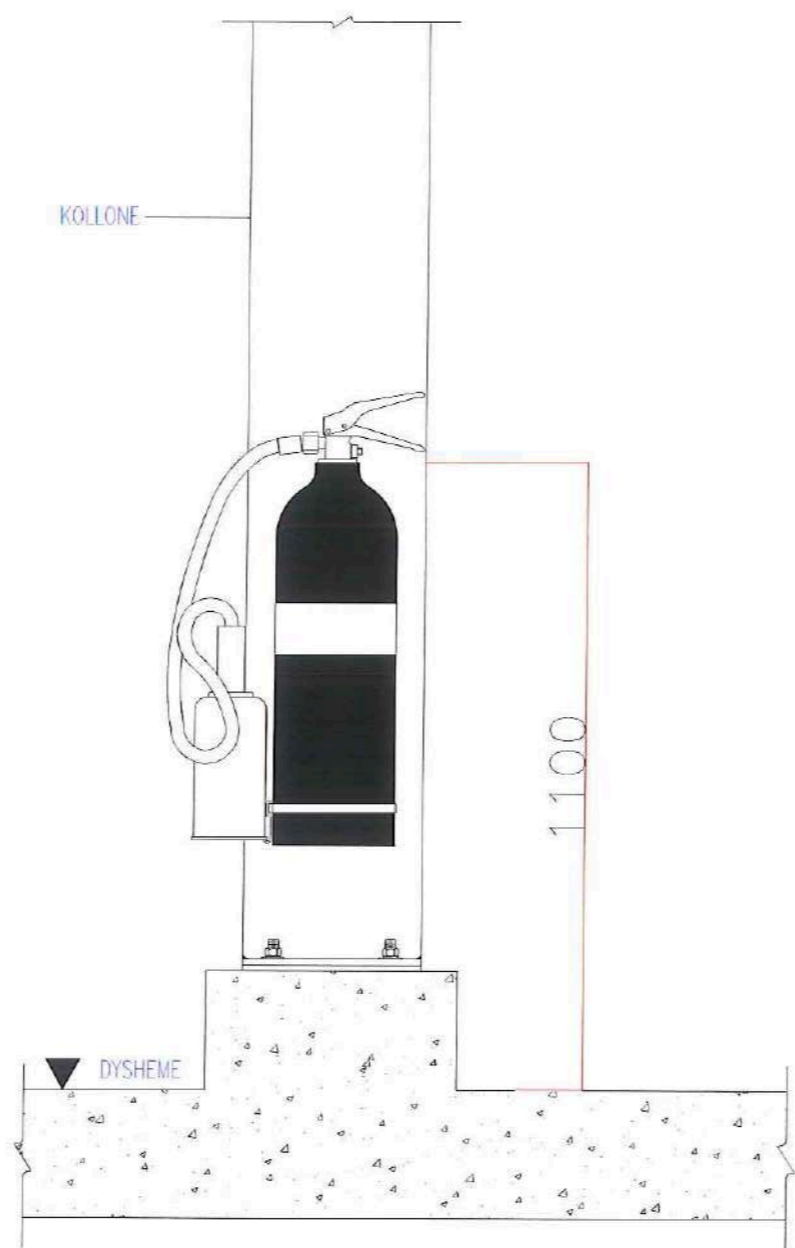
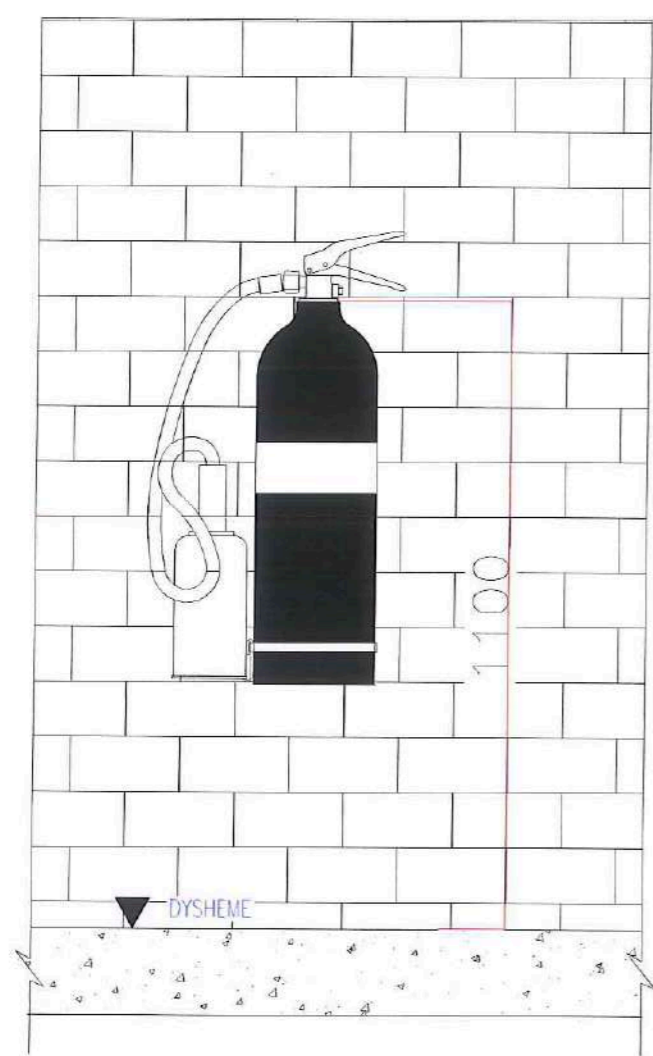

OBJEKTI	RINDERTIMI I SHKOLLES 9-VJECARE "HYSEN XHEKA"	NR.FLETES	A-26
VENDNDODHJA	KARBUNARE	FORMATI	420x297
EMERT.I FLETES	DETAJE	SHKALLA	1:
DREJTOR	ING. MIHOZA HAXHIU		
PERJEGJES	ARK. SAIMIR MEBELLI		
SPECIALIST	ARK. OKSANA BAXHO		
SPECIALIST	ORJALD DEBINJA		
SPECIALIST	ING. ARTUR SINANI		
SPECIALIST	ING. ARBEN MUCA		
SPECIALIST	ING. MALDIN CELA	REPUBLIKA E SHQIPERISE	
SPECIALIST	ING. KLAUD MYZEQARI	BASHKIA LUSHNJE	



**MIRATOI  
KRYETARI I BASHKISË  
ERISELDA SEFA**



**PROJEKT ZBATIMI  
I NGROHJE - FTOHJES**

**DREJTORIA E PLANIFIKIMIT  
MIMOZA HAXHIU**

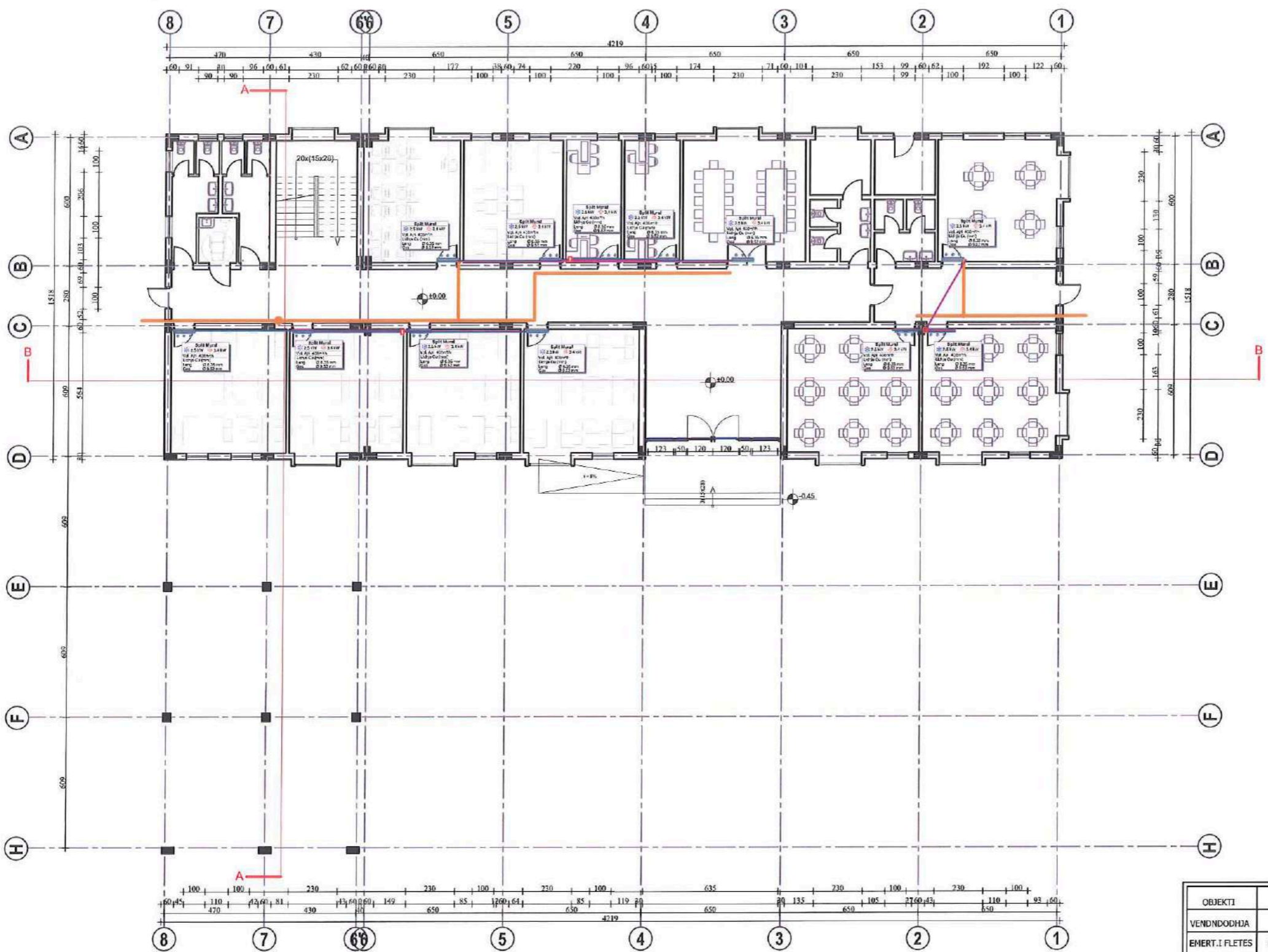
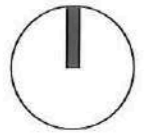

- Shkarkimi i ujrave te njesive te brendshme
- Linja e ftohjes
- Linja e ngrohjes

OBJEKTI	RINDERTIMI I SHKOLLES 9-VJEÇARE "HYSEN XHEKA"	NR.FLETES	A-01
VENDNDODHJA	KARBUNARE	FORMATI	420X297
EMERT.I FLETES	PLANI I NJESISE SE BRENDSHME, KATI PERDHE	SHKALLA	
DREJTOR	ING. MIMOZA HAXHITU	 REPUBLIKA E SHQIPERISE BASHKIA LUSHNJË	
PERGJEGJES	ARK. SAIMIR MEBELIT		
SPECIALIST	ARK. OKSANA BAXHO		
SPECIALIST	ORJALD DEBINIA		
SPECIALIST	ING. ARTUR SINANI		
SPECIALIST	ING. ARBEN MUCA		
SPECIALIST	ING. MALDIN CELA		
SPECIALIST	ING. KLAJDI MYZEQARI		



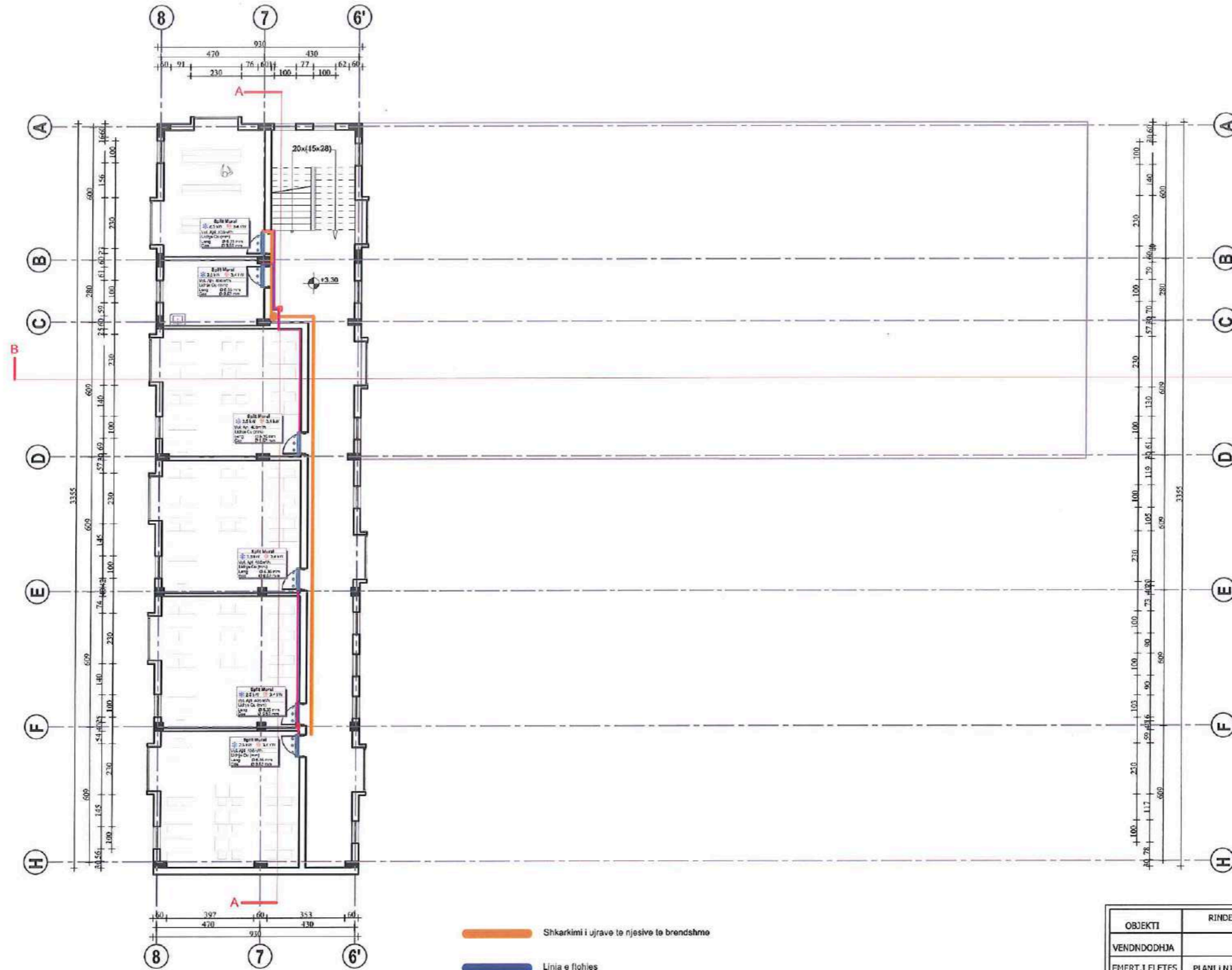
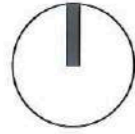

- Shkarkimi i ujrave te njesive te brendshme
- Linja e ftohjes
- Linja e ngrohjes

OBJEKTI	RINDERTIMI I SHKOLLES 9-VJECARE "HYSEN XHEKA"	NR.FLETES	A-01
VENDNDODHJA	KARBUNARE	FORMATI	420X297
EMERT.I FLETES	PLANI I NJESISE SE BRENDSHME, KATT I PARE	SHKALLA	
DREJTOR	ING. MIMOZA HAXHIU	 REPUBLIKA E SHQIPERISE BASHKIA LUSHNJE	
PERGJEGJES	ARK. SAIMIR MEBELLI		
SPECIALIST	ARK. OKSANA BAXHO		
SPECIALIST	ORJALD DEBINJA		
SPECIALIST	ING. ARTUR SINANI		
SPECIALIST	ING. ARBEN MUCA		
SPECIALIST	ING. MALDIN CELA		
SPECIALIST	ING. KLADII MYZEQARI		

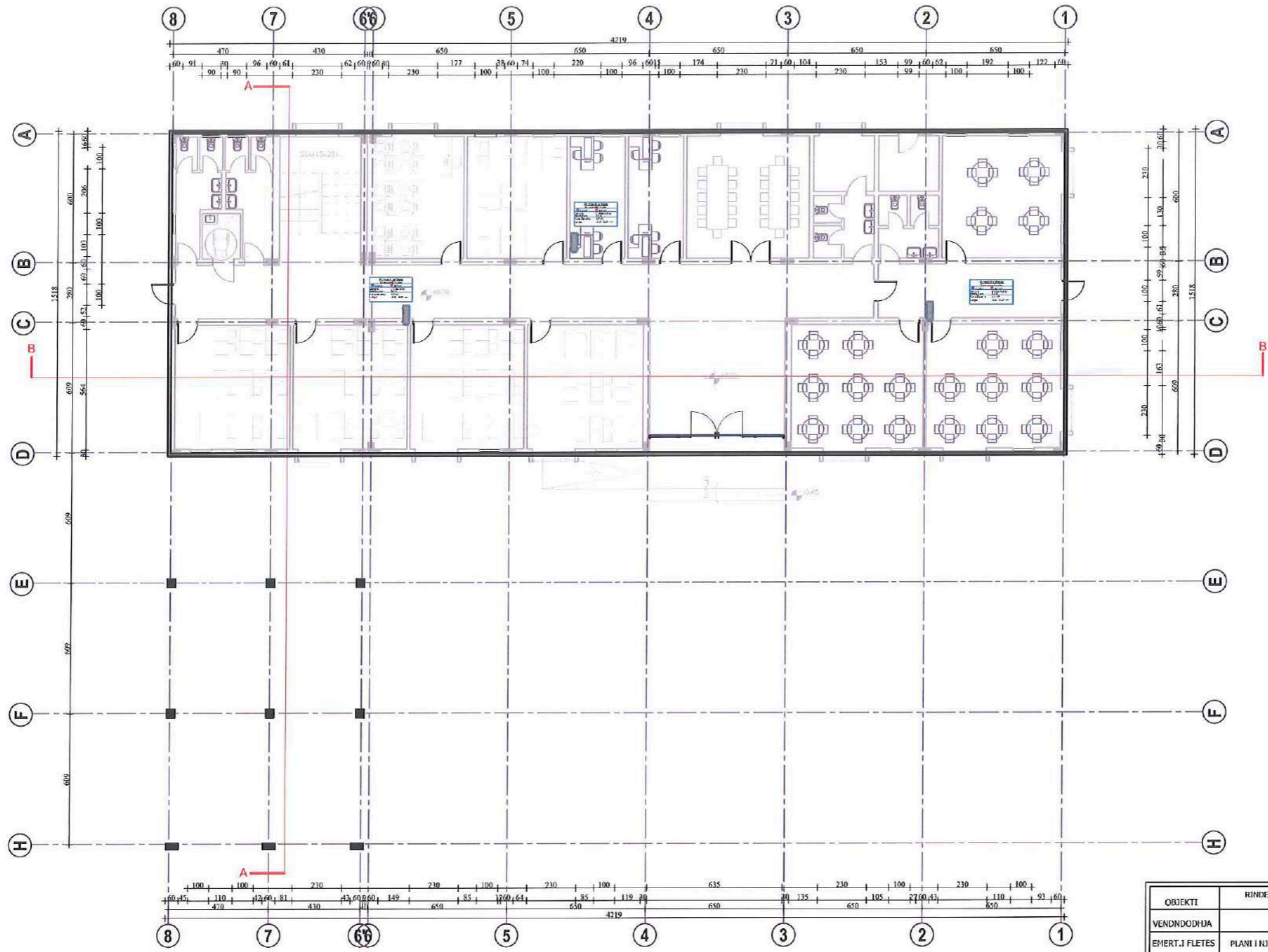

OBJEKTI	RINDERTIMI I SHKOLLES 9-VJECARE "HYSEN XHEKA"	NR.FLETES	A-01
VENDNDODHJA	KARBUNARE	FORMATI	420X297
EMERT.I FLETES	PLANI I NJESISE SE JASHTME, KATI PERDHE	SHKALLA	
DREJTOR	ING. MIMOZA HAXHILU		
PERGJEGJES	ARK. SAIMIR MEBELLI		
SPECIALIST	ARK. ORSANA BAXHO		
SPECIALIST	ORJALD DEBINJA		
SPECIALIST	ING. ARTUR SINANI		
SPECIALIST	ING. ARBEN MUCA		
SPECIALIST	ING. MALDIN CELA		
SPECIALIST	ING. KLADI NYZEQARI		



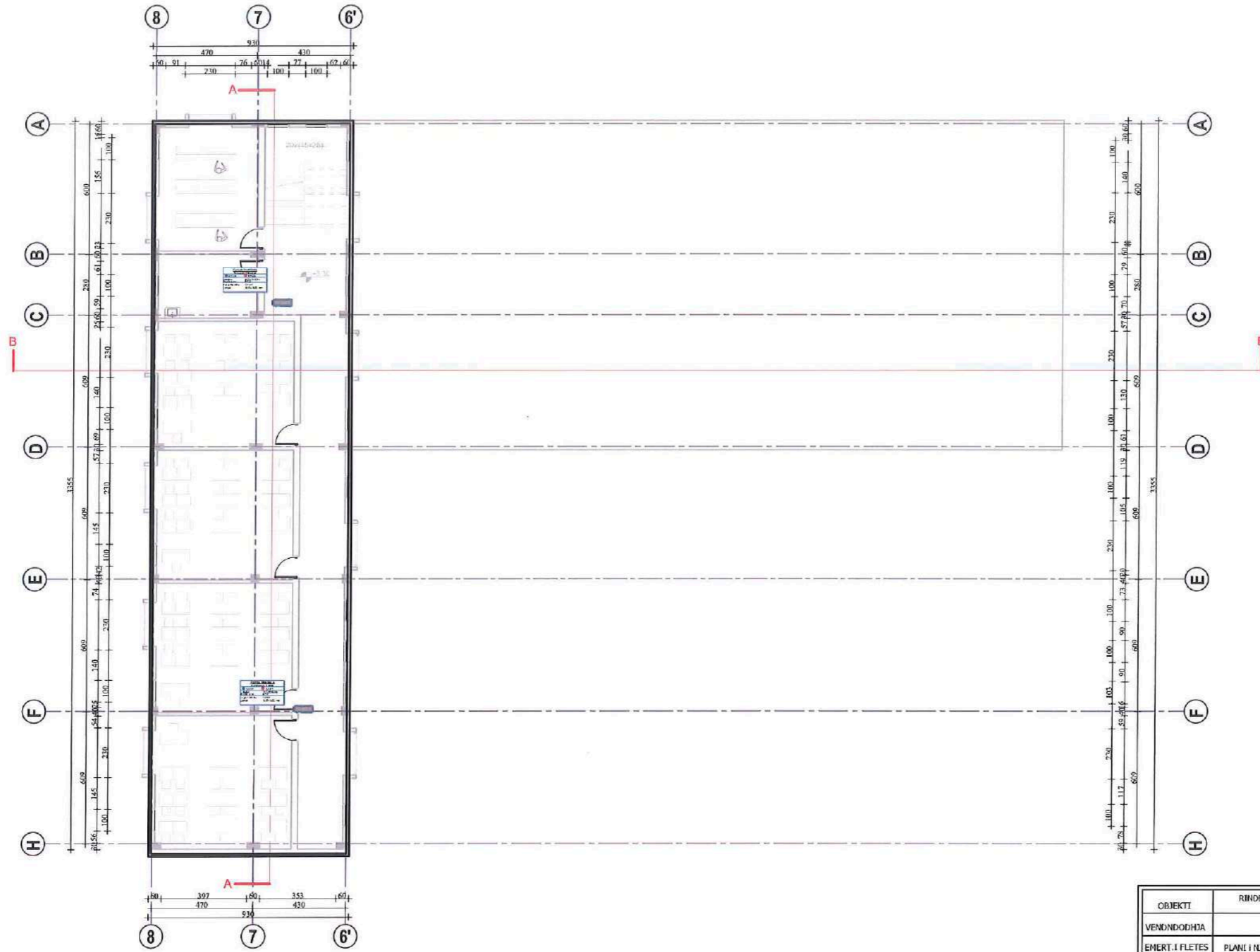
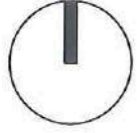

OBJEKTI	RINDERTIMI I SHKOLLES 9-VJECARE "HYSEN XHEKA"	NR.FLETES	A-01
VENDNDODHJA	KARBUNARE	FORMATI	420X297
EMERT.I FLETES	PLANI I NUESISE SE JASHTME, KATI I PARE	SHKALLA	
DREJTOR	ING. MIMOZA HAXHIU	 REPUBLIKA E SHQIPERISE BASHKIA LUSHNJE	
PERGJEGJES	ARK. SAIMIR MEBELLI		
SPECIALIST	ARK. OKSANA BAXHO		
SPECIALIST	ORJALD DEBINJA		
SPECIALIST	ING. ARTUR SINANI		
SPECIALIST	ING. ARBEN MUCA		
SPECIALIST	ING. MALDIN CELA		
SPECIALIST	ING. KLAJDI NYZEQARI		