



Prog 0.000  
 x = 434947.204  
 y = 4593718.855

Prog 107.00  
 x = 435042.575  
 y = 4593765.735

**INVESTITORI: BASHKIA BULQIZE**

SISTEMIM ASFALTIM RRUGA LAGJA GJEOLUGU, BULQIZE

Emertimi: HOROGRAFIA E RRUGES



"ERALD-G" Sh.p.k  
 Rruga "Koli Bano"  
 Tirane

Drejtes i projektit

Inxh. Gezim ISLAMI

Projektues

Inxh. Aldo MERKAJ

Inxh. Erindi GJOKA

Top. Kujtim CANAMETI

Elek. Hajdar KURTI

Mek. Arben MUHA

Hidr. Ersida VERÇANI

SHKALLA

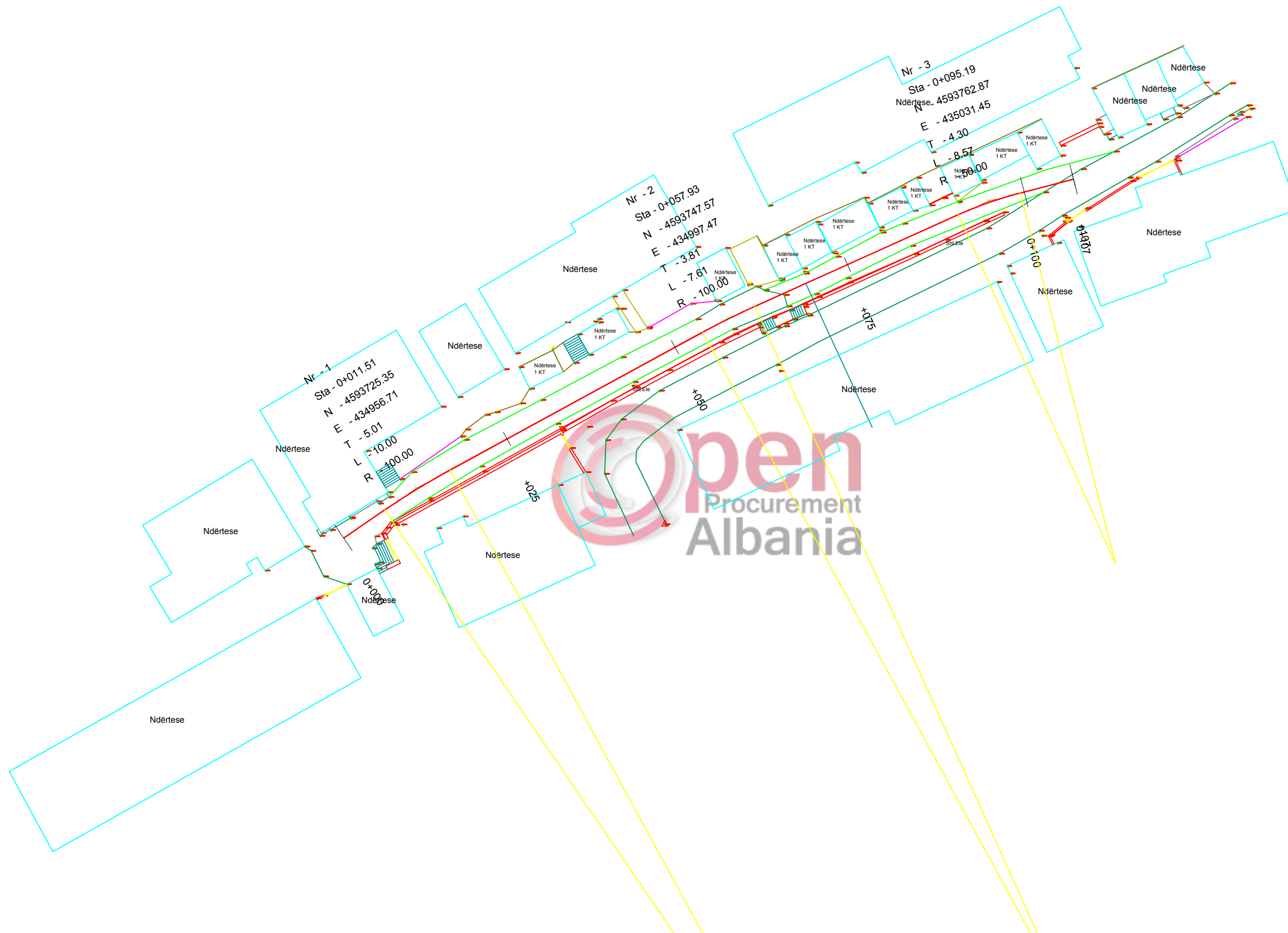
Sh 1:500

Tiranë 2018


FLETA

1 - 01

Format A3



**INVESTITORI: BASHKIA BULQIZE**  
 SISTEMIM ASFALTIM RRUGA LAGJA GJELOGU, BULQIZE

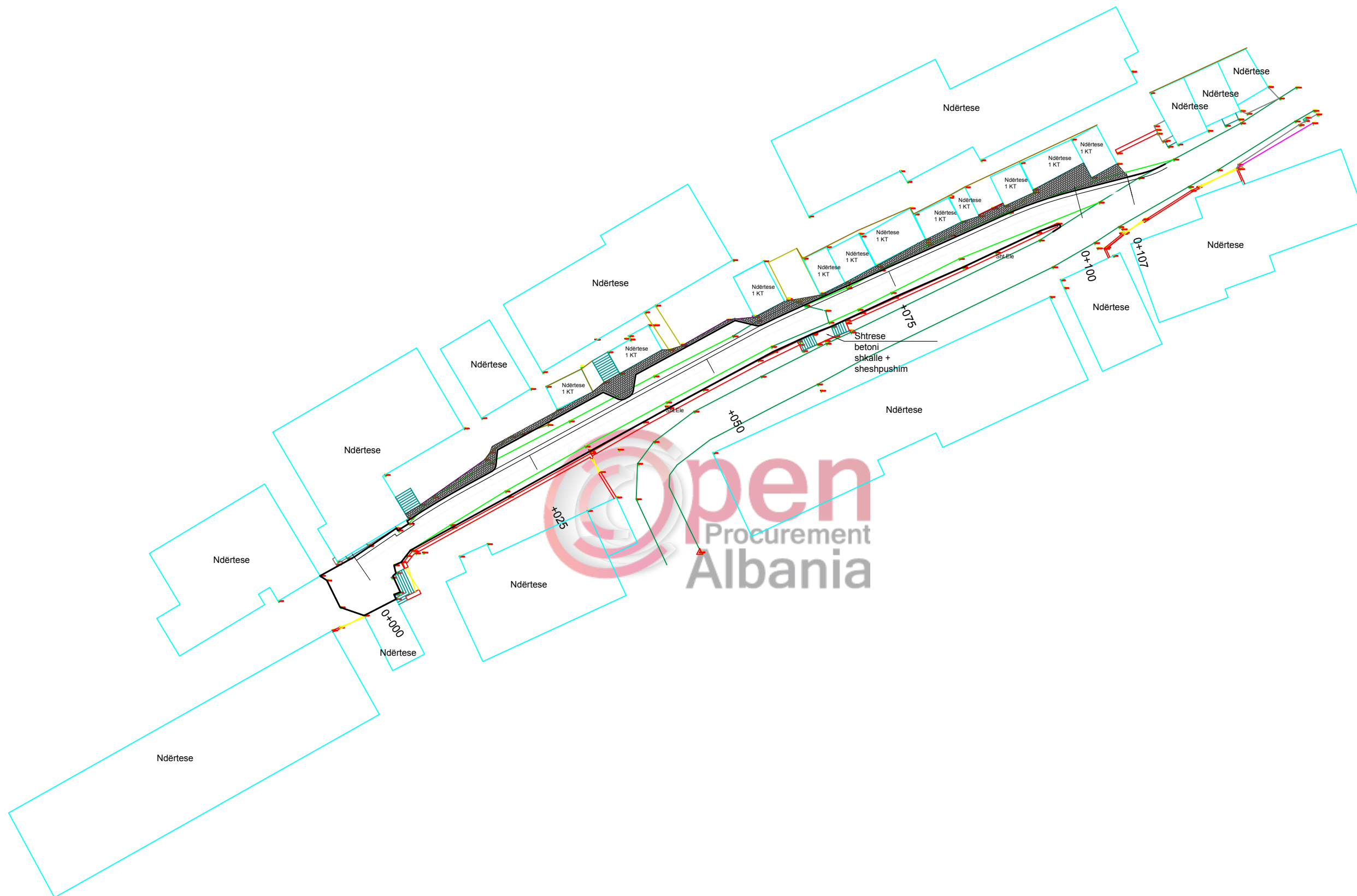
Emertimi: PLANIMETRIA E RRUGES  
  
 "ERALD-G" Sh.p.k  
 Rruga "Koli Bano"  
 Tirane

**Drejtes i projektit**  
 Inxh. Gezim ISLAMI

**Projektues**  
 Inxh. Aldo MERKAJ  
 Inxh. Erindi GJOKA  
 Top. Kujtim CANAMETI  
 Elek. Hajdar KURTI  
 Mek. Arben MUHA  
 Hidr. Ersida VERÇANI

SHKALLA	FLETA
Sh 1:500	3 - 01
Tiranë 2018	Format A3





**INVESTITORI: BASHKIA BULQIZE**

SISTEMIM ASFALTIM RRUGA LAGJA GJELOGU, BULQIZE

Emertimi: PLANIMETRIA E RRUGES



"ERALD-G" Sh.p.k  
Rruga "Koli Bano"  
Tirane

Drejtes i projektit

Inxh. Gezim ISLAMI

Projektues

Inxh. Aldo MERKAJ

Inxh. Erindi GJOKA

Top. Kujtim CANAMETI

Elek. Hajdar KURTI

Mek. Arben MUHA

Hidr. Ersida VERÇANI

SHKALLA

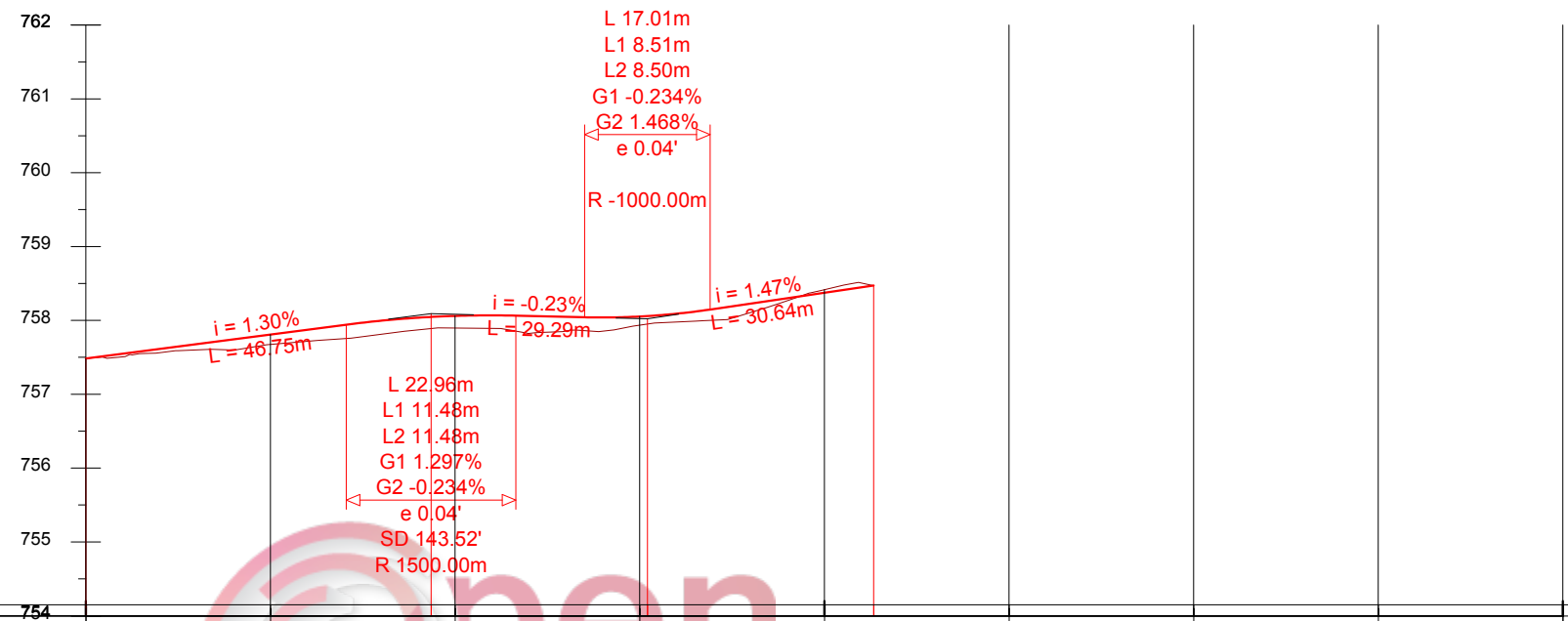
Sh 1:500

Tiranë 2018

FLETA


2 - 01

Format A3



NUMRI I SEKSIONIT	0+000	0+025	0+050	0+075	0+100	0+125	0+150	0+175	0+200
DISTANCA PJESORE	0.00	25.00	25.00	25.00	25.00	25.00	25.00	25.00	25.00
DISTANCA PROGRESIVE	0.00	25.00	50.00	75.00	100.00	125.00	150.00	175.00	200.00
KUOTA E PROJEKTIT	757.484	757.809	758.061	758.053	758.374				
KUOTA E TOKES	757.484	757.675	757.896	757.936	758.416				
THELLESIA E GERMIMIT					0.041				
LARTESIA E MBUSHJES	0.000	0.133	0.164	0.117					
NIVELETA	L 10.00 R 100.00		L 7.61 R 100.00		L 8.57 R 50.00				
PJERRESIA DHE DISTANCA	757.48		758.09		758.02				758.47

**INVESTITORI: BASHKIA BULQIZE**  
 SISTEMIM ASFALTIM RRUGA LAGJA GJEOLOGU, BULQIZE

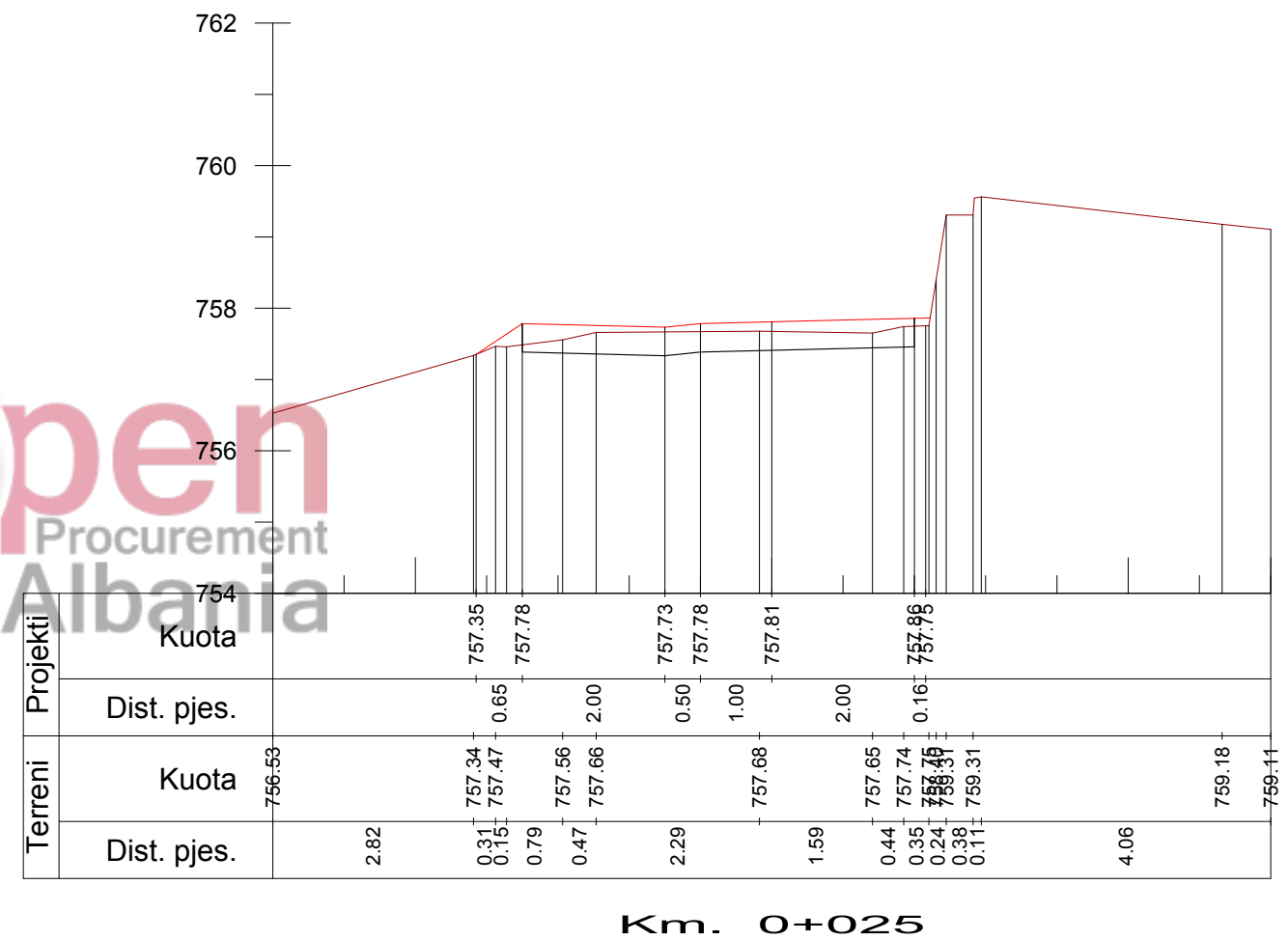
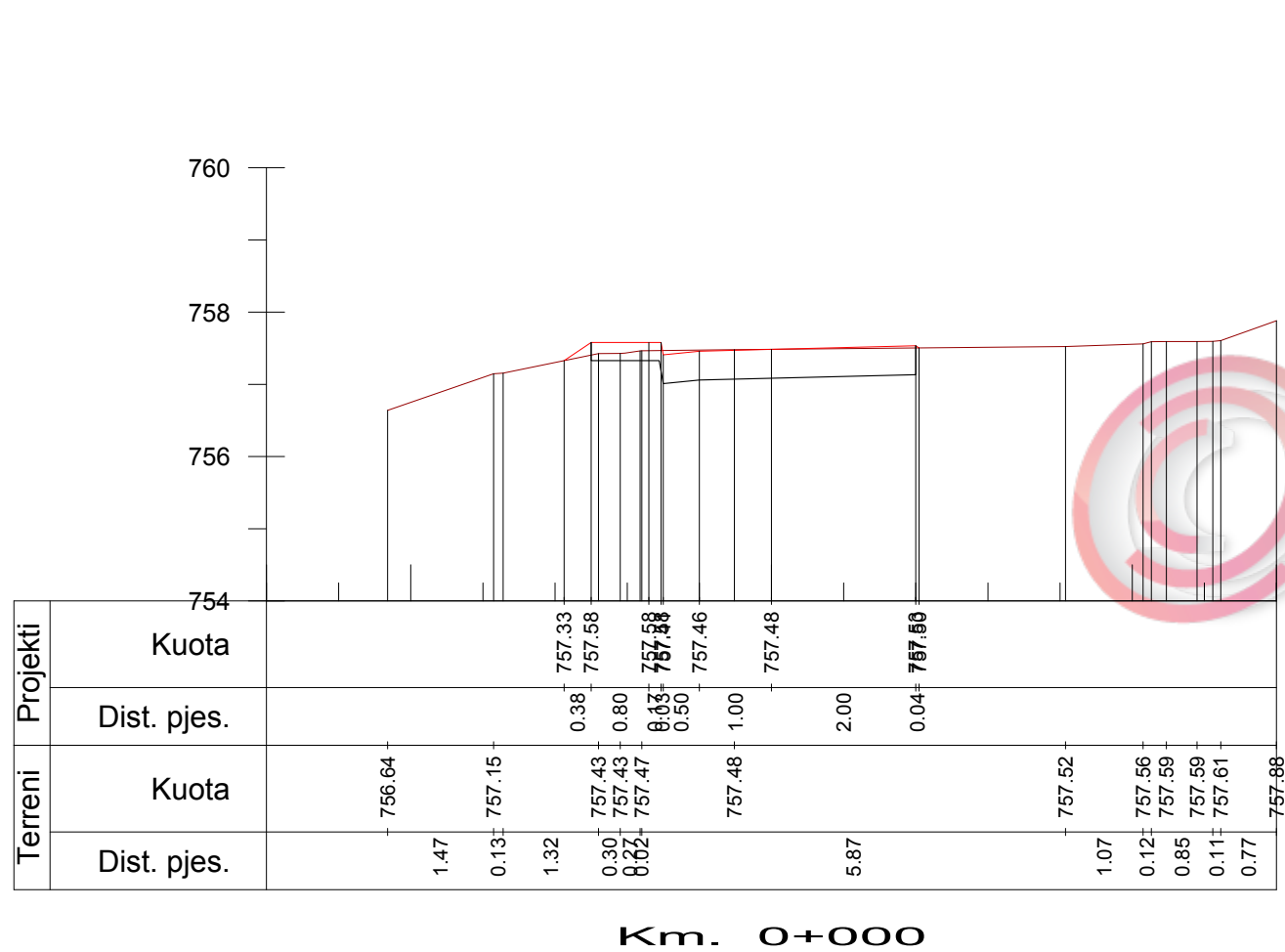
Emertimi: PROFILI GJATESOR  
 "ERALD-G" Sh.p.k.  
 Rruga "Koli Bano"  
 Tirane

Drejtesues i projektit  
 Inxh. Gezim ISLAMI


Projektues  
 Inxh. Aldo MERKAJ  
 Elek. Hajdar KURTI  
 Inxh. Erindi GJOKA  
 Mek. Arben MUHA  
 Top. Kujtim CANAMETI  
 Hidr. Ersida VERÇANI

SHKALLA  
 Sh H 1:1000  
 Sh V 1:100  
 Tiranë 2018

FLETA  
 4 - 01  
 Format A3

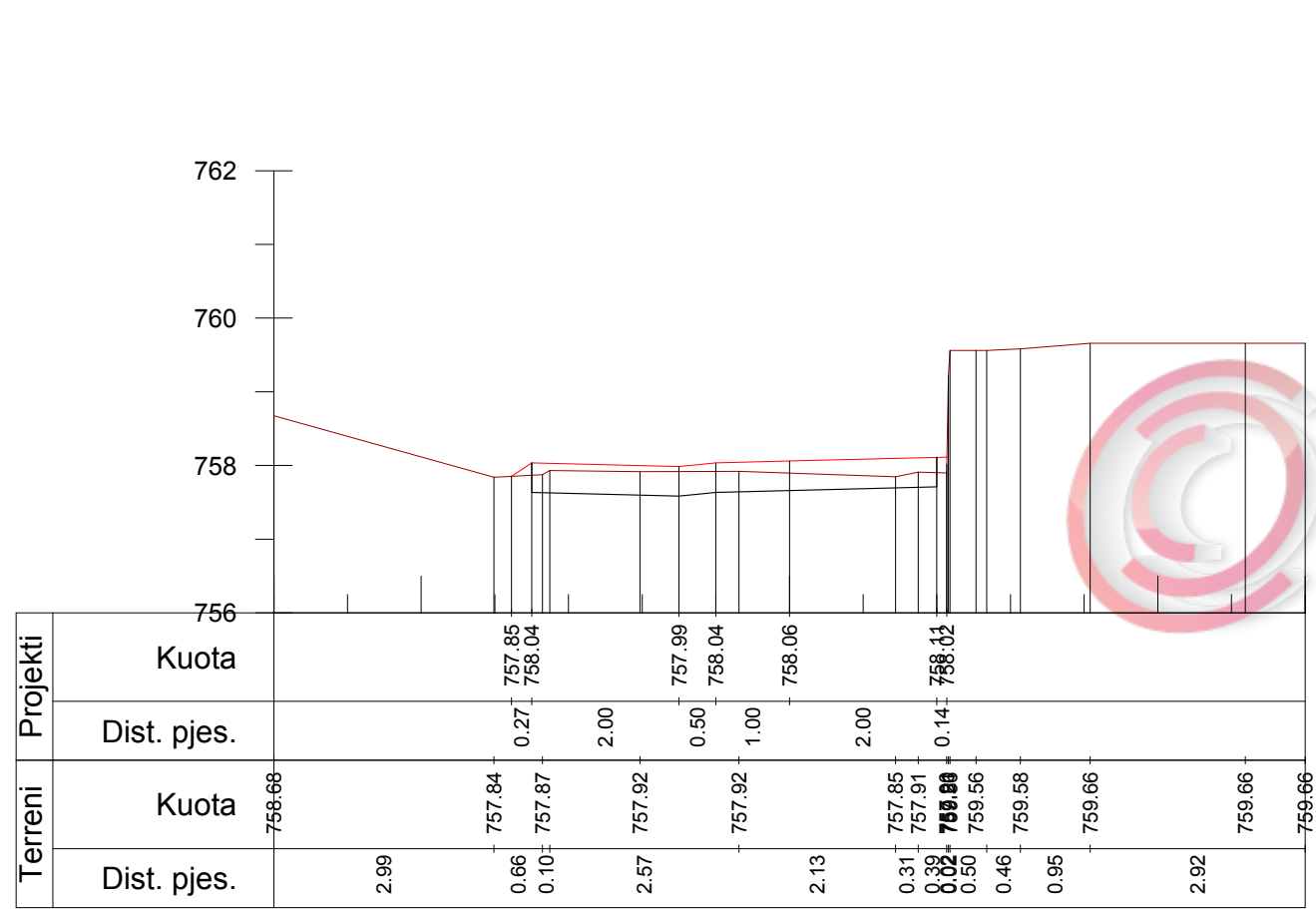


**INVESTITORI: BASHKIA BULQIZE**  
 SISTEMIM ASFALTIM RRUGA LAGJA GJEOLUGU, BULQIZE

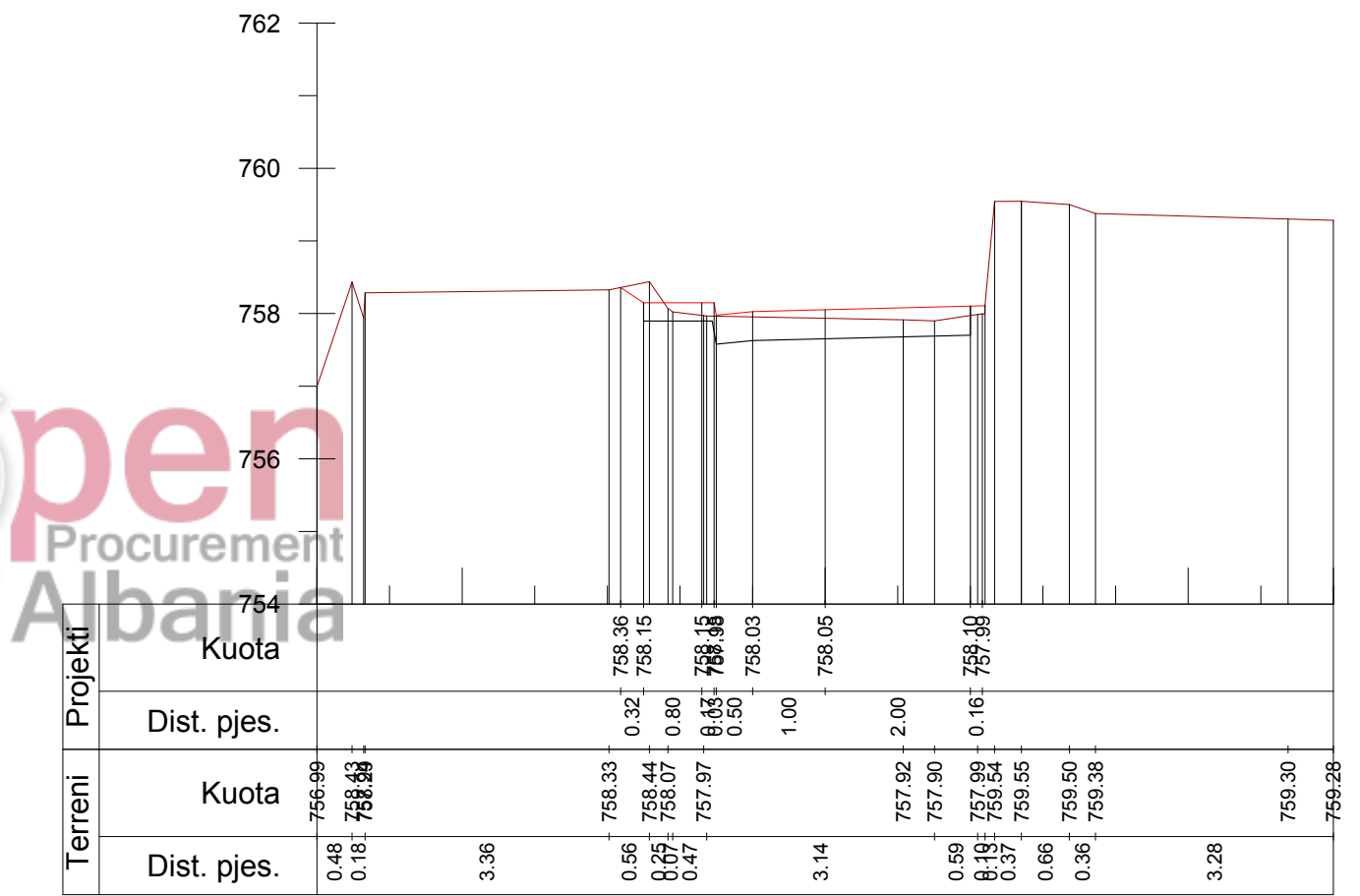
Emertimi: PROFILAT TERTHORE  
  
 "ERALD-G" Sh.p.k  
 Rruga "Koli Bano"  
 Tirane

Drejtes i projektit		Projektues	
Inxh. Gezim ISLAMI		Inxh. Aldo MERKAJ	Elek. Hajdar KURTI
		Inxh. Erindi GJOKA	Mek. Arben MUHA
		Top. Kujtim CANAMETI	Hidr. Ersida VERÇANI

SHKALLA	FLETA
Sh 1:100	5 - 01
Tiranë 2018	Format A3




Km. 0+050



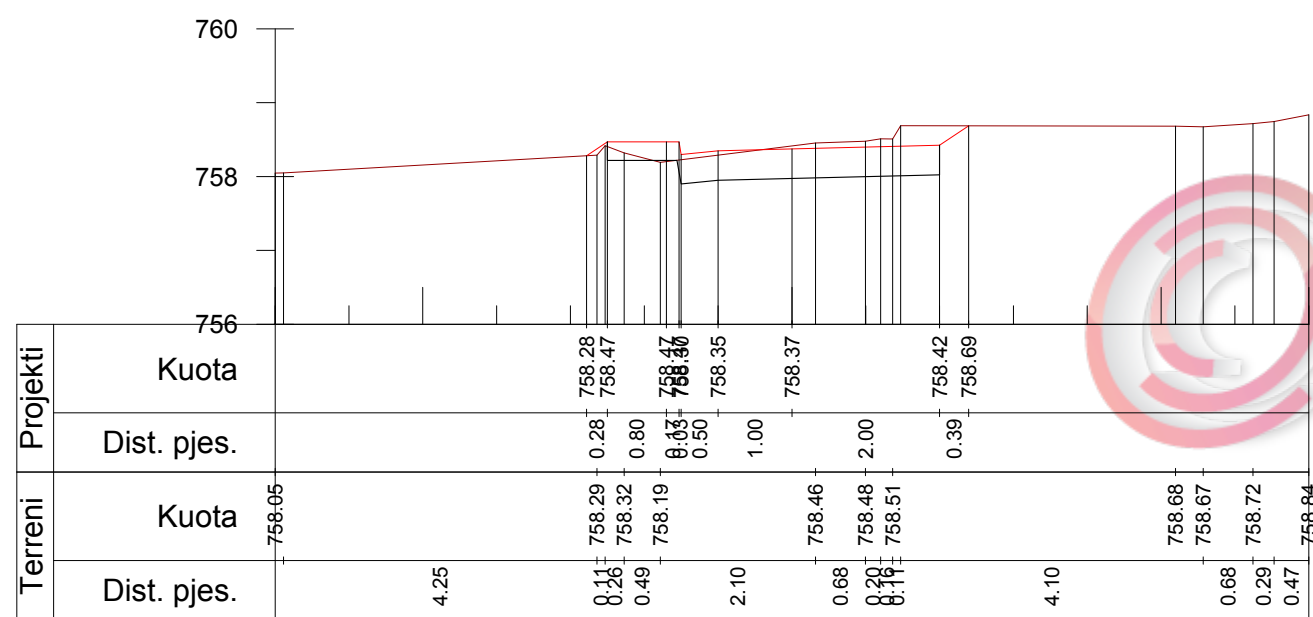
Km. 0+075

**INVESTITORI: BASHKIA BULQIZE**  
 SISTEMIM ASFALTIM RRUGA LAGJA GJEOLUGU, BULQIZE

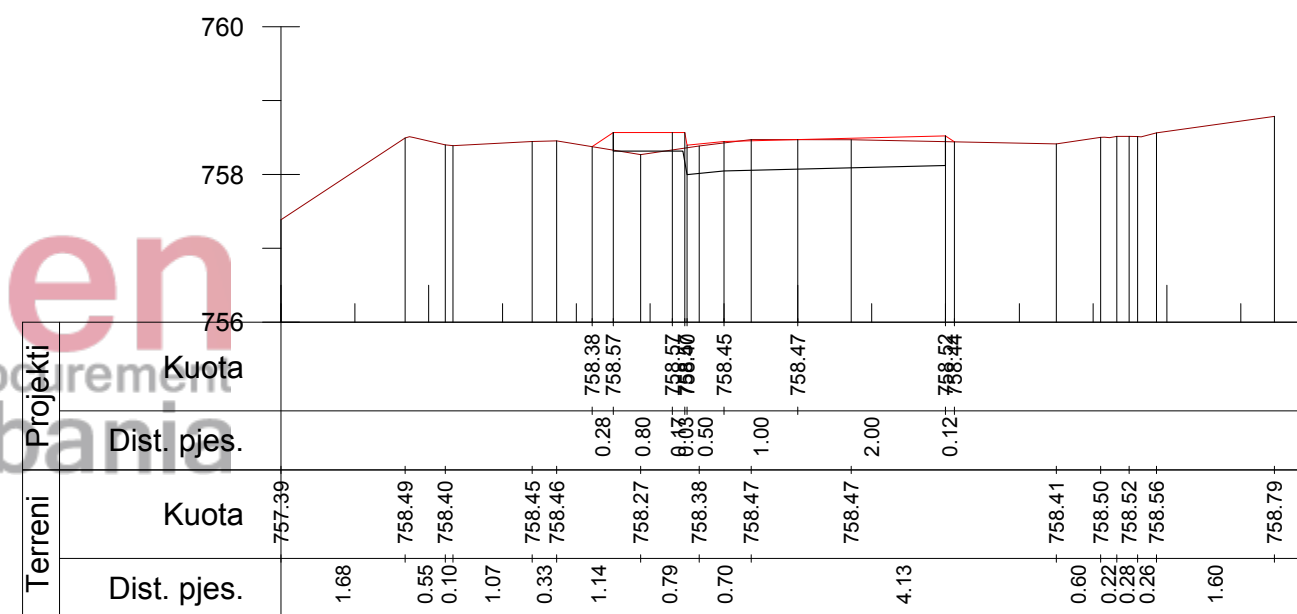
Emertimi: PROFILAT TERTHORE  
 "ERALD-G" Sh.p.k  
 Rruga "Koli Bano"  
 Tirane

Drejtues i projektit		Projektues	
Inxh. Gezim ISLAMI		Inxh. Aldo MERKAJ	Elek. Hajdar KURTI
		Inxh. Erindi GJOKA	Mek. Arben MUHA
		Top. Kujtim CANAMETI	Hidr. Ersida VERÇANI

SHKALLA	FLETA
Sh 1:100	5 - 02
Tiranë 2018	Format A3



Km. 0+100



Km. 0+107

INVESTITORI: BASHKIA BULQIZE

SISTEMIM ASFALTIM RRUGA LAGJA GJEOLUGU, BULQIZE

Emertimi: PROFILAT TERTHORE



"ERALD-G" Sh.p.k  
Rruga "Koli Bano"  
Tirane

Drejtues i projektit

Inxh. Gezim ISLAMI

Projektues

Inxh. Aldo MERKAJ

Inxh. Erindi GJOKA

Top. Kujtim CANAMETI

Elek. Hajdar KURTI

Mek. Arben MUHA

Hidr. Ersida VERÇANI

SHKALLA

Sh 1:100

Tiranë 2018

FLETA

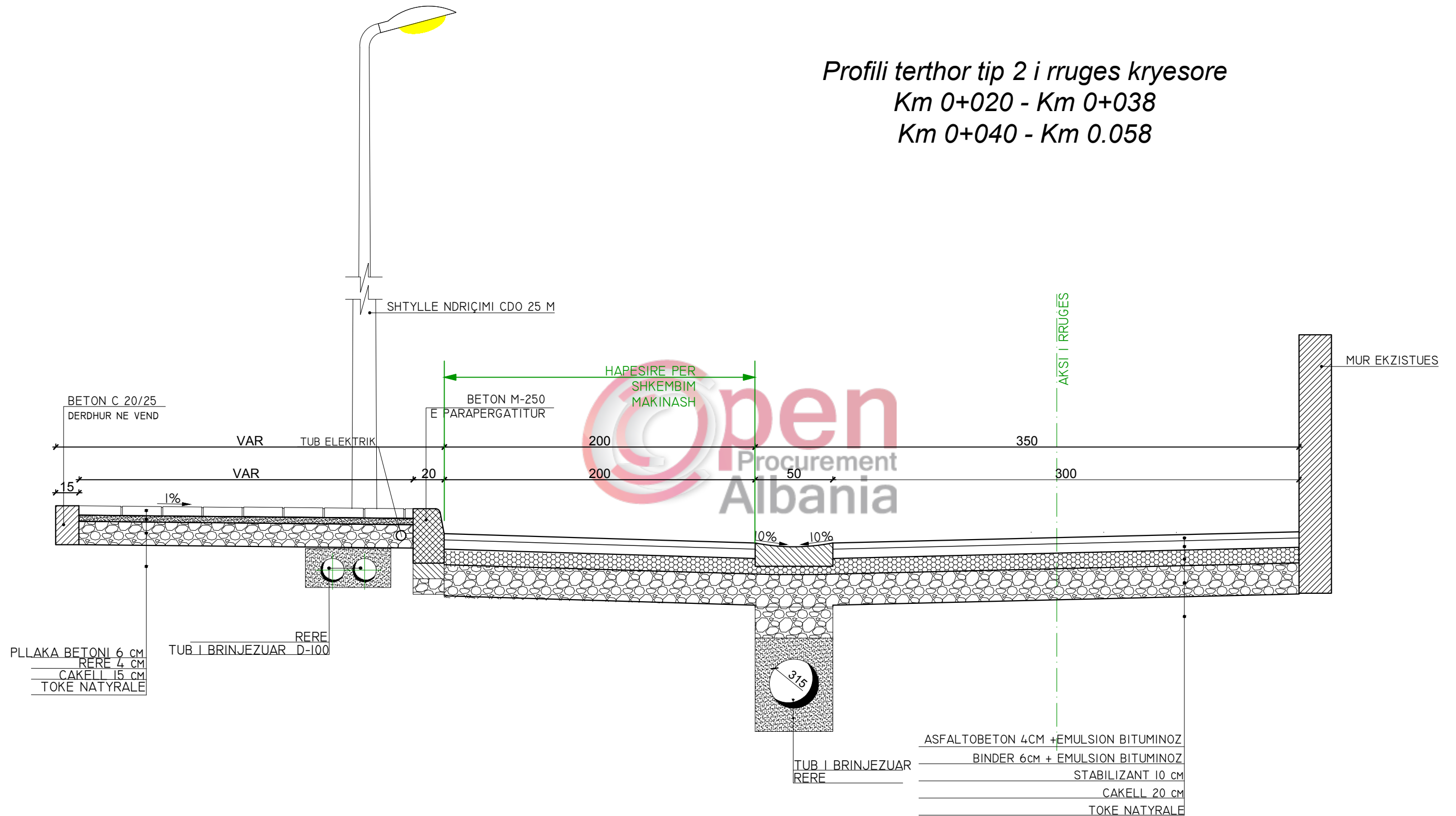
5 - 03

Format A3





Profili terthor tip 2 i rruges kryesore  
 Km 0+020 - Km 0+038  
 Km 0+040 - Km 0.058



INVESTITORI: BASHKIA BULQIZE

SISTEMIM ASFALTIM RRUGA LAGJA GJEOLUGU, BULQIZE

Emertimi: PROFILAT TERTHORE TIP



"ERALD-G" Sh.p.k  
 Rruga "Koli Bano"  
 Tirane

Drejtues i projektit

Inxh. Gezim ISLAMI

Projektues

Inxh. Aldo MERKAJ

Inxh. Erindi GJOKA

Top. Kujtim CANAMETI

Elek. Hajdar KURTI

Mek. Arben MUHA

Hidr. Ersida VERÇANI

SHKALLA

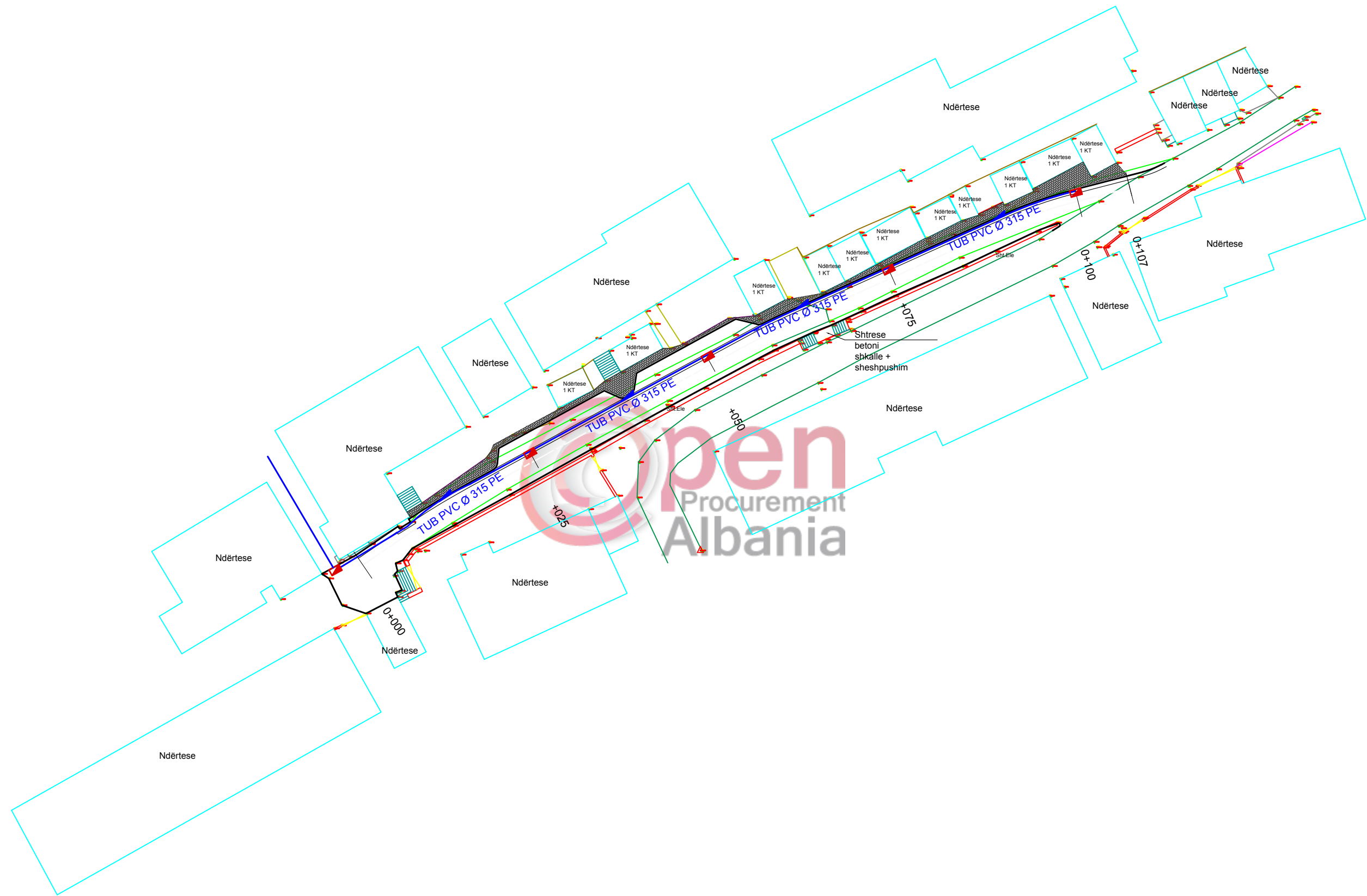
Sh 1:25

Tiranë 2018

FLETA

6 - 02

Format A3



**INVESTITORI: BASHKIA BULQIZE**

SISTEMIM ASFALTIM RRUGA LAGJA GJEOLUGU, BULQIZE

Emertimi: PLANIMETRIA E K.U.B



"ERALD-G" Sh.p.k  
Rruga "Koli Bano"  
Tirane

**Drejtes i projektit**

Inxh. Gezim ISLAMI

**Projektues**

Inxh. Aldo MERKAJ

Inxh. Erindi GJOKA

Top. Kujtim CANAMETI

Elek. Hajdar KURTI

Mek. Arben MUHA

Hidr. Ersida VERÇANI

**SHKALLA**

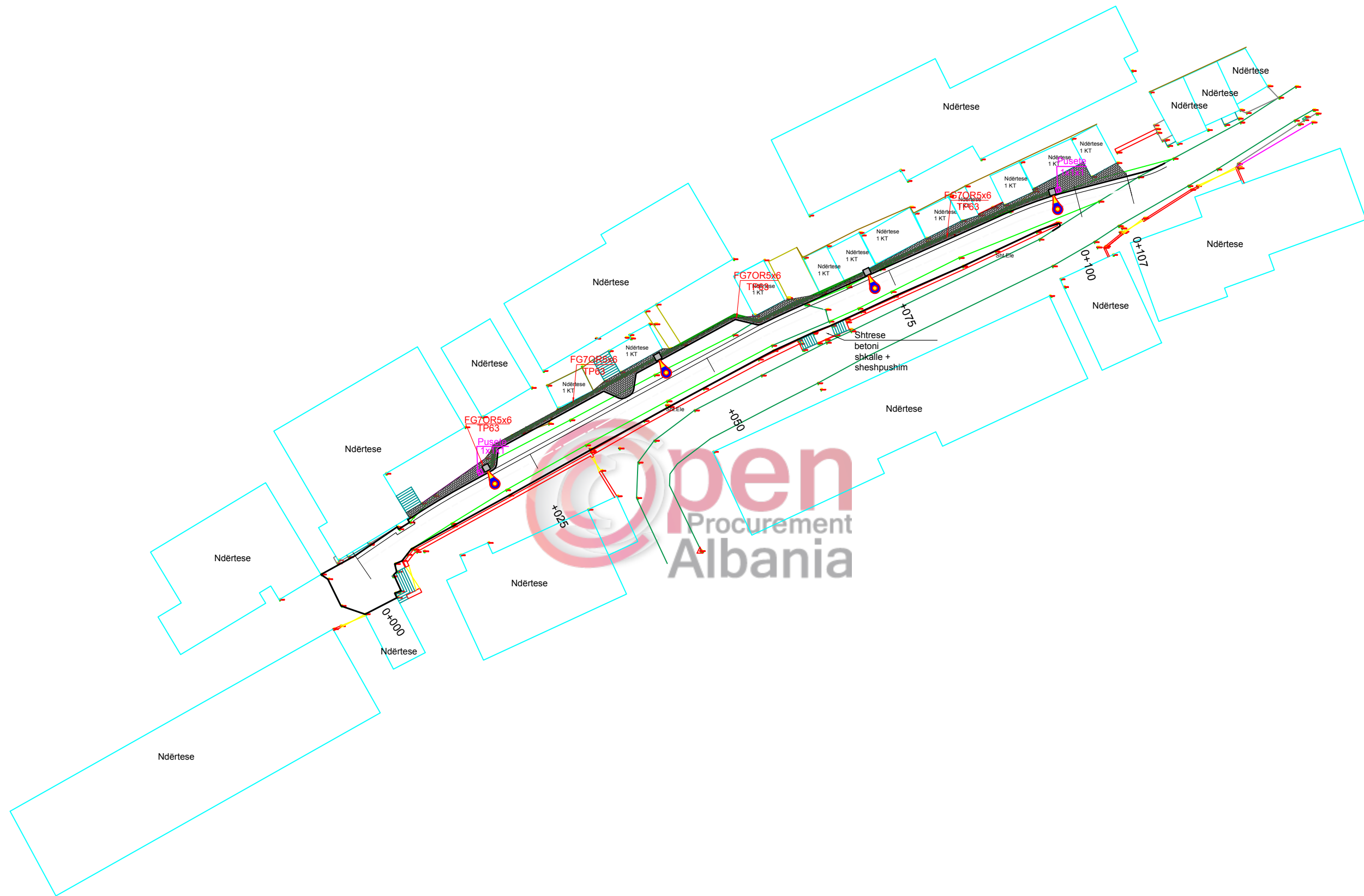
Sh 1:500

Tiranë 2018

**FLETA**

7 - 01

Format A3



**INVESTITORI: BASHKIA BULQIZE**

SISTEMIM ASFALTIM RRUGA LAGJA GJELOGU, BULQIZE

Emertimi: PLANIMETRIA E NDRICIMIT



"ERALD-G" Sh.p.k  
Rruga "Koli Bano"  
Tirane

Drejtes i projektit

Inxh. Gezim ISLAMI

Projektues

Inxh. Aldo MERKAJ

Inxh. Erindi GJOKA

Top. Kujtim CANAMETI

Elek. Hajdar KURTI

Mek. Arben MUHA

Hidr. Ersida VERÇANI

SHKALLA

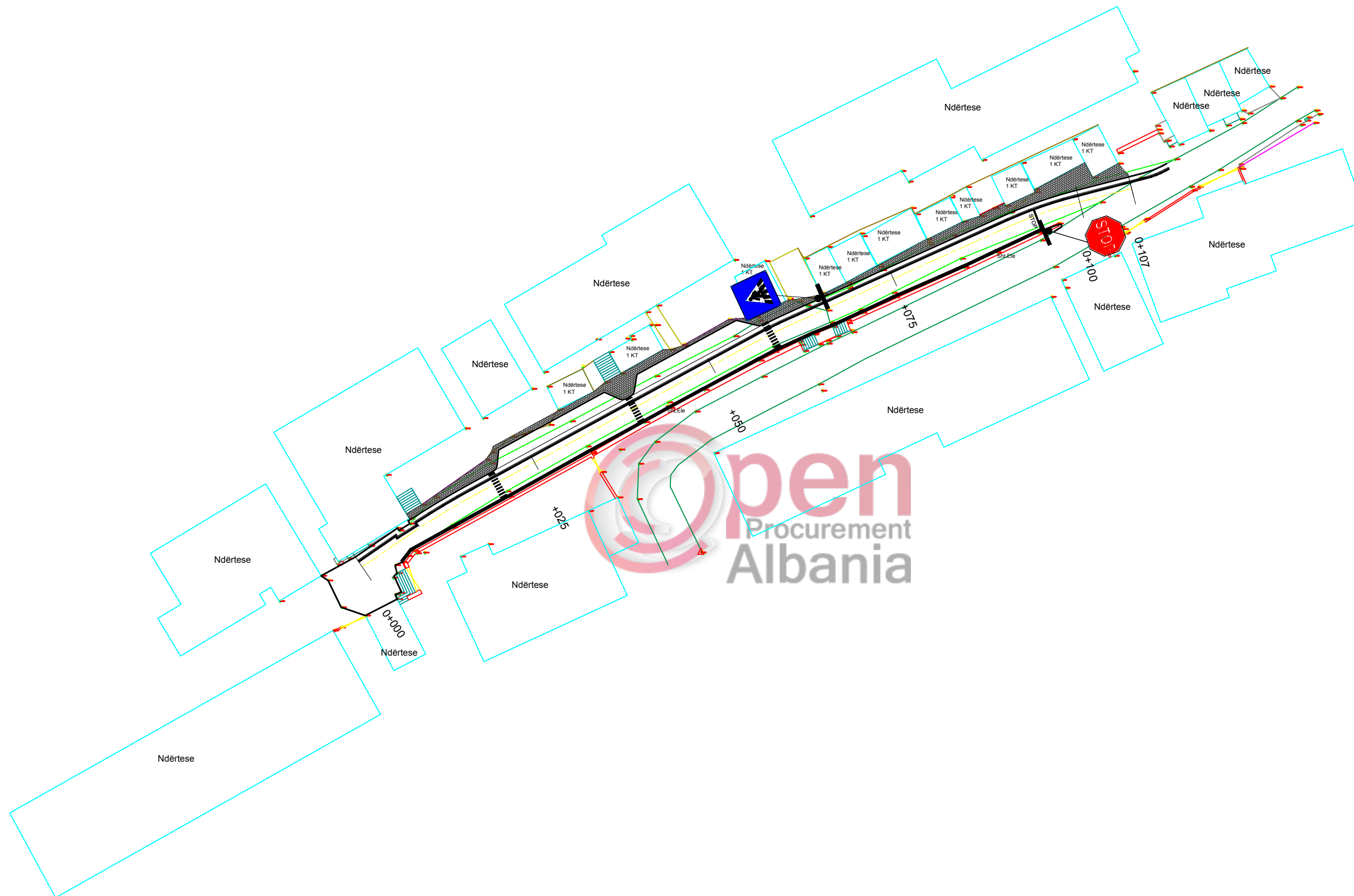
Sh 1:500

Tiranë 2018

FLETA

8 - 01

Format A3



**INVESTITORI: BASHKIA BULQIZE**

SISTEMIM ASFALTIM RRUGA LAGJA GJELOGU, BULQIZE

Emertimi: PLANIMETRIA E SINJALISTIKES



"ERALD-G" Sh.p.k  
Rruga "Koli Bano"  
Tirane

Drejtes i projektit

Inxh. Gezim ISLAMI

Projektues

Inxh. Aldo MERKAJ

Inxh. Erindi GJOKA

Top. Kujtim CANAMETI

Elek. Hajdar KURTI

Mek. Arben MUHA

Hidr. Ersida VERÇANI

SHKALLA

Sh 1:500

Tiranë 2018

FLETA

9 - 01

Format A3

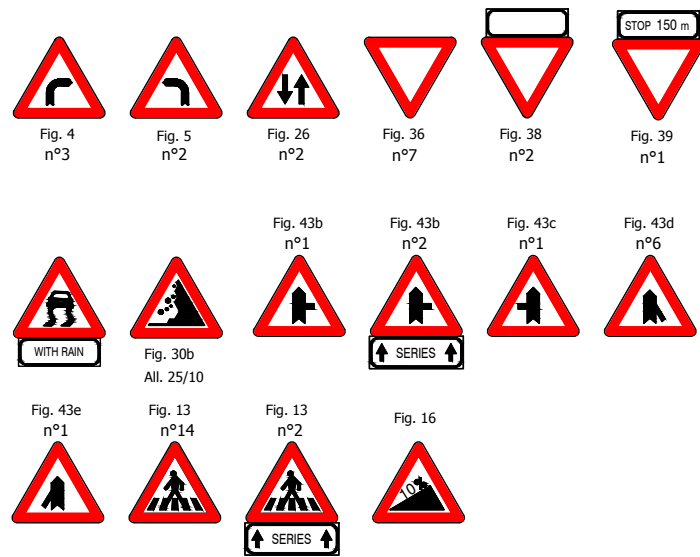


## SHENJAT PARANDALUESE

Trekendeshi: e kuqe reflektive

Sfondi: e kuqe reflektive

Simboli: zeze



## TABELAT POTESUESE

Tabela: e bardhe reflektive

Sfondi: e zeze

## TABELAT SHTESE

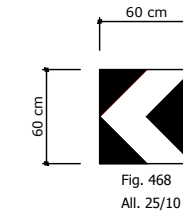
Sfondi: e bardhe reflektive

## TABELAT SHIGJETE

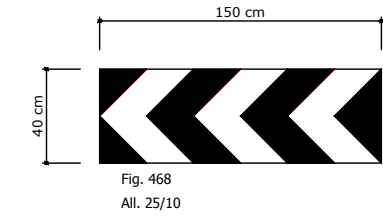
Sfondi: jeshile reflektive

Teksti: e zeze

Pozicioni i shenjave Chevron	
Rrezja e kthese (m)	Distanca (m)
30 - 50	8
50 - 100	12
100 - 200	20
200 - 400	30
>400 (nese duhet)	30-50



Shenja Chevron ne nje drejtim



Shenja Chevron

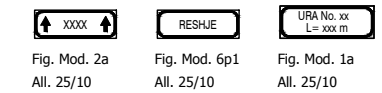
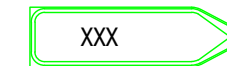


Fig. 249  
All. 25/10



## TABELAT INFORMUESE

Fig. 317  
All. 25/10

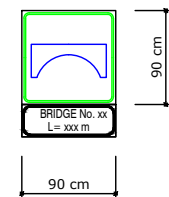


Fig. 295  
All. 25/10

## PROHIBIT SIGN SHENJA PARANDALUES

Ndalim parakalimi

Cepi & sfondi: e bardhe reflektive

Rrethi: e kuqe reflektive

Simboli: e zeze dhe kuqe reflektive

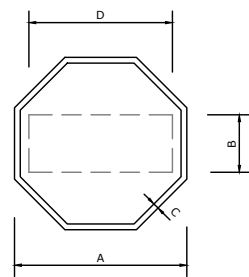
Limit shpejtesie

Rrethi: e kuqe reflektive

Simboli: e zeze reflektive

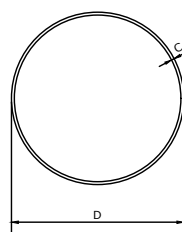
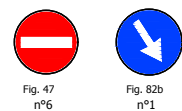


Fig. 37  
n°1



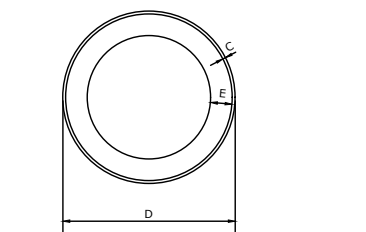
TETEKENDESH

	A	B	C	D
Small	60	20	2	50



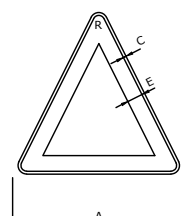
SHENJAT DETYRUESE

	C	D
Small	0.8	40



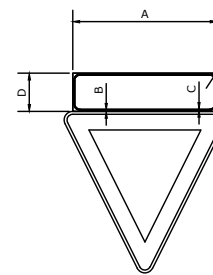
SHENJAT PARANDALUESE

	C	D	E
Small	0.8	40	5
Normal	1	60	7.5



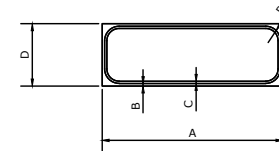
TREKENDORE

	A	C	E	R
Small	60	1	5.5	3
Normal	90	1.5	8	4.5



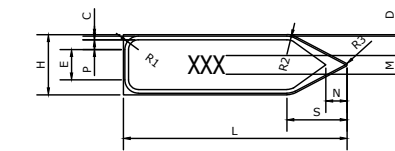
DREJTEKENDESH INFORMUES

	A	B	C	D	R
Small	58	0.3	0.6	18	2

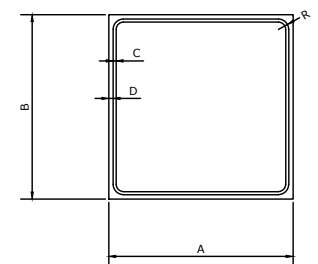


DREJTEKENDESH

	A	B	C	D	R
Normal	90	0.8	1.5	30	5.5



	C	D	E	H	L	M
Normal	1.5	1	22	40	150	18
	N	R1	R2	R3	P	S
	15.5	8	13	2	6.5	38



DREJTEKENDORE

	A	B	C	D	R
Normal	90	135	1.6	0.8	7

INVESTITORI: BASHKIA BULQIZE

SISTEMIM ASFALTIM RRUGA LAGJA GJEOLUGU, BULQIZE

Emertimi: DETAJE



"ERALD-G" Sh.p.k  
Rruga "Koli Bano"  
Tirane

Drejtuues i projektit

Inxh. Gezim ISLAMI

Projektues

Inxh. Aldo MERKAJ

Inxh. Erindi GJOKA

Top. Kujtim CANAMETI

Elek. Hajdar KURTI

Mek. Arben MUHA

Hidr. Ersida VERÇANI

SHKALLA

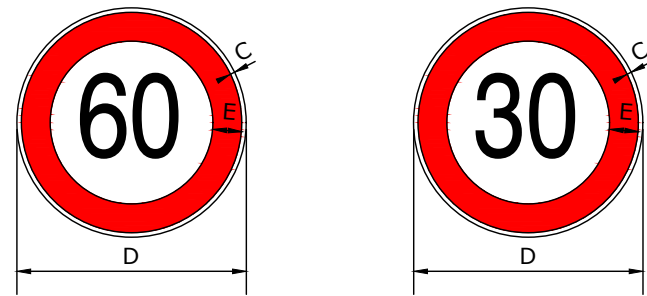
Sh 1:50

Tiranë 2018

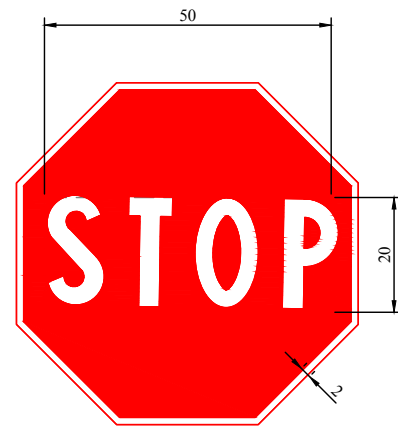
FLETA

10 - 01

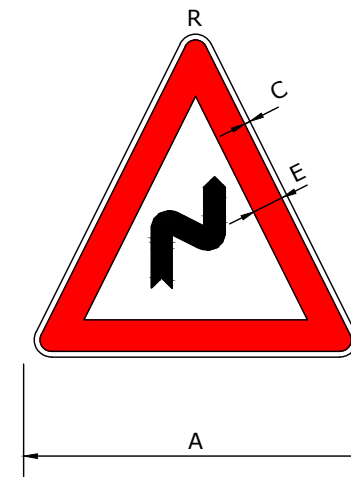
Format A3



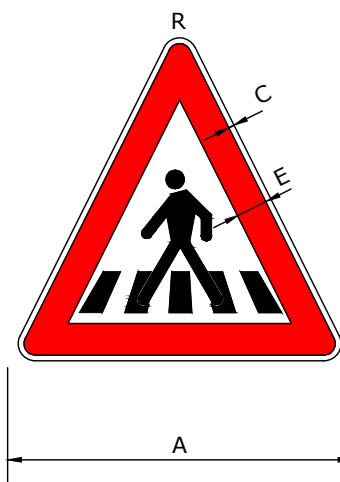
C	D	E
0.8	40	5



A	B	C	D
60	20	2	50



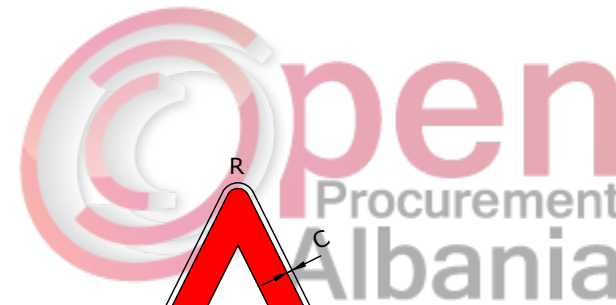
A	C	E	R
60	1	5.5	3



A	C	E	R
60	1	5.5	3



A	C	E	R
60	1	5.5	3



**INVESTITORI: BASHKIA BULQIZE**

SISTEMIM ASFALTIM RRUGA LAGJA GJEOLUGU, BULQIZE

Emertimi: DETAJE



"ERALD-G" Sh.p.k  
Rruga "Koli Bano"  
Tirane

Drejtuës i projektit

Inxh. Gezim ISLAMI

Projektues

Inxh. Aldo MERKAJ

Inxh. Erindi GJOKA

Top. Kujtim CANAMETI

Elek. Hajdar KURTI

Mek. Arben MUHA

Hidr. Ersida VERÇANI

SHKALLA

Sh 1:25

Tiranë 2018

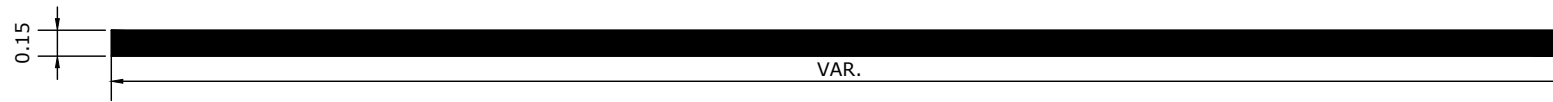
FLETA

10 - 02

Format A3

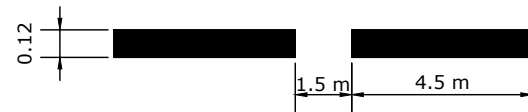
# VIJEZIMI I RRUGEVE

## VIJEZIMI NE KUFIJETE E RRUGES Tipi A"vazhduar"

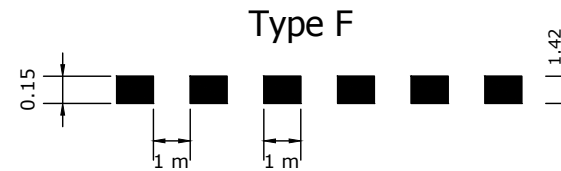


Linjë paralajmëruese tek nyjet, kthesat dhe pikat e tjera të rrezikshme

### Type E



Vijëzimi tek cepi i karrexhatës, tek nyjet ose vendndodhjet anësore.



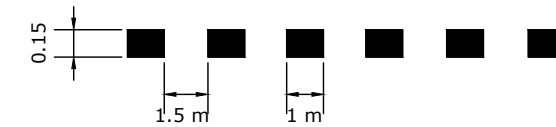
Vijëzimi i aksit qendror ose vijëzimi i korsisë për shpejtësi <50 km/h

### Type D

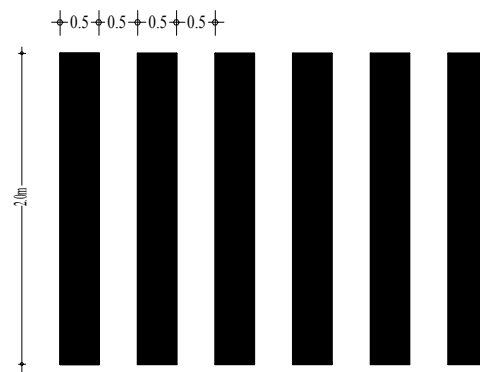


Udhëzuesi për automjetet që duhet të kalojnë nëpër një nyje.  
Zakonisht përdoret tek nyjet komplekse.

### Type G

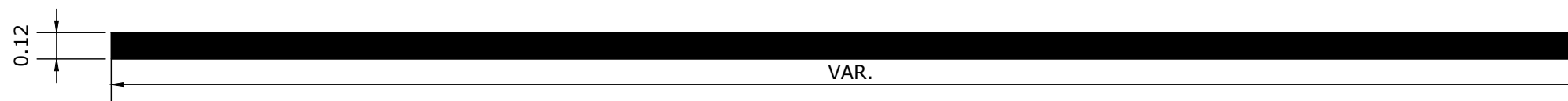


## KALIMI KEMBESOREVE



## VIJEZIMI NE AKS TE RRUGES

### Tipi A"vazhduar"



INVESTITORI: BASHKIA BULQIZE

SISTEMIM ASFALTIM RRUGA LAGJA GJEOLUGU, BULQIZE

Emertimi: DETAJE



"ERALD-G" Sh.p.k  
Rruga "Koli Bano"  
Tirane

Drejtuës i projektit

Inxh. Gezim ISLAMI

Projektues

Inxh. Aldo MERKAJ

Elek. Hajdar KURTI

Inxh. Erindi GJOKA

Mek. Arben MUHA

Top. Kujtim CANAMETI

Hidr. Ersida VERÇANI

SHKALLA

Sh 1:25

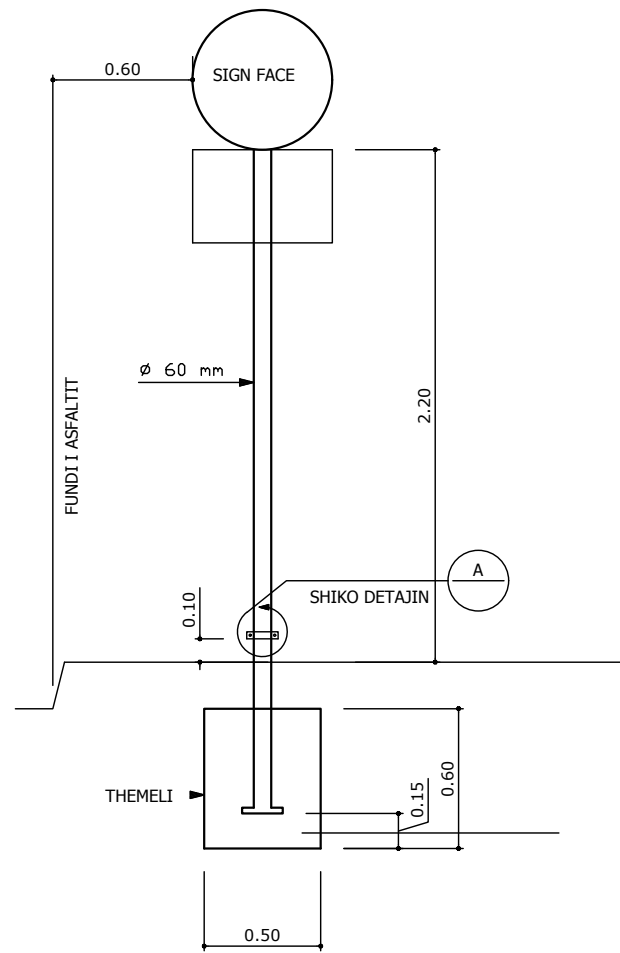
Tiranë 2018

FLETA

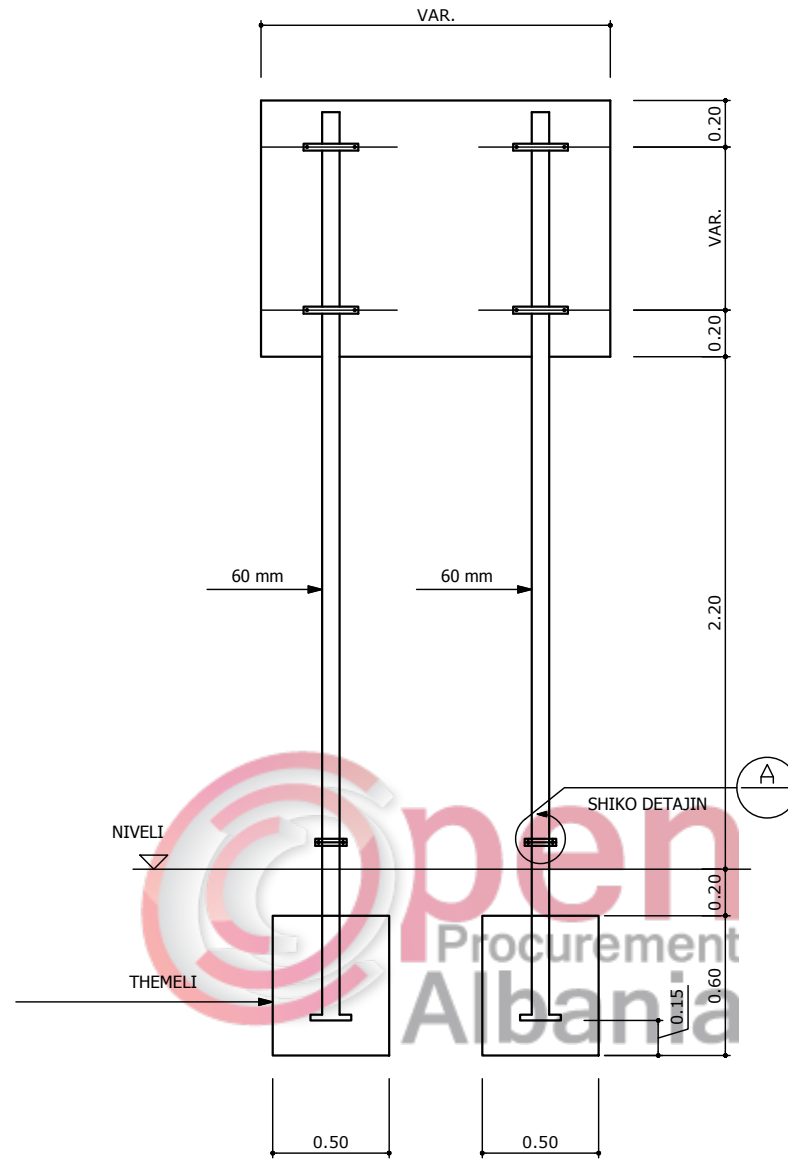
10 - 03

Format A3

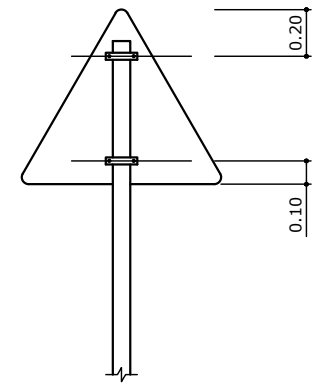
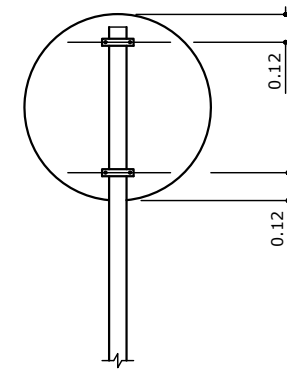
# VENDOSJA E TABELAVE



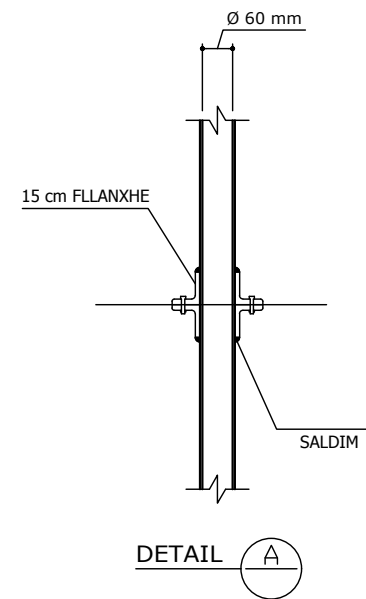
VENDOSJA E NJE TABELE



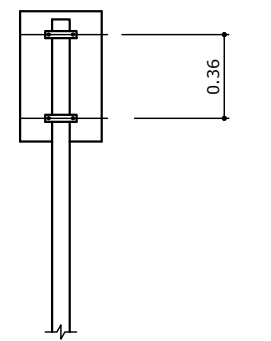
VENDOSJA E E DY TABELAVE



FIKSIMI I TABELES



DETAIL A



0.36

<b>INVESTITORI: BASHKIA BULQIZE</b>
SISTEMIM ASFALTIM RRUGA LAGJA GJEOLUGU, BULQIZE

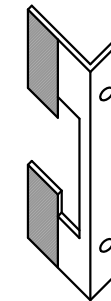
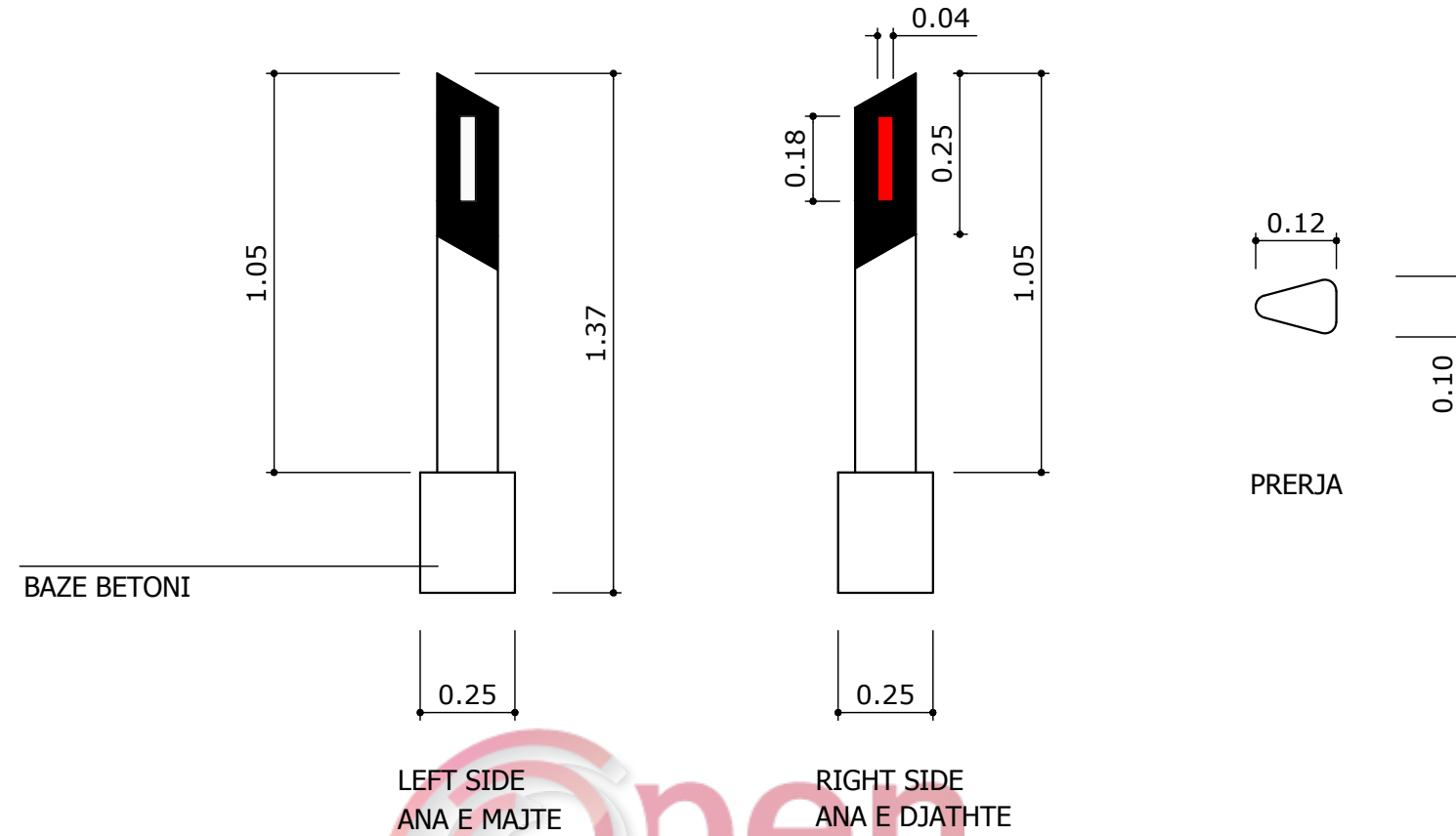
Emertimi: DETAJE
 "ERALD-G" Sh.p.k Rruga "Koli Bano" Tirane

Drejtes i projektit	Projektues		
Inxh. Gezim ISLAMI	Inxh. Aldo MERKAJ	Elek. Hajdar KURTI	
	Inxh. Erindi GJOKA	Mek. Arben MUHA	
	Top. Kujtim CANAMETI	Hidr. Ersida VERÇANI	

SHKALLA	FLETA
Sh 1:25	10 - 04
Tiranë 2018	Format A3



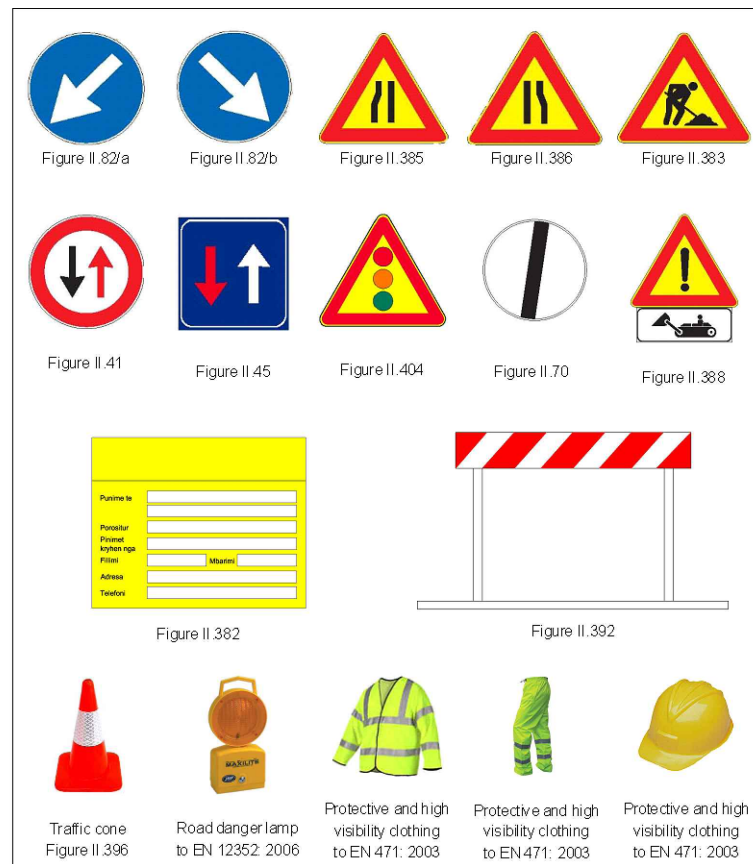
# INDIKATORI I CEPIT TE RRUGES



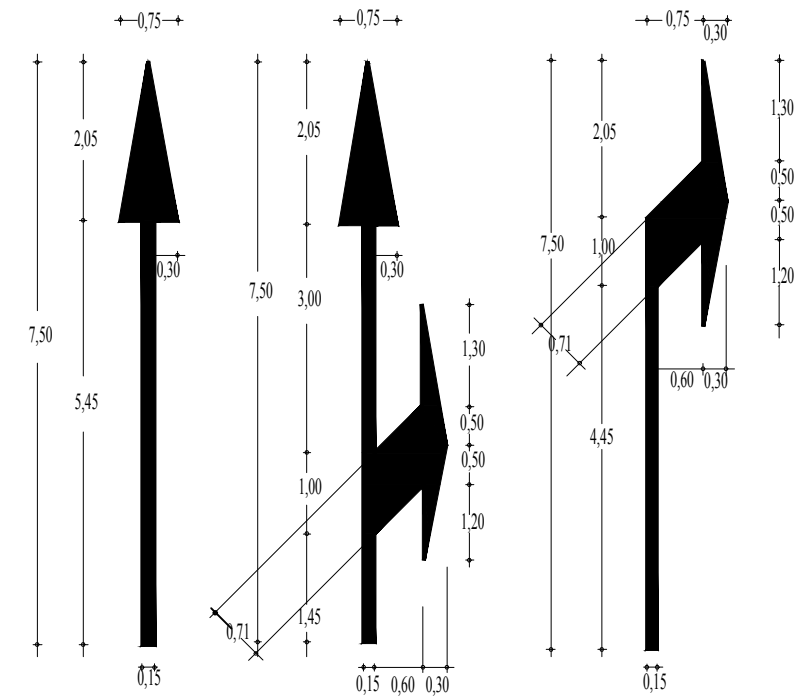
FIKSUES NE CEPAT E MUREVE TE BETONIT

SHENIM: INDIKATORET E FUNDIT TE RRUGES VENDOSEN NE NJE DISTANCE PREJ 50 m.  
NE RAST SE VENDOSEN NE GUARDRAIL TE RRUGES ATO FIKSOHEN NE FAQEN E TYRE.

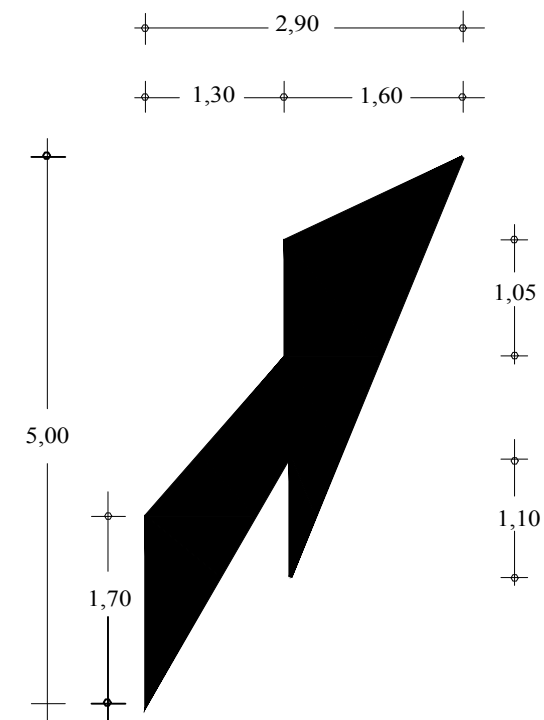
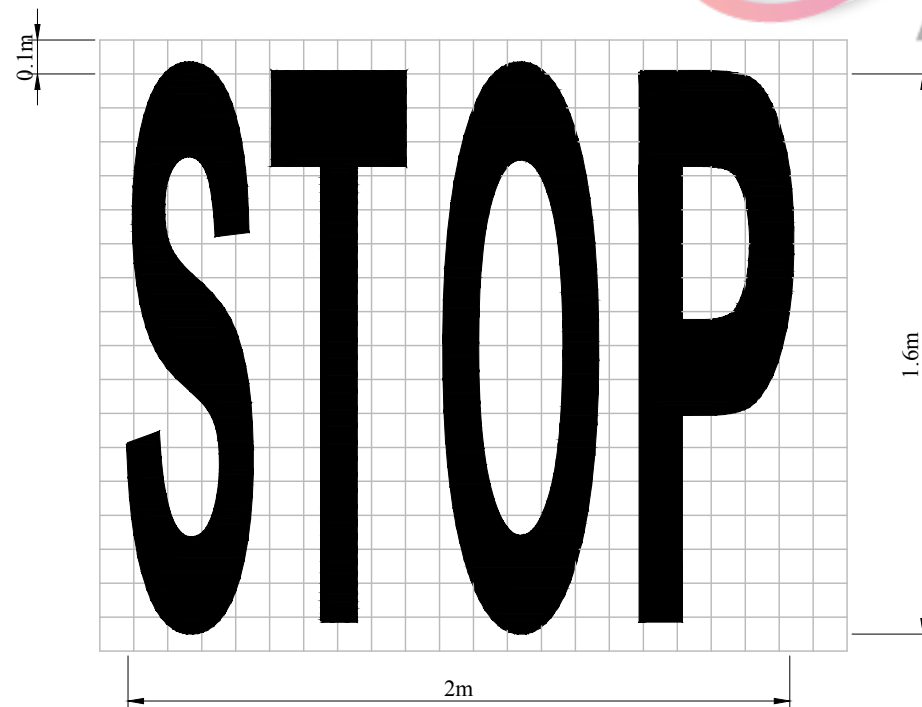
<b>INVESTITORI: BASHKIA BULQIZE</b> SISTEMIM ASFALTIM RRUGA LAGJA GJEOLUGU, BULQIZE	Emertimi: DETAJE		Drejtues i projektit		Projektues		SHKALLA	FLETA
	"ERALD-G" Sh.p.k Rruga "Koli Bano" Tirane		Inxh. Gezim ISLAMI		Inxh. Aldo MERKAJ Inxh. Erindi GJOKA Top. Kujtim CANAMETI	Elek. Hajdar KURTI Mek. Arben MUHA Hidr. Ersida VERÇANI	Sh 1:25	10 - 05
						Tiranë 2018	Format A3	




### SHIGJETAT DREJTUESE



### SHKRIMI I FJALES STOP



<b>INVESTITORI: BASHKIA BULQIZE</b>
SISTEMIM ASFALTIM RRUGA LAGJA GJEOLUGU, BULQIZE

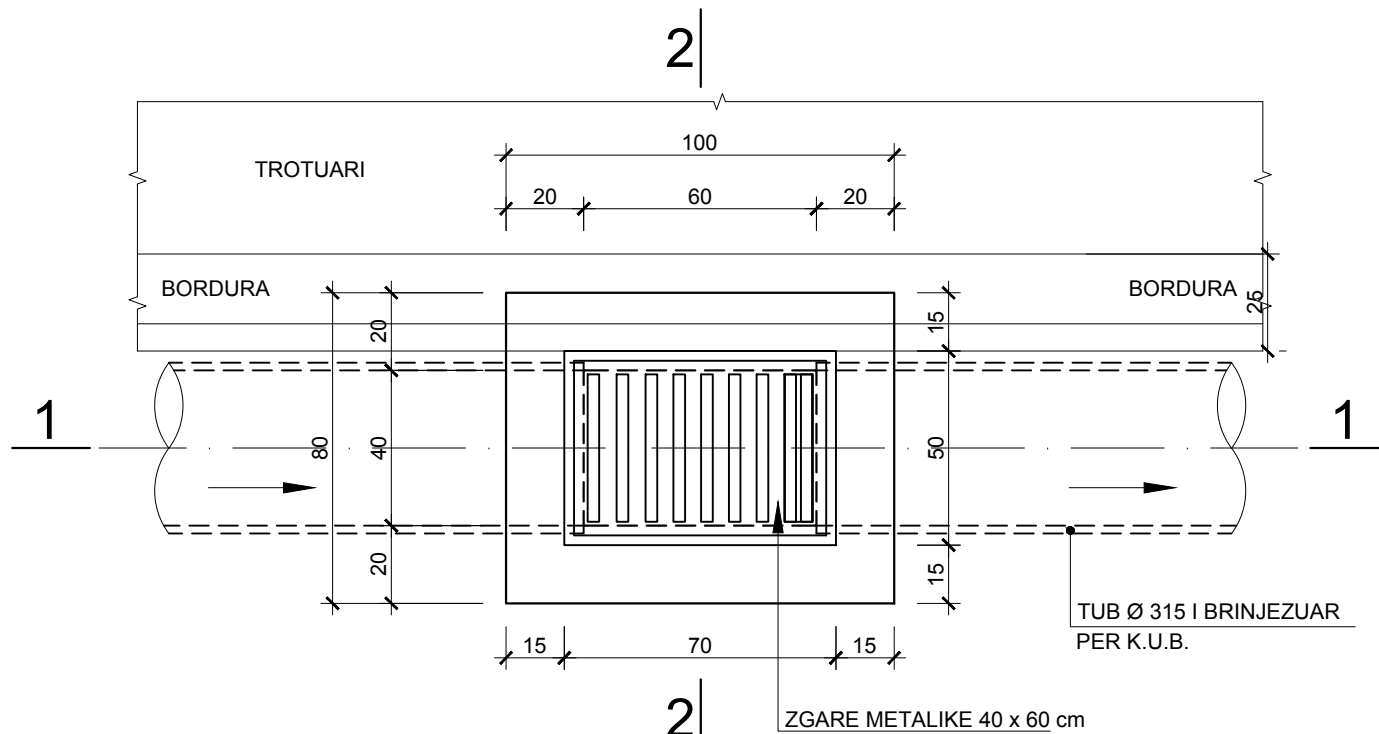
Emertimi: DETAJE
 "ERALD-G" Sh.p.k Rruga "Koli Bano" Tirane

Drejtues i projektit		Projektues	
Inxh. Gezim ISLAMI		Inxh. Aldo MERKAJ	Elek. Hajdar KURTI
		Inxh. Erindi GJOKA	Mek. Arben MUHA
		Top. Kujtim CANAMETI	Hidr. Ersida VERÇANI

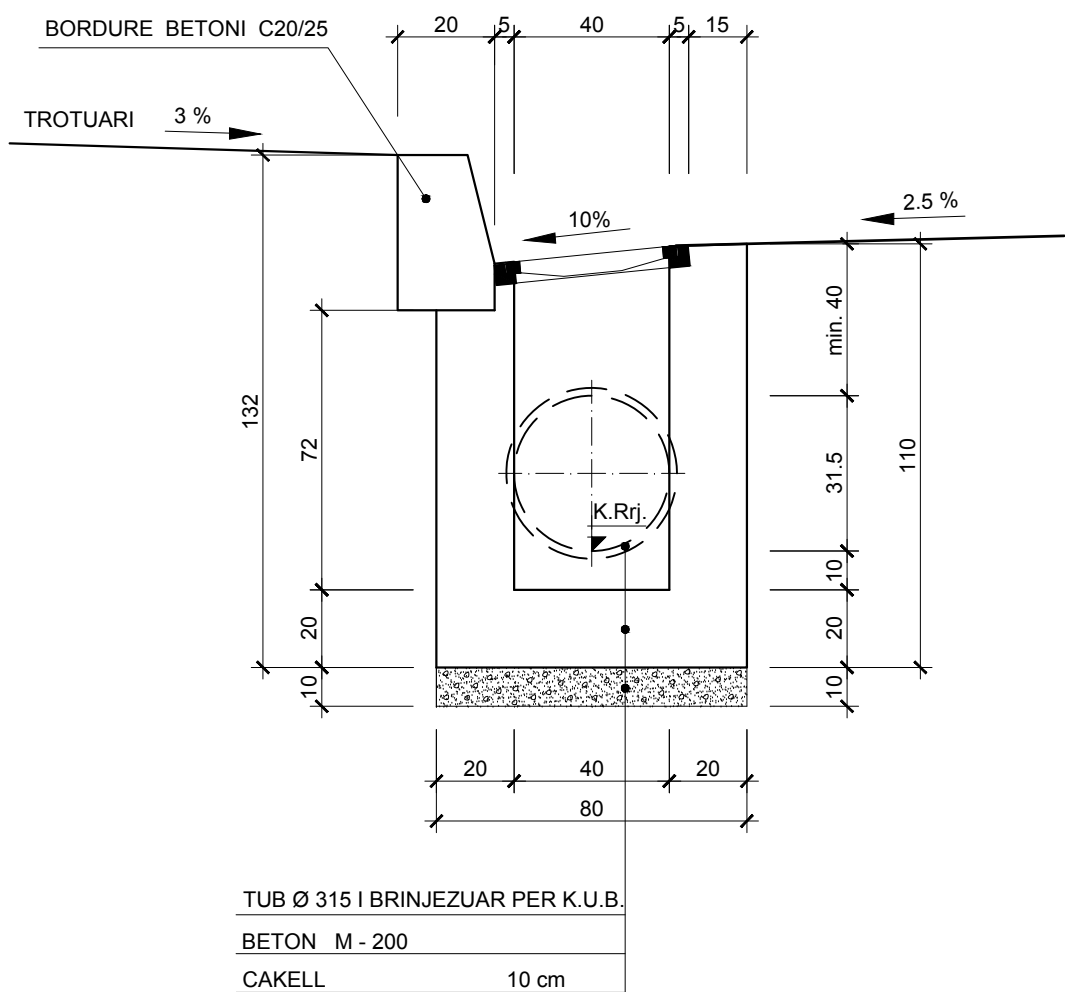
SHKALLA	FLETA
Sh 1:25	10 - 06
Tiranë 2018	Format A3

# PUSETE BETONI 40x60 cm ME ZGARE

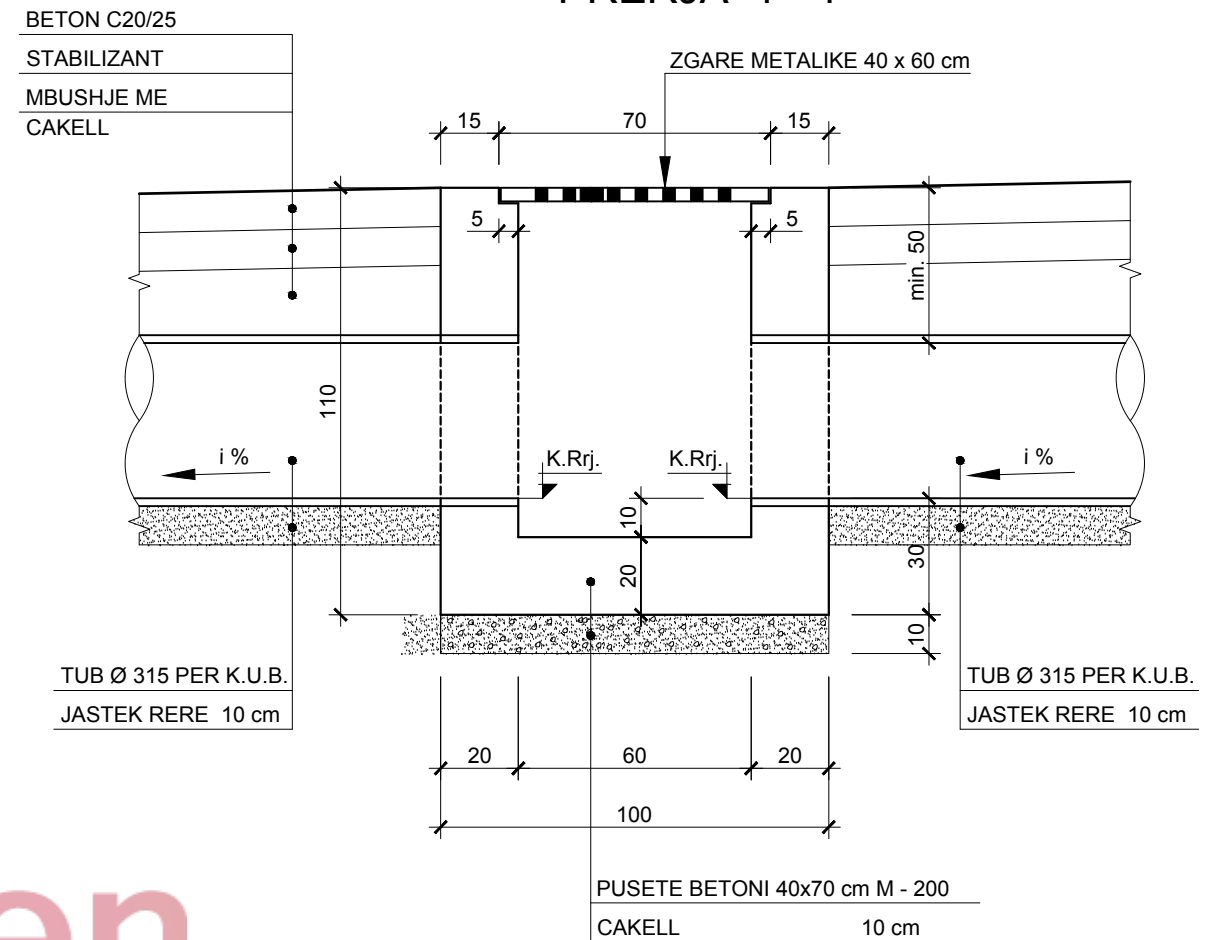
## PLANIMETRIA



## PRERJA 2 - 2



## PRERJA 1 - 1



Shenim: Detaji i pusetes se shiut eshte vendosur per detajin e kapakut te pusetes dhe lidhjen e tij me puseten ekzistuese. Cdo element tjetër i pusetes pervec kapakut eshte ekzistues

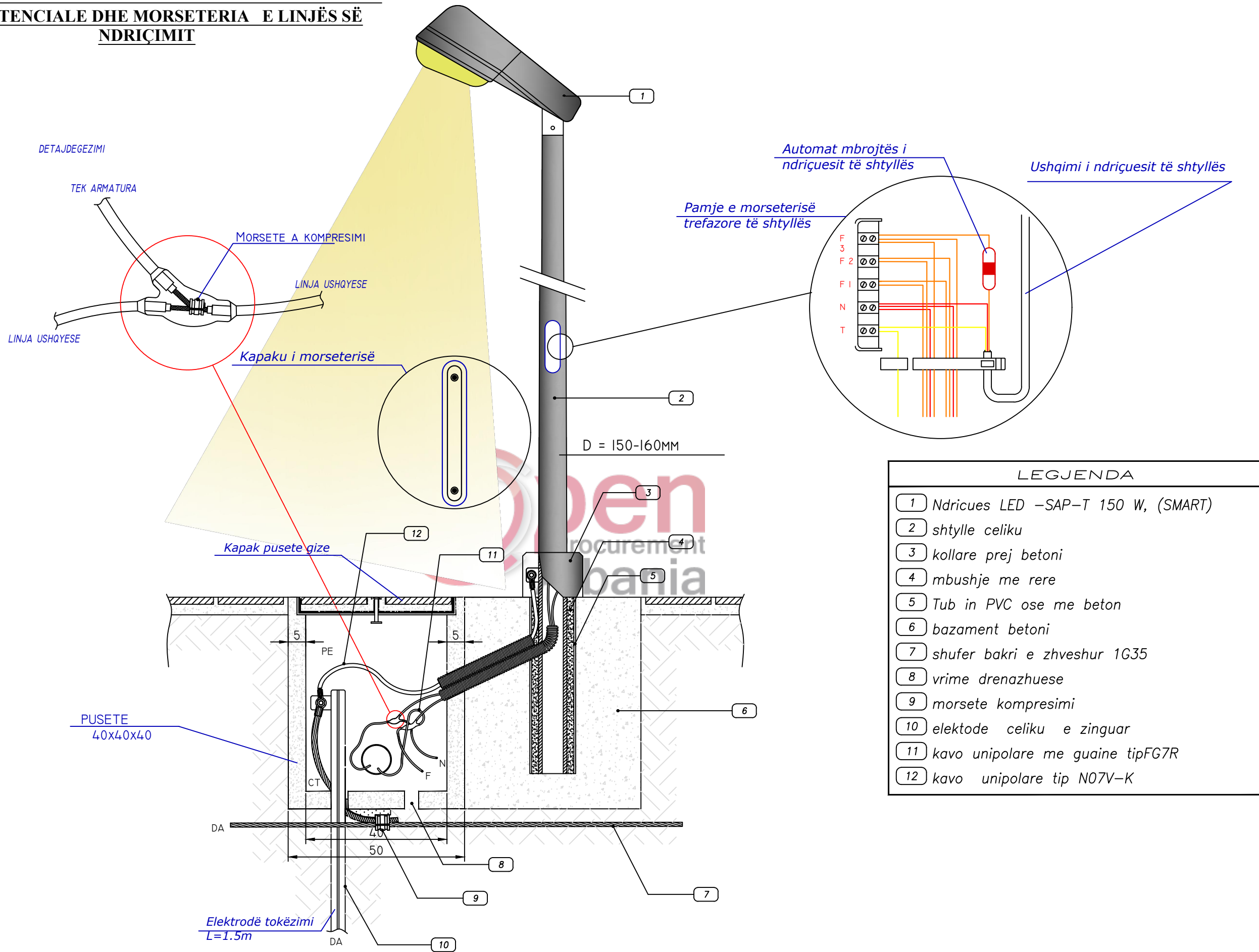
<b>INVESTITORI: BASHKIA BULQIZE</b>
SISTEMIM ASFALTIM RRUGA LAGJA GJELOGU, BULQIZE

Emertimi: DETAJE
 "ERALD-G" Sh.p.k. Rruga "Koli Bano" Tirane

Drejtes i projektit		Projektues	
Inxh. Gezim ISLAMI		Inxh. Aldo MERKAJ	Elek. Hajdar KURTI
		Inxh. Erindi GJOKA	Mek. Arben MUHA
		Top. Kujtim CANAMETI	Hidr. Ersida VERÇANI

SHKALLA	FLETA
Sh 1:25	10 - 07
Tiranë 2018	Format A3

**SHTYLLË ELEKTRIKE ME PUSËTË NË TOKË ME LIDHJE  
EKUIPOTENCIALE DHE MORSETERIA E LINJËS SË  
NDRIÇIMIT**



LEGJENDA	
1	Ndricules LED -SAP-T 150 W, (SMART)
2	shtylle celiku
3	kollare prej betoni
4	mbushje me rere
5	Tab in PVC ose me beton
6	bazament betoni
7	shufer bakri e zhveshur 1G35
8	vrime drenazhuese
9	morsete kompresimi
10	elektode celiku e zinguar
11	kavo unipolare me guaine tipFG7R
12	kavo unipolare tip N07V-K

**INVESTITORI: BASHKIA BULQIZE**  
SISTEMIM ASFALTIM RRUGA LAGJA GJEOLUGU, BULQIZE

Emertimi: DETAJE  
"ERALD-G" Sh.p.k  
Rruga "Koli Bano"  
Tirane

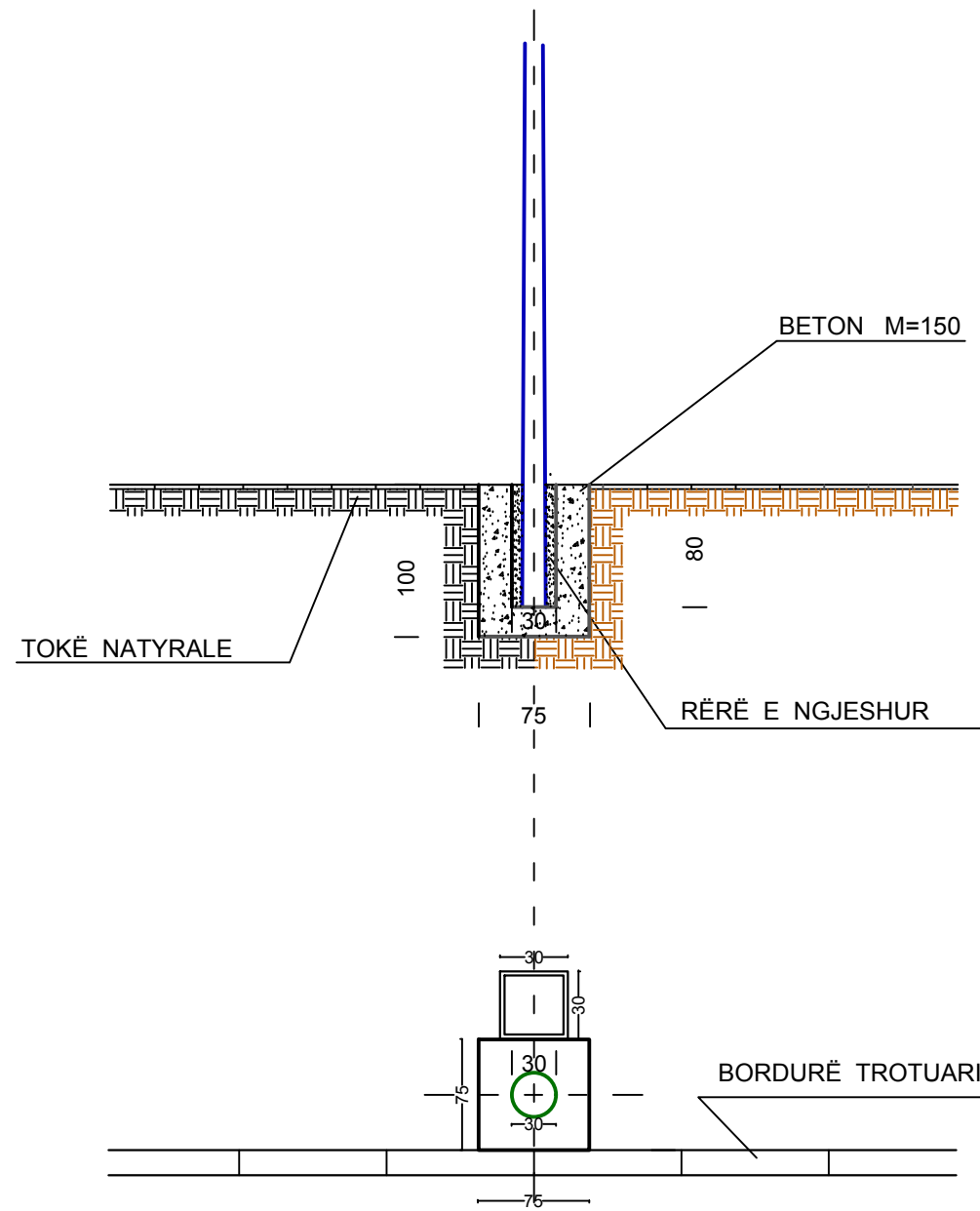
Drejtes i projektit  
Inxh. Gezim ISLAMI

Projektues  
Inxh. Aldo MERKAJ  
Inxh. Erindi GJOKA  
Top. Kujtim CANAMETI  
Elek. Hajdar KURTI  
Mek. Arben MUHA  
Hidr. Ersida VERÇANI

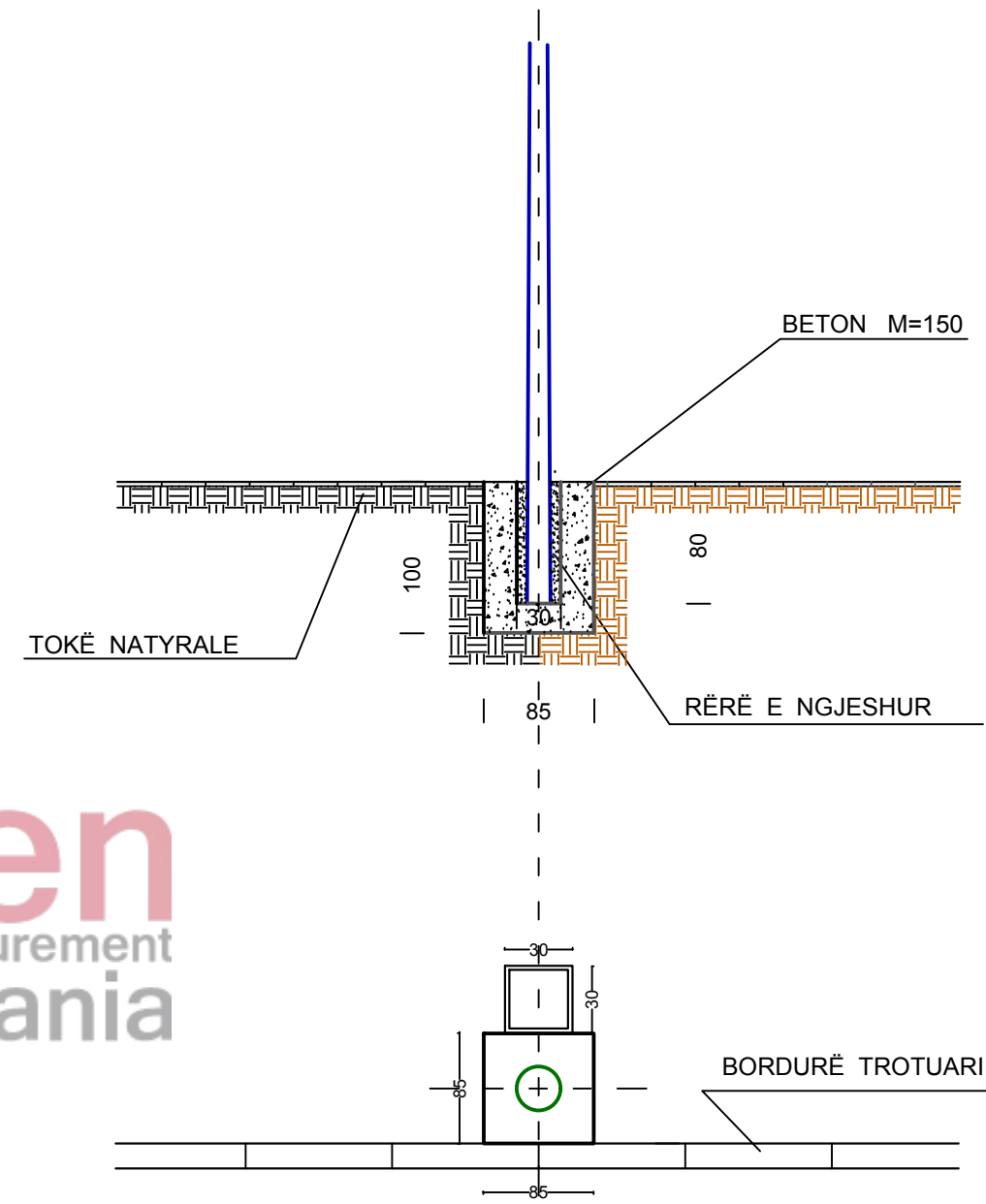
SHKALLA  
Sh 1:25  
Tiranë 2018  
FLETA  
10 - 08  
Format A3



Hollësi e inkastrimit të kolonës së ndriçesit me lartësi H=6.8/7.8m

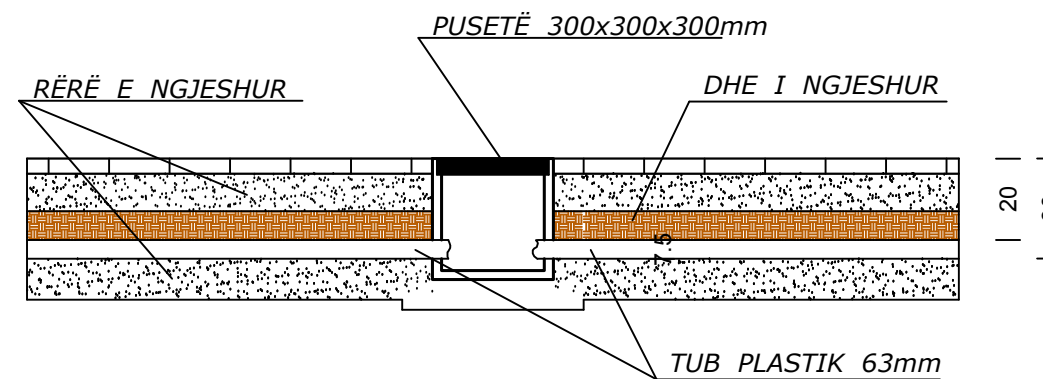


Hollësi e inkastrimit të kolonës së ndriçesit me lartësi H=8.8m



\*Dimensionet e paraqitura ne cm

Hollësi e vendosjes së pusetës



INVESTITORI: BASHKIA BULQIZE

SISTEMIM ASFALTIM RRUGA LAGJA GJEOLOGU, BULQIZE

Emertimi: DETAJE

"ERALD-G" Sh.p.k  
Rruga "Koli Bano"  
Tirane



Drejtuës i projektit

Inxh. Gezim ISLAMI

Projektues

Inxh. Aldo MERKAJ

Inxh. Erindi GJOKA

Top. Kujtim CANAMETI

Elek. Hajdar KURTI

Mek. Arben MUHA

Hidr. Ersida VERÇANI

SHKALLA

Sh 1:25

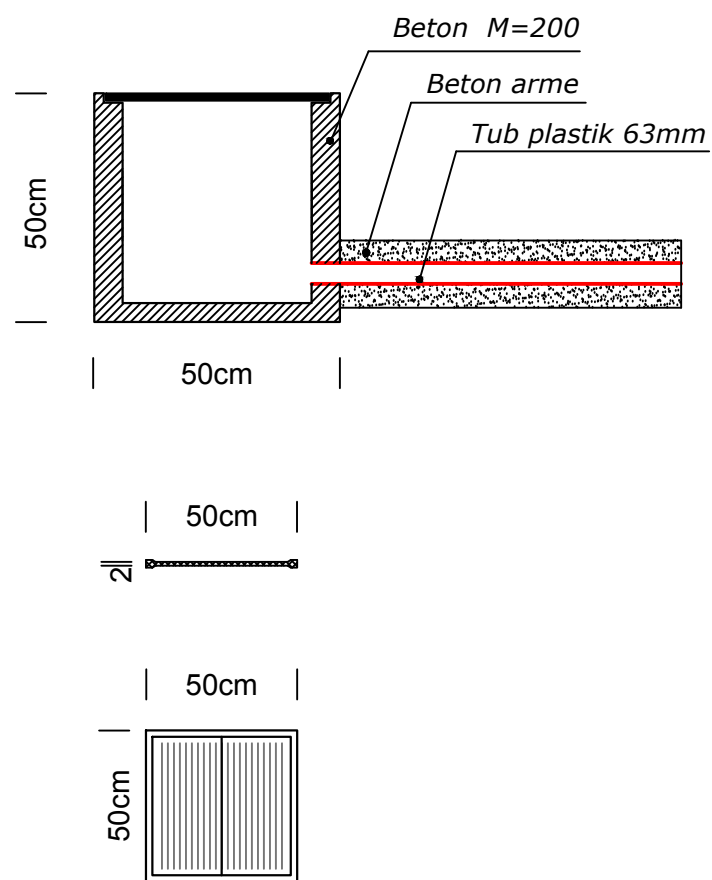
Tiranë 2018

FLETA

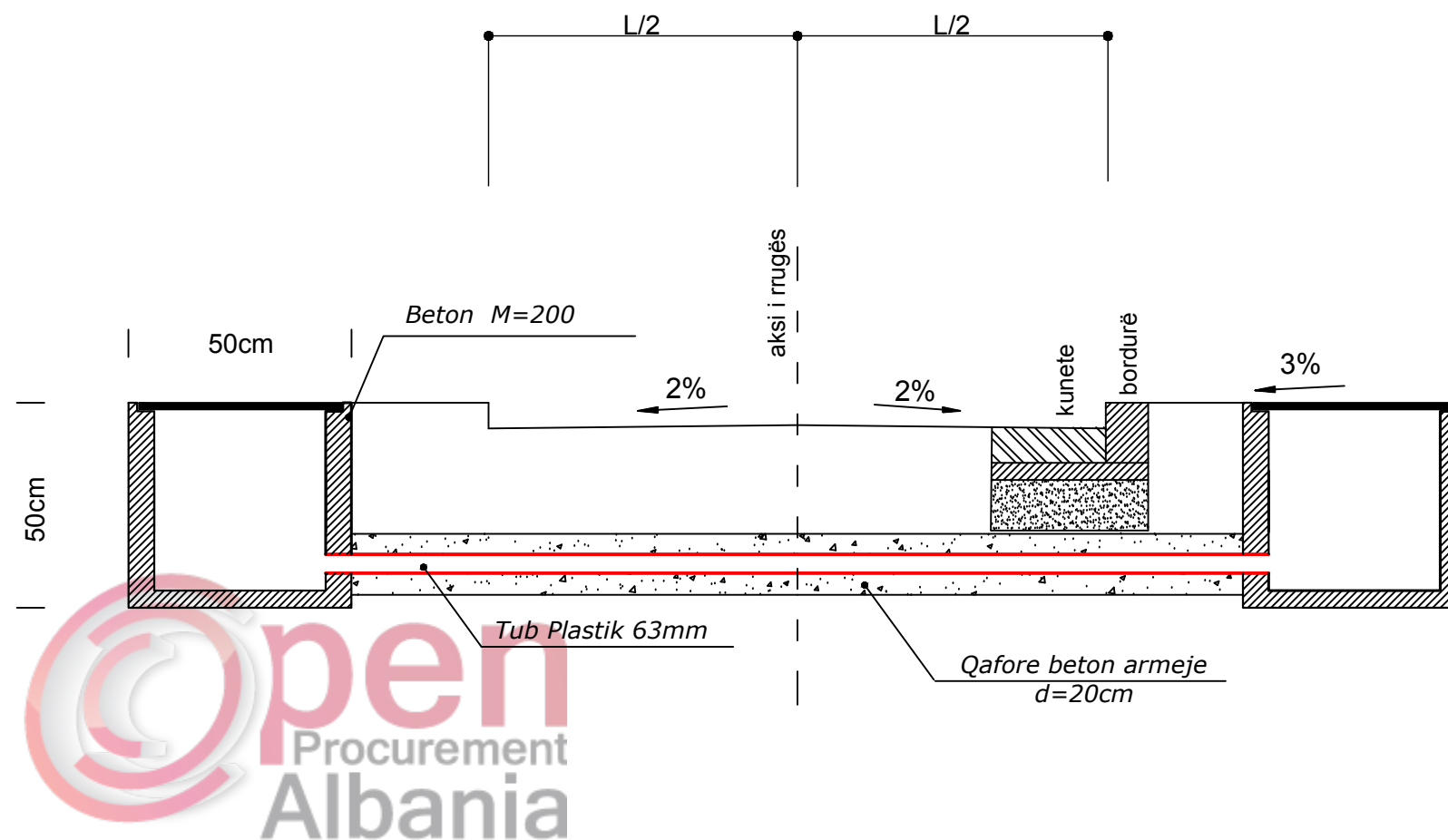
10 - 09

Format A3

## Kapaku i pusetës prej plastike



## Prerje e vendosjes së pusetave



### SHËNIME :

- Gjatë realizimit të intersektimeve kuota e vendosjes së pusetave mund të ndryshojë sipas rastit
- Tubi mund të vendoset me një pjerrësi të lehtë sipas nevojës , por gjithnjë thellësia minimale e vendosjes duhet te jete 50cm nga sip. e asfaltit.

## Kapaku i pusetës prej plastike

INVESTITORI: BASHKIA BULQIZE

SISTEMIM ASFALTIM RRUGA LAGJA GJELOGU, BULQIZE

Emertimi: DETAJE



"ERALD-G" Sh.p.k  
Rruga "Koli Bano"  
Tirane

Drejtes i projektit

Inxh. Gezim ISLAMI

Projektues

Inxh. Aldo MERKAJ

Inxh. Erindi GJOKA

Top. Kujtim CANAMETI

Elek. Hajdar KURTI

Mek. Arben MUHA

Hidr. Ersida VERÇANI

SHKALLA

Sh 1:25

Tiranë 2018

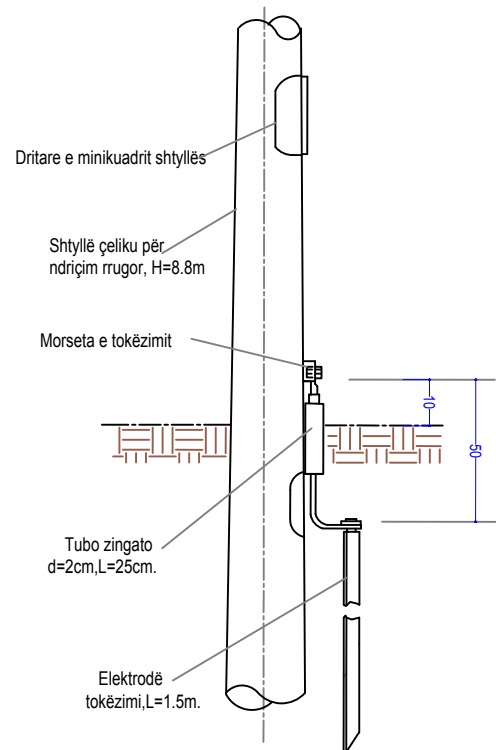
FLETA

10 - 10

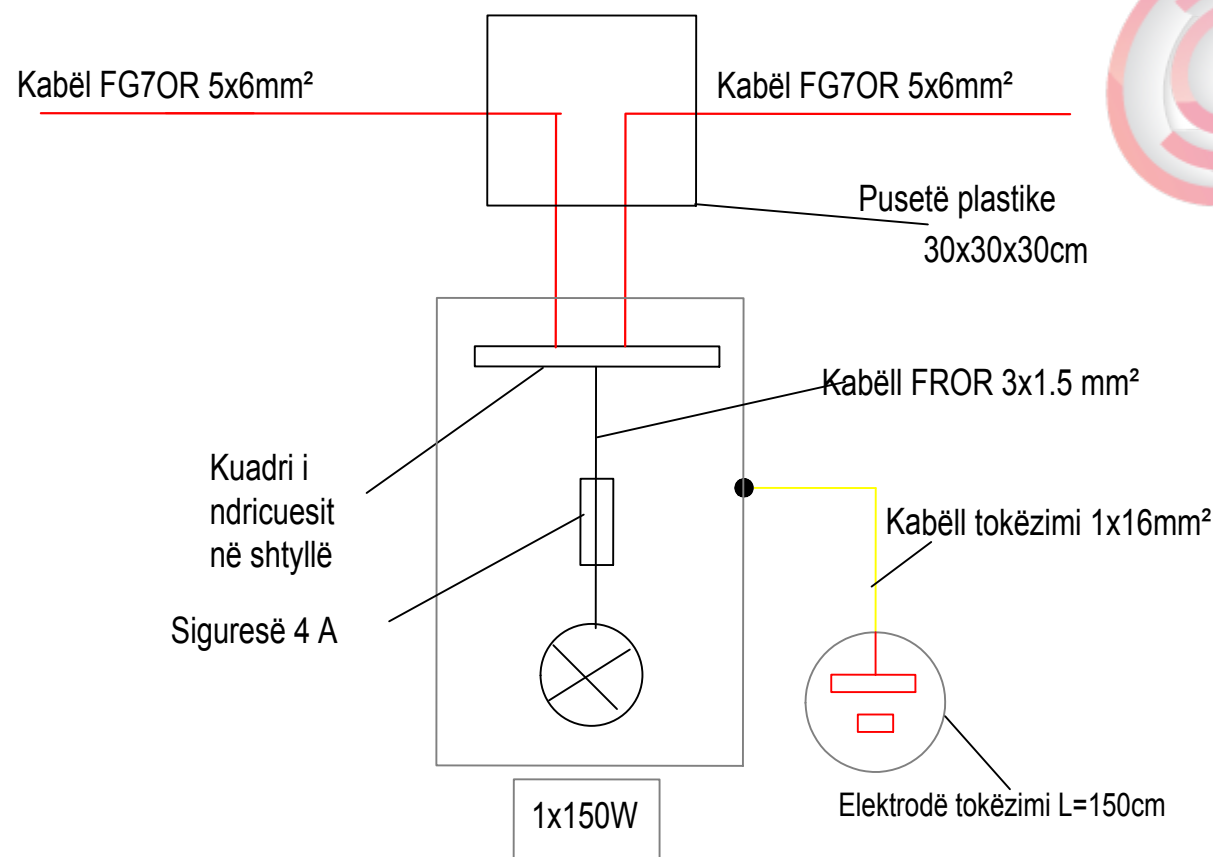
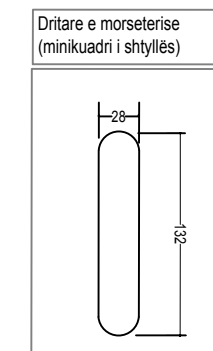
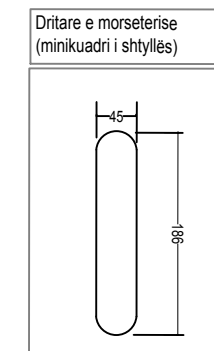
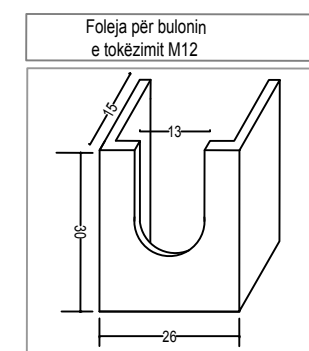
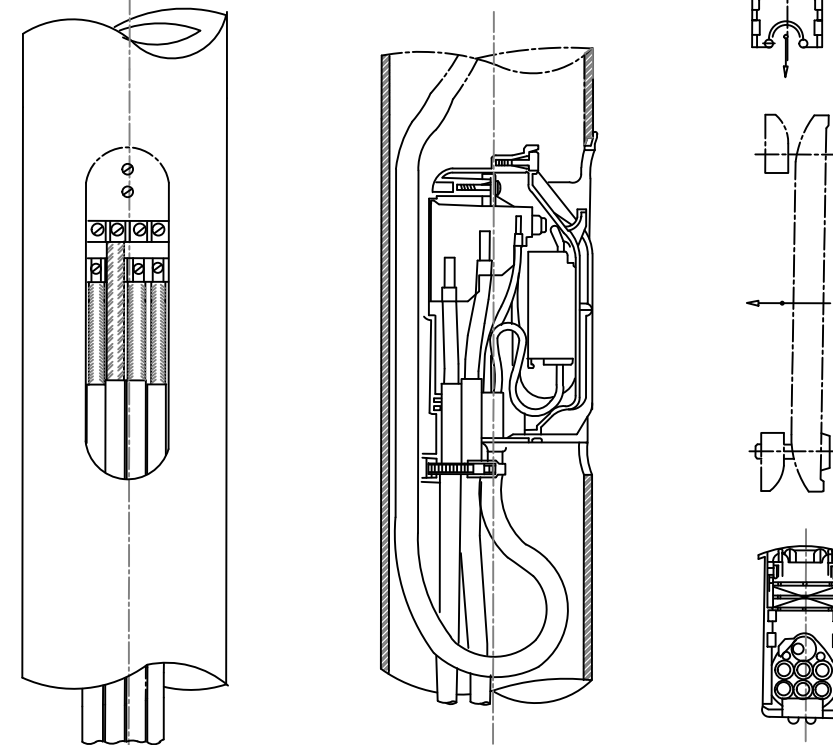
Format A3

\*Dimensionet e paraqitura ne cm

### Detaj i tokëzimit të shtyllës së ndriçimit



### Konstruksioni morseterisë



INVESTITORI: BASHKIA BULQIZE

SISTEMIM ASFALTIM RRUGA LAGJA GJEOLOGU, BULQIZE

Emertimi: DETAJE



"ERALD-G" Sh.p.k  
Rruga "Koli Bano"  
Tirane

Drejtes i projektit

Inxh. Gezim ISLAMI

Projektues

Inxh. Aldo MERKAJ

Elek. Hajdar KURTI

Inxh. Erindi GJOKA

Mek. Arben MUHA

Top. Kujtim CANAMETI

Hidr. Ersida VERÇANI

SHKALLA

Sh 1:25

Tiranë 2018

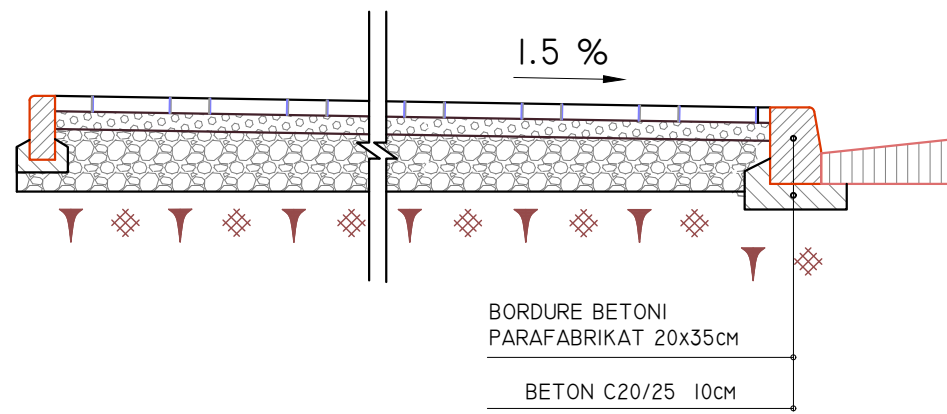
FLETA

10 - 11

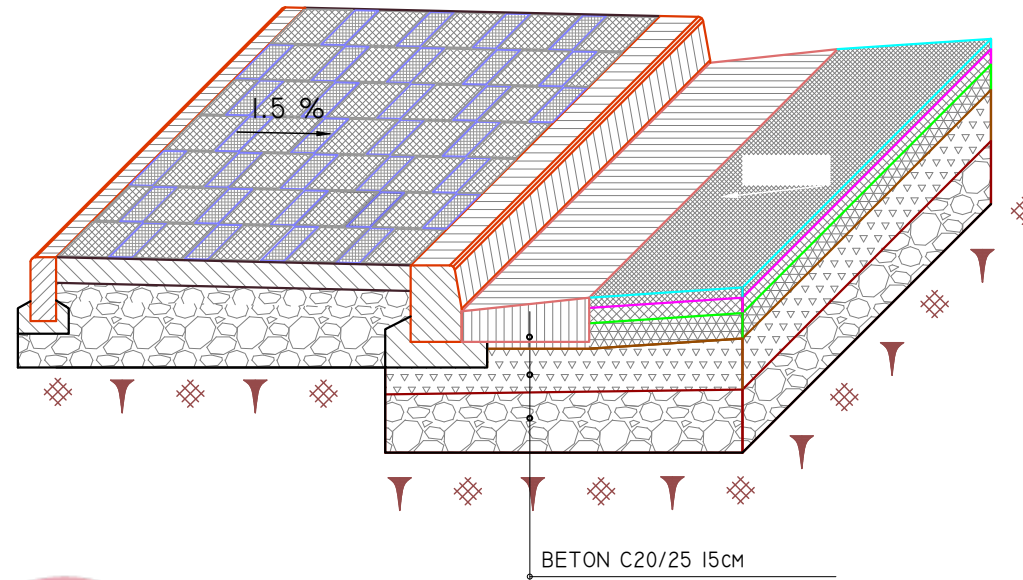
Format A3

# TROTUARI, BORDURAT DHE KUNETA

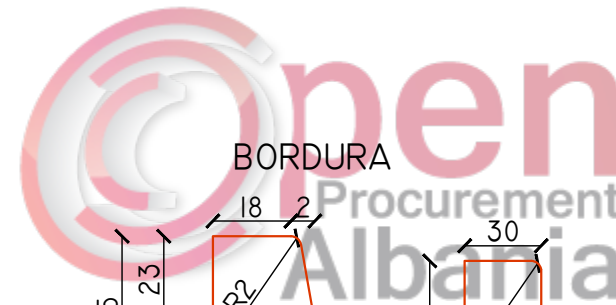
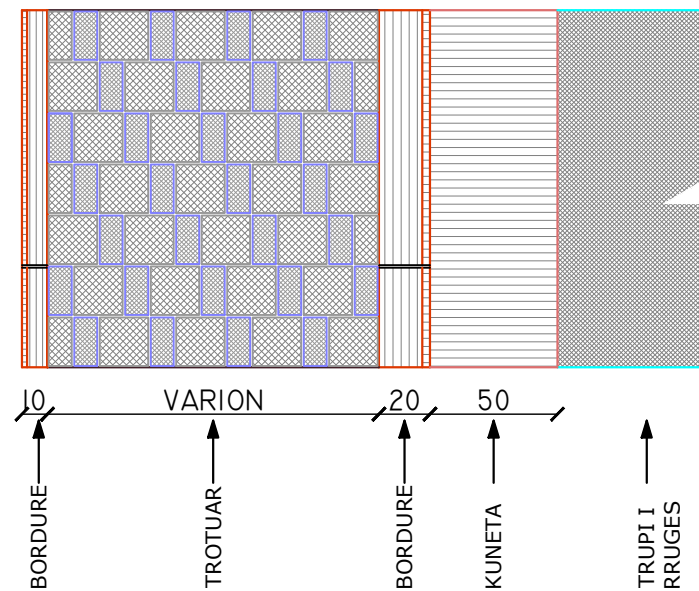
PRERJE E TROTUARIT



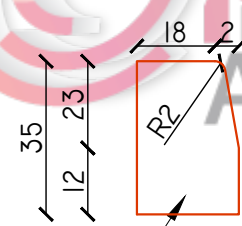
PAMJE E BORDURAVE DHE TROTUARIT



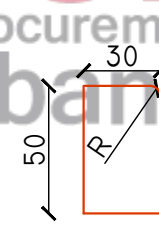
PLAN  
PLANIMETRIA



BORDURA

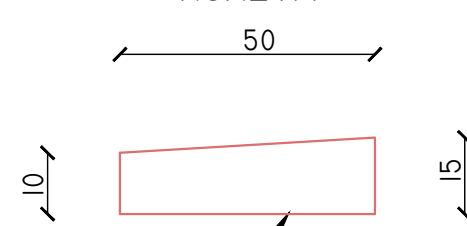


BORDURE PARAFABRIKAT  
BETON C20/25



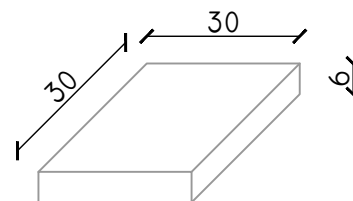
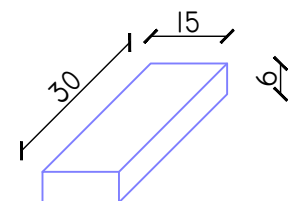
BORDURE PARAFABRIKAT  
BETON C20/25

KUNETA



BETON MONOLIT  
C20/25

PLLAKAT



INVESTITORI: BASHKIA BULQIZE

SISTEMIM ASFALTIM RRUGA LAGJA GJEOLUGU, BULQIZE

Emertimi: DETAJE



"ERALD-G" Sh.p.k  
Rruga "Koli Bano"  
Tirane

Drejtes i projektit

Inxh. Gezim ISLAMI

Projektues

Inxh. Aldo MERKAJ

Elek. Hajdar KURTI

Inxh. Erindi GJOKA

Mek. Arben MUHA

Top. Kujtim CANAMETI

Hidr. Ersida VERÇANI

SHKALLA

Sh 1:25

Tiranë 2018

FLETA

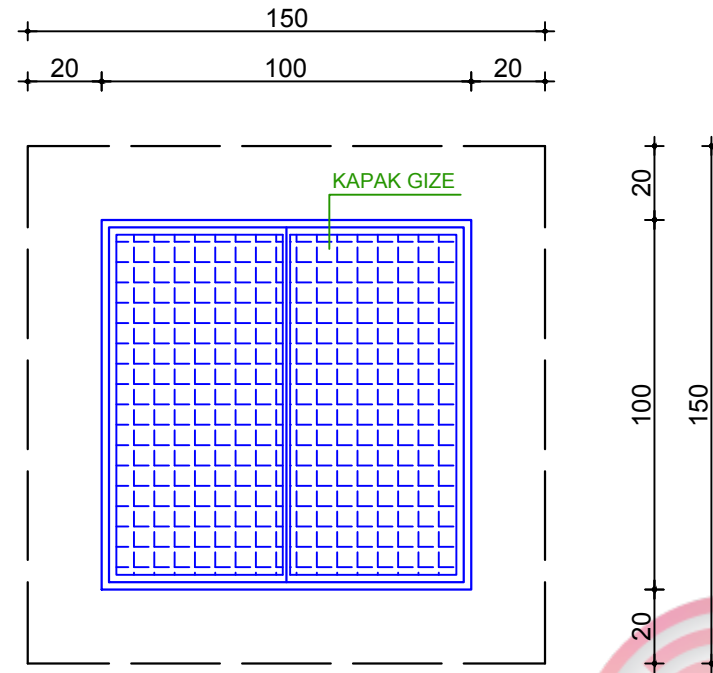
10 - 12

Format A3

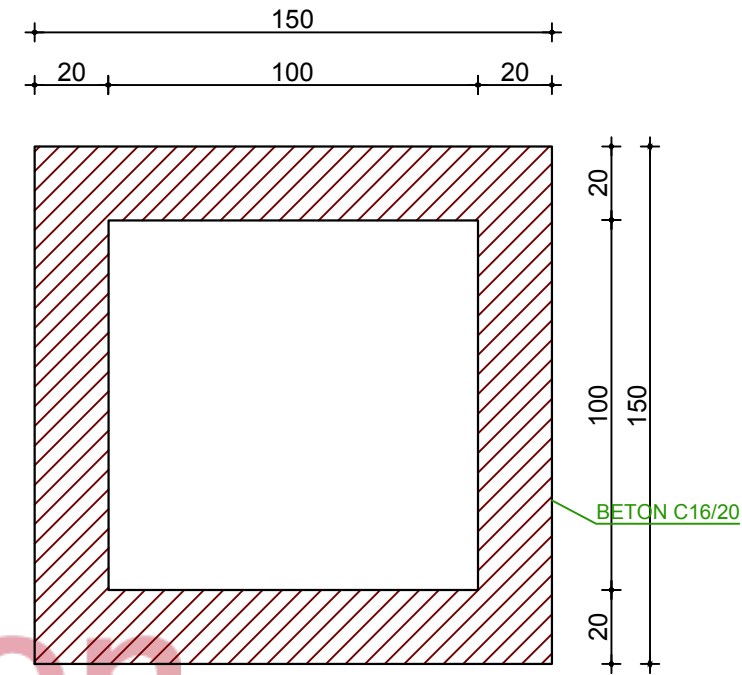


# PUSETA TIP E ELEKTRIKUT

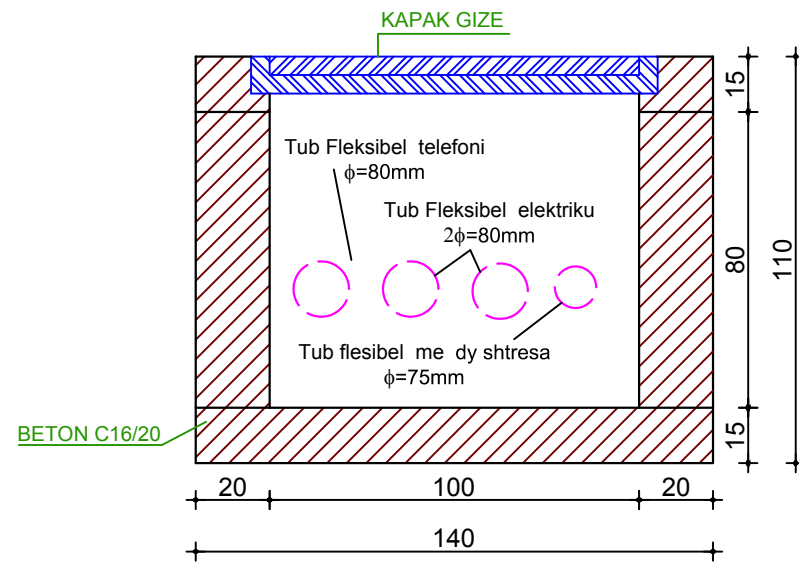
PAMJE NGA SIPER SH 1:20



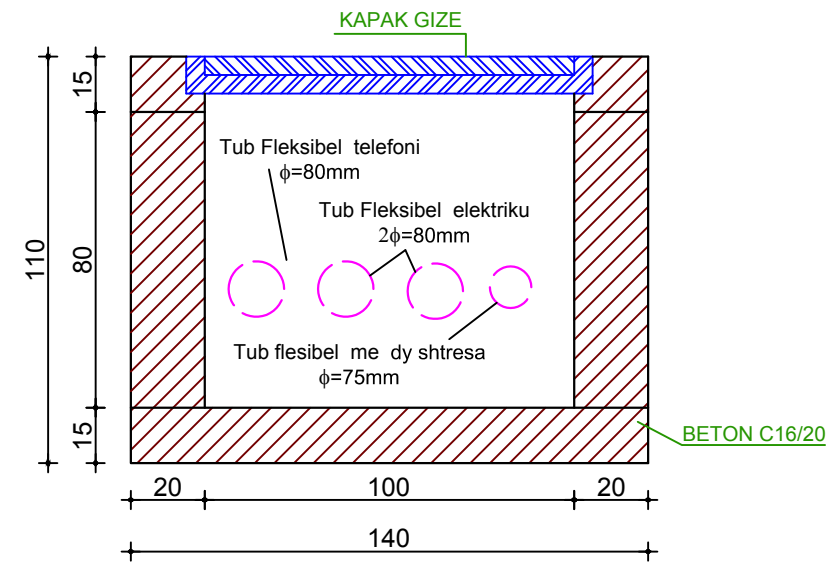
PLANIMETRI SH 1:20



PUSET KRAHU MAJTE SH 1:20



PUSET KRAHU DJATHE SH 1:20



INVESTITORI: BASHKIA BULQIZE

SISTEMIM ASFALTIM RRUGA LAGJA GJEOLUGU, BULQIZE

Emertimi: DETAJE



"ERALD-G" Sh.p.k  
Rruga "Koli Bano"  
Tirane

Drejtes i projektit

Inxh. Gezim ISLAMI

Projektues

Inxh. Aldo MERKAJ

Inxh. Erindi GJOKA

Top. Kujtim CANAMETI

Elek. Hajdar KURTI

Mek. Arben MUHA

Hidr. Ersida VERÇANI

SHKALLA

Sh 1:20

Tiranë 2018

FLETA

10 - 13

Format A3