



Shenime

Legjenda:

- Asfalt ekzistues
- Mure rrethues
- Objekte
- Trotuar
- Platforme betoni
- Puseta
- Kunete
- Rrethim

Investitor  
Bashkia Shkoder



Emertimi i projektit  
RIKUALIFIKIM URBAN BILLOQE BANIMI  
"EUROPA",  
(TEK ISH-PODGORICA)

Faza e Projektit  
PROJEKT ZBATIM

Projekti i infrastrukturës

Konsulentit



Projektoi	Emer Mbiemer	Firma
Insh. Nderim	Vangjush MBRIÇE	
Insh. Nderim	Andren MBRIÇE	
Insh. Mekanik	Paskal JARAZI	
Insh. Gjeolog	Pellumb TOSKA	
Insh. Elektrik	Gazmir ISAKAJ	
Insh. Topograf	Nuredin HAMZAI	
Arkitekte	Gentjana CENGA	
Topograf	Eroglen MUCA	

Dwg.Nr. A1.00

Emertimi fletes:  
Horografia

Shkalla:  
A3 - 1:500

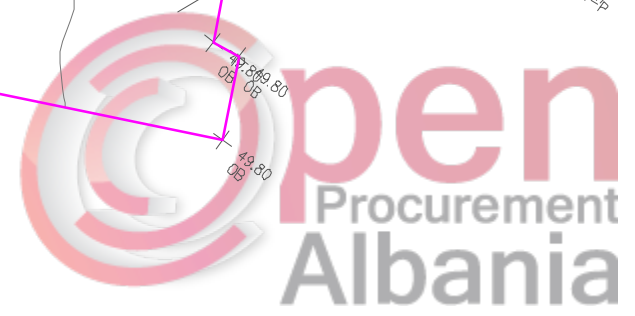
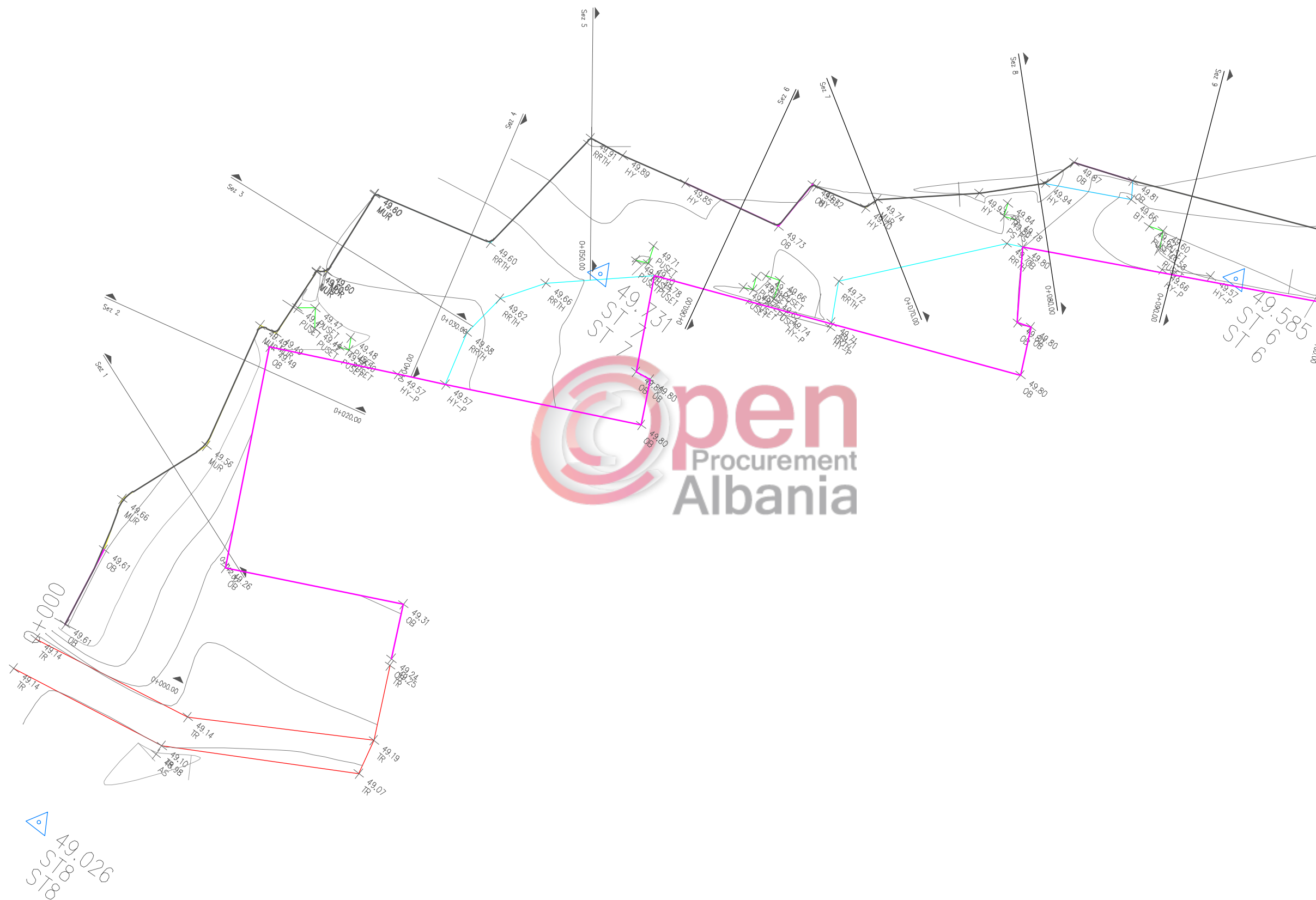

**Shenime**

**Legjenda:**

- Asfalt ekzistues
- Mure rrethues
- Objekte
- Trotuar
- Platforme betoni
- Puseta
- Kunete
- Rrethim

Investitor  
Bashkia Shkoder



Emertimi i projektit  
RIKUALIFIKIM URBAN BILLOQE BANIMI  
"EUROPA",  
(TEK ISH-PODGORICA)

Faza e Projektit  
PROJEKT ZBATIM

**Projekti i infrastruktures**

Konsulentit



Projektoi	Emer Mbiemer	Firma
Insh. Nderim	Vangjush MBRIÇE	
Insh. Nderim	Audien MBRIÇE	
Insh. Mekanik	Paskal JARAZI	
Insh. Gjeolog	Pellumb TOSKA	
Insh. Elektrik	Gazmir ISAKAJ	
Insh. Topograf	Nuredin HAMZAI	
Arkitekte	Gentjana CENGA	
Topograf	Eroglen MUCA	

Dwg.Nr. A1.02

Emertimi fletes:  
Planimetria ekzistuese

Shkalla:

A3 - 1:250

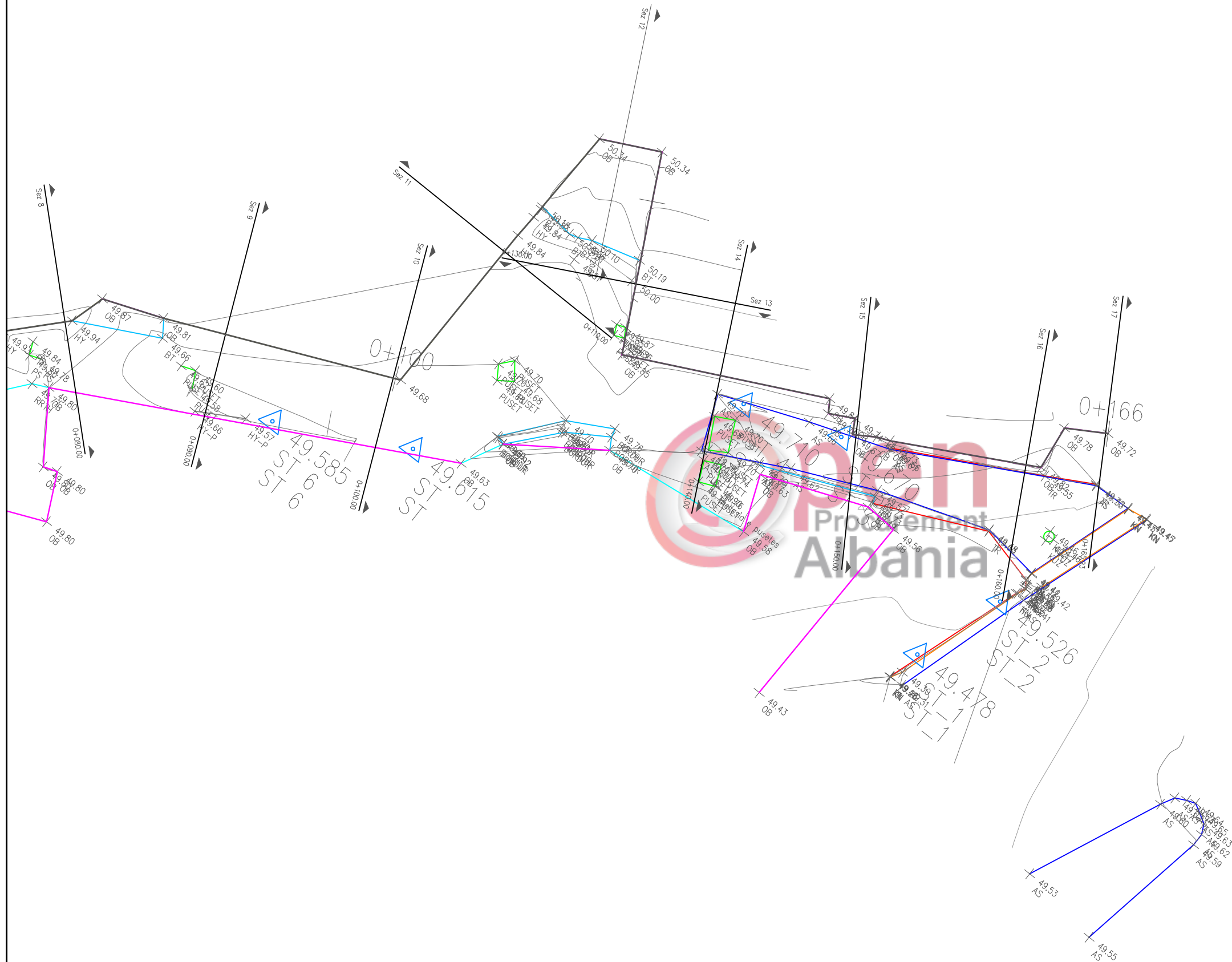

Shenime

Legjenda:

- Asfalt ekzistues
- Mure rrethues
- Objekte
- Trotuar
- Platforme betoni
- Puseta
- Kunete
- Rrethim

Investitor  
Bashkia Shkoder



Emertimi i projektit  
RIKUALIFIKIM URBAN BILLOQE BANIMI  
"EUROPA",  
(TEK ISH-PODGORICA)

Faza e Projektit  
PROJEKT ZBATIM

Projekti i infrastruktures

Konsulent



Projektoi	Emer	Mbiemer	Firma
Insh. Nderim	Vangjush	MBRIÇE	
Insh. Nderim	Andren	MBRIÇE	
Insh. Mekanik	Paskal	JARAZI	
Insh. Gjeolog	Pellumb	TOSKA	
Insh. Elektrik	Gazmir	ISAKAJ	
Insh. Topograf	Nuredin	HAMZAI	
Arkitekte	Genjane	CENGA	
Topograf	Eroglan	MUCA	

Dwg.Nr. A1.03

Emertimi fletes:  
Planimetria ekzistuese



Shkalla:  
A3 - 1:250



Shenime

Legjenda:

- Tub Ø 315 per KUB
- Tub Ø 315 per KUZ
- Tub Ø 63 per rrjetin e ujesjellesit

-  Pusete e ujrave te bardha
-  Pusete e ujrave te zeza
-  Pusete ujesjellesi

Investitor  
Bashkia Shkoder



Emertimi i projektit  
RIKUALIFIKIM URBAN BILLOQE BANIMI  
"EUROPA",  
(TEK ISH-PODGORICA)

Faza e Projektit  
PROJEKT ZBATIM

Projekti i infrastruktures

Konsulent  
**C.E.C Group**  
Civil Engineering Consultants

Projektoi	Emer Mbiemer	Firma
Insh. Nderim	Vangjosh MBRICË	
Insh. Nderim	Andren MBRICË	
Insh. Mekanik	Paskal JARAZI	
Insh. Gjeolog	Pellumb TOSKA	
Insh. Elektrik	Gazmir ISAKAJ	
Insh. Topograf	Nuredin HAMZAI	
Arkitekte	Gentjana CENGA	
Topograf	Eroglan MUCA	

Dwg.Nr. B1.01

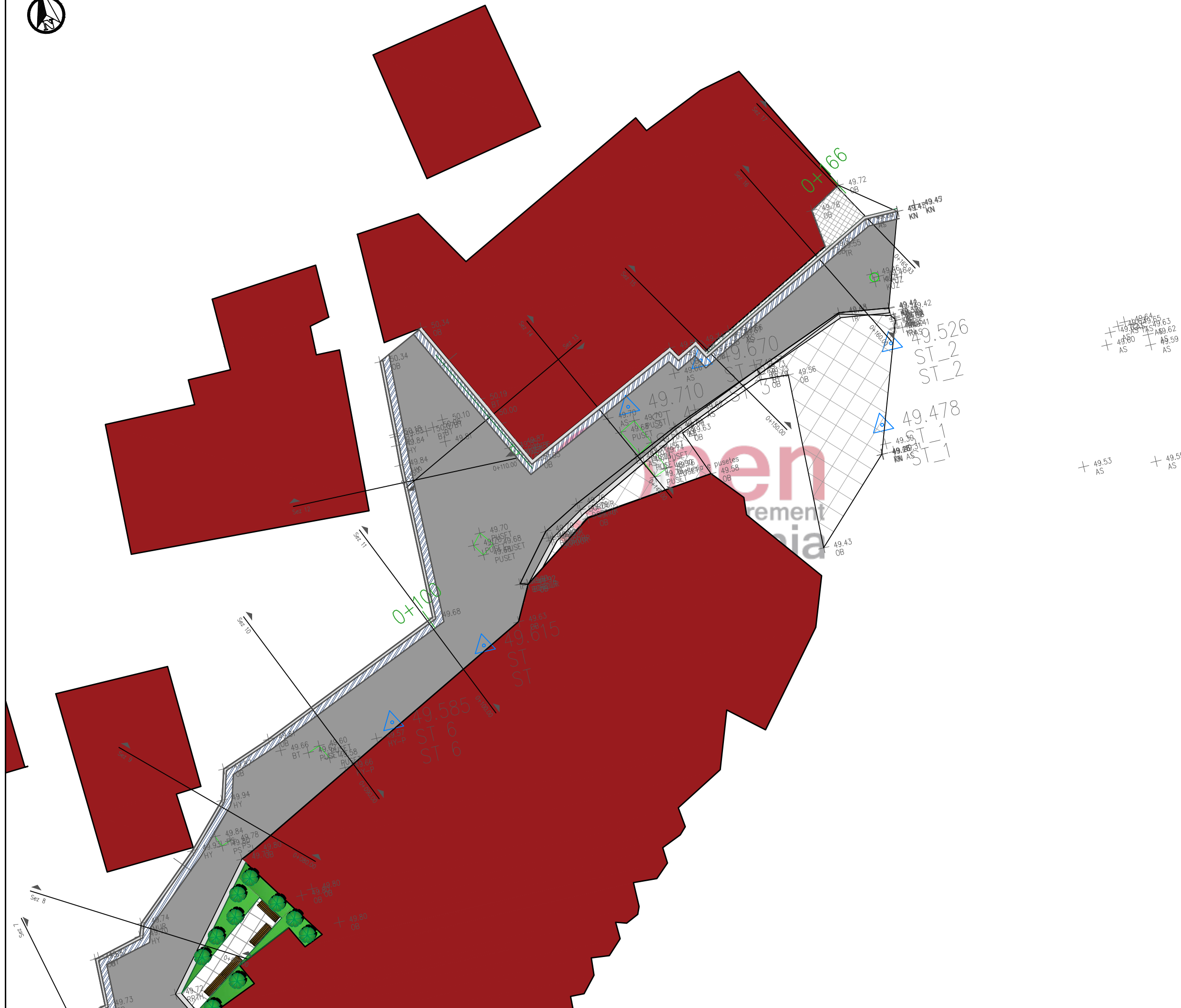

Emertimi fletes:  
Planimetria

Shkalla:  
A3 - 1:250



Shenime

Legjenda:

- Tub Ø 315 per KUB
- Tub Ø 315 per KUZ
- Tub Ø 63 per rrjetin e ujesjellesit
-  Pusete e ujrave te bardha
-  Pusete e ujrave te zeza
-  Pusete ujesjellesi

Investitor  
Bashkia Shkoder



Emertimi i projektit  
RIKUALIFIKIM URBAN BLOQE BANIMI  
"EUROPA",  
(TEK ISH-PODGORICA)

Faza e Projektit  
PROJEKT ZBATIM

Projekti i infrastruktures

Konsulent



Projektoi	Emer Mbiemer	Firma
Insh. Nderim	Vangjush MBRIÇE	
Insh. Nderim	Andrien MBRIÇE	
Insh. Mekanik	Paskal JARAZI	
Insh. Gjeolog	Pellumb TOSKA	
Insh. Elektrik	Gazmir ISAKAJ	
Insh. Topograf	Nuredin HAMZAI	
Arktekte	Gentjana CENGA	
Topograf	Eroglen MUCA	

Dwg.Nr. B1.02

Emertimi fletes:  
Planimetria

Shkalla:  
A3 - 1:250

# NIVELETA

Profili gjatesor  
Shk. : 500:50  
K.Ref. : 40.00

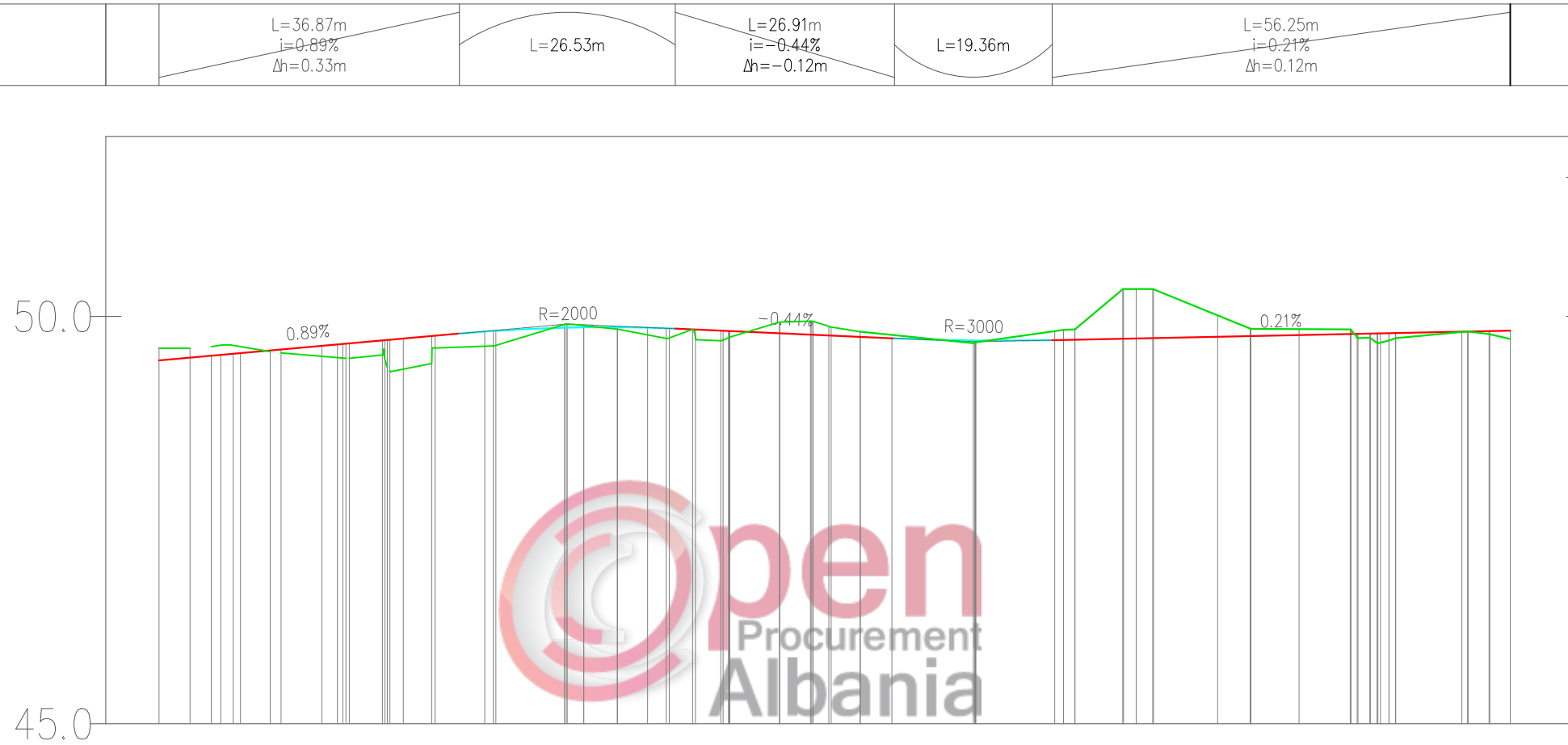

NUMRI I SEKSIONIT	1	2	3	4	5	6	7	8	9	10	11	12	13	14	15	16	17	18
DISTANCE PROGRESIVE	0+000.00	0+010.00	0+020.00	0+030.00	0+040.00	0+050.00	0+060.00	0+070.00	0+080.00	0+090.00	0+100.00	0+110.00	0+120.00	0+130.00	0+140.00	0+150.00	0+160.00	0+165.93
DISTANCE PJESORE		10,00	10,00	10,00	10,00	10,00	10,00	10,00	10,00	10,00	10,00	10,00	10,00	10,00	10,00	10,00	10,00	5,93
KUOTE PROJEKTI	49.46	49.55	49.64	49.73	49.82	49.86	49.86	49.82	49.78	49.73	49.71	49.71	49.73	49.75	49.77	49.79	49.81	49.83
KUOTE TERRENI	49.61	49.63	49.51	49.35	49.64	49.91	49.78	49.74	49.94	49.77	49.67	49.82	50.34	50.02	49.85	49.68	49.81	49.72
KILOMETRAZHI	00										01						02	

## Shenime

Investitor  
BASHKIA SHKODER



Emertimi i PROJEKTTIT  
RIKUALIFIKIM URBAN BLOQE BANIMI  
"EUROPA",  
(TEK ISH-PODGORICA)

Faza e PROJEKTTIT  
PROJEKT ZBATIM

### Projekti i infrastruktures

Konsulent  
**C.E.C Group**  
Civil Engineering Consultants

Projektoi	Emer Mbiemer	Firma
Insh. Nderim	Vangjush MBRICË	
Insh. Nderim	Andren MBRICË	
Insh. Mekanik	Paskal JARAZI	
Insh. Gjeolog	Pellumb TOSKA	
Insh. Elektrik	Gazmir ISAKAJ	
Insh. Topograf	Nuredin HAMZAI	
Arkitekte	Gentjana CENGA	
Topograf	Eroglan MUCA	

Dwg.Nr. C1.01

Emertimi fletes:  
Profili gjatesor

Shkalla:

A3 - 1:750

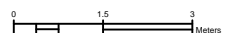

Mat. Per progr 0+000.00			
Materiale	Area (m2)	Vol (m3)	Vol Cum (m3)
Germim	6.07	0	0
Mbushje	0	0	0

Seksioni nr. 1  
 Progr : 0+000.00  
 Shkalla : 100:100  
 K.Ref. : 47.00

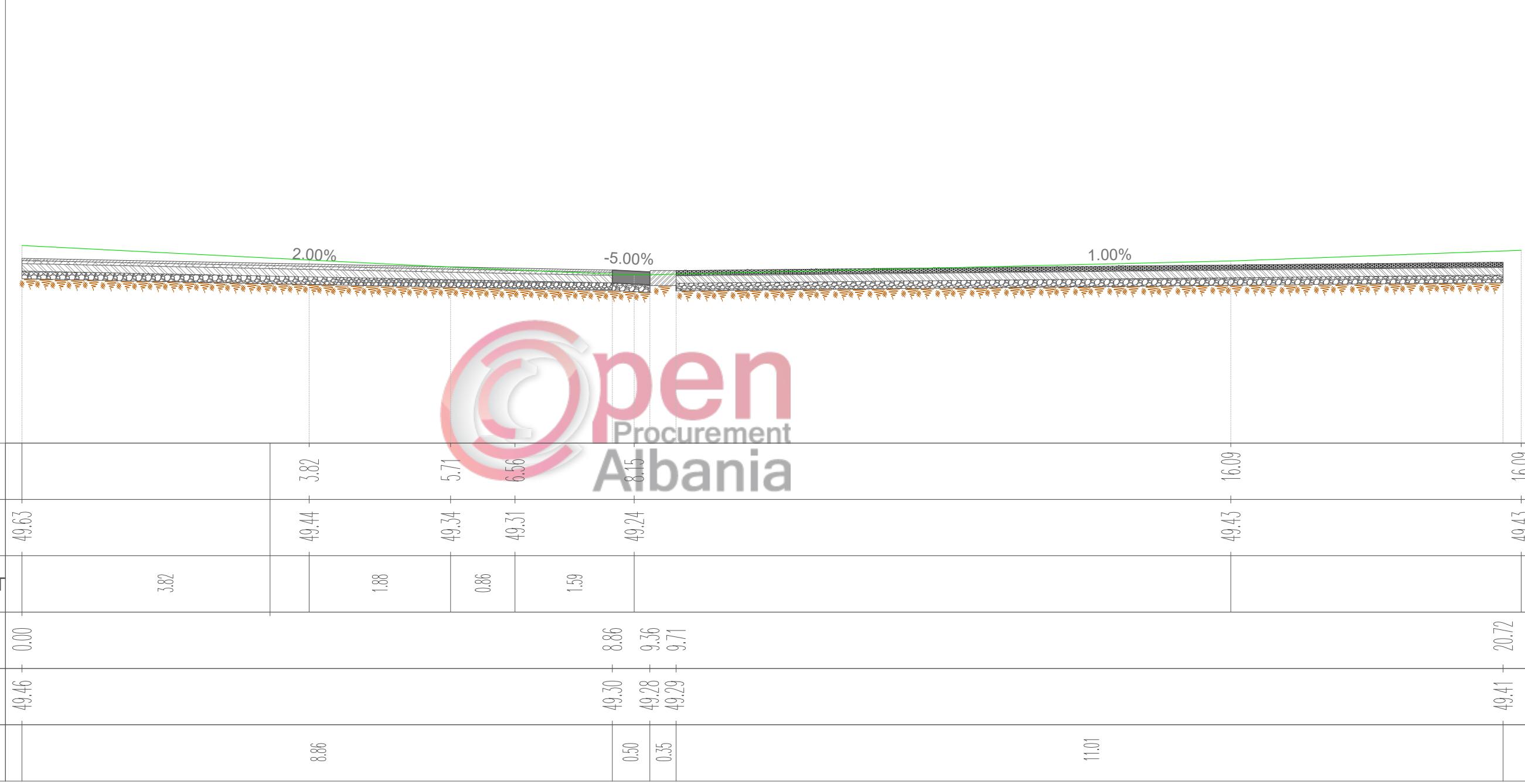

**Shenime**

Investitor  
**BASHKIA SHKODER**

Emertimi i PROJEKTTIT  
**RIKUALIFIKIM URBAN BILLOQE BANIMI "EUROPA", (TEK ISH-PODGORICA)**

Faza e PROJEKTTIT  
**PROJEKT ZBATIM**

**PROJEKTI I infrastruktures**

Konsulentit  
**C.E.C Group**  
 Civil Engineering Consultants

Projektori	Emri Mbiemri	Firma
Emri Nderim	Vangjush ABRUÇE	
Emri Nderim	Andren ABRUÇE	
Emri Mekanik	Pashaj JARVAZI	
Emri Gjeolog	Bullumbi TOSKA	
Emri Elektrik	Gorani ISAKUJ	
Emri Topograf	Nusidan HAMZAJ	
Arditësi	Gentiana CENGA	
Topograf	Ervelin MUÇA	

Dwg.Nr: D1.01

Emertimi fletes:  
 Profiliat terthore progressive

Shkalla:  
**A3 - 1:50**



Mat. Per progr 0+012.00			
Materiale	Area (m2)	Vol (m3)	Vol Cum (m3)
Germim	1.53	45.6	45.6
Mbushje	0	0	0

Seksioni nr. 2  
 Progr : 0+012.00  
 Shkalla : 100:100  
 K.Ref. : 47.00

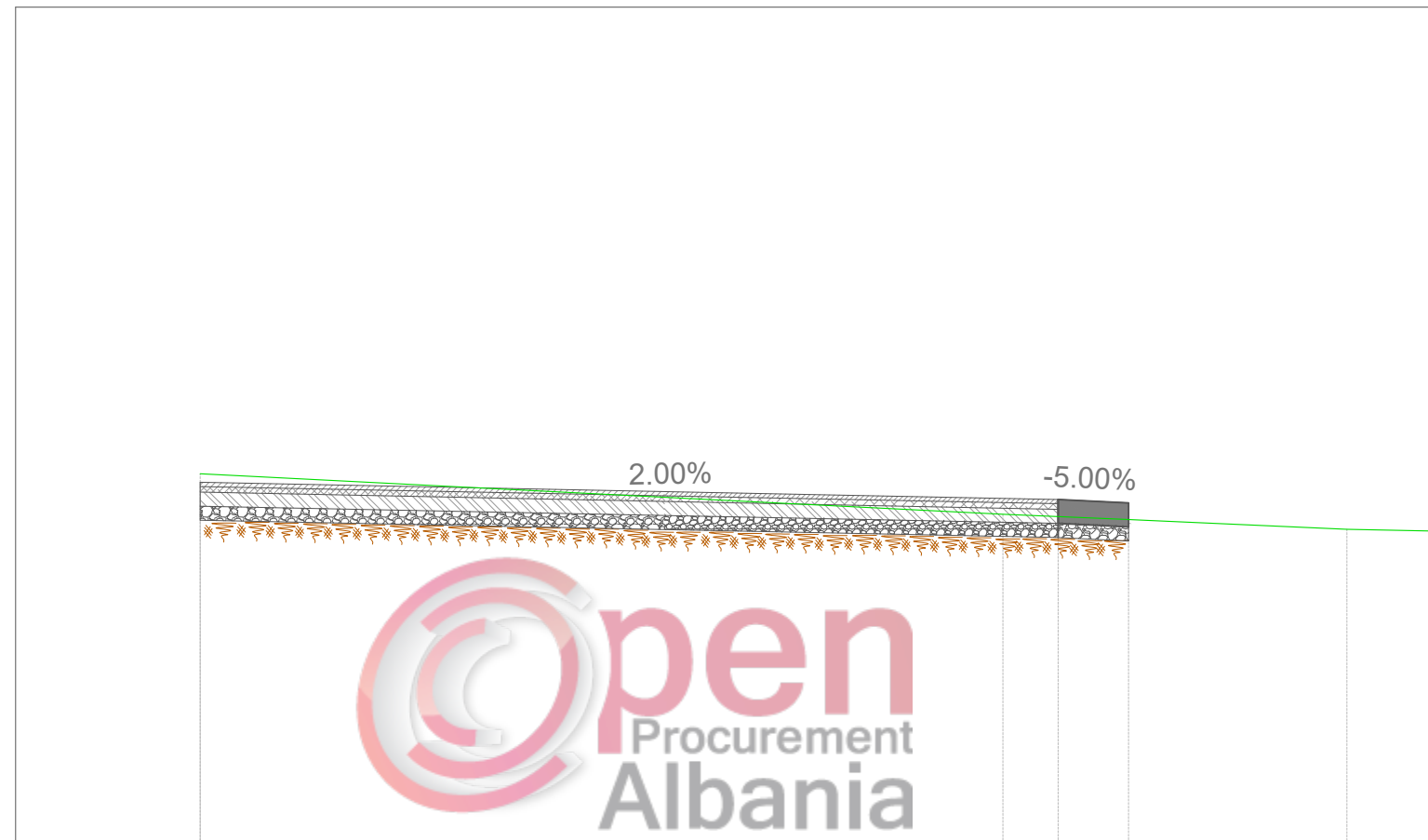

PROGRESIVE TERRENI			3.82	5.71	6.56	8.15
KUOTA E TERRENI	49.63		49.44	49.34	49.31	49.24
DISTANCA PJESORE E TERRENI		3.82		1.88	0.86	1.59
PROGRESIVE PROJEKTI	0.00			6.10	6.60	
KUOTA E PROJEKTI	49.57			49.45	49.42	
DISTANCA PJESORE E PROJ.			6.10		0.50	

### Shenime

Investitor  
 BASHKIA SHKODER



Emertimi i PROJEKTTIT  
 RIKUALIFIKIM URBAN BLOQE BANIMI  
 "EUROPA",  
 (TEK ISH-PODGORICA)

Faza e PROJEKTTIT  
 PROJEKT ZBATIM

### PROJEKTI i infrastruktures

Konsulentit  
**C.E.C Group**  
 Civil Engineering Consultants

Projektoi	Emer Mbiemer	Firma
Insh. Nderim	Vangush MBRICË	
Insh. Nderim	Andren MBRICË	
Insh. Mekanik	Paskal JARAZI	
Insh. Gjeolog	Pellumb TOSKA	
Insh. Elektrik	Gazmir ISAKAJ	
Insh. Topograf	Nuredin HAMZAI	
Arkitekte	Genjiana CENGA	
Topograf	Eroglan MUCA	

Dwg.Nr. D1.02

Emertimi fletes:  
 Profilat terthore progressive

Shkalla:

A3 - 1:50

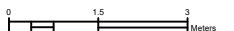



Mat. Per progr 0+020.00			
Materiale	Area (m2)	Vol (m3)	Vol Cum (m3)
Germim	0.18	8.55	54.15
Mbushje	0	0	0

Seksioni nr. 3  
 Progr : 0+020.00  
 Shkalla : 100:100  
 K.Ref. : 48.00

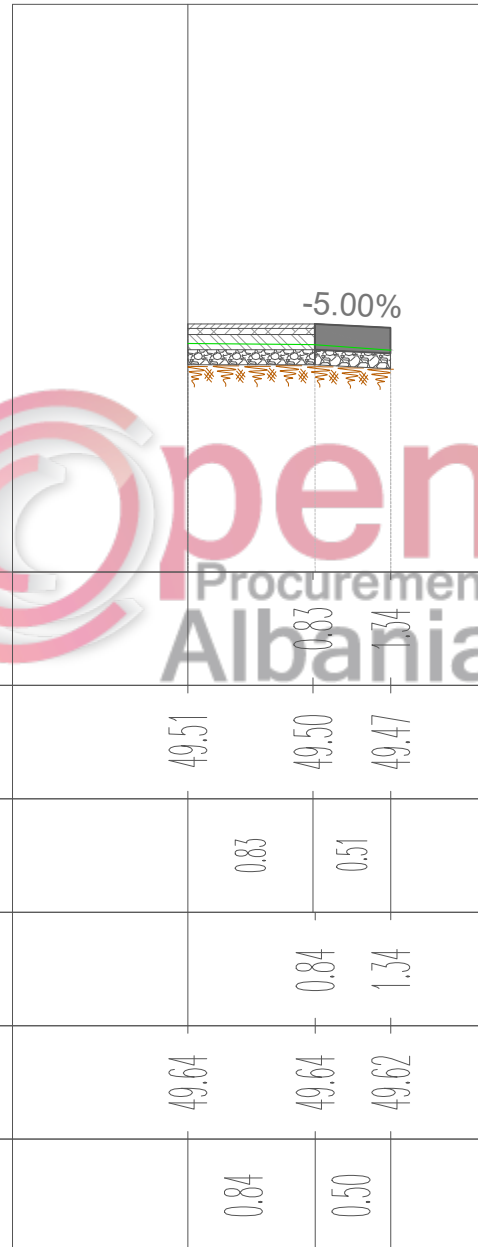

PROGRESIVE TERRENI	49.51	49.50	49.47
KUOTA E TERRENIT	49.51	49.50	49.47
DISTANCA PJESORE E TERRENIT	0.83	0.51	
PROGRESIVE PROJEKTI		0.84	1.34
KUOTA E PROJEKTI	49.64	49.64	49.62
DISTANCA PJESORE E PROJ.	0.84	0.50	

Shenime

Investitor  
 BASHKIA SHKODER



Emertimi i PROJEKTTIT  
 RIKUALIFIKIM URBAN BLOQE BANIMI  
 "EUROPA",  
 (TEK ISH-PODGORICA)

Faza e PROJEKTTIT  
 PROJEKT ZBATIM

PROJEKTI i  
 infrastruktures

Konsulentit  
**C.E.C Group**  
 Civil Engineering Consultants

Projektoi	Emer Mbiemer	Firma
Insh. Nderim	Vangush MBRICJE	
Insh. Nderim	Andren MBRICJE	
Insh. Mekanik	Paskal JARAZI	
Insh. Gjeolog	Pellumb TOSKA	
Insh. Elektrik	Gazmir ISAKAJ	
Insh. Topograf	Nuredin HAMZAI	
Arkitekte	Genjane CENGA	
Topograf	Eroglan MUCA	

Dwg.Nr. D1.03

Emertimi fletes:  
 Profilat terthore progressive

Shkalla:

A3 - 1:150

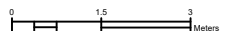

Mat. Per progr 0+030.00			
Materiale	Area (m2)	Vol (m3)	Vol Cum (m3)
Germim	3.43	18.05	72.2
Mbushje	0	0	0

Seksioni nr. 4  
 Progr : 0+030.00  
 Shkalla : 100:100  
 K.Ref. : 48.00

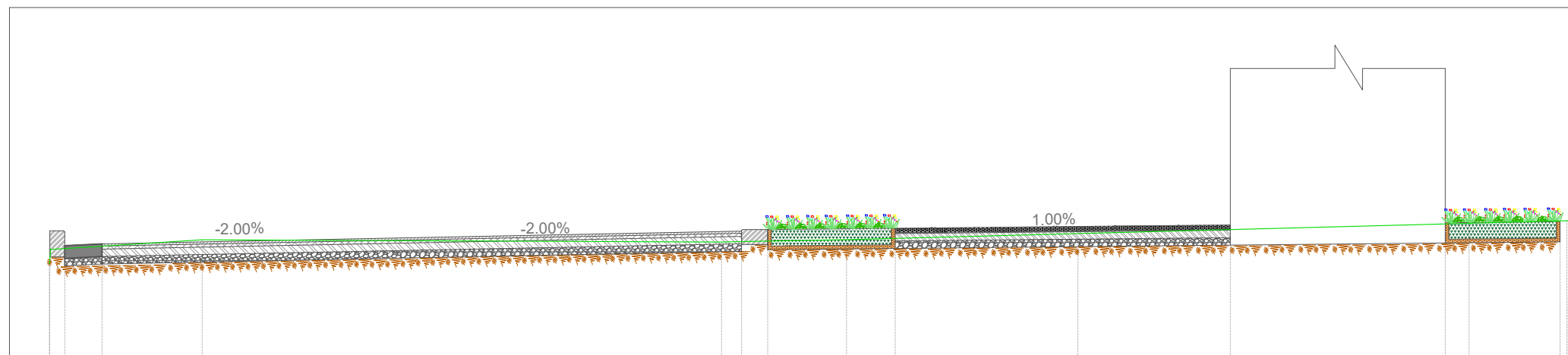

PROGRESIVE TERRENI	-0.01	0.00	2.04	9.00	10.68	13.78	20.55
KUOTA E TERRENIT	49.42	49.35	49.61	49.58	49.61	49.69	49.86
DISTANCA PJESORE E TERRENIT		2.03		6.96	1.68	3.10	6.57
PROGRESIVE PROJEKTI	0.00	0.20	0.70	9.27	9.62	11.33	20.24
KUOTA E PROJEKTIT	49.73	49.53	49.58	49.73	49.75	49.76	49.81
DISTANCA PJESORE E PROJ.	0.20	0.50	8.57	0.35	1.71	4.49	2.88

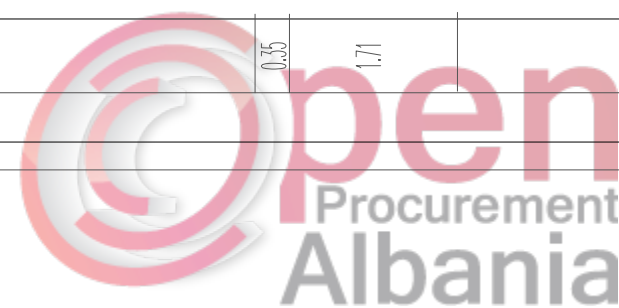

Seksioni nr. 5  
 Progr : 0+040.00  
 Shkalla : 100:100  
 K.Ref. : 48.00

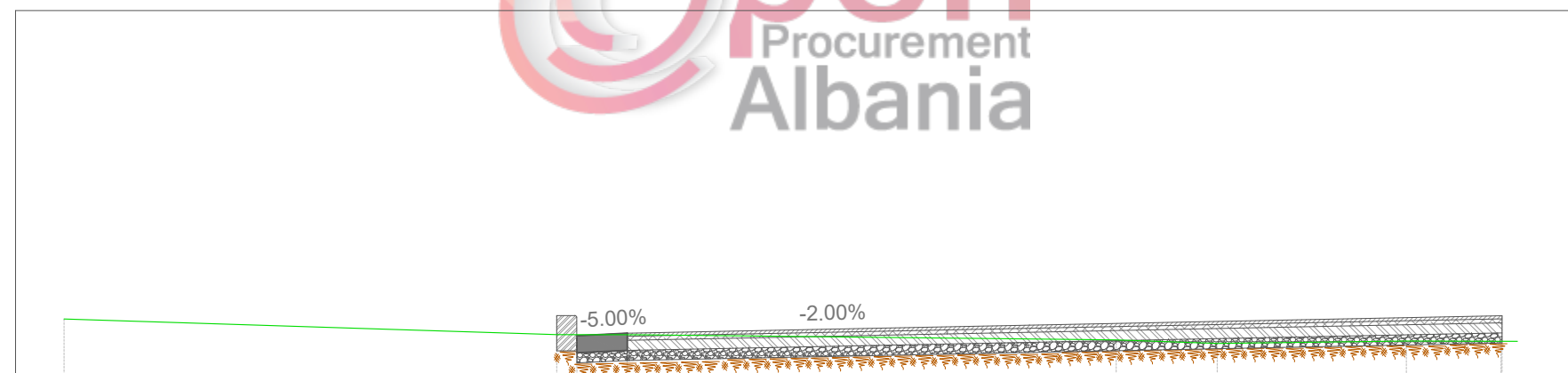

PROGRESIVE TERRENI	-4.89	0.80	5.55	6.55	8.43	9.37
KUOTA E TERRENIT	49.79	49.64	49.63	49.58	49.55	49.57
DISTANCA PJESORE E TERRENIT	4.89	0.80	4.75	1.00	1.88	0.94
PROGRESIVE PROJEKTI		0.20	0.70			9.37
KUOTA E PROJEKTIT		49.82	49.62	49.65		49.82
DISTANCA PJESORE E PROJ.		0.20	0.50	8.68		

## Shenime

Investitor  
 BASHKIA SHKODER



Emertimi i PROJEKTIT  
 RIKUALIFIKIM URBAN BLOQE BANIMI  
 "EUROPA",  
 (TEK ISH-PODGORICA)

Faza e PROJEKTIT  
 PROJEKT ZBATIM

## PROJEKTI i infrastruktures

Konsulenti



Projektoi	Emer Mbiemer	Firma
Insh. Nderim	Vangush MBRICË	
Insh. Nderim	Andren MBRICË	
Insh. Mekanik	Paskal JARAZI	
Insh. Gjeolog	Pellumb TOSKA	
Insh. Elektrik	Gazmir ISAKAJ	
Insh. Topograf	Nuredin HAMZAI	
Arktekte	Genjiana CENGA	
Topograf	Eroglan MUCA	

Dwg.Nr. D1.04

Emertimi fletes:  
 Profilat terthore progresive

Shkalla:

A3 - 1:75

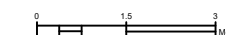

Mat. Per progr 0+040.00			
Materiale	Area (m2)	Vol (m3)	Vol Cum (m3)
Germim	1.23	23.3	95.5
Mbushje	0	0	0

Seksioni nr. 5  
 Progr : 0+040.00  
 Shkalla : 100:100  
 K.Ref. : 48.00

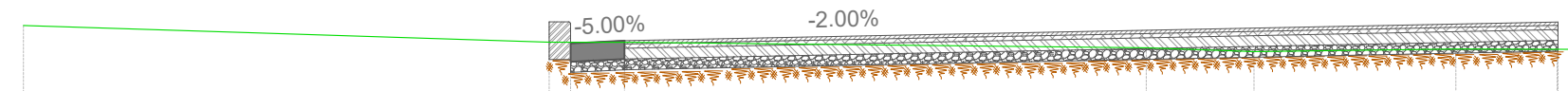

PROGRESIVE TERRENI	-4.89	0.80	5.55	6.55	8.43	9.37	
KUOTA E TERRENIT	49.79	49.64	49.63	49.58	49.55	49.57	49.57
DISTANCA PJESORE E TERRENIT	4.89	0.80	4.75	1.00	1.88	0.94	
PROGRESIVE PROJEKTI		0.20	0.70			9.37	
KUOTA E PROJEKTIT		49.82	49.62	49.65		49.82	
DISTANCA PJESORE E PROJ.		0.20	0.30	8.88			



Mat. Per progr 0+050.00			
Materiale	Area (m2)	Vol (m3)	Vol Cum (m3)
Germim	3.42	23.25	118.75
Mbushje	0	0	0

Seksioni nr. 6  
 Progr : 0+050.00  
 Shkalla : 100:100  
 K.Ref. : 48.00

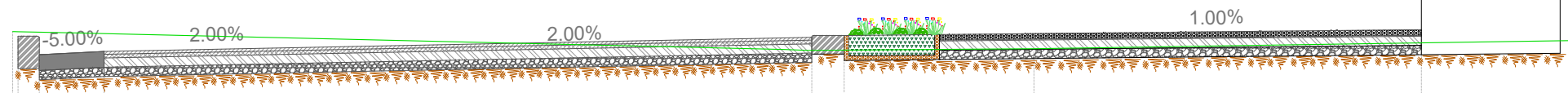

PROGRESIVE TERRENI	-0.06	0.62	8.29	10.98	16.87	
KUOTA E TERRENIT	49.91	49.91	49.90	49.72	49.72	49.81
DISTANCA PJESORE E TERRENIT	0.62	7.68	2.69	5.89		
PROGRESIVE PROJEKTI	0.23	0.93	8.58	8.94	14.15	
KUOTA E PROJEKTIT	49.86	49.66	49.69	49.85	49.87	50.93
DISTANCA PJESORE E PROJ.	0.23	0.70	7.65	0.35	5.21	

### Shenime

Investitor  
 BASHKIA SHKODER



Emertimi i PROJEKTTIT  
 RIKUALIFIKIM URBAN BILLOQE BANIMI  
 "EUROPA",  
 (TEK ISH-PODGORICA)

Faza e PROJEKTTIT  
 PROJEKT ZBATIM

### PROJEKTI i infrastruktures

Konsulentit  
 C.E.C Group  
 Civil Engineering Consultants

Projektoi	Emer Mbiemer	Firma
Insh. Nderim	Vangush MBRICË	
Insh. Nderim	Andren MBRICË	
Insh. Mekanik	Paskal JARAZI	
Insh. Gjeolog	Pellumb TOSKA	
Insh. Elektrik	Gazmir ISAKAJ	
Insh. Topograf	Nuredin HAMZAI	
Arkitekte	Genjiana CENGA	
Topograf	Eroglan MUCA	

Dwg.Nr. D1.05

Emertimi fletes:  
 Profilat terthore progressive

Shkalla:

A3 - 1:75

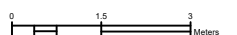

Mat. Per progr 0+060.00			
Materiale	Area (m2)	Vol (m3)	Vol Cum (m3)
Germim	1.54	24.8	143.55
Mbushje	0	0	0

Seksioni nr. 7  
 Progr : 0+060.00  
 Shkalla : 100:100  
 K.Ref. : 48.00

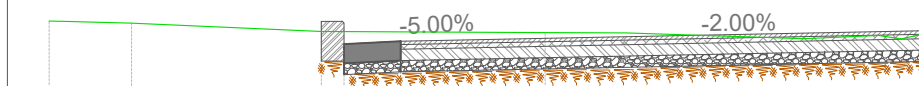

PROGRESIVE TERRENI	-2.40	-2.20	-1.67																			
KUOTA E TERRENIT	49.87	49.86	49.85	49.78																		
DISTANCA PJESORE E TERRENIT		0.53	1.67																			
PROGRESIVE PROJEKTI				0.20	0.70																	
KUOTA E PROJEKTI				49.86	49.66	49.69																49.78
DISTANCA PJESORE E PROJ.				0.70	0.50																	

Mat. Per progr 0+070.00			
Materiale	Area (m2)	Vol (m3)	Vol Cum (m3)
Germim	2.34	19.4	143.55
Mbushje	0	0	0

Seksioni nr. 8  
 Progr : 0+070.00  
 Shkalla : 100:100  
 K.Ref. : 48.00

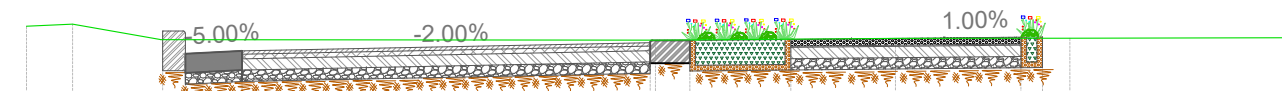

PROGRESIVE TERRENI	-1.20	-0.79	0.00																				
KUOTA E TERRENIT	49.86	49.88	49.74																				
DISTANCA PJESORE E TERRENIT		0.77	4.34																				
PROGRESIVE PROJEKTI			0.71																				
KUOTA E PROJEKTI			49.82	49.62	49.65																		
DISTANCA PJESORE E PROJ.			0.70	0.51	3.59																		

### Shenime

Investitor  
 BASHKIA SHKODER



Emertimi i PROJEKTIIT  
 RIKUALIFIKIM URBAN BLOQE BANIMI  
 "EUROPA",  
 (TEK ISH-PODGORICA)

Faza e PROJEKTIIT  
 PROJEKT ZBATIM

### PROJEKTI i infrastruktures

Konsulent  
**C.E.C Group**  
 Civil Engineering Consultants

Projektoi	Emer Mbiemer	Firma
Insh. Nderim	Vangush MBRICË	
Insh. Nderim	Andren MBRICË	
Insh. Mekanik	Paskal JARAZI	
Insh. Gjeolog	Pellumb TOSKA	
Insh. Elektrik	Gazmir ISAKAJ	
Insh. Topograf	Nuredin HAMZAI	
Arktekte	Genjane CENGA	
Topograf	Eroglan MUCA	

Dwg.Nr. D1.06

Emertimi fletes:  
 Profilat terthore progresive

Shkalla:

A3 - 1:75

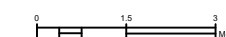

Mat. Per progr 0+080.00			
Materiale	Area (m2)	Vol (m3)	Vol Cum (m3)
Germim	1.97	21.55	165.1
Mbushje	0	0	0

Seksioni nr. 9  
 Progr : 0+080.00  
 Shkalla : 100:100  
 K.Ref. : 48.00

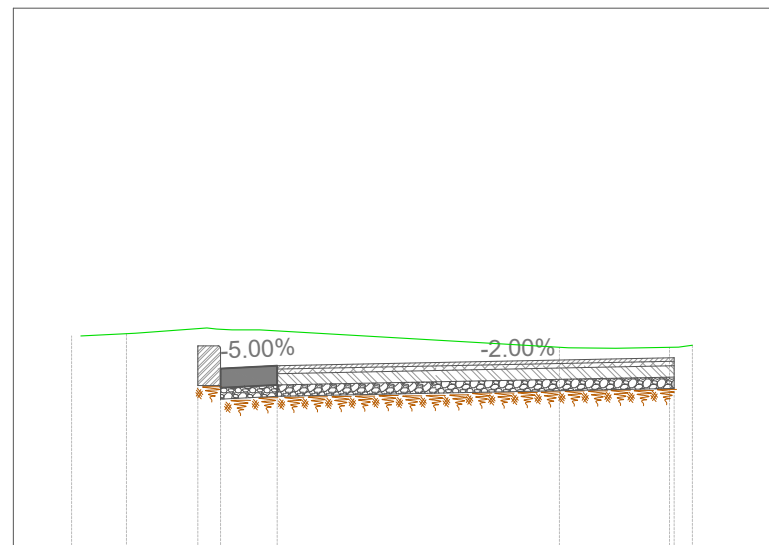

PROGRESIVE TERRENI	-1.11	-0.63		3.19	4.16	4.20
KUOTA E TERRENIT	49.87	49.89	49.94	49.77	49.77	49.79
DISTANCA PJESORE E TERRENIT		0.63	2.72		0.55	
PROGRESIVE PROJEKTI			0.50		4.20	
KUOTA E PROJEKTIT		49.78	49.58	49.61	49.68	
DISTANCA PJESORE E PROJ.		0.20	0.50	3.50		

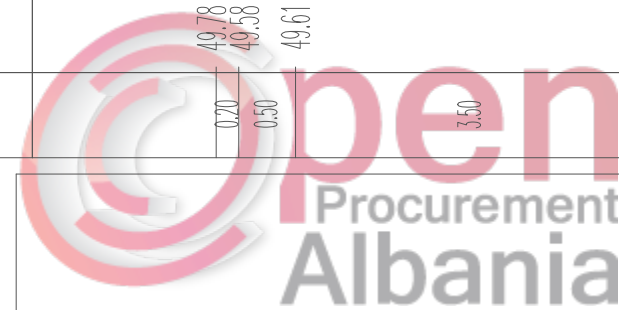

Mat. Per progr 0+090.00			
Materiale	Area (m2)	Vol (m3)	Vol Cum (m3)
Germim	1.55	17.6	182.7
Mbushje	0	0	0

Seksioni nr. 10  
 Progr : 0+090.00  
 Shkalla : 100:100  
 K.Ref. : 48.00

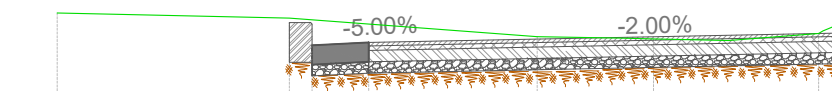

PROGRESIVE TERRENI	-2.05	0.00		2.19	2.92	3.87	4.67	4.88
KUOTA E TERRENIT	49.82	49.77	49.77	49.61	49.60	49.58	49.64	49.73
DISTANCA PJESORE E TERRENIT		2.05	2.19	0.74	0.66	0.80		
PROGRESIVE PROJEKTI			0.20	0.70			4.88	
KUOTA E PROJEKTIT		49.73	49.53	49.56			49.64	
DISTANCA PJESORE E PROJ.		0.20	0.50	4.18				

### Shenime

Investitor  
 BASHKIA SHKODER



Emertimi i PROJEKTTIT  
 RIKUALIFIKIM URBAN BLOQE BANIMI  
 "EUROPA",  
 (TEK ISH-PODGORICA)

Faza e PROJEKTTIT  
 PROJEKT ZBATIM

### PROJEKTI i infrastruktures

Konsulentit  
 C.E.C Group  
 Civil Engineering Consultants

Projektoi	Emer Mbiemer	Firma
Insh. Nderim	Vangush MBRICE	
Insh. Nderim	Andren MBRICE	
Insh. Mekanik	Paskal JARAZI	
Insh. Gjeolog	Pellumb TOSKA	
Insh. Elektrik	Gazmir ISAKAJ	
Insh. Topograf	Nuredin HAMZAI	
Arktekte	Genjana CENGA	
Topograf	Eroglan MUCA	

Dwg.Nr. D1.07

Emertimi fletes:  
 Profilat terthore progresive

Shkalla:

A3 - 1:75

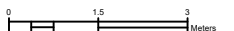

Mat. Per progr 0+100.00			
Materiale	Area (m2)	Vol (m3)	Vol Cum (m3)
Germim	1.39	14.7	197.4
Mbushje	0	0	0

Seksioni nr. 11  
 Progr : 0+100.00  
 Shkalla : 100:100  
 K.Ref. : 48.00

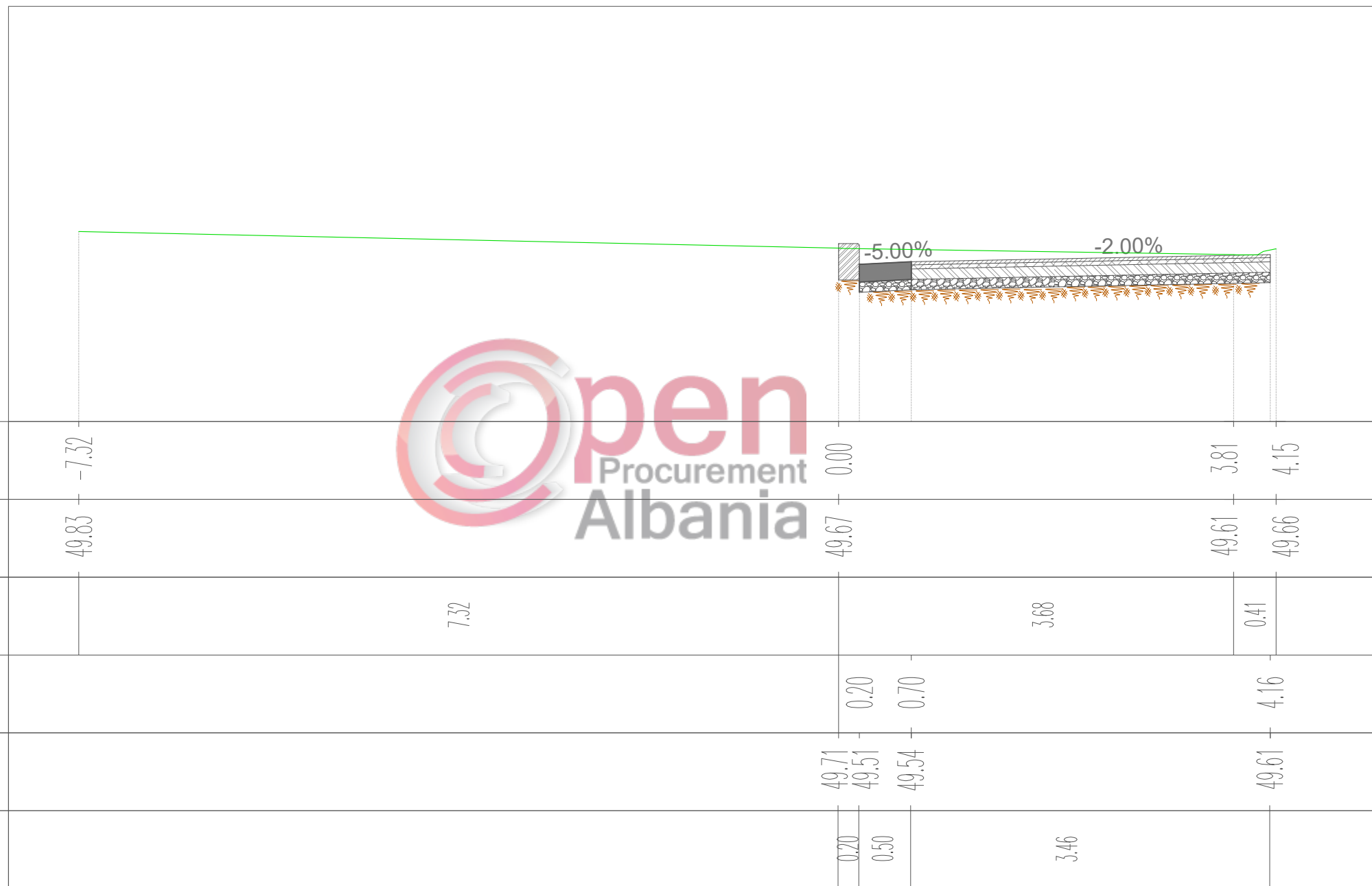

**Shenime**

Investitor  
 BASHKIA SHKODER



Emertimi i PROJEKTTIT  
 RIKUALIFIKIM URBAN BLOQE BANIMI  
 "EUROPA",  
 (TEK ISH-PODGORICA)

Faza e PROJEKTTIT  
 PROJEKT ZBATIM

**PROJEKTI i infrastruktures**

Konsulenti  
 C.E.C Group  
 Civil Engineering Consultants

Projektor	Emer Mbiemer	Firma
Insh. Nderim	Vangjush MBRIÇE	
Insh. Nderim	Andren MBRIÇE	
Insh. Mekanik	Paskal JARAZI	
Insh. Gjeolog	Pllumb TOSKA	
Insh. Elektrik	Gazmir ISAKAJ	
Insh. Topograf	Nuredin HAMZAI	
Arktekte	Gentjana CENGA	
Topograf	Eroglan MUCA	

Dwg.Nr. D1.08

Emertimi fletes:  
 Profilat terthore progresive

Shkalla:  
 A3 - 1:50

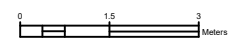

Mat. Per progr 0+110.00			
Materiale	Area (m2)	Vol (m3)	Vol Cum (m3)
Germim	2.9	21.45	218.85
Mbushje	0	0	0

Seksioni nr. 12  
 Progr : 0+110.00  
 Shkalla : 100:100  
 K.Ref. : 48.00

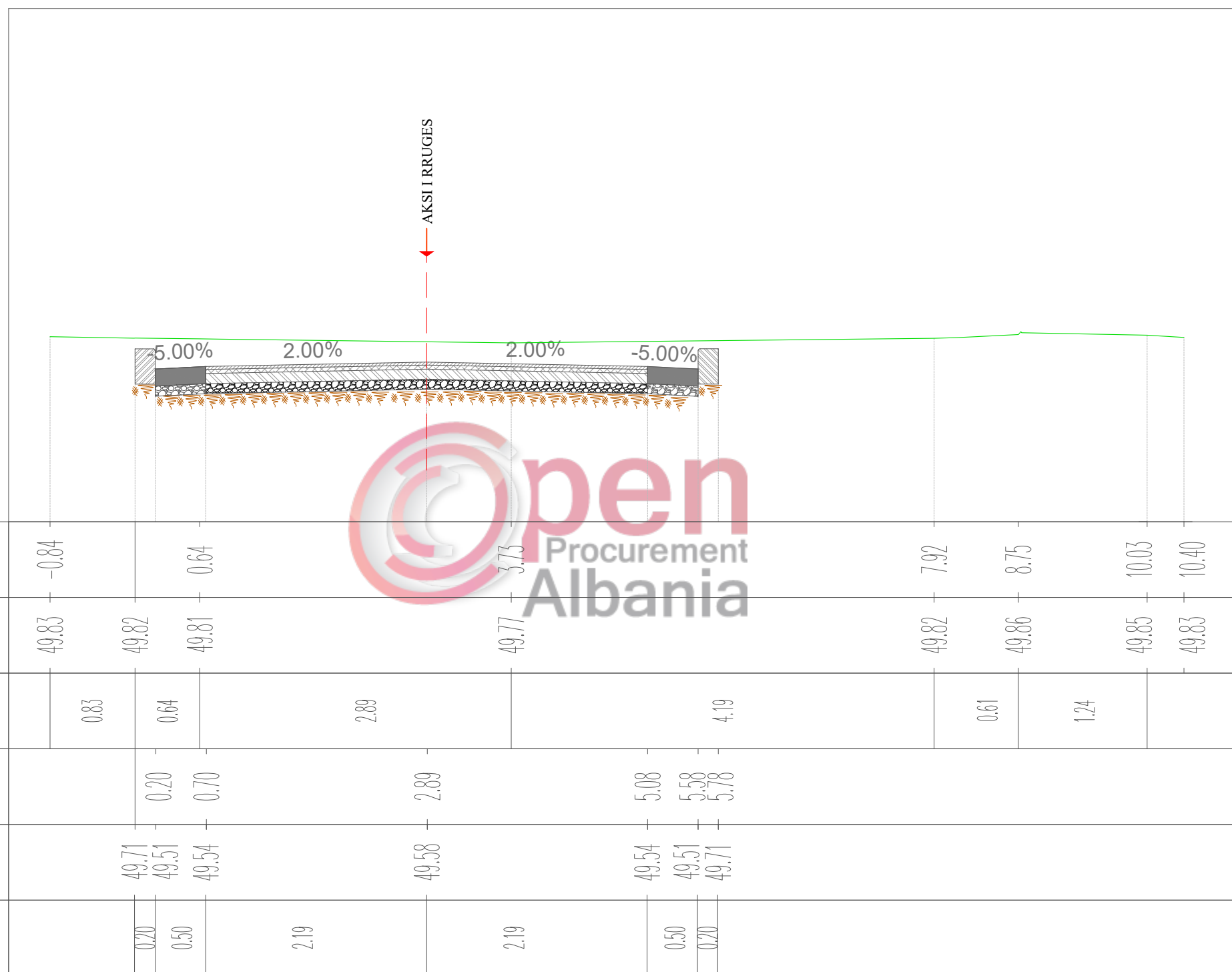

Shenime		
Investitor BASHKIA SHKODER		
Emertimi i PROJEKTTIT RIKUALIFIKIM URBAN BLOQE BANIMI "EUROPA", (TEK ISH-PODGORICA)		
Faza e PROJEKTTIT PROJEKT ZBATIM		
PROJEKTI i infrastruktures		
Konsulentit C.E.C Group Civil Engineering Consultants		
Projektor	Emer Mbiemer	Firma
Insh. Nderim	Vangush MBRIÇE	
Insh. Nderim	Andan MBRIÇE	
Insh. Mekanik	Paskal JARAZI	
Insh. Gjeolog	Pellumb TOSKA	
Insh. Elektrik	Gazmir ISAKAJ	
Insh. Topograf	Nuredin HAMZAI	
Arktekte	Gentjana CENGA	
Topograf	Eroglan MUCA	
Dwg.Nr. D1.09		
Emertimi fletes: Profilat terthore progressive		
Shkalla: A3 - 1:50		

Mat. Per progr 0+130.00			
Materiale	Area (m2)	Vol (m3)	Vol Cum (m3)
Germim	4.08	69.8	288.65
Mbushje	0	0	0

Seksioni nr. 13  
 Progr : 0+130.00  
 Shkalla : 100:100  
 K.Ref. : 48.00

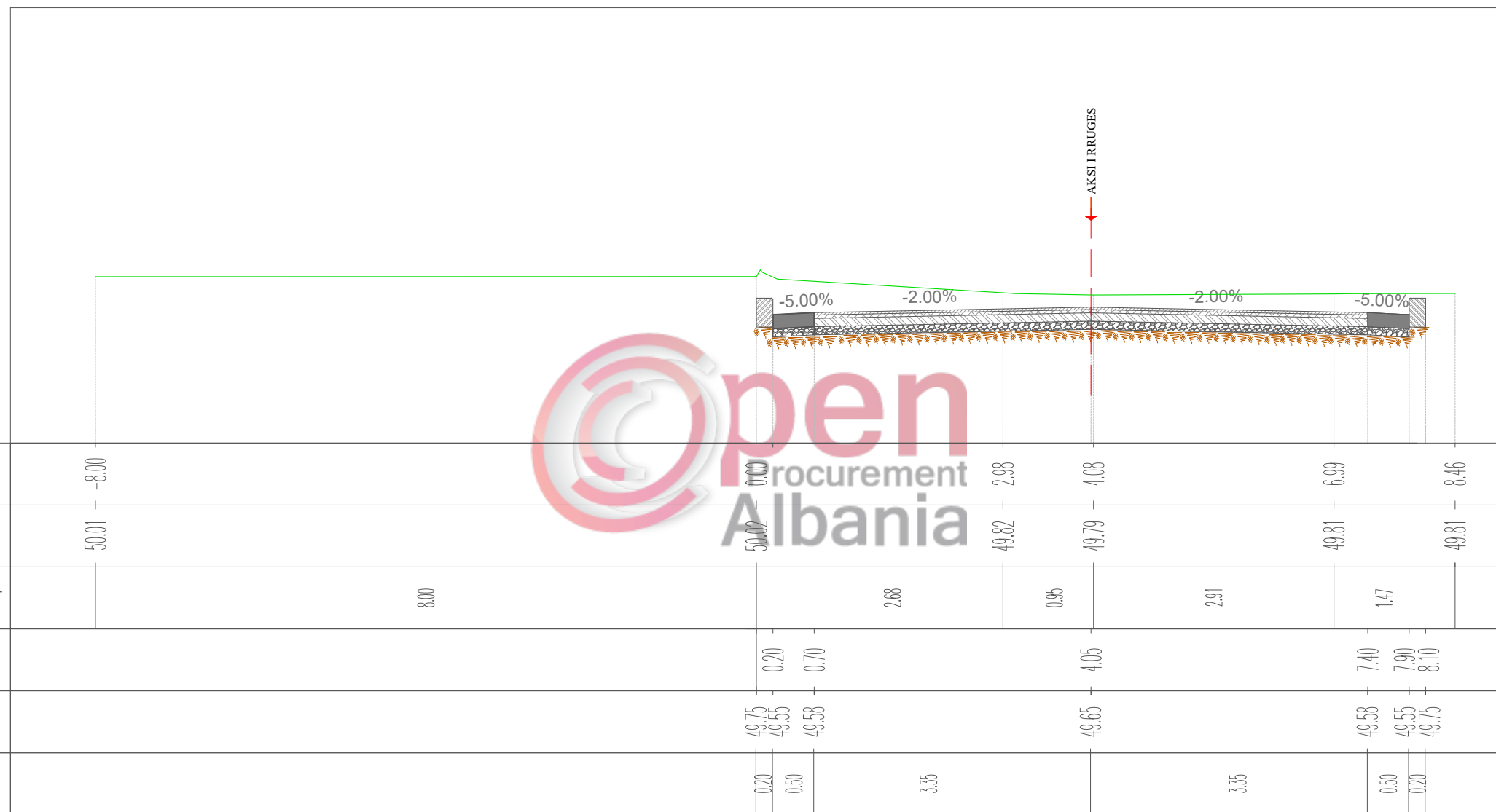

Shenime

Investitor  
 BASHKIA SHKODER



Emertimi i PROJEKTTIT  
 RIKUALIFIKIM URBAN BLOQE BANIMI  
 "EUROPA",  
 (TEK ISH-PODGORICA)

Faza e PROJEKTTIT  
 PROJEKT ZBATIM

PROJEKTI i infrastruktures

Konsulentit  
**C.E.C Group**  
 Civil Engineering Consultants

Projektoi	Emer Mbiemer	Firma
Insh. Nderim	Vangush MBRICË	
Insh. Nderim	Andren MBRICË	
Insh. Mekanik	Paskal JARAZI	
Insh. Gjeolog	Pellumb TOSKA	
Insh. Elektrik	Gazmir ISAKAJ	
Insh. Topograf	Nuredin HAMZAI	
Arkitekte	Genjane CENGA	
Topograf	Eroglan MUCA	

Dwg.Nr. D1.10

Emertimi fletes:  
 Profilat terthore progressive

Shkalla:

A3 - 1:75

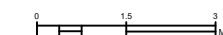



Mat. Per progr 0+140.00			
Materiale	Area (m2)	Vol (m3)	Vol Cum (m3)
Germim	2.35	32.15	320.8
Mbushje	0	0	0

Seksioni nr. 14  
 Progr : 0+140.00  
 Shkalla : 100:100  
 K.Ref. : 48.00

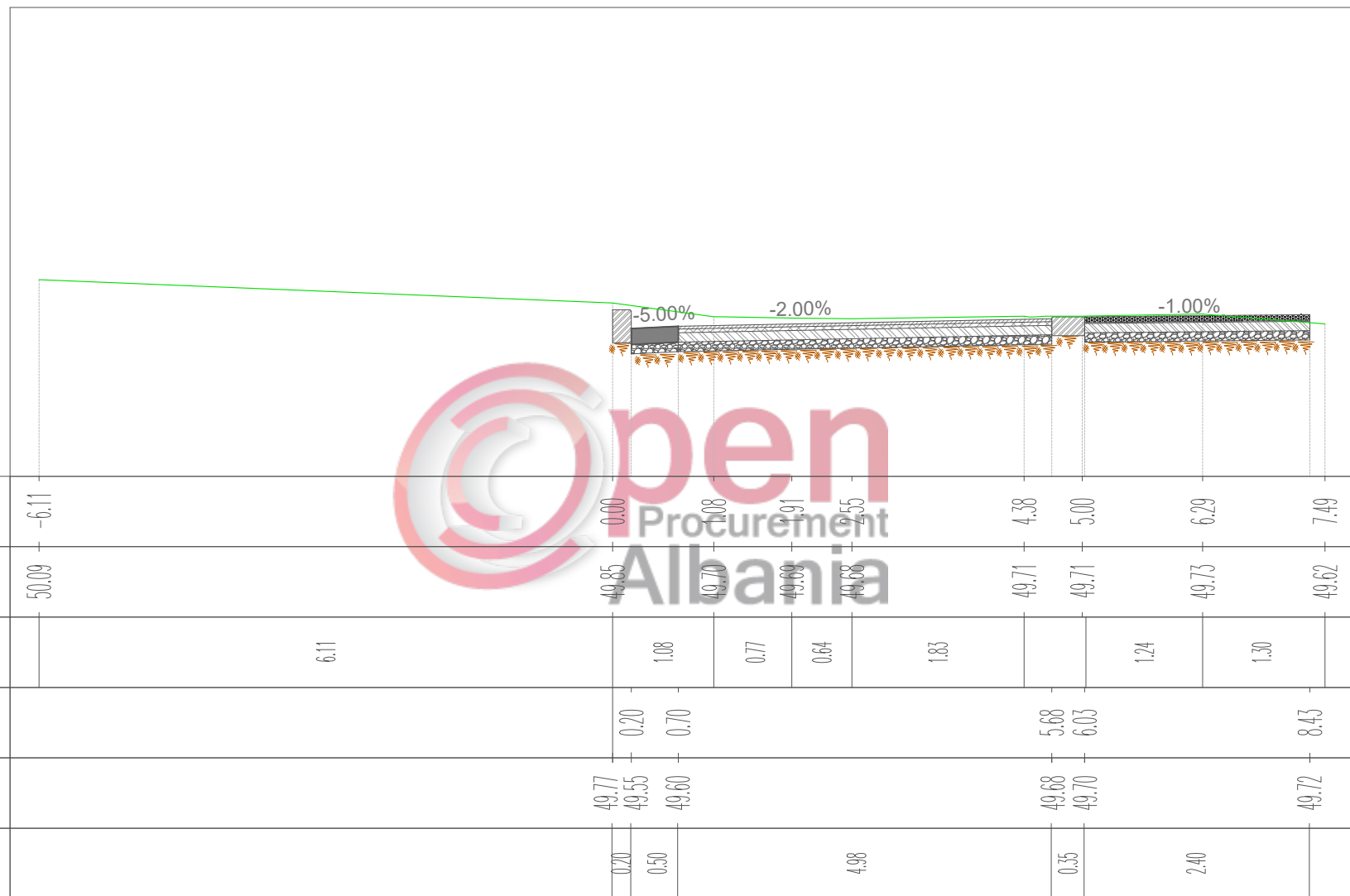

PROGRESIVE TERRENI	50.09	49.85	49.70	49.69	49.68	49.71	49.71	49.73	49.62
KUOTA E TERRENIT	-6.11	0.00	0.08	0.91	2.55	4.38	5.00	6.29	7.49
DISTANCA PJESORE E TERRENIT		6.11	1.08	0.77	0.64	1.83		1.24	1.30
PROGRESIVE PROJEKTI		49.77	49.55	49.60		49.68	49.70	6.03	8.43
KUOTA E PROJEKTI		0.20	0.70			0.35		2.40	
DISTANCA PJESORE E PROJ.		0.20	0.50	4.98					

Shenime

Investitor  
 BASHKIA SHKODER



Emertimi i PROJEKTI  
 RIKUALIFIKIM URBAN BLOQE BANIMI  
 "EUROPA",  
 (TEK ISH-PODGORICA)

Faza e PROJEKTI  
 PROJEKT ZBATIM

PROJEKTI i  
 infrastruktures

Konsulenti



Projektoi	Emer Mbiemer	Firma
Insh. Nderim	Vangush MBRICË	
Insh. Nderim	Andren MBRICË	
Insh. Mekanik	Paskal JARAZI	
Insh. Gjeolog	Pellumb TOSKA	
Insh. Elektrik	Gazmir ISAKAJ	
Insh. Topograf	Nuredin HAMZAI	
Arkitekte	Genjiana CENGA	
Topograf	Eroglan MUCA	

Dwg.Nr. D1.11

Emertimi fletes:  
 Profilat terthore progressive

Shkalla:

A3 - 1:75

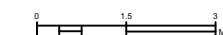

Mat. Per progr 0+150.00			
Materiale	Area (m2)	Vol (m3)	Vol Cum (m3)
Germim	0.95	16.5	337.3
Mbushje	0	0	0

Seksioni nr. 15  
 Progr : 0+150.00  
 Shkalla : 100:100  
 K.Ref. : 48.00

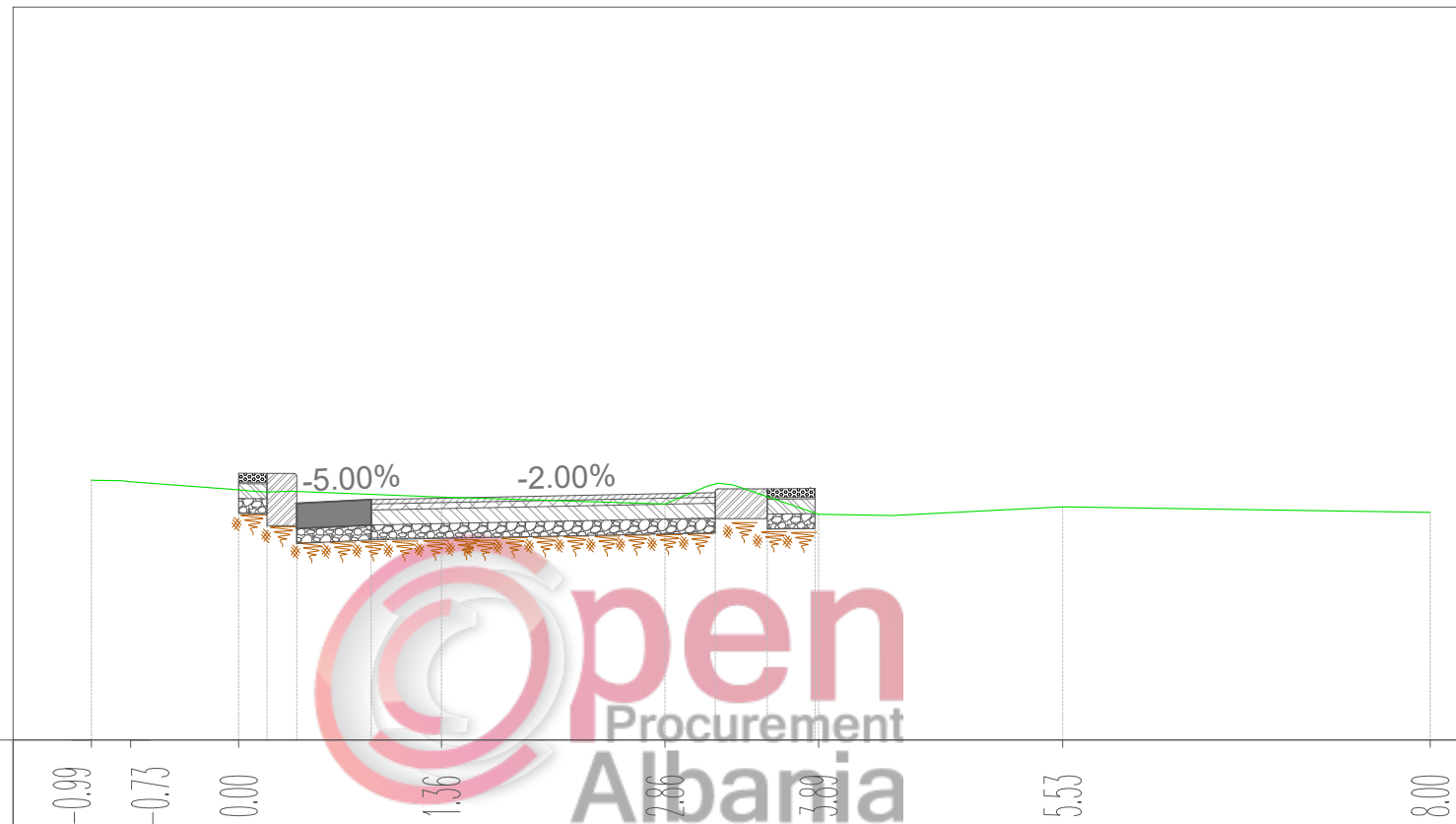

PROGRESIVE TERRENI	-0.99	-0.73	0.00	1.36	2.86	3.89	5.53	8.00
KUOTA E TERRENIT	49.74	49.73	49.68	49.63	49.58	49.51	49.56	49.53
DISTANCA PJESORE E TERRENIT		0.73	1.36	1.50	1.03	1.64	2.47	
PROGRESIVE PROJEKTI			0.19	0.20	0.89	3.20	3.55	3.87
KUOTA E PROJEKTI			49.79	49.79	49.59	49.61	49.66	49.69
DISTANCA PJESORE E PROJ.			0.19	0.20	0.50	2.31	0.35	0.32

## Shenime

Investitor  
 BASHKIA SHKODER



Emertimi i PROJEKTTIT  
 RIKUALIFIKIM URBAN BLOQE BANIMI  
 "EUROPA",  
 (TEK ISH-PODGORICA)

Faza e PROJEKTTIT  
 PROJEKT ZBATIM

**PROJEKTI i  
 infrastruktures**

Konsulentit  
**C.E.C Group**  
 Civil Engineering Consultants

Projektoi	Emer Mbiemer	Firma
Insh. Nderim	Vangush MBRICE	
Insh. Nderim	Andren MBRICE	
Insh. Mekanik	Paskal JARAZI	
Insh. Gjeolog	Pellumb TOSKA	
Insh. Elektrik	Gazmir ISAKAJ	
Insh. Topograf	Nuredin HAMZAI	
Arktekte	Genjiana CENGA	
Topograf	Eroglan MUCA	

Dwg.Nr. D1.12

Emertimi fletes:  
 Profilat terthore progressive

Shkalla:

A3 - 1:50

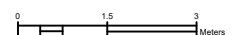

Mat. Per progr 0+160.00			
Materiale	Area (m2)	Vol (m3)	Vol Cum (m3)
Germim	0.2	5.75	343.05
Mbushje	0.02	0.1	0.1

Seksioni nr. 16  
 Progr : 0+160.00  
 Shkalla : 100:100  
 K.Ref. : 48.00

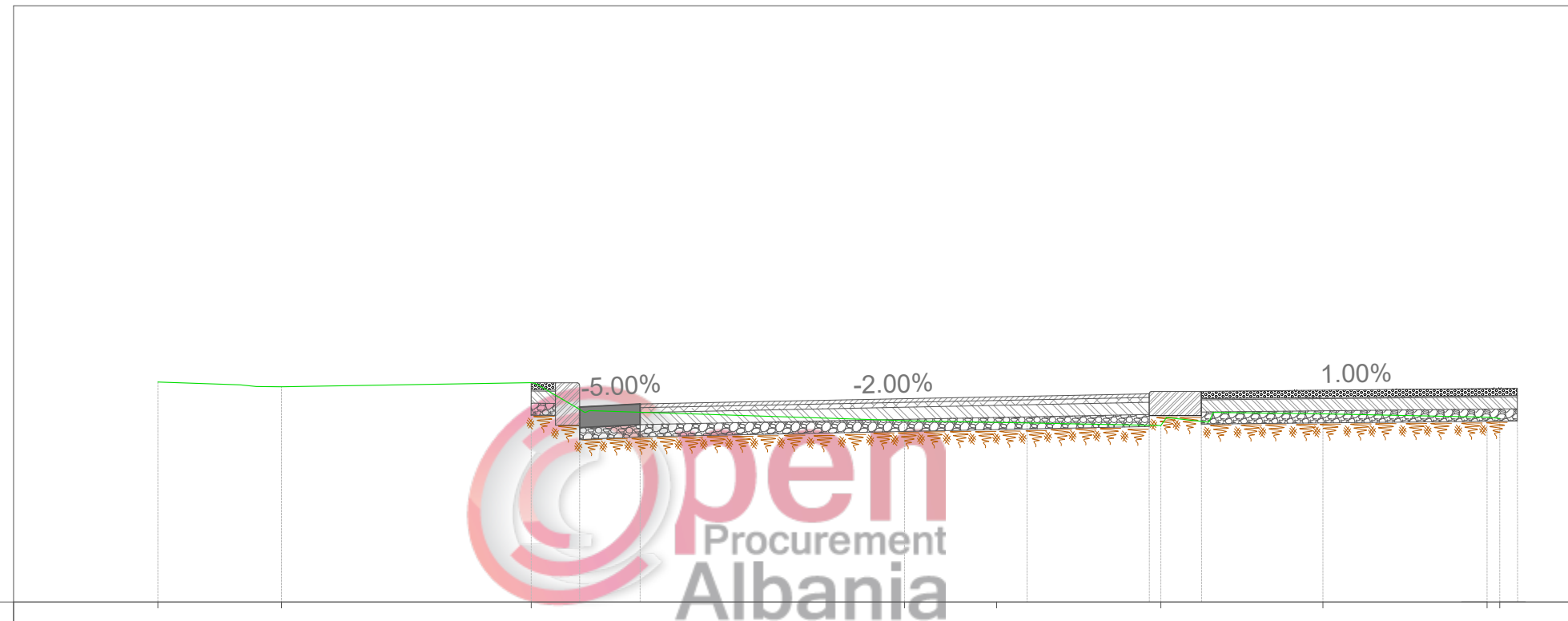

PROGRESIVE TERRENI	-3.08	-2.06	0.00	3.08	3.84	5.20	6.54	7.90	8.00
KUOTA E TERRENIT	49.81	49.78	49.81	49.50	49.47	49.46	49.55	49.53	49.51
DISTANCA PJESORE E TERRENIT	1.02	2.06	3.08	0.76	1.36	1.34	1.36		
PROGRESIVE PROJEKTI			0.20	0.40	0.90	5.10	5.53		8.14
KUOTA E PROJEKTIT			49.81	49.81	49.61	49.63	49.72	49.73	49.76
DISTANCA PJESORE E PROJ.			0.20	0.20	0.50	4.20	0.43	2.61	

### Shenime

Investitor  
 BASHKIA SHKODER



Emertimi i PROJEKTTIT  
 RIKUALIFIKIM URBAN BLOQE BANIMI  
 "EUROPA",  
 (TEK ISH-PODGORICA)

Faza e PROJEKTTIT  
 PROJEKT ZBATIM

### PROJEKTI i infrastruktures

Konsulentit  
**C.E.C Group**  
 Civil Engineering Consultants

Projektoi	Emer Mbiemer	Firma
Insh. Nderim	Vangush MBRICË	
Insh. Nderim	Andren MBRICË	
Insh. Mekanik	Paskal JARAZI	
Insh. Gjeolog	Pellumb TOSKA	
Insh. Elektrik	Gazmir ISAKAJ	
Insh. Topograf	Nuredin HAMZAI	
Arktekte	Genjiana CENGA	
Topograf	Eroglan MUCA	

Dwg.Nr. D1.13

Emertimi fletes:  
 Profilat terthore progressive

Shkalla:

A3 - 1:50

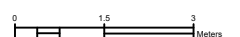

Mat. Per progr 0+165.93			
Materiale	Area (m2)	Vol (m3)	Vol Cum (m3)
Germim	0.83	3.05395	346.104
Mbushje	0	0.1	0.2

Seksioni nr. 17  
 Progr : 0+165.93  
 Shkalla : 100:100  
 K.Ref. : 48.00



PROGRESIVE TERRENI			3.17		5.14	5.64	6.19	7.04		10.00
KUOTA E TERRENIT	49.73		49.67		49.46	49.46	49.43	49.43		49.46
DISTANCA PJESORE E TERRENIT		3.17		1.90	0.50	0.56	0.85		2.88	
PROGRESIVE PROJEKTI	0.00		2.85	3.08	3.66		5.75			
KUOTA E PROJEKTIT	49.83		49.80	49.60	49.63		49.67			
DISTANCA PJESORE E PROJ.		2.85	0.23	0.58		2.09				

Shenime

Investitor  
 BASHKIA SHKODER



Emertimi i PROJEKTTIT  
 RIKUALIFIKIM URBAN BLOQE BANIMI  
 "EUROPA",  
 (TEK ISH-PODGORICA)

Faza e PROJEKTTIT  
 PROJEKT ZBATIM

**PROJEKTI i  
 infrastruktures**

Konsulentit  
**C.E.C Group**  
 Civil Engineering Consultants

Projektoi	Emer Mbiemer	Firma
Insh. Nderim	Vangush MBRICË	
Insh. Nderim	Andren MBRICË	
Insh. Mekanik	Paskal JARAZI	
Insh. Gjeolog	Pellumb TOSKA	
Insh. Elektrik	Gazmir ISAKAJ	
Insh. Topograf	Nuredin HAMZAI	
Arkitekte	Genjane CENGA	
Topograf	Eroglan MUCA	

Dwg.Nr. D1.14

Emertimi fletes:  
 Profilat terthore progresive

Shkalla:

A3 - 1:50

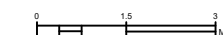

# Stol tip 1

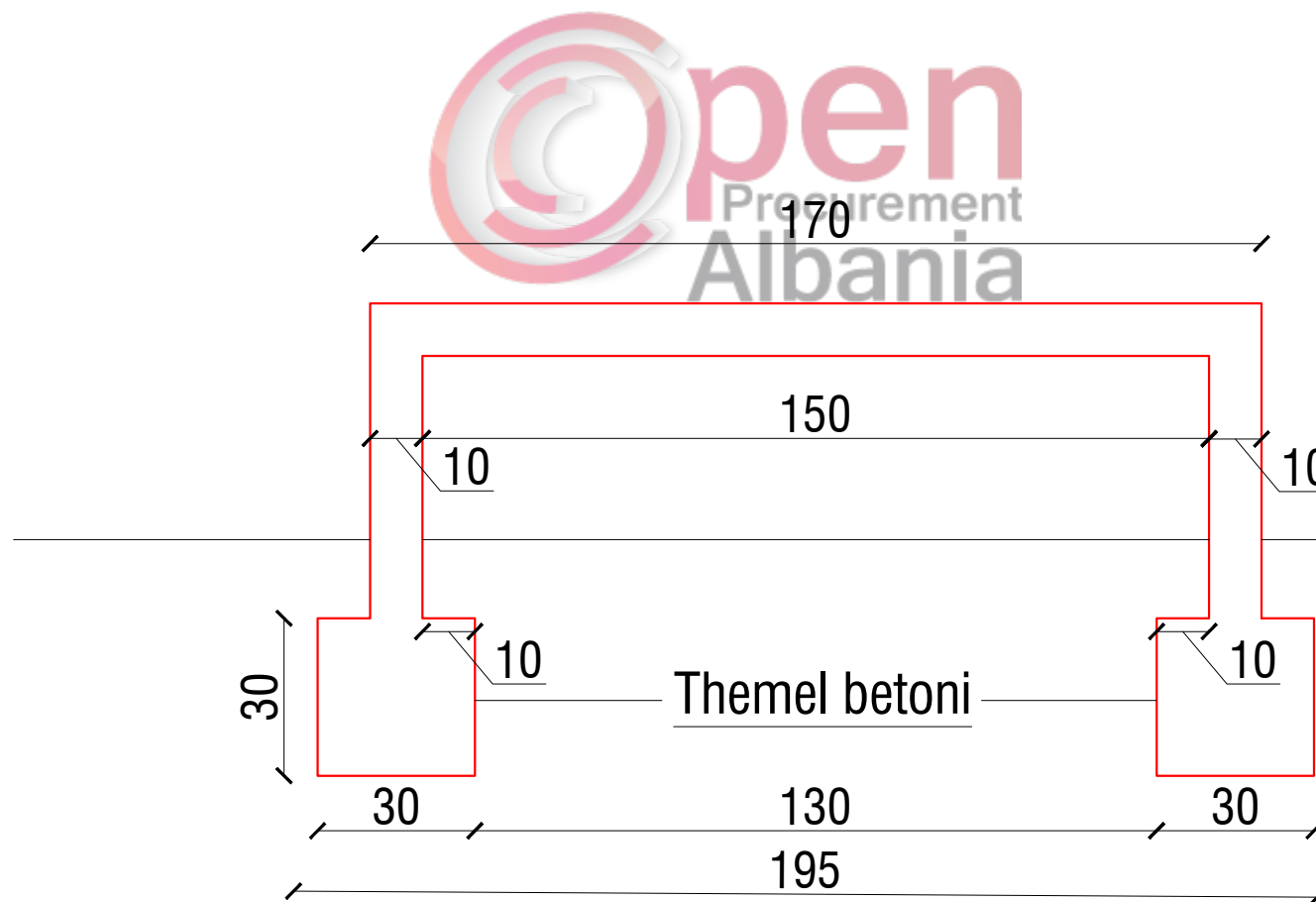
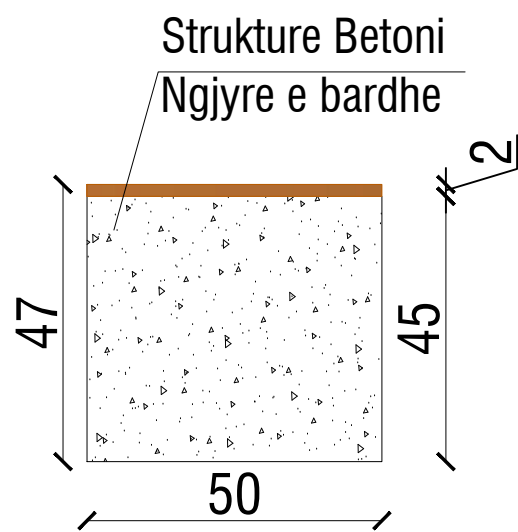
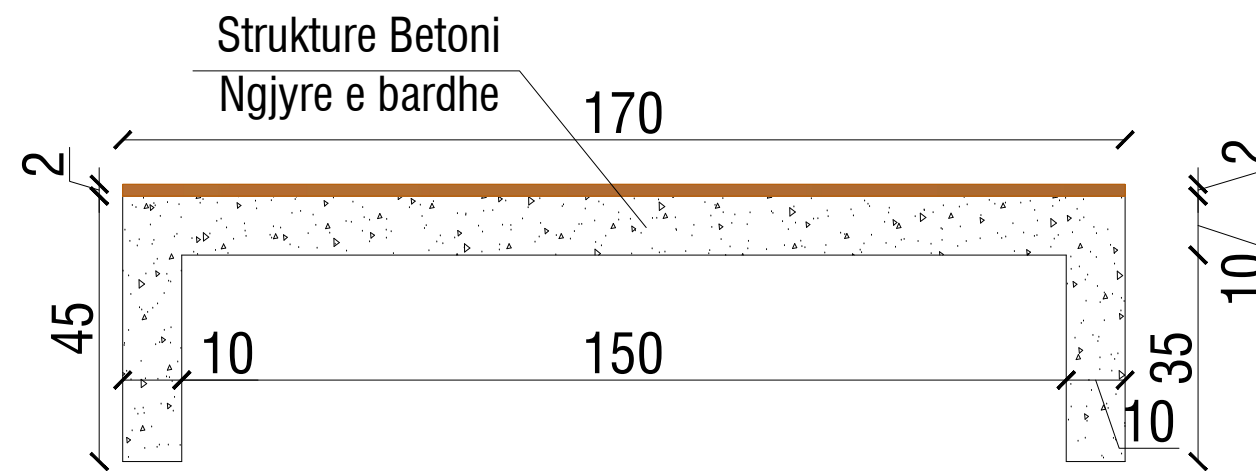
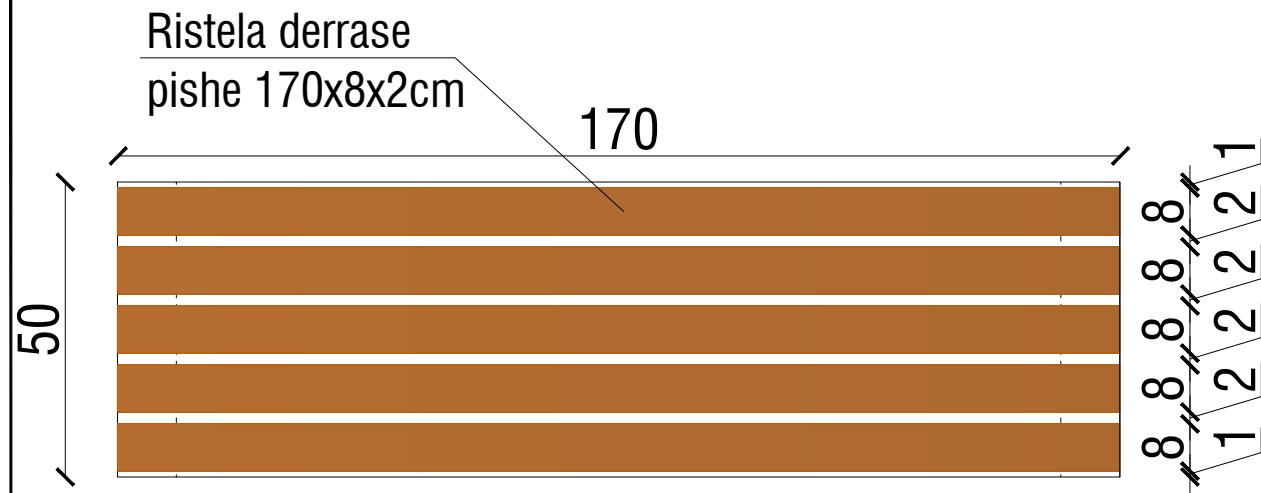

## Shenime

Investitor  
BASHKIA SHKODER



Emertimi i PROJEKTTIT  
RIKUALIFIKIM URBAN BLOQE BANIMI  
"EUROPA",  
(TEK ISH-PODGORICA)

Faza e PROJEKTTIT  
PROJEKT ZBATIM

Projekti i  
infrastruktures

Konsulenti  
C.E.C Group  
Civil Engineering Consultants

Projektori	Emer Mbiemer	Firma
Insh. Nderim	Vangjush MBRICË	
Insh. Nderim	Andaen MBRICË	
Insh. Mekanik	Paskal JARAZI	
Insh. Gjeolog	Pellumb TOSKA	
Insh. Elektrik	Gazmir ISAKAJ	
Insh. Topograf	Nuredin HAMZAI	
Arkitecte	Gentjana CENGA	
Topograf	Eroglan MUCA	

Dwg.Nr. E1.01

Emertimi fletes:  
Detaje stoli tipi 1

Shkalla:

A3 - 1:50



## Stol tip 2

Ristela derrase pishe

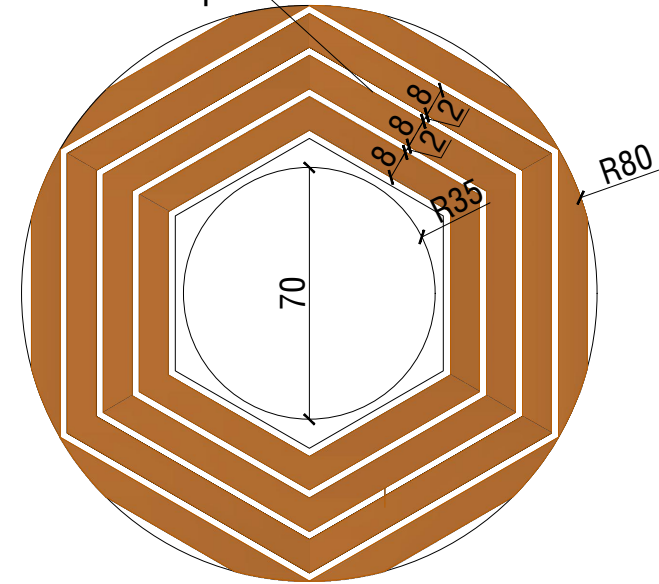

Beton i derdhur ne vend

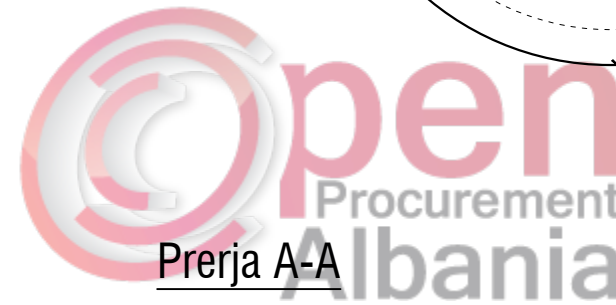
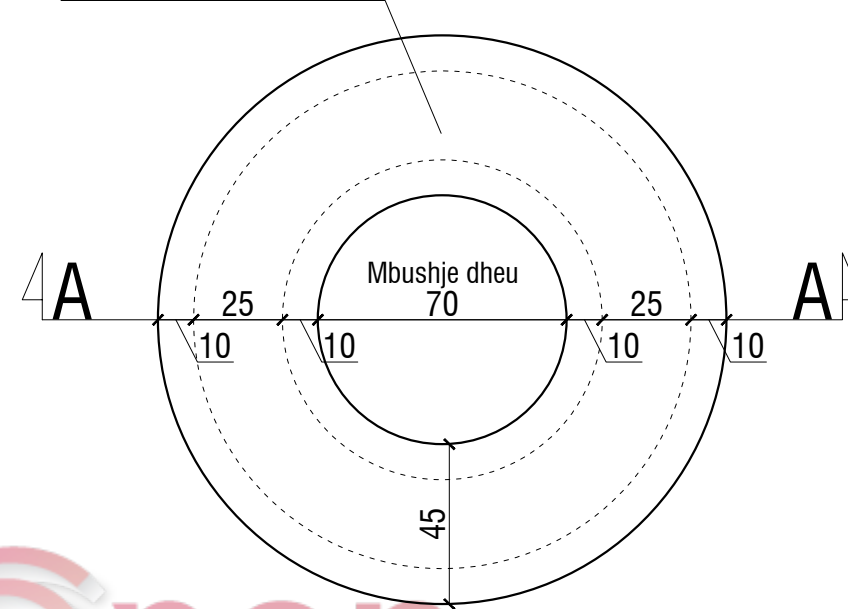

Strukture Betoni

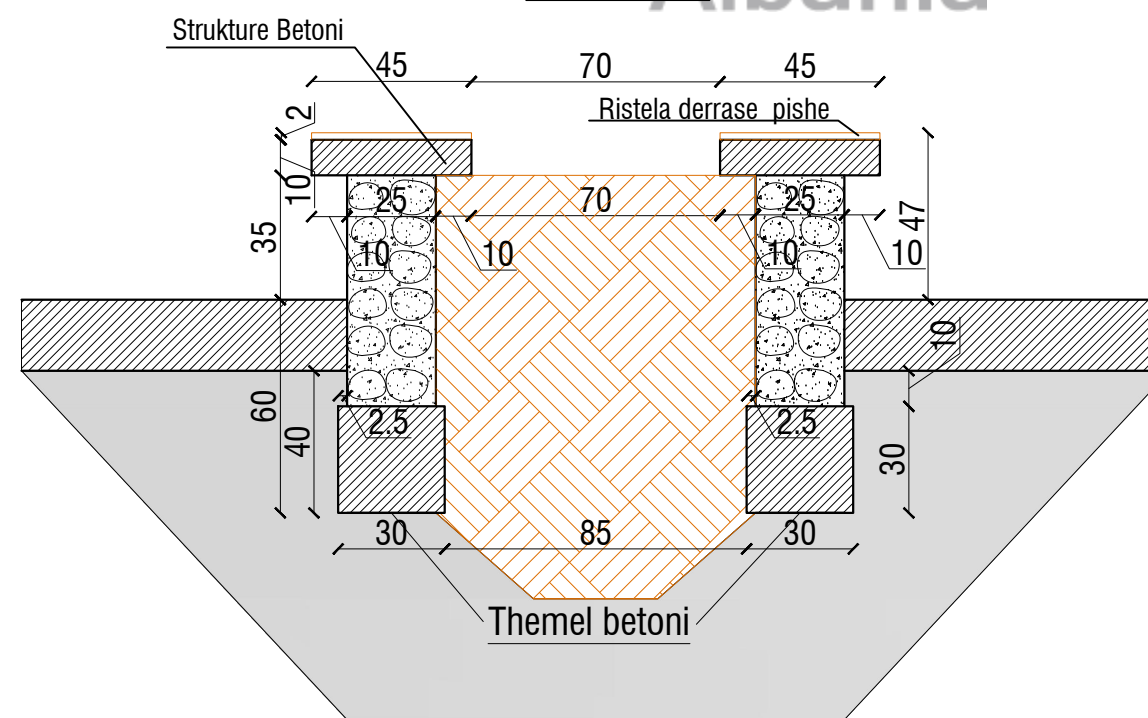

Shenime

Investitor  
BASHKIA SHKODER



Emertimi i PROJEKTTIT  
RIKUALIFIKIM URBAN BLOQE BANIMI  
"EUROPA",  
(TEK ISH-PODGORICA)

Faza e PROJEKTTIT  
PROJEKT ZBATIM

Projekti i  
infrastruktures

Konsulenti  
C.E.C Group  
Civil Engineering Consultants

Projektoi	Emer Mbiemer	Firma
Insh. Nderim	Vangjush MBRICJE	
Insh. Nderim	Andaen MBRICJE	
Insh. Mekanik	Paskal JARAZI	
Insh. Gjeolog	Pellumb TOSKA	
Insh. Elektrik	Gazmir ISAKAJ	
Insh. Topograf	Nuredin HAMZAI	
Arktekte	Gentjana CENGA	
Topograf	Eroglan MUCA	

Dwg.Nr. E1.02

Emertimi fletes:  
Detaje stoli tipi 2

Shkalla:

A3 - 1:50

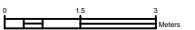

# Tavoline tip 1

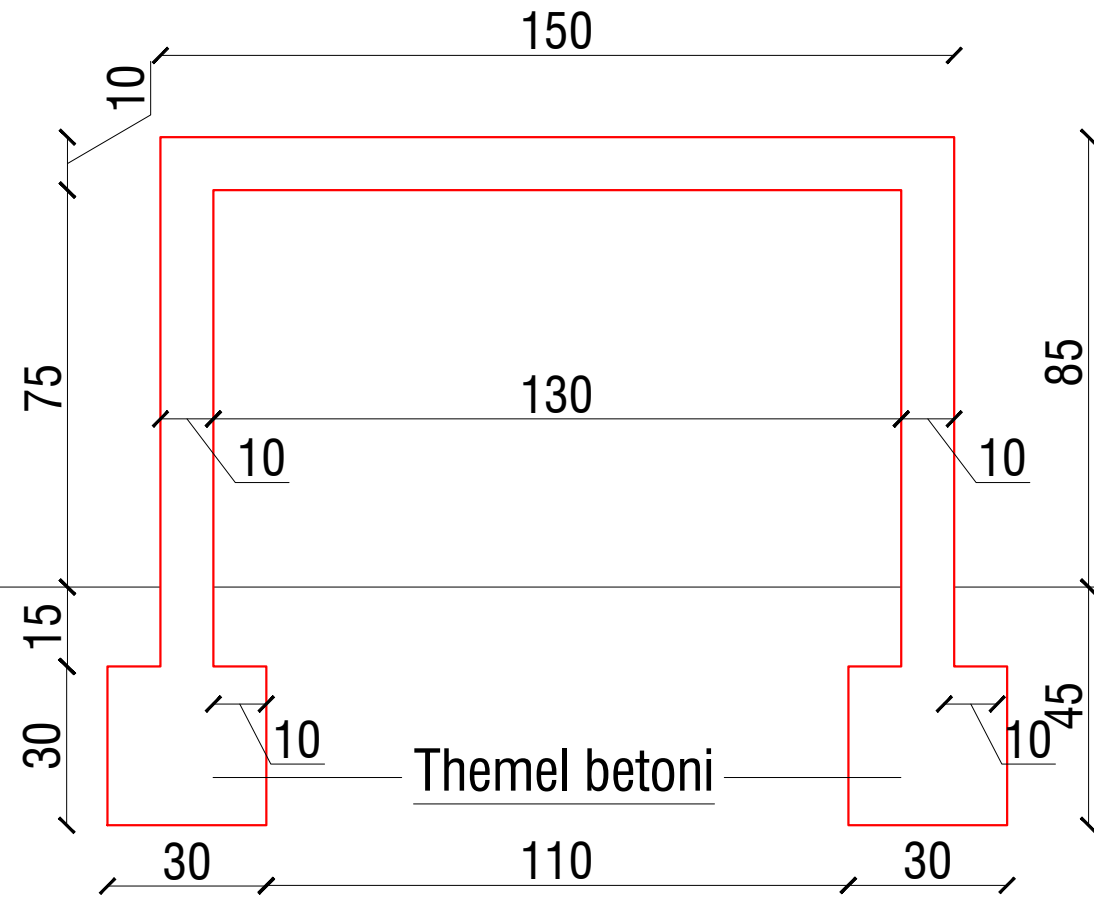

Strukture Betoni ngjyre e bardhe

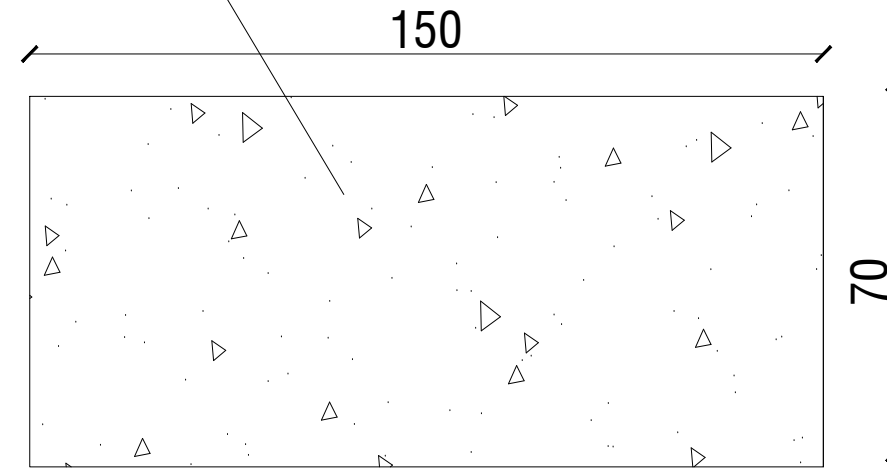

Strukture Betoni ngjyre e bardhe

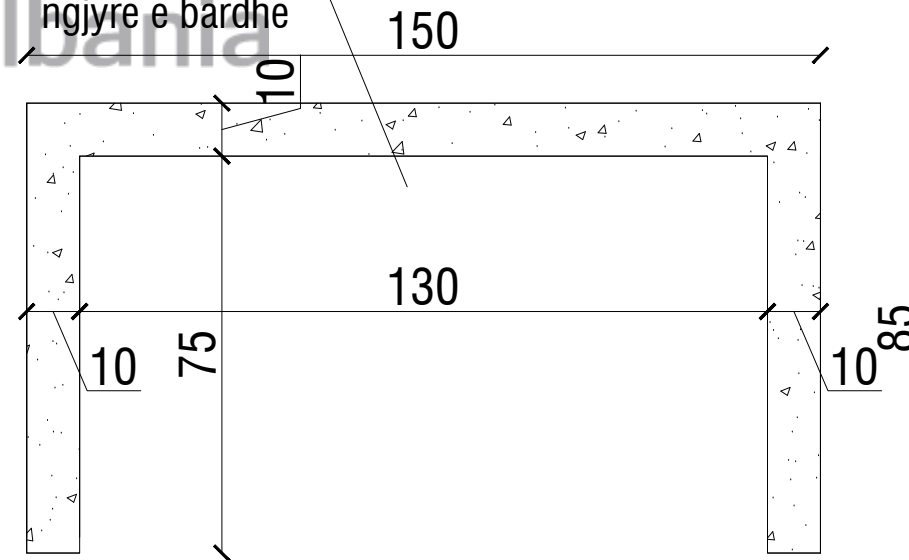

## Shenime

Investitor  
BASHKIA SHKODER



Emertimi i PROJEKTTIT  
RIKUALIFIKIM URBAN BLOQE BANIMI  
"EUROPA",  
(TEK ISH-PODGORICA)

Faza e PROJEKTTIT  
PROJEKT ZBATIM

Projekti i  
infrastrukturaes

Konsulenti  
C.E.C Group  
Civil Engineering Consultants

Projektori	Emer Mbiemer	Firma
Insh. Nderim	Vangjush MBRICJE	
Insh. Nderim	Andaen MBRICJE	
Insh. Mekanik	Paskal JARAZI	
Insh. Gjeolog	Pellumb TOSKA	
Insh. Elektrik	Gazmir ISAKAJ	
Insh. Topograf	Nuredin HAMZAI	
Arktekte	Gentjana CENGA	
Topograf	Eroglan MUCA	

Dwg.Nr. E1.03

Emertimi fletes:  
Detaje tavolina tipi 1

Shkalla:

A3 - 1:50



## Detaj bordure

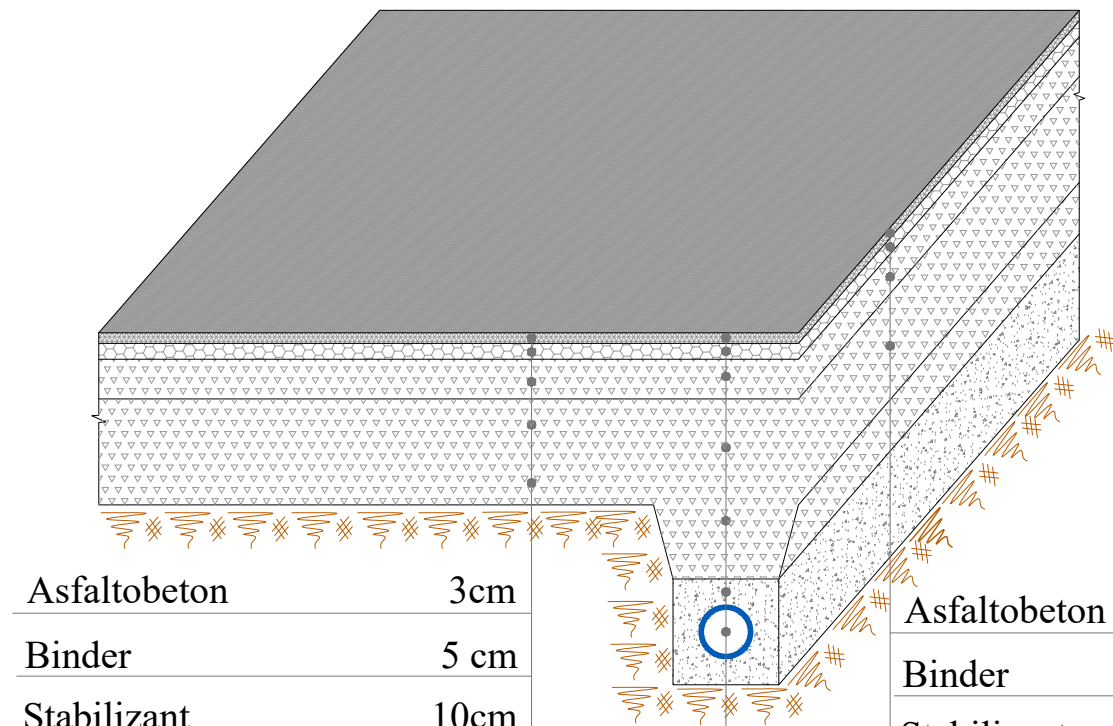

Asfaltobeton	3cm
Binder	5 cm
Stabilizant	10cm
Cakell	25 cm

Asfaltobeton	3cm
Binder	5 cm
Stabilizant	10cm
Cakell	25 cm

Asfaltobeton	3cm
Binder	5 cm
Stabilizant	10cm
Cakell	25 cm
Mbushje me cakell	
Rere	10cm
Tub Ø 315 ÷ 400	

Pllaka betoni	6 cm
Shtrese llaci	2 cm
Shtrese betoni	10 cm
Shtrese zhavorri	20 cm

Shtresat e rruges

Open  
Procurement  
Albania

BORDURA 20X35

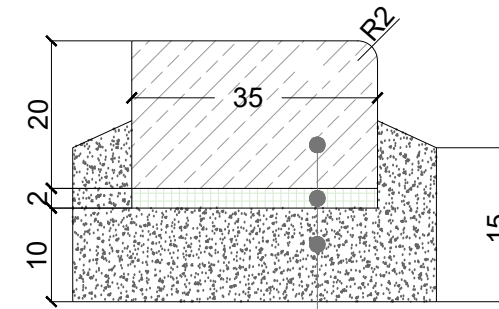

Bordure e parapergatitur

Shtrese niveluese llaci

Beton C16/20 t= 10cm per nivelimin dhe fiksimin e bordures

Bordure betoni 35x20  
M250

Asfaltobeton	3 cm
Binder	5 cm
Stabilizant	10 cm
Cakell	25 cm
Terreni ekzistues	

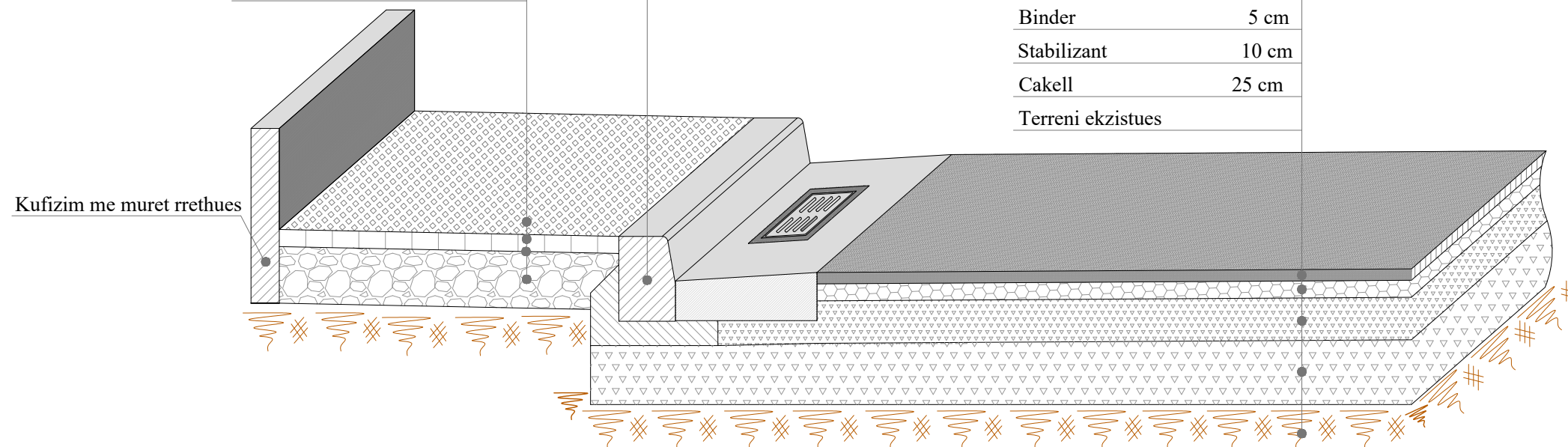

## Shenime

Investitor  
Bashkia Shkoder



Emertimi i projektit

RIKUALIFIKIM URBAN BLOQE BANIMI  
"EUROPA",  
(TEK ISH-PODGORICA)

Faza e Projektit

PROJEKT ZBATIM

Projekti i  
infrastruktures

Konsulentit

C.E.C Group  
Civil Engineering Consultants

Projektoi	Emer Mbiemer	Firma
Inxh. Nderim	Vangush MBRIÇE	
Inxh. Nderim	Anduen MBRIÇE	
Inxh. Mekanik	Paskal JARAZI	
Inxh. Gjeolog	Pellumb TOSKA	
Inxh. Elektrik	Gazmir ISAKAJ	
Inxh. Topograf	Nuredin HAMZAI	
Arkitekto	Genjiana CENGA	
Topograf	Eroglen MUCA	
Inxh. Civil	Xhensika LENGU	

Dwg.Nr. E1.05

Emertimi fletes:  
Detajet e shtresave

Shkalla:



## Ndertimi i soletes B/A kur trashesia e mbushjes mbi tub eshte me pak se Hmin=70cm

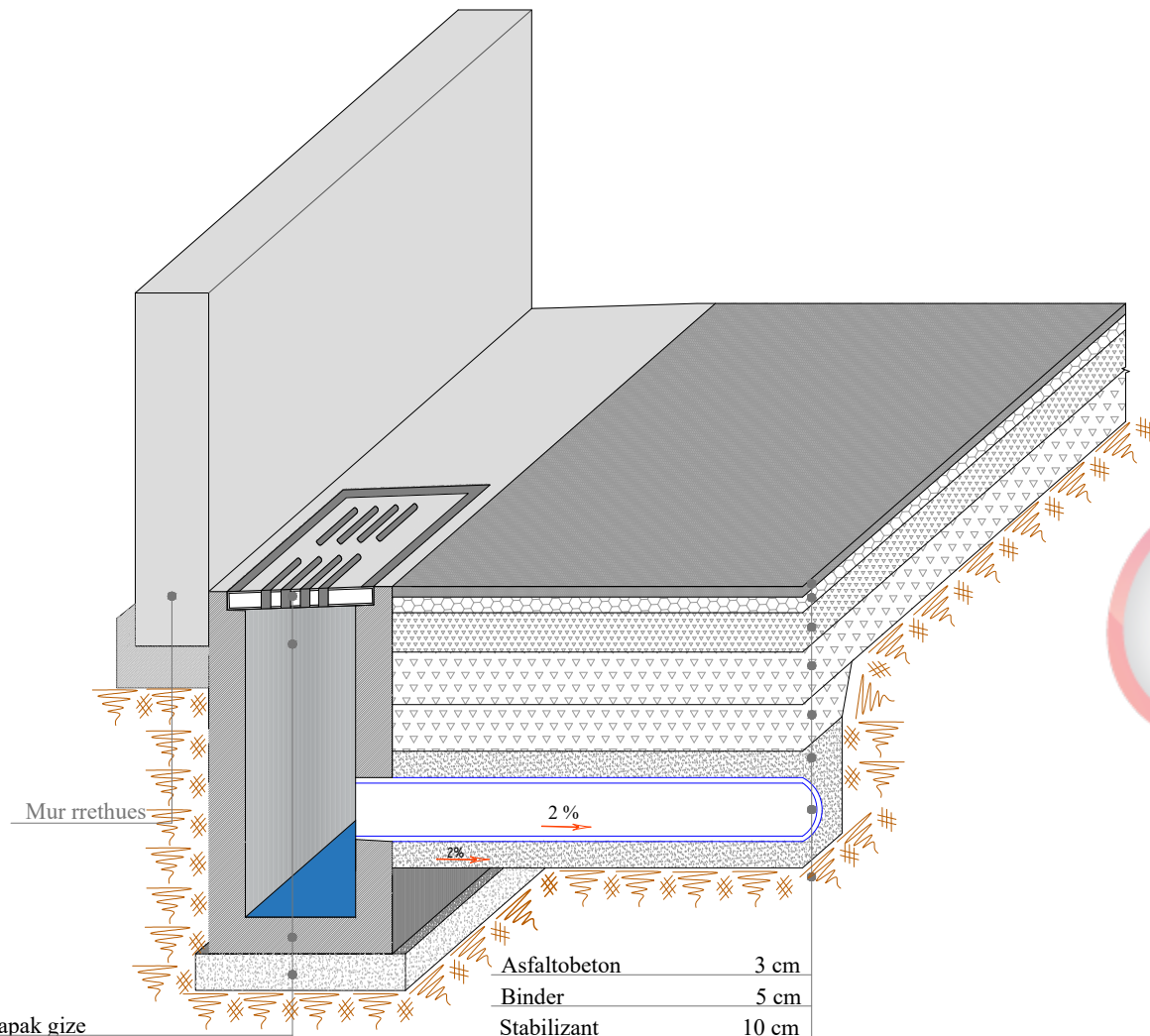

Kapak gize	
Pusete e ujrave te bardha	
Beton	10 cm
Rere	10 cm
Terreni ekzistues	

Asfaltobeton	3 cm
Binder	5 cm
Stabilizant	10 cm
Çakell	25 cm
Mbushje me zhavorr	
Rere	10 cm
Tub Ø 315 ÷ 400	
Terreni ekzistues	

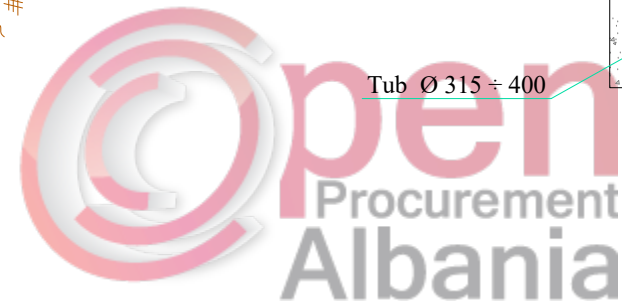
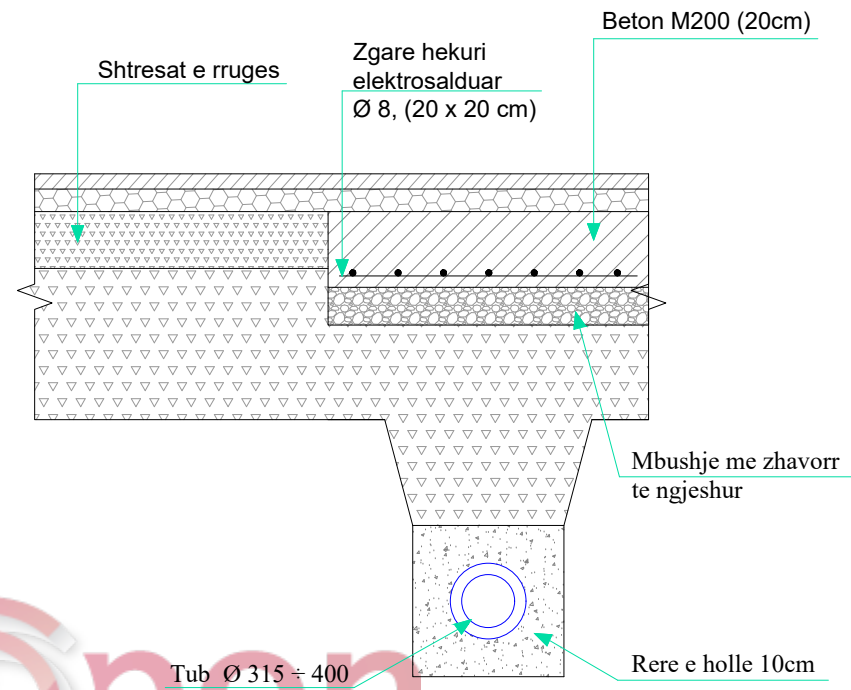

## Detaj i bashkimit te tubave me manikote

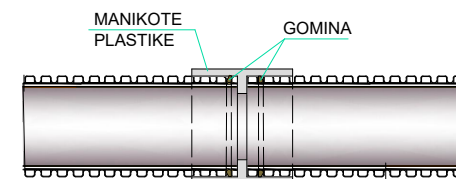

Shenime

Investitor  
Bashkia Shkoder



Emertimi i projektit  
RIKUALIFIKIM URBAN BLOQE BANIMI  
"EUROPA",  
(TEK ISH-PODGORICA)

Faza e Projektit  
PROJEKT ZBATIM

Projekti i  
infrastruktures

Konsulenti  
**C.E.C Group**  
Civil Engineering Consultants

Projektoi	Emer Mbiemer	Firma
Inxh. Nderim	Vangjush MBRICË	
Inxh. Nderim	Anduen MBRICË	
Inxh. Mekanik	Paskal JARAZI	
Inxh. Gjeolog	Pellumb TOSKA	
Inxh. Elektrik	Gazmir ISAKAJ	
Inxh. Topograf	Nuredin HAMZAI	
Arkitekte	Genjiana CENGA	
Topograf	Eroglan MUCA	

Dwg.Nr. E1.06

Emertimi fletes:  
Detajet e shtresave

Shkalla:

## DETAJE TE PusetAVE TE UJRAVE TE BARDHA

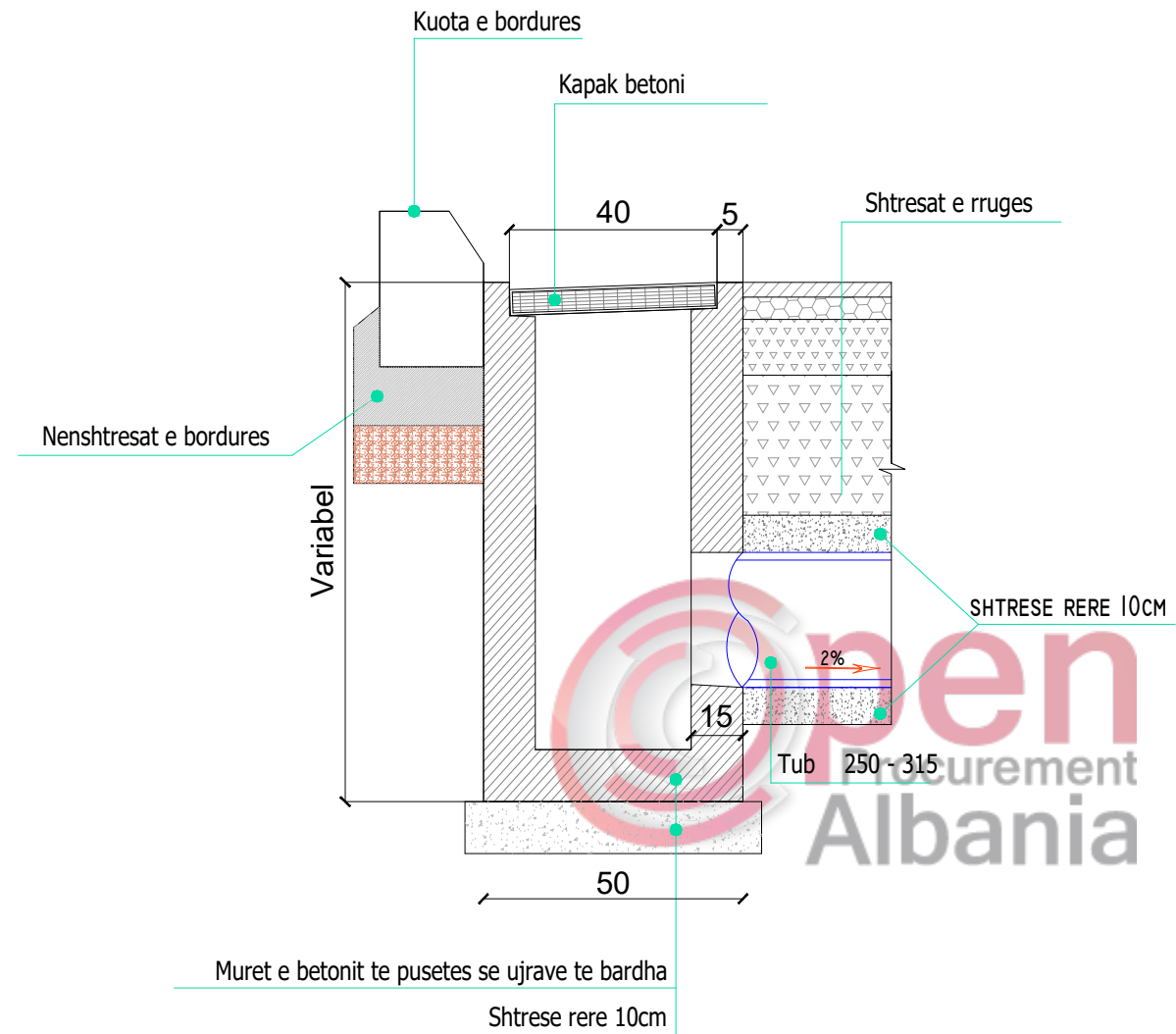

### Shenime

Investitor  
Bashkia Shkoder



Emertimi i projektit  
RIKUALIFIKIM URBAN BLOQE BANIMI  
"EUROPA",  
(TEK ISH-PODGORICA)

Faza e Projektit  
PROJEKT ZBATIM

Projekti i  
infrastruktures

Konsulenti  
**C.E.C Group**  
Civil Engineering Consultants



Projektoi	Emer Mbiemer	Firma
Inxh. Nderim	Vangjush MBRICË	
Inxh. Nderim	Anduen MBRICË	
Inxh. Mekanik	Paskal JARAZI	
Inxh. Gjeolog	Pellumb TOSKA	
Inxh. Elektrik	Gazmir ISAKAJ	
Inxh. Topograf	Nuredin HAMZAI	
Arkitekto	Gentjana CENGA	
Topograf	Eroglan MUCA	

Dwg.Nr. E1.07



Emertimi fletes:  
Detaj i pusetave te ujrave te bardha



Shenime

Legjenda:

- Tub Ø 315 per KUB
- Tub Ø 315 per KUZ
- Tub Ø 63 per rrjetin e ujesjellesit

-  Pusete e ujrave te bardha
-  Pusete e ujrave te zeza
-  Pusete ujesjellesi

Investitor  
Bashkia Shkoder



Emertimi i projektit  
RIKUALIFIKIM URBAN BILLOQE BANIMI  
"EUROPA",  
(TEK ISH-PODGORICA)

Faza e Projektit  
PROJEKT ZBATIM

Projekti i infrastruktures

Konsulent  
**C.E.C Group**  
Civil Engineering Consultants

Projektoi	Emer Mbiemer	Firma
Insh. Nderim	Vangjosh MBRICË	
Insh. Nderim	Andren MBRICË	
Insh. Mekanik	Paskal JARAZI	
Insh. Gjeolog	Pellumb TOSKA	
Insh. Elektrik	Gazmir ISAKAJ	
Insh. Topograf	Nuredin HAMZAI	
Arkitekte	Gentjana CENGA	
Topograf	Eroglan MUCA	

Dwg.Nr. F1.01

Emertimi fletes:  
Planimetria e ndricimit

Shkalla:  
A3 - 1:250

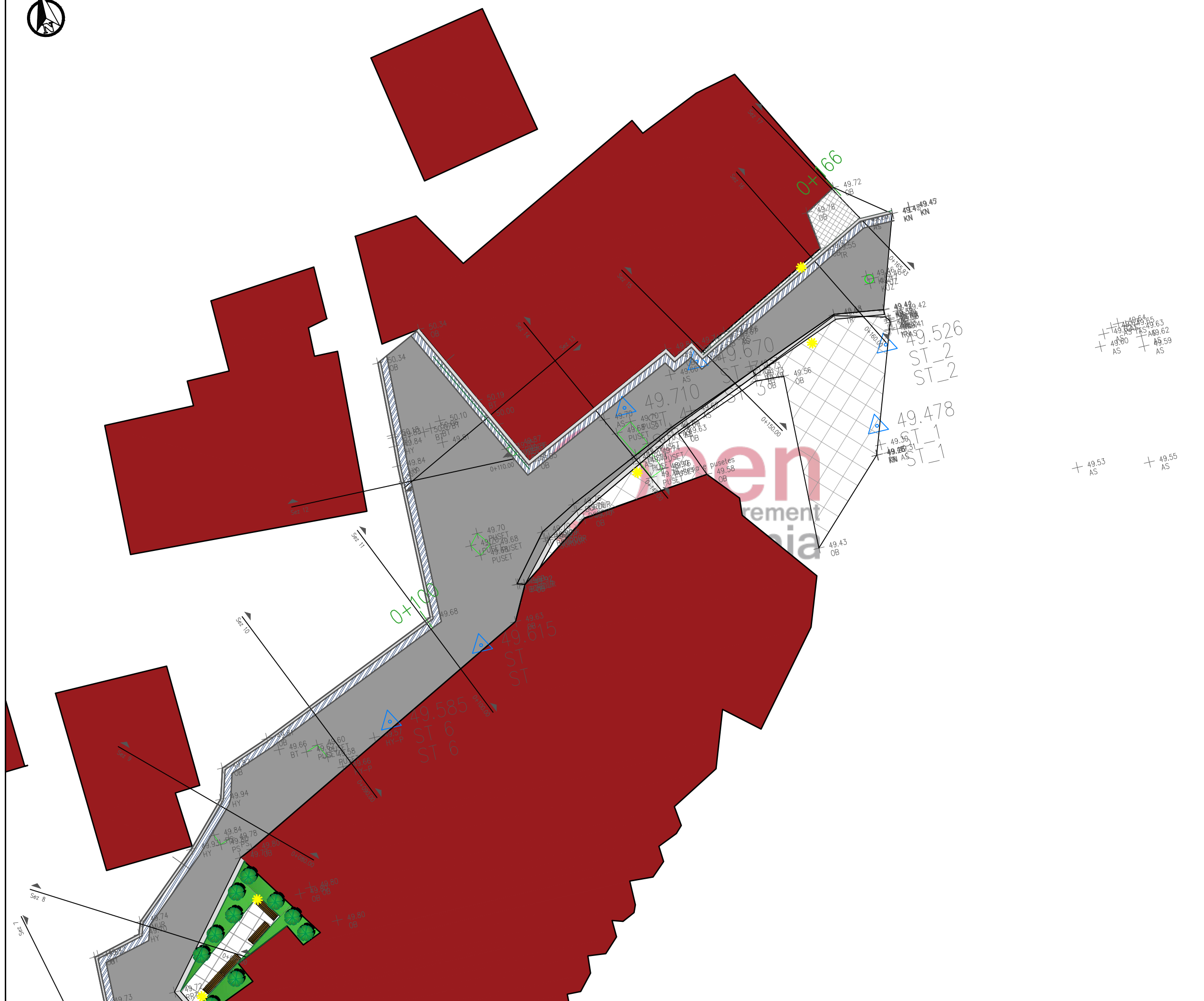

Shenime		
Legjenda:		
Tub Ø 315 per KUB		
Tub Ø 315 per KUZ		
Tub Ø 63 per rrjetin e ujesjellesit		
	Pusete e ujrave te bardha	
	Pusete e ujrave te zeza	
	Pusete ujesjellesi	
Investitor		
Bashkia Shkoder		
Emertimi i projektit	RIKUALIFIKIM URBAN BLOQE BANIMI "EUROPA", (TEK ISH-PODGORICA)	
Faza e Projektit	PROJEKT ZBATIM	
Projekti i infrastruktures		
Konsulent		
Projektoi	Emer Mbiemer	Firma
Insh. Nderim	Vangjush MBRIÇE	
Insh. Nderim	Andrius MBRIÇE	
Insh. Mekanik	Paskal JARAZI	
Insh. Gjeolog	Pellumb TOSKA	
Insh. Elektrik	Gazmir ISAKAJ	
Insh. Topograf	Nuredin HAMZAI	
Arkitekte	Gentjana CENGA	
Topograf	Eroglen MUCA	
Dwg.Nr. F1.02		
Emertimi fletes: Planimetria e ndricimit		
Shkalla: A3 - 1:250		

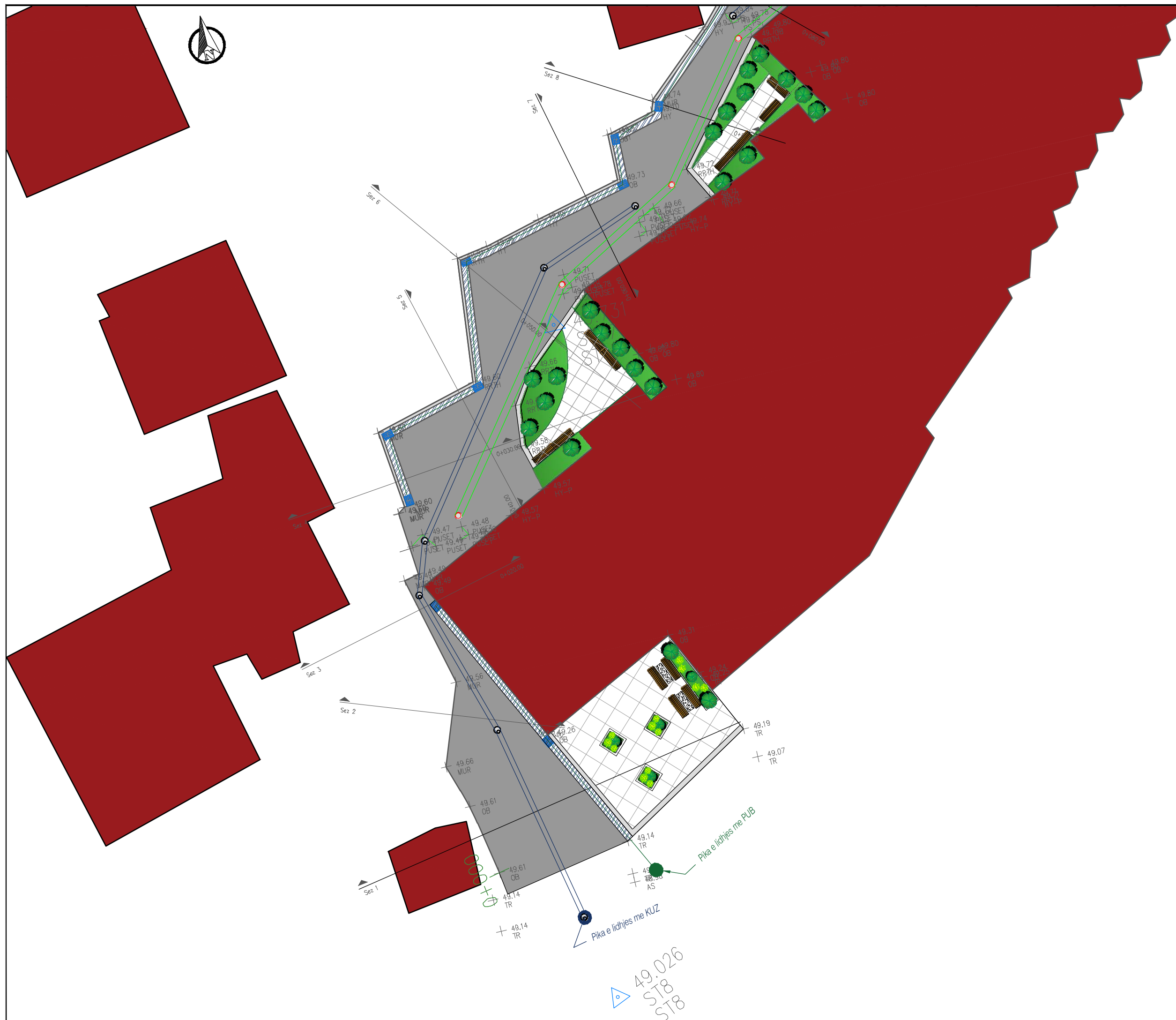

**Shenime**

**Legjenda:**

- Tub Ø 315 per KUB
- Tub Ø 315 per KUZ
- Tub Ø 63 per rrjetin e ujesjellesit
- Pusete e ujrave te bardha
- Pusete e ujrave te zeza
- Pusete ujesjellesi

---

Investitor Bashkia Shkoder

Emertimi i projektit  
RIKUALIFIKIM URBAN BILLOQE BANIMI  
"EUROPA",  
(TEK ISH-PODGORICA)

Faza e Projektit  
PROJEKT ZBATIM

**Projekti i infrastruktures**

Konsulentit C.E.C Group  
Civil Engineering Consultants

Projektoi	Emer Mbiemer	Firma
Insh. Nderim	Vangjosh MBRIÇE	
Insh. Nderim	Andren MBRIÇE	
Insh. Mekanik	Paskal JARAZI	
Insh. Gjeolog	Pellumb TOSKA	
Insh. Elektrik	Gazmir ISAKAJ	
Insh. Topograf	Nuredin HAMZAI	
Arkitekte	Gentjana CENGA	
Topograf	Eroglan MUCA	

Dwg.Nr. K1.01

Emertimi fletes:  
Planimetria e kanalizimeve

---

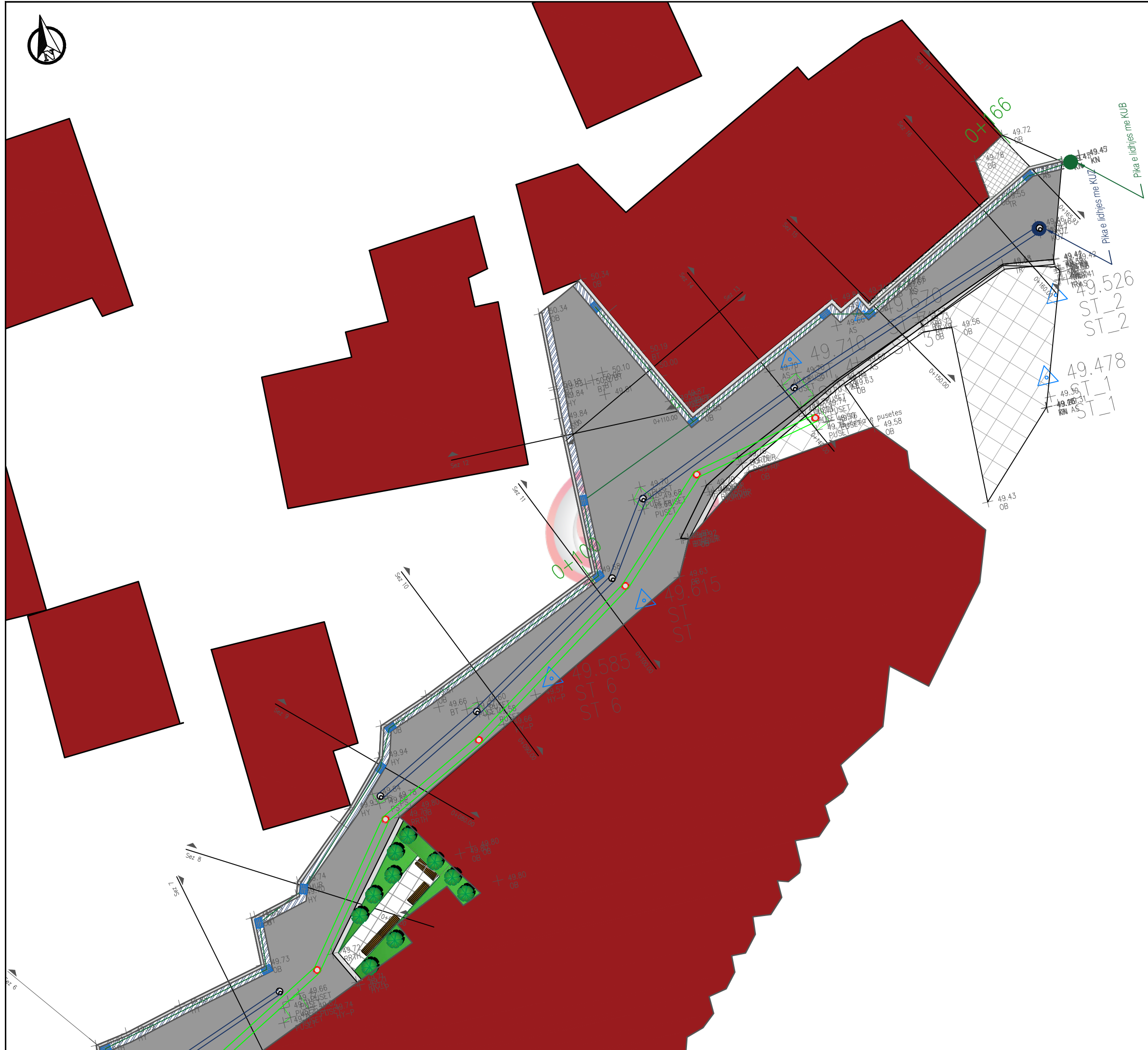

Shkalla:  
A3 - 1:250

49.026  
ST8  
ST8



Shenime

Legjenda:

- Tub Ø 315 per KUB
- Tub Ø 315 per KUZ
- Tub Ø 63 per rrjetin e ujesjellesit
-  Pusetes e ujrave te bardha
-  Pusetes e ujrave te zeza
-  Pusetes ujesjellesi

Investitor  
Bashkia Shkoder



Emertimi i projektit  
RIKUALIFIKIM URBAN BILLOQE BANIMI  
"EUROPA",  
(TEK ISH-PODGORICA)

Faza e Projektit  
PROJEKT ZBATIM

Projekti i infrastruktures

Konsulenti



Projektoi	Emer Mbiemer	Firma
Insh. Nderim	Vangjush MBRIÇE	
Insh. Nderim	Andrius MBRIÇE	
Insh. Mekanik	Paskal JARAZI	
Insh. Gjeolog	Pellumb TOSKA	
Insh. Elektrik	Gazmir ISAKAJ	
Insh. Topograf	Nuredin HAMZAI	
Arkitekte	Genjuna CENGA	
Topograf	Eroglen MUCA	

Dwg.Nr. K1.02

Emertimi fletes:  
Planimetria e kanalizimeve

Shkalla:  
A3 - 1:250