

# RIPARIMI I RRUGES HYRJE ZHAPOKIKE

Per Sektorin e Zhvillimit Urban dhe Kadastres

Ing. Violeta Kanushi

Topograf Petrit H. Hoxha

Miratohet

Kryetari

**DURIM RROSHI**



BASHKIA MEMALIAJ

Per C.E.C Group  
Ing. Vangjush Mbrice

**C.E.C Group**   
Civil Engineering Consultants





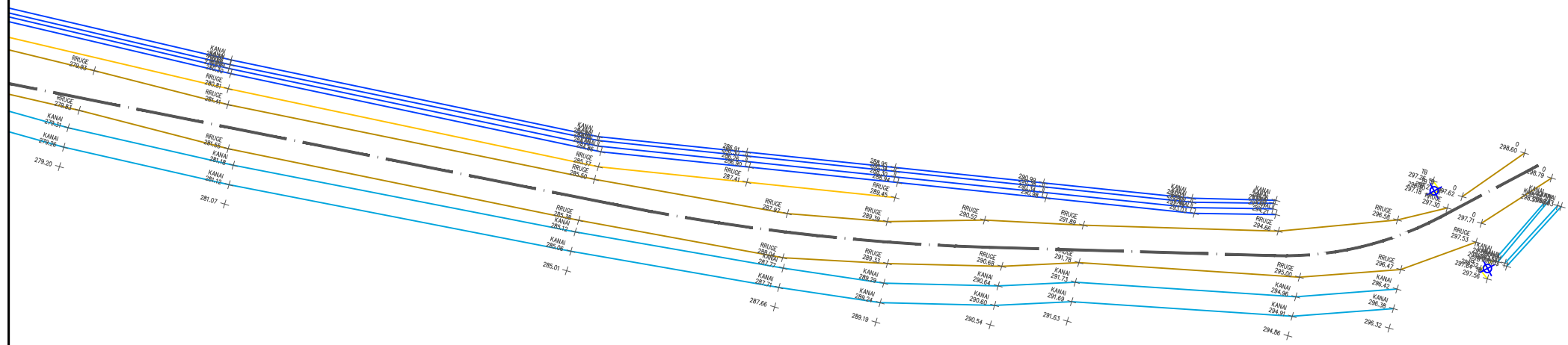

Shenime

Investitor  
Bashkia Memaliaj



Emertimi i projektit  
RIPARIMI I RRUGES HYRJE ZHAPOKIKE

Faza e Projektit  
PROJEKT ZBATIM

Projekti i  
infrastruktures

Konsulentë



Projektoi	Emer Mbiemer	Firma
Insh. Nderim	Vangjush MBRICË	
Insh. Nderim	Andren MBRICË	
Insh. Topograf	Nuredin HAMZAI	

Dwg.Nr. A1.03

Emertimi fletes:  
Topografia

KM.

Shkalla:

A3 - 1:500



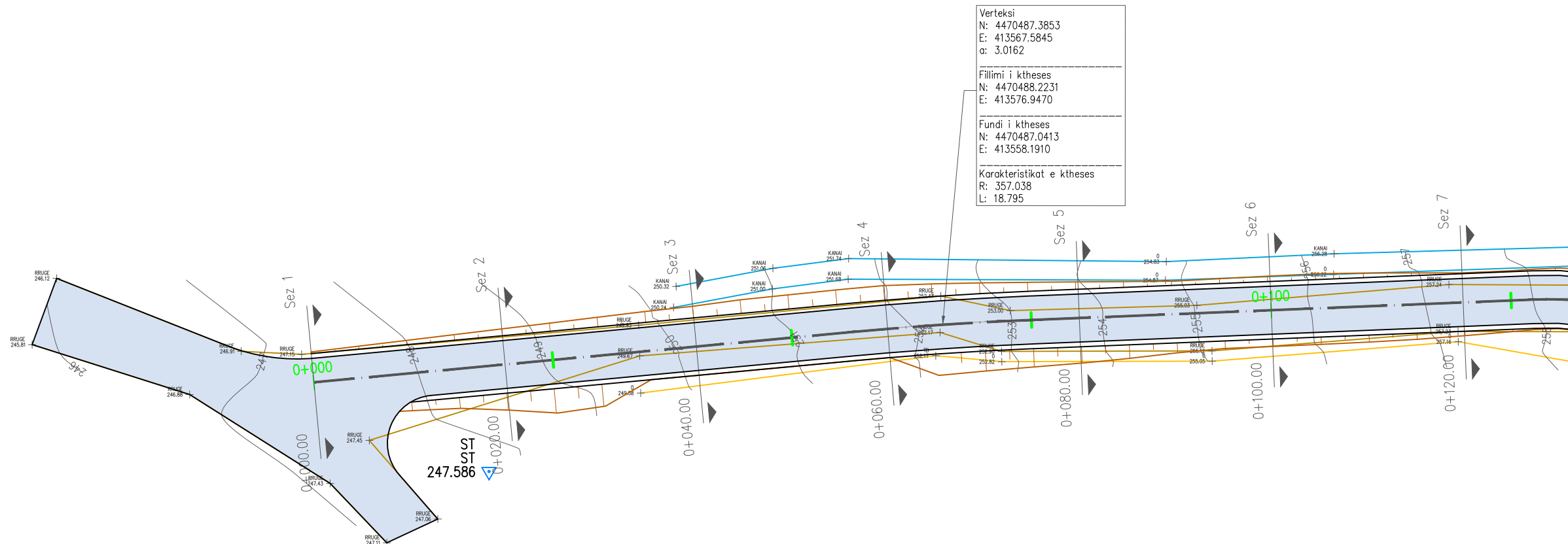

Shenime

Investitor  
 Bashkia Memaliaj



Emertimi i projektit

RIPARIMI I RRUGES HYRJE ZHAPOKIKE

Faza e Projektit

PROJEKT ZBATIM

**Projekti i infrastruktures**

Konsulentit



Projektoi	Emer Mbiemer	Firma
Insh. Nderim	Vangjush MBRICË	
Insh. Nderim	Andren MBRICË	
Insh. Topograf	Nuredin HAMZAI	

Dwg.Nr. B1.01

Emertimi fletes:  
 Planimetria

Shkalla:

A3 - 1:500

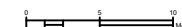

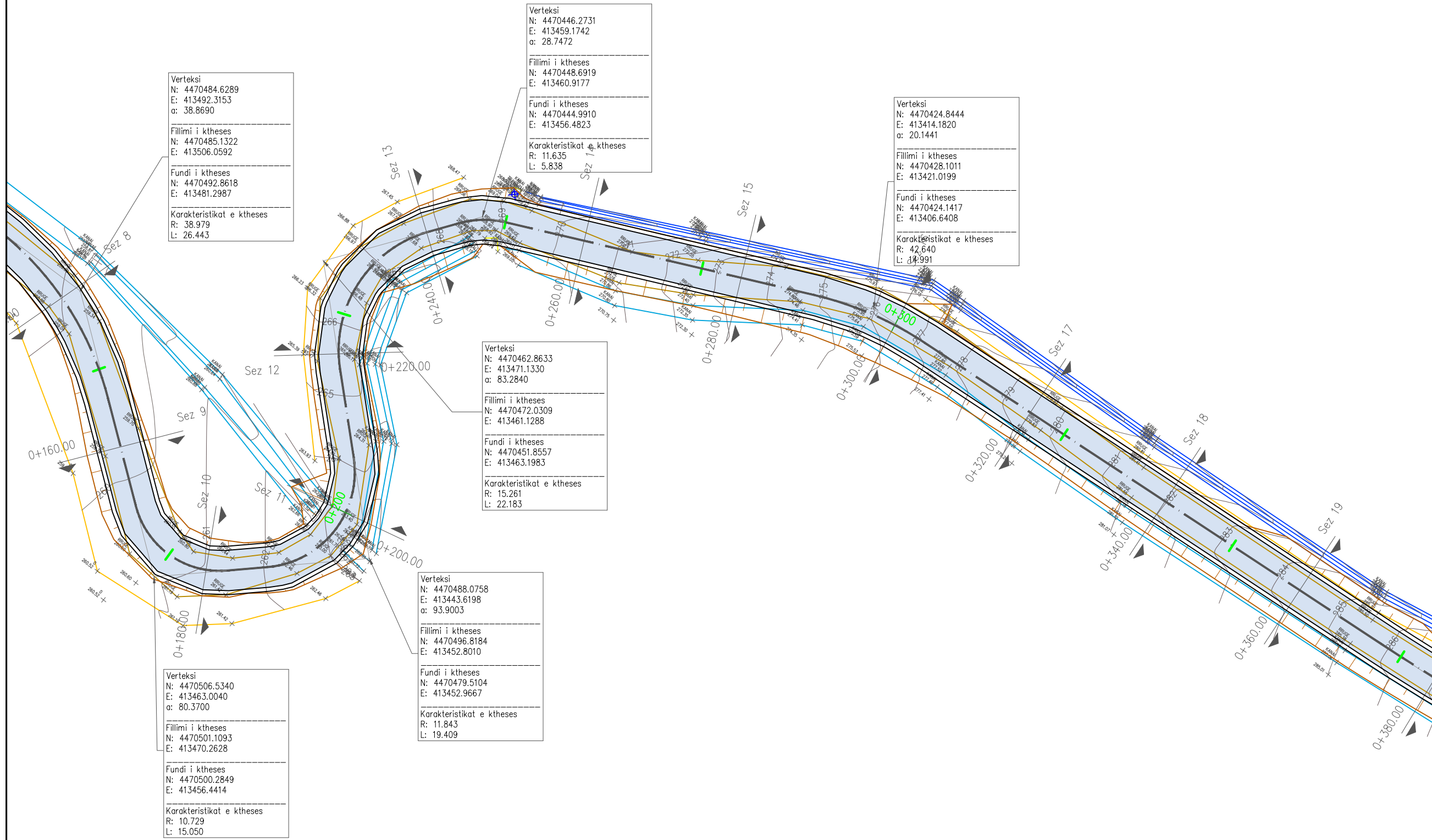

Shenime

Investitor  
Bashkia Memalaj



Emertimi i projektit  
RIPARIMI I RRUGES HYRJE ZHAPOKKE

Faza e Projektit  
PROJEKT ZBATIM

Projekti i infrastruktures

Konsulentit



Projektoi	Emer Mbiemer	Firma
Insh. Nderim	Vangjush MBRICË	
Insh. Nderim	Andren MBRICË	
Insh. Topograf	Nuredin HAMZAI	

Dwg.Nr. B1.02

Emertimi fletes:  
Planimetria

Shkalla:

A3 - 1:500



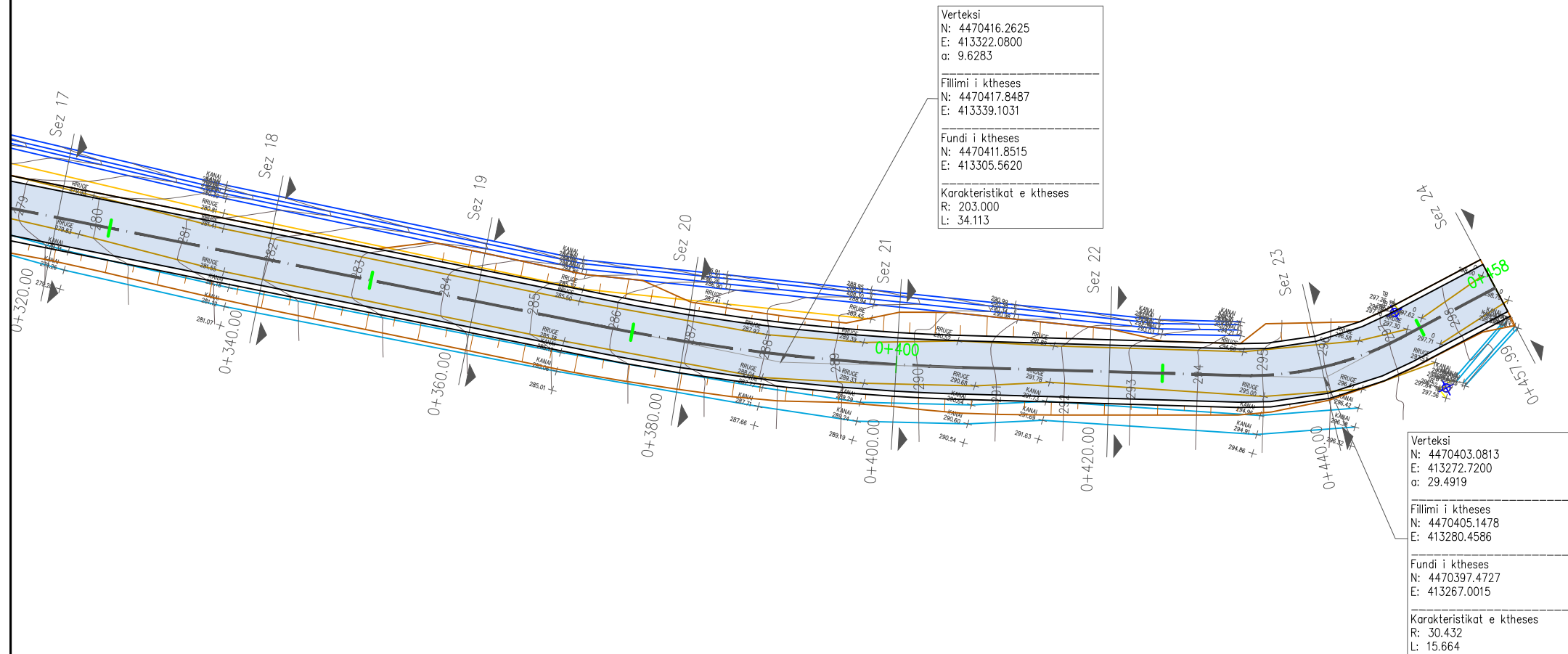

Shenime

Investitor  
 Bashkia Memaliaj



Emertimi i projektit  
 RIPARIMI I RRUGES HYRJE ZHAPOKIKE

Faza e Projektit  
 PROJEKT ZBATIM

**Projekti i infrastruktures**

Konsulentë



Projektoi	Emer Mbiemer	Firma
Insh. Nderim	Vangjush MBRICË	
Insh. Nderim	Andren MBRICË	
Insh. Topograf	Nuredin HAMZAI	

Dwg.Nr. B1.03

Emertimi fletes:  
 Planimetria

Shkalla:

A3 - 1:500



NIVELETA

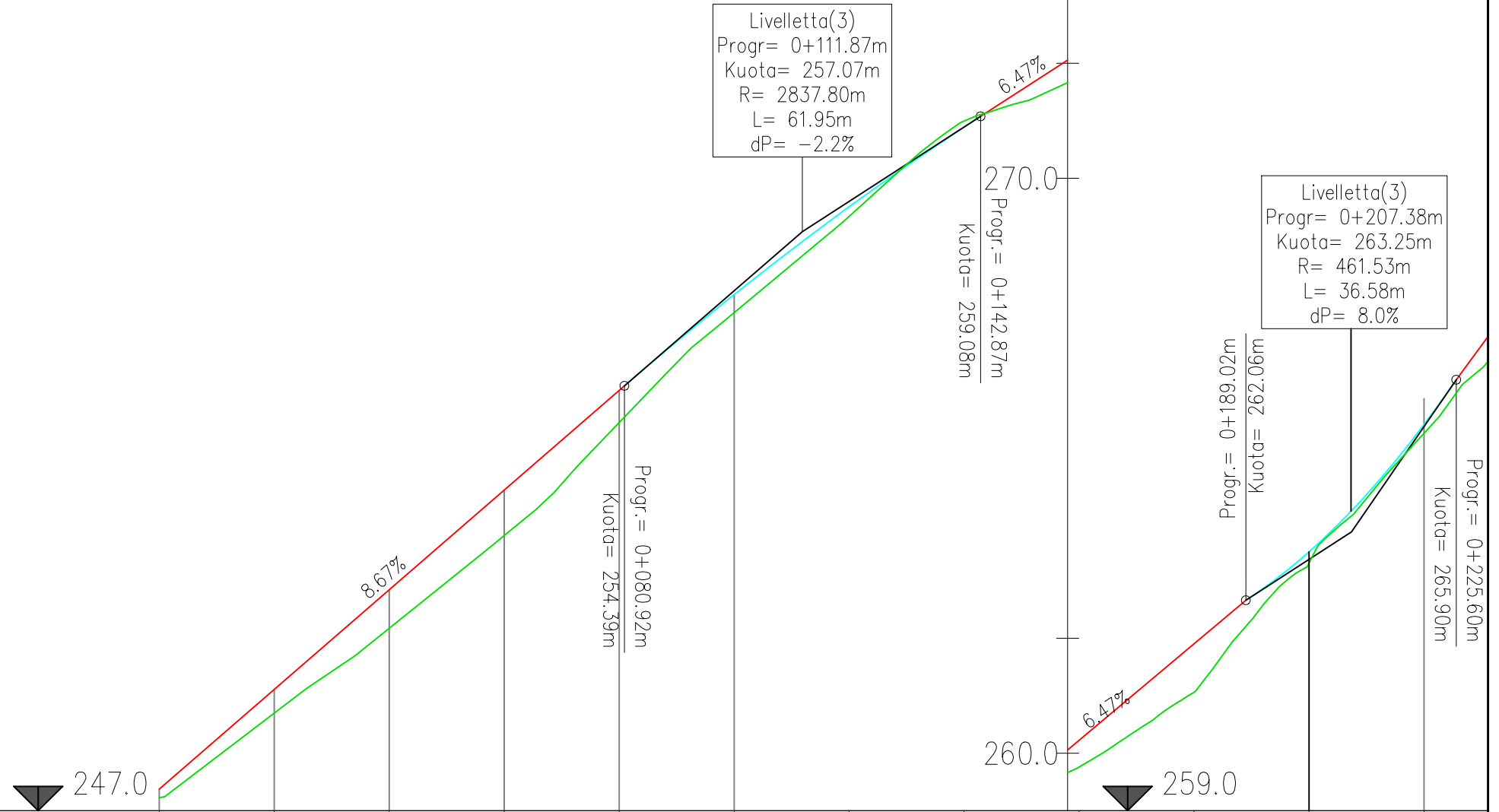
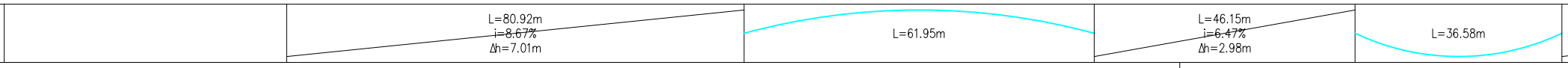

Profili gjatesor  
Shk. : 500:50

NUMRI I SEKSIONIT	1	2	3	4	5	6	7	8	9	10	11	12
DISTANCE PROGRESIVE	0+000.00	0+020.00	0+040.00	0+060.00	0+080.92	0+100.00	0+120.00	0+140.00	0+160.00	0+180.00	0+200.00	0+220.00
DISTANCE PJESORE		20,00	20,00	20,00	20,00	20,00	20,00	20,00	20,00	20,00	20,00	20,00
KUOTE PROJEKTI	247,37	249,11	250,84	252,58	254,31	256,05	257,79	259,53	261,27	263,01	264,75	266,49
KUOTE TERRENI	247,22	246,70	250,17	251,78	251,75	255,66	257,34	259,00	259,76	261,06	263,51	265,57
KILOMETRAZHI	0	0				10					20	

Shenime

---

Investitor  
Bashkia Memaliaj

Emertimi i projektit  
RIPARIMI I RRUGES HYRJE ZHAPOKIKE

Faza e Projektit  
PROJEKT ZBATIM

**Projekti i infrastruktures**

Konsulentit

Projektoi	Emer Mbiemer	Firma
Insh. Nderim	Vangjush MBRICË	
Insh. Nderim	Andren MBRICË	
Insh. Topograf	Nuredin HAMZAI	

Dwg.Nr. C1.01

Emertimi fletes:  
Profili gjatesor

Shkalla:  
**A3 - 1:500**



NIVELETA

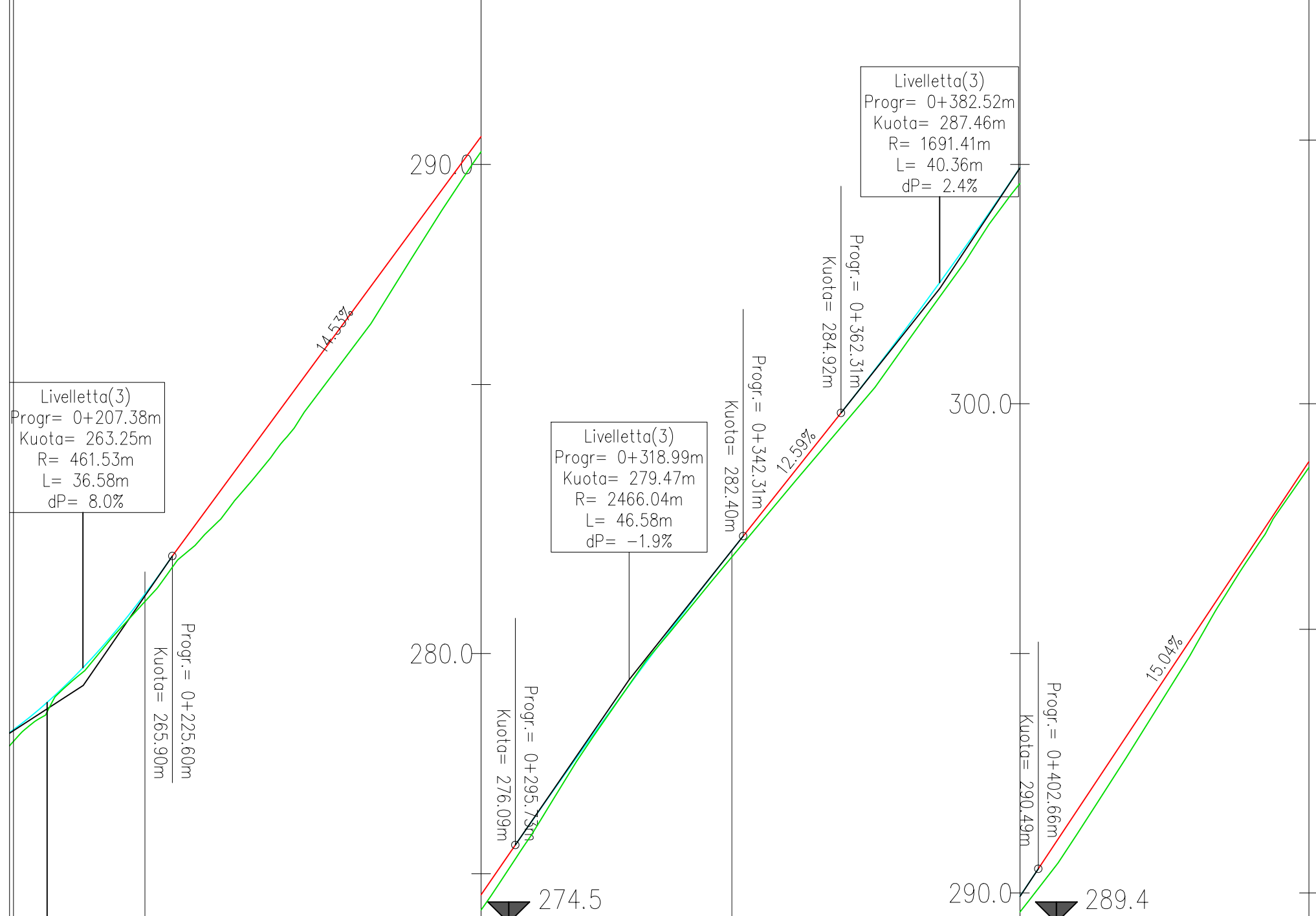
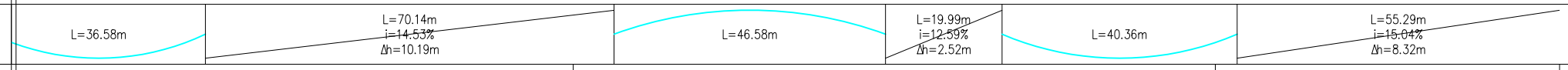

Profili gjatesor  
Shk. : 500:50

NUMRI I SEKSIONIT	11	12	13	14	15	16	17	18	19	20	21	22	23	24
DISTANCE PROGRESIVE	0+000.00	0+026.58	0+046.72	0+086.86	0+127.00	0+163.58	0+200.16	0+210.15	0+230.14	0+250.13	0+270.12	0+290.11	0+310.10	0+330.09
DISTANCE PJESORE		20,00	20,00	20,00	20,00	20,00	20,00	20,00	20,00	20,00	20,00	20,00	20,00	17,99
KUOTE PROJEKTI	263.25	265.90	267.99	270.89	273.80	276.70	279.49	282.28	284.97	287.46	289.95	292.44	294.93	297.42
KUOTE TERRENI	263.31	265.57	267.82	271.42	274.45	276.42	278.50	281.82	284.36	286.95	289.75	292.10	294.95	296.70
KILOMETRAZHI	20					50					70			

**Shenime**

Investitor: Bashkia Memaliaj

Emertimi i projektit: RIPARIMI I RRUGES HYRJE ZHAPOKIKE

Faza e Projektit: PROJEKT ZBATIM

**Projekti i infrastruktures**

Konsulentë: C.E.C Group

Projektoi	Emer Mbiemer	Firma
Insh. Nderim	Vangjush MBRICË	
Insh. Nderim	Andren MBRICË	
Insh. Topograf	Nuredin HAMZAI	

Dwg.Nr. C1.02

Emertimi fletes: Profili gjatesor

Shkalla: A3 - 1:500

Mat. ne progr. 0+000.00

Materiale	Sip. (m <sup>2</sup> )	Vol. (m <sup>3</sup> )	Vol. Cum. (m <sup>3</sup> )
Cermim	1.59	0.00	0.00
Mbushje	0.00	0.00	0.00

Seksioni nr. 1  
 Progr. 0+000.00  
 Shk. 1:100  
 K.Ref. 240.00m

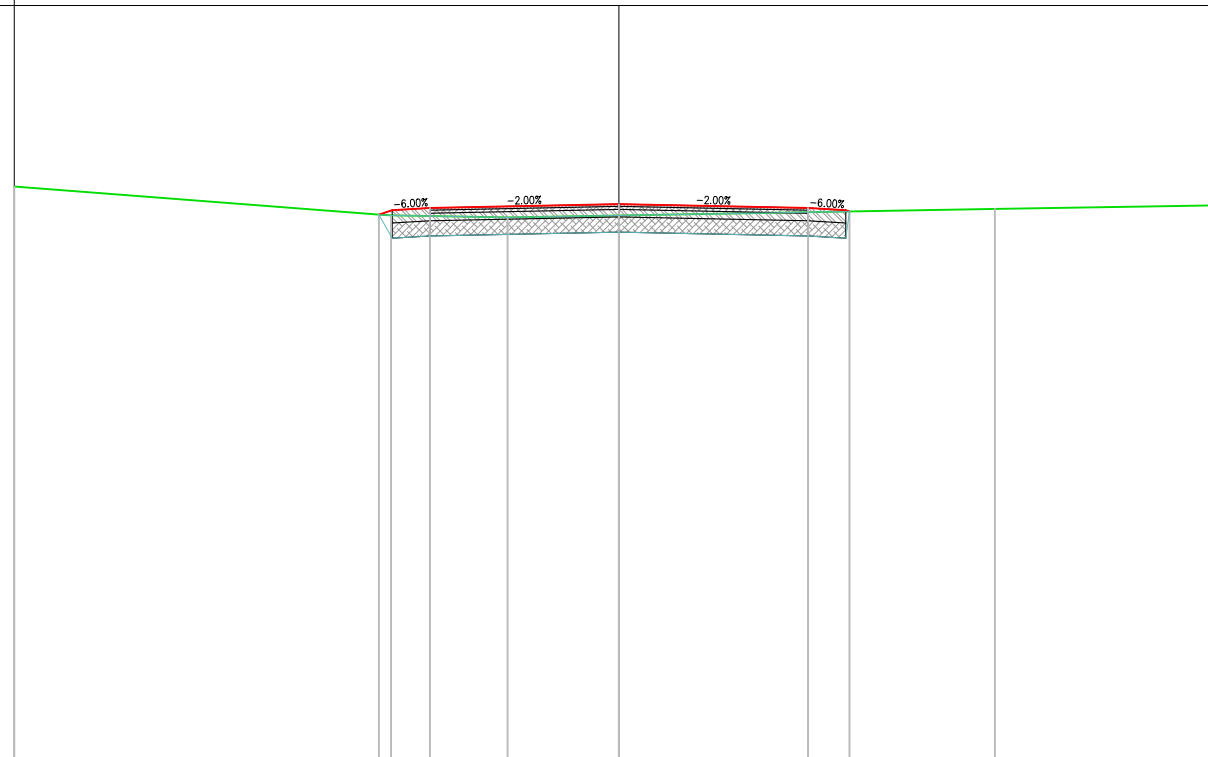

PROGRESIVE TERRENI	8.00	-3.02	-1.47	4.97	8.00			
KUOTE TERRENI	247.61	247.23	247.20	247.22	247.31	247.36		
DISTANCE PUESORE TERRENI	4.89	1.54	1.47	4.97	3.03			
PROGRESIVE PROJEKTI		-3.18	-3.00	-2.50	2.50	3.00	3.05	
KUOTE PROJEKTI		247.24	247.29	247.32	247.37	247.32	247.29	247.28
DISTANCE PUESORE PROJEKTI			0.50	2.50	2.50	0.50		

Shenime

Investitor  
 Bashkia Memaliaj



Emertimi i projektit

RIPARIMI I RRUGES HYRJJE ZHAPOKIKE

Faza e Projektit

PROJEKT ZBATIM

Projekti i  
 infrastruktures

Konsulentit



Projektori Emer Mbiemer Firma

Insh. Nderim Vangjush MBRICJE

Insh. Nderim Andan MBRICJE

Insh. Topografi Nuredin HAMZAI

Dwg.Nr. D1.01

Emertimi fletes:  
 Profilat terthore progresive

Shkalla:

A3 - 1:100

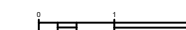

Mat. ne progr. 0+020.00

Materiale	Sip. (m <sup>2</sup> )	Vol. (m <sup>3</sup> )	Vol. Cum. (m <sup>3</sup> )
Cermim	0.11	14.83	14.83
Mbushje	0.18	1.24	1.24

Seksioni nr. 2  
 Progr. 0+020.00  
 Shk. 1:100  
 K.Ref. 240.00m

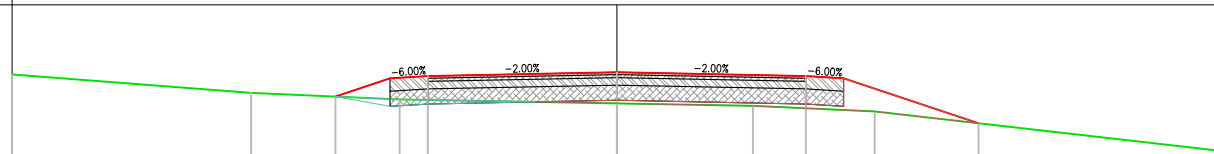

PROGRESIVE TERRENI	8.00	-4.84	-2.87		1.80	3.41	8.00
KUOTE TERRENI	248.08	248.84	248.75		248.70	248.66	248.59
DISTANCE PJESORE TERRENI	3.16	1.96	2.87		1.80	1.61	4.59
PROGRESIVE PROJEKTI		-3.72	-3.00	-2.50	0.00	2.50	3.00
KUOTE PROJEKTI		248.79	249.03	249.06	249.11	249.06	249.03
DISTANCE PJESORE PROJEKTI		0.72	0.50	2.50	2.50	0.50	1.78

Shenime		
Investitor	Bashkia Memaliaj	
Emertimi i projektit	RIPARIMI I RRUGES HYRJE ZHAPOKIKE	
Faza e Projektit	PROJEKT ZBATIM	
<b>Projekti i infrastruktures</b>		
Konsulenti	 C.E.C Group Civil Engineering Consultants	
Projektori	Emer Mbiemer	Firma
Insh. Nderim	Vangjush MBRICJE	
Insh. Nderim	Andaen MBRICJE	
Insh. Topografi	Nuredin HAMZAI	
Dwg.Nr. D1.02		
Emertimi fletes: Profilat terthore progresive		
Shkalla: A3 - 1:100		
		

*Mat. ne progr. 0+040.00*

Materiale	Sip. (m <sup>2</sup> )	Vol. (m <sup>3</sup> )	Vol. Cum. (m <sup>3</sup> )
Germim	0.00	0.78	15.61
Mbushje	1.55	15.76	17.01

*Seksioni nr. 3  
Progr. 0+040.00  
Shk. 1:100  
K.Ref. 245.00m*

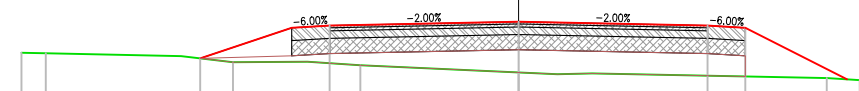

<i>PROGRESIVE TERRENI</i>	-6.57	-6.25	-4.46	-3.78	-2.79	-2.09	0.51	4.08	4.51	
<i>KUOTE TERRENI</i>	250.43	250.42	250.39	250.31	250.31	250.27	250.17	250.15	250.10	250.07
<i>DISTANCE PJESORE TERRENI</i>		1.79	0.69	0.99	0.70	2.09	0.51	3.10		
<i>PROGRESIVE PROJEKTI</i>			-4.21	-3.00	-2.50			2.50	3.00	
<i>KUOTE PROJEKTI</i>			250.36	250.76	250.79		250.84	250.79	250.76	
<i>DISTANCE PJESORE PROJEKTI</i>			1.21	0.50	2.50		2.50	0.50		

<b>Shenime</b>		
Investitor Bashkia Memaliaj		
Emertimi i projektit RIPARIMI I RRUGES HYRJJE ZHAPOKIKE		
Faza e Projektit PROJEKT ZBATIM		
<b>Projekti i infrastruktures</b>		
Konsulentit 		
Projektori	Emer Mbiemer	Firma
Insh. Nderim	Vangjush MBRICJE	
Insh. Nderim	Andaen MBRICJE	
Insh. Topografi	Nuredin HAMZAI	
Dwg.Nr. D1.03		
Emertimi fletes: Profilat terthore progresive		
Shkalla: A3 - 1:100		
		

Mat. ne progr. 0+060.00

Materiale	Sip. (m <sup>2</sup> )	Vol. (m <sup>3</sup> )	Vol. Cum. (m <sup>3</sup> )
Germim	0.00	0.00	15.61
Mbushje	2.20	39.14	56.15

Seksioni nr. 4  
 Progr. 0+060.00  
 Shk. 1:100  
 K.Ref. 250.00m

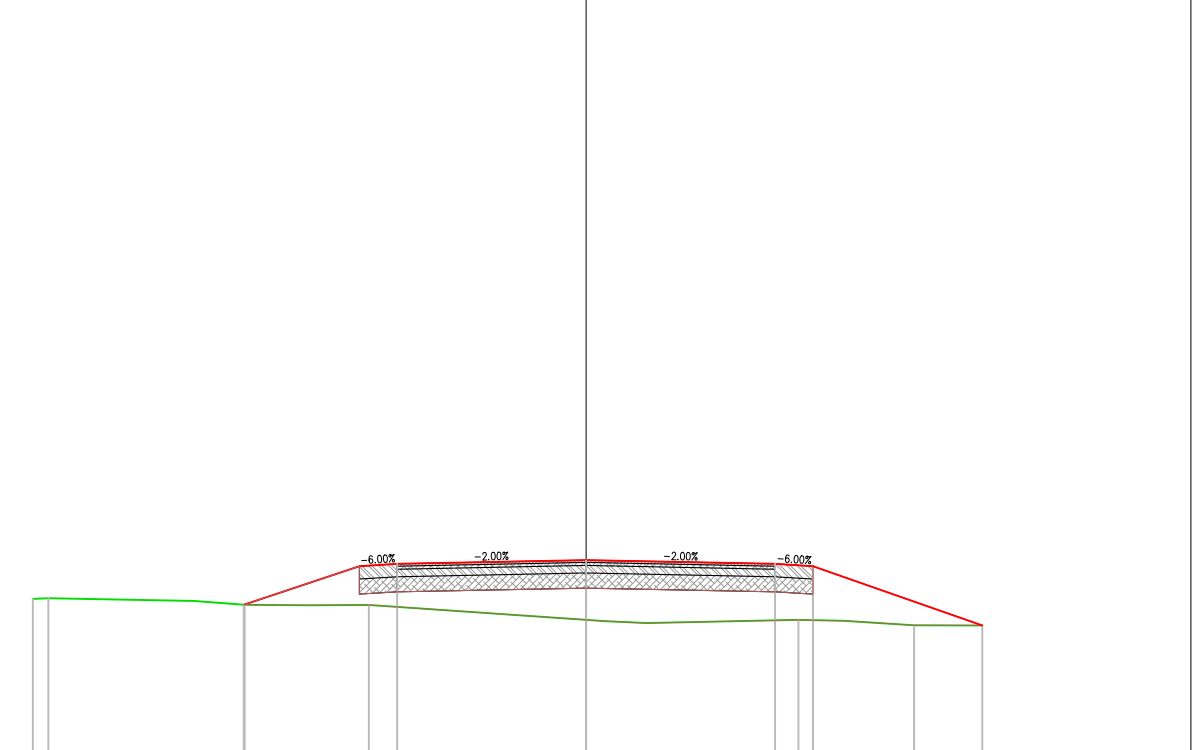

PROGRESIVE TERRENI	-7.32	-7.12	-5.19	-4.52	-3.68	-2.87	0.00	0.80	2.81	3.41	4.34	4.98	5.24
KUOTE TERRENI	252.06	252.07	252.03	251.98	251.98	251.98	251.78	251.74	251.78	251.77	251.71	251.71	251.71
DISTANCE PJESORE TERRENI		1.93	0.67	0.83	0.81	2.87		0.35	2.01	0.60	0.93	0.64	
PROGRESIVE PROJEKTI			-4.53	-3.00	-2.50	0.00		2.50	3.00				
KUOTE PROJEKTI			251.98	252.50	252.53	252.58		252.53	252.50				
DISTANCE PJESORE PROJEKTI			1.53	0.50	2.50		2.50	0.50					

Shenime

---

Investitor  
 Bashkia Memaliaj 

Emertimi i projektit  
 RIPARIMI I RRRUGES HYRJJE ZHAPOKIKE

Faza e Projektit  
 PROJEKT ZBATIM

**Projekti i infrastruktures**

Konsulentit  
  
 C.E.C Group  
 Civil Engineering Consultants

Projektori	Emer Mbiemer	Firma
Insh. Nderim	Vangjush MBRICJE	
Insh. Nderim	Andreas MBRICJE	
Insh. Topografi	Nuredin HAMZAI	

---

Dwg.Nr. D1.04

Emertimi fletes:  
 Profilat terthore progresive

---

Shkalla:  
 A3 - 1:100





Mat. ne progr. 0+100.00

Materiale	Sip. (m <sup>2</sup> )	Vol. (m <sup>3</sup> )	Vol. Cum. (m <sup>3</sup> )
Cermim	0.62	5.46	21.26
Mbushje	0.00	6.40	94.25

Seksioni nr. 6  
 Progr. 0+100.00  
 Shk. 1:100  
 K.Ref. 250.00m

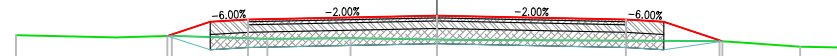

<i>PROGRESIVE TERRENI</i>	-5.57	-4.25	-3.51	-2.24	-1.14	0.00		3.74	4.80	5.47
<i>KUOTE TERRENI</i>	255.72	255.69	255.71	255.67	255.68	255.66		255.64	255.57	255.56
<i>DISTANCE PJESORE TERRENI</i>	1.32	0.74	1.26	1.10	1.14		3.47	0.80	0.67	
<i>PROGRESIVE PROJEKTI</i>			-3.57	-3.00	-2.50	0.00		2.50	3.00	3.78
<i>KUOTE PROJEKTI</i>			255.71	255.90	255.93	255.98		255.93	255.90	255.64
<i>DISTANCE PJESORE PROJEKTI</i>			0.57	0.50	2.50		2.50	0.50	0.78	

Shenime		
Investitor	Bashkia Memaliaj	
Emertimi i projektit	RIPARIMI I RRUGES HYRJE ZHAPOKIKE	
Faza e Projektit	PROJEKT ZBATIM	
<b>Projekti i infrastruktures</b>		
Konsulentit	 C.E.C Group Civil Engineering Consultants	
Projektori	Emer Mbiemer	Firma
Insh. Nderim	Vangjush MBRICJE	
Insh. Nderim	Andaen MBRICJE	
Insh. Topografi	Nuredin HAMZAI	
Dwg.Nr. D1.06		
Emertimi fletes: Profilat terthore progresive		
Shkalla: A3 - 1:100		
		

*Mat. ne progr. 0+120.00*

Materiale	Sip. (m <sup>2</sup> )	Vol. (m <sup>3</sup> )	Vol. Cum. (m <sup>3</sup> )
Cermim	1.37	20.38	41.64
Mbushje	0.00	0.01	94.26

*Seksioni nr. 7  
Progr. 0+120.00  
Shk. 1:100  
K.Ref. 250.00m*

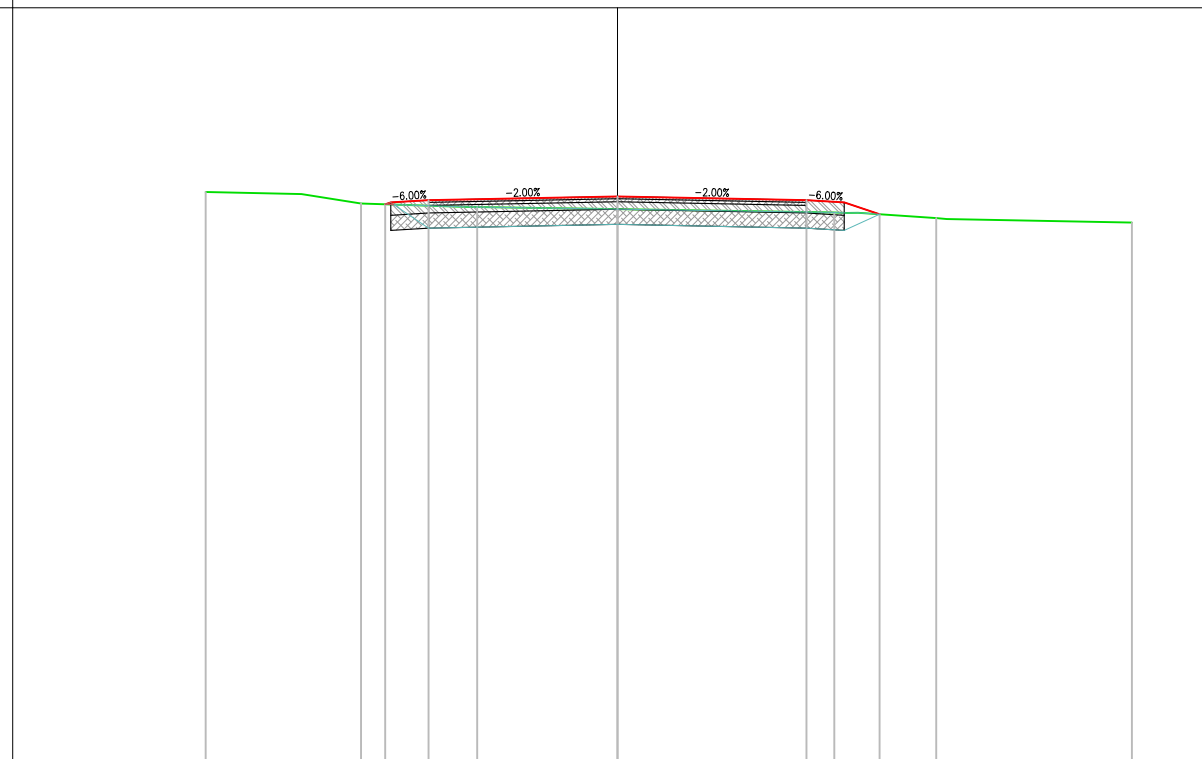

<i>PROGRESIVE TERRENI</i>		-5.45	-4.18	-3.39	-1.86	0.00	2.87	4.22	6.80	
<i>KUOTE TERRENI</i>		257.56	257.53	257.41	257.36	257.34	257.29	257.22	257.16	
<i>DISTANCE PJESORE TERRENI</i>			1.27	0.79	1.38	1.86	2.87	1.03	2.45	
<i>PROGRESIVE PROJEKTI</i>				-3.07	-3.00	-2.50	0.00	2.50	3.00	3.47
<i>KUOTE PROJEKTI</i>				257.40	257.42	257.45	257.50	257.45	257.42	257.27
<i>DISTANCE PJESORE PROJEKTI</i>					0.50	2.50	2.50	0.50	0.47	

Shenime

Investitor  
Bashkia Memaliaj



Emertimi i projektit

RIPARIMI I RRUGES HYRJJE ZHAPOKIKE

Faza e Projektit

PROJEKT ZBATIM

Projekti i  
infrastruktures

Konsulenti



Projektori	Emer Mbiemer	Firma
Insh. Nderim	Vangjush MBRICË	
Insh. Nderim	Andaen MBRICË	
Insh. Topografi	Nuredin HAMZAI	

Dwg.Nr. D1.07

Emertimi fletes:  
Profilat terthore progresive

Shkalla:

A3 - 1:100





Mat. ne progr. 0+140.00

Materiale	Sip. (m <sup>2</sup> )	Vol. (m <sup>3</sup> )	Vol. Cum. (m <sup>3</sup> )
Cermim	2.99	44.70	86.34
Mbushje	0.00	0.01	94.27

Seksioni nr. 8  
 Progr. 0+140.00  
 Shk. 1:100  
 K.Ref. 253.00m

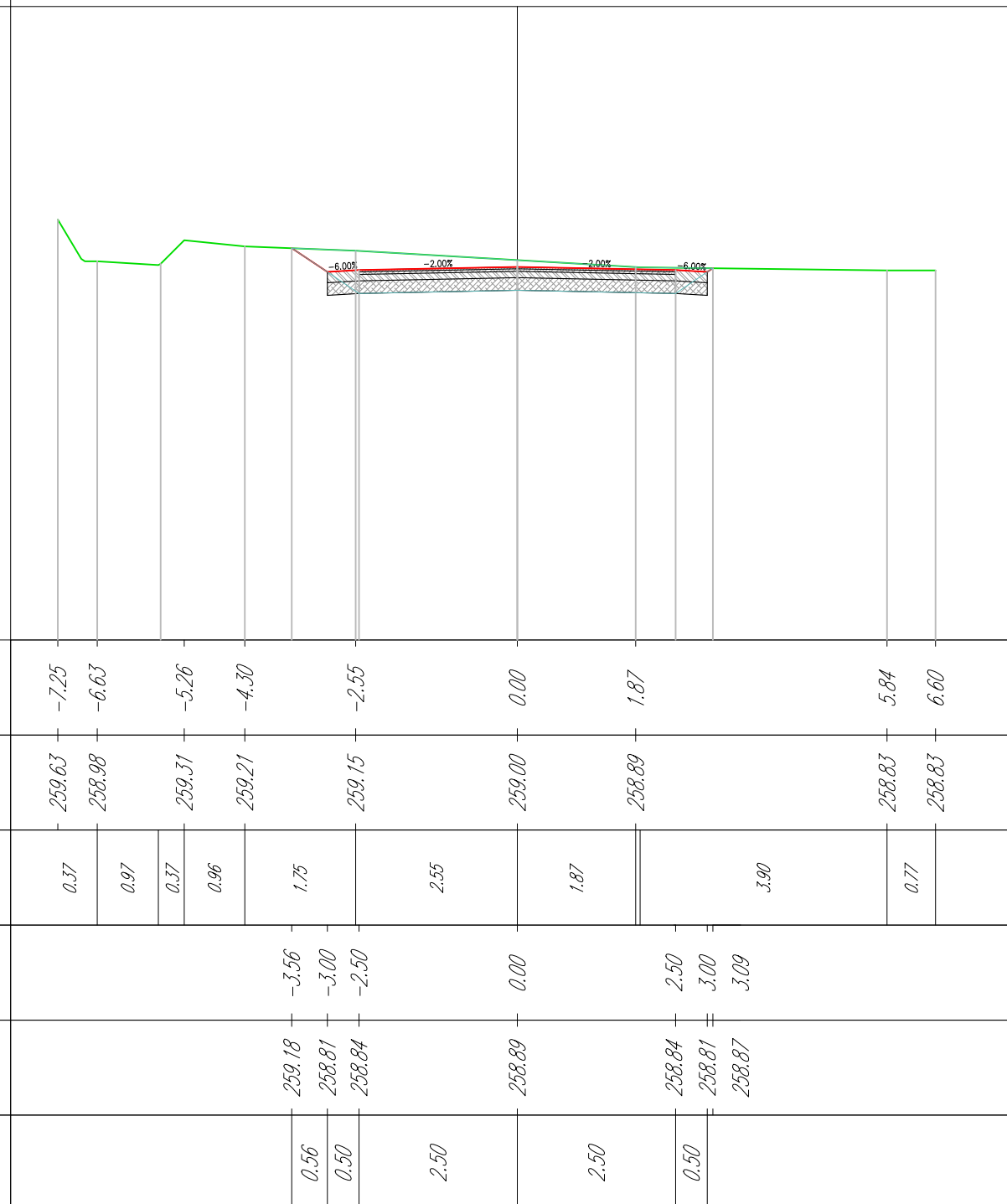

Shenime		
Investitor Bashkia Memaliaj		
Emertimi i projektit RIPARIMI I RRUGES HYRJJE ZHAPOKIKE		
Faza e Projektit PROJEKT ZBATIM		
Projekti i infrastruktures		
Konsulentit 		
Projektoi	Emer Mbiemer	Firma
Insh. Nderim	Vangjush MBRICJE	
Insh. Nderim	Andaen MBRICJE	
Insh. Topografi	Nuredin HAMZAI	
Dwg.Nr. D1.08		
Emertimi fletes: Profilat terthore progresive		
Shkalla: A3 - 1:100		

Mat. ne progr. 0+160.00

Materiale	Sip. (m <sup>2</sup> )	Vol. (m <sup>3</sup> )	Vol. Cum. (m <sup>3</sup> )
Germim	0.07	24.61	110.95
Mbushje	0.20	1.37	95.64

Seksioni nr. 9  
 Progr. 0+160.00  
 Shk. 1:100  
 K.Ref. 258.00m

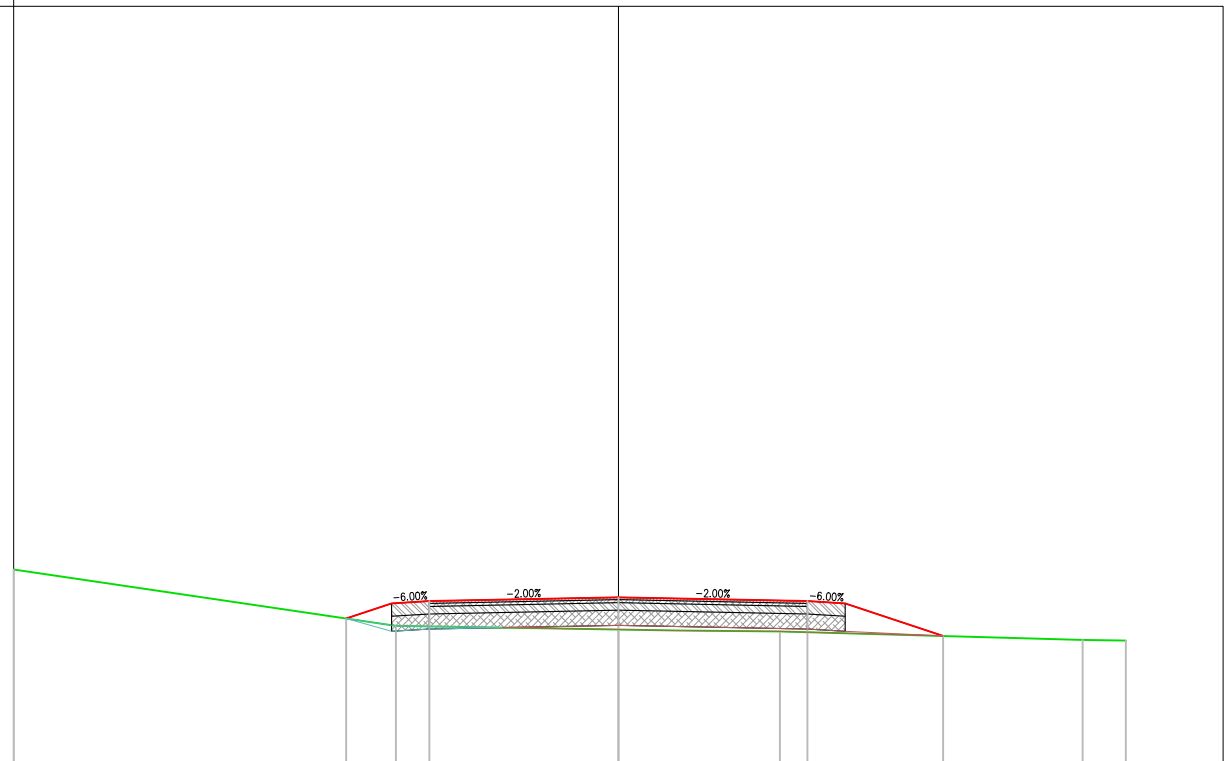

PROGRESIVE TERRENI	8.00	-2.94	0.00	0.76	2.14	6.14	6.71	
KUOTE TERRENI	260.55	259.81	259.76	259.75	259.73	259.62	259.61	
DISTANCE PJESORE TERRENI	5.06	2.94	0.76	1.38	4.00	0.57		
PROGRESIVE PROJEKTI		-3.60	-3.00	-2.50	0.00	2.50	3.00	4.29
KUOTE PROJEKTI		259.90	260.10	260.13	260.18	260.13	260.10	259.67
DISTANCE PJESORE PROJEKTI		0.60	0.50	2.50	2.50	0.50	1.29	

Shenime

Investitor  
 Bashkia Memaliaj



Emertimi i projektit

RIPARIMI I RRUGES HYRJE ZHAPOKIKE

Faza e Projektit

PROJEKT ZBATIM

Projekti i infrastruktures

Konsulentit



Projektori Emer Mbiemer Firma

Insh. Nderim Vangjush MBRICJE

Insh. Nderim Andan MBRICJE

Insh. Topografi Nuredin HAMZAI

Dwg.Nr. D1.09

Emertimi fletes:  
 Profilat terthore progresive

Shkalla:

A3 - 1:100

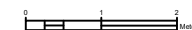

Mat. ne progr. 0+180.00

Materiale	Sip. (m <sup>2</sup> )	Vol. (m <sup>3</sup> )	Vol. Cum. (m <sup>3</sup> )
Cermim	0.36	4.10	115.06
Mbushje	0.10	2.99	98.63

Seksioni nr. 10  
 Progr. 0+180.00  
 Shk. 1:100  
 K.Ref. 256.00m

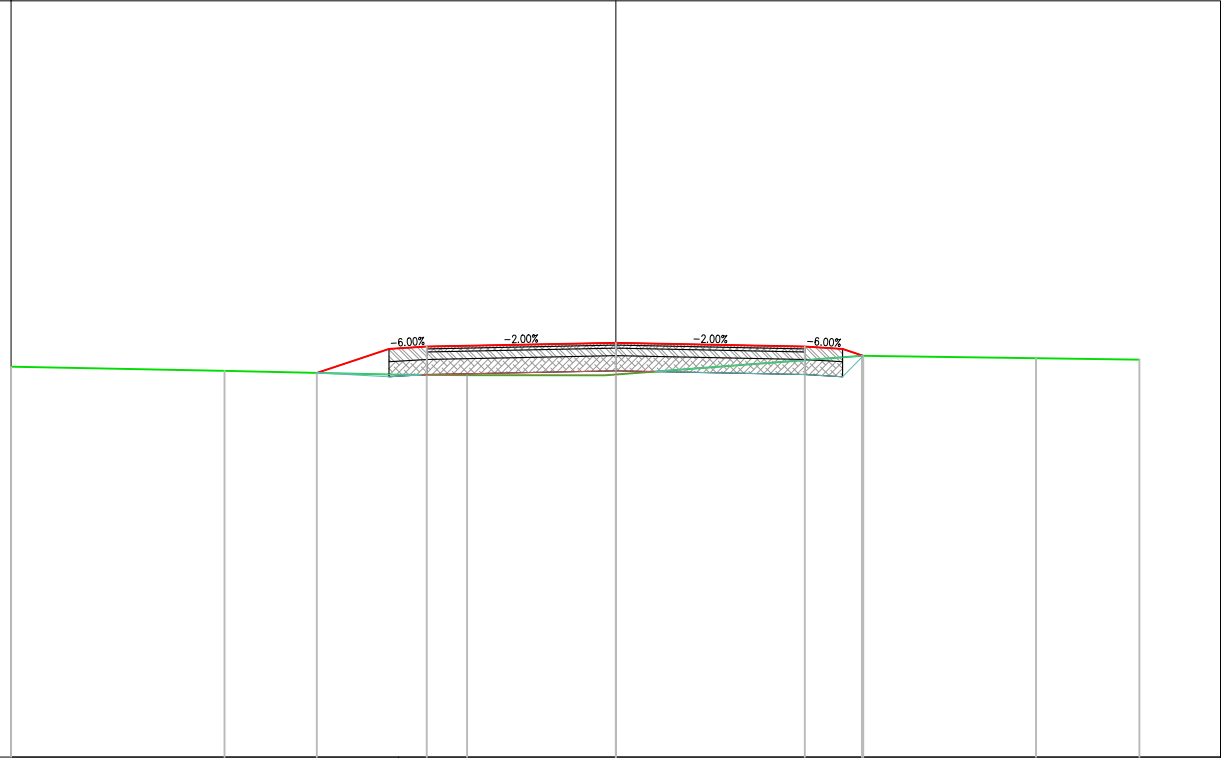

PROGRESIVE TERRENI	8.00	-5.18	-2.87	-1.97	0.00	3.26	5.56	6.93
KUOTE TERRENI	261.16	261.11	261.06	261.05	261.06	261.31	261.27	261.25
DISTANCE PJESORE TERRENI	2.82	2.30	0.91	1.82	3.26	2.30	1.37	
PROGRESIVE PROJEKTI		-3.95	-3.00	-2.50	0.00	2.50	3.00	3.27
KUOTE PROJEKTI		261.08	261.40	261.43	261.48	261.43	261.40	261.31
DISTANCE PJESORE PROJEKTI		0.95	0.50	2.50	2.50	0.50	0.27	

<b>Shenime</b>		
Investitor Bashkia Memaliaj		
Emertimi i projektit RIPARIMI I RRUGES HYRJE ZHAPOKIKE		
Faza e Projektit PROJEKT ZBATIM		
<b>Projekti i infrastruktures</b>		
Konsulentit 		
Projektoi	Emer Mbiemer	Firma
Insh. Nderim	Vangjush MBRICË	
Insh. Nderim	Andaen MBRICË	
Insh. Topografi	Nuredin HAMZAI	
Dwg.Nr. D1.10		
Emertimi fletes: Profilat terthore progresive		
Shkalla: A3 - 1:100		
		

Mat. ne progr. 0+200.00

Materiale	Sip. (m <sup>2</sup> )	Vol. (m <sup>3</sup> )	Vol. Cum. (m <sup>3</sup> )
Cermim	3.87	37.88	152.94
Mbushje	0.54	6.02	104.66

Seksioni nr. 11  
 Progr. 0+200.00  
 Shk. 1:100  
 K.Ref. 260.00m

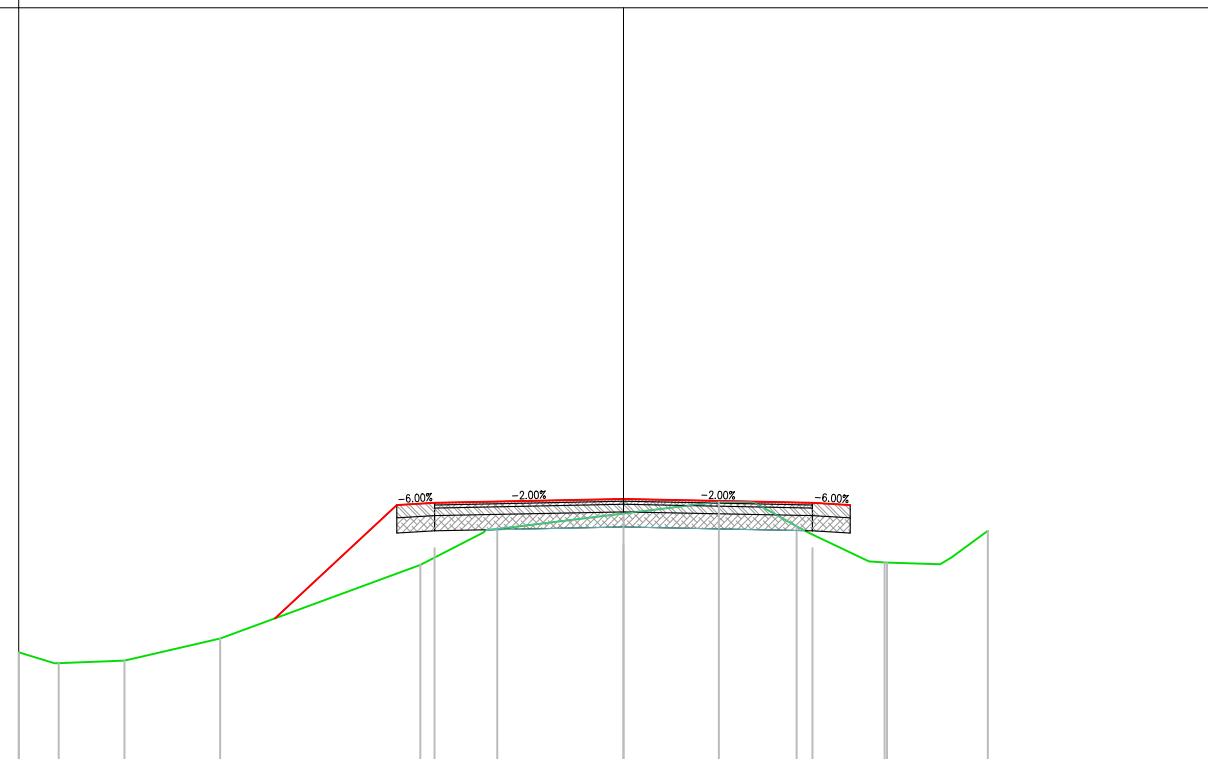

PROGRESIVE TERRENI	8.00	-7.53	-6.60	-5.33	-2.69	-1.67	1.26	2.29	3.25	4.19	4.82	
KUOTE TERRENI	261.48	261.33	261.36	261.66	262.63	263.11	263.31	263.47	263.14	262.68	262.64	263.08
DISTANCE PJESORE TERRENI		0.92	1.27	2.65	0.84	1.67	1.26	0.56	0.76	0.73	0.48	
PROGRESIVE PROJEKTI		-7.47			-3.00	-2.50			2.50	3.00	3.49	
KUOTE PROJEKTI		261.33			262.82	262.85	263.50		262.85	262.82	262.66	
DISTANCE PJESORE PROJEKTI			4.47		0.50	2.50		2.50	0.50	0.49		

Shenime

Investitor  
 Bashkia Memaliaj



Emertimi i projektit

RIPARIMI I RRUGES HYRJJE ZHAPOKIKE

Faza e Projektit

PROJEKT ZBATIM

Projekti i  
 infrastruktures

Konsulentit



Projektori	Emer Mbiemer	Firma
Insh. Nderim	Vangjush MBRICJE	
Insh. Nderim	Andaen MBRICJE	
Insh. Topografi	Nuredin HAMZAI	

Dwg.Nr. D1.11

Emertimi fletes:  
 Profilat terthore progresive

Shkalla:

A3 - 1:100

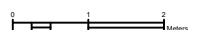

*Mat. ne progr. 0+220.00*

Materiale	Sip. (m <sup>2</sup> )	Vol. (m <sup>3</sup> )	Vol. Cum. (m <sup>3</sup> )
Cermim	5.40	96.89	249.83
Mbushje	0.00	3.77	108.42

*Seksioni nr. 12  
Progr. 0+220.00  
Shk. 1:100  
K.Ref. 260.00m*

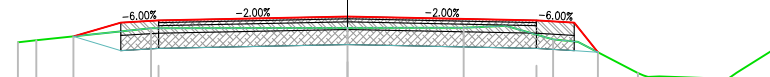

<i>PROGRESIVE TERRENI</i>		-4.36	-4.12	-2.60		1.54	2.10	2.72	3.84	5.03	5.74
<i>KUOTE TERRENI</i>		265.38	265.40	265.56	265.57	265.57	265.59	265.41	264.97	264.89	265.35
<i>DISTANCE PJESORE TERRENI</i>			1.52	2.60		1.54	0.56	0.62	0.79	0.91	0.60
<i>PROGRESIVE PROJEKTI</i>			-3.63	-3.00	-2.50			2.50	3.00	3.31	
<i>KUOTE PROJEKTI</i>			265.45	265.04	265.07	265.72		265.07	265.04	265.25	
<i>DISTANCE PJESORE PROJEKTI</i>			0.63	0.50	2.50		2.50	0.50	0.31		

Shenime

Investitor  
Bashkia Memaliaj



Emertimi i projektit

RIPARIMI I RRUGES HYRJJE ZHAPOKIKE

Faza e Projektit

PROJEKT ZBATIM

**Projekti i  
infrastruktures**

Konsulentit



Projektori	Emer Mbiemer	Firma
Insh. Nderim	Vangjush MBRICJE	
Insh. Nderim	Andan MBRICJE	
Insh. Topografi	Nuredin HAMZAI	

Dwg.Nr. D1.12

Emertimi fletes:  
Profilat terthore progresive

Shkalla:

A3 - 1:100



Mat. ne progr. 0+240.00

Materiale	Sip. (m <sup>2</sup> )	Vol. (m <sup>3</sup> )	Vol. Cum. (m <sup>3</sup> )
Cermim	1.14	63.17	313.00
Mbushje	0.51	3.59	112.01

Seksioni nr. 13  
 Progr. 0+240.00  
 Shk. 1:100  
 K.Ref. 260.00m



PROGRESIVE TERRENI		-4.79	-4.03	-2.01	0.00	1.05	1.65	3.12	4.00	4.97	5.61
KUOTE TERRENI		267.73	267.76	267.82	267.82	267.82	267.82	267.56	267.04	266.95	267.35
DISTANCE PJESORE TERRENI		0.77	2.01	2.01	1.05	0.60	1.36	0.51			
PROGRESIVE PROJEKTI			-3.39	-3.00	-2.50	0.00		2.50	3.00		5.30
KUOTE PROJEKTI			267.78	267.91	267.94	267.99		267.94	267.91		267.14
DISTANCE PJESORE PROJEKTI			0.39	0.50	2.50		2.50	0.50	2.30		

Shenime

Investitor  
Bashkia Memaliaj



Emertimi i projektit

RIPARIMI I RRUGES HYRJJE ZHAPOKIKE

Faza e Projektit

PROJEKT ZBATIM

Projekti i  
infrastruktures

Konsulentit



Projektori	Emer Mbiemer	Firma
Insh. Nderim	Vangjush MBRICJE	
Insh. Nderim	Andaen MBRICJE	
Insh. Topografi	Nuredin HAMZAI	

Dwg.Nr. D1.13

Emertimi fletes:  
Profilat terthore progresive

Shkalla:

A3 - 1:100









Mat. ne progr. 0+300.00

Materiale	Sip. (m <sup>2</sup> )	Vol. (m <sup>3</sup> )	Vol. Cum. (m <sup>3</sup> )
Cermim	0.69	8.47	331.70
Mbushje	0.33	7.95	147.83

Seksioni nr. 16  
 Progr. 0+300.00  
 Shk. 1:100  
 K.Ref. 270.00m

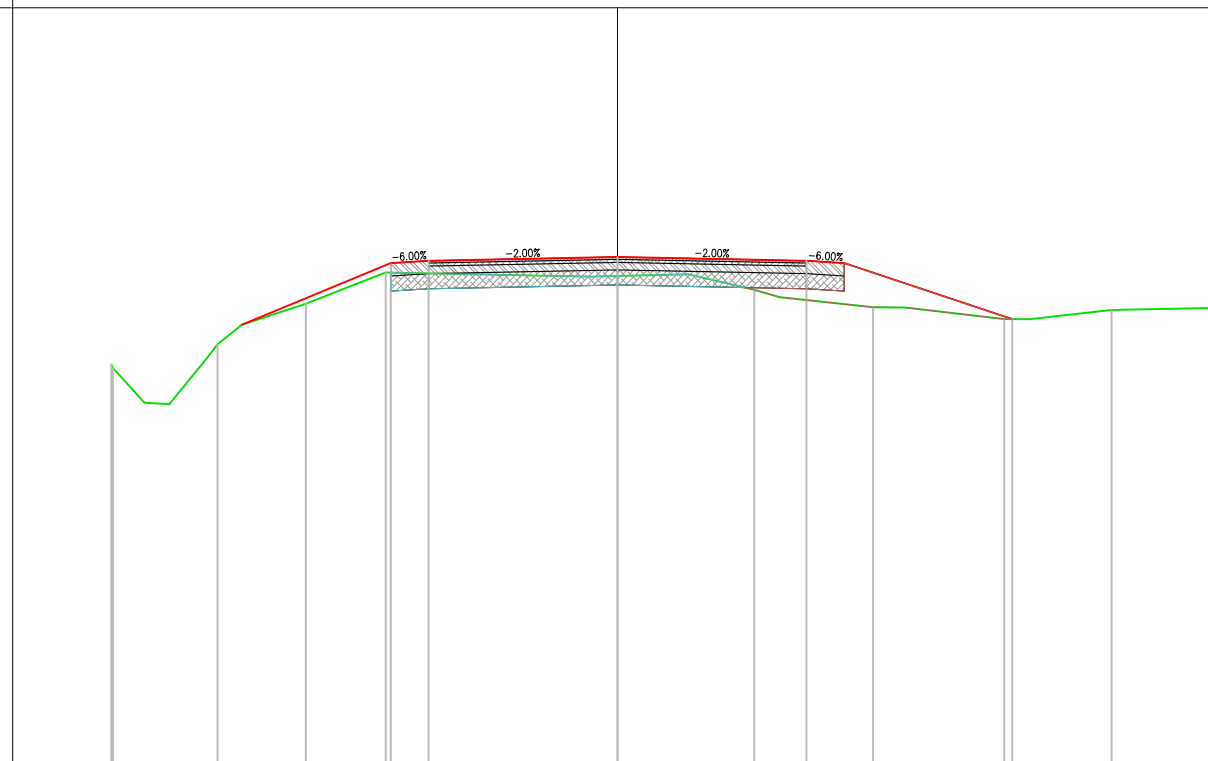

PROGRESIVE TERRENI	-6.70	-6.68	-5.89	-4.97	-4.12	-3.07		0.94	1.81	3.38	5.12	6.53	7.94		
KUOTE TERRENI	275.28	275.24	274.80	275.81	276.09	276.50		276.45	276.47	276.27	276.04	275.88	276.00	276.03	
DISTANCE PJESORE TERRENI	0.42	0.48		0.85	1.06		2.72	0.94	0.87		1.24		1.31	1.09	1.40
PROGRESIVE PROJEKTI						-3.00	-2.50				2.50	3.00		5.22	
KUOTE PROJEKTI						276.62	276.65	276.70			276.65	276.62		275.88	
DISTANCE PJESORE PROJEKTI						0.50	2.50		2.50		0.50	2.22			

Shenime

Investitor  
 Bashkia Memaliaj



Emertimi i projektit

RIPARIMI I RRUGES HYRJJE ZHAPOKIKE

Faza e Projektit

PROJEKT ZBATIM

Projekti i  
 infrastruktures

Konsulentit



Projektori	Emer Mbiemer	Firma
Insh. Nderim	Vangjush MBRICJE	
Insh. Nderim	Andan MBRICJE	
Insh. Topografi	Nuredin HAMZAI	

Dwg.Nr. D1.16

Emertimi fletes:  
 Profilat terthore progresive

Shkalla:

A3 - 1:100



Mat. ne progr. 0+320.00

Materiale	Sip. (m <sup>2</sup> )	Vol. (m <sup>3</sup> )	Vol. Cum. (m <sup>3</sup> )
Cermim	2.02	27.28	358.98
Mbushje	0.24	6.05	153.88

Seksioni nr. 17  
 Progr. 0+320.00  
 Shk. 1:100  
 K.Ref. 273.00m

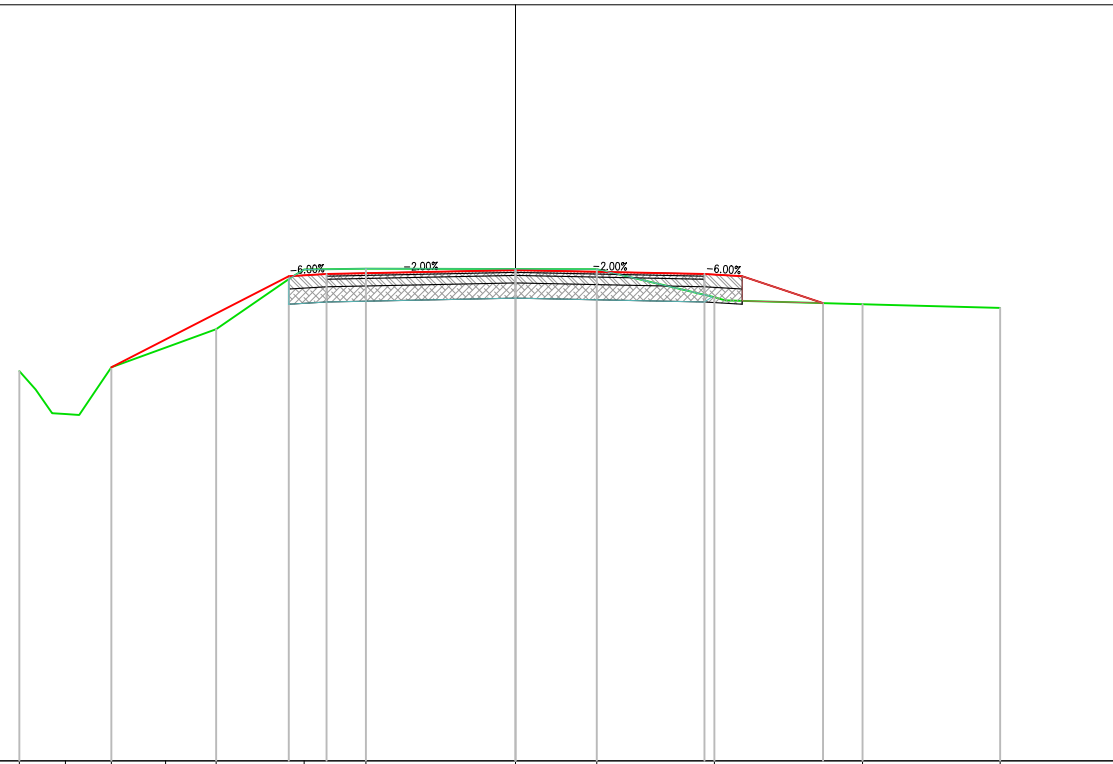

PROGRESIVE TERRENI		-6.56	-5.95	-5.35	-4.63	-3.96	-2.80	-1.98	0.00	1.08	2.63	4.59	6.41
KUOTE TERRENI		278.15	277.59	278.20	278.47	278.71	279.50	279.51	279.50	279.50	279.13	279.04	278.99
DISTANCE PJESORE TERRENI				0.72	0.67	0.99	0.82	1.98	1.08	1.55		1.59	1.60
PROGRESIVE PROJEKTI							-3.00	-2.50	0.00		2.50	3.00	4.07
KUOTE PROJEKTI							279.41	279.44	279.49		279.44	279.41	279.05
DISTANCE PJESORE PROJEKTI							0.50	2.50	2.50		0.50	1.07	

Shenime

---

Investitor  
 Bashkia Memaliaj 

Emertimi i projektit  
 RIPARIMI I RRUGES HYRJJE ZHAPOKIKE

Faza e Projektit  
 PROJEKT ZBATIM

**Projekti i infrastruktures**

Konsulentit  

Projektori	Emer Mbiemer	Firma
Insh. Nderim	Vangjush MBRICJE	
Insh. Nderim	Andan MBRICJE	
Insh. Topografi	Nuredin HAMZAI	

---

Dwg.Nr. D1.17

Emertimi fletes:  
 Profilat terthore progresive

---

Shkalla:  
 A3 - 1:100



Mat. ne progr. 0+340.00

Materiale	Sip. (m <sup>2</sup> )	Vol. (m <sup>3</sup> )	Vol. Cum. (m <sup>3</sup> )
Germim	1.24	33.97	392.95
Mbushje	0.08	3.28	157.15

Seksioni nr. 18  
 Progr. 0+340.00  
 Shk. 1:100  
 K.Ref. 280.00m

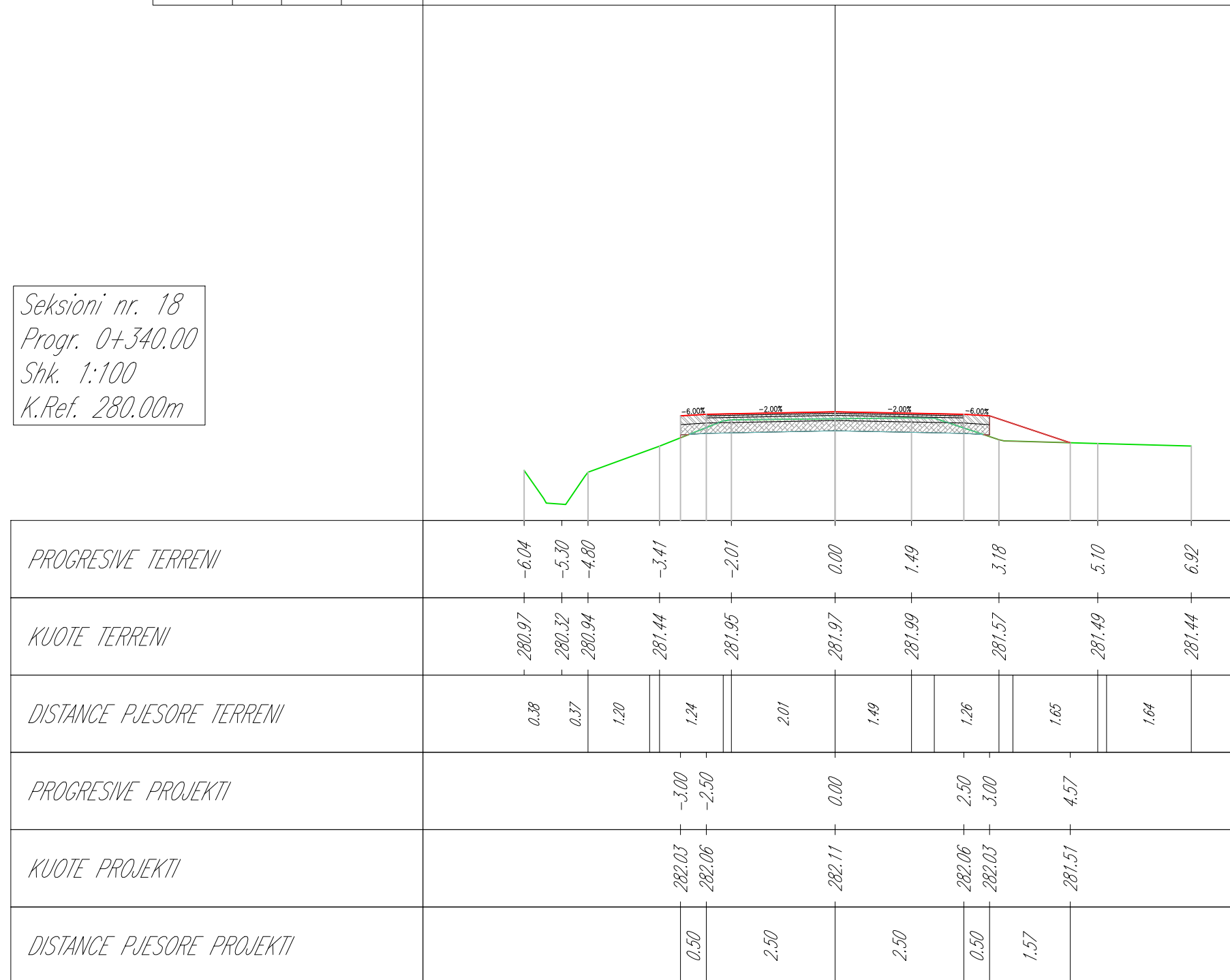

Shenime

Investitor  
 Bashkia Memaliaj



Emertimi i projektit

RIPARIMI I RRRUGES HYRJJE ZHAPOKIKE

Faza e Projektit

PROJEKT ZBATIM

Projekti i  
 infrastruktures

Konsulentit



Projektori	Emer Mbiemer	Firma
Insh. Nderim	Vangjush MBRICJE	
Insh. Nderim	Andan MBRICJE	
Insh. Topografi	Nuredin HAMZAI	

Dwg.Nr. D1.18

Emertimi fletes:  
 Profilat terthore progresive

Shkalla:

A3 - 1:100

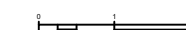

*Mat. ne progr. 0+360.00*

Materiale	Sip. (m <sup>2</sup> )	Vol. (m <sup>3</sup> )	Vol. Cum. (m <sup>3</sup> )
Germim	0.55	18.33	411.27
Mbushje	1.07	10.13	167.29

*Seksioni nr. 19  
Progr. 0+360.00  
Shk. 1:100  
K.Ref. 280.00m*

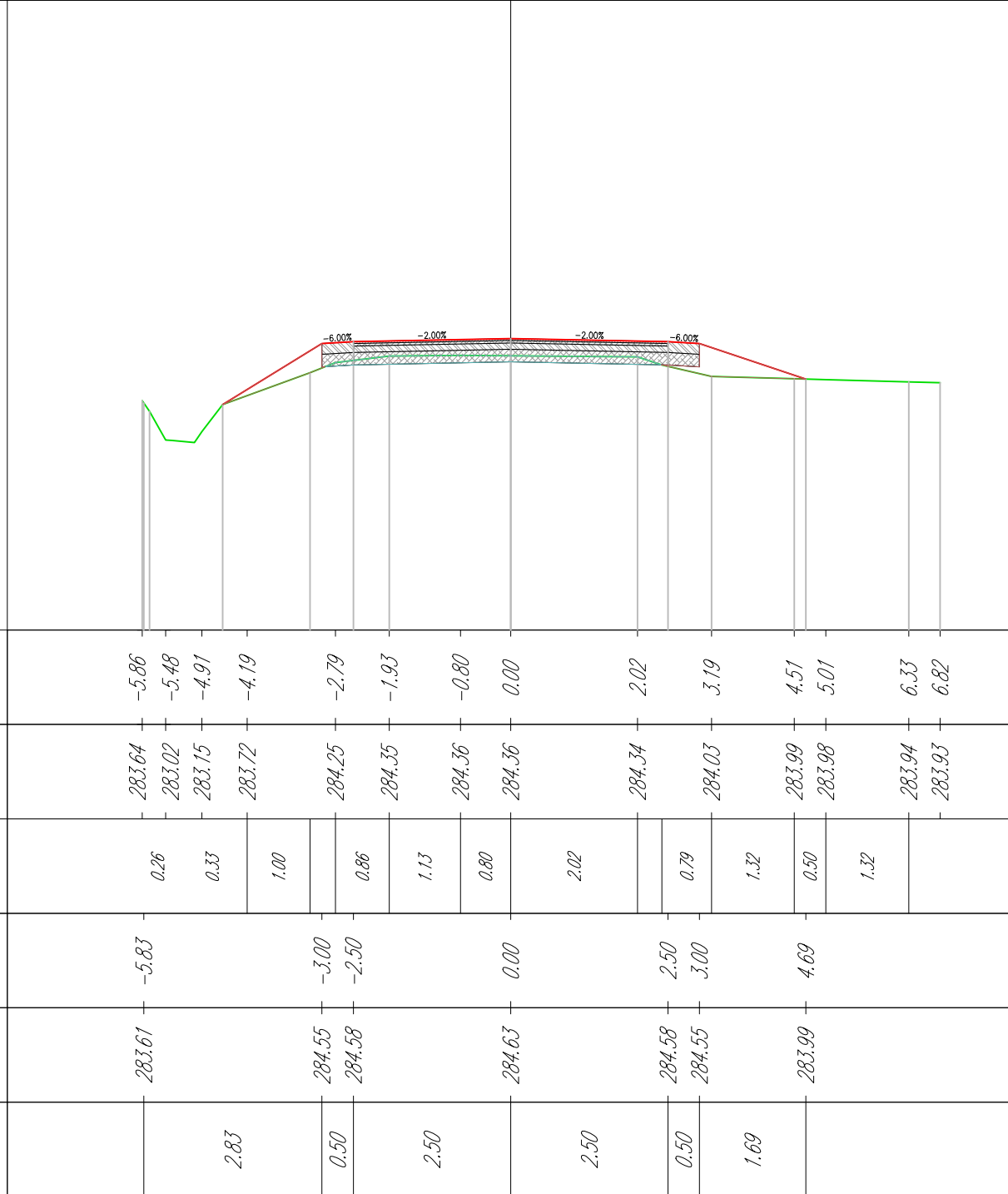

<b>Shenime</b>		
Investitor Bashkia Memaliaj		
Emertimi i projektit RIPARIMI I RRUGES HYRJJE ZHAPOKIKE		
Faza e Projektit PROJEKT ZBATIM		
<b>Projekti i infrastruktures</b>		
Konsulentit 		
Projektoi	Emer Mbiemer	Firma
Insh. Nderim	Vangjush MBRICJE	
Insh. Nderim	Andan MBRICJE	
Insh. Topografi	Nuredin HAMZAI	
Dwg.Nr. D1.19		
Emertimi fletes: Profilat terthore progresive		
Shkalla: A3 - 1:100		
		

*Mat. ne progr. 0+380.00*

Materiale	Sip. (m <sup>2</sup> )	Vol. (m <sup>3</sup> )	Vol. Cum. (m <sup>3</sup> )
Germim	0.48	10.77	422.04
Mbushje	0.22	12.49	179.78

*Seksioni nr. 20  
Progr. 0+380.00  
Shk. 1:100  
K.Ref. 280.00m*

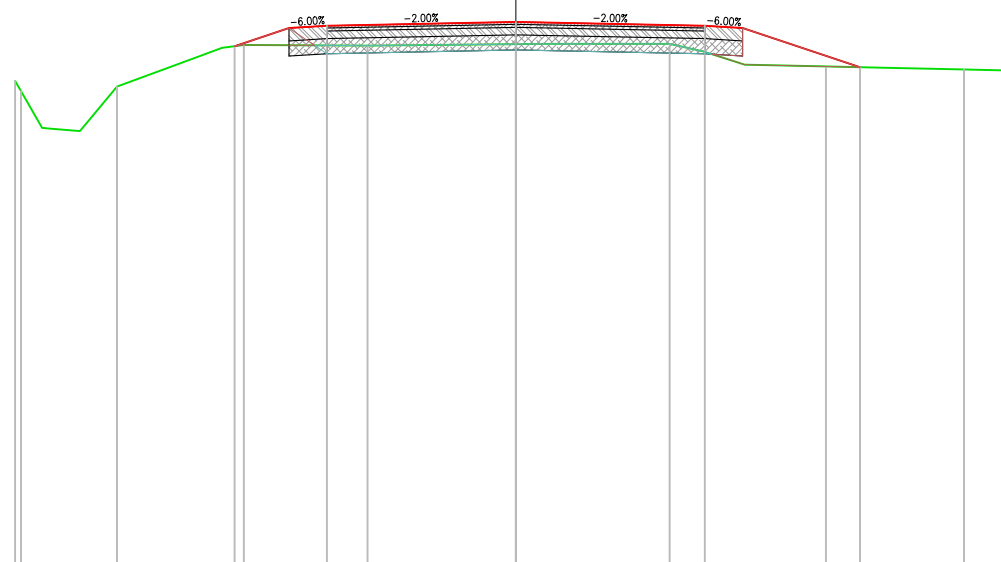

<i>PROGRESIVE TERRENI</i>	-6.62	-6.15	-5.28	-4.24	-3.60	-1.96		2.03	3.03	4.10	4.84	5.93	6.66
<i>KUOTE TERRENI</i>	286.46	285.83	286.39	286.77	286.94	286.93	286.95	286.95	286.68	286.65	286.64	286.61	286.60
<i>DISTANCE PJESORE TERRENI</i>	0.28	0.38	1.04		1.64	1.96		1.68	0.55	1.07	0.74	1.09	0.73
<i>PROGRESIVE PROJEKTI</i>					-3.72	-3.00	-2.50	0.00	2.50	3.00	4.55		
<i>KUOTE PROJEKTI</i>					286.92	287.16	287.19	287.24	287.19	287.16	286.64		
<i>DISTANCE PJESORE PROJEKTI</i>					0.72	0.50	2.50		2.50	0.50	1.55		

Shenime

Investitor  
Bashkia Memaliaj



Emertimi i projektit

RIPARIMI I RRUGES HYRJJE ZHAPOKIKE

Faza e Projektit

PROJEKT ZBATIM

Projekti i  
infrastruktures

Konsulentit



Projektori	Emer Mbiemer	Firma
Insh. Nderim	Vangjush MBRICJE	
Insh. Nderim	Andreas MBRICJE	
Insh. Topografi	Nuredin HAMZAI	

Dwg.Nr. D1.20

Emertimi fletes:  
Profilat terthore progresive

Shkalla:

A3 - 1:100



*Mat. ne progr. 0+400.00*

Materiale	Sip. (m <sup>2</sup> )	Vol. (m <sup>3</sup> )	Vol. Cum. (m <sup>3</sup> )
Germim	0.60	11.31	433.35
Mbushje	0.00	1.61	181.38

*Seksioni nr. 21  
Progr. 0+400.00  
Shk. 1:100  
K.Ref. 285.00m*

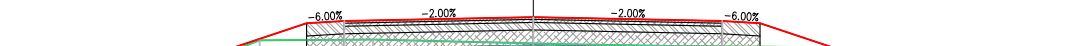

<i>PROGRESIVE TERRENI</i>	-6.73	-5.98	-5.39	-4.60	-3.62	-2.12	0.00	1.83	2.35	3.63	4.18	5.42	6.02	7.20
<i>KUOTE TERRENI</i>	289.37	288.72	289.31	289.42	289.79	289.80	289.75	289.71	289.71	289.70	289.69	289.68	289.68	289.67
<i>DISTANCE PJESORE TERRENI</i>	0.29	0.40	0.79	0.98	1.50	2.12		1.43	0.52	1.27	0.56	1.24	0.60	1.19
<i>PROGRESIVE PROJEKTI</i>			-4.92		-3.00	-2.50	0.00		2.50	3.00	3.96			
<i>KUOTE PROJEKTI</i>			289.38		290.02	290.05	290.10		290.05	290.02	289.70			
<i>DISTANCE PJESORE PROJEKTI</i>				1.92	0.50	2.50		2.50	0.50	0.96				

Shenime		
Investitor	Bashkia Memaliaj	
Emertimi i projektit	RIPARIMI I RRRUGES HYRJJE ZHAPOKIKE	
Faza e Projektit	PROJEKT ZBATIM	
<b>Projekti i infrastruktures</b>		
Konsulentit	 C.E.C Group Civil Engineering Consultants	
Projektori	Emer Mbiemer	Firma
Insh. Nderim	Vangjush MBRICJE	
Insh. Nderim	Andaen MBRICJE	
Insh. Topografi	Nuredin HAMZAI	
Dwg.Nr. D1.21		
Emertimi fletes: Profilat terthore progresive		
Shkalla: A3 - 1:100		
		

Mat. ne progr. 0+420.00

Materiale	Sip. (m <sup>2</sup> )	Vol. (m <sup>3</sup> )	Vol. Cum. (m <sup>3</sup> )
Cermim	0.01	4.70	438.04
Mbushje	1.81	12.80	194.18

Seksioni nr. 22  
 Progr. 0+420.00  
 Shk. 1:100  
 K.Ref. 290.00m

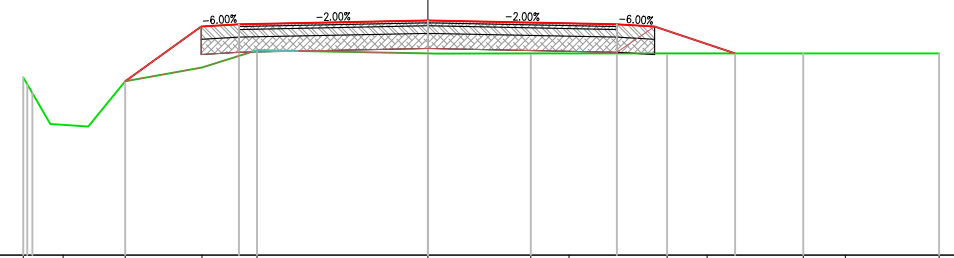

PROGRESIVE TERRENI		-5.35	-4.83	-4.00	-2.99	-2.26	0.00	1.36	1.87	3.16	3.69	4.97	5.52	6.76
KUOTE TERRENI		292.35	291.72	292.30	292.48	292.71	292.67	292.67	292.67	292.67	292.67	292.67	292.67	292.67
DISTANCE PJESORE TERRENI				0.32	1.02	0.73	2.26	1.25	0.51	1.30	0.53	1.27	0.56	1.24
PROGRESIVE PROJEKTI		-5.30			-3.00	-2.50	0.00			2.50	3.00	4.06		
KUOTE PROJEKTI		292.26			293.02	293.05	293.10			293.05	293.02	292.67		
DISTANCE PJESORE PROJEKTI				2.30	0.50	2.50			2.50	0.50	1.06			

<b>Shenime</b>		
Investitor		
Bashkia Memaliaj		
Emertimi i projektit	RIPARIMI I RRUGES HYRJJE ZHAPOKIKE	
Faza e Projektit	PROJEKT ZBATIM	
<b>Projekti i infrastruktures</b>		
Konsulentit		
Projektoi	Emer Mbiemer	Firma
Insh. Nderim	Vangjush MBRICJE	
Insh. Nderim	Andan MBRICJE	
Insh. Topografi	Nuredin HAMZAI	
Dwg.Nr. D1.22		
Emertimi fletes: Profilat terthore progresive		
Shkalla:		
A3 - 1:100		
		

*Mat. ne progr. 0+440.00*

Materiale	Sip. (m <sup>2</sup> )	Vol. (m <sup>3</sup> )	Vol. Cum. (m <sup>3</sup> )
Germim	1.24	9.36	447.41
Mbushje	0.00	12.70	206.87

*Seksioni nr. 23  
Progr. 0+440.00  
Shk. 1:100  
K.Ref. 290.00m*

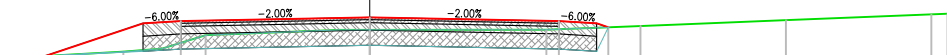

<i>PROGRESIVE TERRENI</i>	-4.64	-3.26	-2.75	-2.17	0.00	2.34	3.58	4.11	5.50	7.43	7.64
<i>KUOTE TERRENI</i>	295.58	295.66	295.70	295.88	295.95	295.95	296.00	296.02	296.07	296.15	296.16
<i>DISTANCE PJESORE TERRENI</i>		1.38	0.51	0.58	1.77	2.34	1.24	0.53	1.39	1.54	
<i>PROGRESIVE PROJEKTI</i>	-4.29	-3.00	-2.50		0.00	2.50	3.00	3.15			
<i>KUOTE PROJEKTI</i>	295.60	296.03	296.06		296.11	296.06	296.03	295.98			
<i>DISTANCE PJESORE PROJEKTI</i>		1.29	0.50	2.50		2.50	0.50				

Shenime

Investitor  
Bashkia Memaliaj



Emertimi i projektit

RIPARIMI I RRUGES HYRJJE ZHAPOKIKE

Faza e Projektit

PROJEKT ZBATIM

**Projekti i  
infrastruktures**

Konsulentit



Projektori	Emer Mbiemer	Firma
Insh. Nderim	Vangjush MBRICJE	
Insh. Nderim	Andaen MBRICJE	
Insh. Topografi	Nuredin HAMZAI	

Dwg.Nr. D1.23

Emertimi fletes:  
Profilat terthore progresive

Shkalla:

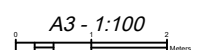



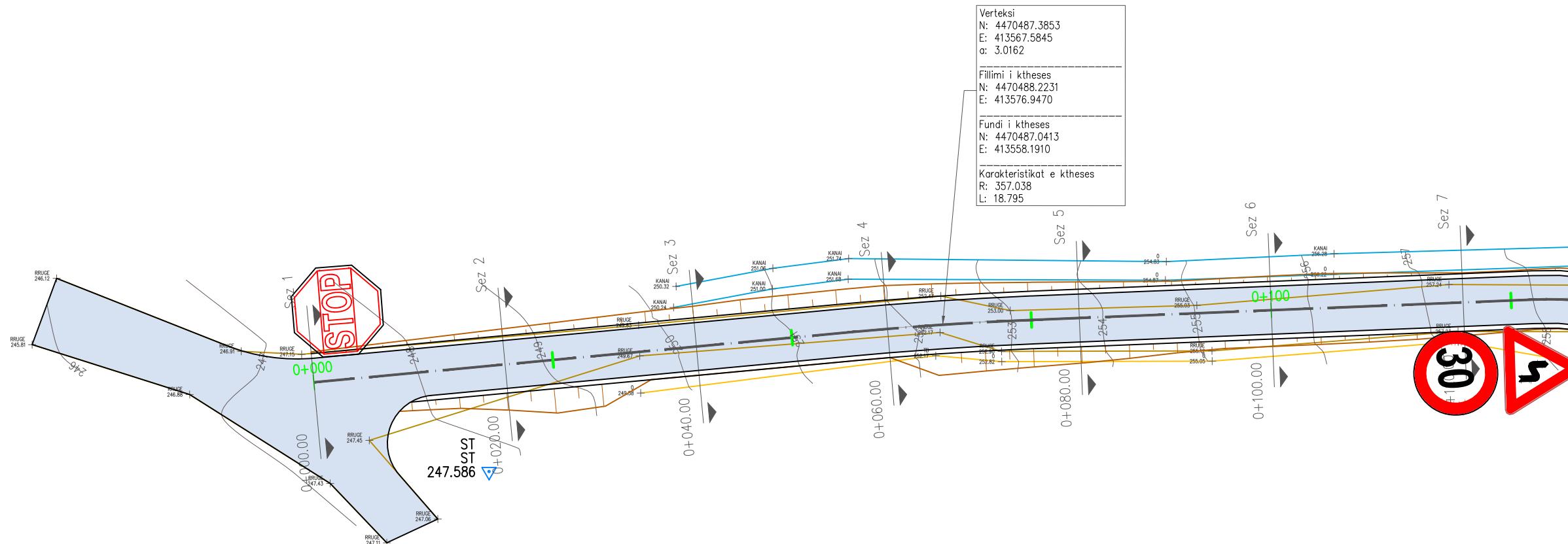

Shenime

Investitor  
 Bashkia Memaliaj



Emertimi i projektit

RIPARIMI I RRUGES HYRJE ZHAPOKIKE

Faza e Projektit

PROJEKT ZBATIM

**Projekti i infrastruktures**

Konsulentit



Projektoi	Emer Mbiemer	Firma
Insh. Nderim	Vangjush MBRICË	
Insh. Nderim	Andren MBRICË	
Insh. Topograf	Nuredin HAMZAI	

Dwg.Nr. S0.01

Emertimi fletes:  
 Planimetria e sinjalistikes

Shkalla:

A3 - 1:500

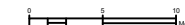

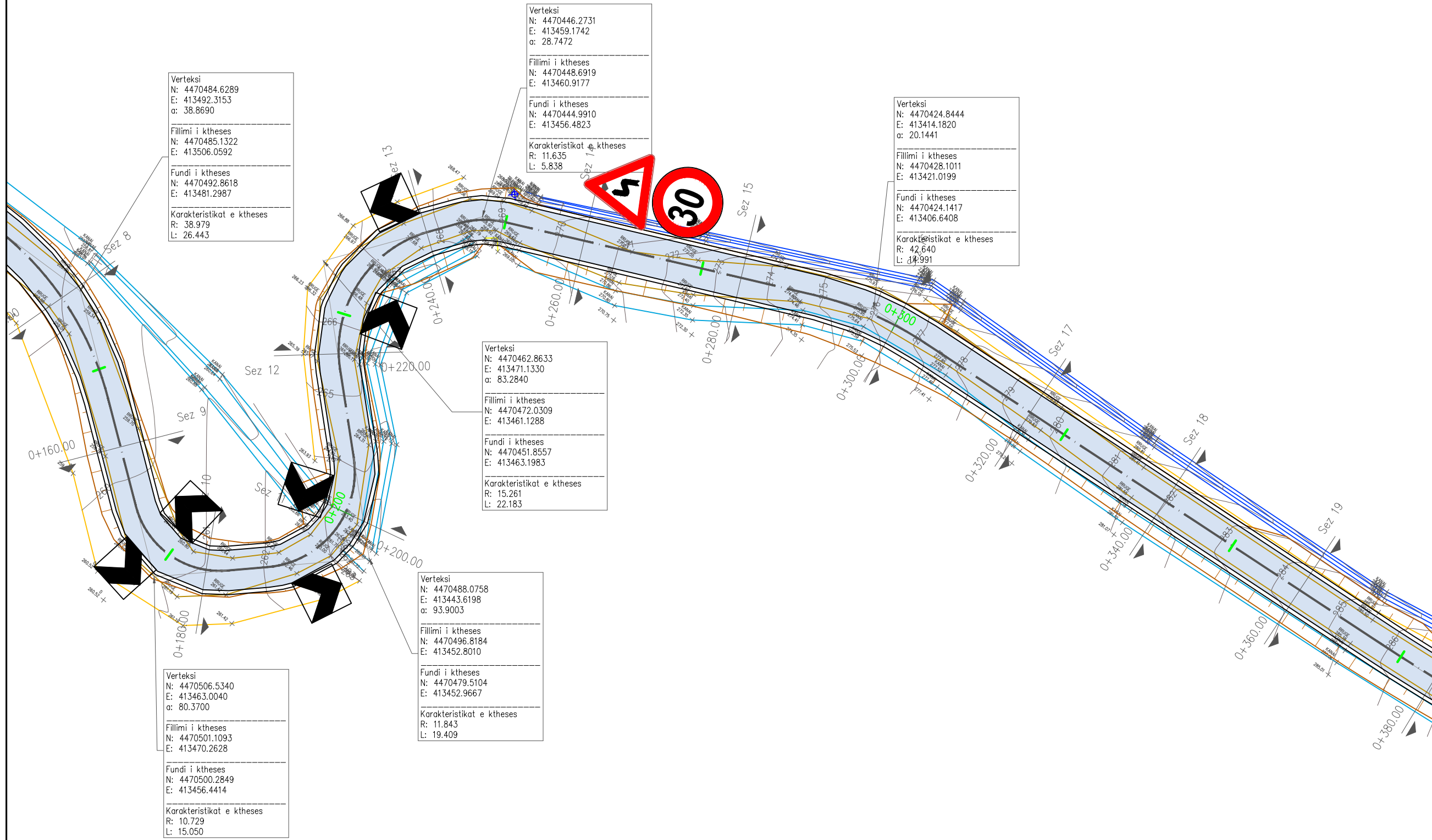

Shenime

Investitor  
Bashkia Memalaj



Emertimi i projektit  
RIPARIMI I RRUGES HYRJE ZHAPOKIKE

Faza e Projektit  
PROJEKT ZBATIM

Projekti i infrastruktures

Konsulentit



Projektoi	Emer Mbiemer	Firma
Insh. Nderim	Vangjush MBRICË	
Insh. Nderim	Andren MBRICË	
Insh. Topograf	Nuredin HAMZAI	

Dwg.Nr. S0.02

Emertimi fletes:  
Planimetria e sinjalistikes

Shkalla:

A3 - 1:500



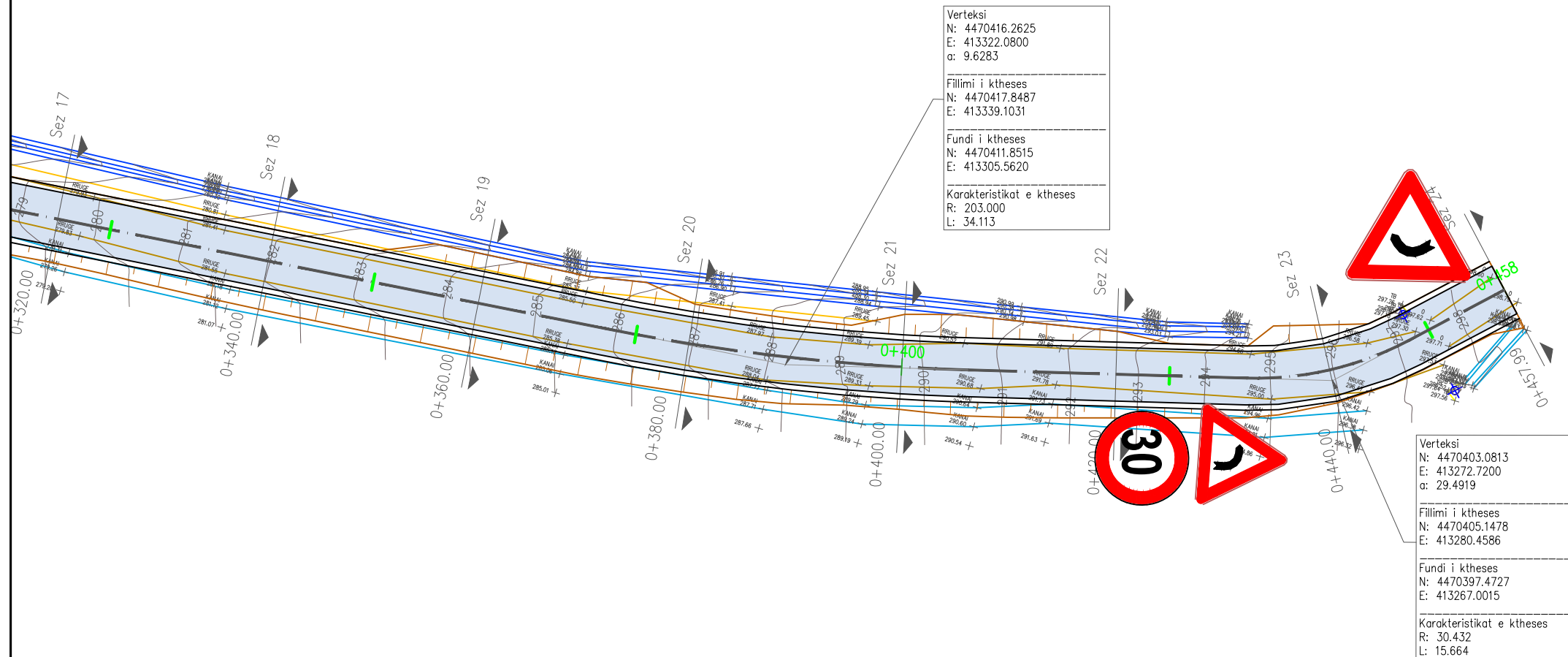

Shenime

Investitor  
Bashkia Memaliaj



Emertimi i projektit  
RIPARIMI I RRUGES HYRJE ZHAPOKIKE

Faza e Projektit  
PROJEKT ZBATIM

Projekti i infrastruktures

Konsulentë



Projektoi	Emer Mbiemer	Firma
Insh. Nderim	Vangjush MBRICË	
Insh. Nderim	Andren MBRICË	
Insh. Topograf	Nuredin HAMZAI	

Dwg.Nr. S0.03

Emertimi fletes:  
Planimetria e sinjalistikes

Shkalla:

A3 - 1:500

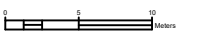

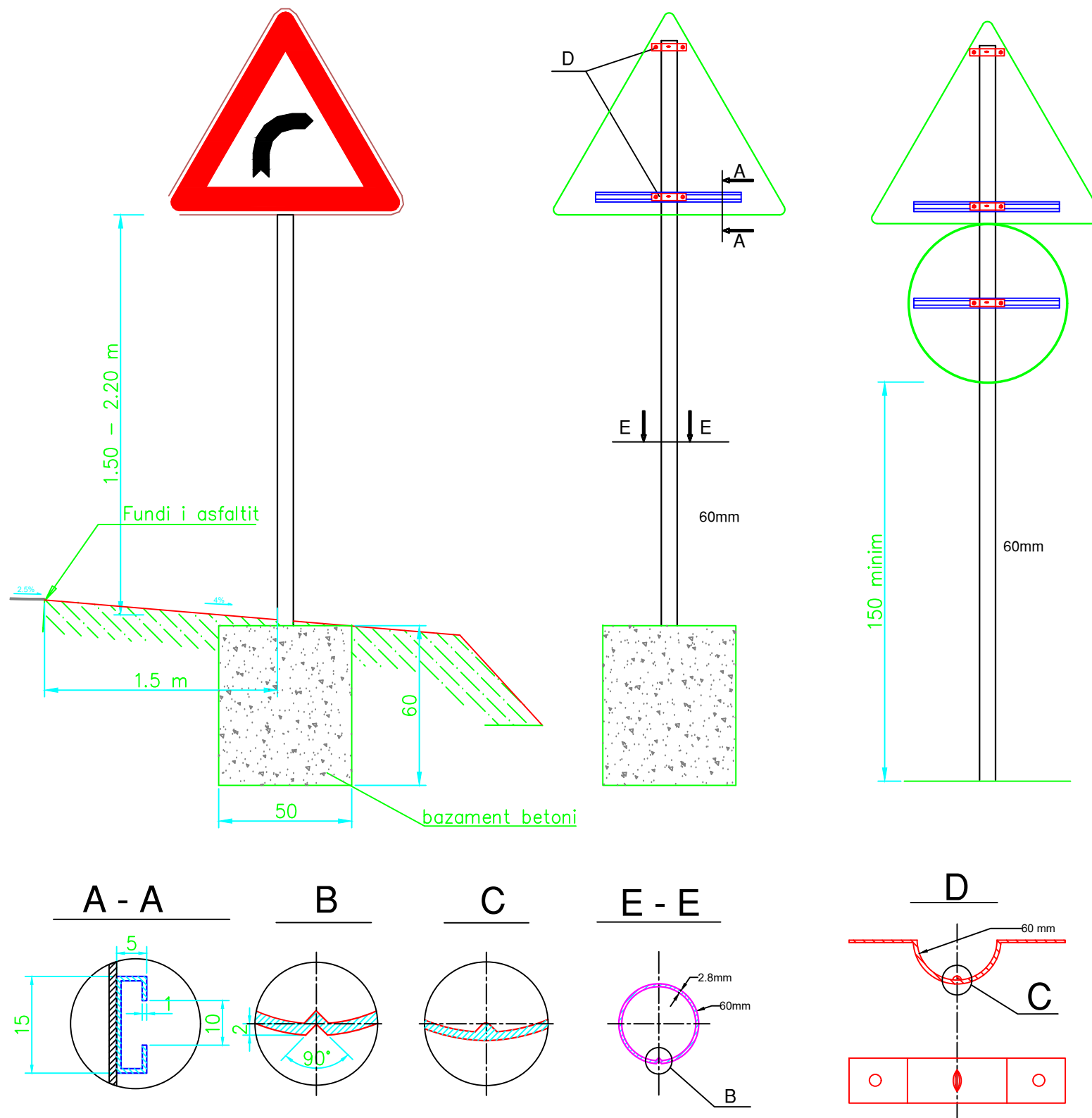

Shenime

Klienti  
Bashkia Memaliaj



Emertimi i projektit  
RIPARIMI I RRUGES HYRJE ZHAPOKIKE

Faza e Projektit  
PROJEKT ZBATIM

Projekti i  
infrastruktures

Konsulenti



Projektoi	Emer Mbiemer	Firma
Insh. Nderim	Vangush MBRIÇE	
Insh. Nderim	Andren MBRIÇE	
Insh. Topograf	Nuredin HAMZAI	

Dwg.Nr. S1.01

Emertimi fletes:  
Detaje te sinjalistikes

KM.

Shkalla:

A3 - 1:20



# PERMASAT E SHENJAVE RRUGORE

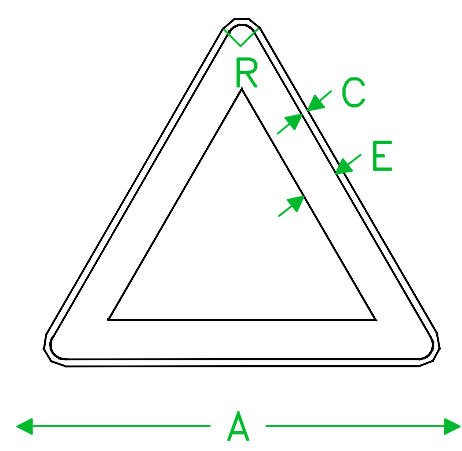

A	C	E	R
90	1.5	8	4.5

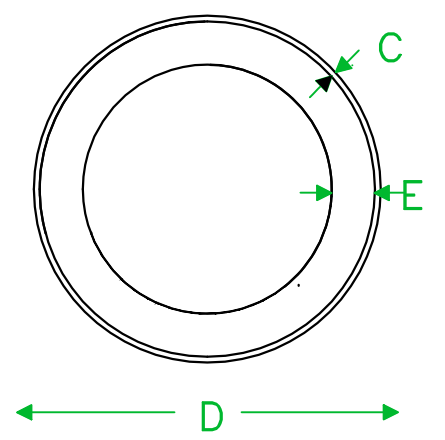

C	D	E
1	60	7.5
Dim vogel		

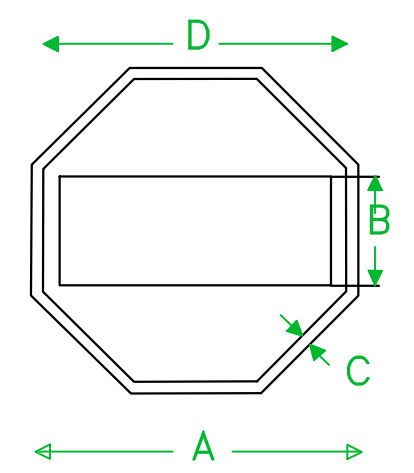

A	C	E	D
90	30	3	75
60	20	2	50

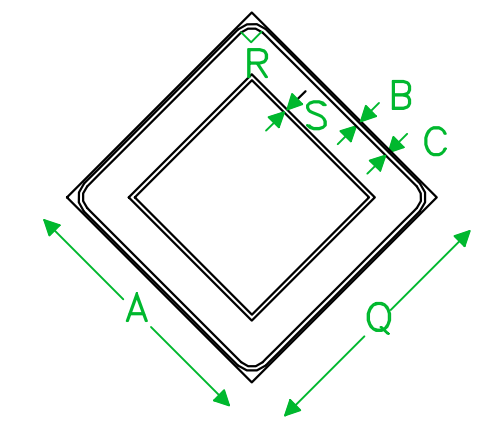

A	B	C	Q	R	S
60	0.5	1	40	3.5	11

Shenje kuadratike

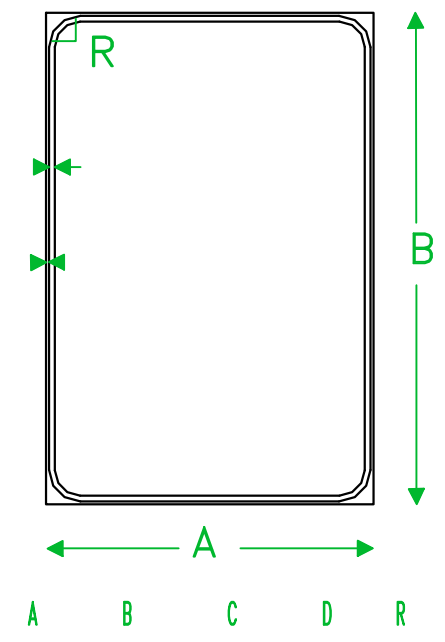

A	B	C	D	R
---	---	---	---	---

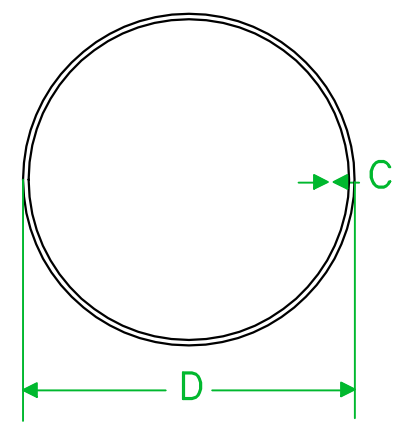

C	D
1	60
Dim vogel	
0.8	40

Shenime

Klienti  
Bashkia Memaliaj



Emertimi i projektit  
RIPARIMI I RRUGES HYRJE ZHAPOKIKE

Faza e Projektit  
PROJEKT ZBATIM

Projekti i infrastrukturës

Konsulenti  
C.E.C Group  
Civil Engineering Consultant

Projektoi	Emer Mbiemer	Firma
Insh. Nderim	Vangjush MBRIÇE	
Insh. Nderim	Anduen MBRIÇE	
Insh. Topograf	Nuredin HAMZAI	

Dwg.Nr. S1.02

Emertimi fletes:  
Detaje te sinjalistikes

KM.

Shkalla:  
A3 - 1:20



# SHENJA PLOTESUESE

## SHENJA E KTHESES NE NJE DREJTIM & DY DREJTIME

Shenja: e bardhe reflektuese

Sfondi: e zeze



240x90

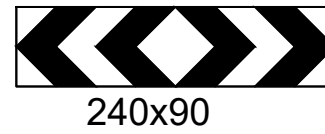

240x90

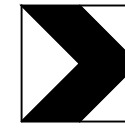

90x90

# SHENJA INFORMUESE

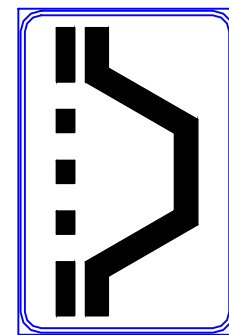

135

90

Kufizim maksimal i shpejtesise



Fig II-50

Ndalim parakalimi

Fundi i kufizimit te shpejtesise



Fig II-48

Klas 2



Fig II-71

Kryqezim me te drejte perpariesie



Fig II-43 c



Fig II-43b



Klas 2  
Fig II-37

Kthese dyfishe



Fig II-23



Fig II-17



Fig II-28



Fig II-13

Femijet

Kthese

Vendkalim kembesoresh

Kthese

Kthese dyfishe



Fig II-4



Fig II-5



Fig II-6



Fig II-7

Shenime

Klienti  
Bashkia Memaliaj



Emertimi i projektit

RIPARIMI I RRUGES HYRJE ZHAPOKIKE

Faza e Projektit

PROJEKT ZBATIM

Projekti i  
infrastruktures

Konsulenti



Projektoi	Emer Mbiemer	Firma
Insh. Nderim	Vangush MBRICË	
Insh. Nderim	Andren MBRICË	
Insh. Topograf	Nuredin HAMZAI	

Dwg.Nr. S1.03

Emertimi fletes:  
Detaje te sinjalistikes

KM.

Shkalla:

A3 - 1:20

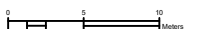

## VENDOSJA DHE MONTIMI I SHENJES RRUGORE

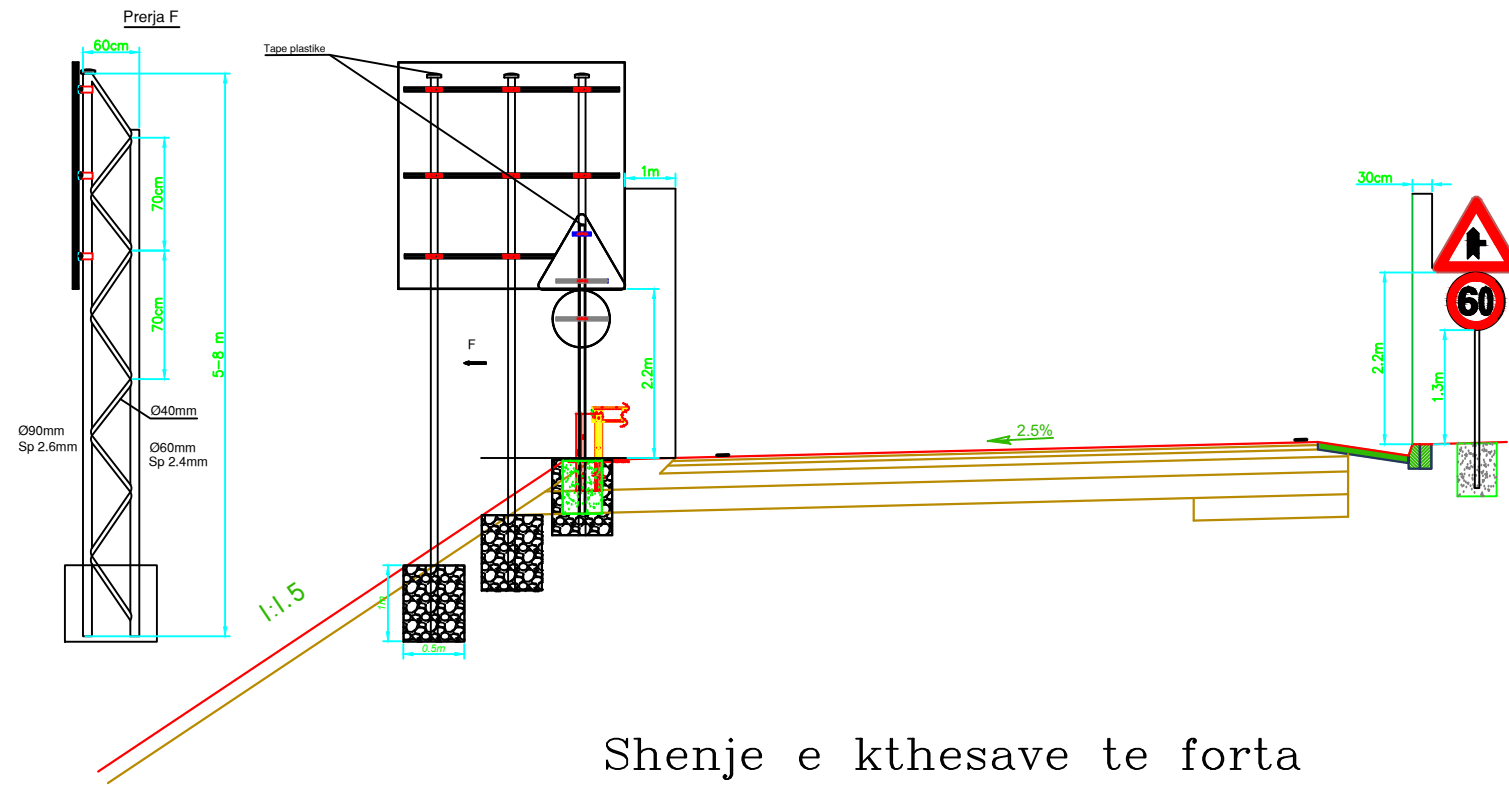

Shenje e kthesave te forta

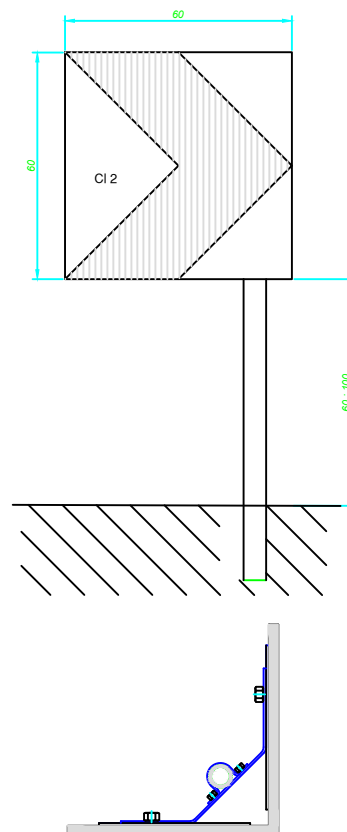

Distanca e shenjave ne kthese

RREZJA E KTHESAVE	DISTANCE
100 : 200 m	20 m
200 : 400 m	30 m
> 400 m	50 m

Shenime

Klienti  
Bashkia Memaliaj



Emertimi i projektit

RIPARIMI I RRUGES HYRJE ZHAPOKIKE

Faza e Projektit

PROJEKT ZBATIM

Projekti i  
infrastruktures

Konsulenti



Projektoi Emer Mbiemer Firma

Insh. Nderim Vangush MBRIÇE

Insh. Nderim Anduen MBRIÇE

Insh. Topograf Nuredin HAMZAI

Dwg.Nr. S1.04

Emertimi fletes:  
Detaje te sinjalistikes

KM.

Shkalla:

A3 - 1:20

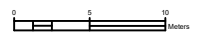



Klas 2  
Fig II-37

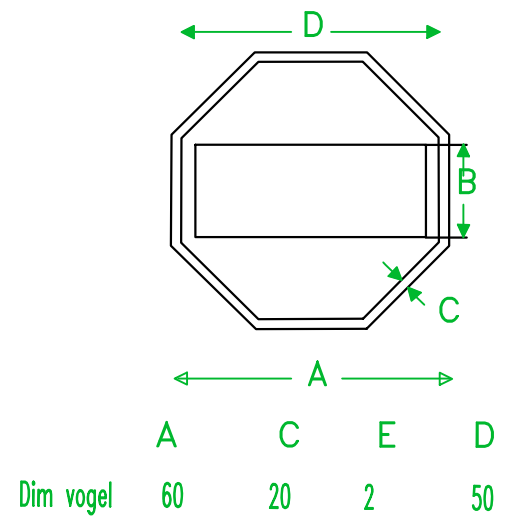

### Delineatoret Shevron triplo

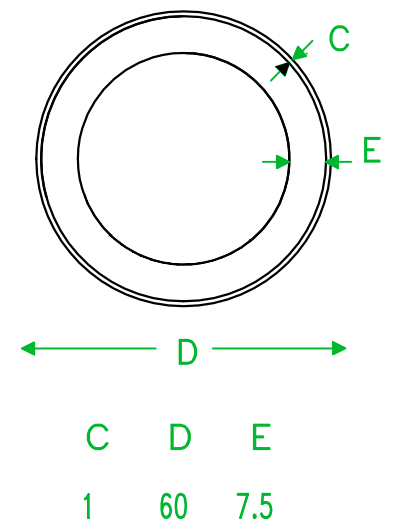

#### DISTANCA E INSTALIMIT TE SHEVRONEVE

RREZJA E KTHESES	DISTANCA
100 : 200 m	20 m
200 : 400 m	30 m
> 400 m	50 m
-	50 m

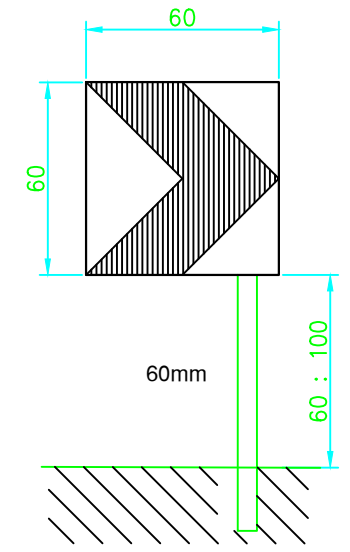

Dimensionet jane ne cm

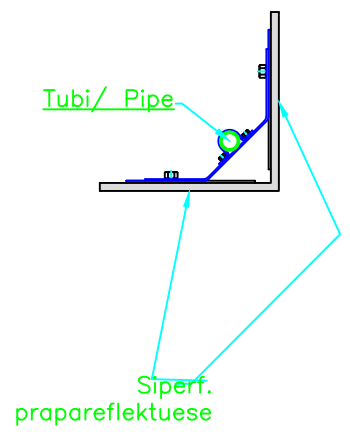

Shenime

---

Klienti  
Bashkia Memaliaj



Emertimi i projektit  
RIPARIMI I RRUGES HYRJE ZHAPOKIKE

Faza e Projektit  
PROJEKT ZBATIM

Projekti i infrastruktures

Konsulenti  
C.E.C Group  
Civil Engineering Consulting

Projektoi	Emer Mbiemer	Firma
Insh. Nderim	Vangush MBRIÇE	
Insh. Nderim	Andren MBRIÇE	
Insh. Topograf	Nuredin HAMZAI	

Dwg.Nr. S1.05

Emertimi fletes:  
Detaje te sinjalistikes

KM.

Shkalla:  
A3 - 1:20

