



REPUBLIKA E SHQIPERISË  
BASHKIA VORË

**MIRATOHET**  
BASHKIA VORE  
KRYETARI/I DELEGUARI I TIJ  
**ZNJ.ADELINA ZELA**  
SEKRETARI I PERGJITHSHEM

# PROJEKT ZBATIMI

OBJEKTI:  
"RIKONSTRUKSION I RRUGEVE MUCAJ,SHERAJ DHE E VESLEVE  
FSHATI MUCAJ ,BASHKIA VORE"



**POROSITESI : BASHKIA VORË**

OBJEKTI:  
"RIKONSTRUKSION I RRUGEVE MUCAJ,SHERAJ DHE E VESLEVE  
FSHATI MUCAJ ,BASHKIA VORE "

Emertimi: KAPAKU



"ARABEL - STUDIO" Sh.p.k  
Adresa:Njesia Bashkiake nr.7, Rruga "Frosina Plaku",  
Pallati 21, Hyrja 1, Kati 2,Tirane.  
Email: arabelstudio@gmail.com

Drejtues i projektit

Adm. Ana NISHKU  
Inxh. Ardi ARKAXHIU

Projektues

Nd. Ardi ARKAXHIU  
Ark.Rigert HYRA  
Gjeo.Irfan BEGAJ  
Elek. Altin ALLKAJ  
Top. Mustafa HOXHAJ  
Hid. Hajredin MURGU

SHKALLA FLETA

1 : 1000 1-  
Vorë 2019 Format A3

# LEGJENDA:

- 1.HOROGRAFIA E RRUGES
- 2.PLAN RILEVIMI DHE GJENDJA EKZISTUESE
- 3.PLANPIKETIMI I RRUGES
- 4.PLANI I PRISHJEVE DHE SPOSTIMI I LINJAVE T.U
- 5.PLANIMETRIA E PERGJITHSHME E RRUGES
- 6.PROFILI GJATESOR
- 7.PLANIMETRIA E K.U.B
- 8.PROFILI TIP
- 9.PROFILET TERTHORE
- 10.PLANIMETRIA E SINJALISTIKES
- 11.PLANIMETRIA E NDRICIMIT
- 12.DETAJET E RRUGES
- 13.TABELA E VOLUMEVE



**POROSITESI : BASHKIA VORË**

OBJEKTI:  
"RIKONSTRUKSION I RRUGEVE MUCAJ,SHERAJ DHE E VESLEVE  
FSHATI MUCAJ ,BASHKIA VORE "

Emertimi: KAPAKU



"ARABEL - STUDIO" Sh.p.k  
Adresa:Njesia Bashkiake nr.7, Rruga "Frosina Plaku",  
Pallati 21, Hyrja 1, Kati 2,Tirane.  
Email: arabelstudio@gmail.com

Drejtuues i projektit

Adm. Ana NISHKU  
Inxh. Ardi ARKAXHIU

Projektues

Nd. Ardi ARKAXHIU  
Ark.Rigert HYRA  
Gjeo.Irfan BEGAJ  
Elek. Altin ALLKAJ  
Top. Mustafa HOXHAJ  
Hid. Hajredin MURGU

SHKALLA

1 : 1000

Vorë 2019

FLETA

1-

Format A3



REPUBLIKA E SHQIPERISË  
BASHKIA VORË

# PROJEKT ZBATIMI

OBJEKTI:  
"RIKONSTRUKSION I RRUGEVE MUCAJ, SHERAJ DHE E VESLEVE  
FSHATI MUCAJ ,BASHKIA VORE"

1.HOROGRAFIA E RRUGES



**POROSITESI : BASHKIA VORË**

OBJEKTI:  
"RIKONSTRUKSION I RRUGEVE MUCAJ, SHERAJ DHE E VESLEVE  
FSHATI MUCAJ ,BASHKIA VORE "



Emertimi: 1.HOROGRAFIA

"ARABEL - STUDIO" Sh.p.k  
Adresa: Njesia Bashkiake nr.7, Rruga "Frosina Plaku",  
Pallati 21, Hyrja 1, Kati 2, Tirane.  
Email: arabelstudio@gmail.com

Drejtues i projektit

Adm. Ana NISHKU

Inxh. Ardi ARKAXHIU

Projektues

Nd. Ardi ARKAXHIU

Ark.Rigert HYRA

Gjeo.Irfan BEGAJ

Elek. Altin ALLKAJ

Top. Mustafa HOXHAJ

Hid. Hajredin MURGU

SHKALLA

1 : 1000

Vorë 2019

FLETA

1-

Format A3



**POROSITESI : BASHKIA VORË**

OBJEKTI:  
 "RIKONSTRUKSION I RRUGEVE MUCAJ, SHERAJ DHE E VESLEVE  
 FSHATI MUCAJ ,BASHKIA VORE "



Emertimi: 1.HOROGRAFIA

**"ARABEL - STUDIO" Sh.p.k**  
 Adresa:Njesia Bashkiake nr.7, Rruga "Frosina Plaku",  
 Pallati 21, Hyrja 1, Kati 2,Tirane.  
 Email: arabelstudio@gmail.com

**Drejtues i projektit**

Adm. Ana NISHKU  
 Inxh. Ardi ARKAXHIU

**Projektues**

Nd. Ardi ARKAXHIU  
 Ark.Rigert HYRA  
 Gjeo.Irfan BEGAJ  
 Elek. Altin ALLKAJ  
 Top. Mustafa HOXHAJ  
 Hid. Hajredin MURGU

**SHKALLA**

1 : 1000  
 Vorë 2019

**FLETA**

1- 01  
 Format A3



REPUBLIKA E SHQIPERISË  
BASHKIA VORË

# PROJEKT ZBATIMI

OBJEKTI:

"RIKONSTRUKSION I RRUGEVE MUCAJ, SHERAJ DHE E VESLEVE, FSHATI MUCAJ"











BASHKIA VORË



## 2. PLAN RILEVIMI I RRUGES

	<b>POROSITESI : BASHKIA VORË</b>	<b>Emertimi: PLAN RILEVIMI I RRUGES</b>		<b>Drejtues i projektit</b>		<b>Projektues</b>		<b>SHKALLA</b>	<b>FLETA</b>
	OBJEKTI: "RIKONSTRUKSION I RRUGEVE MUCAJ, SHERAJ DHE E VESLEVE FSHATI MUCAJ ,BASHKIA VORE "	 <b>"ARABEL - STUDIO" Sh.p.k</b> Adresa:Njesia Bashkiake nr.7, Rruga "Frosina Plaku", Pallati 21, Hyrja 1, Kati 2,Tirane. Email: arabelstudio@gmail.com	Adm. Ana NISHKU	Inxh. Ardi ARKAXHIU	Nd. Ardi ARKAXHIU	Elek. Altin ALLKAJ	Ark.Rigert HYRA	Hid. Hajredin MURGU	-
								Vorë 2018	Format A3

LEGJENDA

-  Asfalt ekzistues
-  Rruga ekzistuese
-  Aksi i ri
-  Objekt Ekzistues
-  Shtyll elektrike
-  Mur ekzistues
-  Skarpota
-  Gardh
-  Porte
-  Pike Relievi

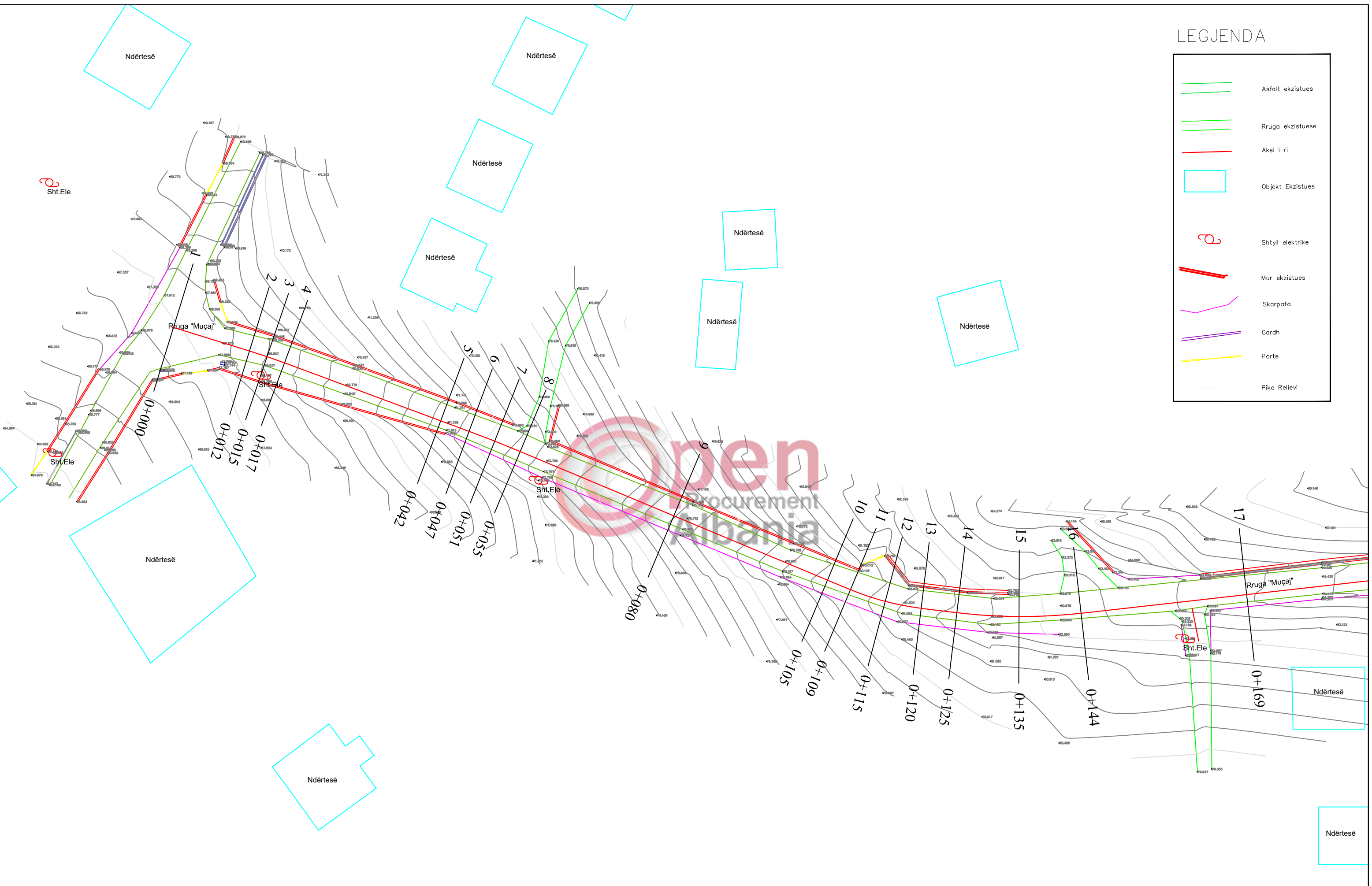

**POROSITESI : BASHKIA VORË**  
 OBJEKTI:  
 "RIKONSTRUKSION I RRUGEVE MUCAJ, SHERAJ DHE E VESLEVE FSHATI MUCAJ ,BASHKIA VORE "

Emertimi: PLANRILEVIMI DHE GJENDJA EKZISTUESE  
 **"ARABEL - STUDIO" Sh.p.k**  
 Adresa: Njesia Bashkiake nr.7, Rruga "Frosina Plaku", Pallati 21, Hyrja 1, Kati 2, Tirane.  
 Email: arabelstudio@gmail.com

**Drejtes i projektit**  
 Adm. Ana NISHKU  
 Inxh. Ardi ARKAXHIU

**Projektues**

Nd. Ardi ARKAXHIU	Elek. Altin ALLKAJ
Ark.Rigert HYRA	Top. Mustafa HOXHAJ
Gjeo.Irfan BEGAJ	Hid. Hajredin MURGU

<b>SHKALLA</b>	<b>FLETA</b>
1 : 500	2- 01
Vorë 2019	Format A3

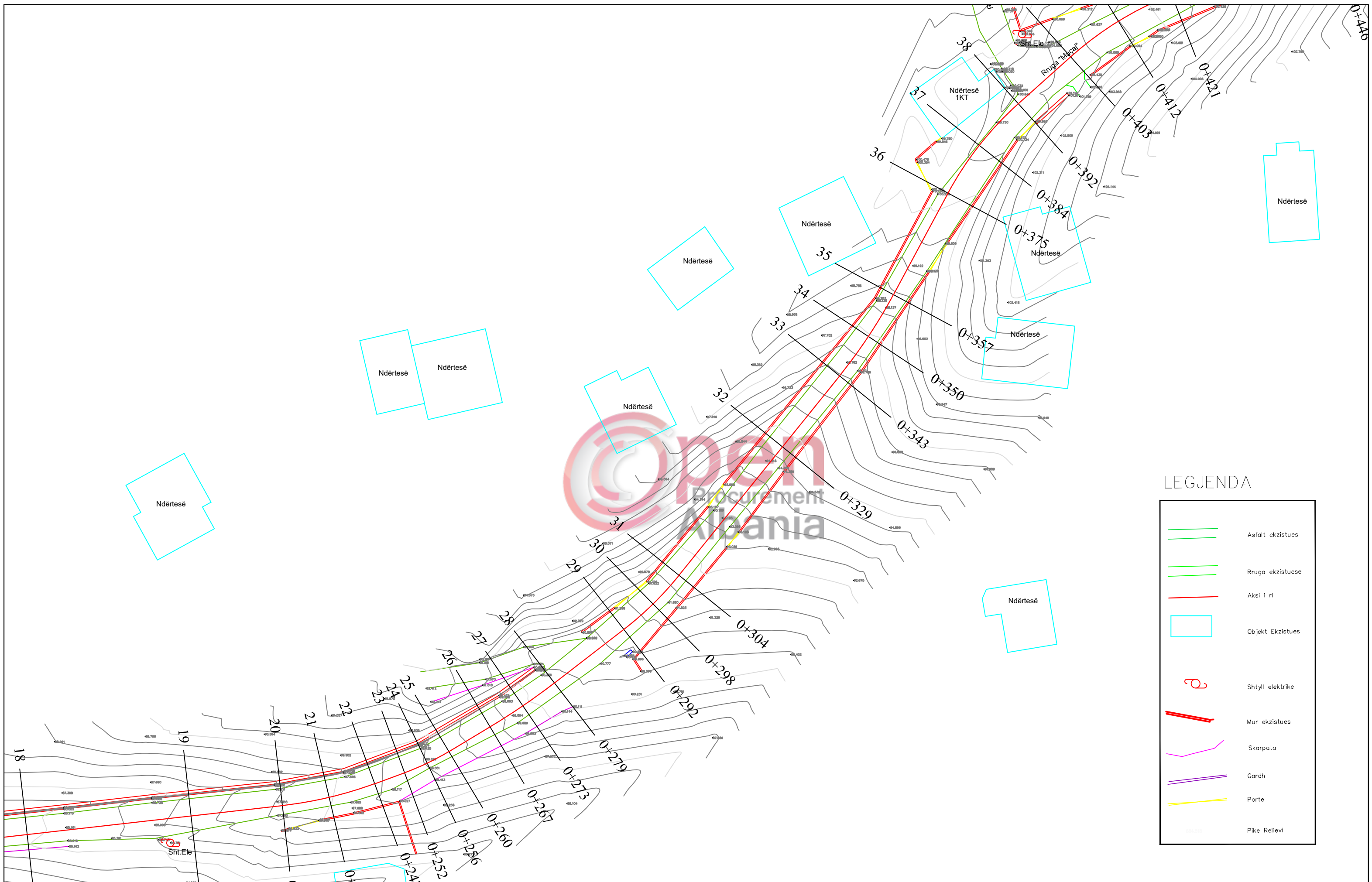

LEGJENDA

	Asfalt ekzistues
	Rruga ekzistuese
	Aksi i ri
	Objekt Ekzistues
	Shtyll elektrike
	Mur ekzistues
	Skarpata
	Gardh
	Porte
	Pike Relievi



**POROSITESI : BASHKIA VORË**  
 OBJEKTI:  
 "RIKONSTRUKSION I RRUGEVE MUCAJ, SHERAJ DHE E VESLEVE FSHATI MUCAJ ,BASHKIA VORE "

Emertimi: PLANRILEVIMI DHE GJENDJA EKZISTUESE  
  
**"ARABEL - STUDIO" Sh.p.k**  
 Adresa: Njesia Bashkiake nr.7, Rruga "Frosina Plaku", Pallati 21, Hyrja 1, Kati 2, Tirane.  
 Email: arabelstudio@gmail.com









Drejtesues i projektit  
 Adm. Ana NISHKU  
 Inxh. Ardi ARKAXHIU

Projektues  
 Nd. Ardi ARKAXHIU  
 Ark.Rigert HYRA  
 Gjeo.Irfan BEGAJ  
 Elek. Altin ALLKAJ  
 Top. Mustafa HOXHAI  
 Hid. Hajredin MURGU

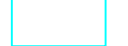
SHKALLA  
 1 : 500  
 Vorë 2019

FLETA  
 2- 02  
 Format A3

LEJENDA

-  Asfalt ekzistues
-  Rruga ekzistuese
-  Aksi i ri
-  Objekt Ekzistues
-  Shtyll elektrike
-  Mur ekzistues
-  Skarpata
-  Gardh
-  Porte
-  Pike Relievi

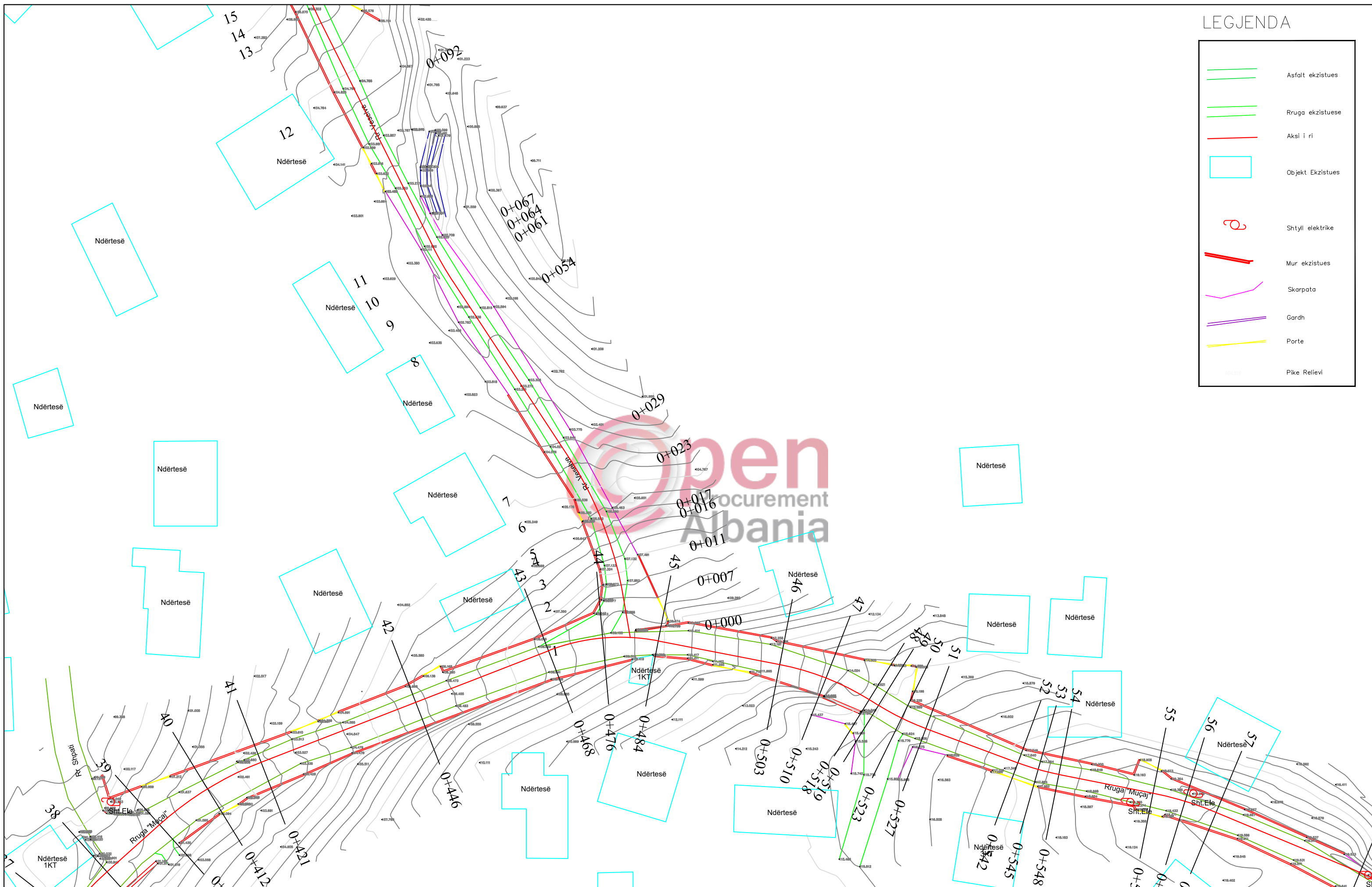

**POROSITESI : BASHKIA VORË**  
 OBJEKTI:  
 "RIKONSTRUKSION I RRUGEVE MUCAJ, SHERAJ DHE E VESLEVE  
 FSHATI MUCAJ ,BASHKIA VORE "

Emertimi: PLANRILEVIMI DHE GJENDJA EKZISTUESE  
 **"ARABEL - STUDIO" Sh.p.k**  
 Adresa:Njesia Bashkiake nr.7, Rruga "Frosina Plaku",  
 Pallati 21, Hyrja 1, Kati 2,Tirane.  
 Email: arabelstudio@gmail.com

**Drejtesues i projektit**  
 Adm. Ana NISHKU  
 Inxh. Ardi ARKAXHIU

**Projektues**

Nd. Ardi ARKAXHIU	Elek. Altin ALLKAJ
Ark.Rigert HYRA	Top. Mustafa HOXHAJ
Gjeo.Irfan BEGAJ	Hid. Hajredin MURGU

<b>SHKALLA</b>	<b>FLETA</b>
1 : 500	2- 03
Vorë 2019	Format A3



LEGJENDA

	Asfalt ekzistues
	Rruga ekzistuese
	Aksi i ri
	Objekt Ekzistues
	Shtyll elektrike
	Mur ekzistues
	Skarpata
	Gardh
	Porte
	Pike Relievi

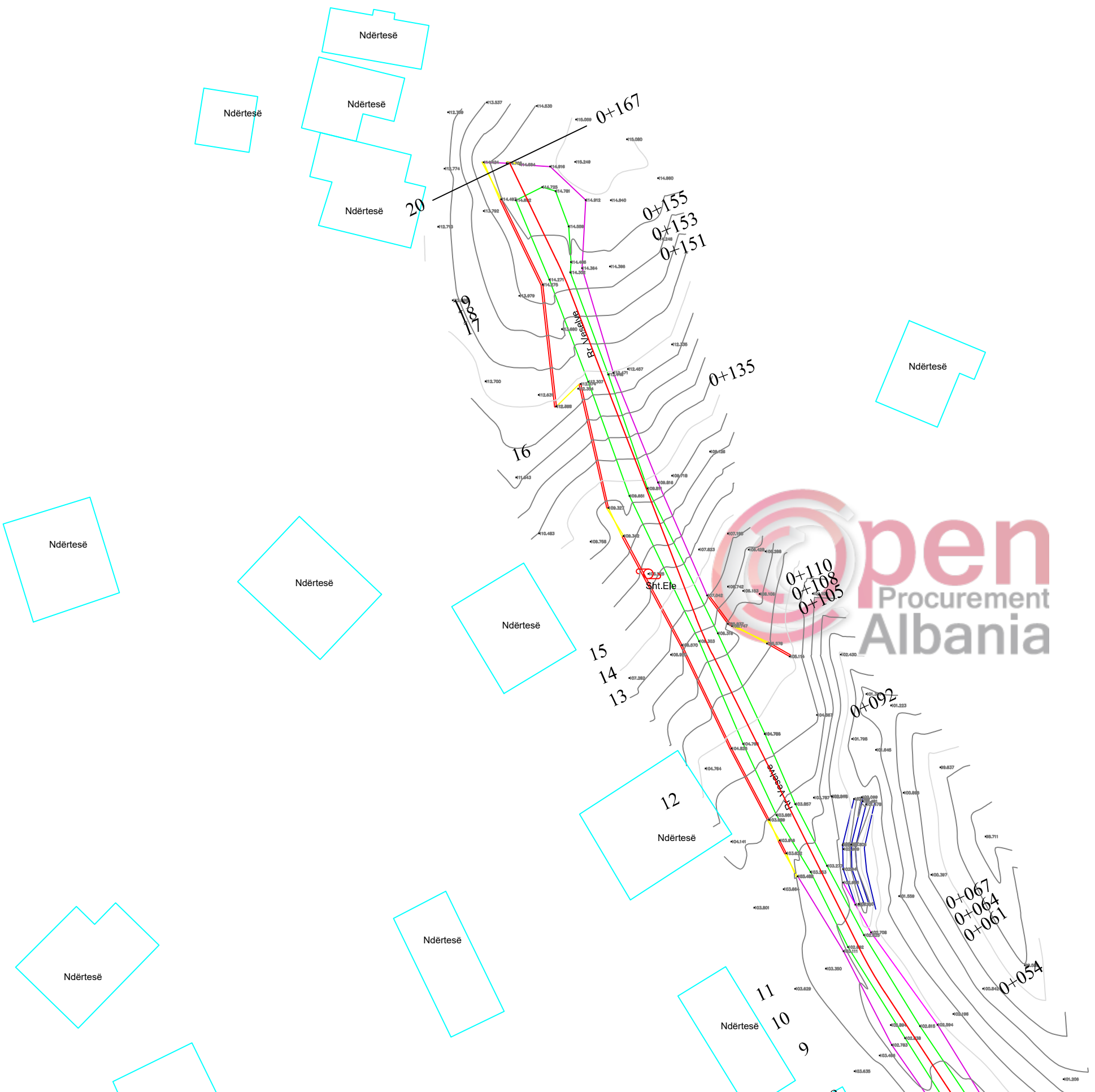

**POROSITESI : BASHKIA VORË**  
 OBJEKTI:  
 "RIKONSTRUKSION I RRUGEVE MUCAJ, SHERAJ DHE E VESLEVE FSHATI MUCAJ ,BASHKIA VORE "

Emertimi: PLANRILEVIMI DHE GJENDJA EKZISTUESE  
 **"ARABEL - STUDIO" Sh.p.k**  
 Adresa: Njesia Bashkiake nr.7, Rruga "Frosina Plaku", Pallati 21, Hyrja 1, Kati 2, Tirane.  
 Email: arabelstudio@gmail.com











**Drejtesues i projektit**  
 Adm. Ana NISHKU  
 Inxh. Ardi ARKAXHIU

**Projektues**

Nd. Ardi ARKAXHIU	Elek. Altin ALLKAJ
Ark.Rigert HYRA	Top. Mustafa HOXHAI
Gjeo.Irfan BEGAJ	Hid. Hajredin MURGU

<b>SHKALLA</b>	<b>FLETA</b>
1 : 500	2- 05
Vorë 2019	Format A3

LEGJENDA

	Asfalt ekzistues
	Rruga ekzistuese
	Aksi i ri
	Objekt Ekzistues
	Shtyll elektrike
	Mur ekzistues
	Skarpata
	Gardh
	Porte
	Pike Relievi

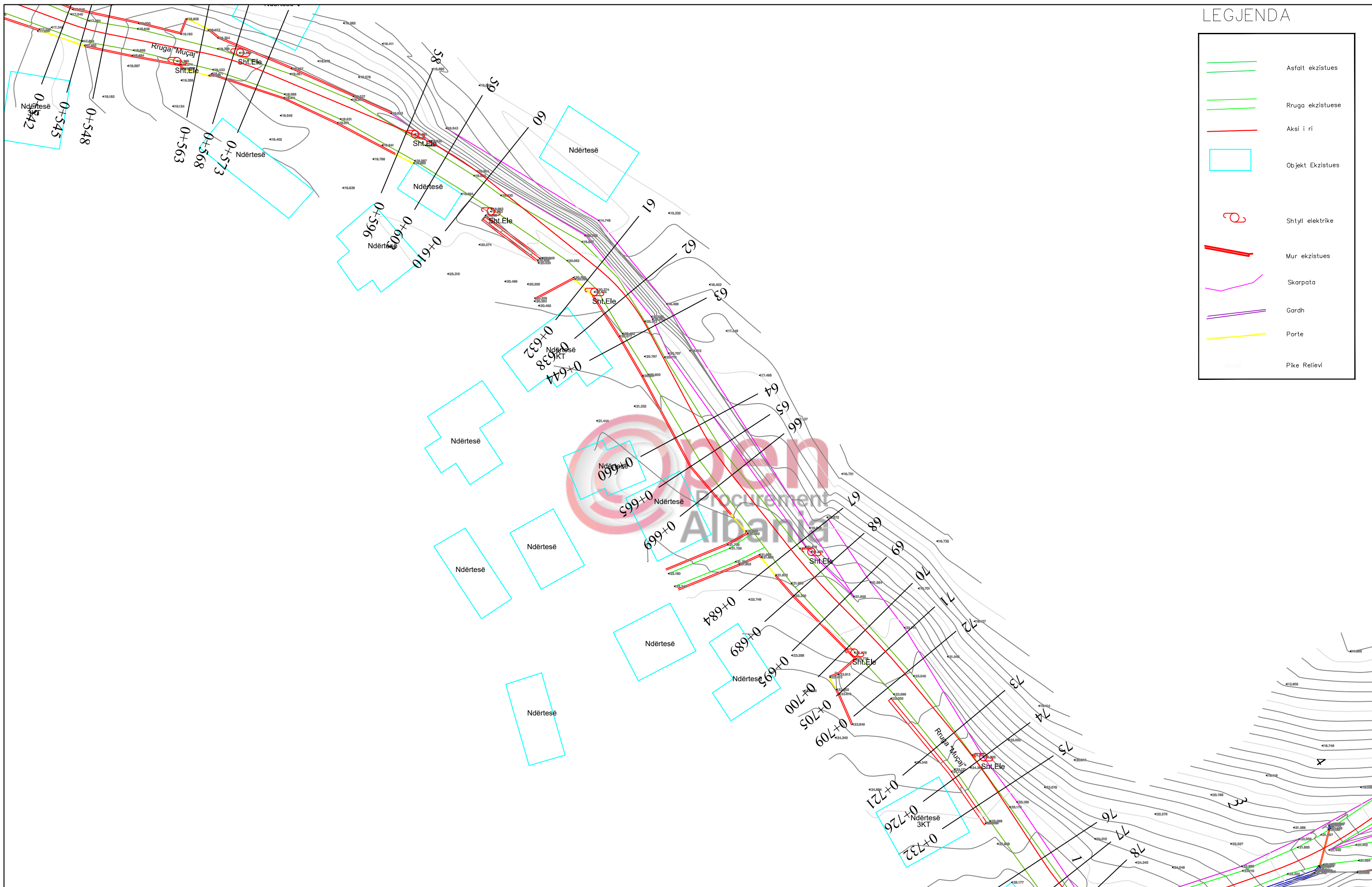

**POROSITESI : BASHKIA VORË**  
 OBJEKTI:  
 "RIKONSTRUKSION I RRUGEVE MUCAJ, SHERAJ DHE E VESLEVE  
 FSHATI MUCAJ ,BASHKIA VORE "

Emertimi: PLANRILEVIMI DHE GJENDJA EKZISTUESE  
 **"ARABEL - STUDIO" Sh.p.k**  
 Adresa: Njesia Bashkiake nr.7, Rruga "Frosina Plaku",  
 Pallati 21, Hyrja 1, Kati 2, Tirane.  
 Email: arabelstudio@gmail.com

**Drejtes i projektit**  
 Adm. Ana NISHKU  
 Inxh. Ardi ARKAXHIU

**Projektues**

Nd. Ardi ARKAXHIU	Elek. Altin ALLKAJ
Ark.Rigert HYRA	Top. Mustafa HOXHAI
Gjeo.Irfan BEGAJ	Hid. Hajredin MURGU

<b>SHKALLA</b>	<b>FLETA</b>
1 : 500	2- 05
Vorë 2019	Format A3

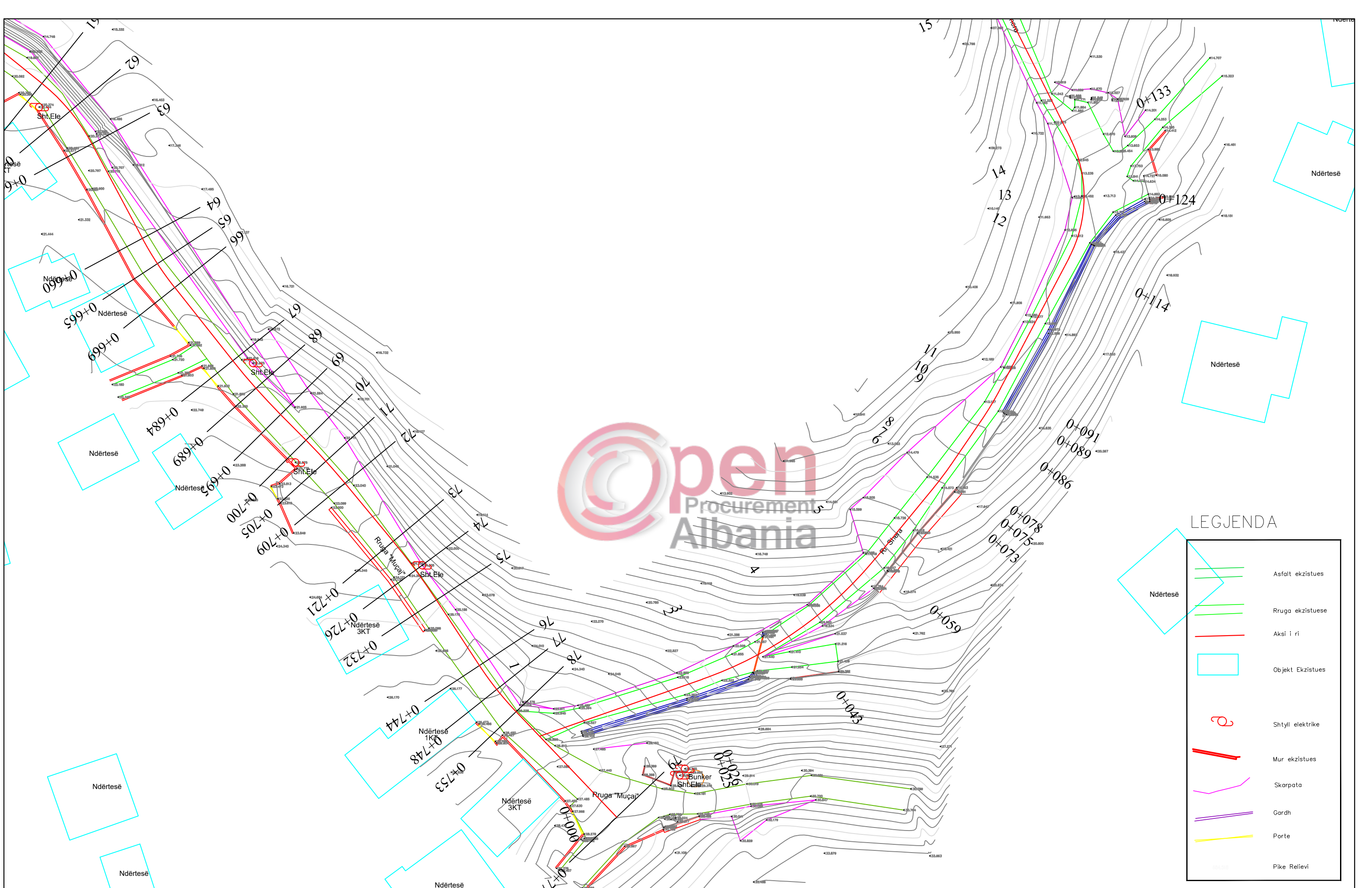

**Open**  
Procurement  
Albania

LEGJENDA

	Asfalt ekzistues
	Rruga ekzistuese
	Aksi i ri
	Objekt Ekzistues
	Shtyll elektrike
	Mur ekzistues
	Skarpota
	Gardh
	Porte
	Pike Relievi



**POROSITESI : BASHKIA VORË**  
OBJEKTI:  
"RIKONSTRUKSION I RRUGEVE MUCAJ, SHERAJ DHE E VESLEVE  
FSHATI MUCAJ ,BASHKIA VORE "

Emertimi: PLANRILEVIMI DHE GJENDJA EKZISTUESE  
  
"ARABEL - STUDIO" Sh.p.k  
Adresa: Njesia Bashkiake nr.7, Rruga "Frosina Plaku",  
Pallati 21, Hyrja 1, Kati 2, Tirane.  
Email: arabelstudio@gmail.com

Drejtesues i projektit  
Adm. Ana NISHKU  
Inxh. Ardi ARKAXHIU

Projektues  
Nd. Ardi ARKAXHIU  
Ark.Rigert HYRA  
Gjeo.Irfan BEGAJ  
Elek. Altin ALLKAJ  
Top. Mustafa HOXHAI  
Hid. Hajredin MURGU

SHKALLA	FLETA
1 : 500	2- 06
Vorë 2019	Format A3

# LEGJENDA

	Asfalt ekzistues
	Rruga ekzistuese
	Aksi i ri
	Objekt Ekzistues
	Shtyll elektrike
	Mur ekzistues
	Skarpata
	Gardh
	Porte
	Pike Relievi

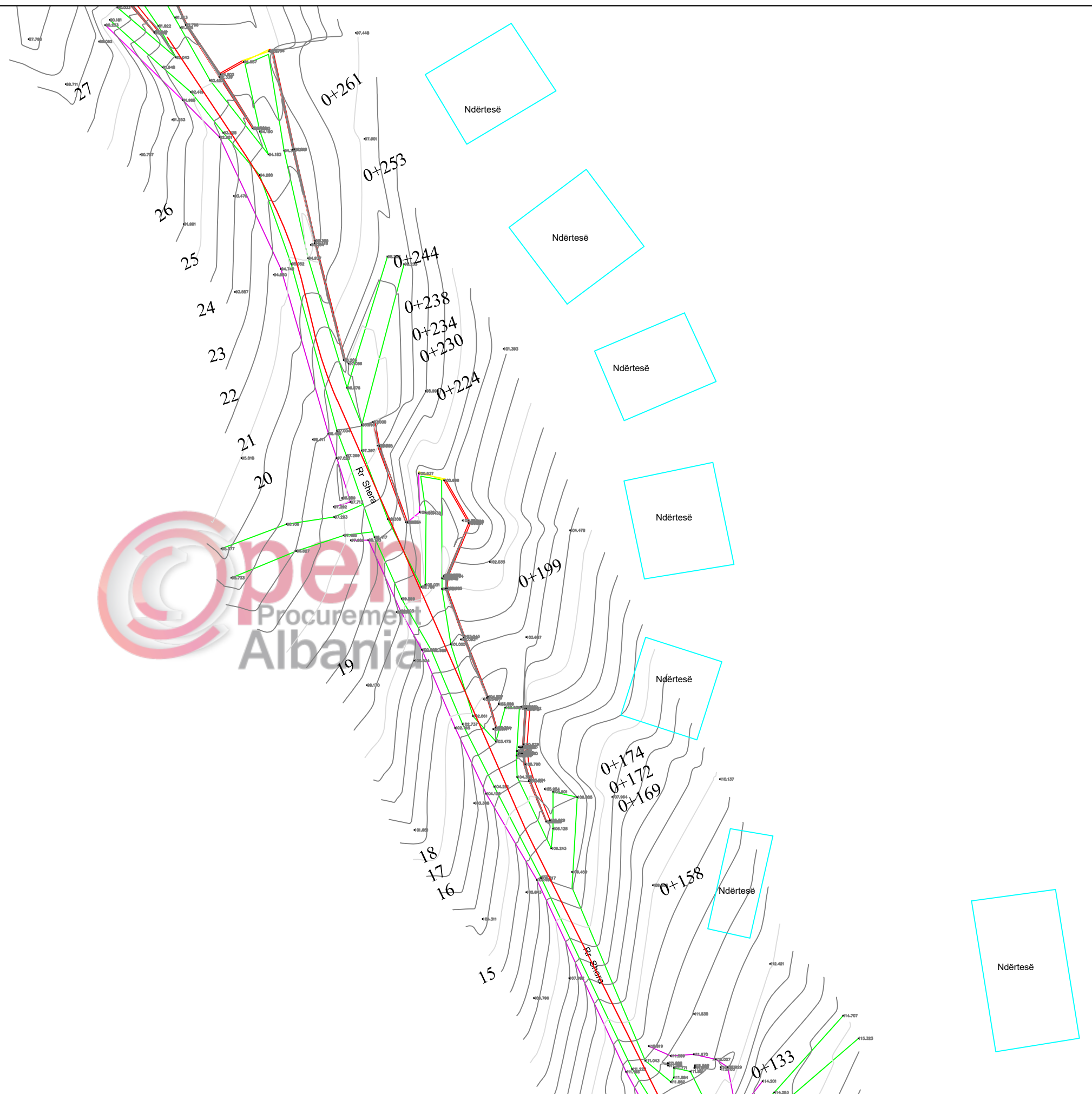

**POROSITESI : BASHKIA VORË**

OBJEKTI:  
"RIKONSTRUKSION I RRUGEVE MUCAJ, SHERAJ DHE E VESLEVE  
FSHATI MUCAJ ,BASHKIA VORE "

Emertimi: PLANRILEVIMI DHE GJENDJA EKZISTUESE

**"ARABEL - STUDIO" Sh.p.k**  
Adresa: Njesia Bashkiake nr.7, Rruga "Frosina Plaku",  
Pallati 21, Hyrja 1, Kati 2, Tirane.  
Email: arabelstudio@gmail.com

**Drejtes i projektit**

Adm. Ana NISHKU  
Inxh. Ardi ARKAXHIU

**Projektues**

Nd. Ardi ARKAXHIU	Elek. Altin ALLKAJ
Ark.Rigert HYRA	Top. Mustafa HOXHAI
Gjeo.Irfan BEGAJ	Hid. Hajredin MURGU

<b>SHKALLA</b>	<b>FLETA</b>
1 : 500	2- 07
Vorë 2019	Format A3

# PROJEKT ZBATIMI

## OBJEKTI:

"RIKONSTRUKSION I RRUGEVE MUCAJ, SHERAJ DHE E VESLEVE  
FSHATI MUCAJ , BASHKIA VORE "

3.PLANPIKETIMI I RRUGES



**POROSITESI : BASHKIA VORË**

OBJEKTI:  
"RIKONSTRUKSION I RRUGEVE MUCAJ, SHERAJ DHE E VESLEVE  
FSHATI MUCAJ , BASHKIA VORE "

Emertimi: PLAN PIKETIMI I RUGES



"ARABEL - STUDIO" Sh.p.k  
Adresa: Njesia Bashkiake nr.7, Rruga "Frosina Plaku",  
Pallati 21, Hyrja 1, Kati 2, Tirane.  
Email: arabelstudio@gmail.com

Drejtues i projektit

Adm. Ana NISHKU  
Inxh. Ardi ARKAXHIU

Projektues

Nd. Ardi ARKAXHIU  
Ark.Rigert HYRA  
Gjeo.Irfan BEGAJ  
Elek. Altin ALLKAJ  
Top. Mustafa HOXHAJ  
Hid. Hajredin MURGU

SHKALLA FLETA

1 : 3-  
Vorë 2019 Format A3

<b>FILLIMI</b>
E= 388580.501
N= 4583236.070

<b>1V2</b>	a = 3.54025c
	E= 388594.554
	N= 4583231.730
EI	<b>KURBA:1V2</b>
Ec	388562.388
Nc	4583137.003
R	100.000
a	3.54022c
Sv	5.561
Tg	2.781
Bs	0.039

<b>1V3</b>	a = 2.62560c
	E= 388628.730
	N= 4583219.055
EI	<b>KURBA:1V3</b>
Ec	388555.318
Nc	4583032.974
R	200.000
a	2.62566c
Sv	8.249
Tg	4.125
Bs	0.043

<b>1V4</b>	a = -17.51797c
	E= 388687.211
	N= 4583194.578
EI	<b>KURBA:1V4</b>
Ec	388697.546
Nc	4583233.615
R	40.000
a	17.51797c
Sv	11.007
Tg	5.538
Bs	0.382

<b>1V5</b>	a = -14.87776c
	E= 388707.397
	N= 4583192.119
EI	<b>KURBA:1V5</b>
Ec	388707.749
Nc	4583272.668
R	80.000
a	14.87776c
Sv	18.696

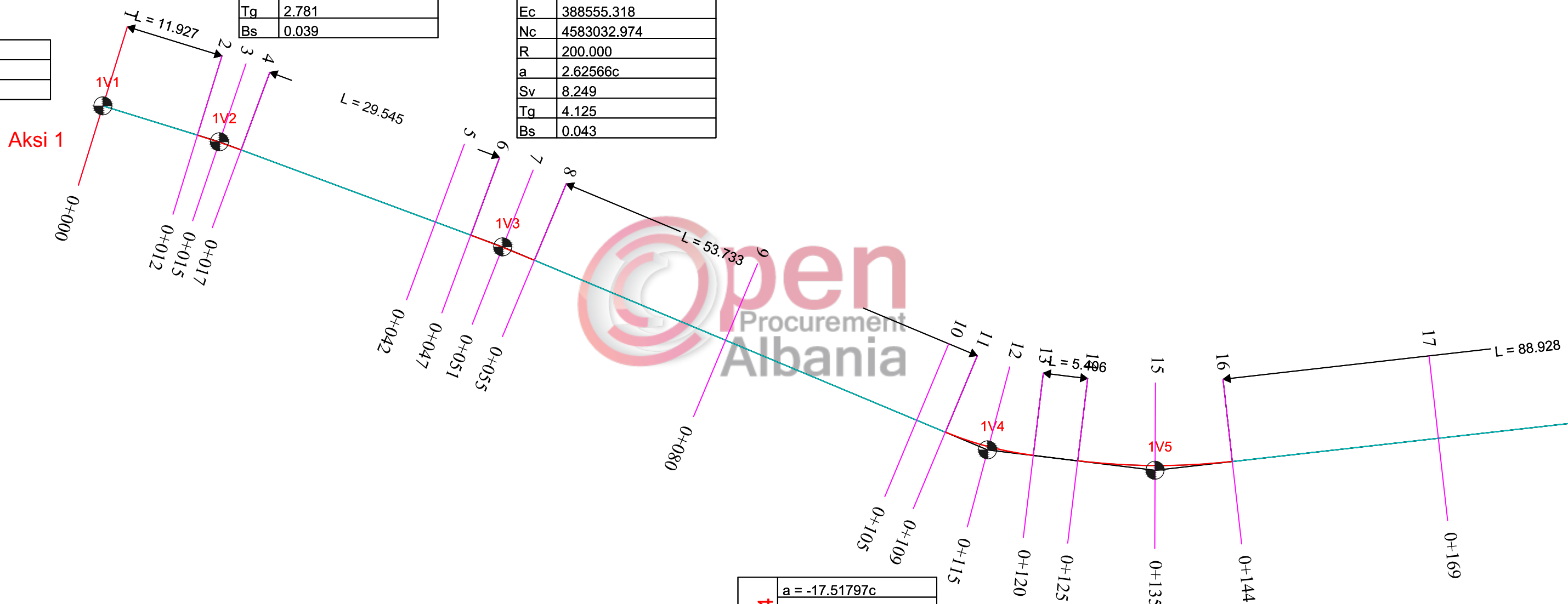

## POROSITESI : BASHKIA VORË

OBJEKTI:  
"RIKONSTRUKSION I RRUGEVE MUCAJ, SHERAJ DHE E VESLEVE  
FSHATI MUCAJ , BASHKIA VORE "



Emertimi: PLANPIKETIMI I RRUGES

"ARABEL - STUDIO" Sh.p.k  
Adresa: Njesia Bashkiake nr.7, Rruga "Frosina Plaku",  
Pallati 21, Hyrja 1, Kati 2, Tirane.  
Email: arabelstudio@gmail.com

Drejtues i projektit

Adm. Ana NISHKU  
Inxh. Ardi ARKAXHIU

Projektues

Nd. Ardi ARKAXHIU  
Ark.Rigert HYRA  
Gjeo.Irfan BEGAJ  
Elek. Altin ALLKAJ  
Top. Mustafa HOXHAJ  
Hid. Hajredin MURGU

SHKALLA

1 : 500

FLETA

3- 01

Vorë 2019

Format A3

R	50.000
a	22.05432c
Sv	17.321
Tg	8.748
Bs	0.760

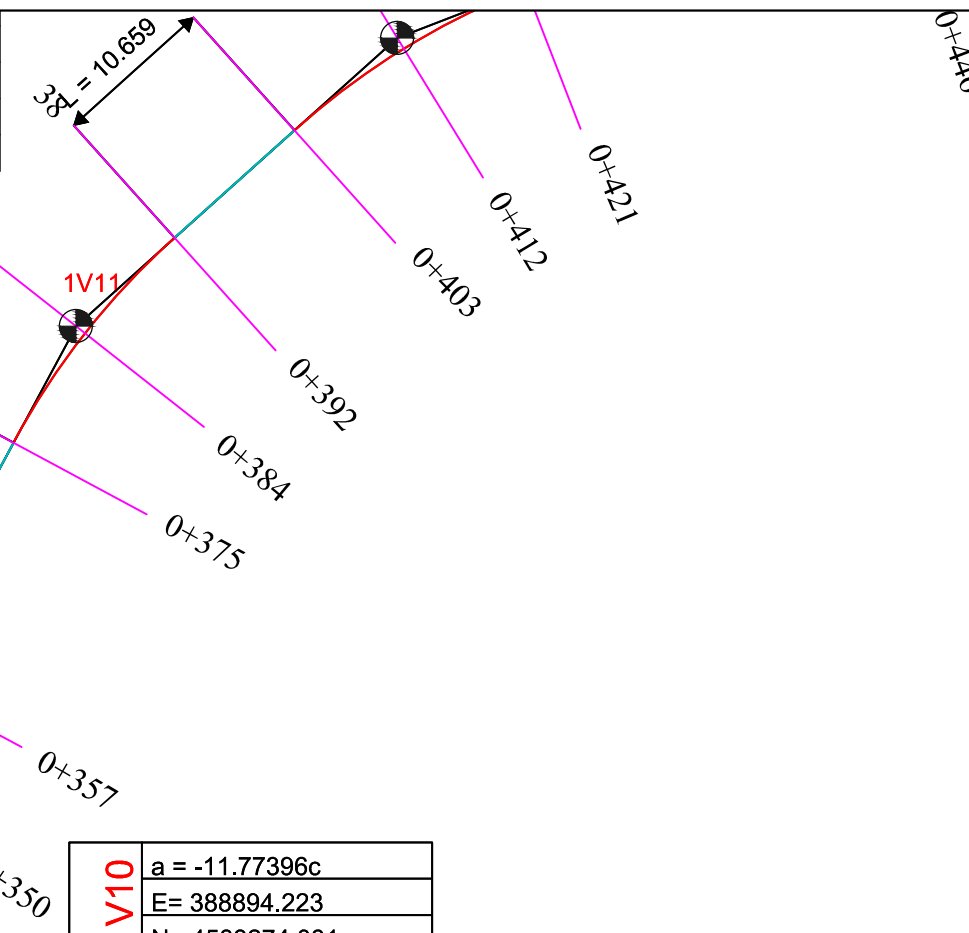

<b>1V10</b>	a = -11.77396c
	E= 388894.223
	N= 4583274.081
EI	<b>KURBA:1V10</b>
Ec	388827.264
Nc	4583318.483
R	80.000
a	11.77396c
Sv	14.796
Tg	7.419
Bs	0.343

<b>1V8</b>	a = -7.52615c
	E= 388841.660
	N= 4583218.133
EI	<b>KURBA:1V8</b>
Ec	388785.201
Nc	4583300.882
R	100.000
a	7.52615c
Sv	11.822
Tg	5.918
Bs	0.175

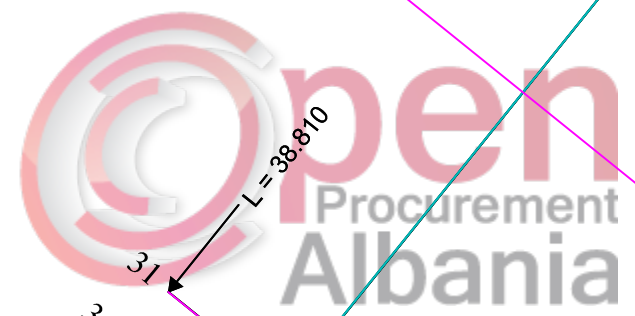

<b>1V9</b>	a = -14.95598c
	E= 388861.525
	N= 4583233.482
EI	<b>KURBA:1V9</b>
Ec	388826.285
Nc	4583269.440
R	50.000
a	14.95598c
Sv	11.746
Tg	5.900
Bs	0.347

<b>1V7</b>	a = -11.88798c
	E= 388827.124

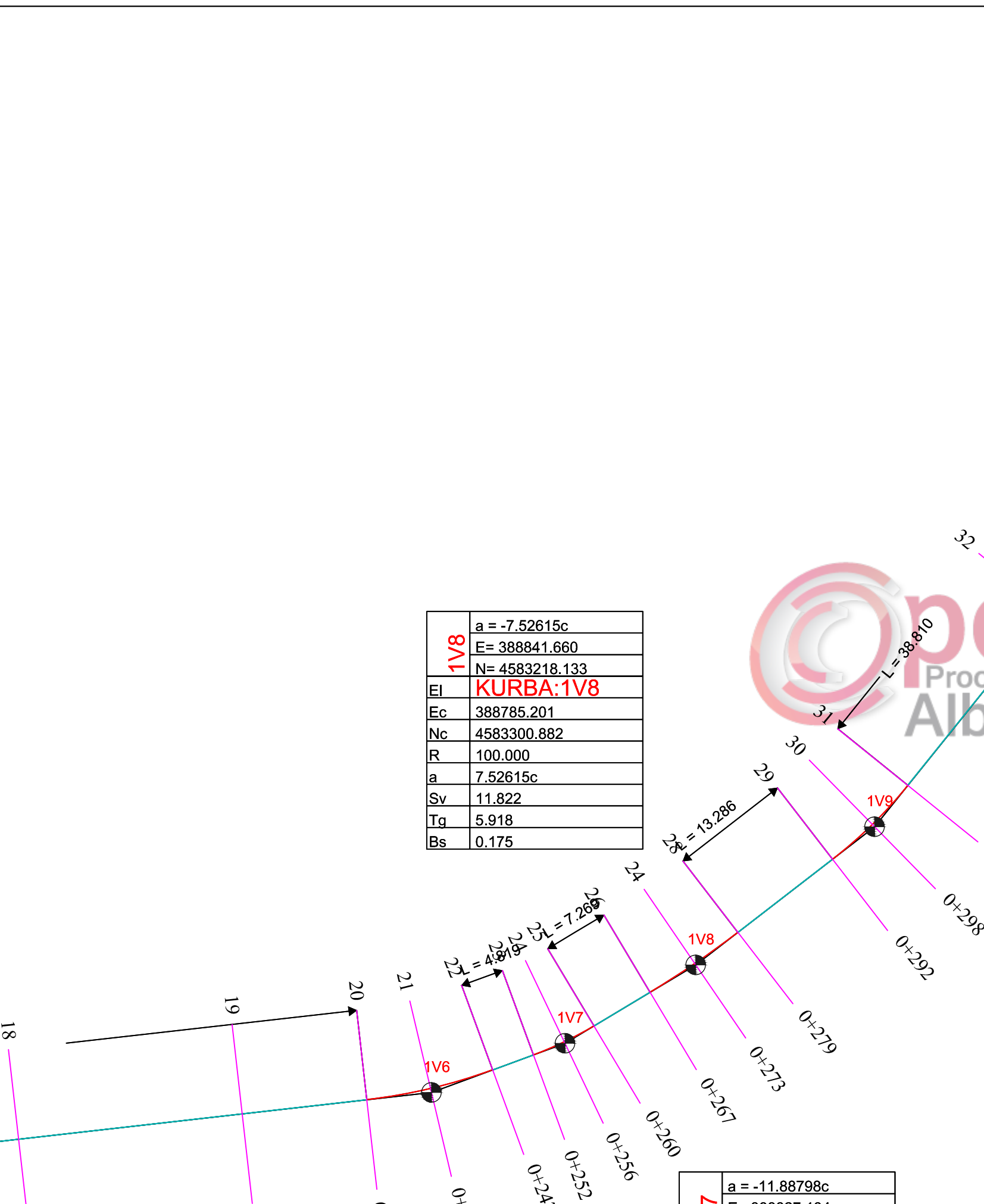

**POROSITESI : BASHKIA VORË**  
 OBJEKTI:  
 "RIKONSTRUKSION I RRUGEVE MUCAJ, SHERAJ DHE E VESLEVE FSHATI MUCAJ ,BASHKIA VORE "

Emertimi: PLANPIKETIMI I RRUGES  
**"ARABEL - STUDIO" Sh.p.k**  
 Adresa:Njesia Bashkiake nr.7, Rruga "Frosina Plaku", Pallati 21, Hyrja 1, Kati 2,Tirane.  
 Email: arabelstudio@gmail.com

Drejtesues i projektit  
 Adm. Ana NISHKU  
 Inxh. Ardi ARKAXHIU

Projektues  
 Nd. Ardi ARKAXHIU  
 Ark.Rigert HYRA  
 Gjeo.Irfan BEGAJ  
 Elek. Altin ALLKAJ  
 Top. Mustafa HOXHAJ  
 Hid. Hajredin MURGU

SHKALLA	FLETA
1 : 500	3- 02
Vorë 2019	Format A3

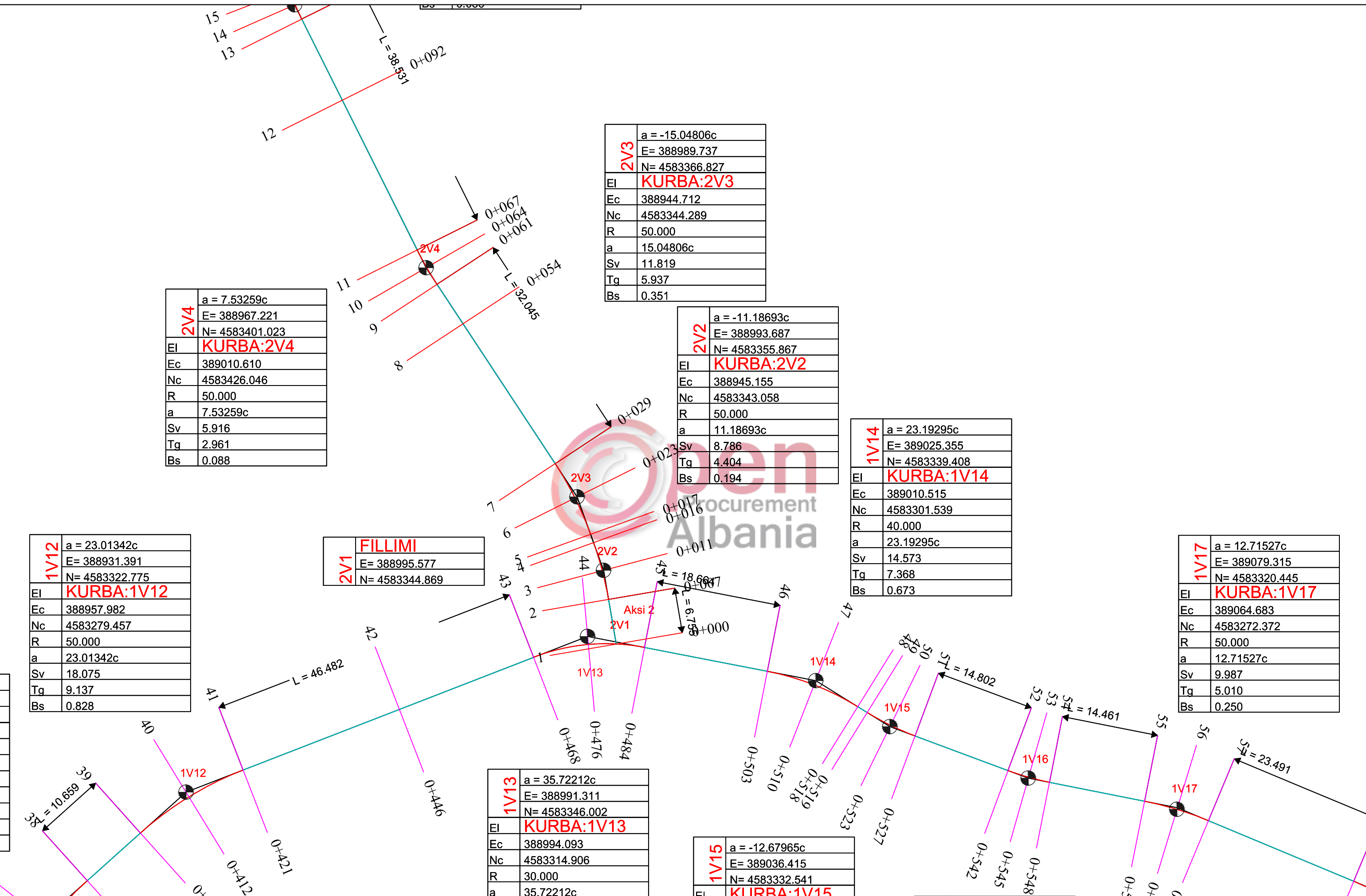

<b>2V4</b>	a = 7.53259c
	E= 388967.221
	N= 4583401.023
EI	<b>KURBA:2V4</b>
Ec	389010.610
Nc	4583426.046
R	50.000
a	7.53259c
Sv	5.916
Tg	2.961
Bs	0.088

<b>2V3</b>	a = -15.04806c
	E= 388989.737
	N= 4583366.827
EI	<b>KURBA:2V3</b>
Ec	388944.712
Nc	4583344.289
R	50.000
a	15.04806c
Sv	11.819
Tg	5.937
Bs	0.351

<b>2V2</b>	a = -11.18693c
	E= 388993.687
	N= 4583355.867
EI	<b>KURBA:2V2</b>
Ec	388945.155
Nc	4583343.058
R	50.000
a	11.18693c
Sv	8.786
Tg	4.404
Bs	0.194

<b>1V14</b>	a = 23.19295c
	E= 389025.355
	N= 4583339.408
EI	<b>KURBA:1V14</b>
Ec	389010.515
Nc	4583301.539
R	40.000
a	23.19295c
Sv	14.573
Tg	7.368
Bs	0.673

<b>1V17</b>	a = 12.71527c
	E= 389079.315
	N= 4583320.445
EI	<b>KURBA:1V17</b>
Ec	389064.683
Nc	4583272.372
R	50.000
a	12.71527c
Sv	9.987
Tg	5.010
Bs	0.250

<b>1V12</b>	a = 23.01342c
	E= 388931.391
	N= 4583322.775
EI	<b>KURBA:1V12</b>
Ec	388957.982
Nc	4583279.457
R	50.000
a	23.01342c
Sv	18.075
Tg	9.137
Bs	0.828

<b>2V1</b>	<b>FILLIMI</b>
	E= 388995.577
	N= 4583344.869

<b>1V13</b>	a = 35.72212c
	E= 388991.311
	N= 4583346.002
EI	<b>KURBA:1V13</b>
Ec	388994.093
Nc	4583314.906
R	30.000
a	35.72212c

<b>1V15</b>	a = -12.67965c
	E= 389036.415
	N= 4583332.541
EI	<b>KURBA:1V15</b>

**POROSITESI : BASHKIA VORË**

OBJEKTI:  
"RIKONSTRUKSION I RRUGEVE MUCAJ, SHERAJ DHE E VESLEVE FSHATI MUCAJ ,BASHKIA VORE "

Emertimi: PLANPIKETIMI I RRUGES

**"ARABEL - STUDIO" Sh.p.k**

Adresa: Njesia Bashkiake nr.7, Rruga "Frosina Plaku", Pallati 21, Hyrja 1, Kati 2, Tirane.  
Email: arabelstudio@gmail.com

Drejtes i projektit

Adm. Ana NISHKU

Inxh. Ardi ARKAXHIU

Projektues

Nd. Ardi ARKAXHIU	Elek. Altin ALLKAJ
Ark.Rigert HYRA	Top. Mustafa HOXHAI
Gjeo.Irfan BEGAJ	Hid. Hajredin MURGU

SHKALLA	FLETA
1 : 500	3- 03
Vorë 2019	Format A3



<b>2V7</b>	<b>FUNDI</b>
E=	388924.942
N=	4583495.537

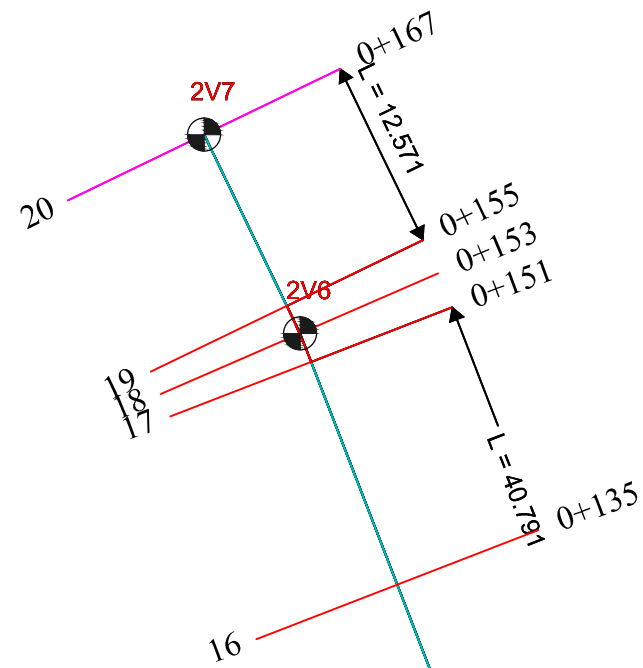

<b>2V6</b>	a = -5.14764c
E=	388931.289
N=	4583482.396
EI	<b>KURBA:2V6</b>
Ec	388885.386
Nc	4583462.471
R	50.000
a	5.14765c
Sv	4.043
Tg	2.023
Bs	0.041

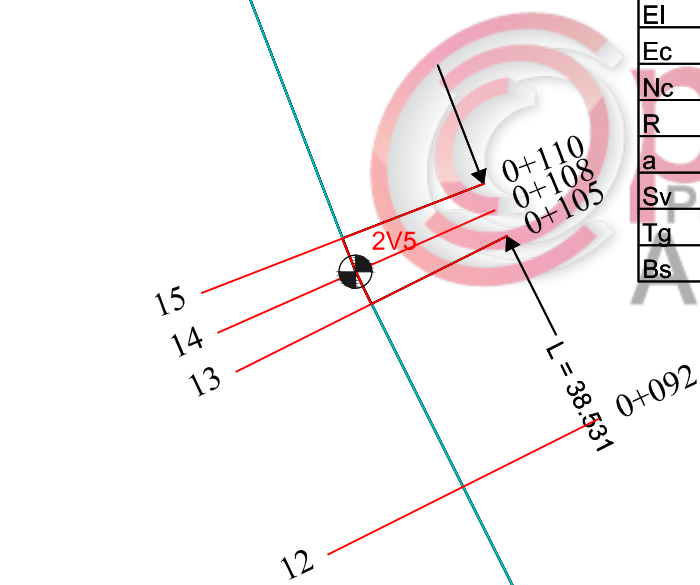

<b>2V5</b>	a = 6.03984c
E=	388947.591
N=	4583440.252
EI	<b>KURBA:2V5</b>
Ec	388993.367
Nc	4583460.504
R	50.000
a	6.03985c
Sv	4.744
Tg	2.374
Bs	0.056

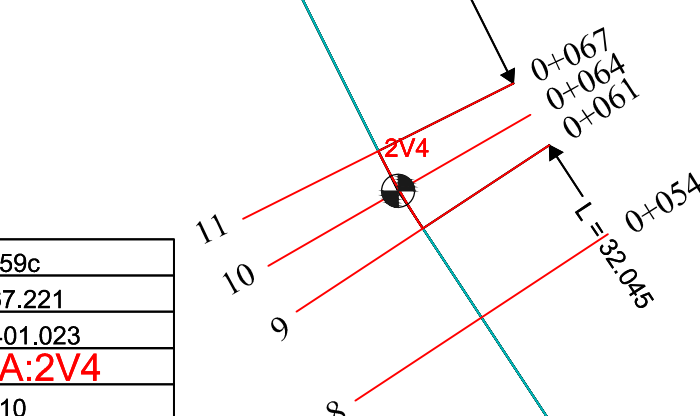

<b>2V4</b>	a = 7.53259c
E=	388967.221
N=	4583401.023
EI	<b>KURBA:2V4</b>
Ec	389010.610

<b>2V3</b>	a = -15.04806c
E=	388989.737
N=	4583366.827
EI	<b>KURBA:2V3</b>
Ec	388944.712
Nc	4583344.289
R	50.000
a	15.04806c
Sv	11.819
Tg	5.937
Bs	0.351

<b>2V2</b>	a = -11.18693c
E=	388993.687
N=	4583355.867
EI	<b>KURBA:2V2</b>



**POROSITESI : BASHKIA VORË**  
 OBJEKTI:  
 "RIKONSTRUKSION I RRUGEVE MUCAJ, SHERAJ DHE E VESLEVE FSHATI MUCAJ ,BASHKIA VORE "

Emertimi: PLANPIKETIMI I RRUGES  
  
**"ARABEL - STUDIO" Sh.p.k**  
 Adresa: Njesia Bashkiake nr.7, Rruga "Frosina Plaku", Pallati 21, Hyrja 1, Kati 2, Tirane.  
 Email: arabelstudio@gmail.com

Drejtesues i projektit  
 Adm. Ana NISHKU  
 Inxh. Ardi ARKAXHIU

Projektues  
 Nd. Ardi ARKAXHIU  
 Ark.Rigert HYRA  
 Gjeo.Irfan BEGAJ  
 Elek. Altin ALLKAJ  
 Top. Mustafa HOXHAJ  
 Hid. Hajredin MURGU

SHKALLA	FLETA
1 : 500	3- 04
Vorë 2019	Format A3

a = -10.24050c
E= 389057.053
N= 4583324.856
<b>KURBA:1V16</b>
389067.990
4583363.467
40.000
10.24049c
6.434
3.224
0.130

a	17.94922c
Sv	14.097
Tg	7.096
Bs	0.501

<b>1V19</b>	a = 25.63033c
	E= 389139.114
	N= 4583285.065
EI	<b>KURBA:1V19</b>
Ec	389115.543
Nc	4583265.523
R	30.000
a	25.63033c
Sv	12.078
Tg	6.122
Bs	0.618

<b>3V6</b>	a = 3.18389c
	E= 389274.44
	N= 4583315.3
EI	<b>KURBA:3</b>
Ec	389365.024
Nc	4583357.760
R	100.000
a	3.18391c
Sv	5.001
Tg	2.501
Bs	0.031

<b>1V21</b>	a = -7.01370c
	E= 389166.995
	N= 4583242.160
EI	<b>KURBA:1V21</b>
Ec	389241.882
Nc	4583308.661
R	100.000
a	7.01371c
Sv	11.017
Tg	5.514
Bs	0.152

<b>3V4</b>	a = -7.43224c
	E= 389279.73
	N= 4583239.6
EI	<b>KURBA:3</b>
Ec	389236.843
Nc	4583265.467
R	50.000
a	7.43224c
Sv	5.837
Tg	2.922
Bs	0.085

<b>1V20</b>	a = -11.46924c
	E= 389151.859
	N= 4583261.223
EI	<b>KURBA:1V20</b>
Ec	389193.825
Nc	4583288.777
R	50.000
a	11.46924c
Sv	9.008
Tg	4.516
Bs	0.204

<b>1V22</b>	a = 5.66092c
	E= 389177.897
	N= 4583231.167
EI	<b>KURBA:1V22</b>
Ec	389103.760
Nc	4583163.910
R	100.000
a	5.66092c
Sv	8.892
Tg	4.449
Bs	0.099

<b>1V23</b>	a = 7.10187c
	E= 389191.689
	N= 4583214.535
EI	<b>KURBA:1V23</b>
Ec	389111.148
Nc	4583155.001
R	100.000
a	7.10187c
Sv	11.156
Tg	5.584
Bs	0.156

<b>3V1</b>	<b>FILLIMI</b>
	E= 389210.536
	N= 4583189.005

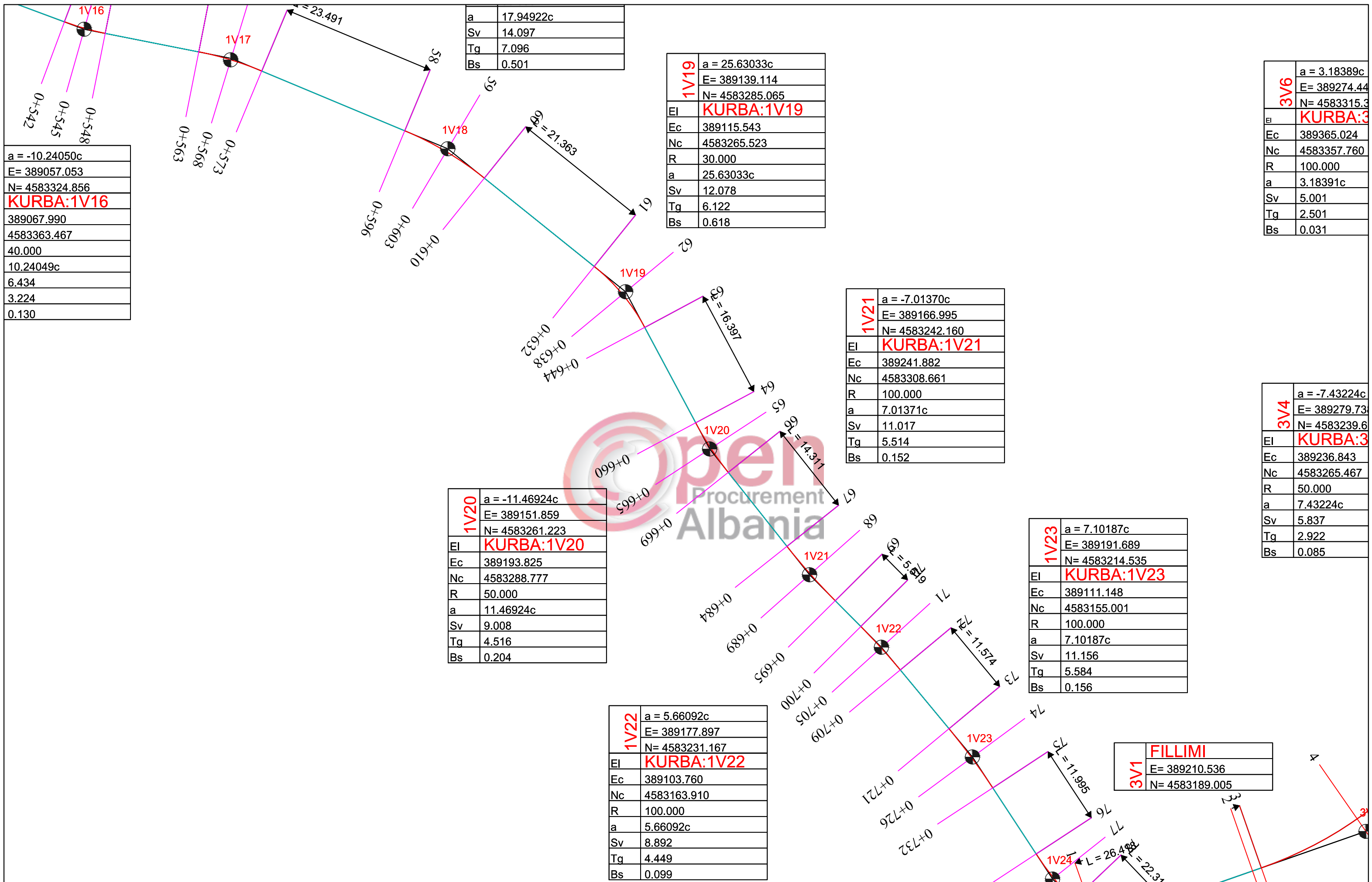

**POROSITESI : BASHKIA VORË**  
 OBJEKTI:  
 "RIKONSTRUKSION I RRUGEVE MUCAJ, SHERAJ DHE E VESLEVE FSHATI MUCAJ ,BASHKIA VORE "

Emertimi: PLANPIKETIMI I RRUGES  
**"ARABEL - STUDIO" Sh.p.k**  
 Adresa:Njesia Bashkiake nr.7, Rruga "Frosina Plaku", Pallati 21, Hyrja 1, Kati 2,Tirane.  
 Email: arabelstudio@gmail.com

Drejtesues i projektit  
 Adm. Ana NISHKU  
 Inxh. Ardi ARKAXHIU  
 Projektues  
 Nd. Ardi ARKAXHIU  
 Ark.Rigert HYRA  
 Gjeo.Irfan BEGAJ  
 Elek. Altin ALLKAJ  
 Top. Mustafa HOXHAI  
 Hid. Hajredin MURGU

SHKALLA  
 1 : 500  
 VORË 2019  
 FLETA  
 3- 05  
 Format A3

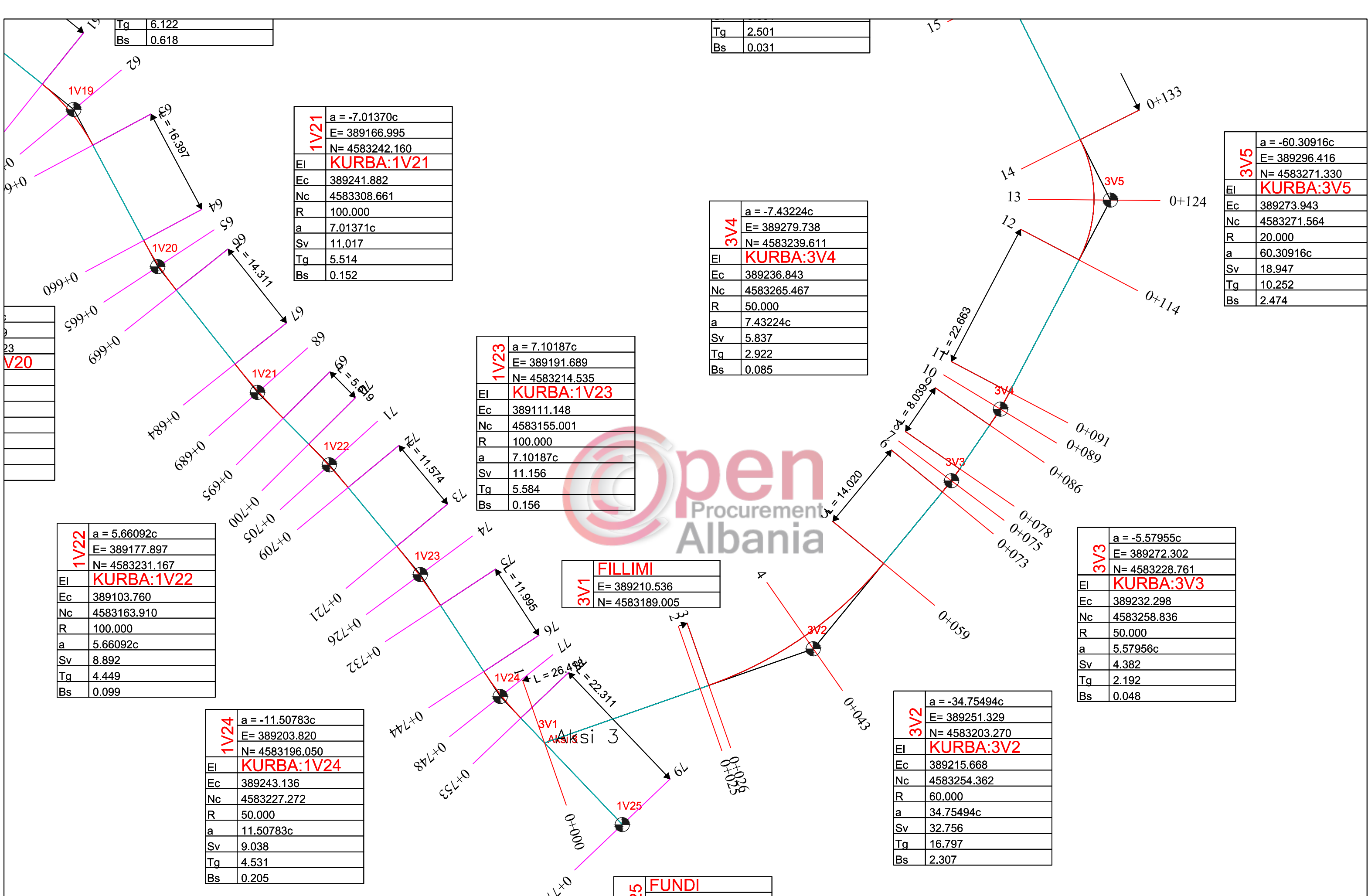

Tg	6.122
Bs	0.618

Tg	2.501
Bs	0.031

<b>1V21</b>	a = -7.01370c
	E= 389166.995
	N= 4583242.160
EI	<b>KURBA:1V21</b>
Ec	389241.882
Nc	4583308.661
R	100.000
a	7.01371c
Sv	11.017
Tg	5.514
Bs	0.152

<b>3V4</b>	a = -7.43224c
	E= 389279.738
	N= 4583239.611
EI	<b>KURBA:3V4</b>
Ec	389236.843
Nc	4583265.467
R	50.000
a	7.43224c
Sv	5.837
Tg	2.922
Bs	0.085

<b>3V5</b>	a = -60.30916c
	E= 389296.416
	N= 4583271.330
EI	<b>KURBA:3V5</b>
Ec	389273.943
Nc	4583271.564
R	20.000
a	60.30916c
Sv	18.947
Tg	10.252
Bs	2.474

<b>1V23</b>	a = 7.10187c
	E= 389191.689
	N= 4583214.535
EI	<b>KURBA:1V23</b>
Ec	389111.148
Nc	4583155.001
R	100.000
a	7.10187c
Sv	11.156
Tg	5.584
Bs	0.156

<b>3V1</b>	<b>FILLIMI</b>
	E= 389210.536
	N= 4583189.005

<b>1V22</b>	a = 5.66092c
	E= 389177.897
	N= 4583231.167
EI	<b>KURBA:1V22</b>
Ec	389103.760
Nc	4583163.910
R	100.000
a	5.66092c
Sv	8.892
Tg	4.449
Bs	0.099

<b>3V3</b>	a = -5.57955c
	E= 389272.302
	N= 4583228.761
EI	<b>KURBA:3V3</b>
Ec	389232.298
Nc	4583258.836
R	50.000
a	5.57956c
Sv	4.382
Tg	2.192
Bs	0.048

<b>1V24</b>	a = -11.50783c
	E= 389203.820
	N= 4583196.050
EI	<b>KURBA:1V24</b>
Ec	389243.136
Nc	4583227.272
R	50.000
a	11.50783c
Sv	9.038
Tg	4.531
Bs	0.205

<b>3V2</b>	a = -34.75494c
	E= 389251.329
	N= 4583203.270
EI	<b>KURBA:3V2</b>
Ec	389215.668
Nc	4583254.362
R	60.000
a	34.75494c
Sv	32.756
Tg	16.797
Bs	2.307

**25 FUNDI**



**POROSITESI : BASHKIA VORË**  
 OBJEKTI:  
 "RIKONSTRUKSION I RRUGEVE MUCAJ,SHERAJ DHE E VESLEVE FSHATI MUCAJ ,BASHKIA VORE "



Emertimi: PLANPIKETIMI I RRUGES  
**"ARABEL - STUDIO" Sh.p.k**  
 Adresa:Njesia Bashkiake nr.7, Rruga "Frosina Plaku", Pallati 21, Hyrja 1, Kati 2,Tirane.  
 Email: arabelstudio@gmail.com

Drejtes i projektit  
 Adm. Ana NISHKU  
 Inxh. Ardi ARKAXHIU

Projektues  
 Nd. Ardi ARKAXHIU  
 Ark.Rigert HYRA  
 Gjeo.Irfan BEGAJ  
 Elek. Altin ALLKAJ  
 Top. Mustafa HOXHAI  
 Hid. Hajredin MURGU

SHKALLA  
 1 : 500  
 VORË 2019

FLETA  
 3- 06  
 Format A3

<b>3V9</b>	<b>FUNDI</b>
E=	389230.559
N=	4583412.380

<b>3V8</b>	a = -22.11216c
E=	389245.101
N=	4583390.447
EI	<b>KURBA:3V8</b>
Ec	389198.581
Nc	4583370.128
R	50.000
a	22.11216c
Sv	17.367
Tg	8.772
Bs	0.764

<b>3V7</b>	a = 11.14771c
E=	389249.566
N=	4583372.053
EI	<b>KURBA:3V7</b>
Ec	389297.120
Nc	4583388.113
R	50.000
a	11.14771c
Sv	8.755
Tg	4.389
Bs	0.192

<b>3V6</b>	a = 3.18389c
E=	389274.447
N=	4583315.311
EI	<b>KURBA:3V6</b>
Ec	389365.024
Nc	4583357.760
R	100.000
a	3.18391c
Sv	5.001
Tg	2.501
Bs	0.031

<b>1V19</b>	a = 25.63033c
E=	389139.114
N=	4583285.065
EI	<b>KURBA:1V19</b>
Ec	389115.543
Nc	4583265.523
R	30.000
a	25.63033c
Sv	12.078
Tg	6.122
Bs	0.618

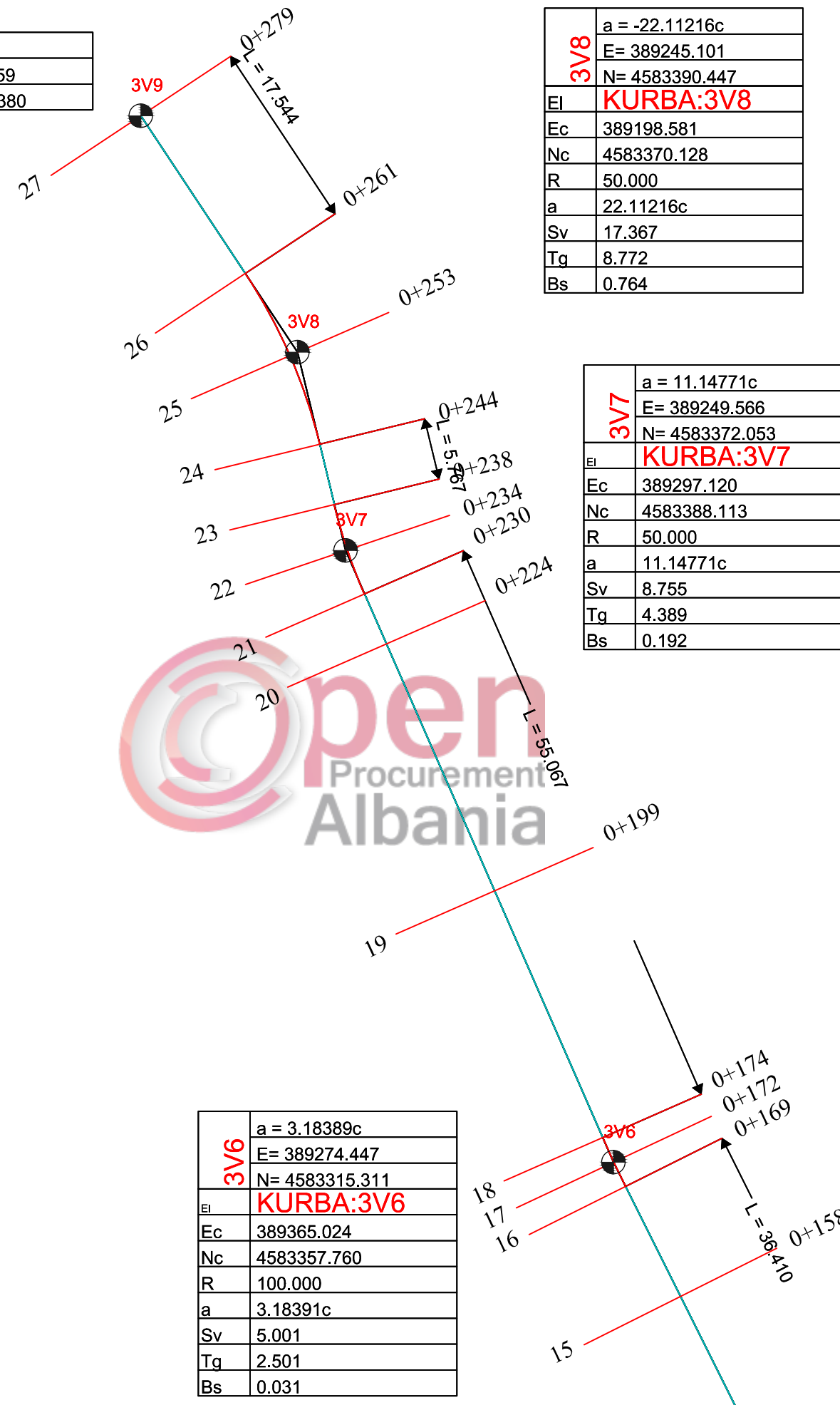

## POROSITESI : BASHKIA VORË

OBJEKTI:  
"RIKONSTRUKSION I RRUGEVE MUCAJ, SHERAJ DHE E VESLEVE  
FSHATI MUCAJ , BASHKIA VORE "



Emertimi: PLANPIKETIMI I RRUGES

"ARABEL - STUDIO" Sh.p.k  
Adresa: Njesia Bashkiake nr.7, Rruga "Frosina Plaku",  
Pallati 21, Hyrja 1, Kati 2, Tirane.  
Email: arabelstudio@gmail.com

Drejtues i projektit

Adm. Ana NISHKU  
Inxh. Ardi ARKAXHIU

Projektues

Nd. Ardi ARKAXHIU  
Ark.Rigert HYRA  
Gjeo.Irfan BEGAJ  
Elek. Altin ALLKAJ  
Top. Mustafa HOXHAJ  
Hid. Hajredin MURGU

SHKALLA FLETA

1 : 500 3- 07  
Vorë 2019 Format A3

# PROJEKT ZBATIMI

## OBJEKTI:

"RIKONSTRUKSION I RRUGEVE MUCAJ, SHERAJ DHE E VESLEVE  
FSHATI MUCAJ , BASHKIA VORE "

4. PLANIMETRIA E PRISHJEVE DHE SPOSTIMI I  
LINJAVE T.U



**POROSITESI : BASHKIA VORË**

OBJEKTI:  
"RIKONSTRUKSION I RRUGEVE MUCAJ, SHERAJ DHE E VESLEVE  
FSHATI MUCAJ , BASHKIA VORE "

Emertimi: 4.PLANIMETRIA E PRISHJEVE DHE SPOSTIMI I LINJAVE T.U



"ARABEL - STUDIO" Sh.p.k  
Adresa: Njesia Bashkiake nr.7, Rruga "Frosina Plaku",  
Pallati 21, Hyrja 1, Kati 2, Tirane.  
Email: arabelstudio@gmail.com

Drejtues i projektit

Adm. Ana NISHKU

Inxh. Ardi ARKAXHIU

Projektues

Nd. Ardi ARKAXHIU

Ark.Rigert HYRA

Gjeo.Irfan BEGAJ

Elek. Altin ALLKAJ

Top. Mustafa HOXHAJ

Hid. Hajredin MURGU

SHKALLA

1 : 500

Vorë 2019

FLETA

4-

Format A3

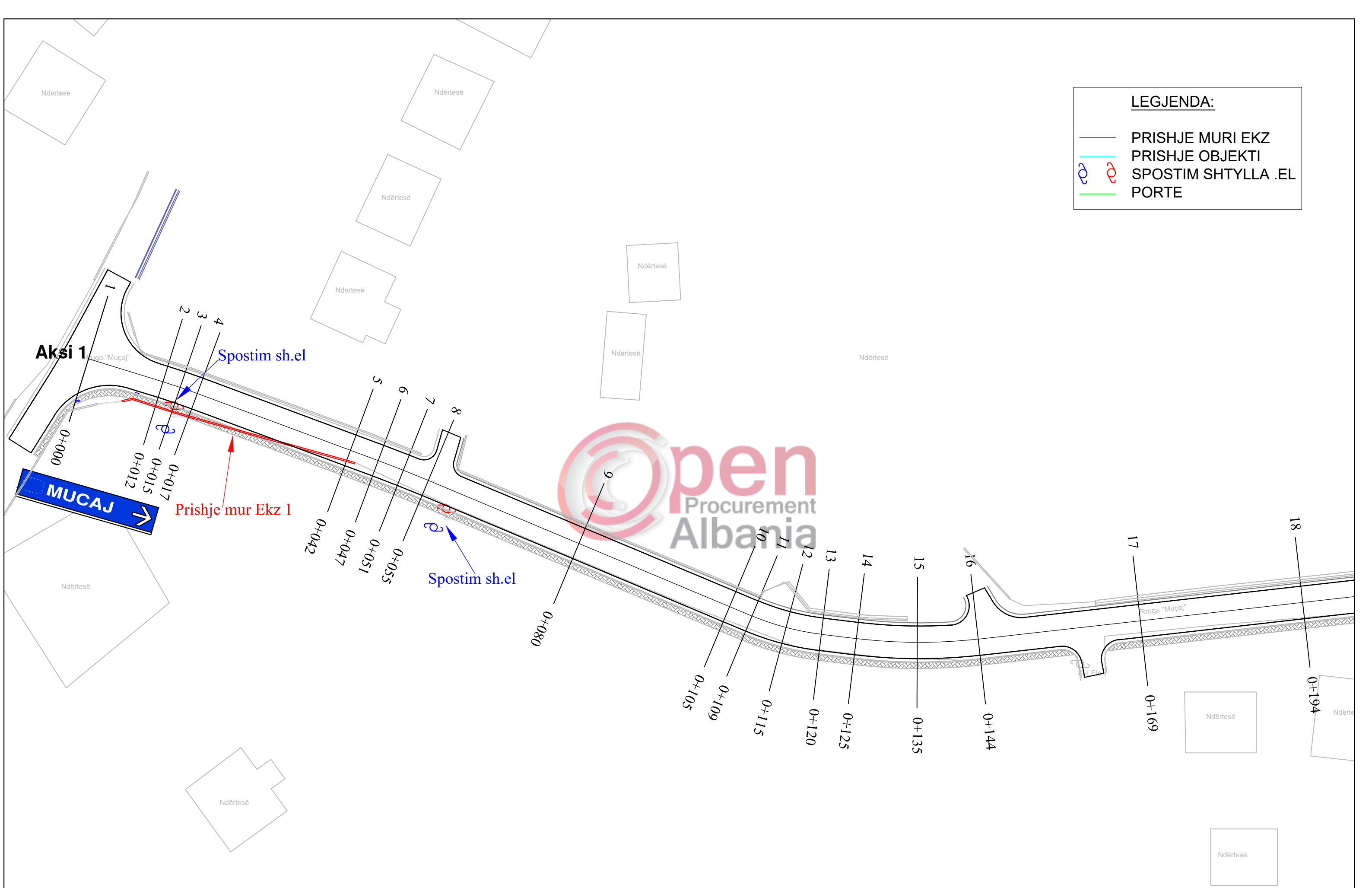

**LEGJENDA:**

	PRISHJE MURI EKZ
	PRISHJE OBJEKTI
	SPOSTIM SHTYLLA .EL
	PORTE



**POROSITESI : BASHKIA VORË**

OBJEKTI:  
"RIKONSTRUKSION I RRUGEVE MUCAJ, SHERAJ DHE E VESLEVE  
FSHATI MUCAJ ,BASHKIA VORE "

Emertimi: 4.PLANIMETRIA E PRISHJEVE DHE SPOSTIMI I LINJAVE T.U



**"ARABEL - STUDIO" Sh.p.k**  
Adresa:Njesia Bashkiake nr.7, Rruga "Frosina Plaku",  
Pallati 21, Hyrja 1, Kati 2,Tirane.  
Email: arabelstudio@gmail.com

**Drejtesues i projektit**

Adm. Ana NISHKU  
Inxh. Ardi ARKAXHIU

**Projektues**

Nd. Ardi ARKAXHIU	Elek. Altin ALLKAJ
Ark.Rigert HYRA	Top. Mustafa HOXHAJ
Gjeo.Irfan BEGAJ	Hid. Hajredin MURGU

**SHKALLA**

1 : 500

Vorë 2019

**FLETA**

4- 01

Format A3

**LEGJENDA:**

- PRISHJE MURI EKZ
- PRISHJE OBJEKTI
- — SPOSTIM SHTYLLA .EL
- PORTE

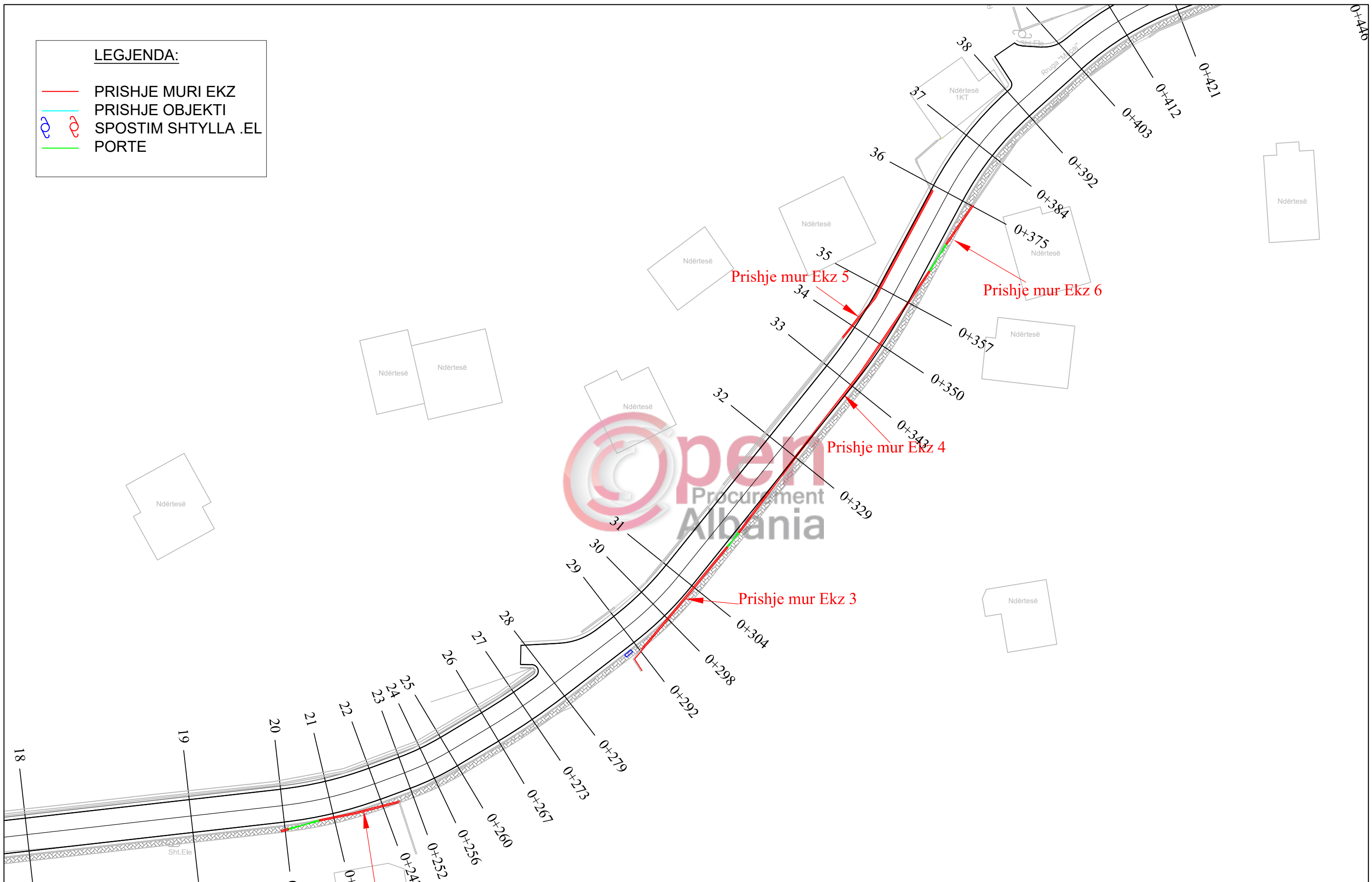

**POROSITESI : BASHKIA VORË**  
 OBJEKTI:  
 "RIKONSTRUKSION I RRUGEVE MUCAJ,SHERAJ DHE E VESLEVE  
 FSHATI MUCAJ ,BASHKIA VORE "

Emertimi: 4.PLANIMETRIA E PRISHJEVE DHE SPOSTIMI I LINJAVE T.U  
 **"ARABEL - STUDIO" Sh.p.k**  
 Adresa:Njesia Bashkiake nr.7, Rruga "Frosina Plaku",  
 Pallati 21, Hyrja 1, Kati 2,Tirane.  
 Email: arabelstudio@gmail.com

**Drejtesues i projektit**  
 Adm. Ana NISHKU  
 Inxh. Ardi ARKAXHIU

**Projektues**

Nd. Ardi ARKAXHIU	Elek. Altin ALLKAJ
Ark.Rigert HYRA	Top. Mustafa HOXHAI
Gjeo.Irfan BEGAJ	Hid. Hajredin MURGU

<b>SHKALLA</b>	<b>FLETA</b>
1 : 500	4- 02
Vorë 2019	Format A3

**LEGJENDA:**

- PRISHJE MURI EKZ
- PRISHJE OBJEKTI
- ↻ SPOSTIM SHTYLLA .EL
- PORTE

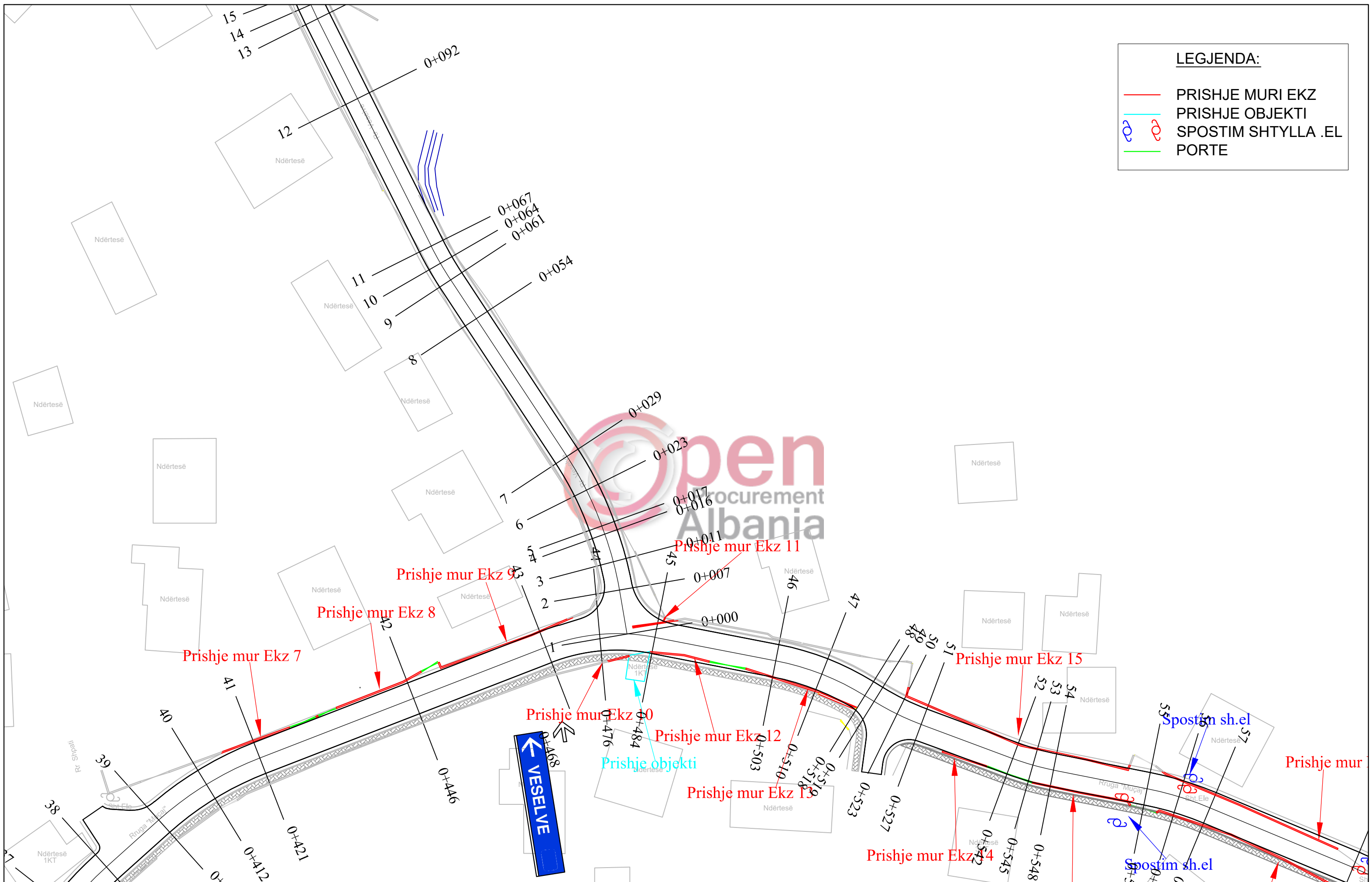

**POROSITESI : BASHKIA VORË**  
 OBJEKTI:  
 "RIKONSTRUKSION I RRUGEVE MUCAJ, SHERAJ DHE E VESLEVE  
 FSHATI MUCAJ ,BASHKIA VORE "

Emertimi: 4.PLANIMETRIA E PRISHJEVE DHE SPOSTIMI I LINJAVE T.U  
 **"ARABEL - STUDIO" Sh.p.k**  
 Adresa: Njesia Bashkiake nr.7, Rruga "Frosina Plaku",  
 Pallati 21, Hyrja 1, Kati 2, Tirane.  
 Email: arabelstudio@gmail.com

**Drejtesues i projektit**  
 Adm. Ana NISHKU  
 Inxh. Ardi ARKAXHIU

**Projektues**

Nd. Ardi ARKAXHIU	Elek. Altin ALLKAJ
Ark.Rigert HYRA	Top. Mustafa HOXHAJ
Gjeo.Irfan BEGAJ	Hid. Hajredin MURGU

<b>SHKALLA</b>	<b>FLETA</b>
1 : 500	4- 03
Vorë 2019	Format A3



**LEGJENDA:**

- PRISHJE MURI EKZ
- PRISHJE OBJEKTI
- ⌒ ⌒ SPOSTIM SHTYLLA .EL
- PORTE

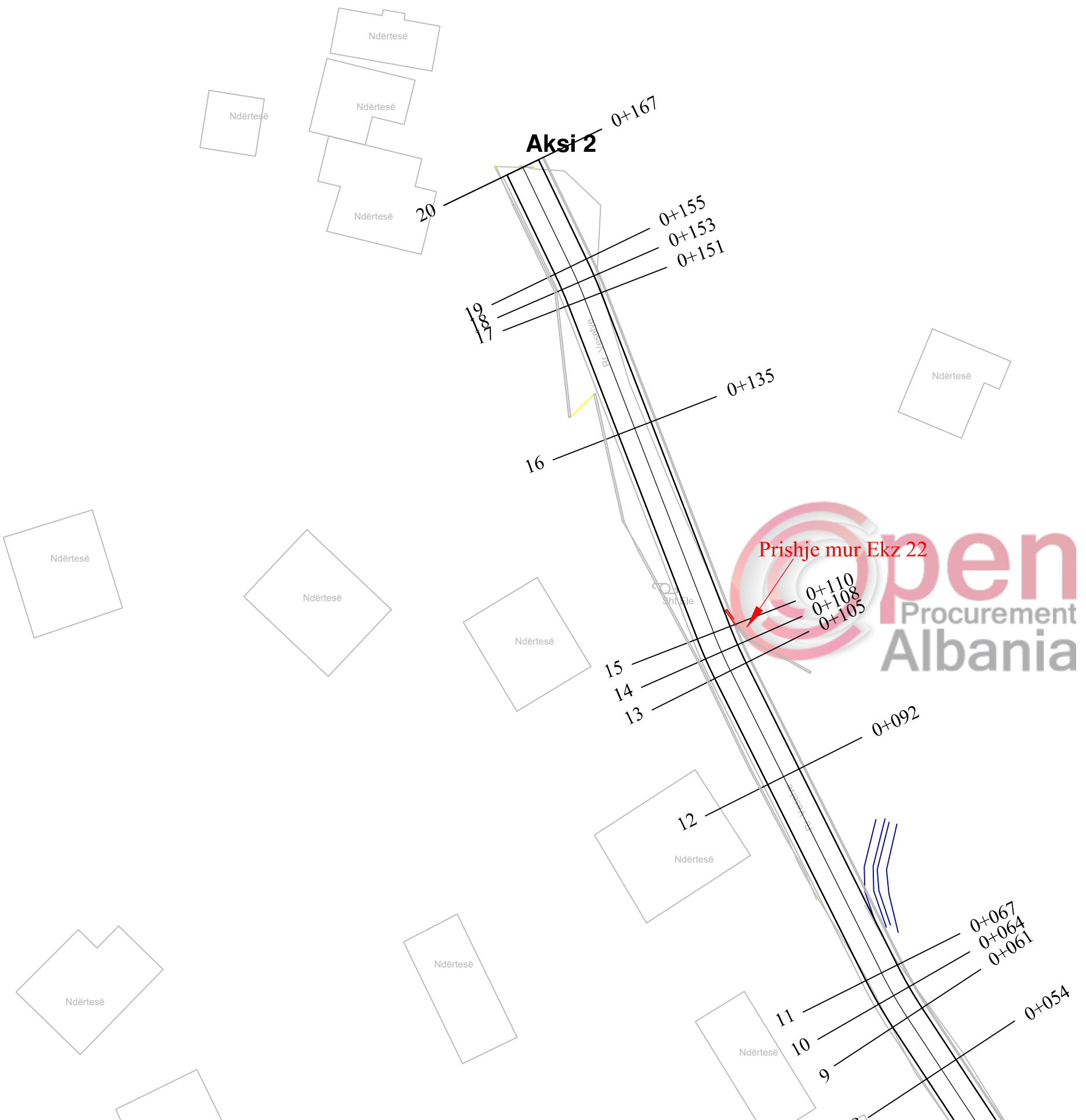

**POROSITESI : BASHKIA VORË**  
 OBJEKTI:  
 "RIKONSTRUKSION I RRUGEVE MUCAJ,SHERAJ DHE E VESLEVE  
 FSHATI MUCAJ ,BASHKIA VORE "

Emertimi: 4.PLANIMETRIA E PRISHJEVE DHE SPOSTIMI I LINJAVE T.U  
 **"ARABEL - STUDIO" Sh.p.k**  
 Adresa:Njesia Bashkiake nr.7, Rruga "Frosina Plaku",  
 Pallati 21, Hyrja 1, Kati 2,Tirane.  
 Email: arabelstudio@gmail.com

**Drejtues i projektit**  
 Adm. Ana NISHKU  
 Inxh. Ardi ARKAXHIU

**Projektues**

Nd. Ardi ARKAXHIU	Elek. Altin ALLKAJ
Ark.Rigert HYRA	Top. Mustafa HOXHAI
Gjeo.Irfan BEGAJ	Hid. Hajredin MURGU

<b>SHKALLA</b>	<b>FLETA</b>
1 : 500	4- 05
Vorë 2019	Format A3

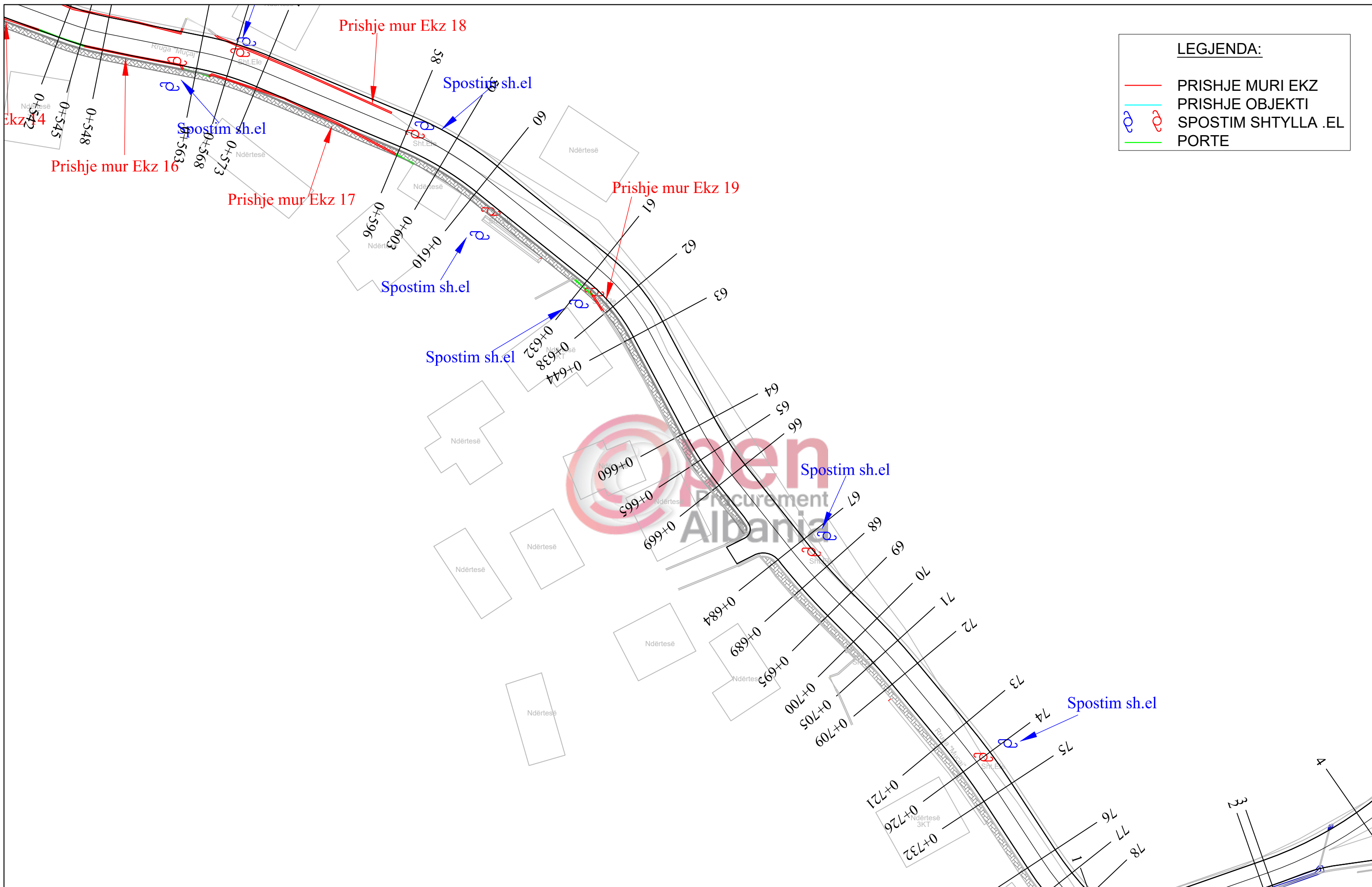

**LEGJENDA:**

<span style="color: red;">—</span>	PRISHJE MURI EKZ
<span style="color: cyan;">—</span>	PRISHJE OBJEKTI
<span style="color: blue;">↔</span> <span style="color: red;">↔</span>	SPOSTIM SHTYLLA .EL
<span style="color: green;">—</span>	PORTE



**POROSITESI : BASHKIA VORË**

OBJEKTI:  
 "RIKONSTRUKSION I RRUGEVE MUCAJ, SHERAJ DHE E VESLEVE  
 FSHATI MUCAJ ,BASHKIA VORE "

Emertimi: 4.PLANIMETRIA E PRISHJEVE DHE SPOSTIMI I LINJAVE T.U

**"ARABEL - STUDIO" Sh.p.k**  
 Adresa:Njesia Bashkiake nr.7, Rruga "Frosina Plaku",  
 Pallati 21, Hyrja 1, Kati 2,Tirane.  
 Email: arabelstudio@gmail.com

**Drejtesues i projektit**

Adm. Ana NISHKU  
 Inxh. Ardi ARKAXHIU

**Projektues**

Nd. Ardi ARKAXHIU	Elek. Altin ALLKAJ
Ark.Rigert HYRA	Top. Mustafa HOXHAI
Gjeo.Irfan BEGAJ	Hid. Hajredin MURGU

<b>SHKALLA</b>	<b>FLETA</b>
1 : 500	4- 05
Vorë 2019	Format A3



**LEGJENDA:**

	PRISHJE MURI EKZ
	PRISHJE OBJEKTI
	SPOSTIM SHTYLLA .EL
	PORTE



**POROSITESI : BASHKIA VORË**

OBJEKTI:  
"RIKONSTRUKSION I RRUGEVE MUCAJ,SHERAJ DHE E VESLEVE  
FSHATI MUCAJ ,BASHKIA VORE "

Emertimi: 4.PLANIMETRIA E PRISHJEVE DHE SPOSTIMI I LINJAVE T.U



**"ARABEL - STUDIO" Sh.p.k**  
Adresa:Njesia Bashkiake nr.7, Rruga "Frosina Plaku",  
Pallati 21, Hyrja 1, Kati 2,Tirane.  
Email: arabelstudio@gmail.com

**Drejtesues i projektit**

Adm. Ana NISHKU  
Inxh. Ardi ARKAXHIU

**Projektues**

Nd. Ardi ARKAXHIU	Elek. Altin ALLKAJ
Ark.Rigert HYRA	Top. Mustafa HOXHAI
Gjeo.Irfan BEGAJ	Hid. Hajredin MURGU

**SHKALLA**

1 : 500  
Vorë 2019

**FLETA**

4- 06  
Format A3

# PROJEKT ZBATIMI

## OBJEKTI:

"RIKONSTRUKSION I RRUGEVE MUCAJ,SHERAJ DHE E VESLEVE  
FSHATI MUCAJ ,BASHKIA VORE "

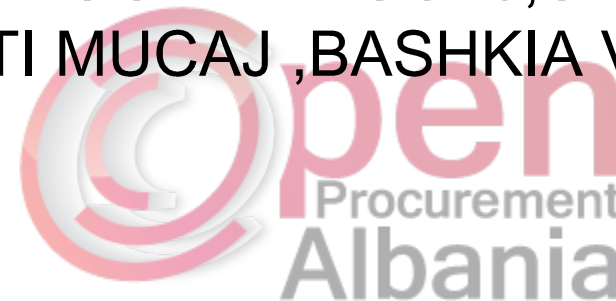

5.PLANIMETRIA E PERGJITHSHME E RRUGES



**POROSITESI : BASHKIA VORË**

OBJEKTI:  
"RIKONSTRUKSION I RRUGEVE MUCAJ,SHERAJ DHE E VESLEVE  
FSHATI MUCAJ ,BASHKIA VORE "



Emertimi: PLANIMETRIA E PERGJITHSHME

"ARABEL - STUDIO" Sh.p.k  
Adresa:Njesia Bashkiake nr.7, Rruga "Frosina Plaku",  
Pallati 21, Hyrja 1, Kati 2,Tirane.  
Email: arabelstudio@gmail.com

Drejtues i projektit

Adm. Ana NISHKU  
Inxh. Ardi ARKAXHIU

Projektues

Nd. Ardi ARKAXHIU  
Ark.Rigert HYRA  
Gjeo.Irfan BEGAJ  
Elek. Altin ALLKAJ  
Top. Mustafa HOXHAJ  
Hid. Hajredin MURGU

SHKALLA FLETA

1 : 500

5-

Vorë 2019 Format A3

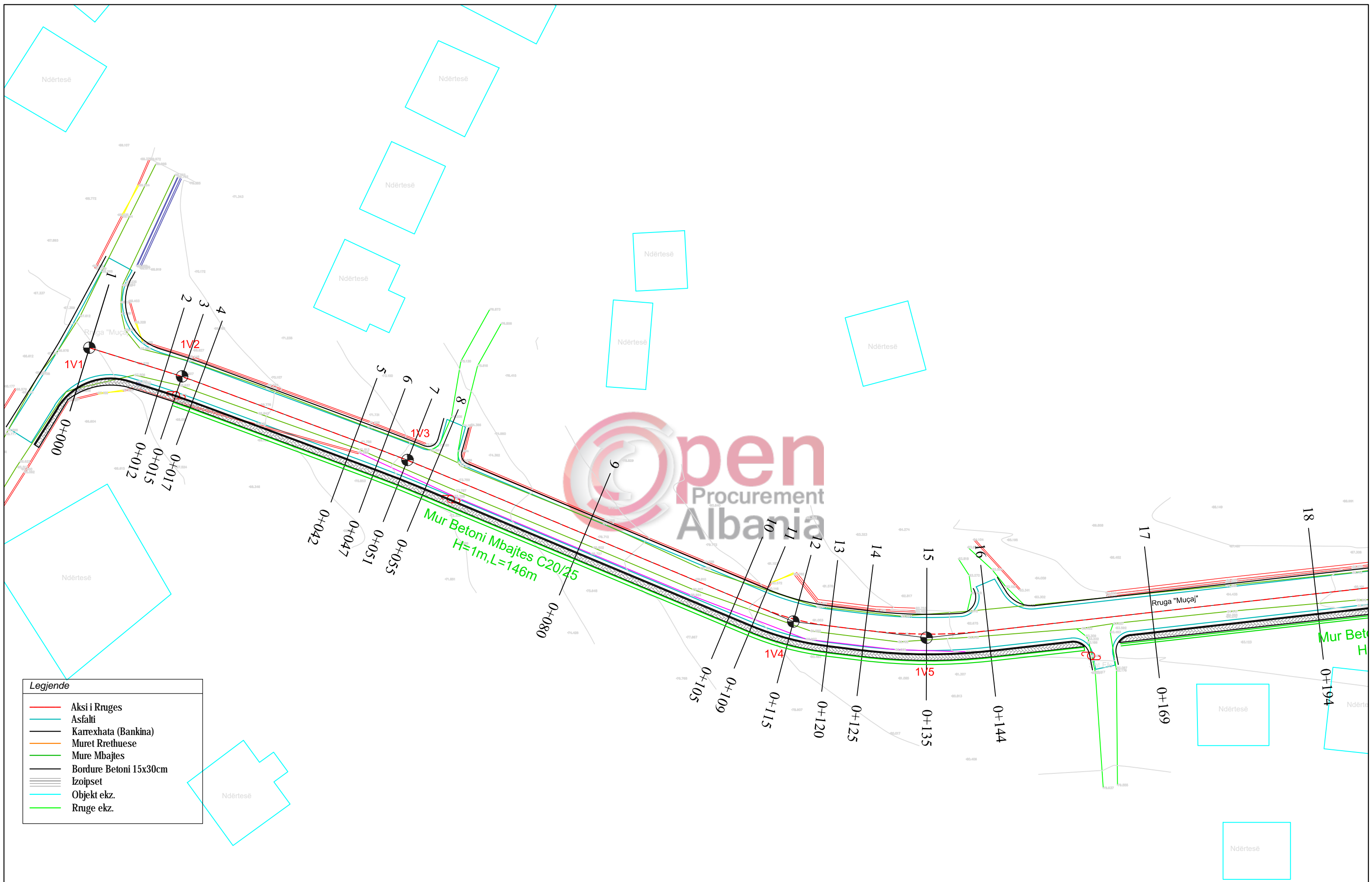

**Legjende**

	Aksi i Rruges
	Asfalti
	Karrexhata (Bankina)
	Muret Rrethuese
	Mure Mbajtes
	Bordure Betoni 15x30cm
	Izoipset
	Objekt ekz.
	Rruge ekz.

**POROSITESI : BASHKIA VORË**

OBJEKTI:  
"RIKONSTRUKSION I RRUGEVE MUCAJ, SHERAJ DHE E VESLEVE FSHATI MUCAJ ,BASHKIA VORE "

Emertimi: PLANIMETRIA E PERGJITHSHME

**"ARABEL - STUDIO" Sh.p.k**  
Adresa: Njesia Bashkiake nr.7, Rruga "Frosina Plaku", Pallati 21, Hyrja 1, Kati 2, Tirane.  
Email: arabelstudio@gmail.com

Drejtesues i projektit

Adm. Ana NISHKU
Inxh. Ardi ARKAXHIU

Projektues

Nd. Ardi ARKAXHIU	Elek. Altin ALLKAJ
Ark.Rigert HYRA	Top. Mustafa HOXHAI
Gjeo.Irfan BEGAJ	Hid. Hajredin MURGU

SHKALLA	FLETA
1 : 500	5- 01
Vorë 2019	Format A3

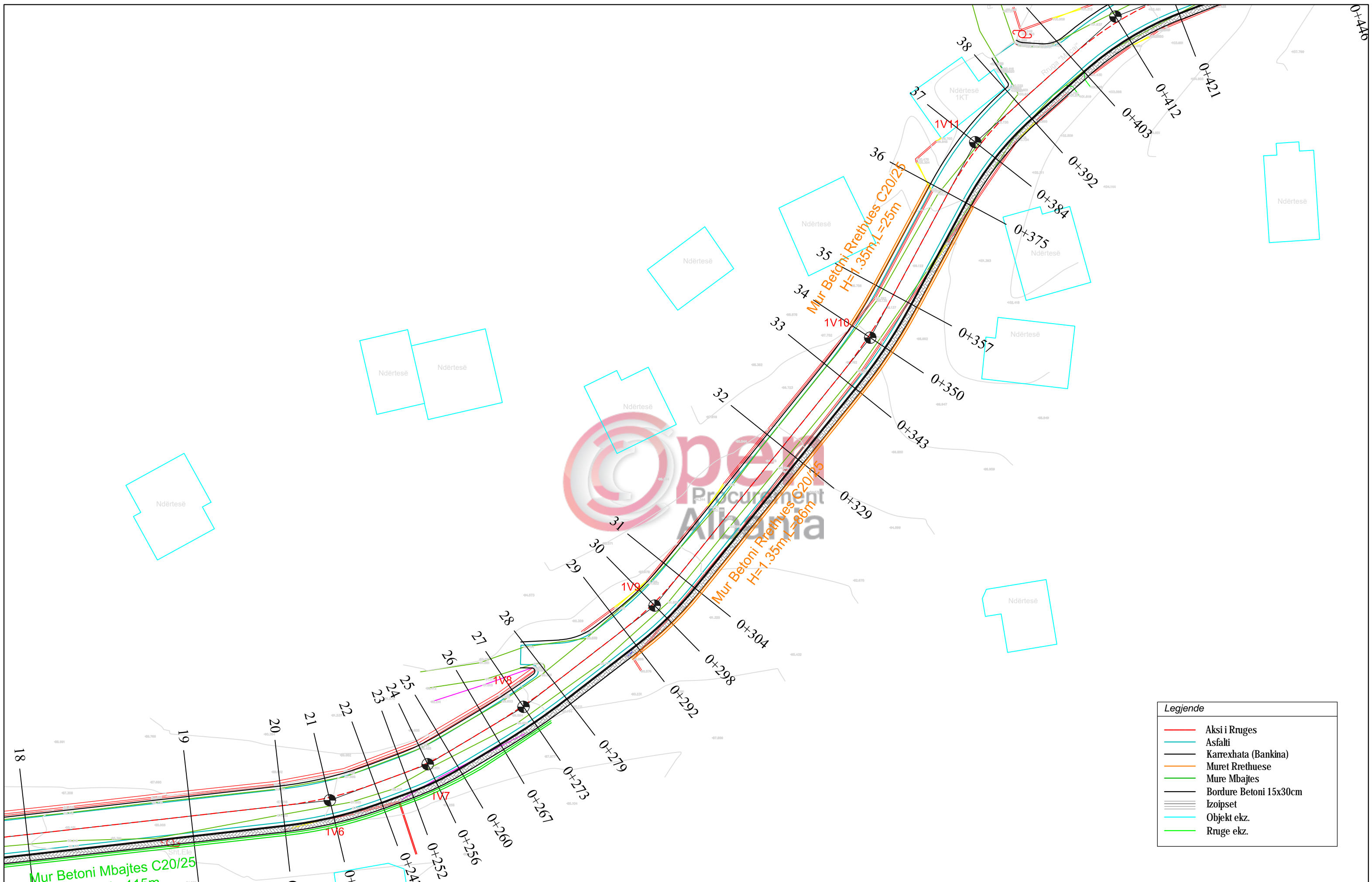

Legjende	
	Aksi i Rruges
	Asfalti
	Karrexhata (Bankina)
	Muret Rrethuese
	Muret Mbajtes
	Bordure Betoni 15x30cm
	Izoipset
	Objekt ekz.
	Rruge ekz.



**POROSITESI : BASHKIA VORË**

OBJEKTI:  
"RIKONSTRUKSION I RRUGEVE MUCAJ, SHERAJ DHE E VESLEVE FSHATI MUCAJ ,BASHKIA VORE "

Emertimi: PLANIMETRIA E PERGJITHSHME

**"ARABEL - STUDIO" Sh.p.k**  
Adresa: Njesia Bashkiake nr.7, Rruga "Frosina Plaku", Pallati 21, Hyrja 1, Kati 2, Tirane.  
Email: arabelstudio@gmail.com

Drejtesues i projektit

Adm. Ana NISHKU  
Inxh. Ardi ARKAXHIU

Projektues

Nd. Ardi ARKAXHIU	Elek. Altin ALLKAJ
Ark.Rigert HYRA	Top. Mustafa HOXHAI
Gjeo.Irfan BEGAJ	Hid. Hajredin MURGU

SHKALLA	FLETA
1 : 500	5- 02
Vorë 2019	Format A3

Legjende	
	Aksi i Rruges
	Asfalti
	Karrexhata (Bankina)
	Muret Rrethuese
	Mure Mbajtes
	Bordure Betoni 15x30cm
	Izoipset
	Objekt ekz.
	Rruge ekz.

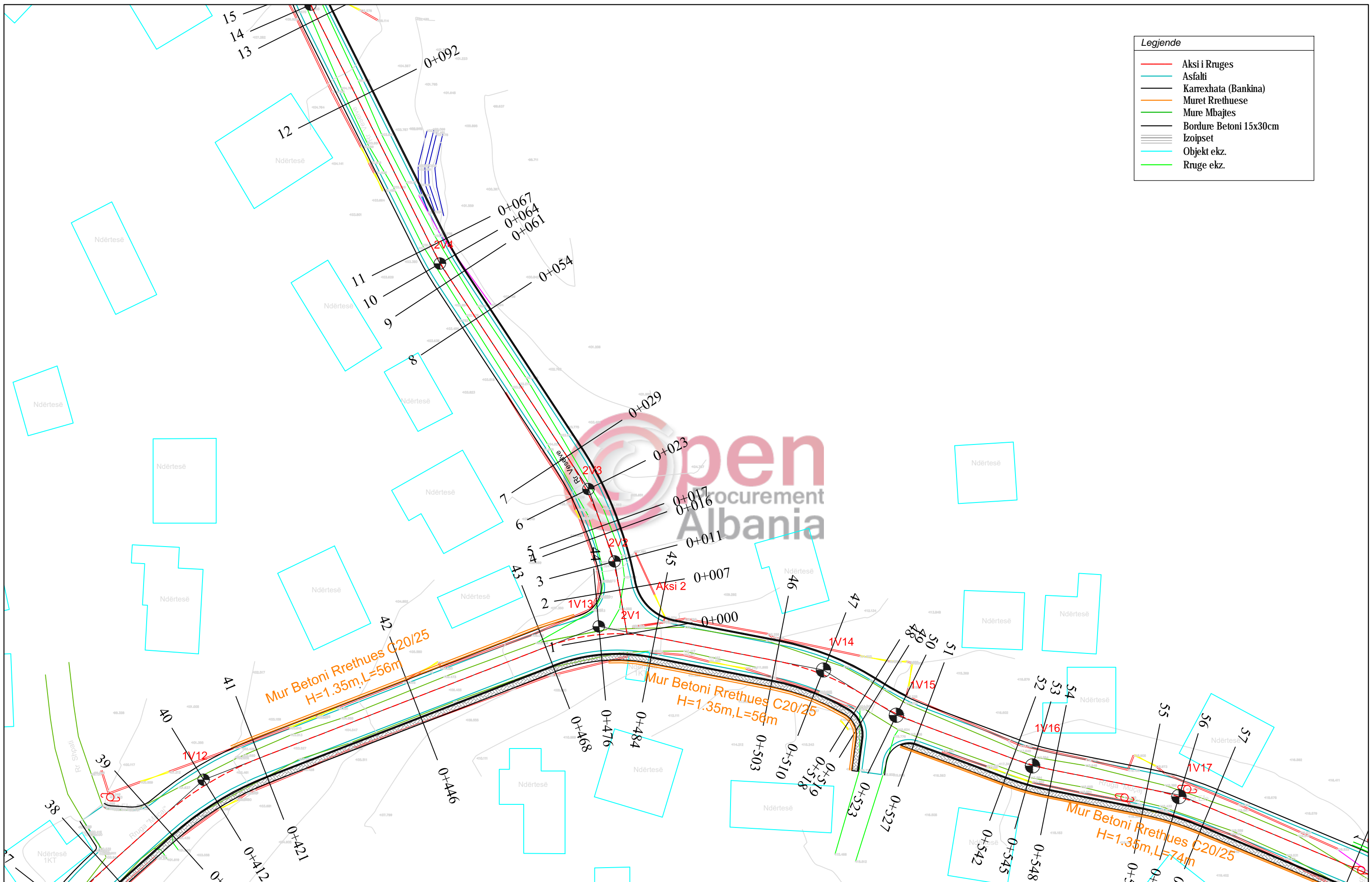

**POROSITESI : BASHKIA VORË**

OBJEKTI:  
"RIKONSTRUKSION I RRUGEVE MUCAJ, SHERAJ DHE E VESLEVE FSHATI MUCAJ ,BASHKIA VORE "

Emertimi: PLANIMETRIA E PERGJITHSHME

**"ARABEL - STUDIO" Sh.p.k**

Adresa: Njesia Bashkiake nr.7, Rruga "Frosina Plaku", Pallati 21, Hyrja 1, Kati 2, Tirane.  
Email: arabelstudio@gmail.com

Drejtesues i projektit

Adm. Ana NISHKU

Inxh. Ardi ARKAXHIU

Projektues

Nd. Ardi ARKAXHIU	Elek. Altin ALLKAJ
Ark.Rigert HYRA	Top. Mustafa HOXHAI
Gjeo.Irfan BEGAJ	Hid. Hajredin MURGU

SHKALLA	FLETA
1 : 500	5- 03
Vorë 2019	Format A3

Legjende	
	Aksi i Rruges
	Asfalti
	Karrexhata (Bankina)
	Muret Rrethuese
	Mure Mbajtes
	Bordure Betoni 15x30cm
	Izoipset
	Objekt ekz.
	Rruge ekz.

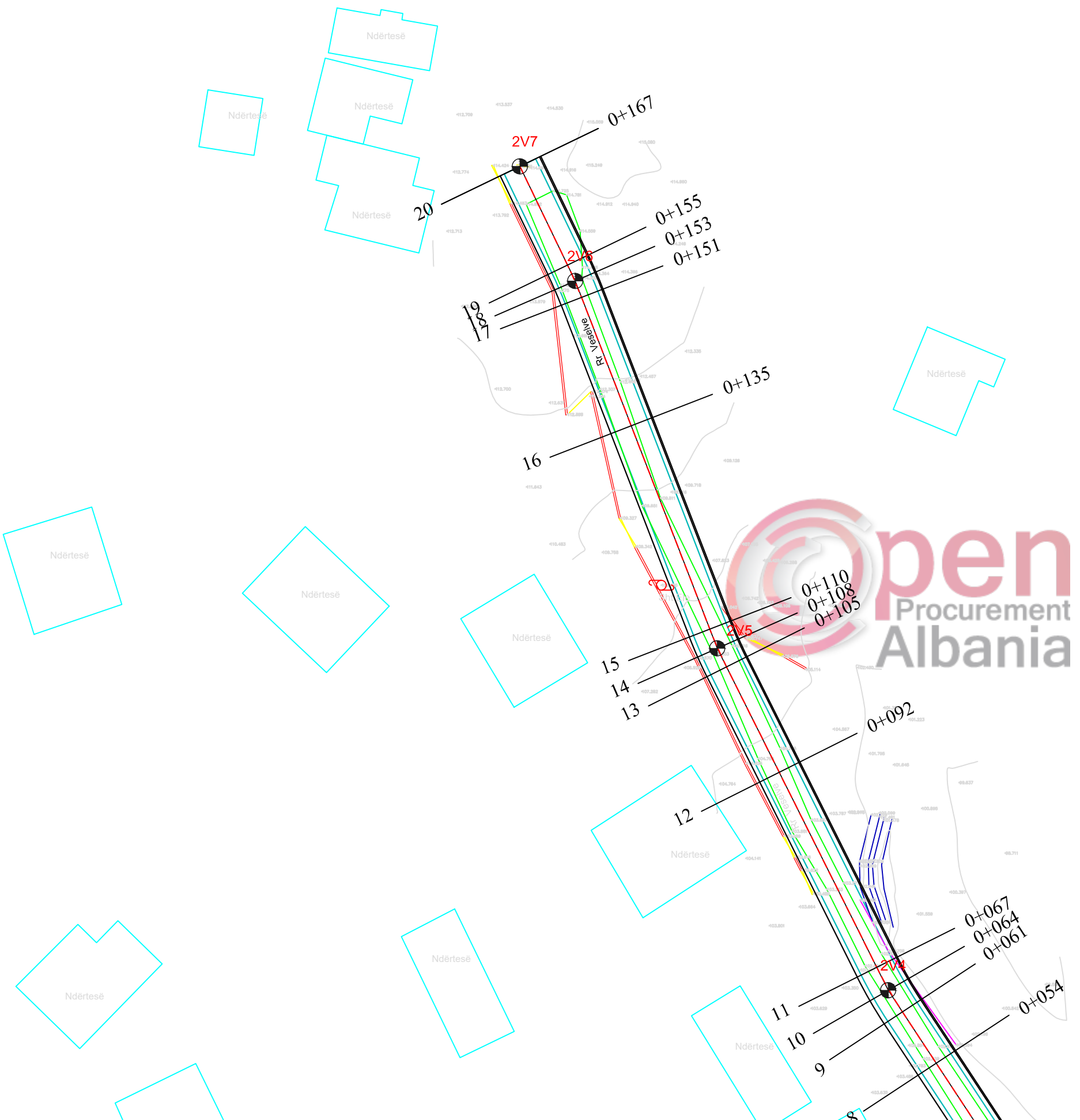

**POROSITESI : BASHKIA VORË**  
 OBJEKTI:  
 "RIKONSTRUKSION I RRUGEVE MUCAJ, SHERAJ DHE E VESLEVE  
 FSHATI MUCAJ ,BASHKIA VORE "

Emertimi: PLANIMETRIA E PERGJITHSHME  
 "ARABEL - STUDIO" Sh.p.k  
 Adresa:Njesia Bashkiake nr.7, Rruga "Frosina Plaku",  
 Pallati 21, Hyrja 1, Kati 2,Tirane.  
 Email: arabelstudio@gmail.com

Drejtesues i projektit  
 Adm. Ana NISHKU  
 Inxh. Ardi ARKAXHIU

Projektues  
 Nd. Ardi ARKAXHIU  
 Ark.Rigert HYRA  
 Gjeo.Irfan BEGAJ  
 Elek. Altin ALLKAJ  
 Top. Mustafa HOXHAJ  
 Hid. Hajredin MURGU

SHKALLA	FLETA
1 : 500	5- 04
Vorë 2019	Format A3



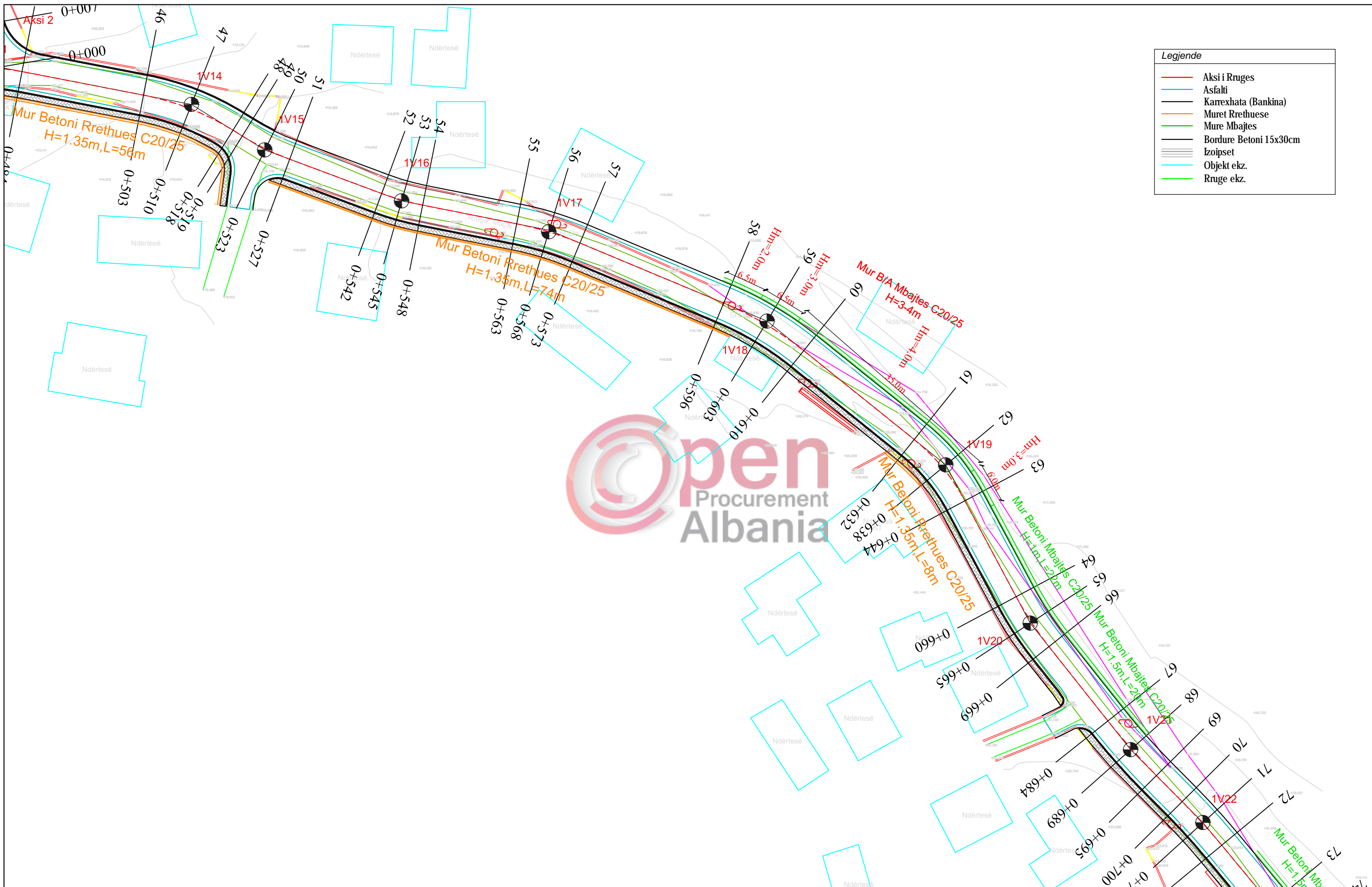

Legjende	
	Aksi i Rruges
	Asfalti
	Karrexhata (Bankina)
	Muret Rrethuese
	Mure Mbijtes
	Bordure Betoni 15x30cm
	Izoipset
	Objekt ekz.
	Rruge ekz.

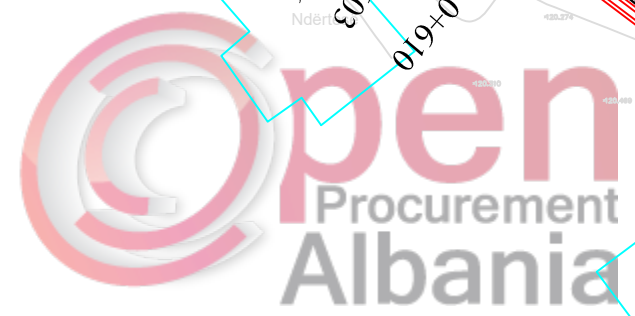

**POROSITESI : BASHKIA VORË**

OBJEKTI:  
"RIKONSTRUKSION I RRUGEVE MUCAJ, SHERAJ DHE E VESLEVE  
FSHATI MUCAJ ,BASHKIA VORE "

Emertimi: PLANIMETRIA E PERGJITHSHME

**"ARABEL - STUDIO" Sh.p.k**  
Adresa: Njesia Bashkiake nr.7, Rruga "Frosina Plaku",  
Pallati 21, Hyrja 1, Kati 2, Tirane.  
Email: arabelstudio@gmail.com

Drejtesues i projektit

Adm. Ana NISHKU  
Inxh. Ardi ARKAXHIU

Projektues	
Nd. Ardi ARKAXHIU	Elek. Altin ALLKAJ
Ark.Rigert HYRA	Top. Mustafa HOXHAI
Gjeo.Irfan BEGAJ	Hid. Hajredin MURGU

SHKALLA	FLETA
1 : 500	5- 05
Vorë 2019	Format A3

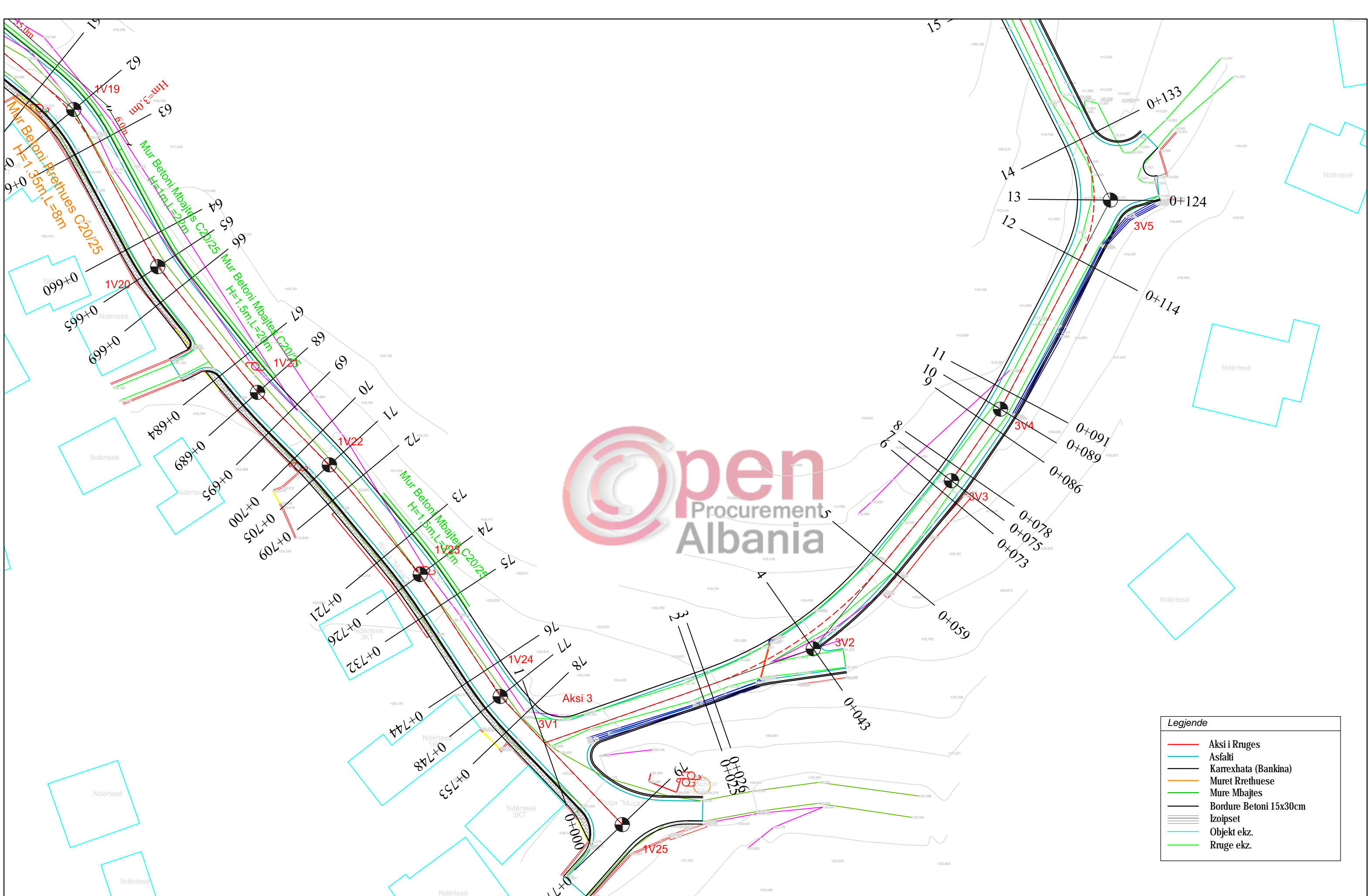

Legjende	
	Aksi i Rruges
	Asfalti
	Karrexhata (Bankina)
	Muret Rrethuese
	Mure Mbahtes
	Bordure Betoni 15x30cm
	Izoipset
	Objekt ekz.
	Rruge ekz.



**POROSITESI : BASHKIA VORË**

OBJEKTI:  
"RIKONSTRUKSION I RRUGEVE MUCAJ, SHERAJ DHE E VESLEVE FSHATI MUCAJ ,BASHKIA VORE "

Emertimi: PLANIMETRIA E PERGJITHSHME

**"ARABEL - STUDIO" Sh.p.k**  
Adresa: Njesia Bashkiake nr.7, Rruga "Frosina Plaku", Pallati 21, Hyrja 1, Kati 2, Tirane.  
Email: arabelstudio@gmail.com

Drejtesues i projektit

Adm. Ana NISHKU  
Inxh. Ardi ARKAXHIU

Projektues

Nd. Ardi ARKAXHIU	Elek. Altin ALLKAJ
Ark.Rigert HYRA	Top. Mustafa HOXHAI
Gjeo.Irfan BEGAJ	Hid. Hajredin MURGU

SHKALLA	FLETA
1 : 500	5- 06
Vorë 2019	Format A3

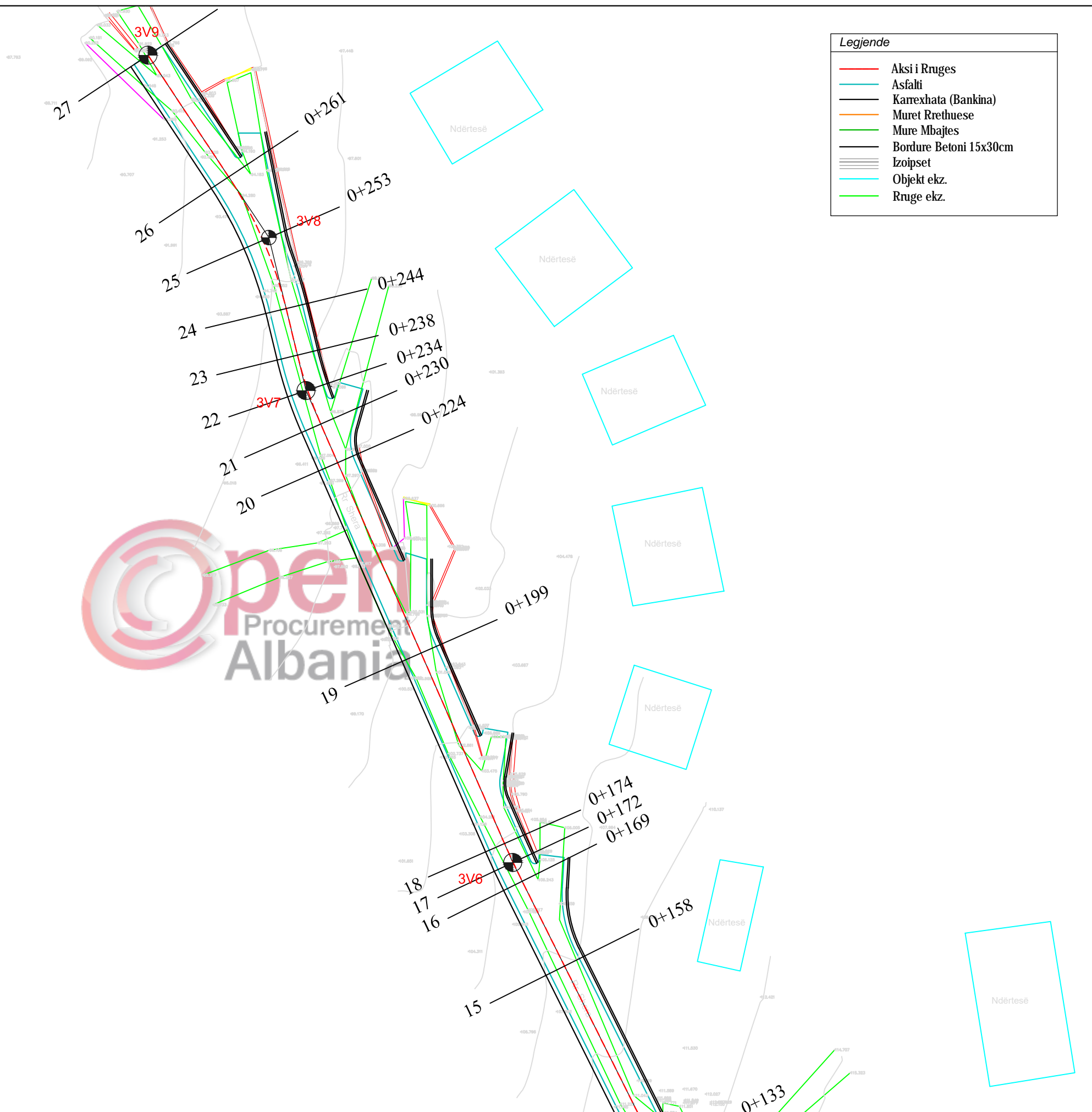

Legjende	
	Aksi i Rrugës
	Asfalti
	Karrexhata (Bankina)
	Muret Rrethuese
	Mure Mbajtes
	Bordure Betoni 15x30cm
	Izoipset
	Objekt ekz.
	Rruge ekz.

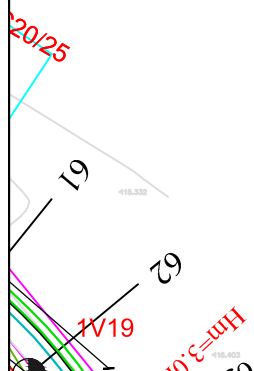

**POROSITESI : BASHKIA VORË**

OBJEKTI:  
"RIKONSTRUKSION I RRUGEVE MUCAJ, SHERAJ DHE E VESLEVE  
FSHATI MUCAJ ,BASHKIA VORE "

Emertimi: PLANIMETRIA E PERGJITHSHME

**"ARABEL - STUDIO" Sh.p.k**  
Adresa: Njesia Bashkiake nr.7, Rruga "Frosina Plaku",  
Pallati 21, Hyrja 1, Kati 2, Tirane.  
Email: arabelstudio@gmail.com

Drejtesues i projektit

Adm. Ana NISHKU  
Inxh. Ardi ARKAXHIU

Projektues

Nd. Ardi ARKAXHIU	Elek. Altin ALLKAJ
Ark.Rigert HYRA	Top. Mustafa HOXHAJ
Gjeo.Irfan BEGAJ	Hid. Hajredin MURGU

SHKALLA	FLETA
1 : 500	5- 07
Vorë 2019	Format A3



REPUBLIKA E SHQIPERISË  
BASHKIA VORË

# PROJEKT ZBATIMI

OBJEKTI:

"RIKONSTRUKSION I RRUGEVE MUCAJ, SHERAJ DHE E VESLEVE, FSHATI MUCAJ"

BASHKIA VORË



## 6. PROFILI GJATESOR

	<b>POROSITESI : BASHKIA VORË</b>	Emertimi: PROFILI GJATESOR I RRUGES	Drejtesues i projektit		Projektues			SHKALLA	FLETA
	OBJEKTI: "RIKONSTRUKSION I RRUGEVE MUCAJ, SHERAJ DHE E VESLEVE FSHATI MUCAJ ,BASHKIA VORE "	 "ARABEL - STUDIO" Sh.p.k Adresa: Njesia Bashkiake nr.7, Rruga "Frosina Plaku", Pallati 21, Hyrja 1, Kati 2, Tirane. Email: arabelstudio@gmail.com	Adm. Ana NISHKU		Nd. Ardi ARKAXHIU		Elek. Altin ALLKAJ	-	6-00
			Inxh. Ardi ARKAXHIU		Ark.Rigert HYRA		Top. Mustafa HOXHAJ	Vorë 2018	Format A3
					Gjeo.Irfan BEGAJ		Hid. Hajredin MURGU		

# PROFILI GJATESOR AKSI 1

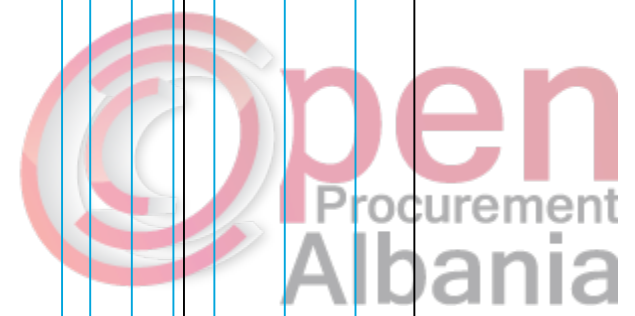
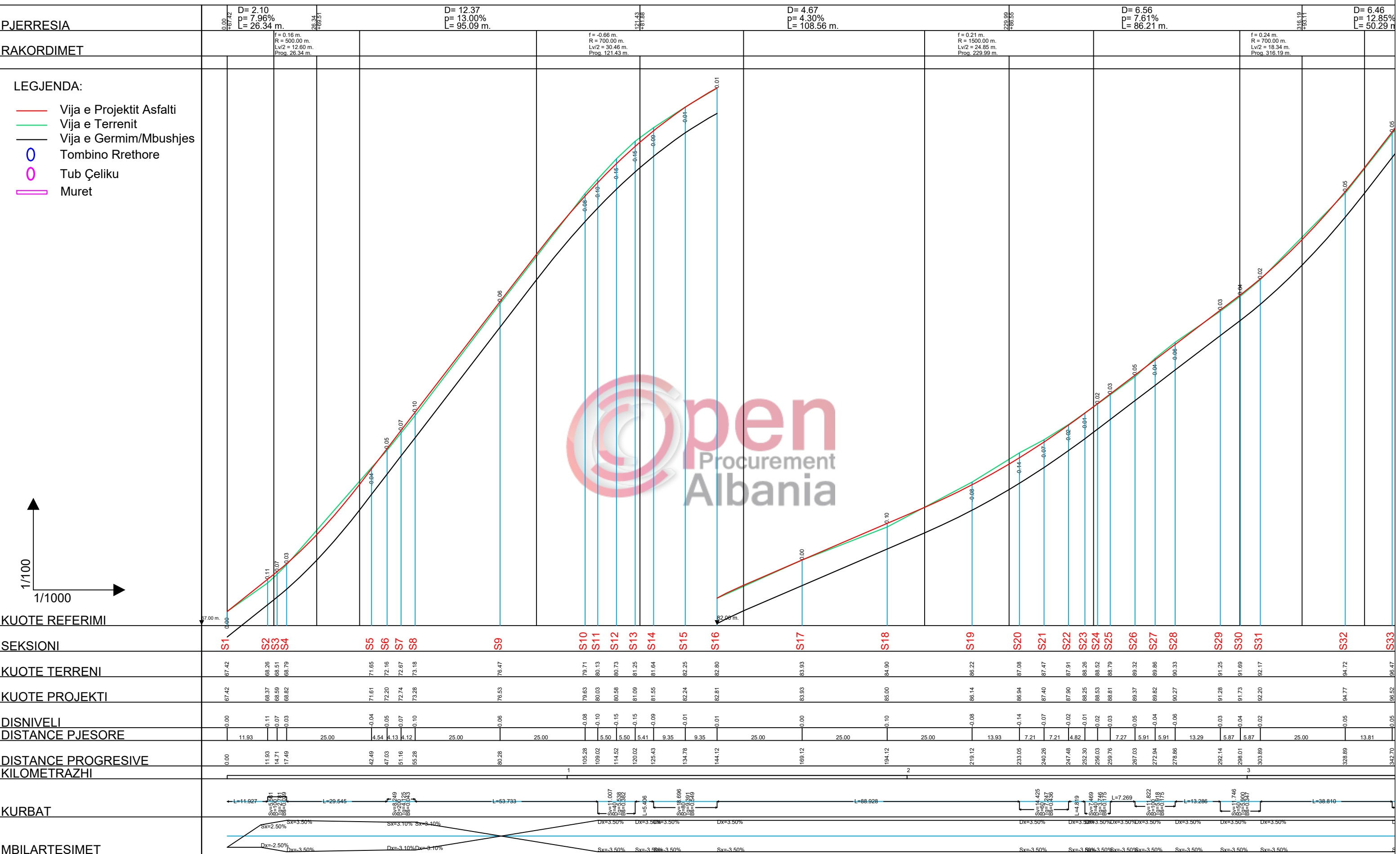

**POROSITESI : BASHKIA VORË**

OBJEKTI:  
"RIKONSTRUKSION I RRUGEVE MUCAJ, SHERAJ DHE E VESLEVE FSHATI MUCAJ, BASHKIA VORE "

Emertimi: PROFILI GJATESOR I RRUGES

**"ARABEL - STUDIO" Sh.p.k**

Adresa: Njesia Bashkiake nr.7, Rruga "Frosina Plaku", Pallati 21, Hyrja 1, Kati 2, Tirane.  
Email: arabelstudio@gmail.com

Drejtues i projektit

Adm. Ana NISHKU  
Inxh. Ardi ARKAXHIU

Projektues

Nd. Ardi ARKAXHIU  
Ark. Rigert HYRA  
Gjeo. Irfan BEGAJ

Elek. Altin ALLKAJ  
Top. Mustafa HOXHAI  
Hid. Hajredin MURGU

SHKALLA: H 1-1000, V 1-100

FLETA: 6-01

Vorë 2018, Format A3

# PROFILI GJATESOR AKSI 1

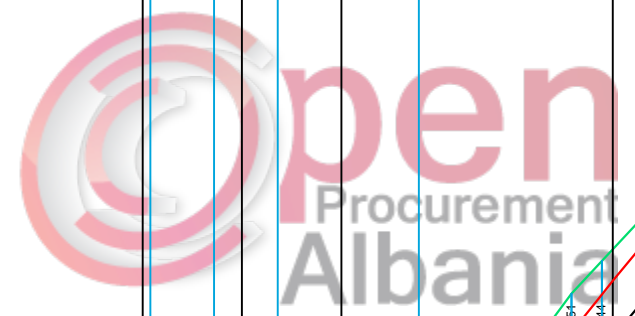
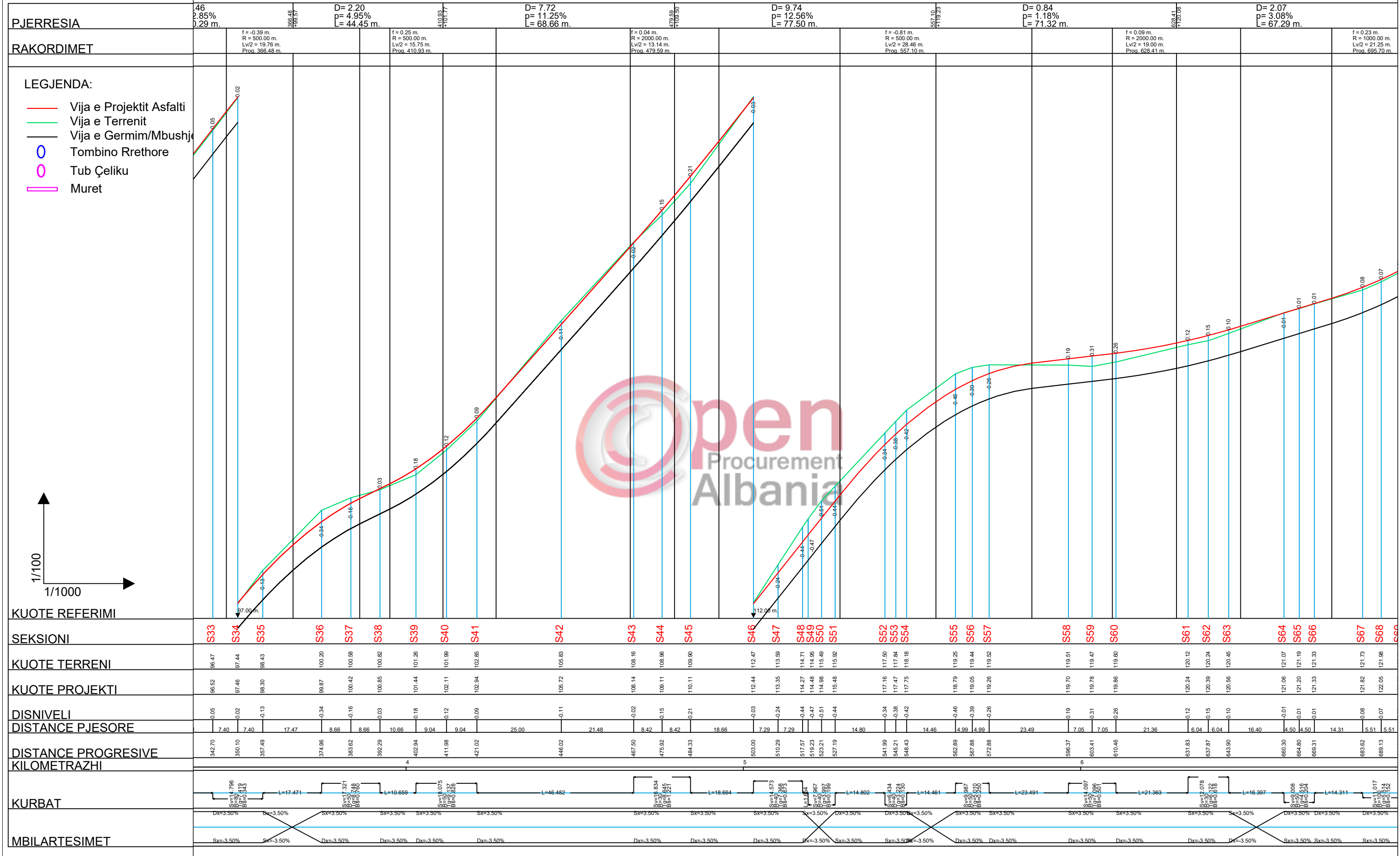

**POROSITESI : BASHKIA VORË**

OBJEKTI:  
"RIKONSTRUKSION I RRUGEVE MUCAJ, SHERAJ DHE E VESLEVE FSHATI MUCAJ ,BASHKIA VORE "

Emertimi: PROFILI GJATESOR I RRUGES

**"ARABEL - STUDIO" Sh.p.k**

Adresa: Njesia Bashkiake nr.7, Rruga "Frosina Plaku", Pallati 21, Hyrja 1, Kati 2, Tirane.  
Email: arabelstudio@gmail.com

<b>Drejtesues i projektit</b>		<b>Projektues</b>	
Adm. Ana NISHKU		Nd. Ardi ARKAXHIU	Elek. Altin ALLKAJ
Inxh. Ardi ARKAXHIU		Ark.Rigert HYRA	Top. Mustafa HOXHAI
		Gjeo.Irfan BEGAJ	Hid. Hajredin MURGU

<b>SHKALLA</b>	<b>FLETA</b>
H 1-1000 V 1-100	6-02
Vorë 2018	Format A3

## PROFILI GJATESOR AKSI 1

## PROFILI GJATESOR AKSI 2

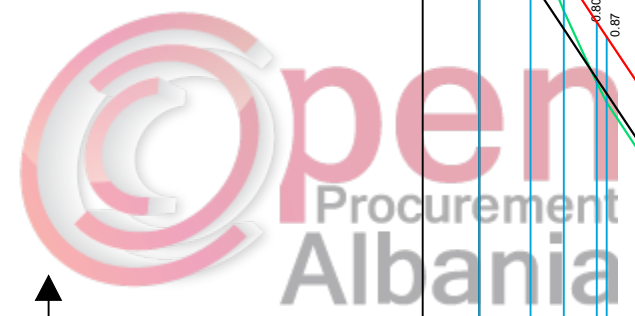
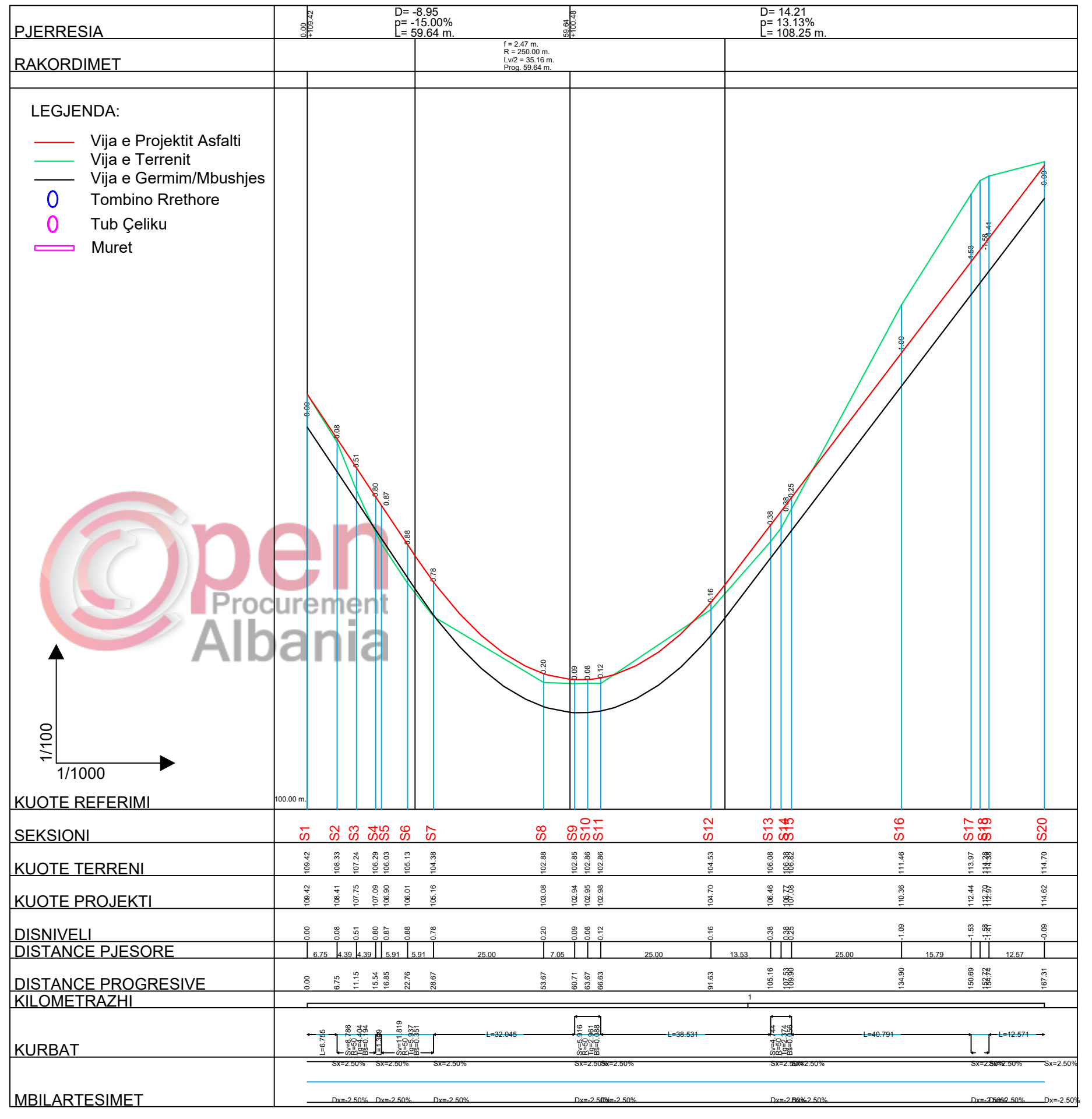
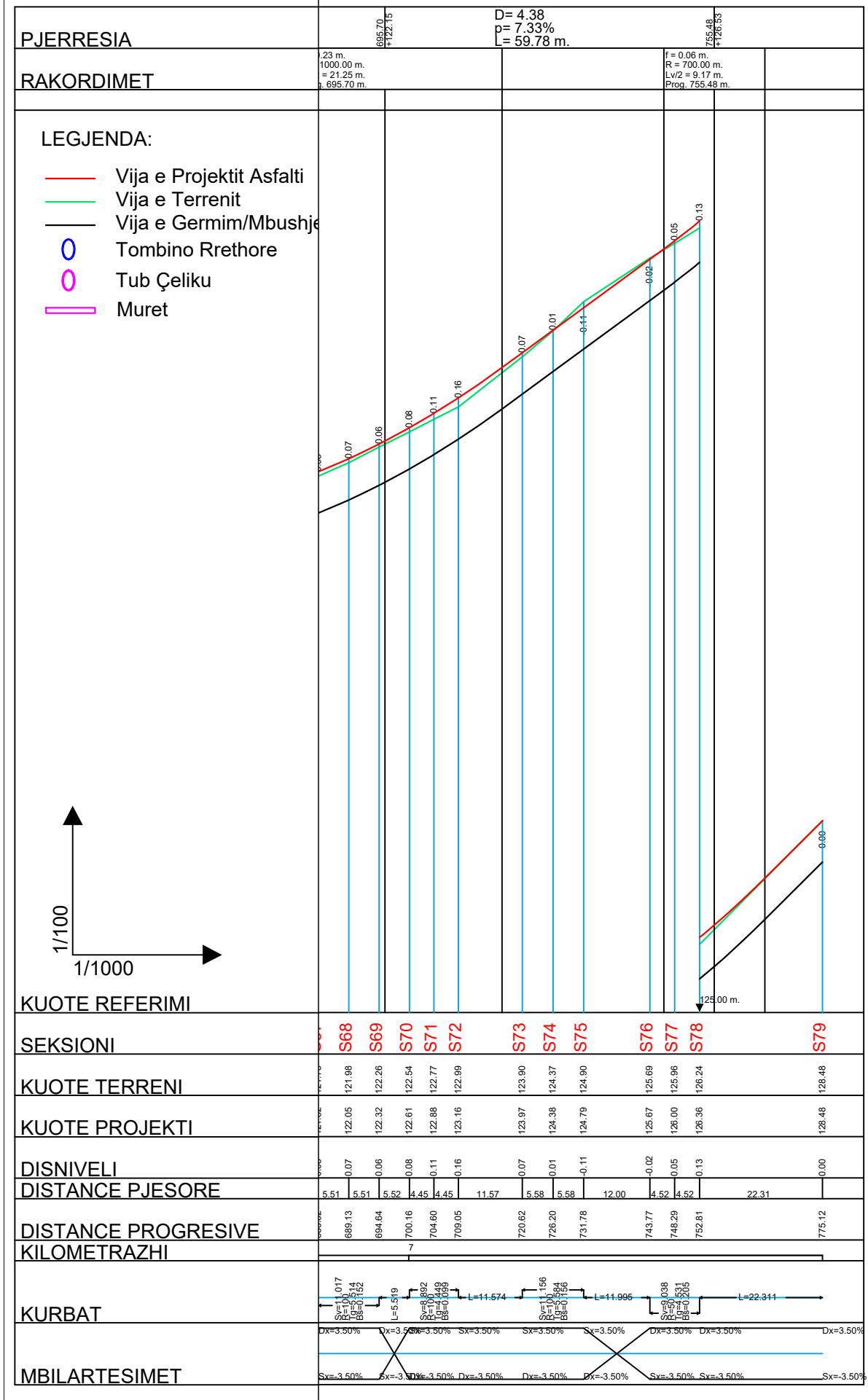

### POROSITESI : BASHKIA VORË

OBJEKTI:  
"RIKONSTRUKSION I RRUGEVE MUCAJ, SHERAJ DHE E VESLEVE  
FSHATI MUCAJ, BASHKIA VORE "

Emertimi: PROFILI GJATESOR I RRUGES

**"ARABEL - STUDIO" Sh.p.k**

Adresa: Njesia Bashkiake nr.7, Rruga "Frosina Plaku",  
Pallati 21, Hyrja 1, Kati 2, Tirane.  
Email: arabelstudio@gmail.com

Drejtesues i projektit		Projektues	
Adm. Ana NISHKU	Nd. Ardi ARKAXHIU	Elek. Altin ALLKAJ	
Inxh. Ardi ARKAXHIU	Ark.Rigert HYRA	Top. Mustafa HOXHAI	
	Gjeo.Irfan BEGAJ	Hid. Hajredin MURGU	

SHKALLA	FLETA
H 1-1000 V 1-100	6-03
Vorë 2018	Format A3

# PROFILI GJATESOR AKSI 3

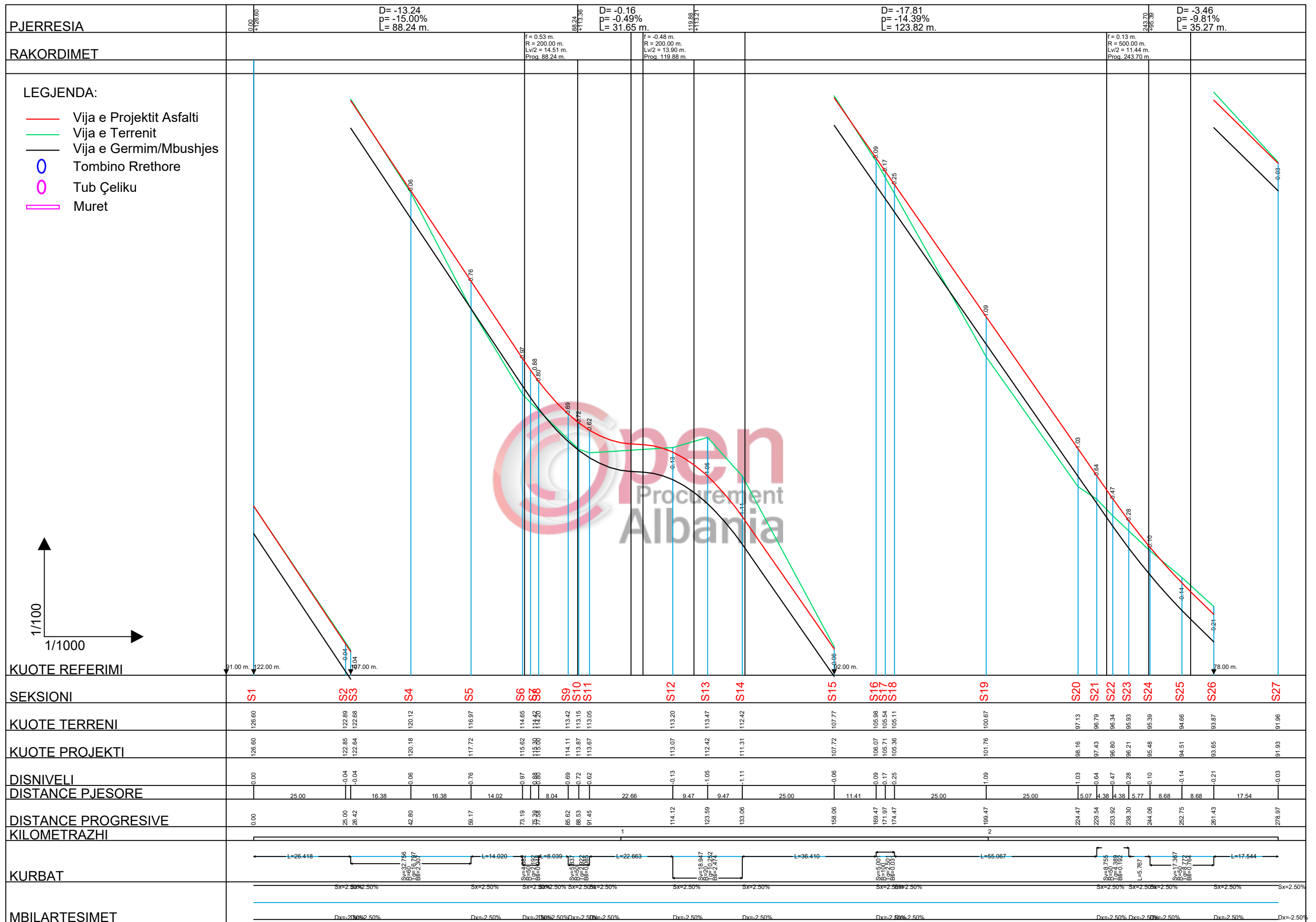

**POROSITESI : BASHKIA VORË**

OBJEKTI:  
"RIKONSTRUKSION I RRUGEVE MUCAJ, SHERAJ DHE E VESLEVE FSHATI MUCAJ ,BASHKIA VORE "

Emertimi: PROFILI GJATESOR I RRUGES

**"ARABEL - STUDIO" Sh.p.k**

Adresa: Njesia Bashkiake nr.7, Rruga "Frosina Plaku", Pallati 21, Hyrja 1, Kati 2, Tirane.  
Email: arabelstudio@gmail.com

Drejtesues i projektit

Adm. Ana NISHKU

Inxh. Ardi ARKAXHIU

Projektues

Nd. Ardi ARKAXHIU  
Ark. Rigert HYRA  
Gjeo. Irfan BEGAJ

Elek. Altin ALLKAJ  
Top. Mustafa HOXHAI  
Hid. Hajredin MURGU

SHKALLA  
H 1-1000  
V 1-100  
Vorë 2018

FLETA  
6-04  
Format A3





REPUBLIKA E SHQIPERISË  
BASHKIA VORË

# PROJEKT ZBATIMI

OBJEKTI:

"RIKONSTRUKSION I RRUGEVE MUCAJ, SHERAJ DHE E VESLEVE, FSHATI MUCAJ"

BASHKIA VORË



7.PLANI K.U.B



**POROSITESI : BASHKIA VORË**

OBJEKTI:  
"RIKONSTRUKSION I RRUGEVE MUCAJ, SHERAJ DHE E VESLEVE  
FSHATI MUCAJ ,BASHKIA VORE "

Emertimi: PLANI K.U.B DHE K.U.Z



"ARABEL - STUDIO" Sh.p.k  
Adresa:Njesia Bashkiake nr.7, Rruga "Frosina Plaku",  
Pallati 21, Hyrja 1, Kati 2,Tirane.  
Email: arabelstudio@gmail.com

Drejtues i projektit

Adm. Ana NISHKU  
Inxh. Ardi ARKAXHIU

Projektues

Nd. Ardi ARKAXHIU  
Ark.Rigert HYRA  
Gjeo.Irfan BEGAJ  
Elek. Altin ALLKAJ  
Top. Mustafa HOXHAJ  
Hid. Hajredin MURGU

SHKALLA FLETA

- 7 - 00  
Vorë 2018 Format A3

LEGJENDA:

	Tub H.D.P.E Ø=250 KUB
	Tub H.D.P.E Ø=315 KUB
	Tub H.D.P.E Ø=400 KUB
	Tombino kalimi tub KUB
	PIKE SHKARKIMI
	PUSETE SHIU
	DREJTIMI I RRJEDHES KUB

Pike shkarkimi  
PUSETE KUZ EKZ

Pike shkarkimi  
PUSETE KUZ EKZ

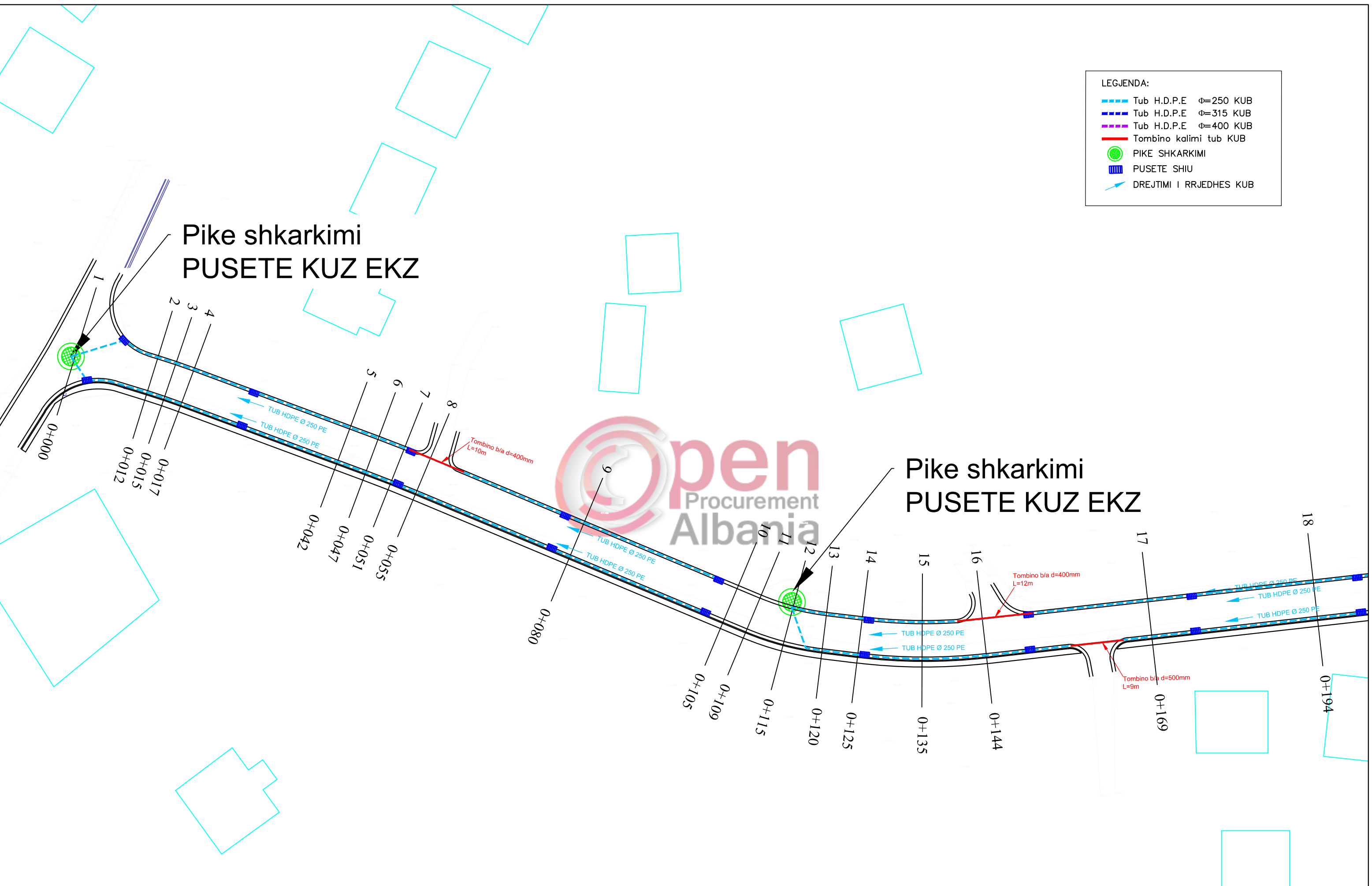

**POROSITESI : BASHKIA VORË**

OBJEKTI:  
"RIKONSTRUKSION I RRUGEVE MUCAJ, SHERAJ DHE E VESLEVE FSHATI MUCAJ ,BASHKIA VORE "

Emertimi: PLANI K.U.B DHE K.U.Z

"ARABEL - STUDIO" Sh.p.k  
Adresa:Njesia Bashkiake nr.7, Rruga "Frosina Plaku", Pallati 21, Hyrja 1, Kati 2,Tirane.  
Email: arabelstudio@gmail.com

Drejtes i projektit

Adm. Ana NISHKU  
Inxh. Ardi ARKAXHIU

Projektues

Nd. Ardi ARKAXHIU	Elek. Altin ALLKAJ
Ark.Rigert HYRA	Top. Mustafa HOXHAI
Gjeo.Irfan BEGAJ	Hid. Hajredin MURGU

SHKALLA	FLETA
1 : 500	7- 01
Vorë 2019	Format A3

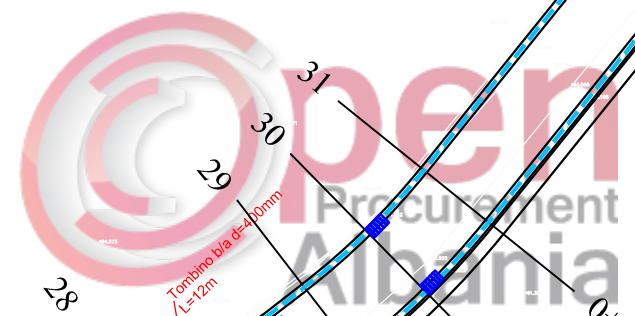
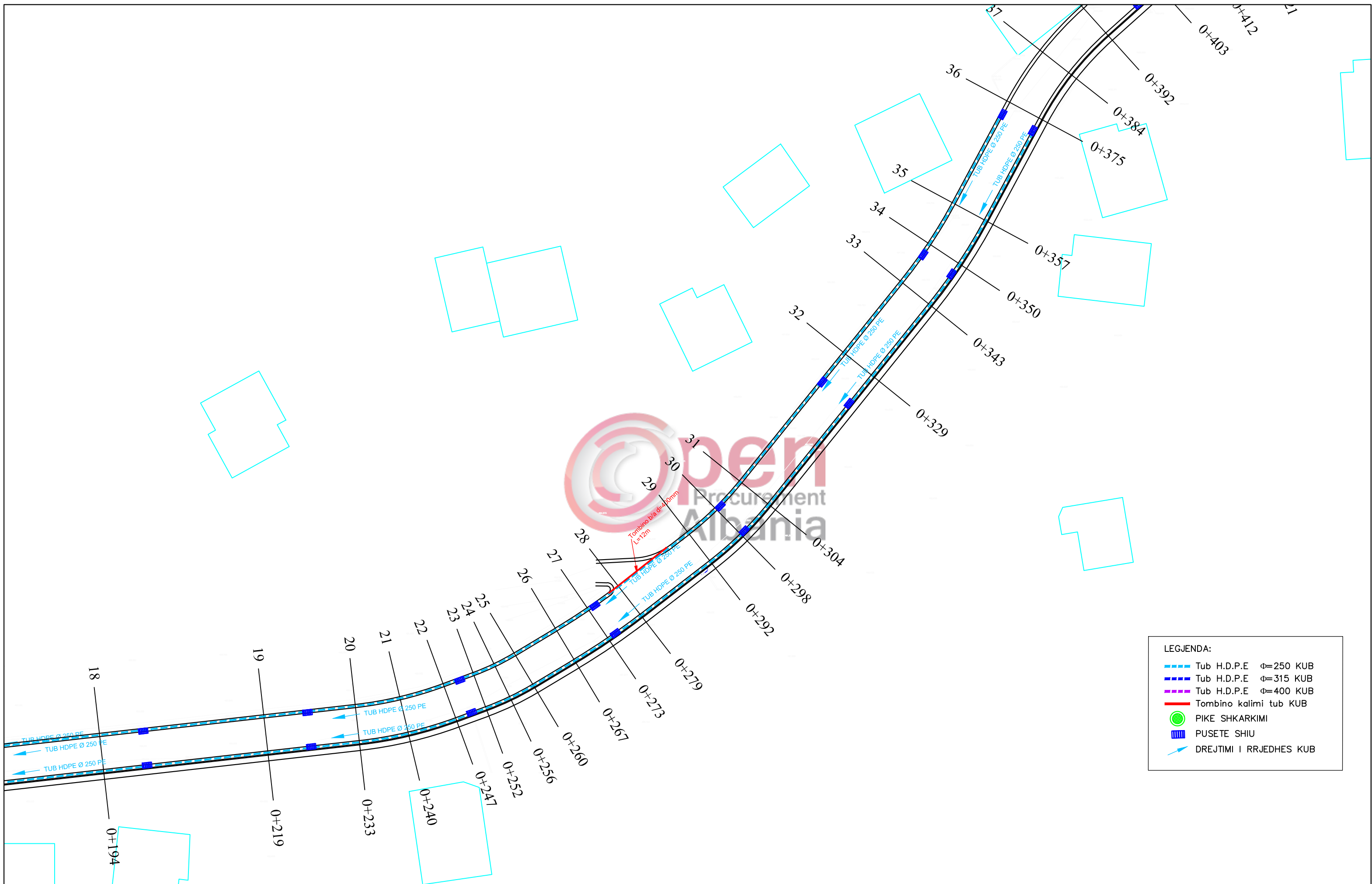

LEGJENDA:

	Tub H.D.P.E $\Phi=250$ KUB
	Tub H.D.P.E $\Phi=315$ KUB
	Tub H.D.P.E $\Phi=400$ KUB
	Tombino kalimi tub KUB
	PIKE SHKARKIMI
	PUSETE SHIU
	DREJTIMI I RRJEDHES KUB



**POROSITESI : BASHKIA VORË**

OBJEKTI:  
"RIKONSTRUKSION I RRUGEVE MUCAJ, SHERAJ DHE E VESLEVE FSHATI MUCAJ ,BASHKIA VORE "

Emertimi: PLANI K.U.B DHE K.U.Z

**"ARABEL - STUDIO" Sh.p.k**

Adresa:Njesia Bashkiake nr.7, Rruga "Frosina Plaku", Pallati 21, Hyrja 1, Kati 2,Tirane.  
Email: arabelstudio@gmail.com

Drejtesues i projektit

Adm. Ana NISHKU

Inxh. Ardi ARKAXHIU

Projektues

Nd. Ardi ARKAXHIU	Elek. Altin ALLKAJ
Ark.Rigert HYRA	Top. Mustafa HOXHAI
Gjeo.Irfan BEGAJ	Hid. Hajredin MURGU

SHKALLA	FLETA
1 : 500	7- 02
Vorë 2019	Format A3

LEGJENDA:

	Tub H.D.P.E Ø=250 KUB
	Tub H.D.P.E Ø=315 KUB
	Tub H.D.P.E Ø=400 KUB
	Tombino kalimi tub KUB
	PIKE SHKARKIMI
	PUSETE SHIU
	DREJTIMI I RRJEDHES KUB

**Pike shkarkimi  
PUSETE KUZ EKZ**

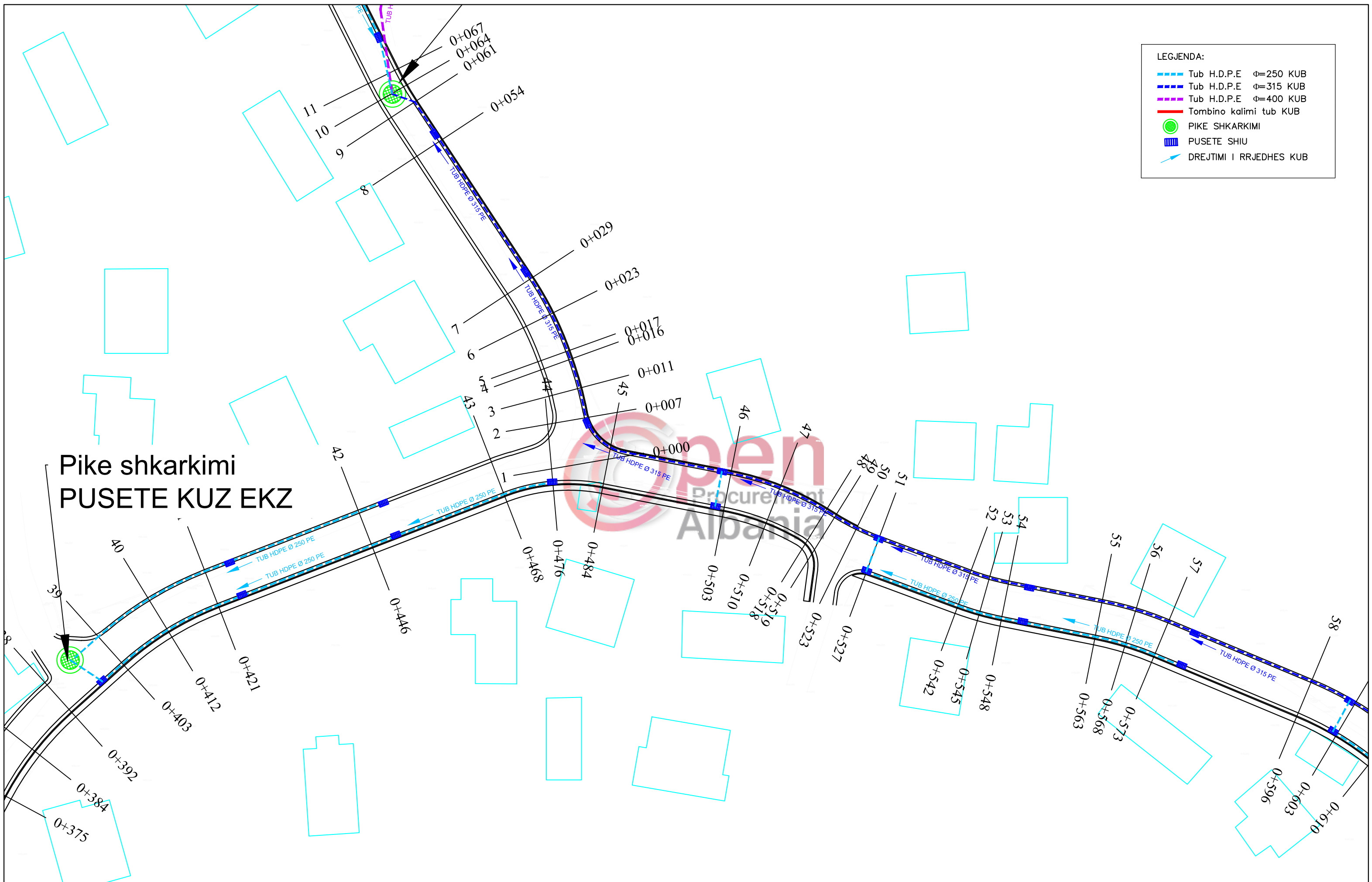

**POROSITESI : BASHKIA VORË**  
 OBJEKTI:  
 "RIKONSTRUKSION I RRUGEVE MUCAJ, SHERAJ DHE E VESLEVE  
 FSHATI MUCAJ ,BASHKIA VORE "

Emertimi: PLANI K.U.B DHE K.U.Z  
  
**"ARABEL - STUDIO" Sh.p.k**  
 Adresa:Njesia Bashkiake nr.7, Rruga "Frosina Plaku",  
 Pallati 21, Hyrja 1, Kati 2,Tirane.  
 Email: arabelstudio@gmail.com

Drejtues i projektit  
 Adm. Ana NISHKU  
 Inxh. Ardi ARKAXHIU

Projektues  
 Nd. Ardi ARKAXHIU  
 Ark.Rigert HYRA  
 Gjeo.Irfan BEGAJ  
 Elek. Altin ALLKAJ  
 Top. Mustafa HOXHAJ  
 Hid. Hajredin MURGU

SHKALLA	FLETA
1 : 500	7- 03
Vorë 2019	Format A3

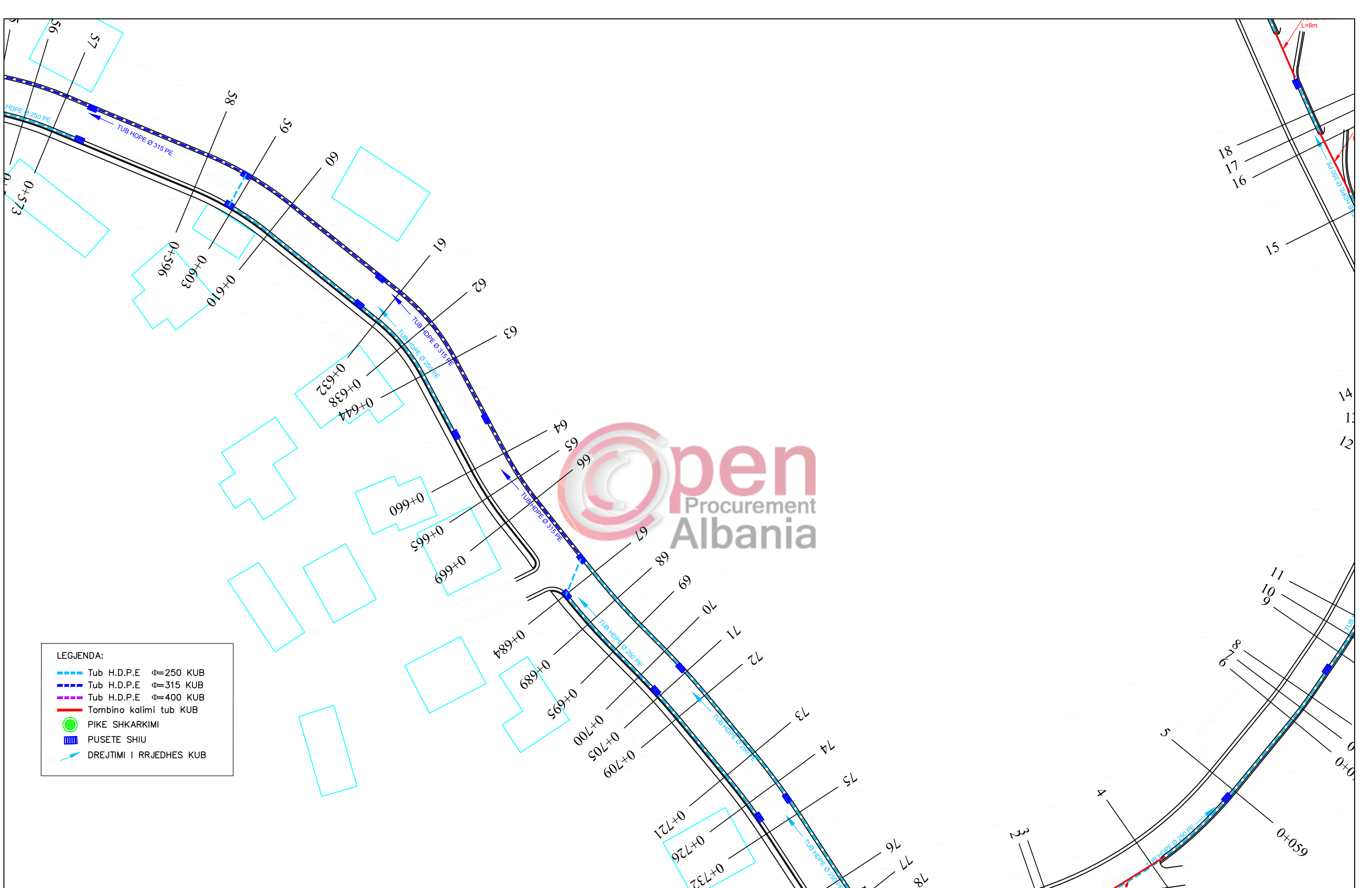

- LEGJENDA:
- Tub H.D.P.E  $\Phi=250$  KUB
  - Tub H.D.P.E  $\Phi=315$  KUB
  - Tub H.D.P.E  $\Phi=400$  KUB
  - Tombino kalimi tub KUB
  - PIKE SHKARKIMI
  - PUSETE SHIU
  - DREJTIMI I RRJEDHES KUB



**POROSITESI : BASHKIA VORË**

OBJEKTI:  
 "RIKONSTRUKSION I RRUGEVE MUCAJ, SHERAJ DHE E VESLEVE FSHATI MUCAJ ,BASHKIA VORE "

Emertimi: PLANI K.U.B DHE K.U.Z

"ARABEL - STUDIO" Sh.p.k  
 Adresa: Njesia Bashkiake nr.7, Rruga "Frosina Plaku", Pallati 21, Hyrja 1, Kati 2, Tirane.  
 Email: arabelstudio@gmail.com

Drejtues i projektit

Adm. Ana NISHKU  
 Inxh. Ardi ARKAXHIU

Projektues

Nd. Ardi ARKAXHIU	Elek. Altin ALLKAJ
Ark.Rigert HYRA	Top. Mustafa HOXHAI
Gjeo.Irfan BEGAJ	Hid. Hajredin MURGU

SHKALLA	FLETA
1 : 500	7- 04
Vorë 2019	Format A3

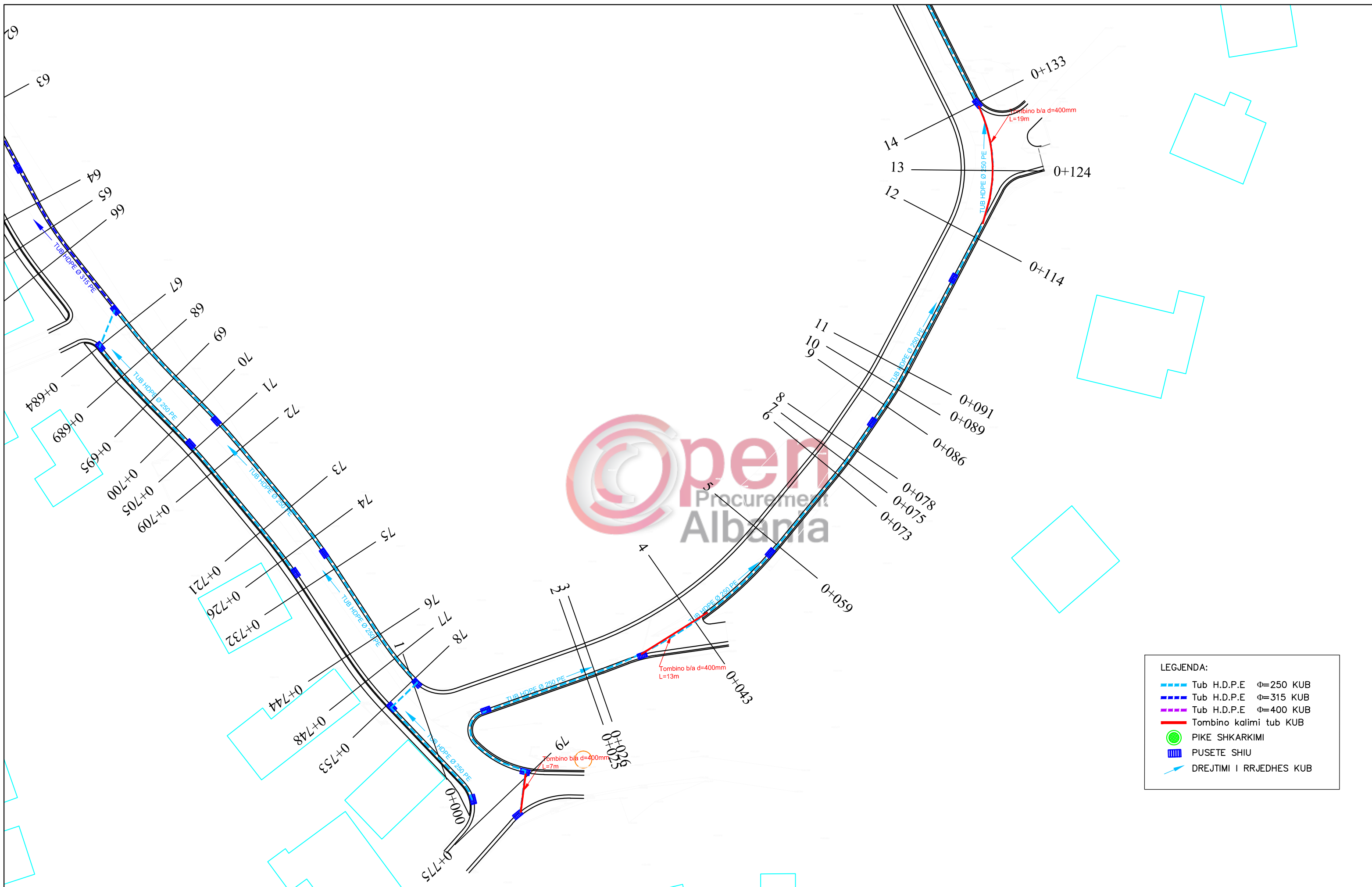

**LEGJENDA:**

	Tub H.D.P.E $\phi=250$ KUB
	Tub H.D.P.E $\phi=315$ KUB
	Tub H.D.P.E $\phi=400$ KUB
	Tombino kalimi tub KUB
	PIKE SHKARKIMI
	PUSETE SHIU
	DREJTIMI I RRJEDHES KUB



**POROSITESI : BASHKIA VORË**

OBJEKTI:  
 "RIKONSTRUKSION I RRUGEVE MUCAJ, SHERAJ DHE E VESLEVE  
 FSHATI MUCAJ ,BASHKIA VORE "

Emertimi: PLANI K.U.B DHE K.U.Z

**"ARABEL - STUDIO" Sh.p.k**

Adresa:Njesia Bashkiake nr.7, Rruga "Frosina Plaku",  
 Pallati 21, Hyrja 1, Kati 2,Tirane.  
 Email: arabelstudio@gmail.com

**Drejtesues i projektit**

Adm. Ana NISHKU

Inxh. Ardi ARKAXHIU

**Projektues**

Nd. Ardi ARKAXHIU	Elek. Altin ALLKAJ
Ark.Rigert HYRA	Top. Mustafa HOXHAJ
Gjeo.Irfan BEGAJ	Hid. Hajredin MURGU

<b>SHKALLA</b>	<b>FLETA</b>
1 : 500	7- 05
Vorë 2019	Format A3

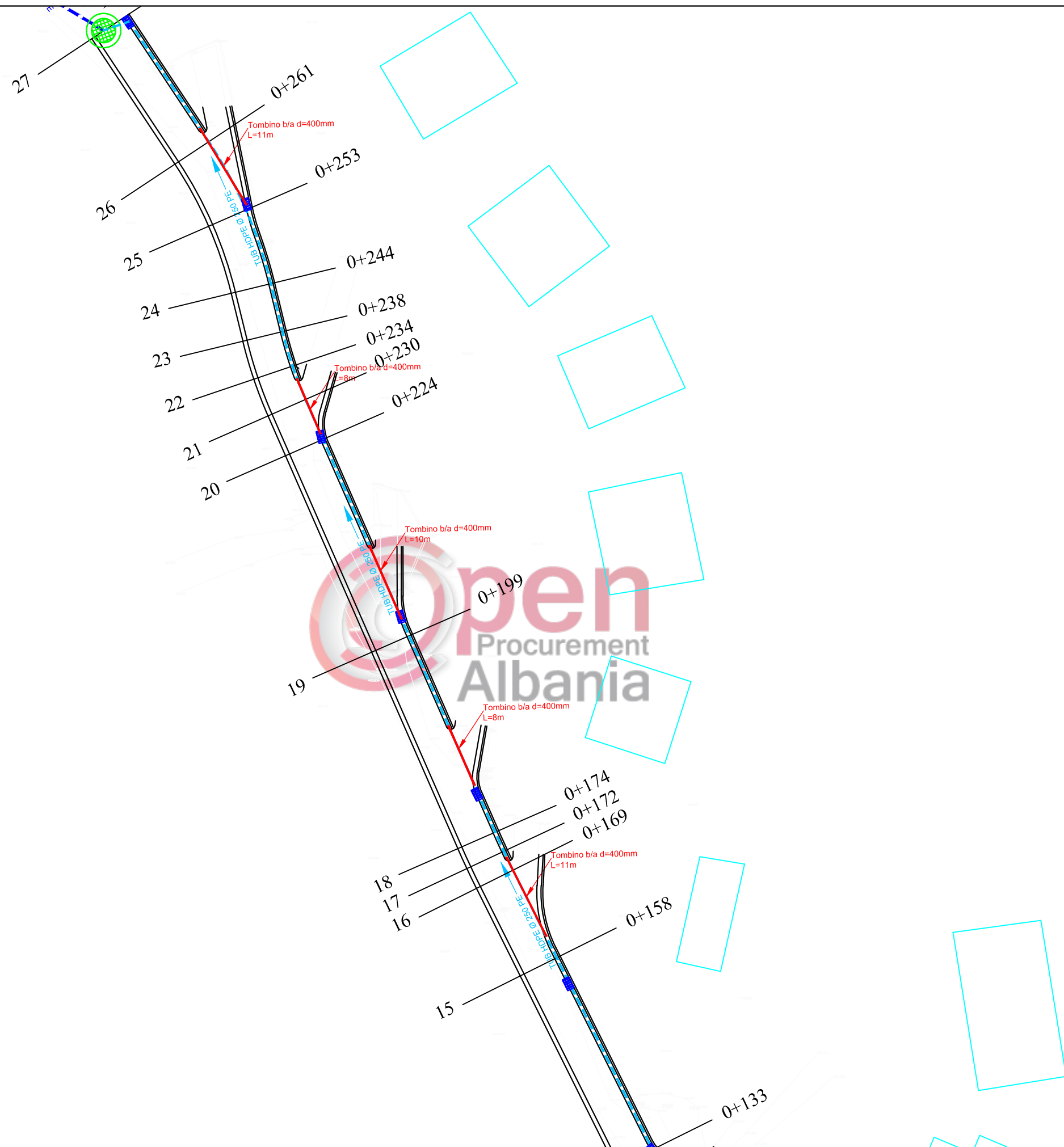

- LEGJENDA:**
- Tub H.D.P.E  $\Phi=250$  KUB
  - Tub H.D.P.E  $\Phi=315$  KUB
  - Tub H.D.P.E  $\Phi=400$  KUB
  - Tombino kalimi tub KUB
  - PIKE SHKARKIMI
  - PUSETE SHIU
  - DREJTIMI I RRJEDHES KUB

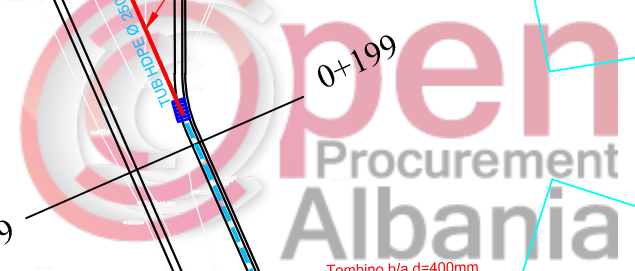

**POROSITESI : BASHKIA VORË**

OBJEKTI:  
 "RIKONSTRUKSION I RRUGEVE MUCAJ, SHERAJ DHE E VESLEVE FSHATI MUCAJ ,BASHKIA VORE "

Emertimi: PLANI K.U.B DHE K.U.Z

"ARABEL - STUDIO" Sh.p.k  
 Adresa: Njesia Bashkiake nr.7, Rruga "Frosina Plaku", Pallati 21, Hyrja 1, Kati 2, Tirane.  
 Email: arabelstudio@gmail.com

Drejtimes i projektit

Adm. Ana NISHKU  
 Inxh. Ardi ARKAXHIU

Projektues

Nd. Ardi ARKAXHIU	Elek. Altin ALLKAJ
Ark.Rigert HYRA	Top. Mustafa HOXHAI
Gjeo.Irfan BEGAJ	Hid. Hajredin MURGU

SHKALLA	FLETA
1 : 500	7- 06
Vorë 2019	Format A3



LEGJENDA:

- Tub H.D.P.E  $\Phi=250$  KUB
- Tub H.D.P.E  $\Phi=315$  KUB
- Tub H.D.P.E  $\Phi=400$  KUB
- Tombino kalimi tub KUB
- PIKE SHKARKIMI
- ▨ PUSETE SHIU
- DREJTIMI I RRJEDHES KUB



**POROSITESI : BASHKIA VORË**

OBJEKTI:  
"RIKONSTRUKSION I RRUGEVE MUCAJ, SHERAJ DHE E VESLEVE  
FSHATI MUCAJ ,BASHKIA VORE "

Emertimi: PLANI K.U.B DHE K.U.Z

**"ARABEL - STUDIO" Sh.p.k**  
Adresa: Njesia Bashkiake nr.7, Rruga "Frosina Plaku",  
Pallati 21, Hyrja 1, Kati 2, Tirane.  
Email: arabelstudio@gmail.com

Drejtuues i projektit

Adm. Ana NISHKU

Inxh. Ardi ARKAXHIU

Projektues

Nd. Ardi ARKAXHIU	Elek. Altin ALLKAJ
Ark.Rigert HYRA	Top. Mustafa HOXHAJ
Gjeo.Irfan BEGAJ	Hid. Hajredin MURGU

SHKALLA	FLETA
1 : 500	7- 07
Vorë 2019	Format A3



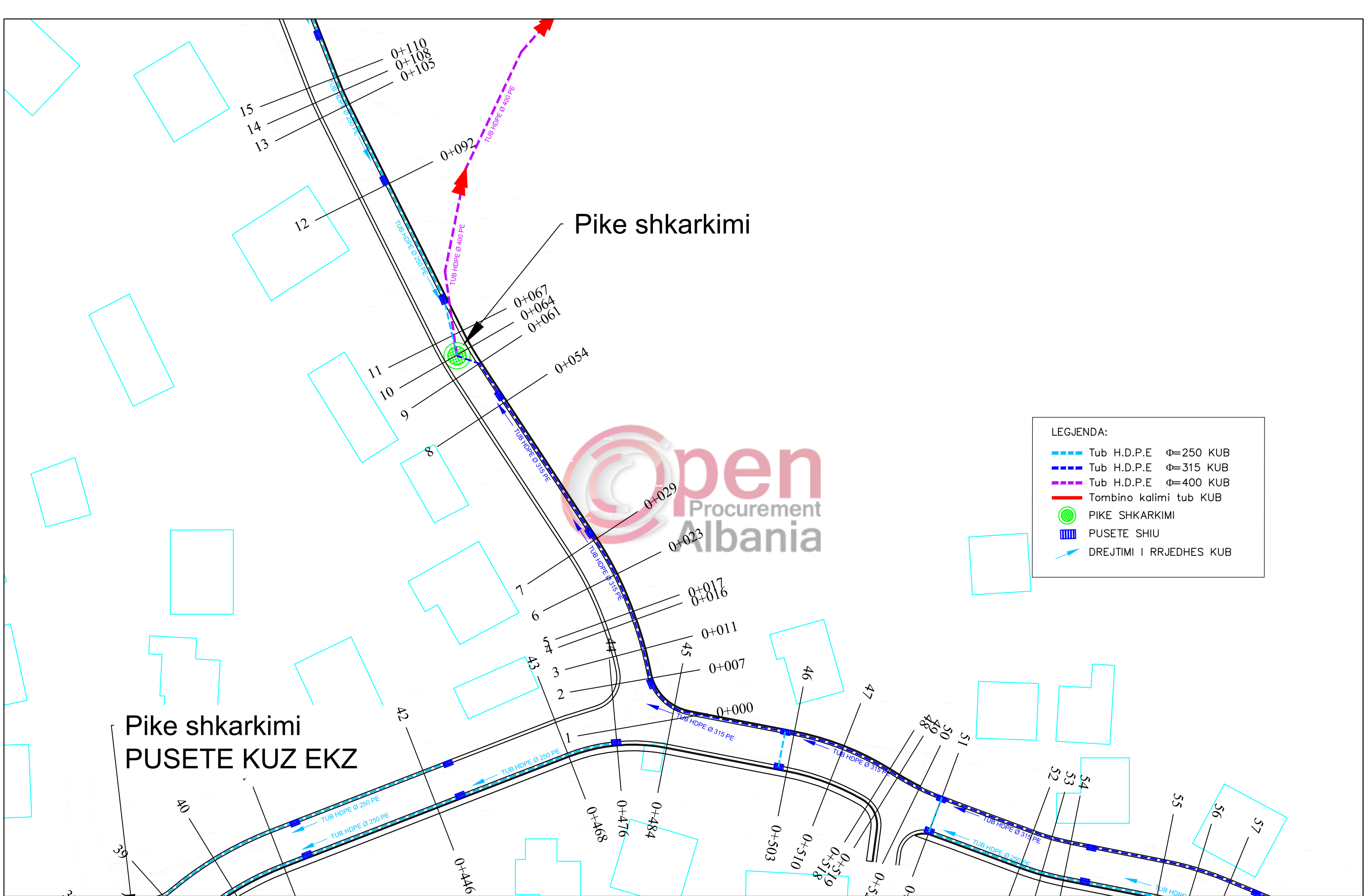

LEGJENDA:

	Tub H.D.P.E $\Phi=250$ KUB
	Tub H.D.P.E $\Phi=315$ KUB
	Tub H.D.P.E $\Phi=400$ KUB
	Tombino kalimi tub KUB
	PIKE SHKARKIMI
	PUSETE SHIU
	DREJTIMI I RRJEDHES KUB

Pike shkarkimi  
PUSETE KUZ EKZ

Pike shkarkimi



**POROSITESI : BASHKIA VORË**  
 OBJEKTI:  
 "RIKONSTRUKSION I RRUGEVE MUCAJ, SHERAJ DHE E VESLEVE  
 FSHATI MUCAJ ,BASHKIA VORE "

Emertimi: PLANI K.U.B DHE K.U.Z  
  
**"ARABEL - STUDIO" Sh.p.k**  
 Adresa:Njesia Bashkiake nr.7, Rruga "Frosina Plaku",  
 Pallati 21, Hyrja 1, Kati 2,Tirane.  
 Email: arabelstudio@gmail.com

Drejtesues i projektit  
 Adm. Ana NISHKU  
 Inxh. Ardi ARKAXHIU

Projektues  
 Nd. Ardi ARKAXHIU  
 Ark.Rigert HYRA  
 Gjeo.Irfan BEGAJ  
 Elek. Altin ALLKAJ  
 Top. Mustafa HOXHAI  
 Hid. Hajredin MURGU

SHKALLA	FLETA
1 : 500	7- 10
Vorë 2019	Format A3

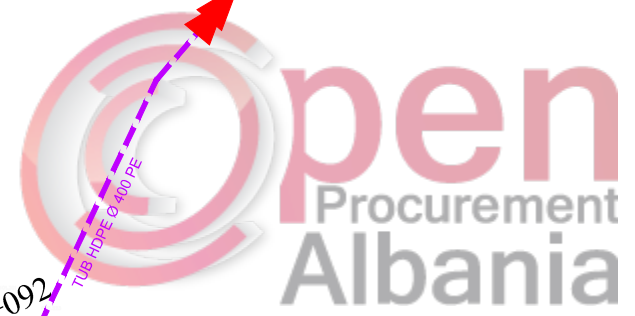
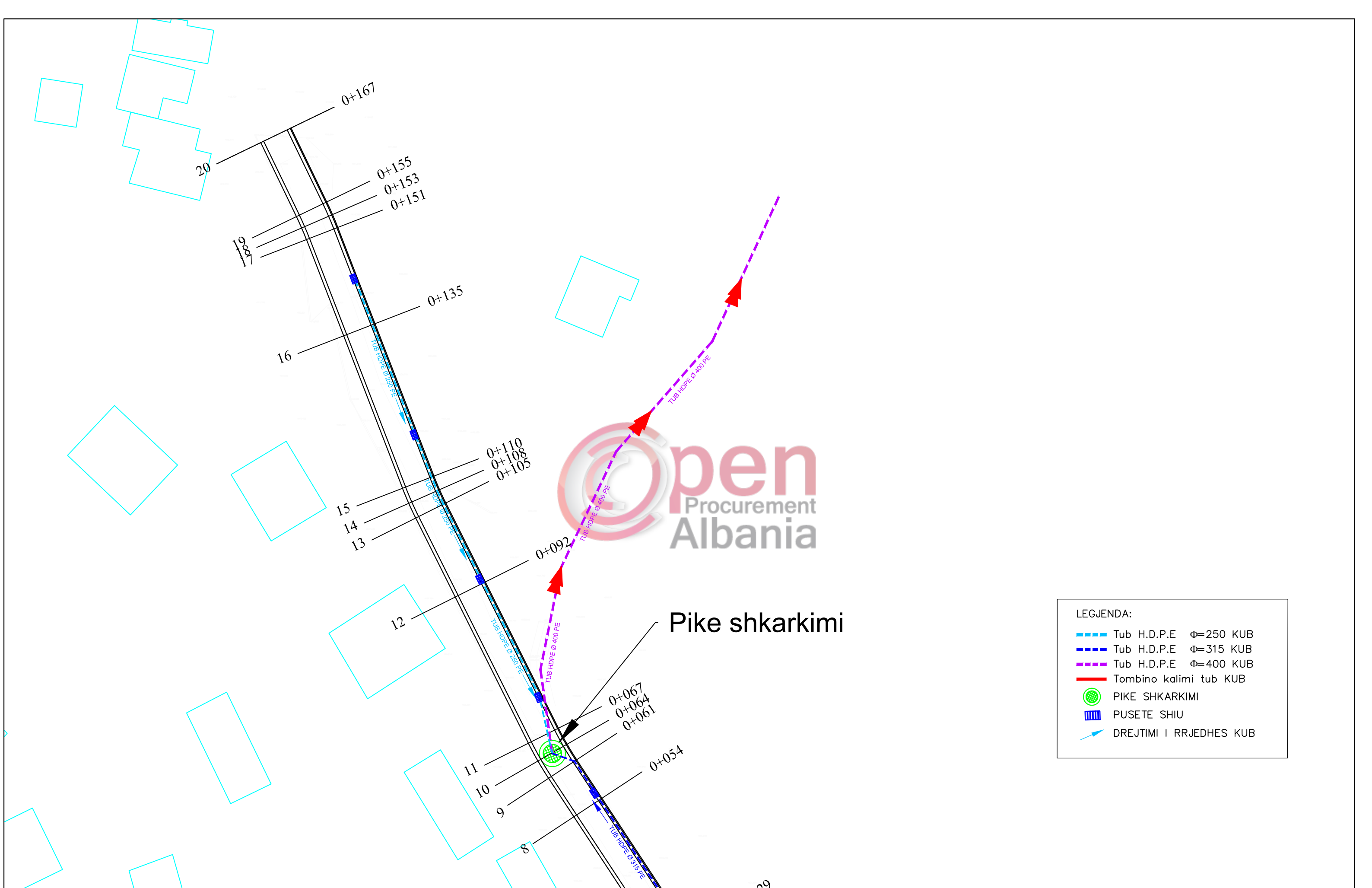

Pike shkarkimi

LEGJENDA:

	Tub H.D.P.E $\Phi=250$ KUB
	Tub H.D.P.E $\Phi=315$ KUB
	Tub H.D.P.E $\Phi=400$ KUB
	Tombino kalimi tub KUB
	PIKE SHKARKIMI
	PUSETE SHIU
	DREJTIMI I RRJEDHES KUB



**POROSITESI : BASHKIA VORË**

OBJEKTI:  
"RIKONSTRUKSION I RRUGEVE MUCAJ, SHERAJ DHE E VESLEVE FSHATI MUCAJ ,BASHKIA VORE "

Emertimi: PLANI K.U.B DHE K.U.Z

"ARABEL - STUDIO" Sh.p.k  
Adresa: Njesia Bashkiake nr.7, Rruga "Frosina Plaku", Pallati 21, Hyrja 1, Kati 2, Tirane.  
Email: arabelstudio@gmail.com

Drejtues i projektit

Adm. Ana NISHKU	
Inxh. Ardi ARKAXHIU	

Projektues

Nd. Ardi ARKAXHIU	Elek. Altin ALLKAJ
Ark.Rigert HYRA	Top. Mustafa HOXHAI
Gjeo.Irfan BEGAJ	Hid. Hajredin MURGU

SHKALLA	FLETA
1 : 500	7- 11
Vorë 2019	Format A3



REPUBLIKA E SHQIPERISË  
BASHKIA VORË

# PROJEKT ZBATIMI

OBJEKTI:

"RIKONSTRUKSION I RRUGEVE MUCAJ, SHERAJ DHE E VESLEVE, FSHATI MUCAJ"

BASHKIA VORË



## 11. PLANIMETRIA E NDRICIMIT

	<b>POROSITESI : BASHKIA VORË</b>	<b>Emertimi: PLANIMETRIA E NDRICIMIT</b>	<b>Drejtues i projektit</b>		<b>Projektues</b>			<b>SHKALLA</b>	<b>FLETA</b>
	OBJEKTI: "RIKONSTRUKSION I RRUGEVE MUCAJ, SHERAJ DHE E VESLEVE FSHATI MUCAJ ,BASHKIA VORE "	 "ARABEL - STUDIO" Sh.p.k Adresa:Njesia Bashkiake nr.7, Rruga "Frosina Plaku", Pallati 21, Hyrja 1, Kati 2,Tirane. Email: arabelstudio@gmail.com	Adm. Ana NISHKU		Nd. Ardi ARKAXHIU		Elek. Altin ALLKAJ	-	11 - 00
			Inxh. Ardi ARKAXHIU		Ark.Rigert HYRA		Top. Mustafa HOXHAJ	Vorë 2018	Format A3
					Gjeo.Irfan BEGAJ		Hid. Hajredin MURGU		

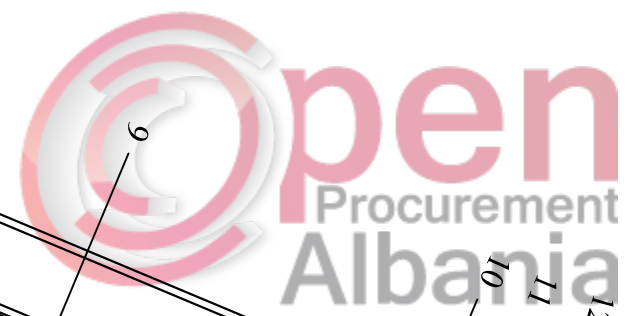
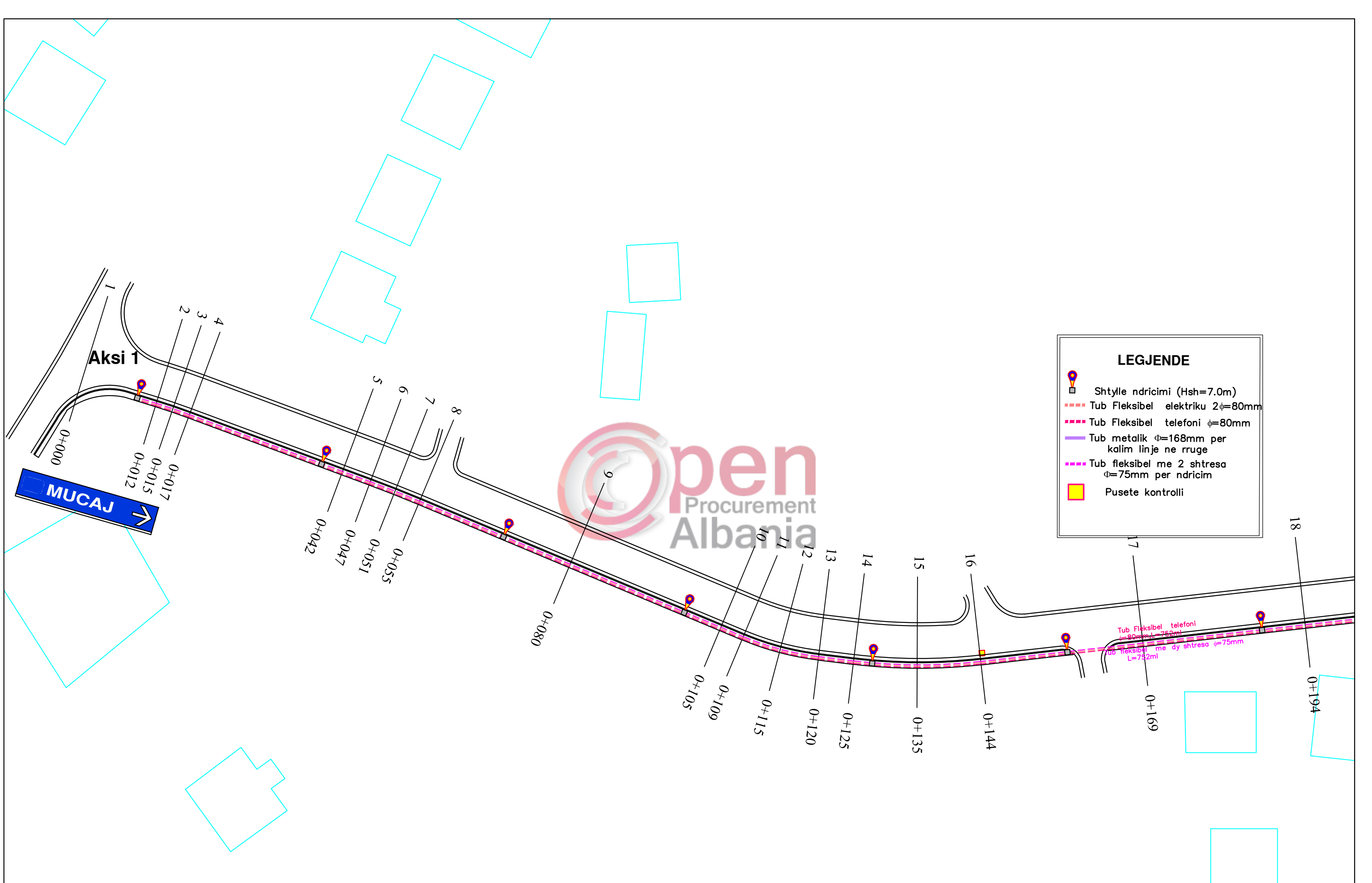

**POROSITESI : BASHKIA VORË**

OBJEKTI:  
 "RIKONSTRUKSION I RRUGEVE MUCAJ, SHERAJ DHE E VESLEVE  
 FSHATI MUCAJ ,BASHKIA VORE "

Emertimi: PLANIMETRIA E NDRICIMIT

**"ARABEL - STUDIO" Sh.p.k**  
 Adresa: Njesia Bashkiake nr.7, Rruga "Frosina Plaku",  
 Pallati 21, Hyrja 1, Kati 2, Tirane.  
 Email: arabelstudio@gmail.com

Drejtesues i projektit

Adm. Ana NISHKU  
 Inxh. Ardi ARKAXHIU

Projektues

Nd. Ardi ARKAXHIU	Elek. Altin ALLKAJ
Ark.Rigert HYRA	Top. Mustafa HOXHAI
Gjeo.Irfan BEGAJ	Hid. Hajredin MURGU

<b>SHKALLA</b>	<b>FLETA</b>
1 : 500	11 -01
Vorë 2019	Format A3

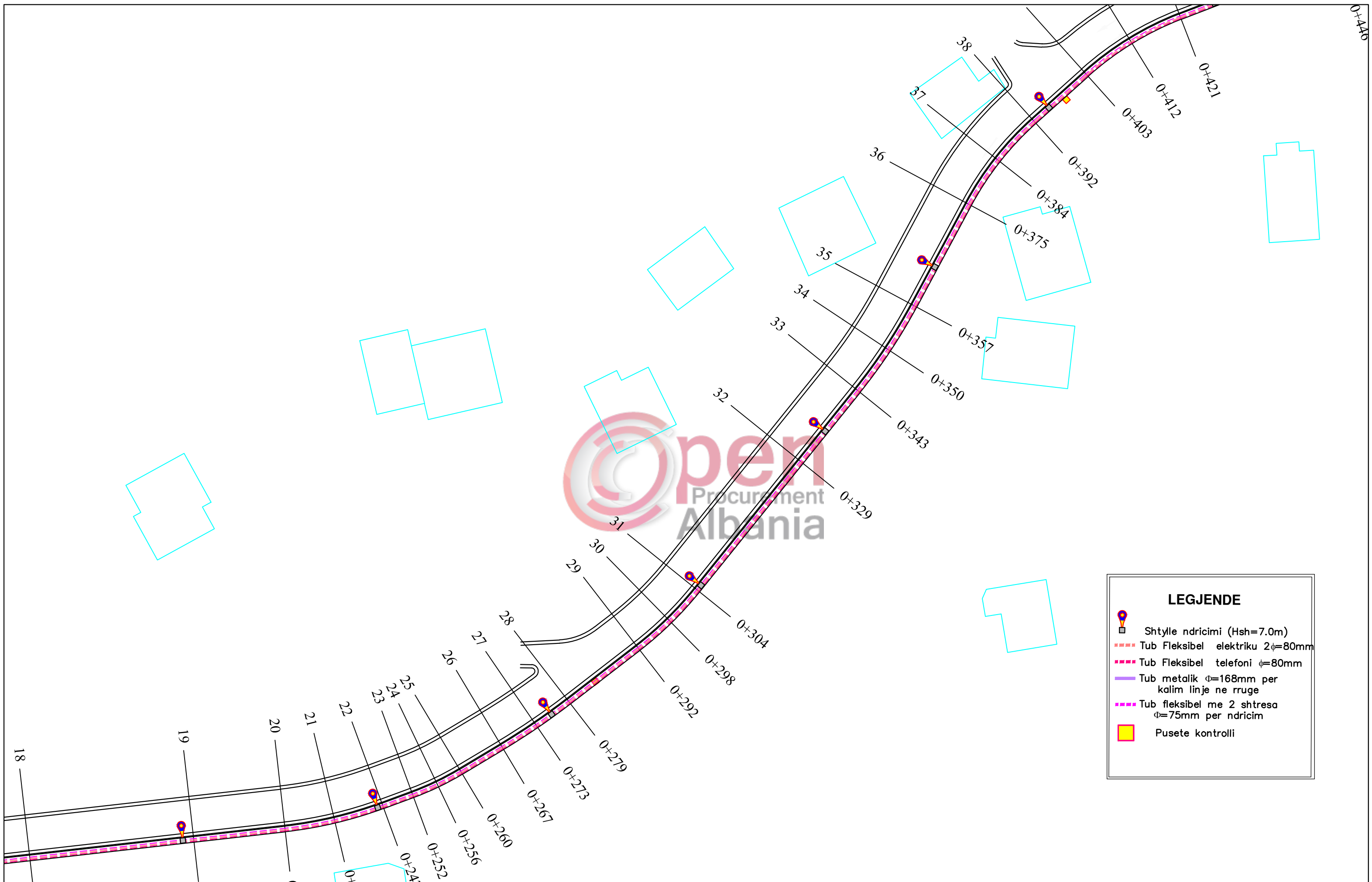

**LEGJENDE**

- Shtyle ndricimi (Hsh=7.0m)
- Tub Fleksibel elektrik 2φ=80mm
- Tub Fleksibel telefoni φ=80mm
- Tub metalik φ=168mm per kalim linje ne rruge
- Tub fleksibel me 2 shtresa φ=75mm per ndricim
- Pusete kontrolli



**POROSITESI : BASHKIA VORË**

OBJEKTI:  
"RIKONSTRUKSION I RRUGEVE MUCAJ, SHERAJ DHE E VESLEVE  
FSHATI MUCAJ ,BASHKIA VORE "

Emertimi: PLANIMETRIA E NDRICIMIT

**"ARABEL - STUDIO" Sh.p.k**  
Adresa: Njesia Bashkiake nr.7, Rruga "Frosina Plaku",  
Pallati 21, Hyrja 1, Kati 2, Tirane.  
Email: arabelstudio@gmail.com

Drejtesues i projektit

Adm. Ana NISHKU  
Inxh. Ardi ARKAXHIU

Projektues

Nd. Ardi ARKAXHIU	Elek. Altin ALLKAJ
Ark.Rigert HYRA	Top. Mustafa HOXHAJ
Gjeo.Irfan BEGAJ	Hid. Hajredin MURGU

SHKALLA	FLETA
1 : 500	11 -02
Vorë 2019	Format A3

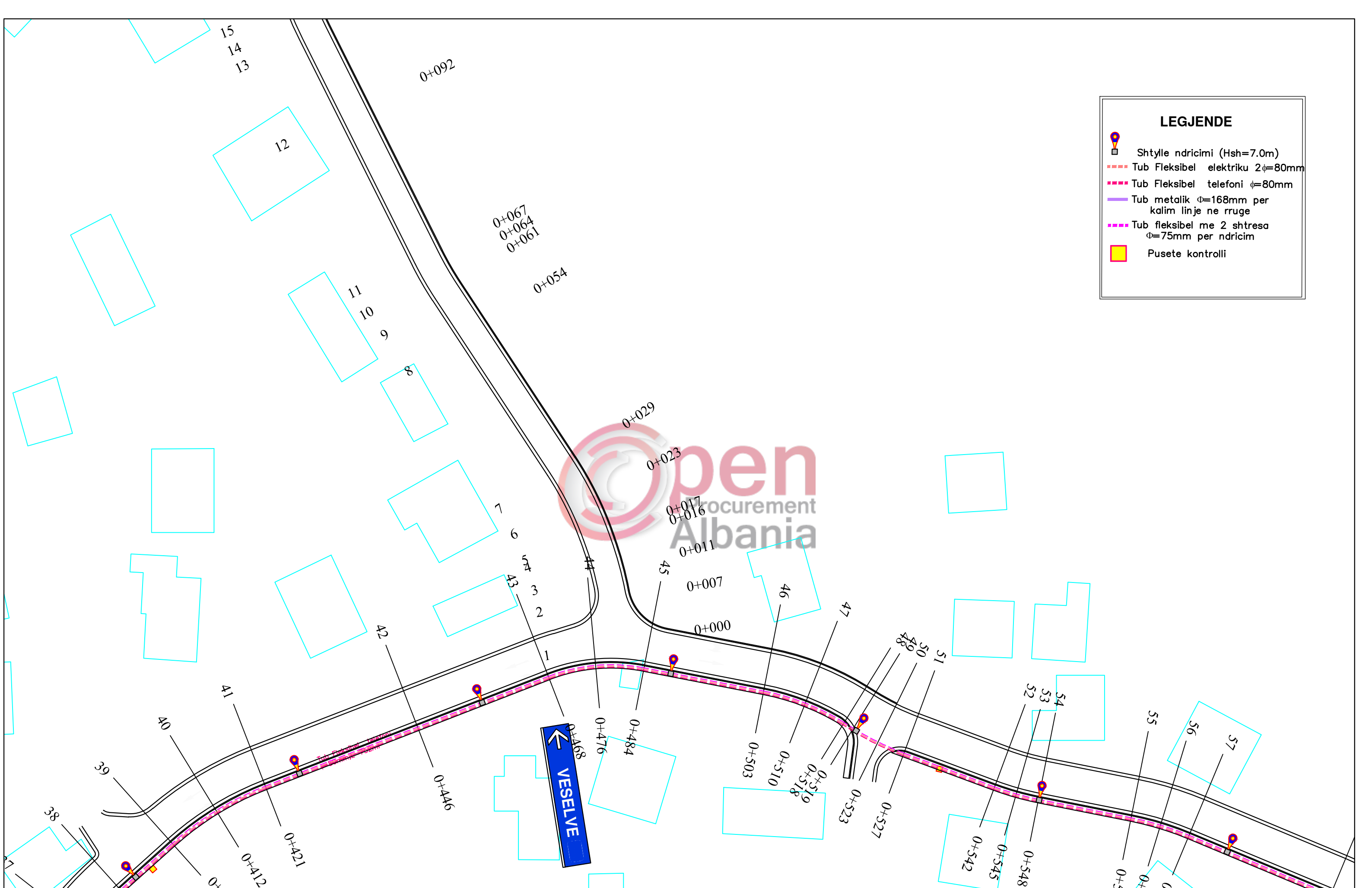

**LEGJENDE**

- Shtyle ndricimi (Hsh=7.0m)
- Tub Fleksibel elektrik 2φ=80mm
- Tub Fleksibel telefoni φ=80mm
- Tub metalik φ=168mm per kalim linje ne rruge
- Tub fleksibel me 2 shtresa φ=75mm per ndricim
- Pusete kontrolli



**POROSITESI : BASHKIA VORË**

OBJEKTI:  
 "RIKONSTRUKSION I RRUGEVE MUCAJ, SHERAJ DHE E VESLEVE  
 FSHATI MUCAJ ,BASHKIA VORE "

Emertimi: PLANIMETRIA E NDRICIMIT

**"ARABEL - STUDIO" Sh.p.k**  
 Adresa: Njesia Bashkiake nr.7, Rruga "Frosina Plaku",  
 Pallati 21, Hyrja 1, Kati 2, Tirane.  
 Email: arabelstudio@gmail.com

**Drejtesues i projektit**

Adm. Ana NISHKU  
 Inxh. Ardi ARKAXHIU

**Projektues**

Nd. Ardi ARKAXHIU	Elek. Altin ALLKAJ
Ark.Rigert HYRA	Top. Mustafa HOXHAI
Gjeo.Irfan BEGAJ	Hid. Hajredin MURGU

<b>SHKALLA</b>	<b>FLETA</b>
1 : 500	11 -03
Vorë 2019	Format A3

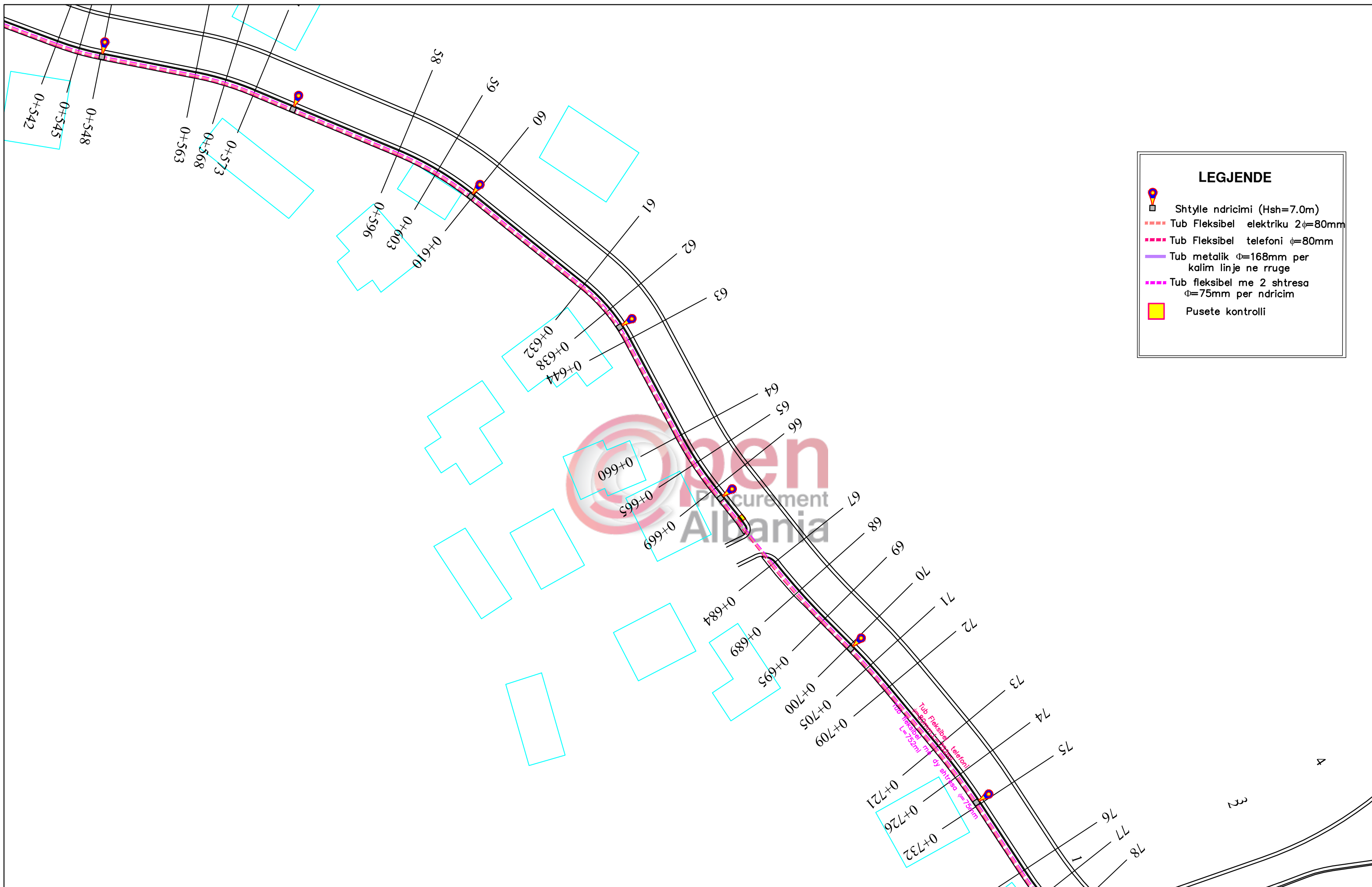

**LEGJENDE**

- Shtyle ndricimi (Hsh=7.0m)
- Tub Fleksibel elektrik 2φ=80mm
- Tub Fleksibel telefoni φ=80mm
- Tub metalik φ=168mm per kalim linje ne rruge
- Tub fleksibel me 2 shtresa φ=75mm per ndricim
- Pusete kontrolli



**POROSITESI : BASHKIA VORË**

OBJEKTI:  
 "RIKONSTRUKSION I RRUGEVE MUCAJ, SHERAJ DHE E VESLEVE  
 FSHATI MUCAJ ,BASHKIA VORE "

Emertimi: PLANIMETRIA E NDRICIMIT

**"ARABEL - STUDIO" Sh.p.k**  
 Adresa: Njesia Bashkiake nr.7, Rruga "Frosina Plaku",  
 Pallati 21, Hyrja 1, Kati 2, Tirane.  
 Email: arabelstudio@gmail.com

Drejtesues i projektit

Adm. Ana NISHKU  
 Inxh. Ardi ARKAXHIU

Projektues

Nd. Ardi ARKAXHIU	Elek. Altin ALLKAJ
Ark.Rigert HYRA	Top. Mustafa HOXHAJ
Gjeo.Irfan BEGAJ	Hid. Hajredin MURGU

<b>SHKALLA</b>	<b>FLETA</b>
1 : 500	11 -05
Vorë 2019	Format A3



**LEGJENDE**

- Shtyle ndricimi (Hsh=7.0m)
- Tub Fleksibel elektrik 2φ=80mm
- Tub Fleksibel telefoni φ=80mm
- Tub metalik φ=168mm per kalim linje ne rruge
- Tub fleksibel me 2 shtresa φ=75mm per ndricim
- Pusete kontrolli



**POROSITESI : BASHKIA VORË**

OBJEKTI:  
"RIKONSTRUKSION I RRUGEVE MUCAJ,SHERAJ DHE E VESLEVE  
FSHATI MUCAJ ,BASHKIA VORE "



Emertimi: PLANIMETRIA E NDRICIMIT  
"ARABEL - STUDIO" Sh.p.k  
Adresa:Njesia Bashkiake nr.7, Rruga "Frosina Plaku",  
Pallati 21, Hyrja 1, Kati 2,Tirane.  
Email: arabelstudio@gmail.com

**Drejtues i projektit**

Adm. Ana NISHKU  
Inxh. Ardi ARKAXHIU

**Projektues**

Nd. Ardi ARKAXHIU	Elek. Altin ALLKAJ
Ark.Rigert HYRA	Top. Mustafa HOXHAI
Gjeo.Irfan BEGAJ	Hid. Hajredin MURGU

**SHKALLA FLETA**

1 : 500	11 -06
Vorë 2019	Format A3



# PROJEKT ZBATIMI

## OBJEKTI:

"RIKONSTRUKSION I RRUGEVE MUCAJ, SHERAJ DHE E VESLEVE  
FSHATI MUCAJ , BASHKIA VORE "

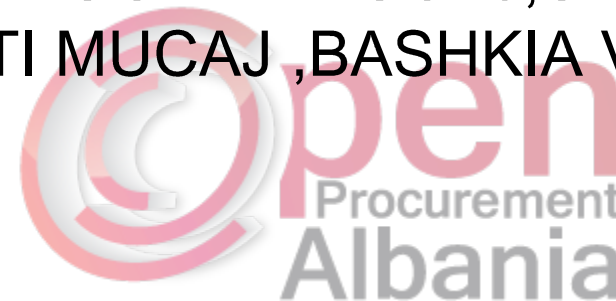

## 10.PLANIMETRIA E SINJALISTIKES



**POROSITESI : BASHKIA VORË**

OBJEKTI:  
"RIKONSTRUKSION I RRUGEVE MUCAJ, SHERAJ DHE E VESLEVE  
FSHATI MUCAJ , BASHKIA VORE "

Emertimi: PLANIMETRIA E SINJALISTIKES



"ARABEL - STUDIO" Sh.p.k  
Adresa: Njesia Bashkiake nr.7, Rruga "Frosina Plaku",  
Pallati 21, Hyrja 1, Kati 2, Tirane.  
Email: arabelstudio@gmail.com

Drejtues i projektit

Adm. Ana NISHKU  
Inxh. Ardi ARKAXHIU

Projektues

Nd. Ardi ARKAXHIU  
Ark.Rigert HYRA  
Gjeo.Irfan BEGAJ  
Elek. Altin ALLKAJ  
Top. Mustafa HOXHAJ  
Hid. Hajredin MURGU

SHKALLA FLETA

1 : 500

10-

Vorë 2019 Format A3

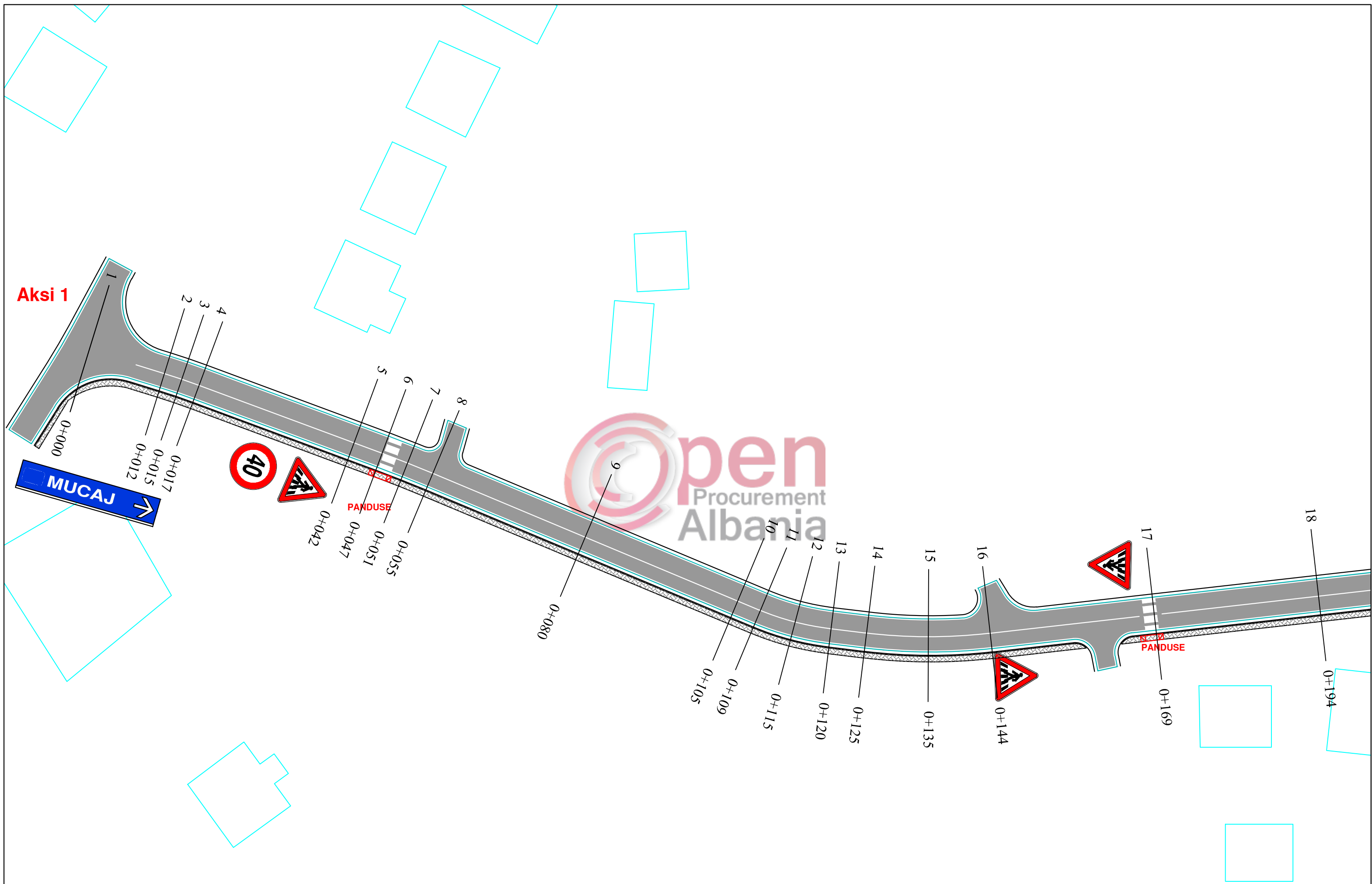

**POROSITESI : BASHKIA VORË**

OBJEKTI:  
 "RIKONSTRUKSION I RRUGEVE MUCAJ, SHERAJ DHE E VESLEVE  
 FSHATI MUCAJ ,BASHKIA VORE "



Emertimi: PLANIMETRIA E SINJALISTIKES  
**"ARABEL - STUDIO" Sh.p.k**  
 Adresa: Njesia Bashkiake nr.7, Rruga "Frosina Plaku",  
 Pallati 21, Hyrja 1, Kati 2, Tirane.  
 Email: arabelstudio@gmail.com

**Drejtues i projektit**

Adm. Ana NISHKU  
 Inxh. Ardi ARKAXHIU

**Projektues**

Nd. Ardi ARKAXHIU	Elek. Altin ALLKAJ
Ark.Rigert HYRA	Top. Mustafa HOXHAJ
Gjeo.Irfan BEGAJ	Hid. Hajredin MURGU

**SHKALLA**

1 : 500  
 Vorë 2019

**FLETA**

10- 01  
 Format A3

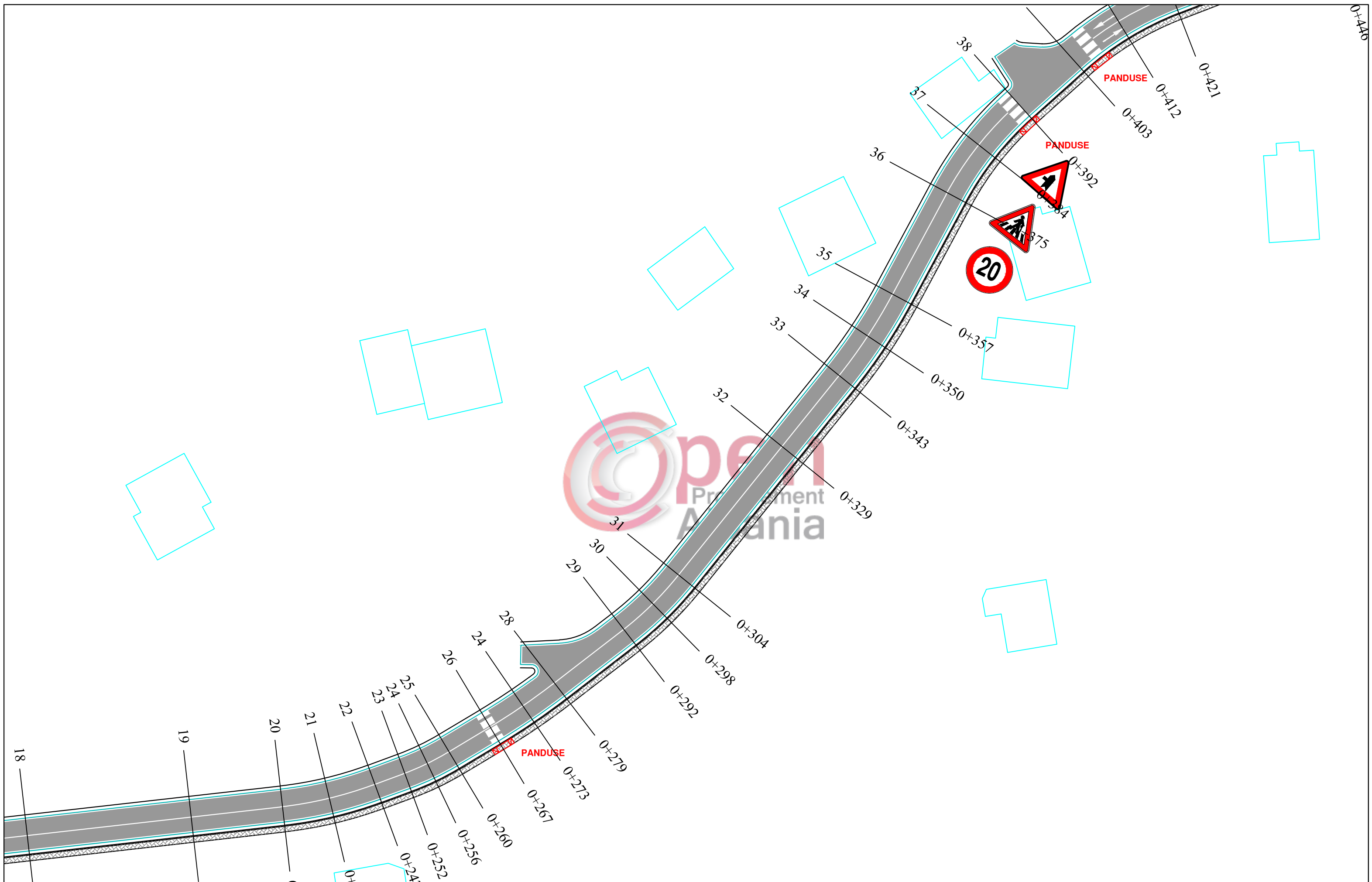

**POROSITESI : BASHKIA VORË**

OBJEKTI:  
 "RIKONSTRUKSION I RRUGEVE MUCAJ, SHERAJ DHE E VESLEVE  
 FSHATI MUCAJ ,BASHKIA VORE "

Emertimi: PLANIMETRIA E SINJALISTIKES

**"ARABEL - STUDIO" Sh.p.k**  
 Adresa: Njesia Bashkiake nr.7, Rruga "Frosina Plaku",  
 Pallati 21, Hyrja 1, Kati 2, Tirane.  
 Email: arabelstudio@gmail.com



Drejtues i projektit

Adm. Ana NISHKU

Inxh. Ardi ARKAXHIU

Projektues

Nd. Ardi ARKAXHIU	Elek. Altin ALLKAJ
Ark.Rigert HYRA	Top. Mustafa HOXHAI
Gjeo.Irfan BEGAJ	Hid. Hajredin MURGU

SHKALLA	FLETA
1 : 500	10- 02
Vorë 2019	Format A3

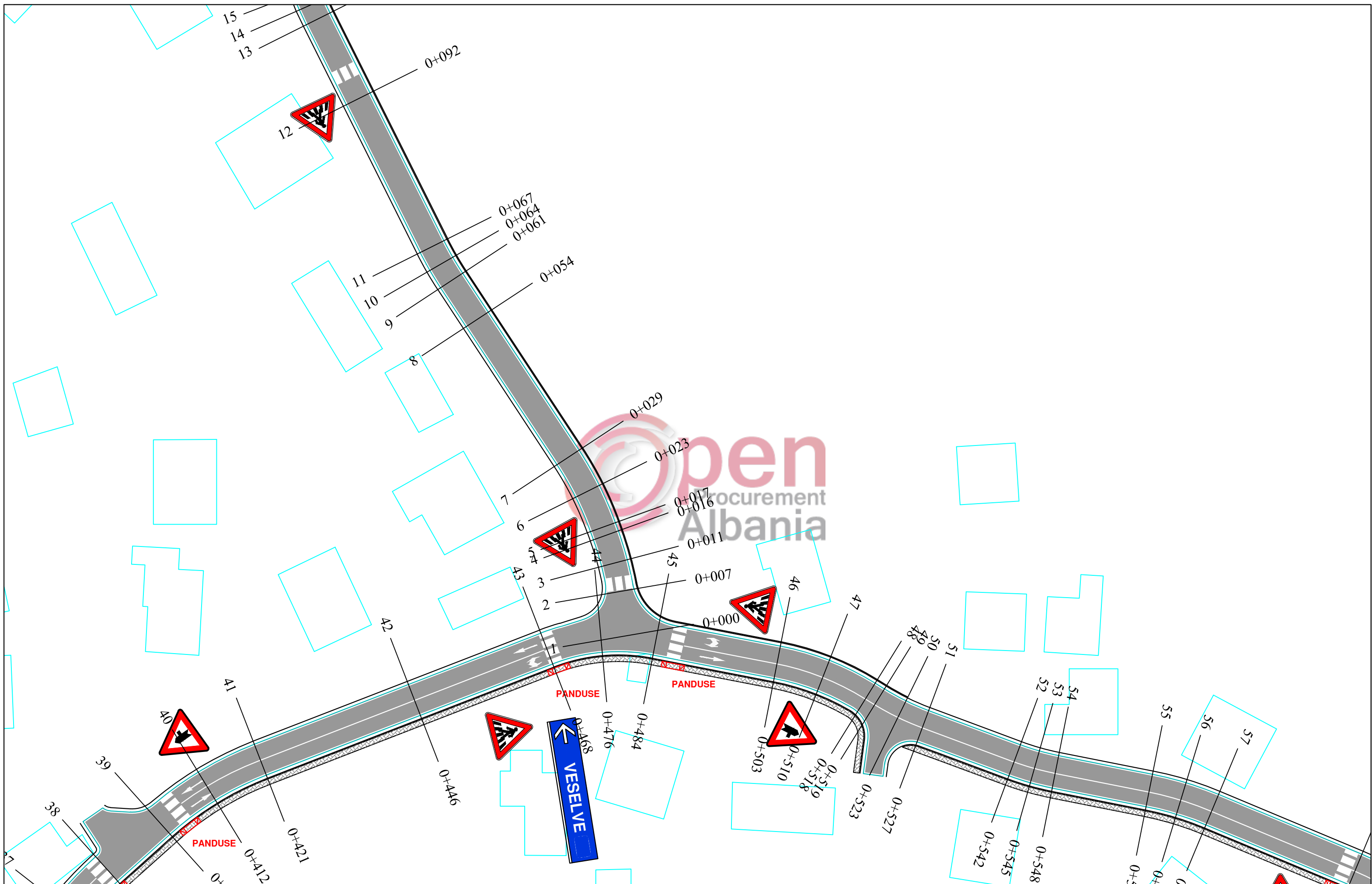

**POROSITESI : BASHKIA VORË**

OBJEKTI:  
 "RIKONSTRUKSION I RRUGEVE MUCAJ, SHERAJ DHE E VESLEVE  
 FSHATI MUCAJ ,BASHKIA VORE "

Emertimi: PLANIMETRIA E SINJALISTIKES

**"ARABEL - STUDIO" Sh.p.k**

Adresa: Njesia Bashkiake nr.7, Rruga "Frosina Plaku",  
 Pallati 21, Hyrja 1, Kati 2, Tirane.  
 Email: arabelstudio@gmail.com

Drejtesues i projektit

Adm. Ana NISHKU

Inxh. Ardi ARKAXHIU

Projektues

Nd. Ardi ARKAXHIU	Elek. Altin ALLKAJ
Ark.Rigert HYRA	Top. Mustafa HOXHAI
Gjeo.Irfan BEGAJ	Hid. Hajredin MURGU

SHKALLA	FLETA
1 : 500	10- 03
Vorë 2019	Format A3

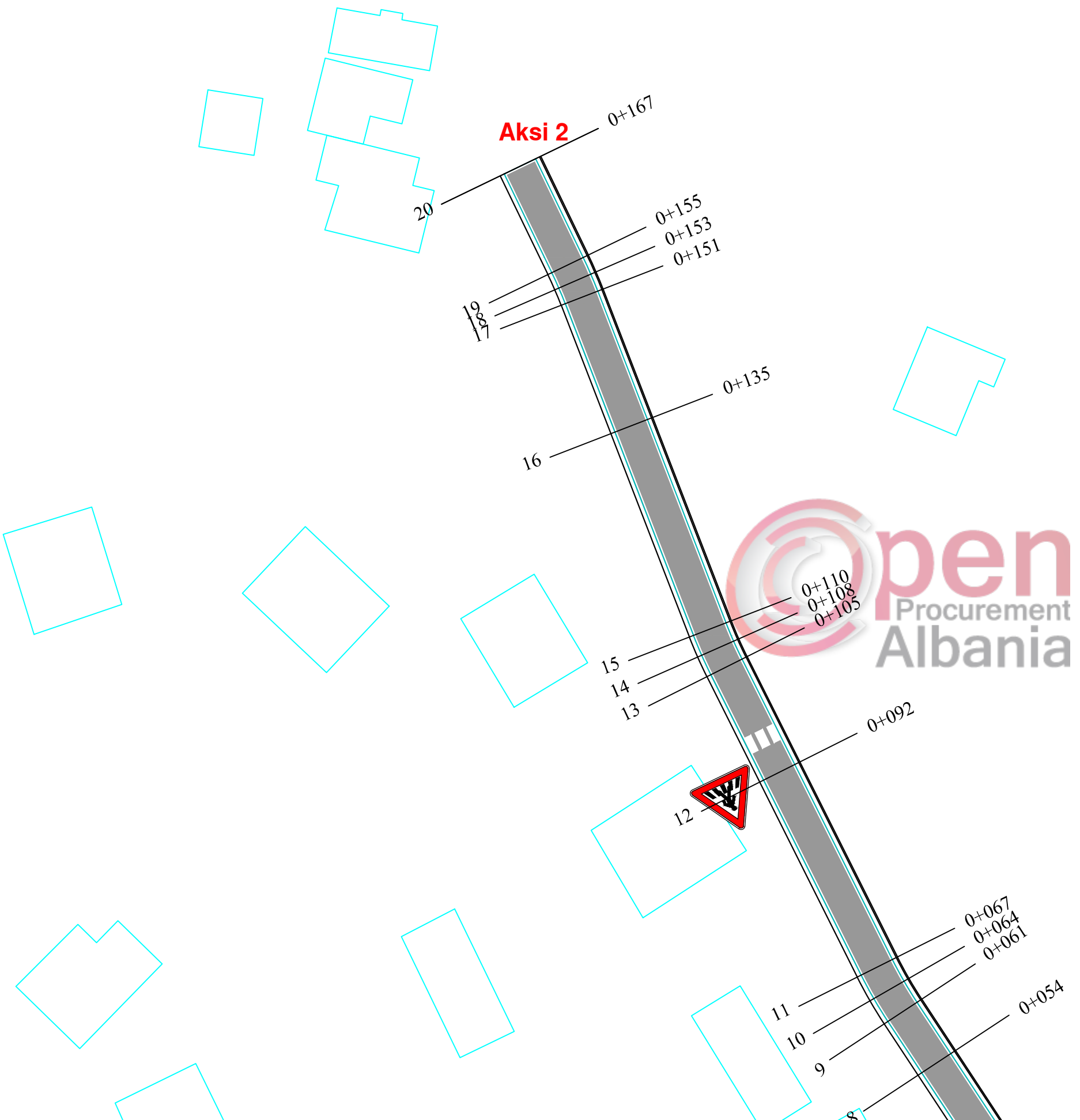

**POROSITESI : BASHKIA VORË**

OBJEKTI:  
 "RIKONSTRUKSION I RRUGEVE MUCAJ,SHERAJ DHE E VESLEVE  
 FSHATI MUCAJ ,BASHKIA VORE "

Emertimi: PLANIMETRIA E SINJALISTIKES

**"ARABEL - STUDIO" Sh.p.k**  
 Adresa:Njesia Bashkiake nr.7, Rruga "Frosina Plaku",  
 Pallati 21, Hyrja 1, Kati 2,Tirane.  
 Email: arabelstudio@gmail.com

Drejtues i projektit

Adm. Ana NISHKU

Inxh. Ardi ARKAXHIU

Projektues

Nd. Ardi ARKAXHIU	Elek. Altin ALLKAJ
Ark.Rigert HYRA	Top. Mustafa HOXHAJ
Gjeo.Irfan BEGAJ	Hid. Hajredin MURGU

SHKALLA	FLETA
1 : 500	10- 04
Vorë 2019	Format A3

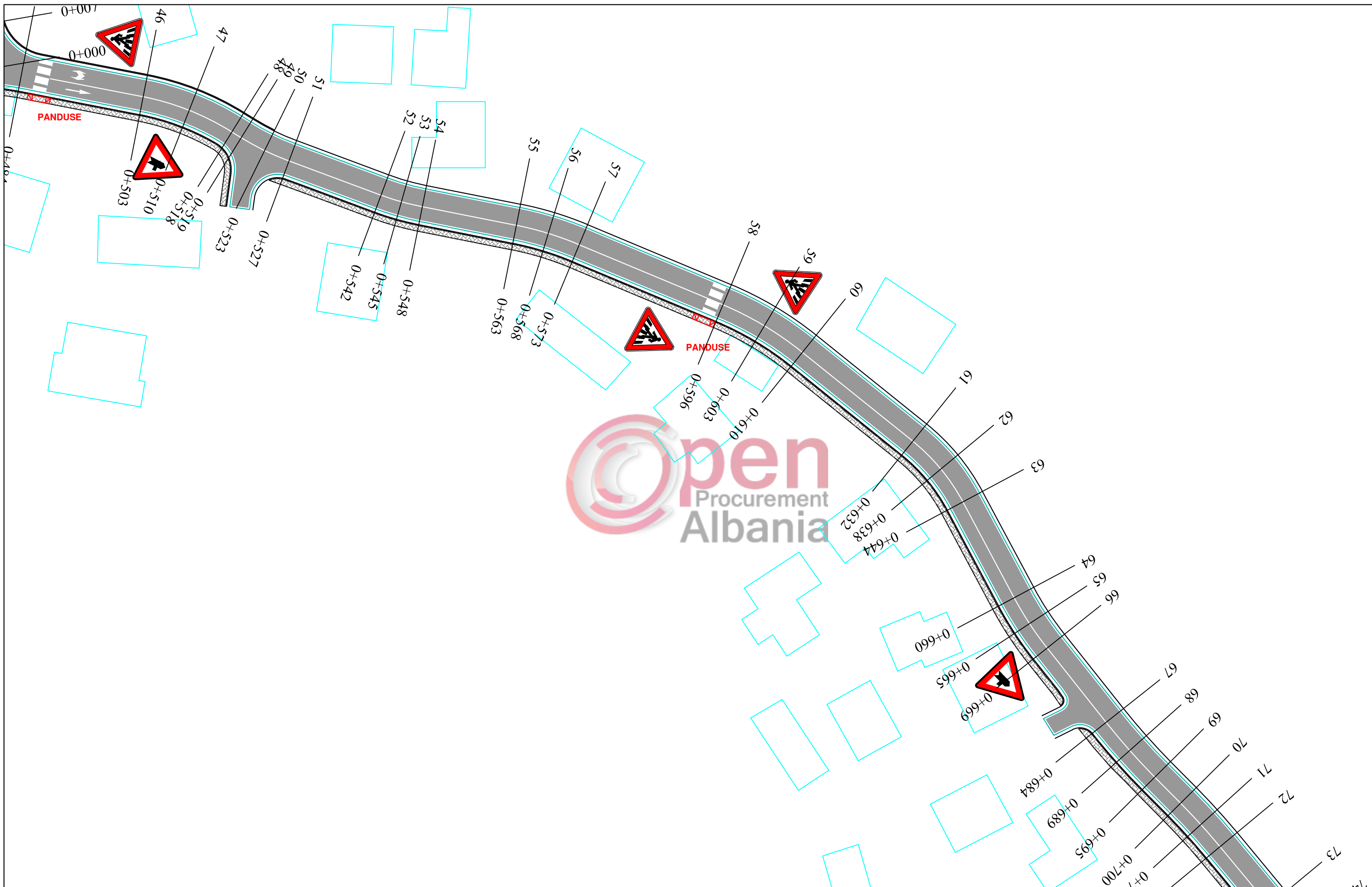

**POROSITESI : BASHKIA VORË**

OBJEKTI:  
 "RIKONSTRUKSION I RRUGEVE MUCAJ, SHERAJ DHE E VESLEVE  
 FSHATI MUCAJ ,BASHKIA VORE "

Emertimi: PLANIMETRIA E SINJALISTIKES

**"ARABEL - STUDIO" Sh.p.k**  
 Adresa:Njesia Bashkiake nr.7, Rruga "Frosina Plaku",  
 Pallati 21, Hyrja 1, Kati 2,Tirane.  
 Email: arabelstudio@gmail.com

Drejtesues i projektit

Adm. Ana NISHKU  
 Inxh. Ardi ARKAXHIU

Projektues

Nd. Ardi ARKAXHIU	Elek. Altin ALLKAJ
Ark.Rigert HYRA	Top. Mustafa HOXHAJ
Gjeo.Irfan BEGAJ	Hid. Hajredin MURGU

SHKALLA	FLETA
1 : 500	10- 05
Vorë 2019	Format A3

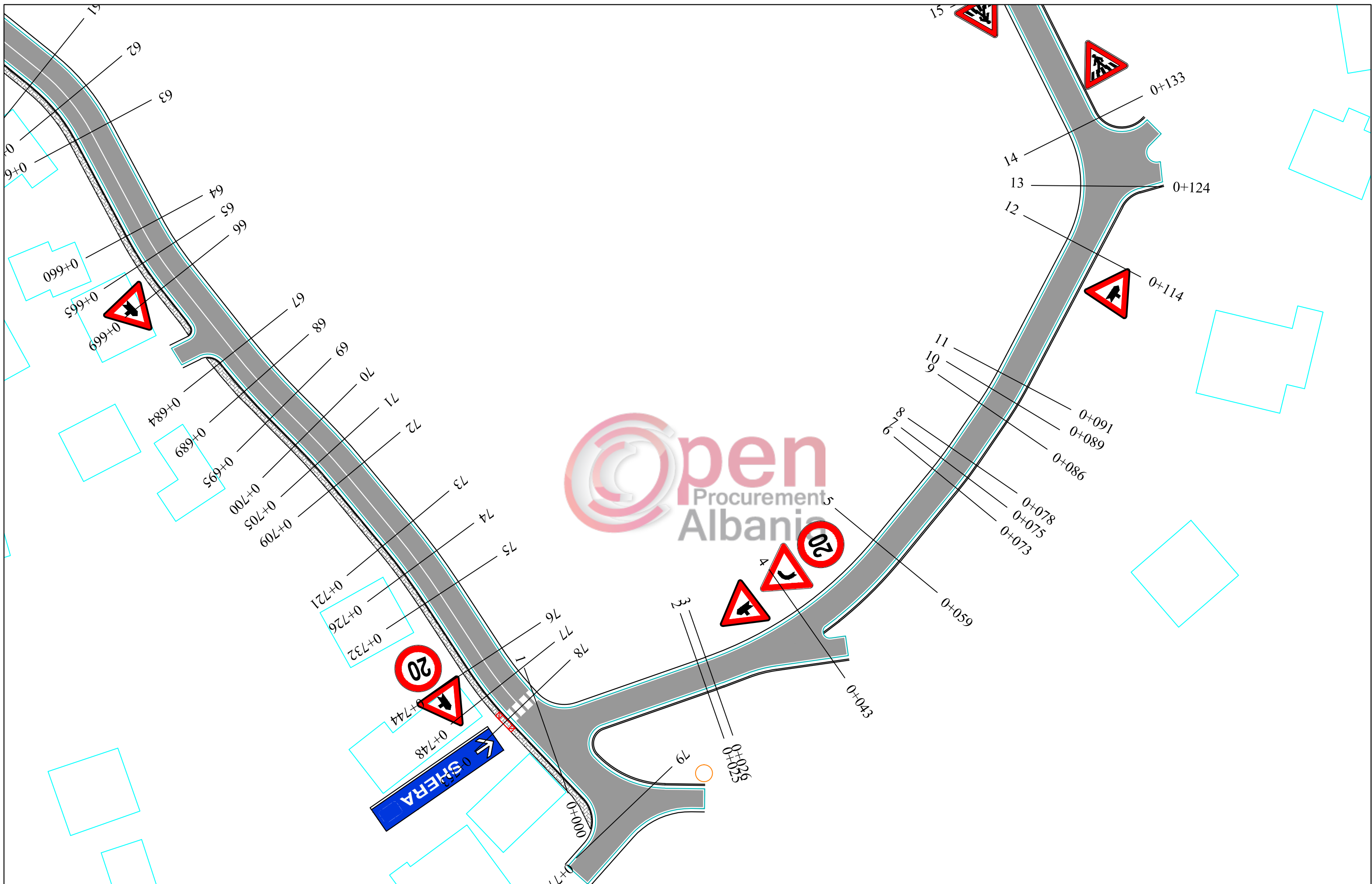

**POROSITESI : BASHKIA VORË**

OBJEKTI:  
 "RIKONSTRUKSION I RRUGEVE MUCAJ,SHERAJ DHE E VESLEVE  
 FSHATI MUCAJ ,BASHKIA VORE "



Emertimi: PLANIMETRIA E SINJALISTIKES  
**"ARABEL - STUDIO" Sh.p.k**  
 Adresa:Njesia Bashkiake nr.7, Rruga "Frosina Plaku",  
 Pallati 21, Hyrja 1, Kati 2,Tirane.  
 Email: arabelstudio@gmail.com

**Drejtesues i projektit**

Adm. Ana NISHKU  
 Inxh. Ardi ARKAXHIU

**Projektues**

Nd. Ardi ARKAXHIU	Elek. Altin ALLKAJ
Ark.Rigert HYRA	Top. Mustafa HOXHAJ
Gjeo.Irfan BEGAJ	Hid. Hajredin MURGU

**SHKALLA**

1 : 500  
 Vorë 2019

**FLETA**

10- 06  
 Format A3

**Aksi 3**

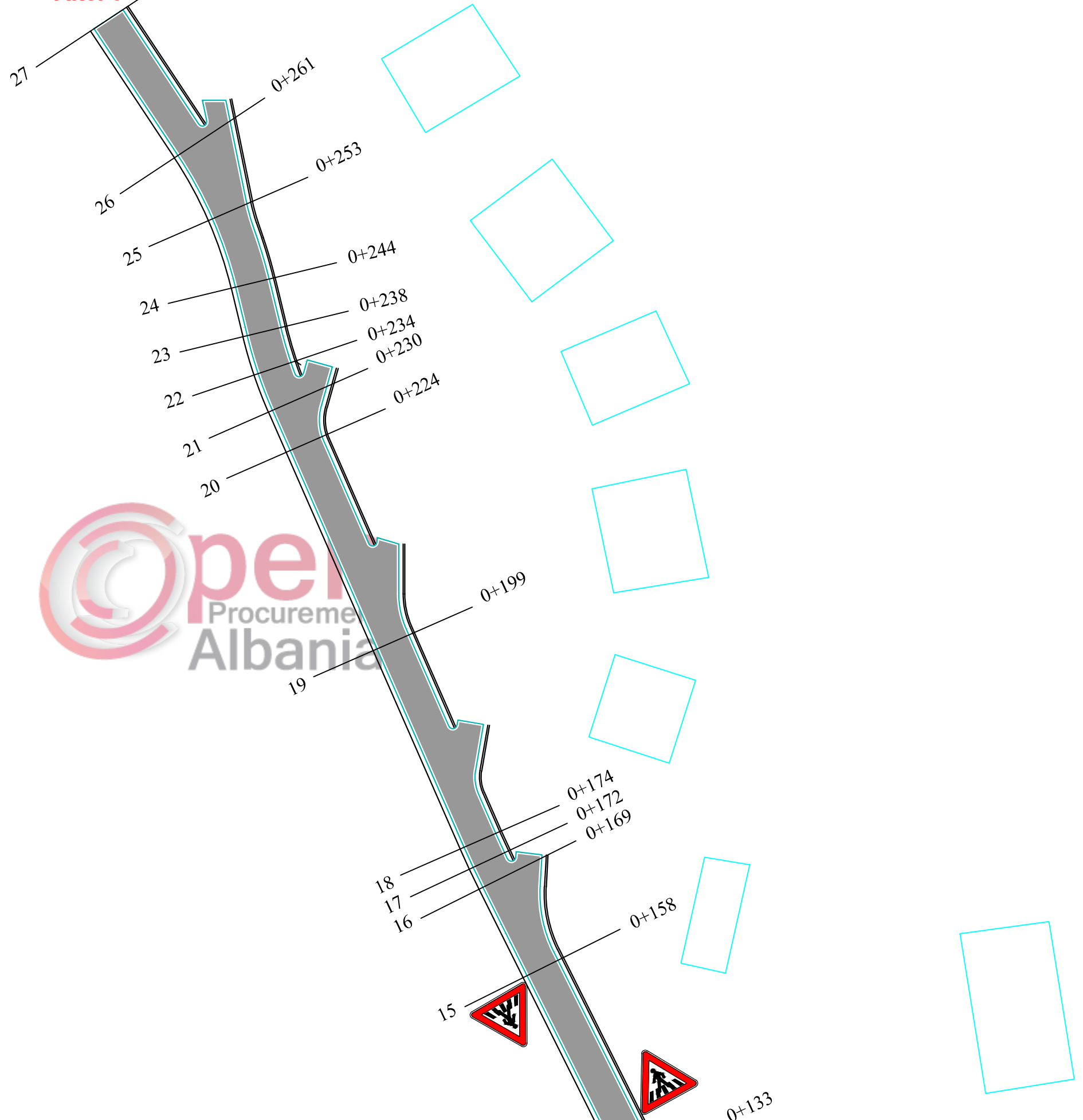

**Opere**  
Procurement  
Albania



**POROSITESI : BASHKIA VORË**  
OBJEKTI:  
"RIKONSTRUKSION I RRUGEVE MUCAJ, SHERAJ DHE E VESLEVE  
FSHATI MUCAJ ,BASHKIA VORE "

Emertimi: PLANIMETRIA E SINJALISTIKES  
**"ARABEL - STUDIO" Sh.p.k**  
Adresa: Njesia Bashkiake nr.7, Rruga "Frosina Plaku",  
Pallati 21, Hyrja 1, Kati 2, Tirane.  
Email: arabelstudio@gmail.com



**Drejtues i projektit**  
Adm. Ana NISHKU  
Inxh. Ardi ARKAXHIU

**Projektues**  
Nd. Ardi ARKAXHIU  
Ark.Rigert HYRA  
Gjeo.Irfan BEGAJ  
Elek. Altin ALLKAJ  
Top. Mustafa HOXHAJ  
Hid. Hajredin MURGU

SHKALLA	FLETA
1 : 500	10- 07
Vorë 2019	Format A3





REPUBLIKA E SHQIPERISË  
BASHKIA VORË

# PROJEKT ZBATIMI

OBJEKTI:

"RIKONSTRUKSION I RRUGEVE MUCAJ, SHERAJ DHE E VESLEVE, FSHATI MUCAJ"

BASHKIA VORË



8. PROFILI TERTHOR TIP

	<b>POROSITESI : BASHKIA VORË</b>	<b>Emertimi: PROFILI TERTHOR TIP</b>	<b>Drejtes i projektit</b>			<b>Projektues</b>			<b>SHKALLA</b>	<b>FLETA</b>
	OBJEKTI: "RIKONSTRUKSION I RRUGEVE MUCAJ, SHERAJ DHE E VESLEVE FSHATI MUCAJ ,BASHKIA VORE "	 "ARABEL - STUDIO" Sh.p.k Adresa:Njesia Bashkiake nr.7, Rruga "Frosina Plaku", Pallati 21, Hyrja 1, Kati 2,Tirane. Email: arabelstudio@gmail.com	Adm. Ana NISHKU		Nd. Ardi ARKAXHIU		Elek. Altin ALLKAJ		-	8 - 00
			Inxh. Ardi ARKAXHIU		Ark.Rigert HYRA		Top. Mustafa HOXHAJ		Vorë 2019	Format A3
					Gjeo.Irfan BEGAJ		Hid. Hajredin MURGU			

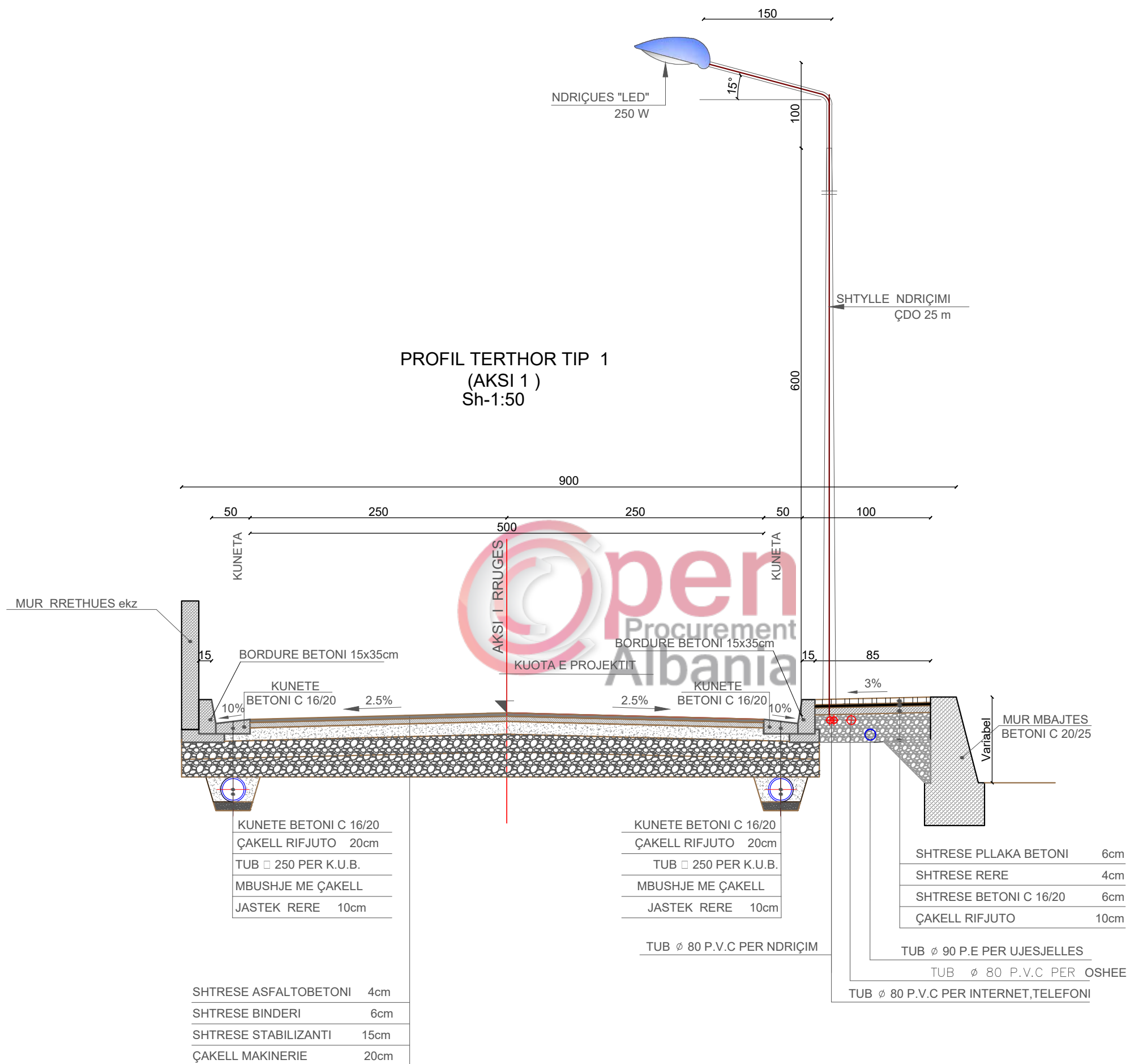

**POROSITESI : BASHKIA VORË**

OBJEKTI:  
"RIKONSTRUKSION I RRUGEVE MUCAJ, SHERAJ DHE E VESLEVE  
FSHATI MUCAJ ,BASHKIA VORE "

**Emertimi: PROFIL TERTHOR TIP**



**"ARABEL - STUDIO" Sh.p.k**  
Adresa: Njesia Bashkiake nr.7, Rruga "Frosina Plaku",  
Pallati 21, Hyrja 1, Kati 2, Tirane.  
Email: arabelstudio@gmail.com

**Drejtues i projektit**

Adm. Ana NISHKU  
Inxh. Ardi ARKAXHIU

**Projektues**

Nd. Ardi ARKAXHIU  
Ark.Rigert HYRA  
Gjeo.Irfan BEGAJ  
Elek. Altin ALLKAJ  
Top. Mustafa HOXHAI  
Hid. Hajredin MURGU

**SHKALLA**

1-50

Vorë 2019

**FLETA**

8-01

Format A3

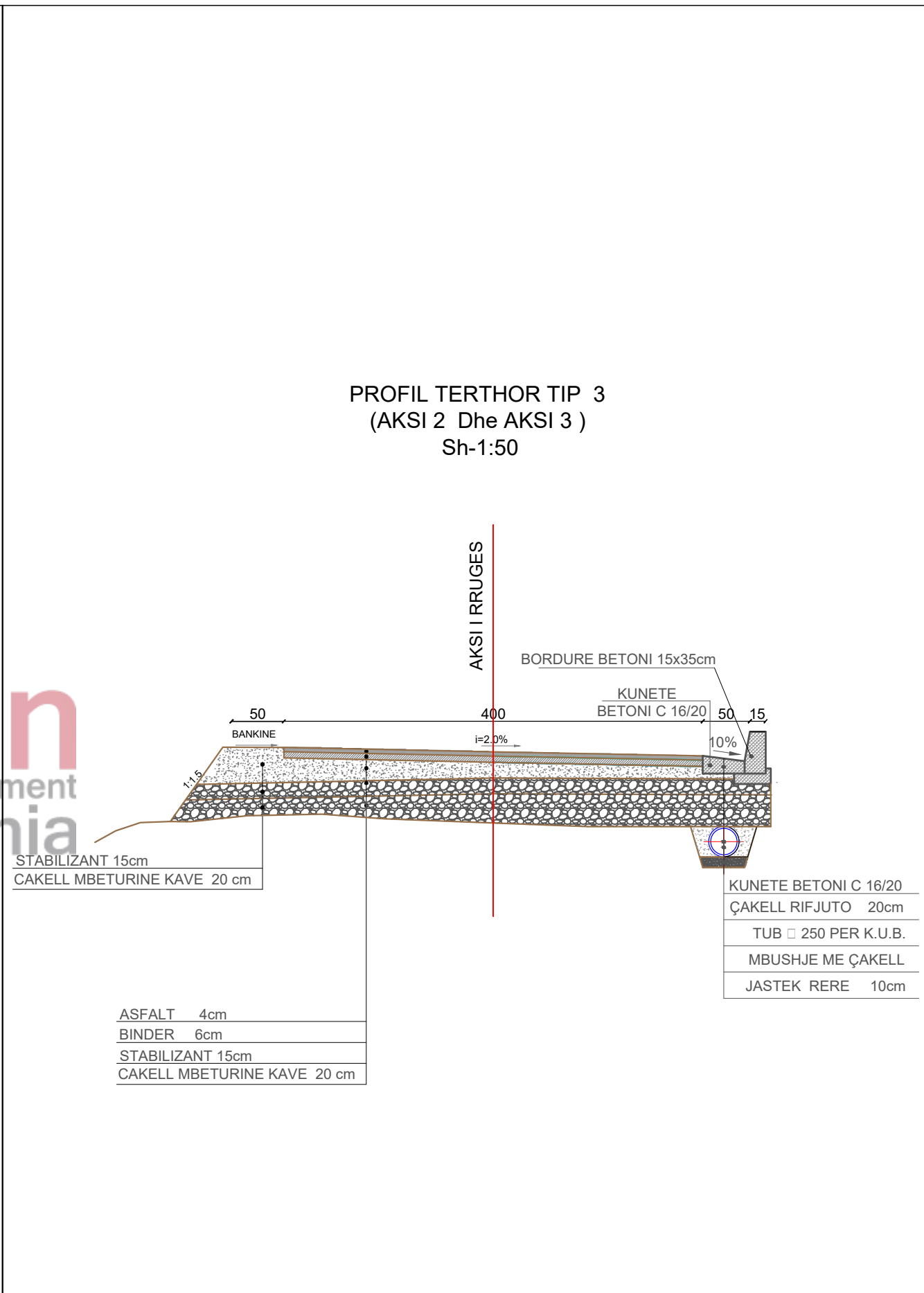
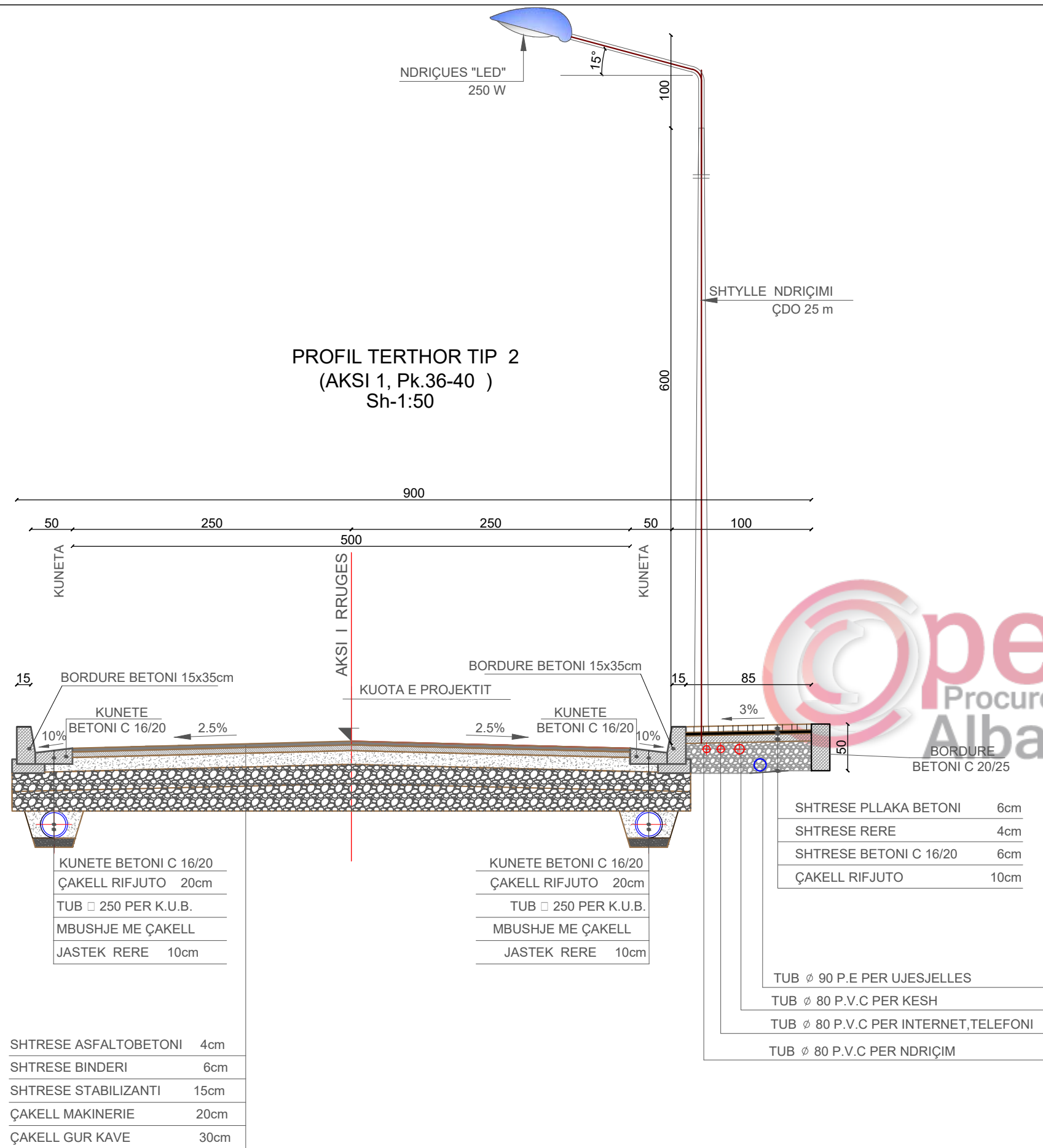

**POROSITESI : BASHKIA VORË**

OBJEKTI:  
"RIKONSTRUKSION I RRUGEVE MUCAJ, SHERAJ DHE E VESLEVE FSHATI MUCAJ ,BASHKIA VORE "

Emertimi: PROFIL TERTHOR TIP  
"ARABEL - STUDIO" Sh.p.k  
Adresa:Njesia Bashkiake nr.7, Rruga "Frosina Plaku", Pallati 21, Hyrja 1, Kati 2,Tirane.  
Email: arabelstudio@gmail.com

Drejtues i projektit  
Adm. Ana NISHKU  
Inxh. Ardi ARKAXHIU

Projektues  
Nd. Ardi ARKAXHIU  
Ark.Rigert HYRA  
Gjeo.Irfan BEGAJ

Elek. Altin ALLKAJ  
Top. Mustafa HOXHAI  
Hid. Hajredin MURGU

SHKALLA  
1-50  
Vorë 2019

FLETA  
8-02  
Format A3

# PROJEKT ZBATIMI

## OBJEKTI:

"RIKONSTRUKSION I RRUGEVE MUCAJ, SHERAJ DHE E VESLEVE  
FSHATI MUCAJ , BASHKIA VORE "

9.PROFILET TERTHORE



**POROSITESI : BASHKIA VORË**

OBJEKTI:  
"RIKONSTRUKSION I RRUGEVE MUCAJ, SHERAJ DHE E VESLEVE  
FSHATI MUCAJ , BASHKIA VORE "



Emertimi: PROFILET TERTHORE

"ARABEL - STUDIO" Sh.p.k  
Adresa: Njesia Bashkiake nr.7, Rruga "Frosina Plaku",  
Pallati 21, Hyrja 1, Kati 2, Tirane.  
Email: arabelstudio@gmail.com

Drejtues i projektit

Adm. Ana NISHKU  
Inxh. Ardi ARKAXHIU

Projektues

Nd. Ardi ARKAXHIU  
Ark.Rigert HYRA  
Gjeo.Irfan BEGAJ  
Elek. Altin ALLKAJ  
Top. Mustafa HOXHAJ  
Hid. Hajredin MURGU

SHKALLA FLETA

1 : 200

9-

Vorë 2019 Format A3

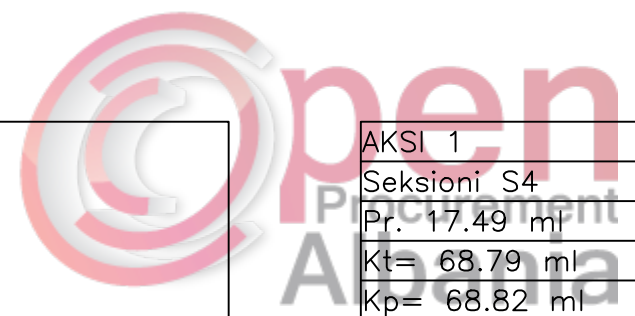
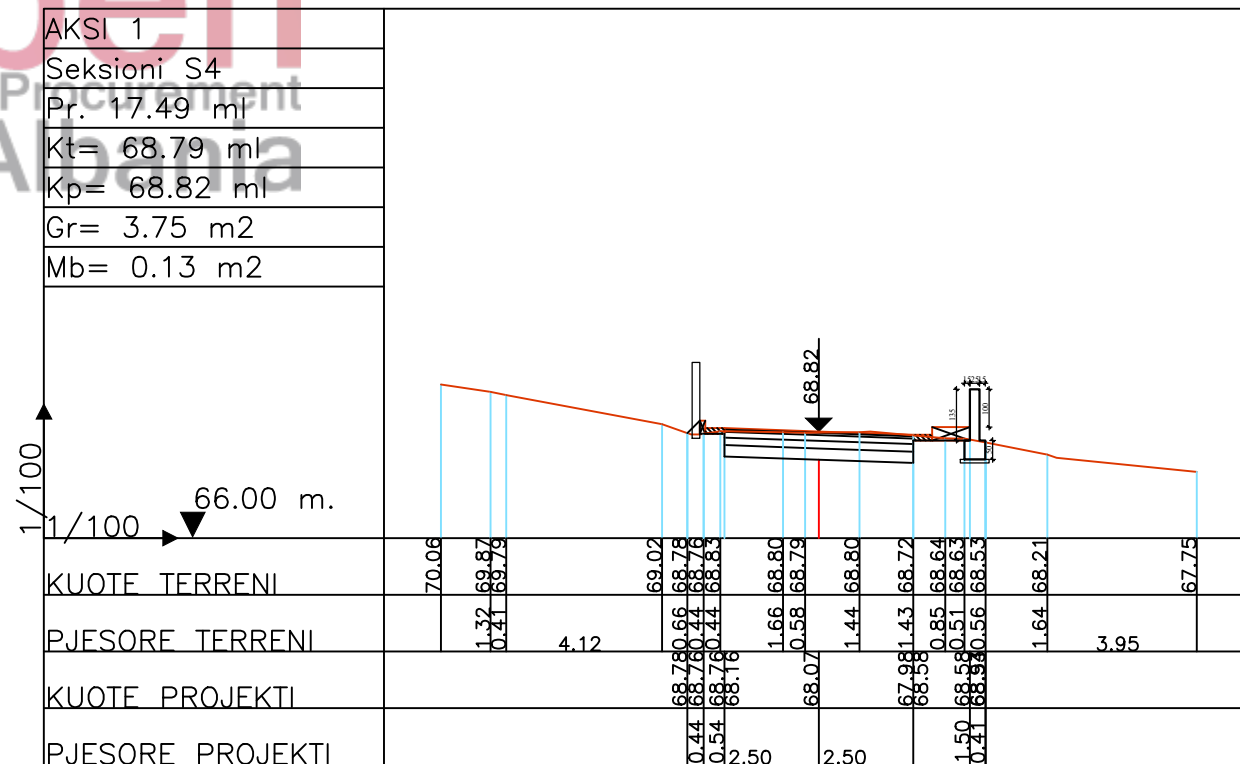
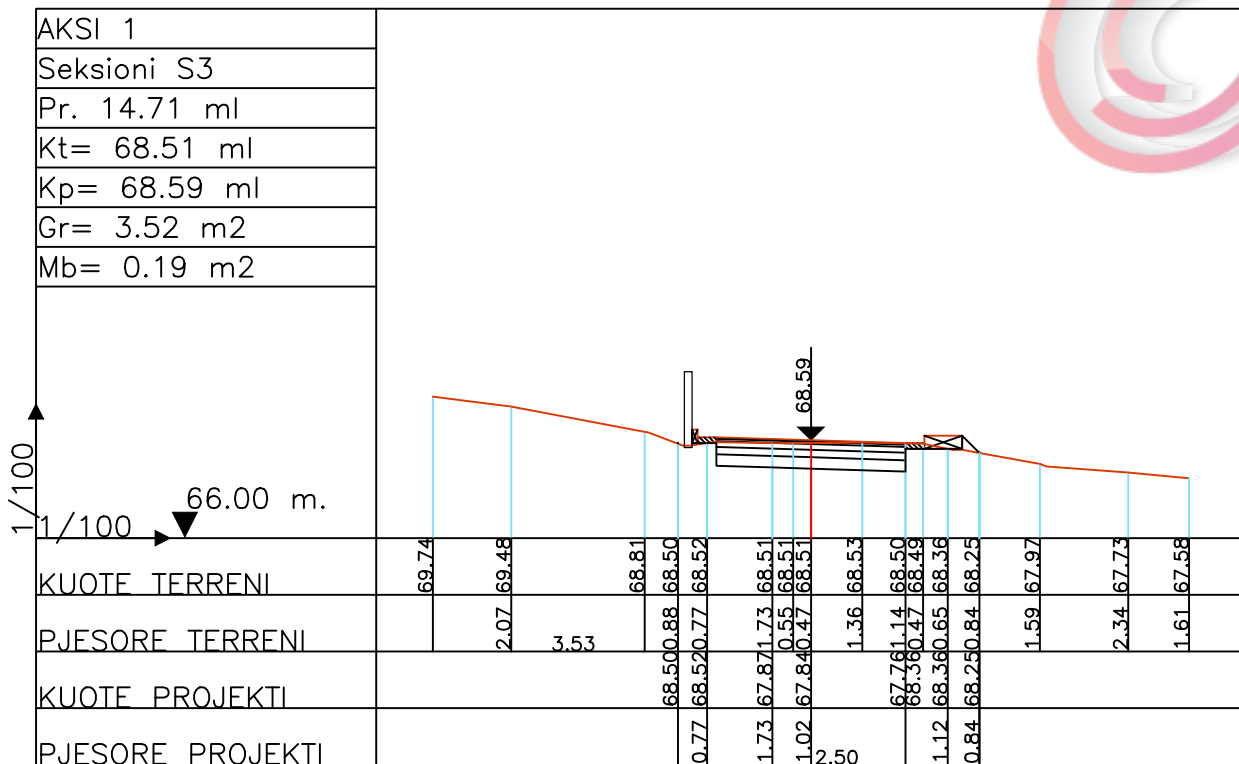
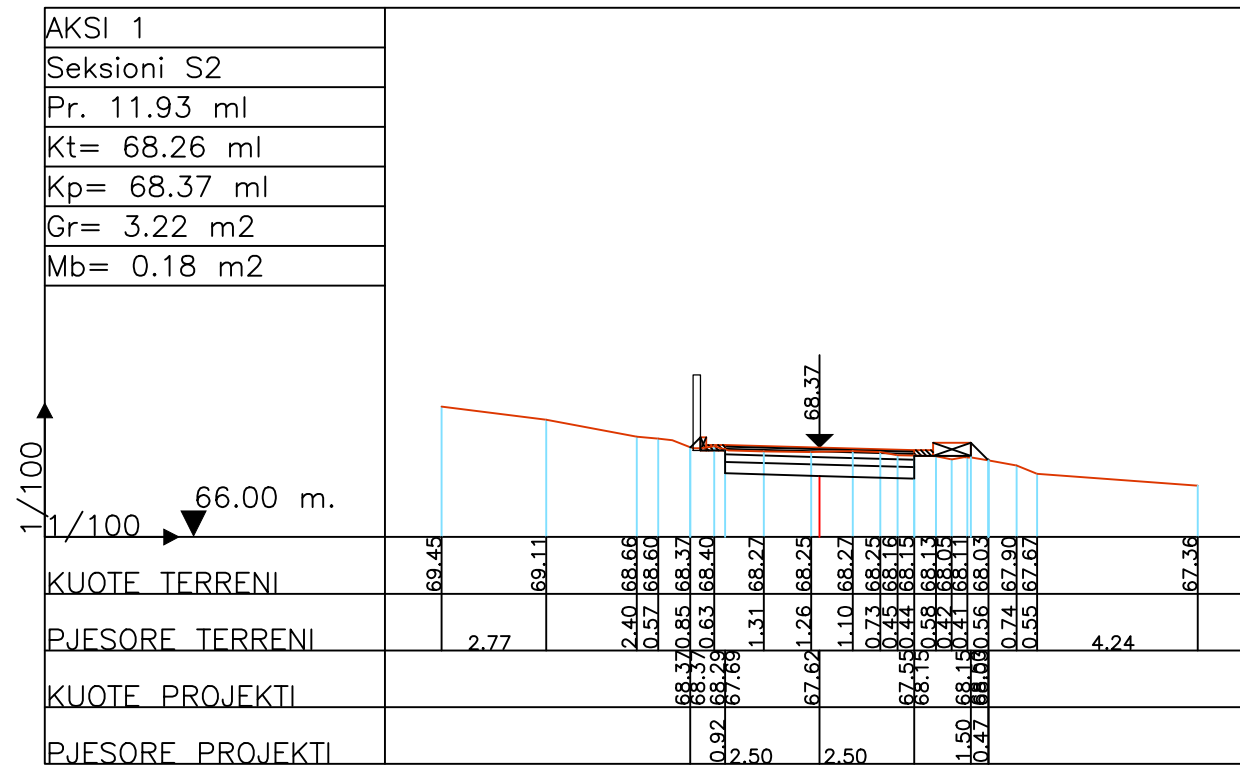
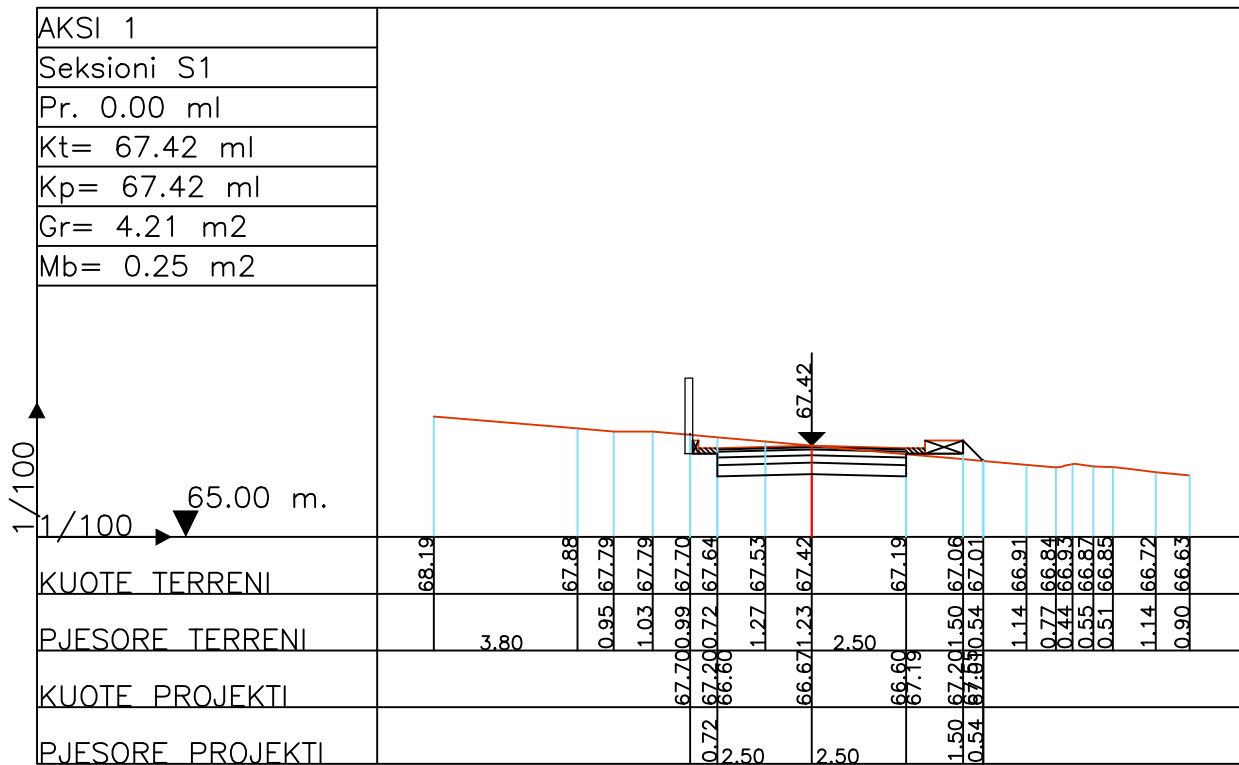

**POROSITESI : BASHKIA VORË**

OBJEKTI:  
"RIKONSTRUKSION I RRUGEVE MUCAJ, SHERAJ DHE E VESLEVE  
FSHATI MUCAJ ,BASHKIA VORE "

Emertimi: PROFILET TERTHORE

**"ARABEL - STUDIO" Sh.p.k**  
Adresa:Njesia Bashkiake nr.7, Rruga "Frosina Plaku",  
Pallati 21, Hyrja 1, Kati 2,Tirane.  
Email: arabelstudio@gmail.com

Drejtesues i projektit

Adm. Ana NISHKU	Nd. Ardi ARKAXHIU	Elek. Altin ALLKAJ
Inxh. Ardi ARKAXHIU	Ark.Rigert HYRA	Top. Mustafa HOXHAI
	Gjeo.Irfan BEGAJ	Hid. Hajredin MURGU

SHKALLA	FLETA
1 : 200	9- 02
Vorë 2019	Format A3

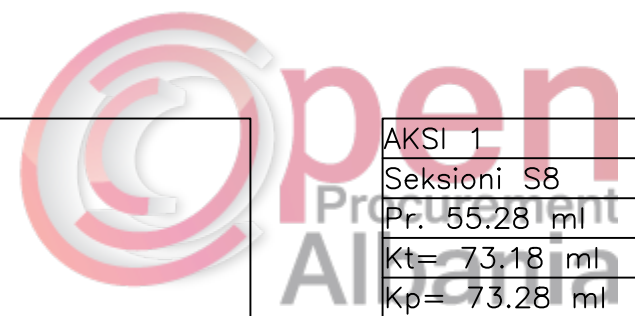
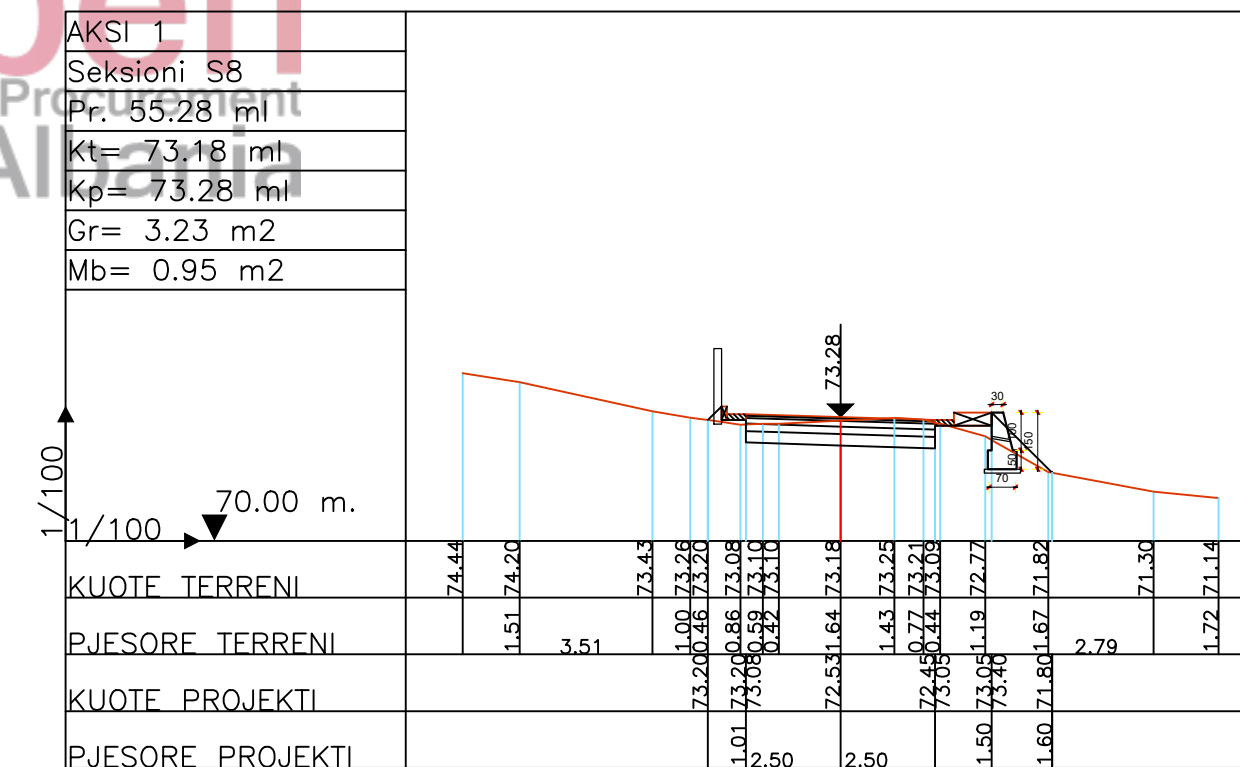
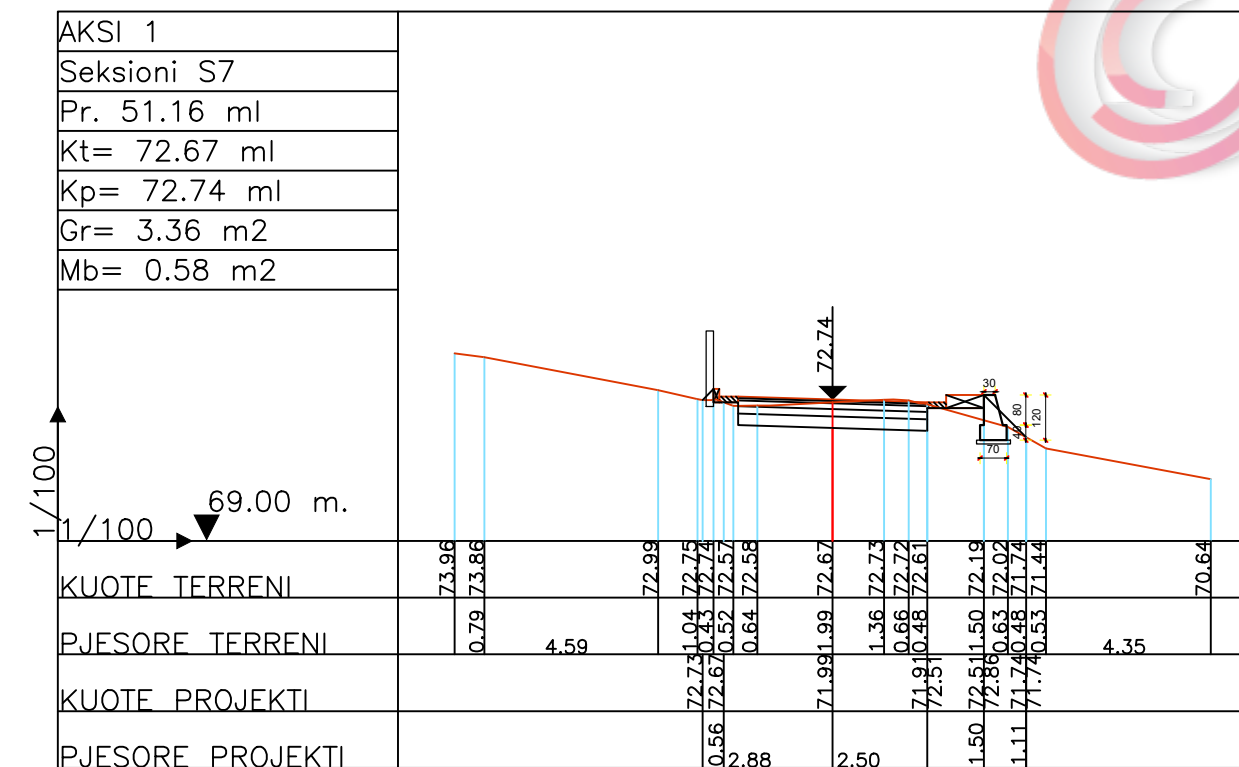
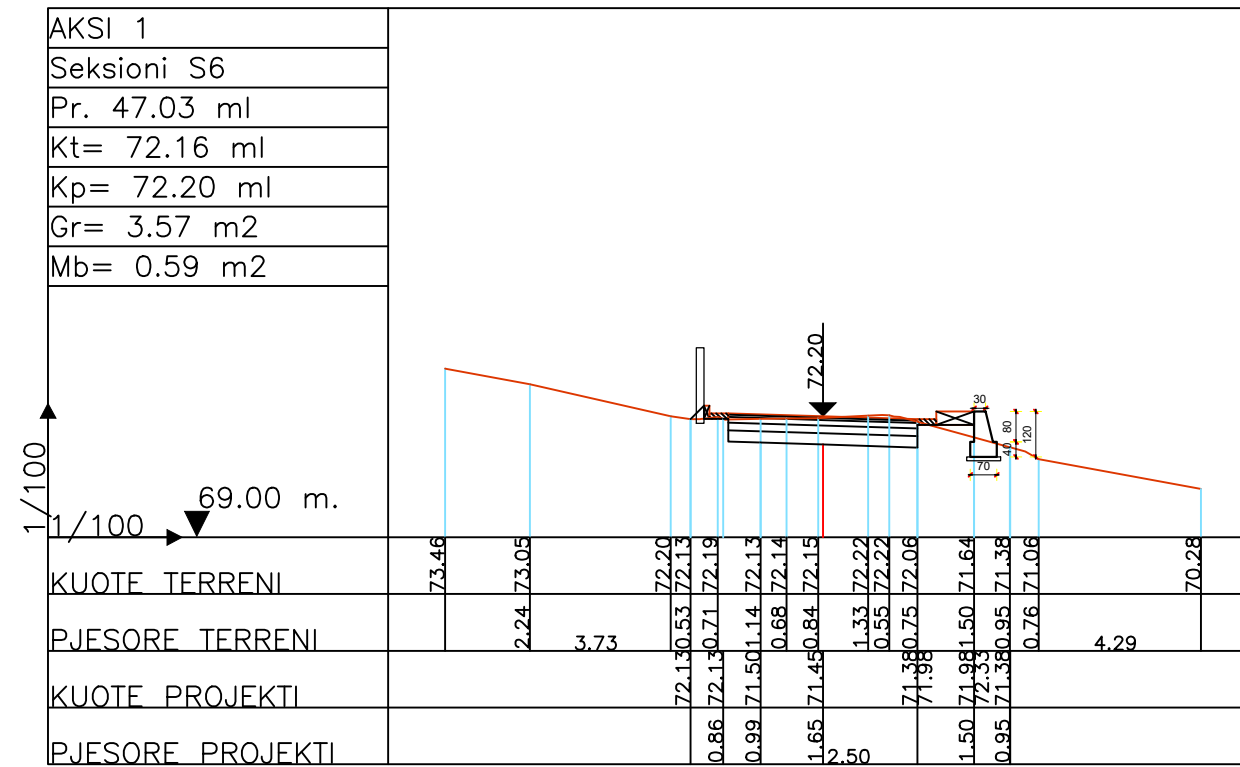
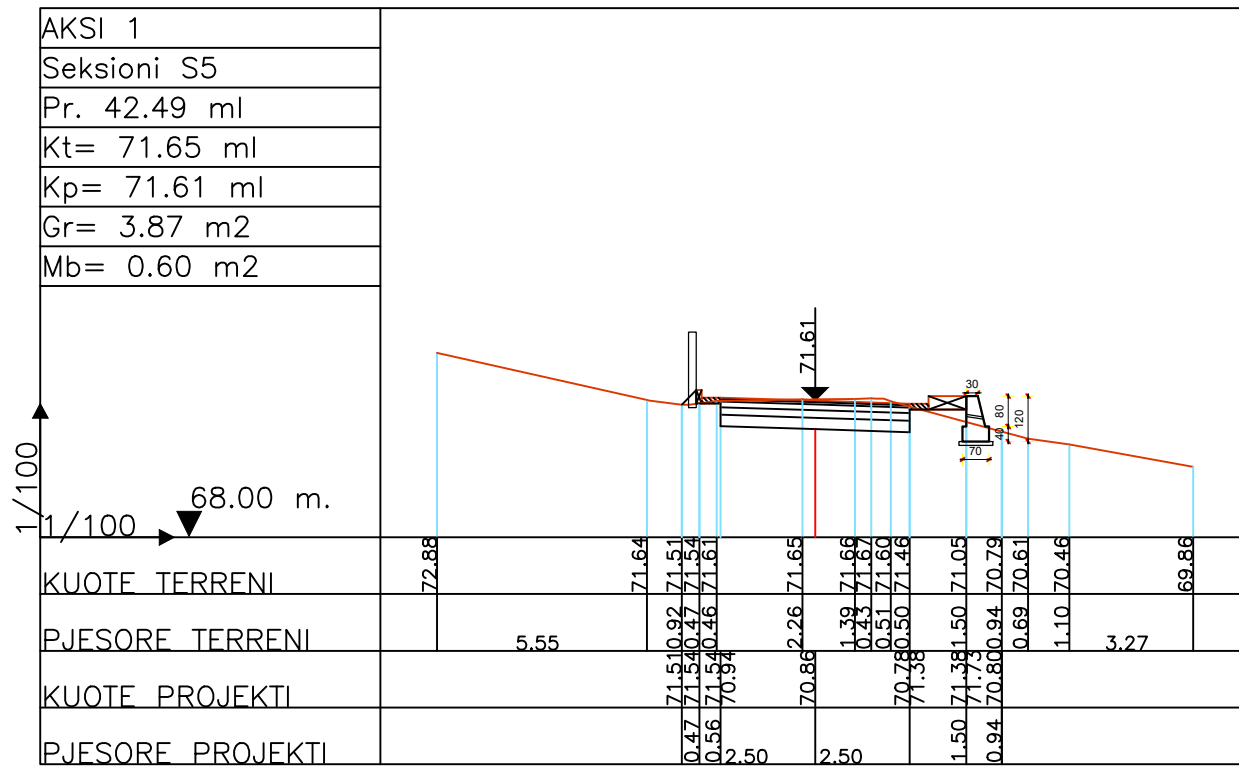

**POROSITESI : BASHKIA VORË**

OBJEKTI:  
"RIKONSTRUKSION I RRUGEVE MUCAJ, SHERAJ DHE E VESLEVE  
FSHATI MUCAJ, BASHKIA VORE "

Emertimi: PROFILET TERTHORE

**"ARABEL - STUDIO" Sh.p.k**  
Adresa: Njesia Bashkiake nr.7, Rruga "Frosina Plaku",  
Pallati 21, Hyrja 1, Kati 2, Tirane.  
Email: arabelstudio@gmail.com

**Drejtes i projektit**

Adm. Ana NISHKU	
Inxh. Ardi ARKAXHIU	

**Projektues**

Nd. Ardi ARKAXHIU	Elek. Altin ALLKAJ
Ark. Rigert HYRA	Top. Mustafa HOXHAI
Gjeo. Irfan BEGAJ	Hid. Hajredin MURGU

<b>SHKALLA</b>	<b>FLETA</b>
1 : 200	9- 03
Vorë 2019	Format A3

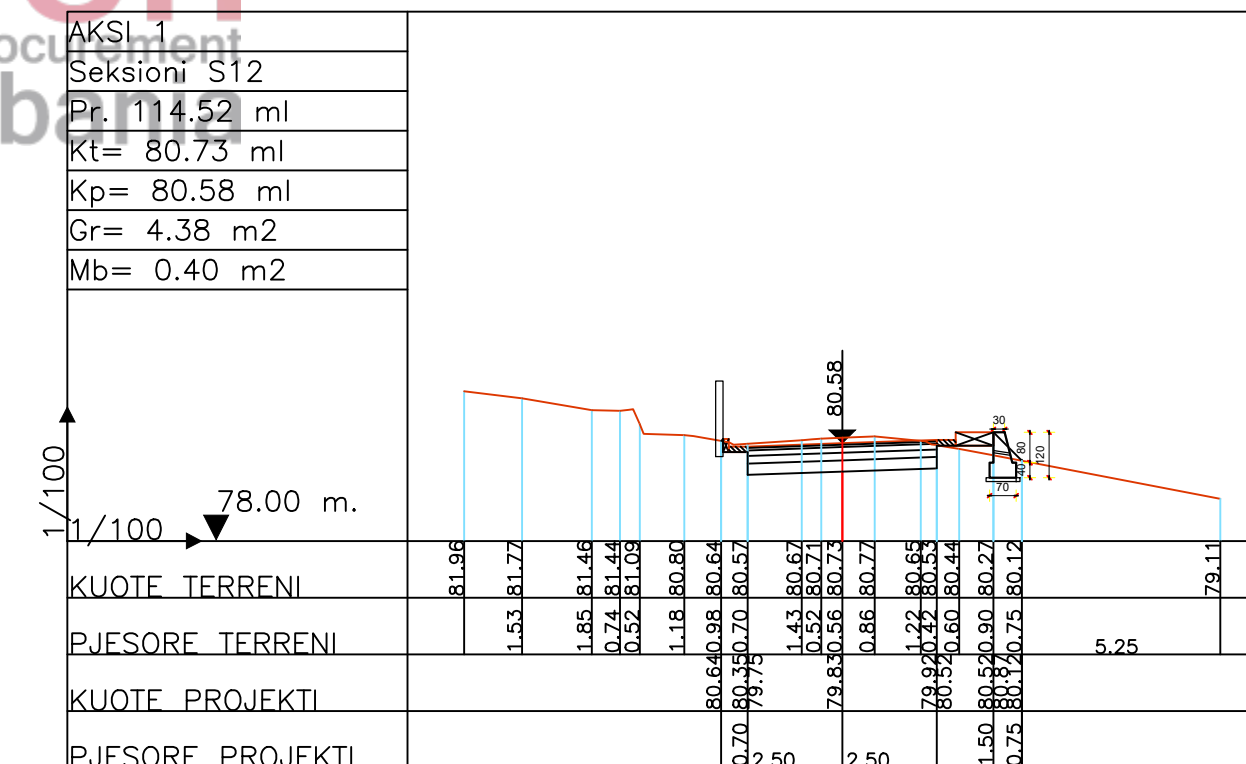
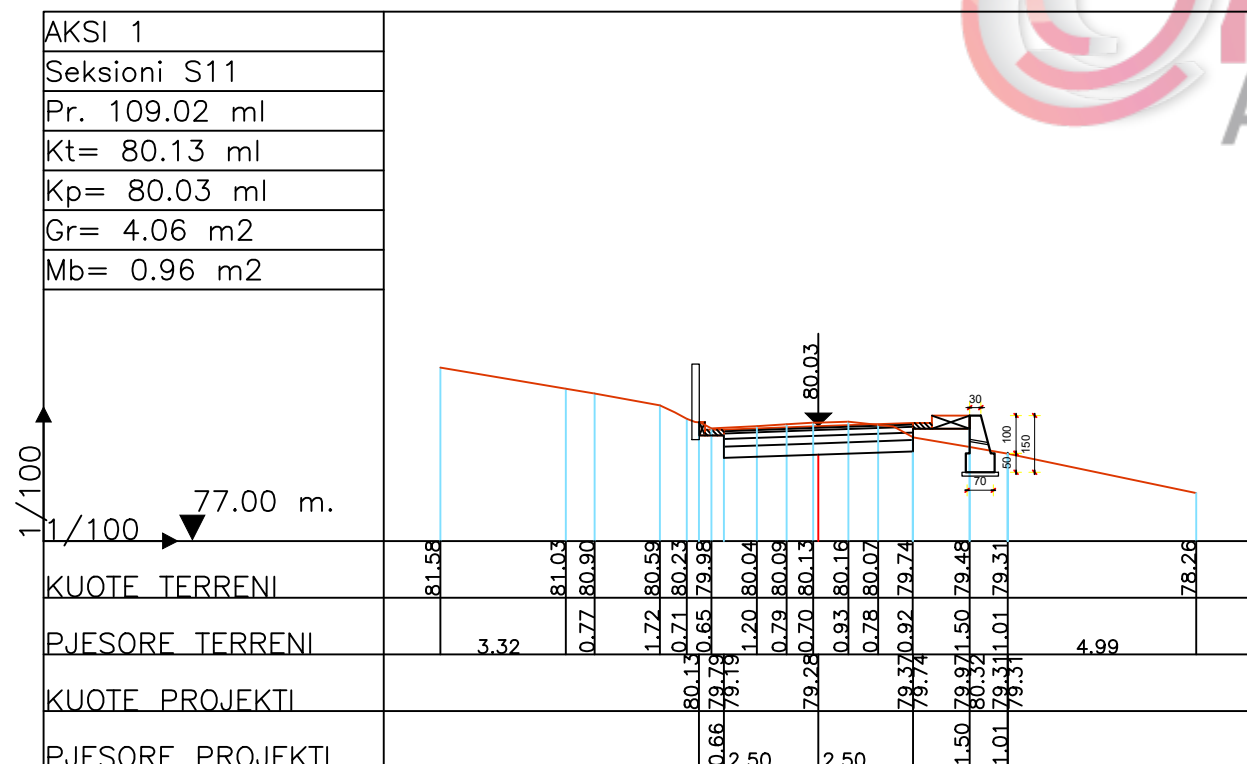
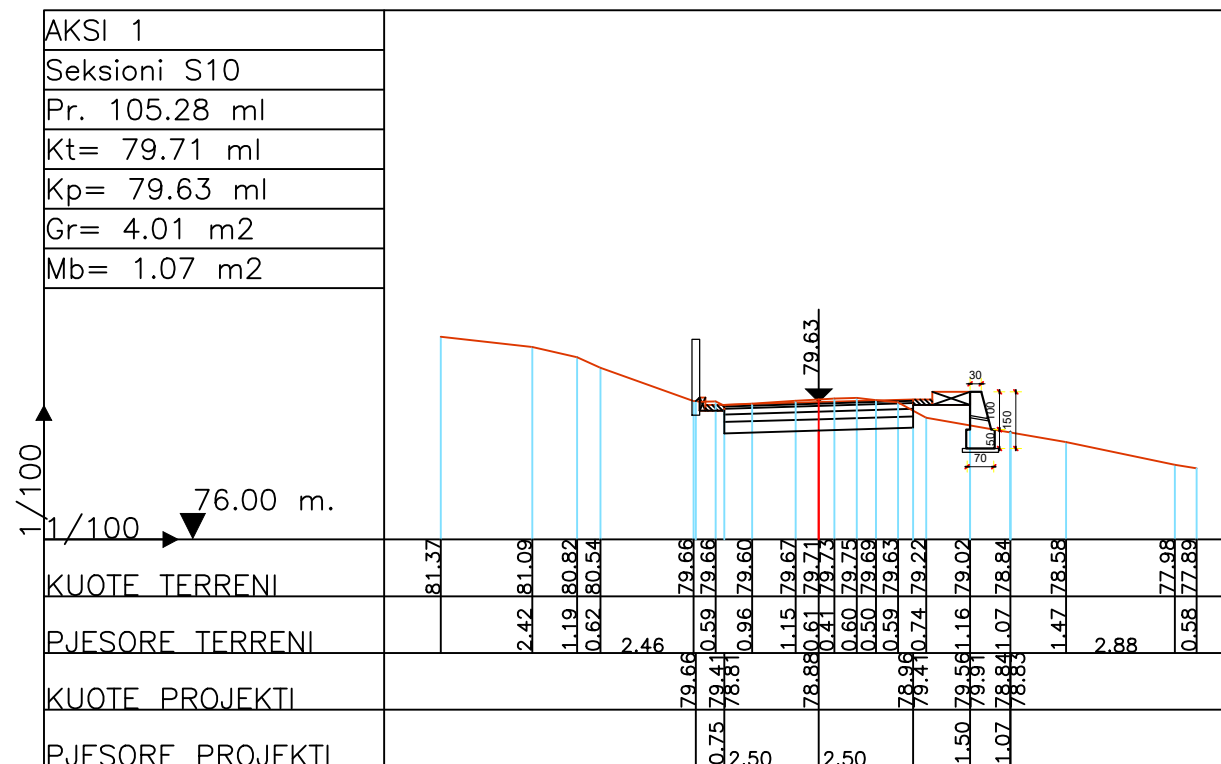
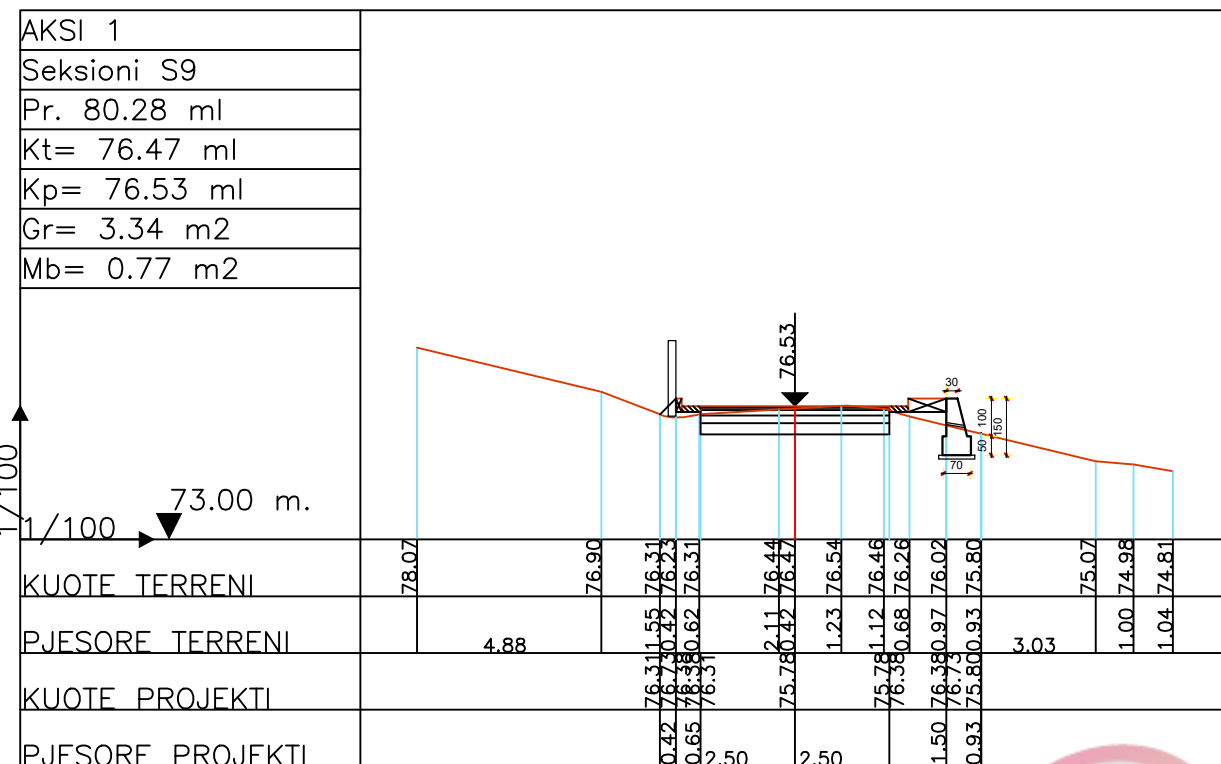

# POROSITESI : BASHKIA VORË

OBJEKTI:  
"RIKONSTRUKSION I RRUGEVE MUCAJ, SHERAJ DHE E VESLEVE  
FSHATI MUCAJ ,BASHKIA VORE "

Emertimi: PROFILET TERTHORE



"ARABEL - STUDIO" Sh.p.k  
Adresa: Njesia Bashkiake nr.7, Rruga "Frosina Plaku",  
Pallati 21, Hyrja 1, Kati 2, Tirane.  
Email: arabelstudio@gmail.com

## Drejtesues i projektit

Adm. Ana NISHKU  
Inxh. Ardi ARKAXHIU

## Projektues

Nd. Ardi ARKAXHIU  
Ark.Rigert HYRA  
Gjeo.Irfan BEGAJ  
Elek. Altin ALLKAJ  
Top. Mustafa HOXHAI  
Hid. Hajredin MURGU

## SHKALLA

1 : 200

Vorë 2019

## FLETA

9- 04

Format A3

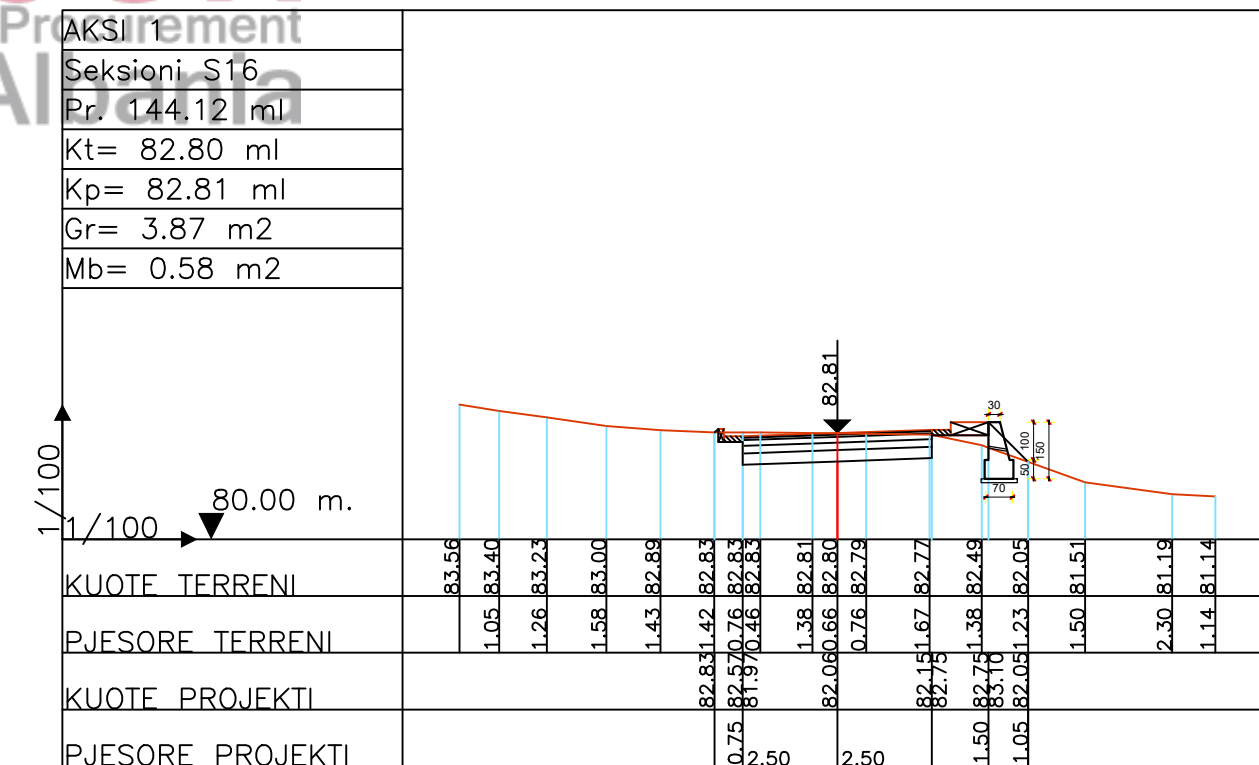
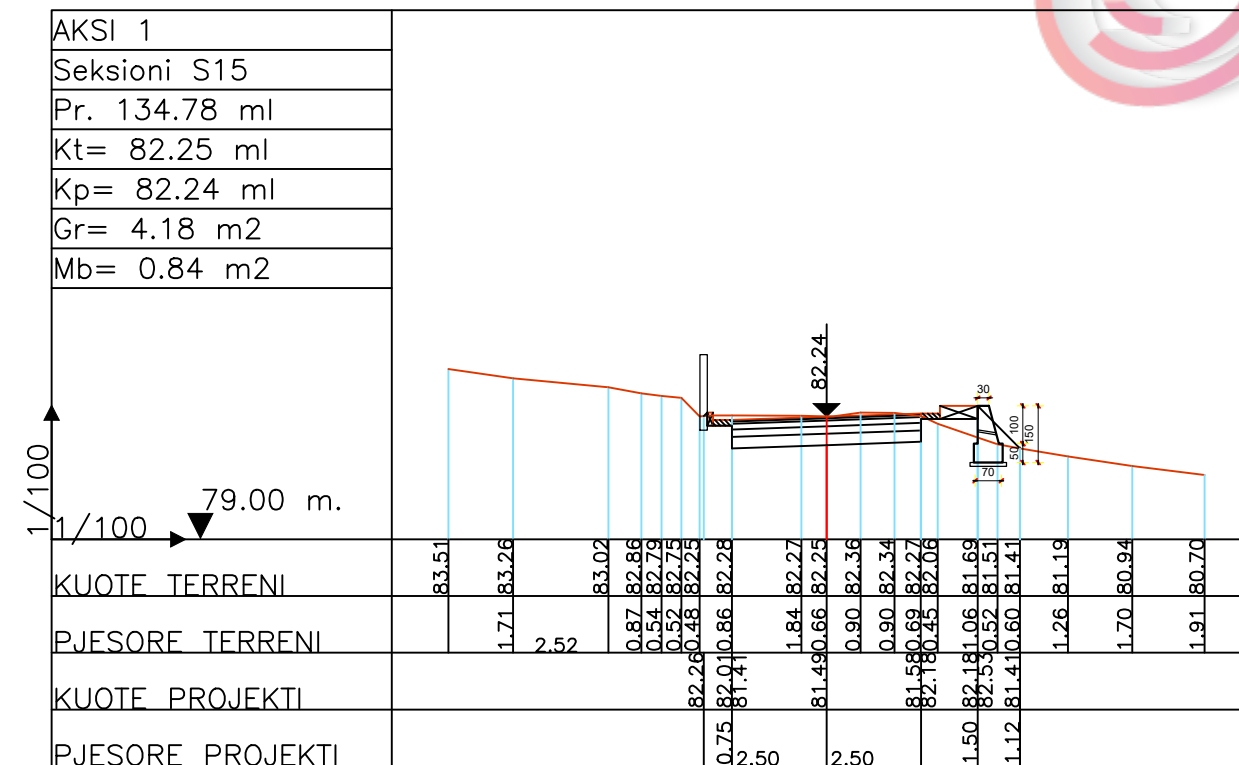
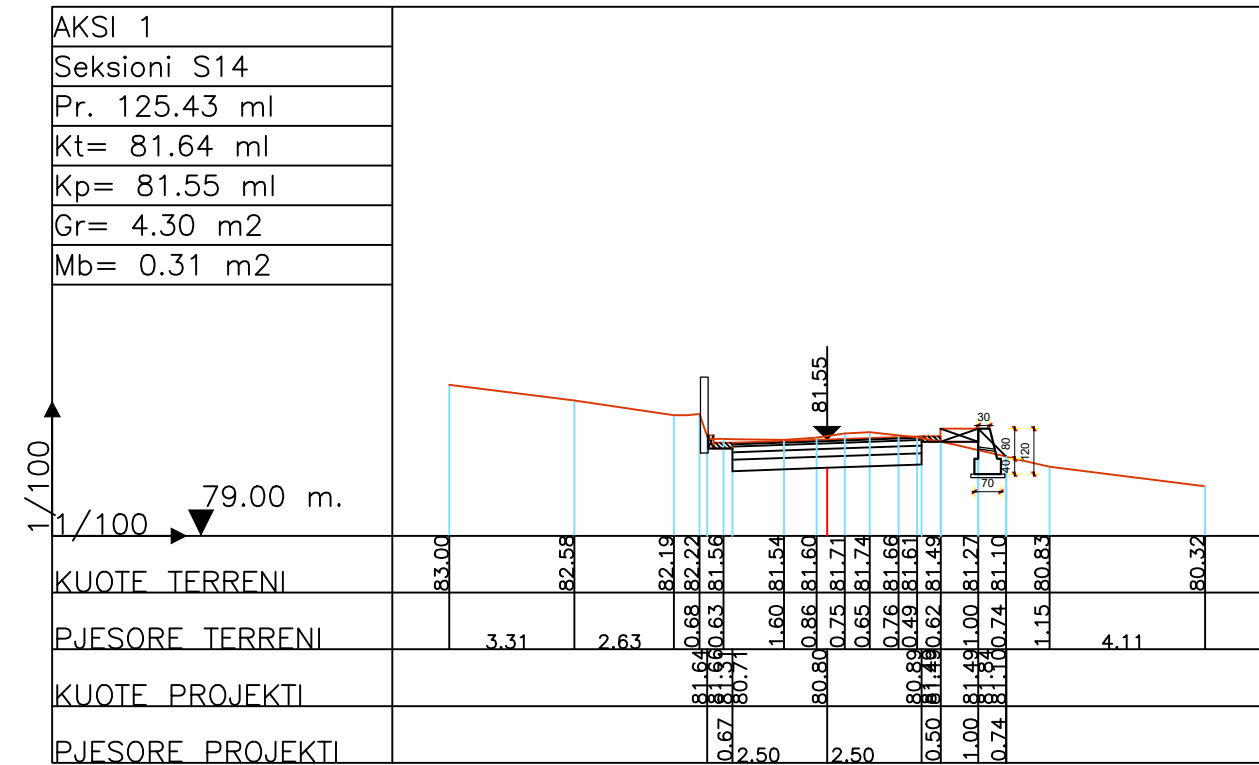
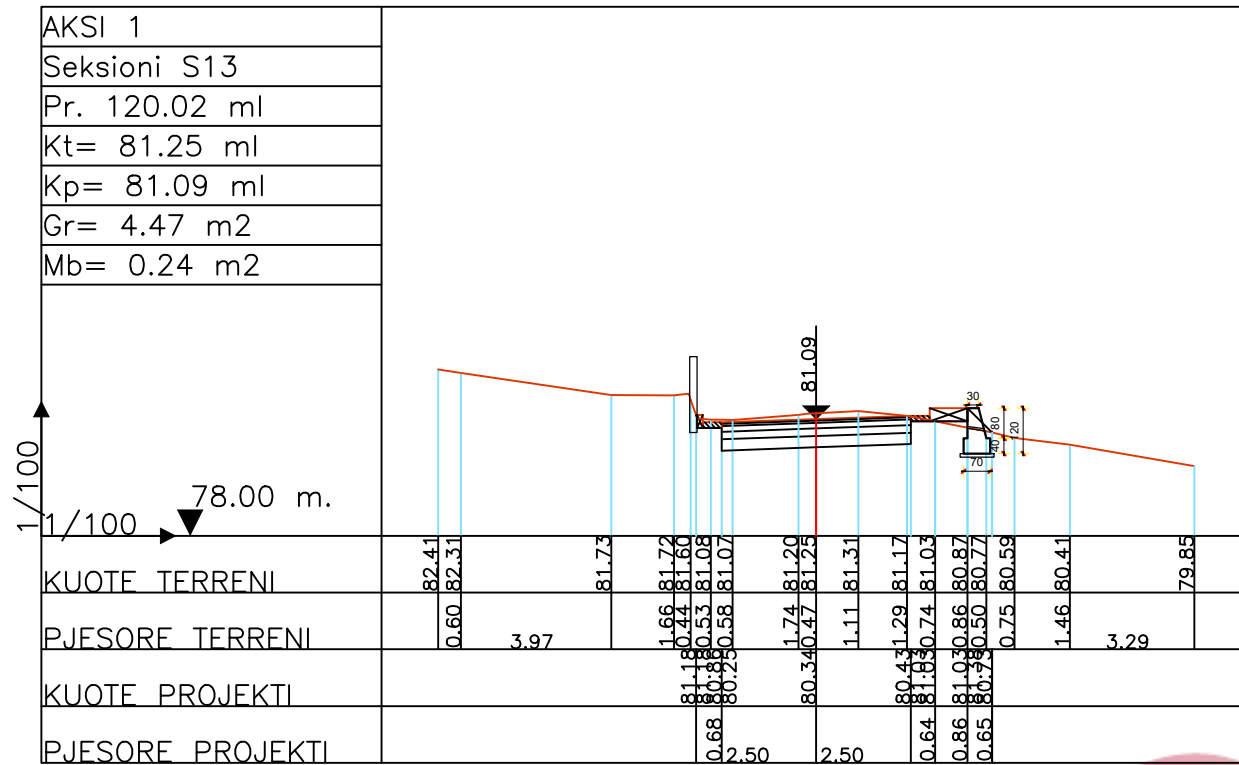

**POROSITESI : BASHKIA VORË**

OBJEKTI:  
"RIKONSTRUKSION I RRUGEVE MUCAJ, SHERAJ DHE E VESLEVE FSHATI MUCAJ ,BASHKIA VORE "

Emertimi: PROFILET TERTHORE

**"ARABEL - STUDIO" Sh.p.k**  
Adresa: Njesia Bashkiake nr.7, Rruga "Frosina Plaku", Pallati 21, Hyrja 1, Kati 2, Tirane.  
Email: arabelstudio@gmail.com

Drejtes i projektit

Adm. Ana NISHKU  
Inxh. Ardi ARKAXHIU

Projektues

Nd. Ardi ARKAXHIU  
Ark.Rigert HYRA  
Gjeo.Irfan BEGAJ

Elek. Altin ALLKAJ  
Top. Mustafa HOXHAI  
Hid. Hajredin MURGU

SHKALLA

1 : 200

FLETA

9- 05

Vorë 2019

Format A3



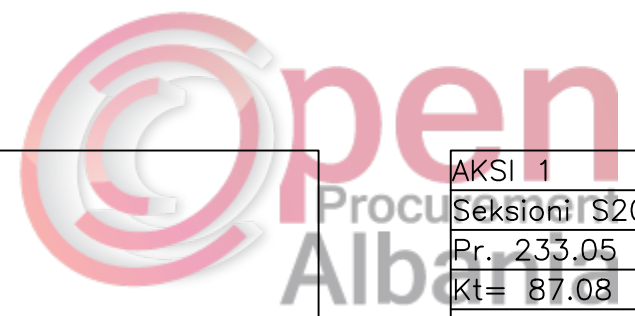
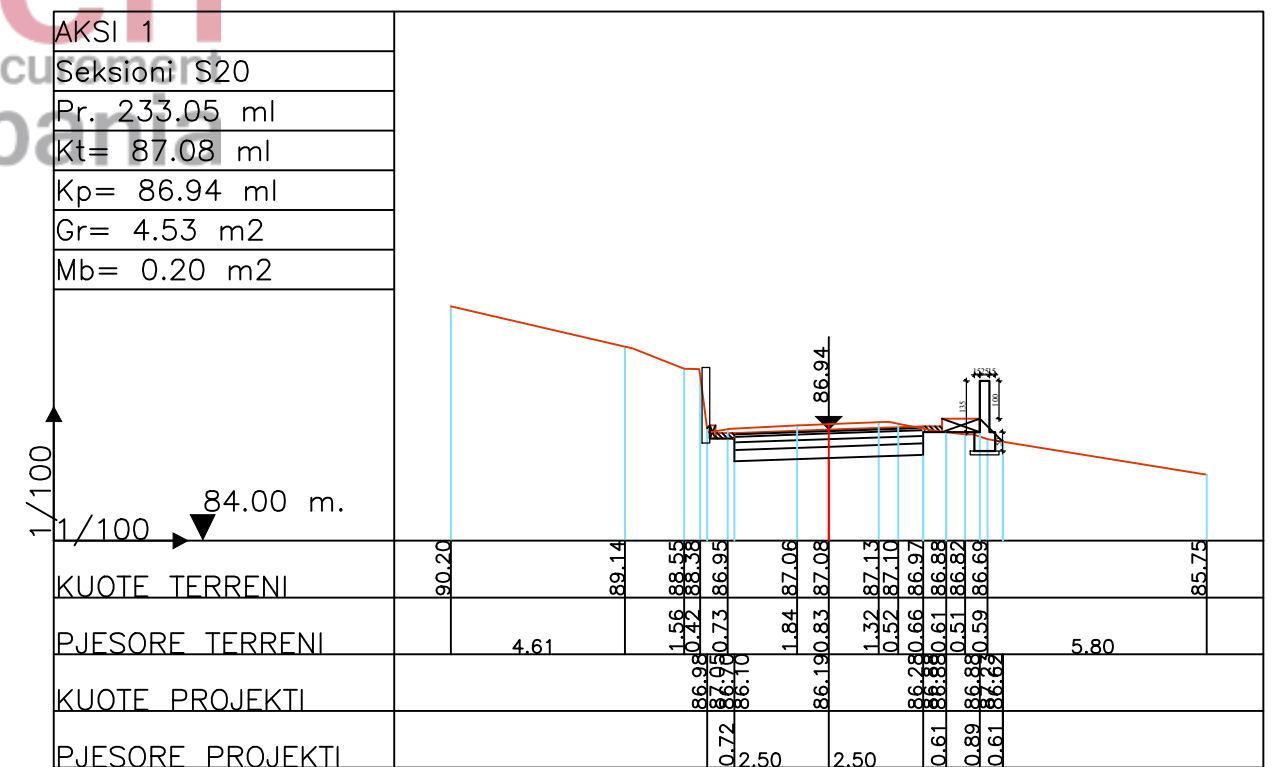
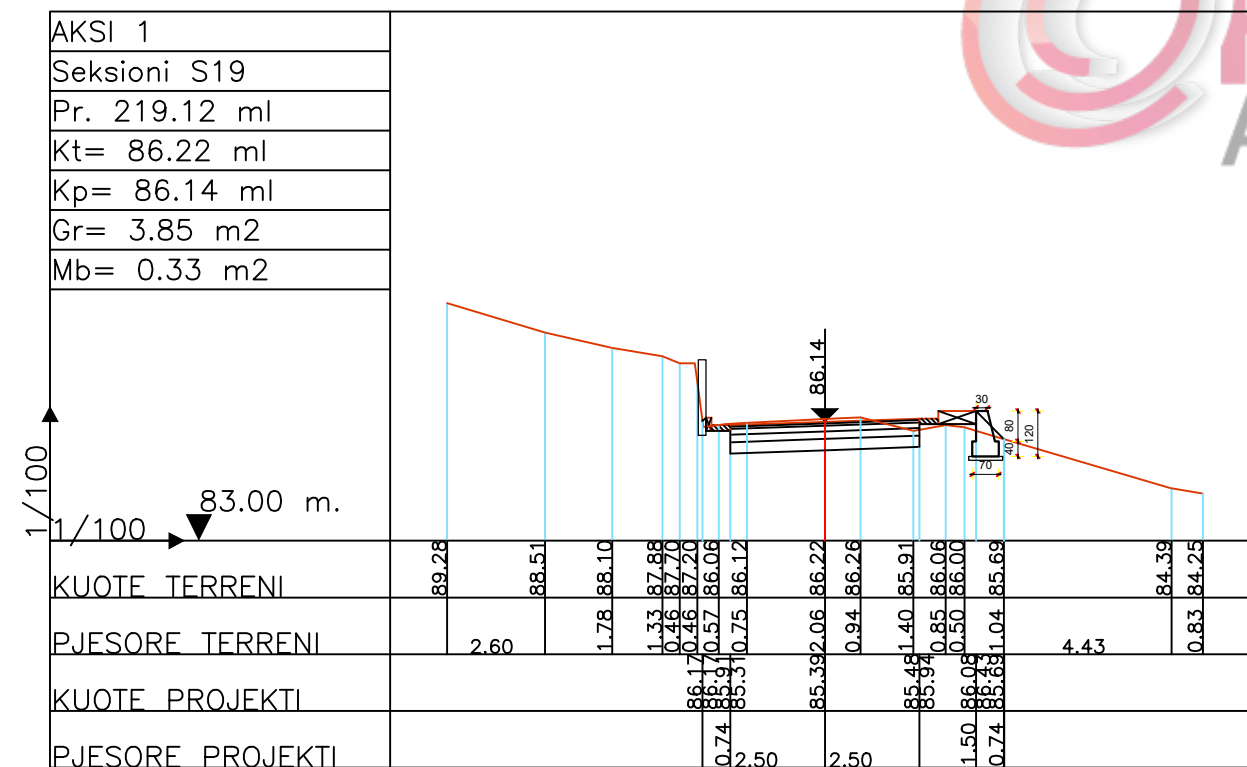
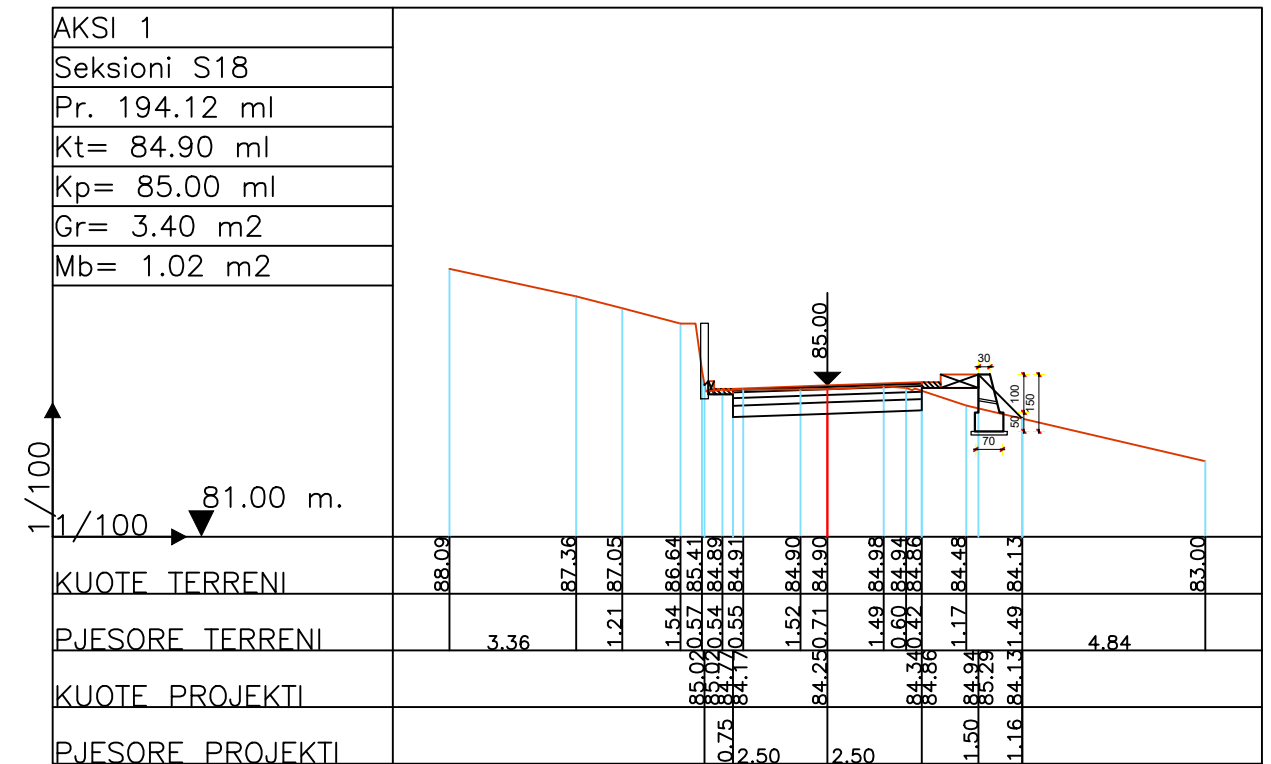
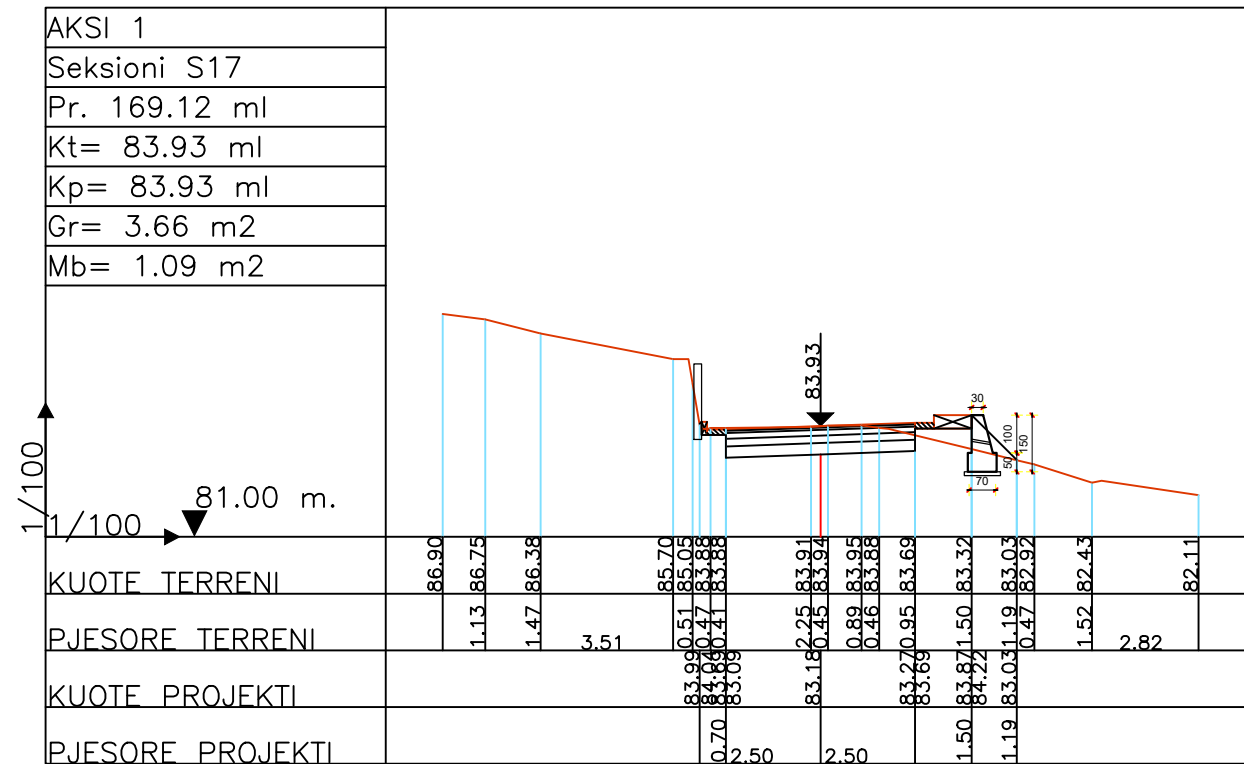

**POROSITESI : BASHKIA VORË**

OBJEKTI:  
"RIKONSTRUKSION I RRUGEVE MUCAJ, SHERAJ DHE E VESLEVE FSHATI MUCAJ, BASHKIA VORE "

Emertimi: PROFILET TERTHORE

**"ARABEL - STUDIO" Sh.p.k**  
Adresa: Njesia Bashkiake nr.7, Rruga "Frosina Plaku", Pallati 21, Hyrja 1, Kati 2, Tirane.  
Email: arabelstudio@gmail.com

**Drejtes i projektit**

Adm. Ana NISHKU  
Inxh. Ardi ARKAXHIU

**Projektues**

Nd. Ardi ARKAXHIU  
Ark.Rigert HYRA  
Gjeo.Irfan BEGAJ

Elek. Altin ALLKAJ  
Top. Mustafa HOXHAI  
Hid. Hajredin MURGU

**SHKALLA**  
1 : 200  
Vorë 2019

**FLETA**  
9- 06  
Format A3

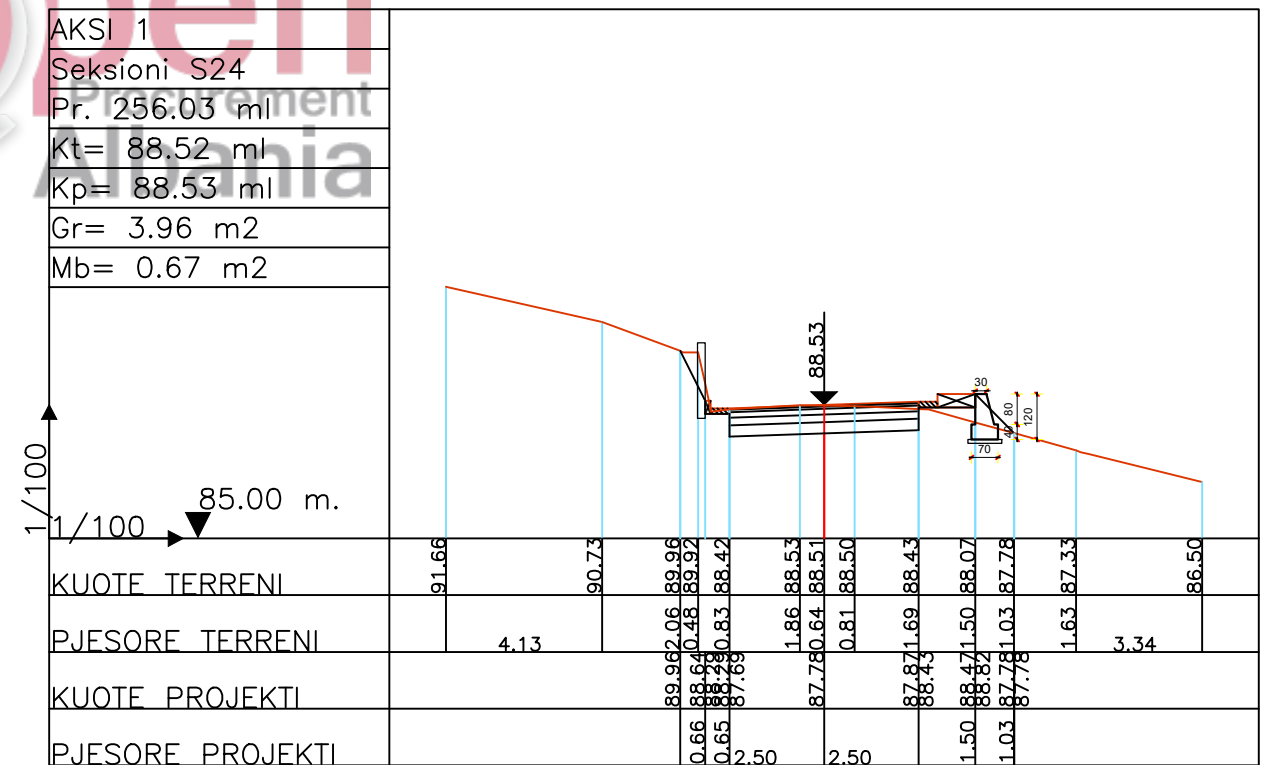
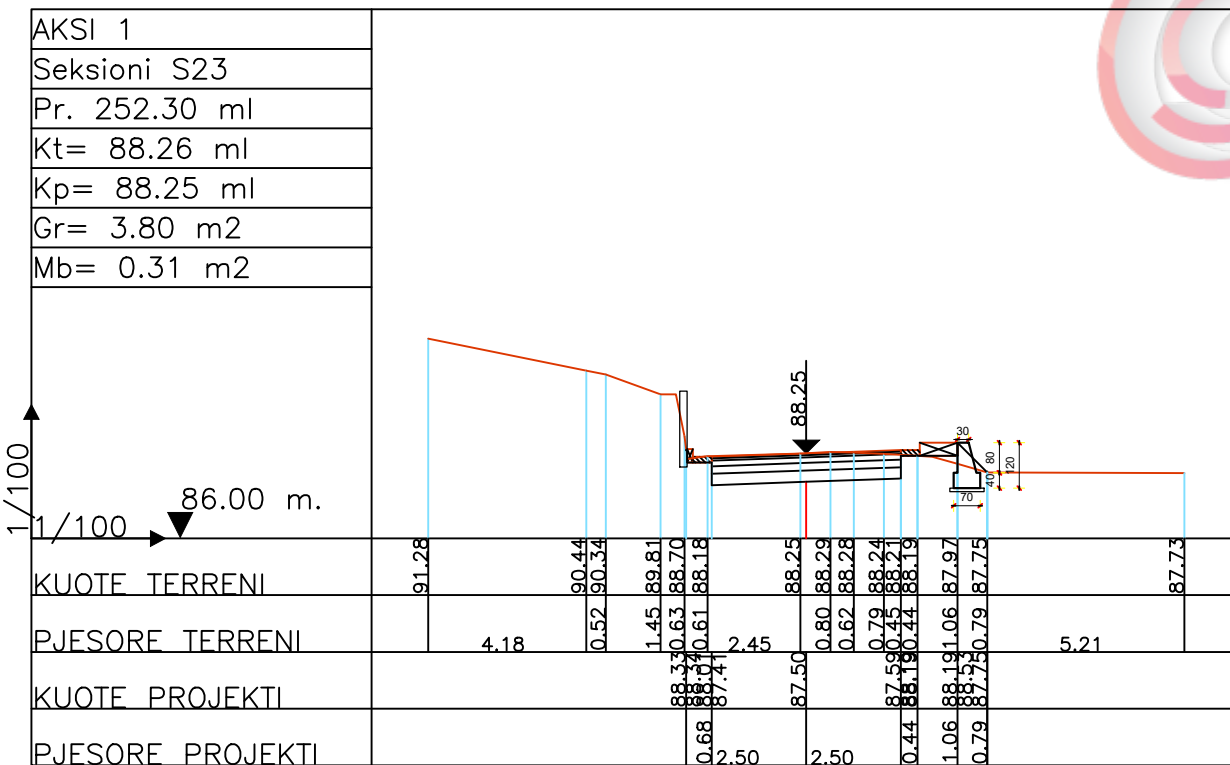
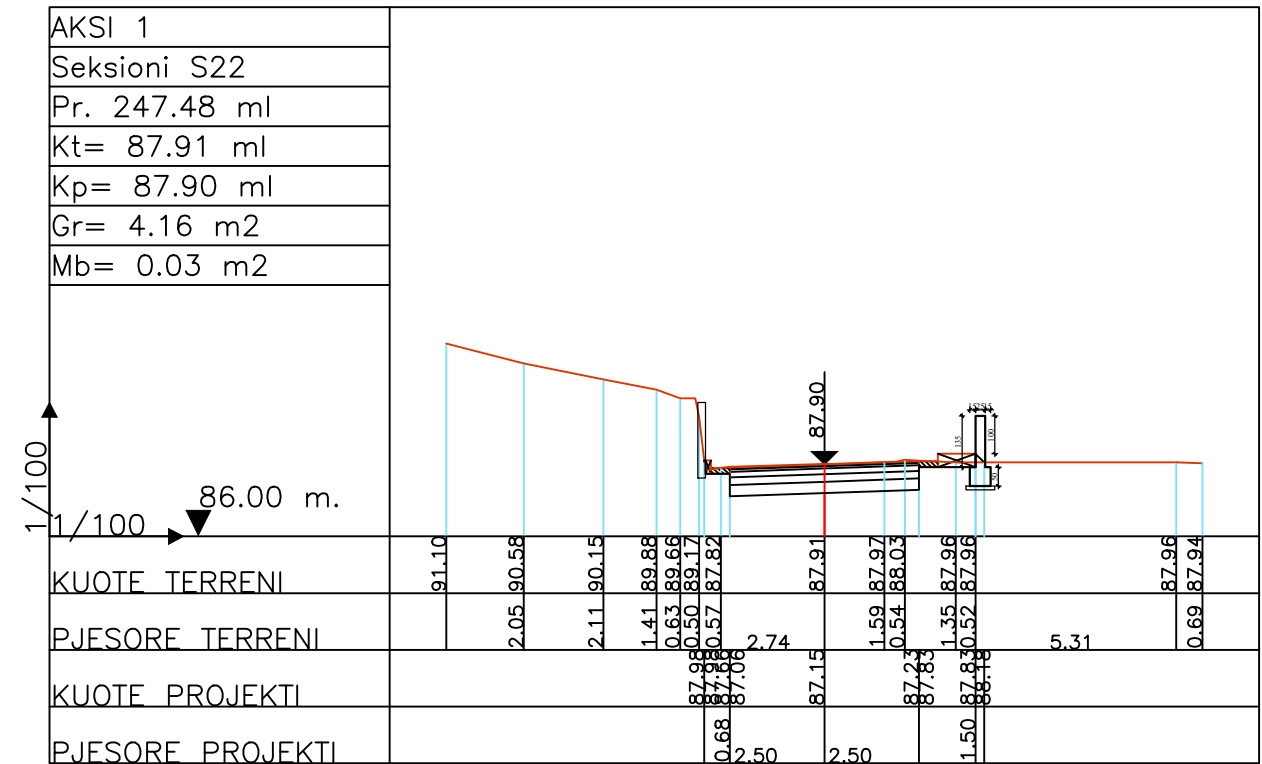
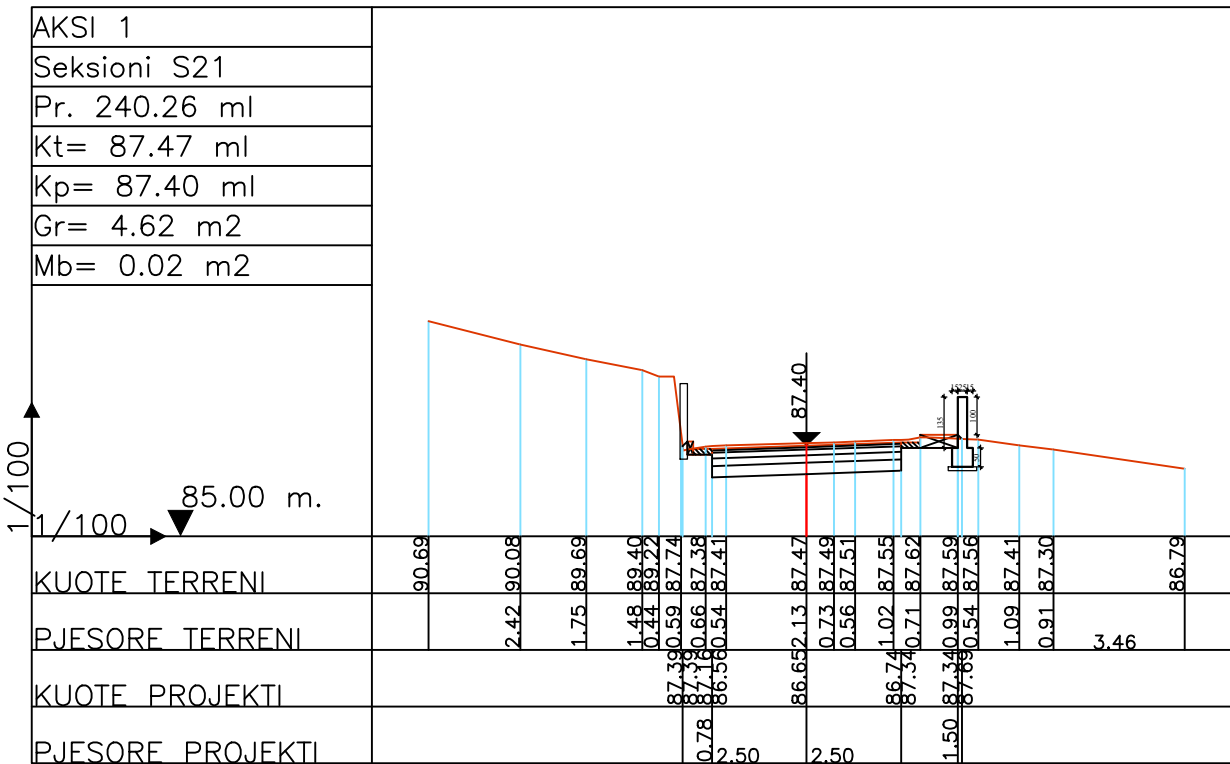

**POROSITESI : BASHKIA VORË**

OBJEKTI:  
"RIKONSTRUKSION I RRUGEVE MUCAJ, SHERAJ DHE E VESLEVE FSHATI MUCAJ, BASHKIA VORE "

Emertimi: PROFILET TERTHORE

**"ARABEL - STUDIO" Sh.p.k**  
Adresa: Njesia Bashkiake nr.7, Rruga "Frosina Plaku", Pallati 21, Hyrja 1, Kati 2, Tirane.  
Email: arabelstudio@gmail.com

Drejtesues i projektit

Adm. Ana NISHKU  
Inxh. Ardi ARKAXHIU

Projektues

Nd. Ardi ARKAXHIU  
Ark. Rigert HYRA  
Gjeo. Irfan BEGAJ

Elek. Altin ALLKAJ  
Top. Mustafa HOXHAI  
Hid. Hajredin MURGU

SHKALLA  
1 : 200  
Vorë 2019

FLETA  
9- 07  
Format A3

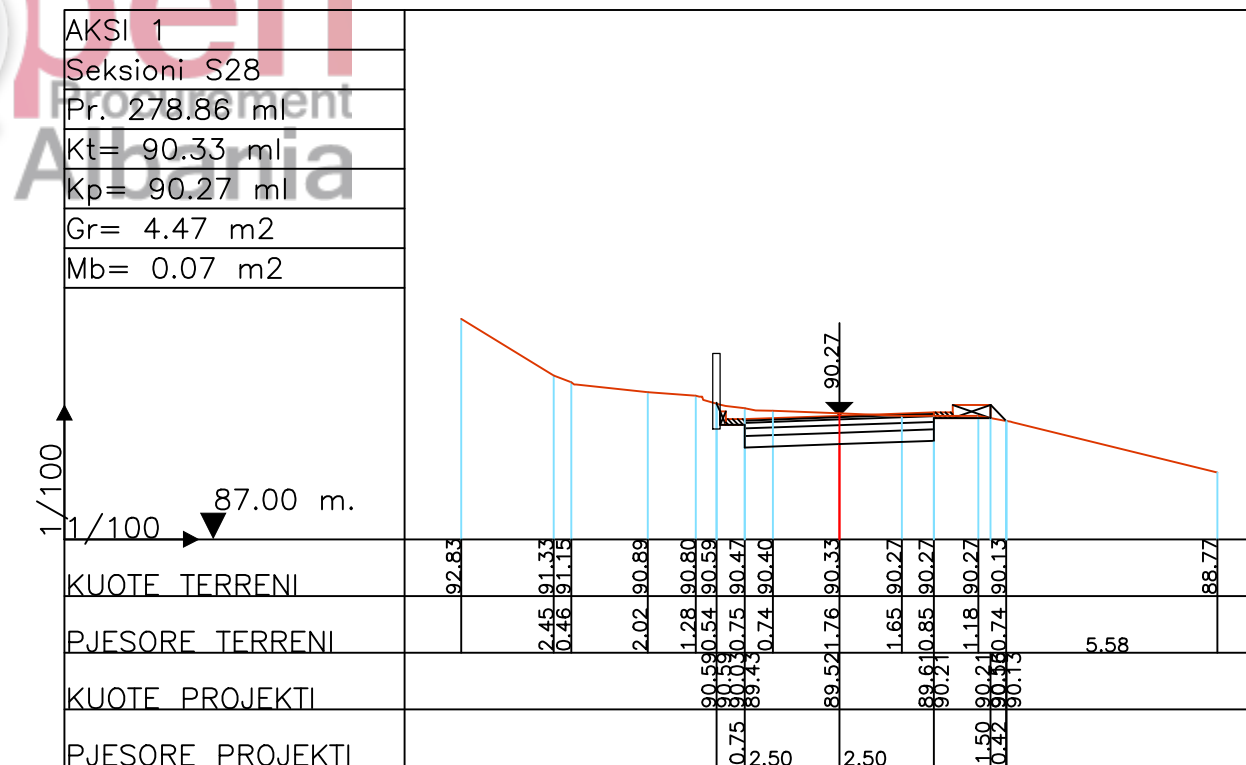
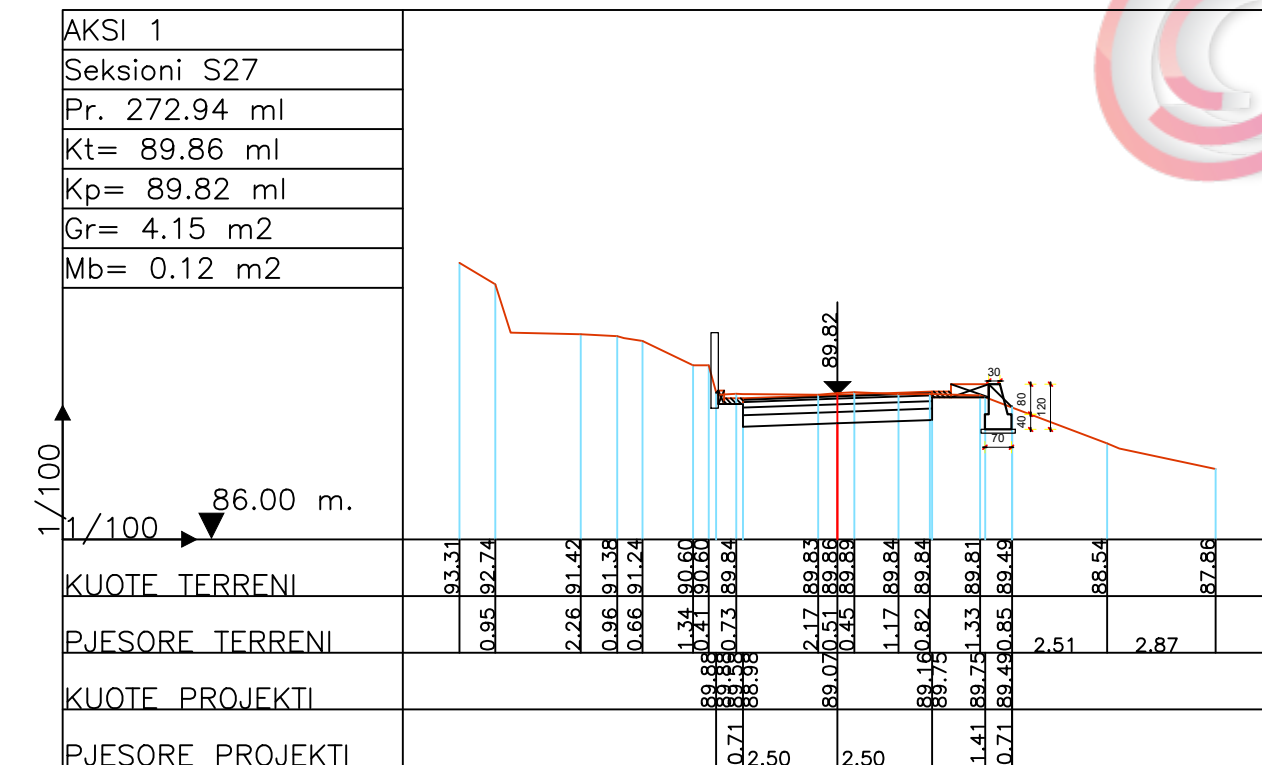
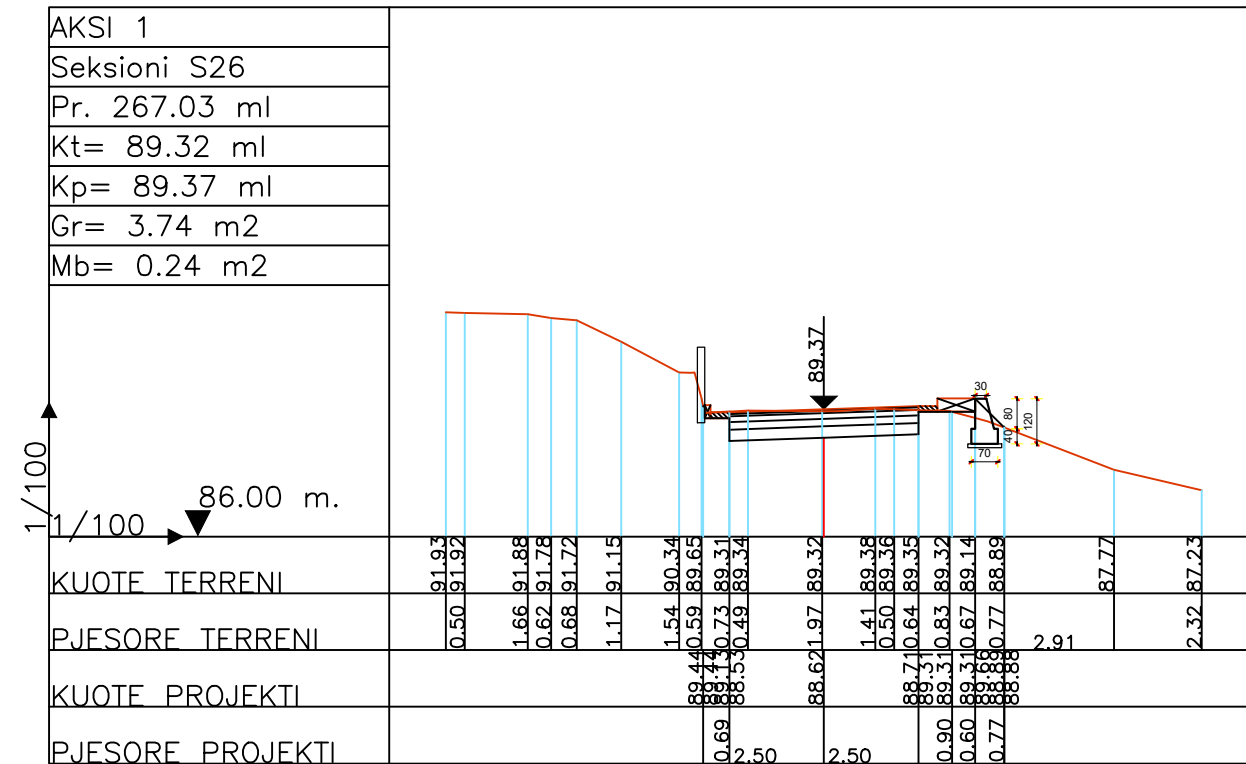
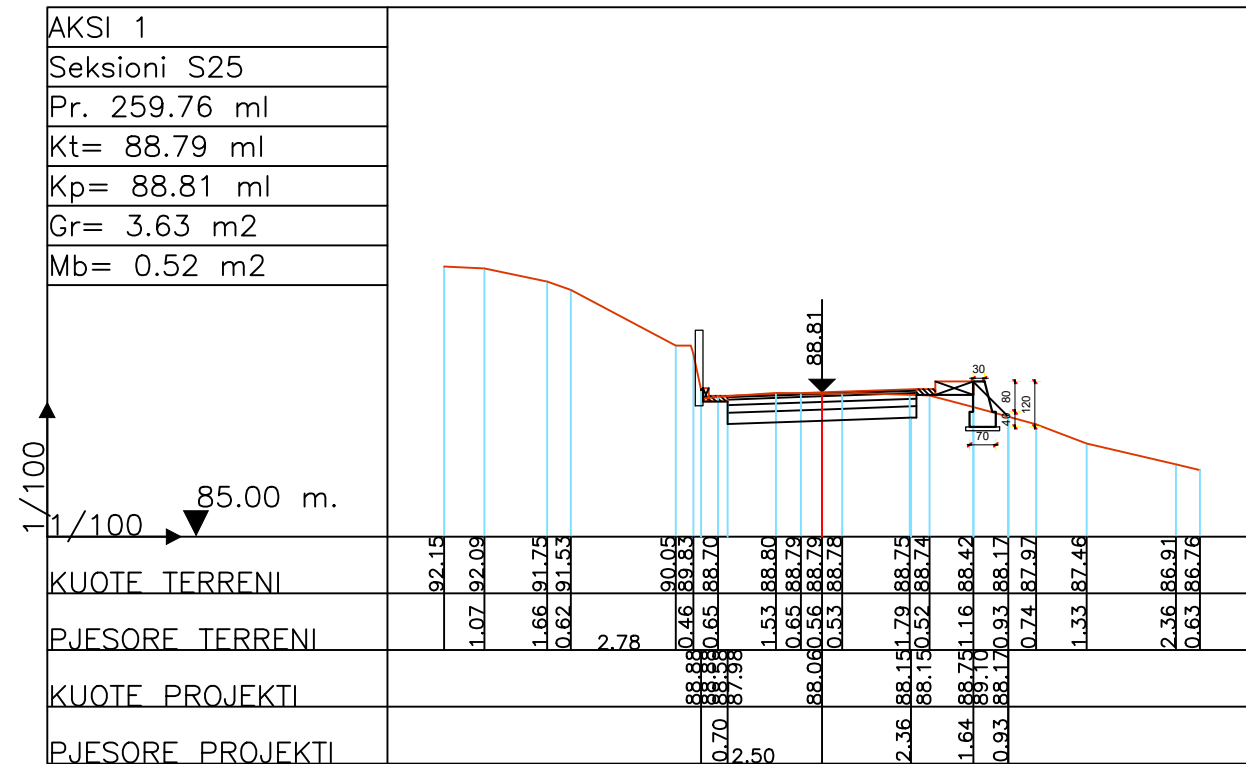

**POROSITESI : BASHKIA VORË**

OBJEKTI:  
"RIKONSTRUKSION I RRUGEVE MUCAJ, SHERAJ DHE E VESLEVE  
FSHATI MUCAJ ,BASHKIA VORE "

Emertimi: PROFILET TERTHORE

**"ARABEL - STUDIO" Sh.p.k**  
Adresa: Njesia Bashkiake nr.7, Rruga "Frosina Plaku",  
Pallati 21, Hyrja 1, Kati 2, Tirane.  
Email: arabelstudio@gmail.com

Drejtesues i projektit

Adm. Ana NISHKU	Nd. Ardi ARKAXHIU	Elek. Altin ALLKAJ
Inxh. Ardi ARKAXHIU	Ark.Rigert HYRA	Top. Mustafa HOXHAI
	Gjeo.Irfan BEGAJ	Hid. Hajredin MURGU

SHKALLA	FLETA
1 : 200	9- 08
Vorë 2019	Format A3

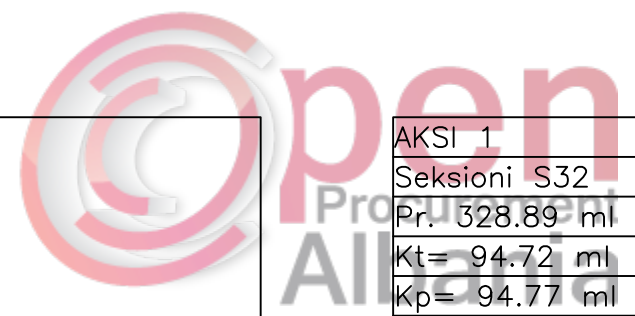
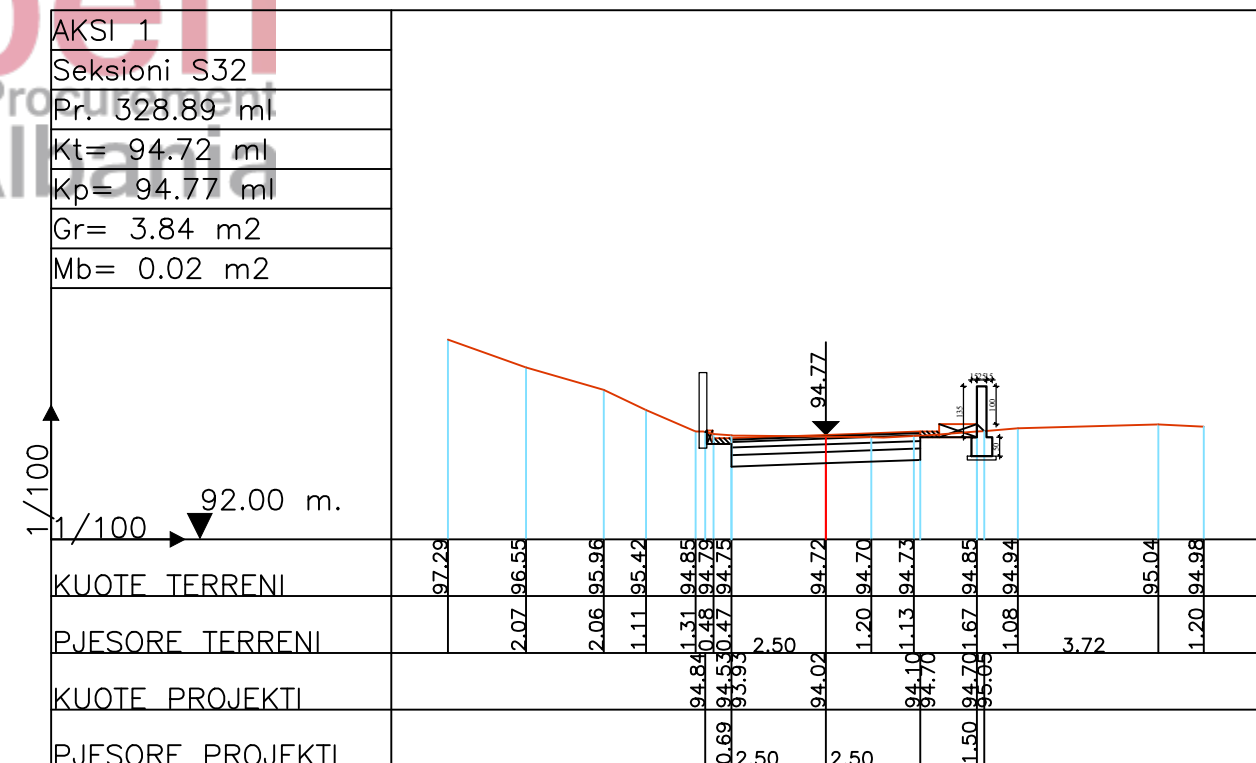
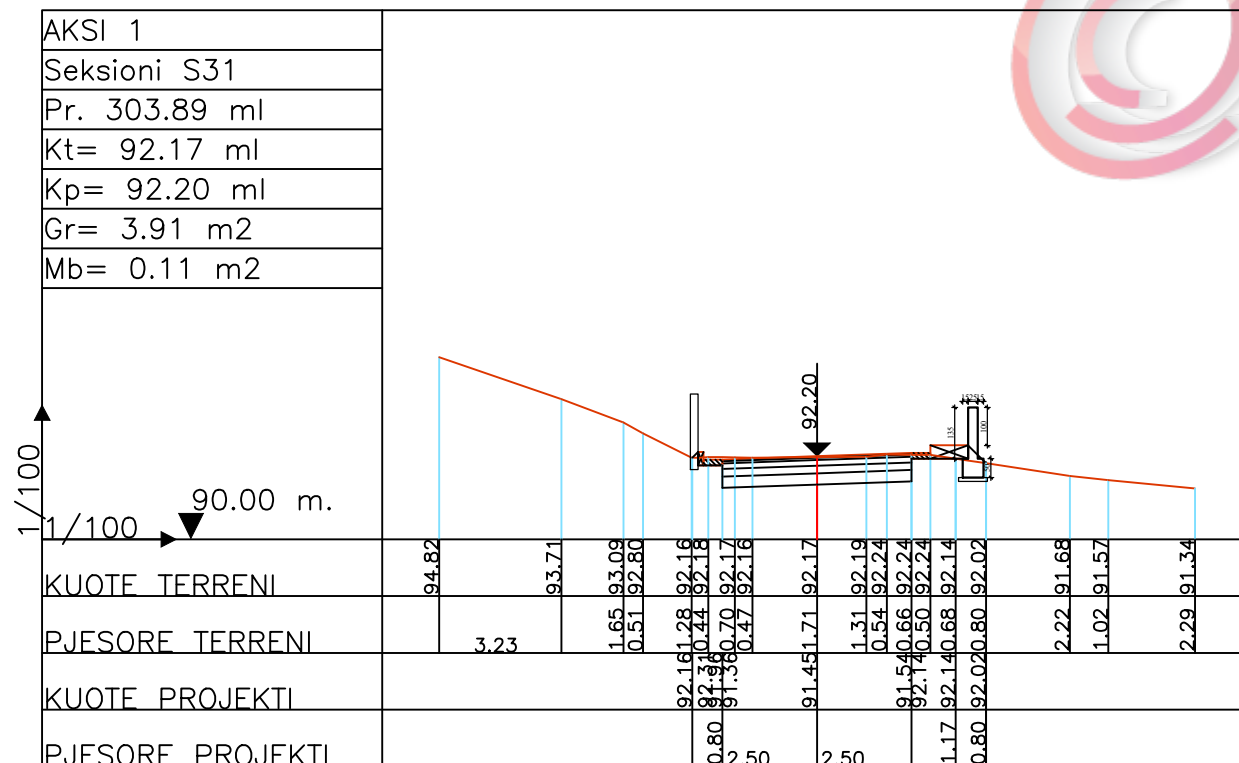
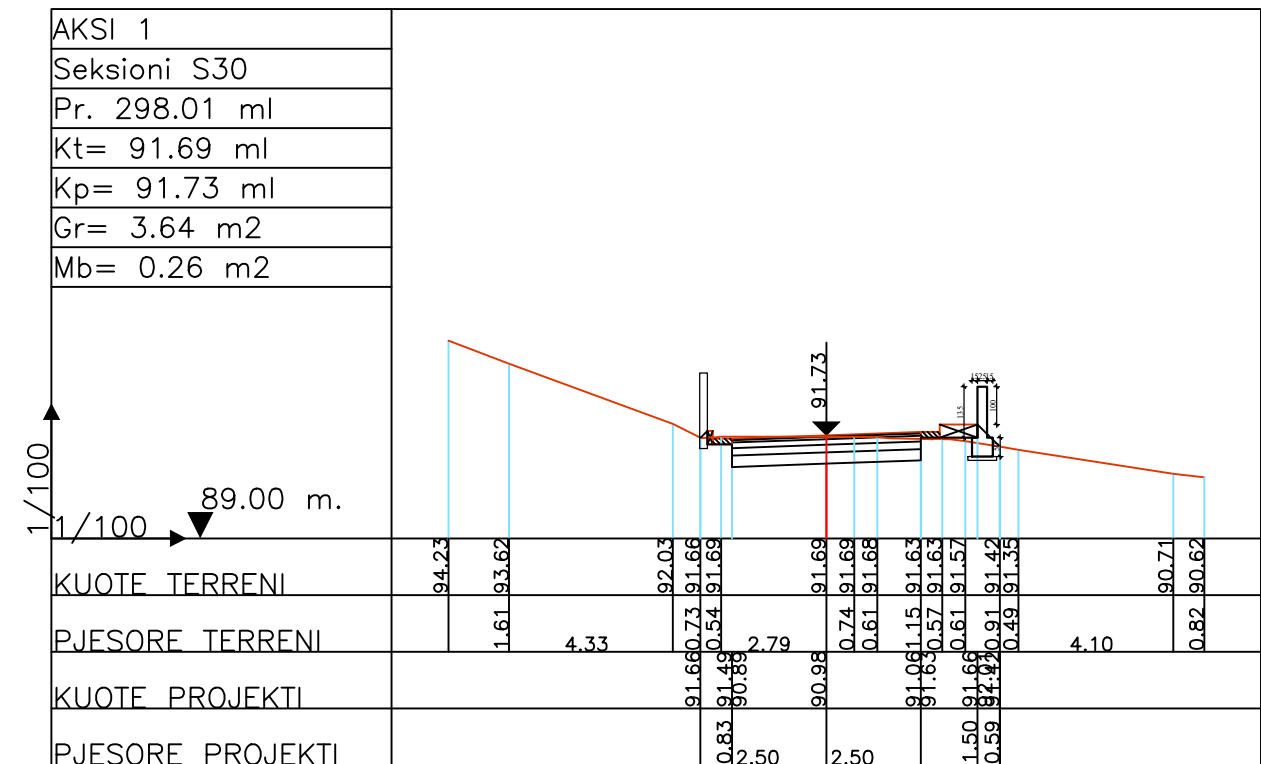
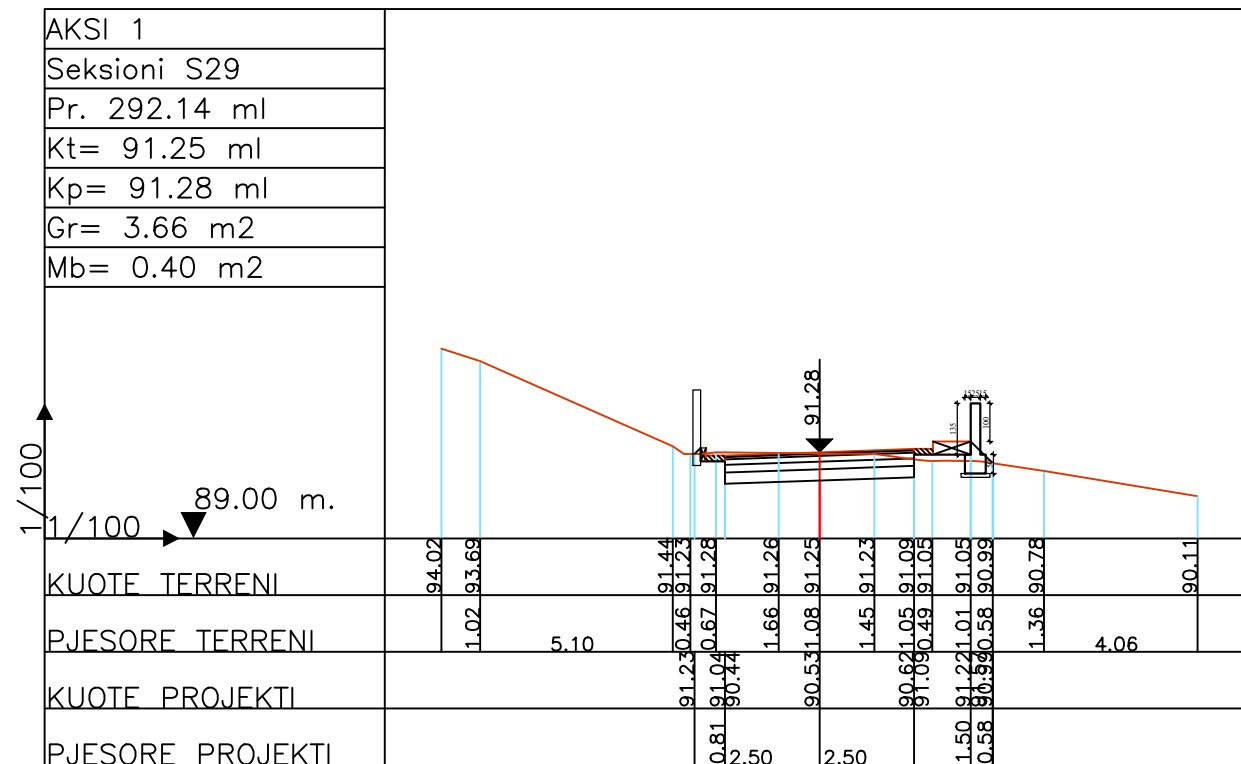

**POROSITESI : BASHKIA VORË**

OBJEKTI:  
"RIKONSTRUKSION I RRUGEVE MUCAJ, SHERAJ DHE E VESLEVE FSHATI MUCAJ ,BASHKIA VORE "

Emertimi: PROFILET TERTHORE

**"ARABEL - STUDIO" Sh.p.k**  
Adresa: Njesia Bashkiake nr.7, Rruga "Frosina Plaku", Pallati 21, Hyrja 1, Kati 2, Tirane.  
Email: arabelstudio@gmail.com

Drejtesues i projektit

Adm. Ana NISHKU	Nd. Ardi ARKAXHIU	Elek. Altin ALLKAJ
Inxh. Ardi ARKAXHIU	Ark.Rigert HYRA	Top. Mustafa HOXHAI
	Gjeo.Irfan BEGAJ	Hid. Hajredin MURGU

SHKALLA	FLETA
1 : 200	9- 09
Vorë 2019	Format A3

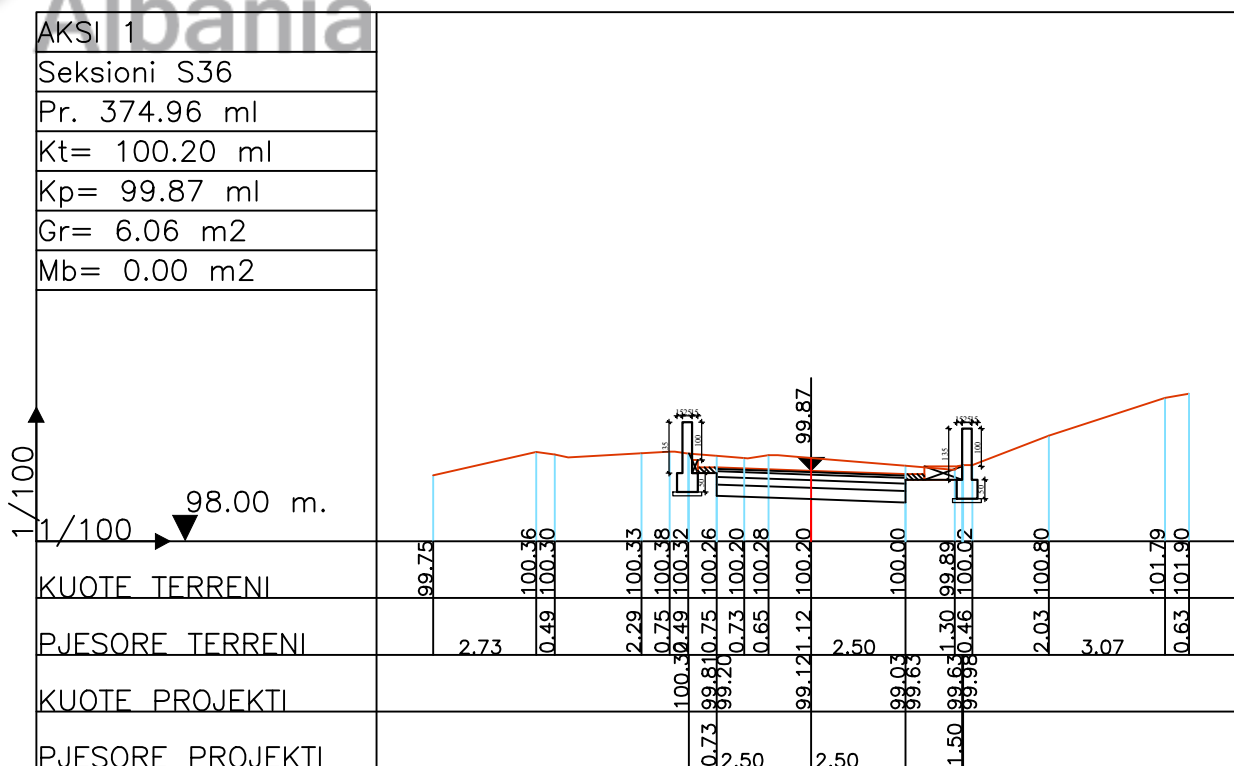
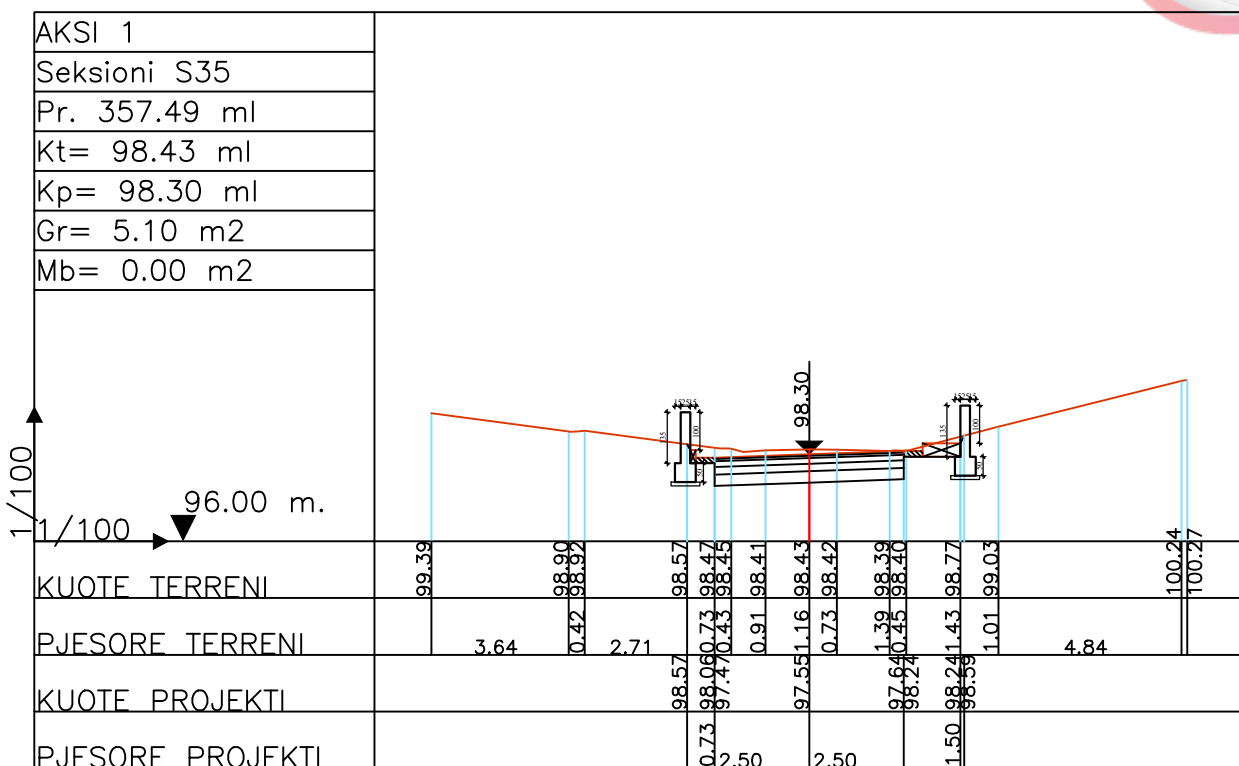
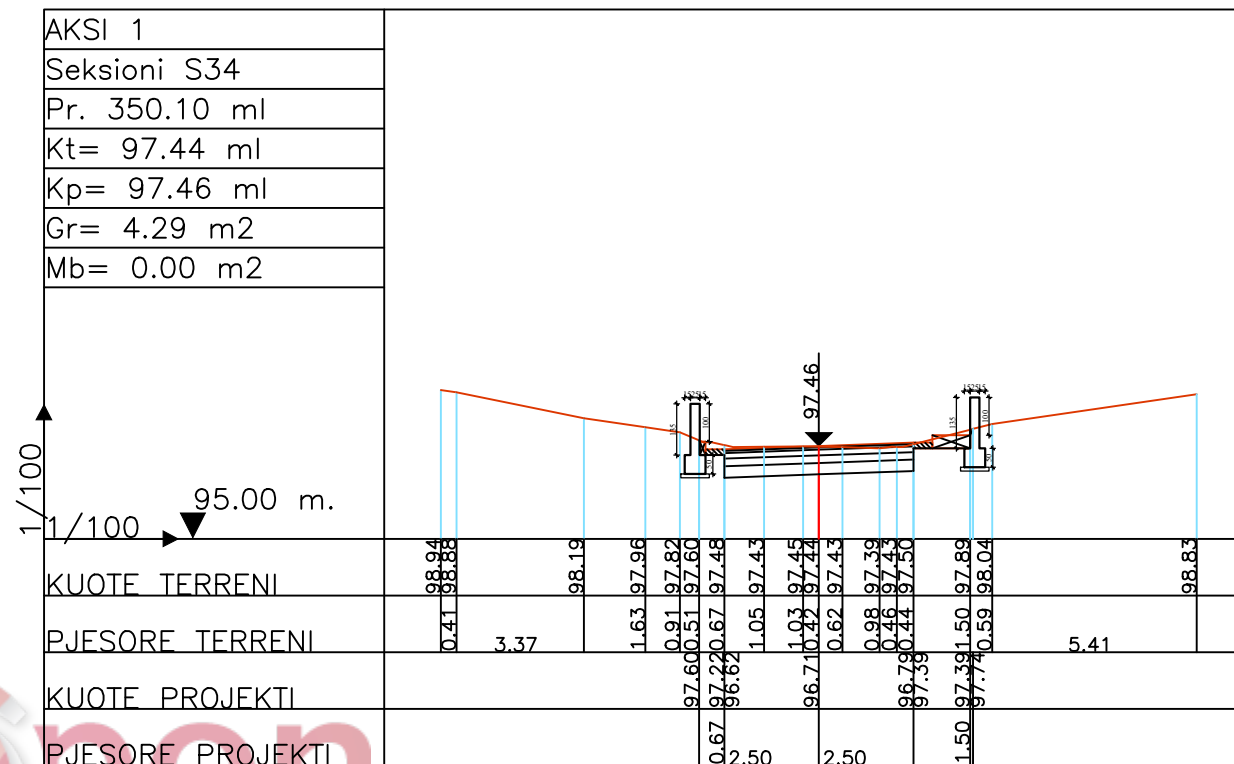
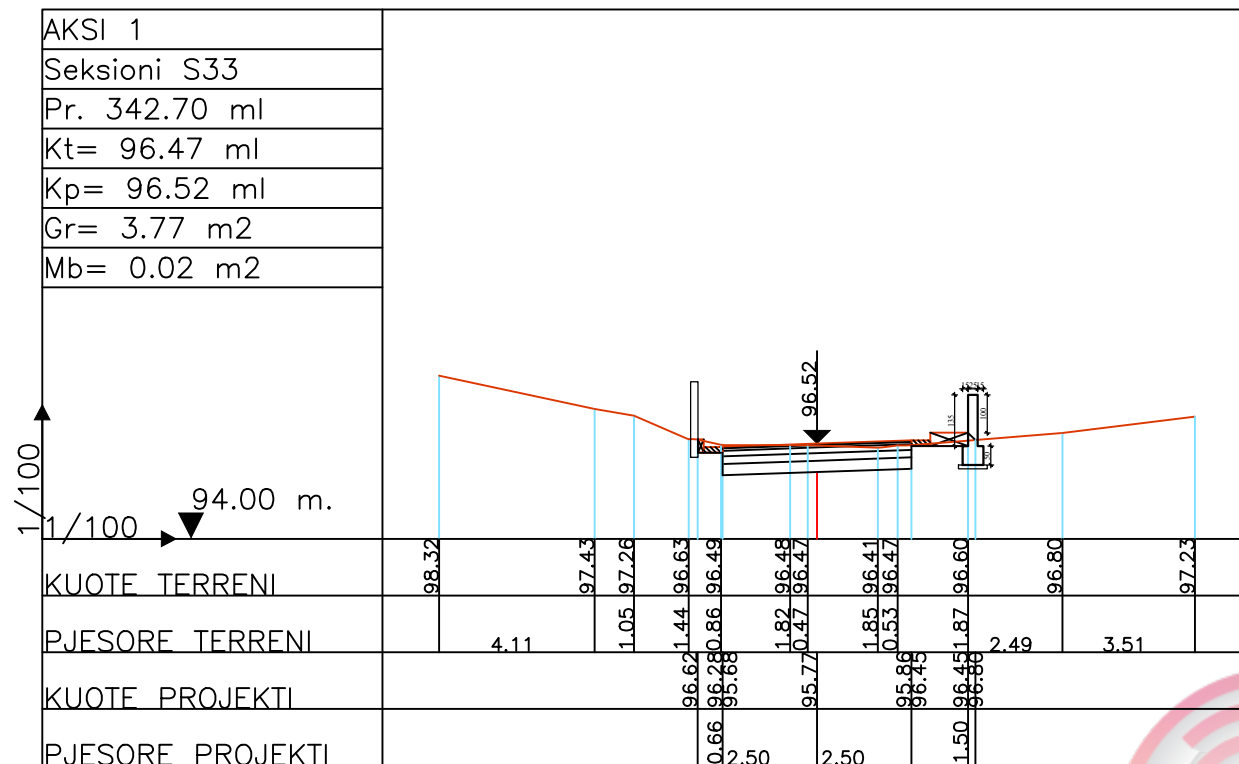

**POROSITESI : BASHKIA VORË**

OBJEKTI:  
"RIKONSTRUKSION I RRUGEVE MUCAJ, SHERAJ DHE E VESLEVE FSHATI MUCAJ ,BASHKIA VORE "

Emertimi: PROFILET TERTHORE

**"ARABEL - STUDIO" Sh.p.k**  
Adresa: Njesia Bashkiake nr.7, Rruga "Frosina Plaku", Pallati 21, Hyrja 1, Kati 2, Tirane.  
Email: arabelstudio@gmail.com

**Drejtes i projektit**  
Adm. Ana NISHKU  
Inxh. Ardi ARKAXHIU

**Projektues**  
Nd. Ardi ARKAXHIU  
Ark.Rigert HYRA  
Gjeo.Irfan BEGAJ

Elek. Altin ALLKAJ  
Top. Mustafa HOXHAI  
Hid. Hajredin MURGU

**SHKALLA**  
1 : 200

**FLETA**  
9- 10

Vorë 2019  
Format A3

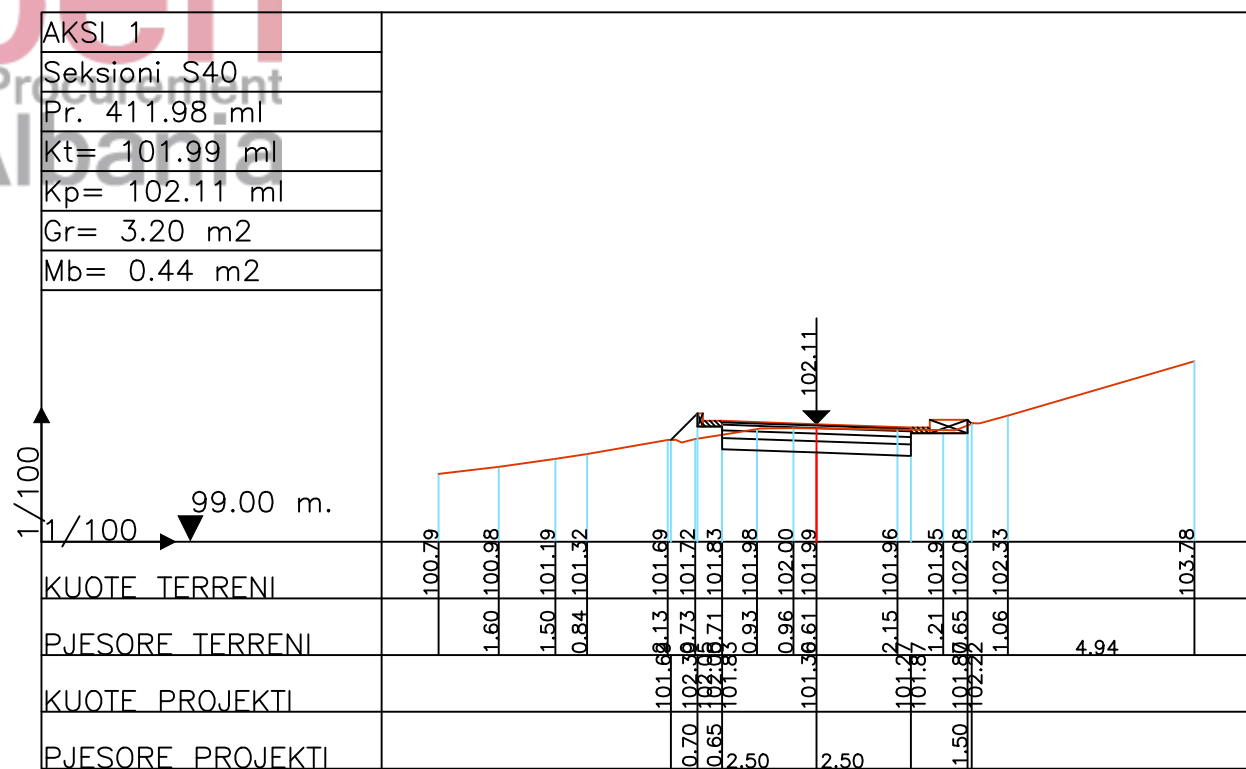
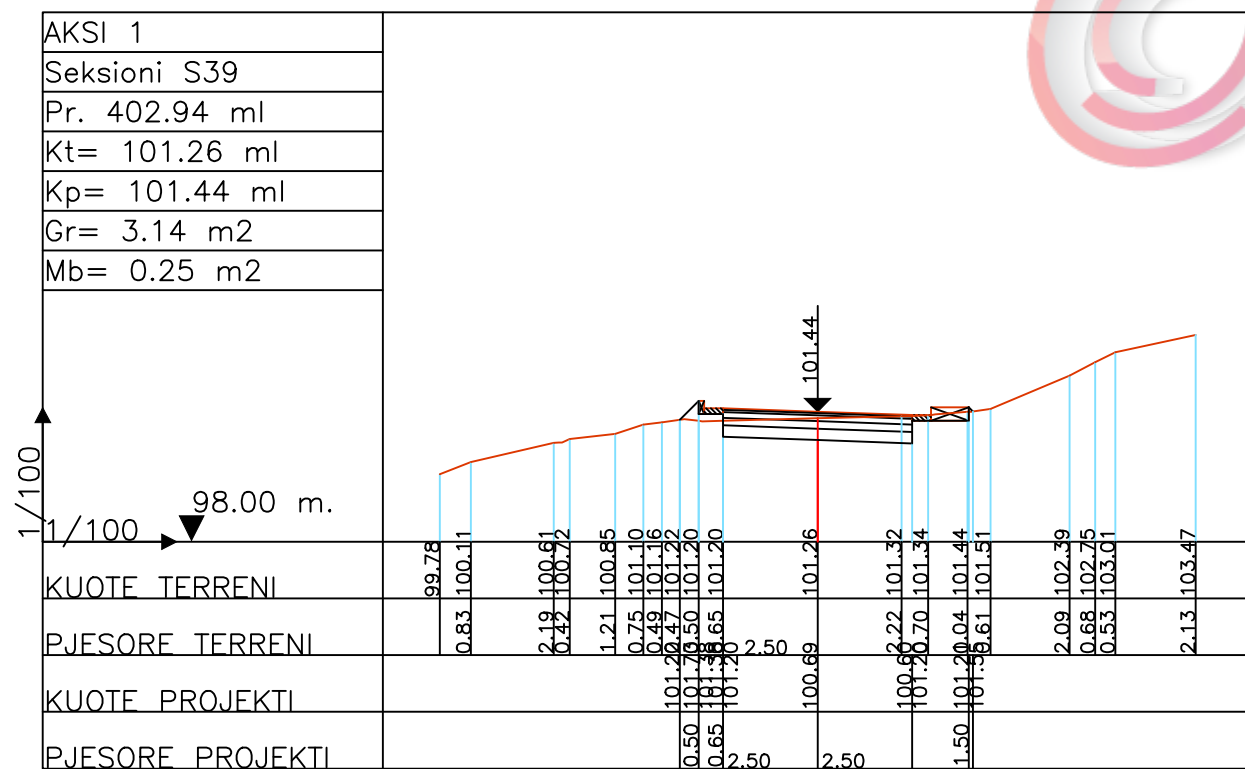
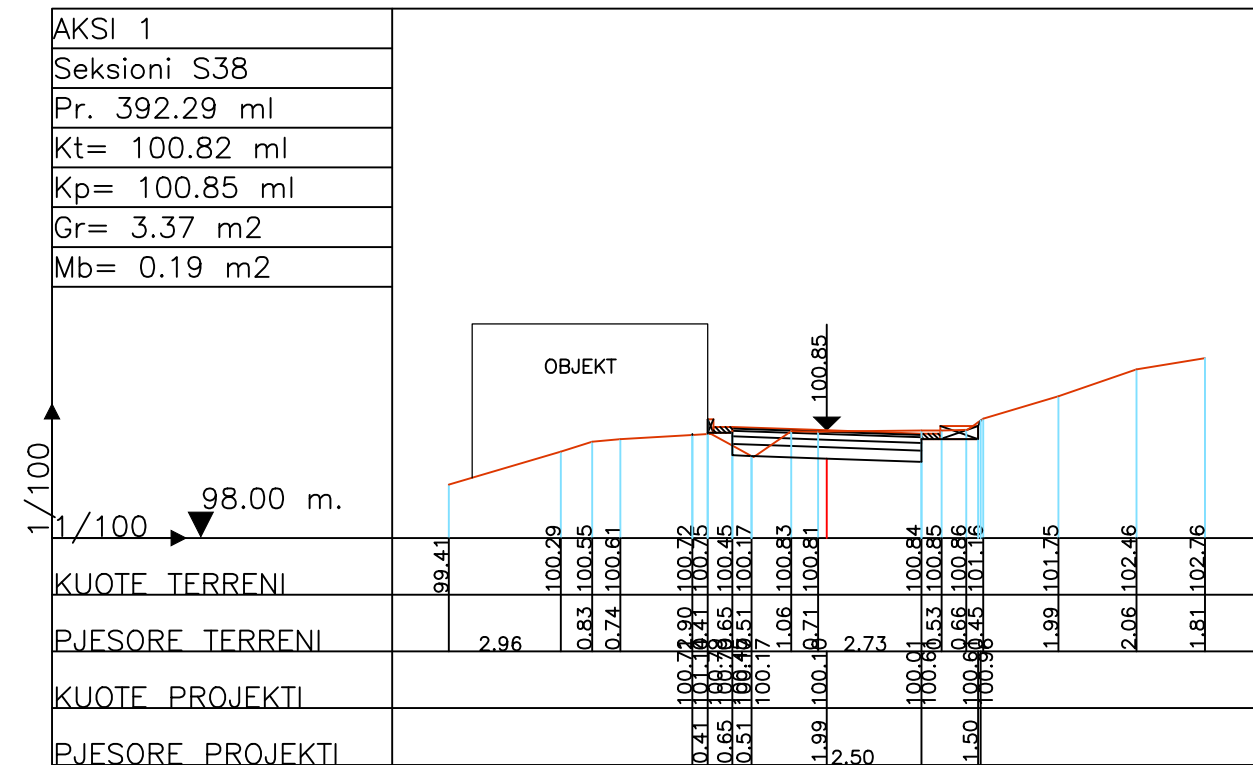
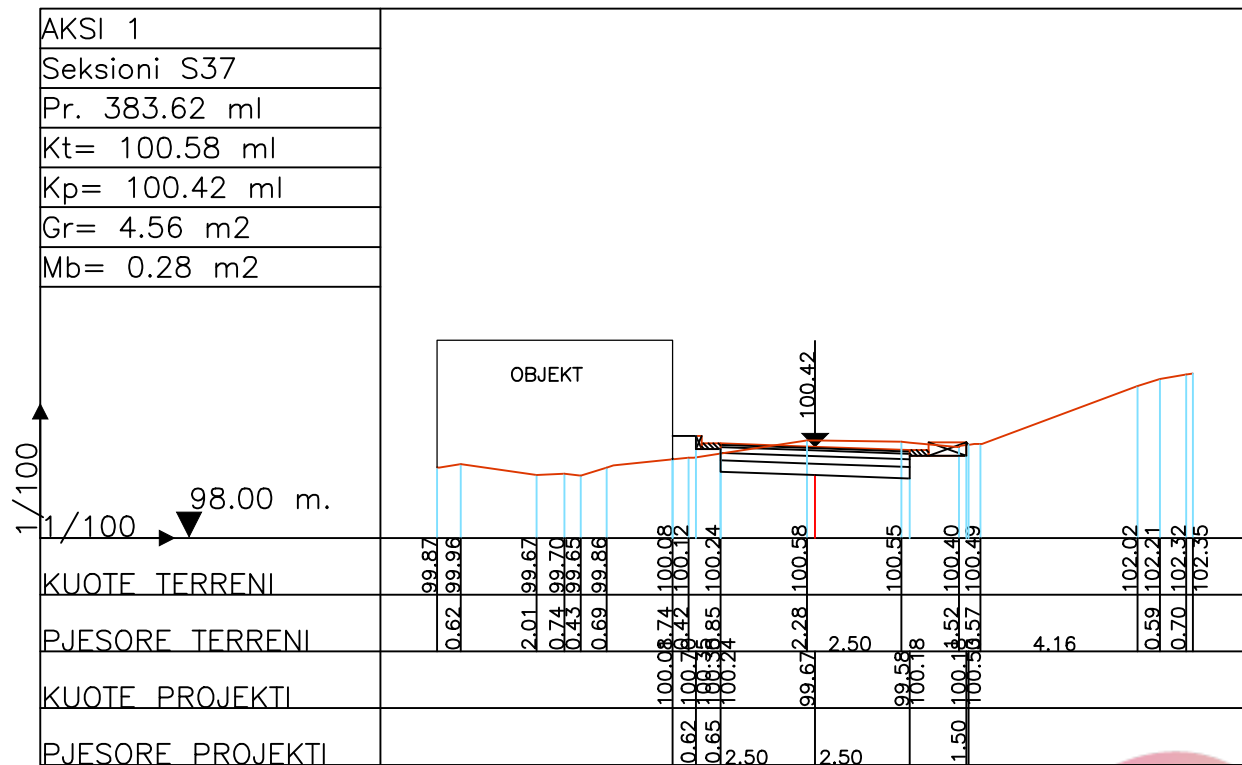

**POROSITESI : BASHKIA VORË**

OBJEKTI:  
"RIKONSTRUKSION I RRUGEVE MUCAJ, SHERAJ DHE E VESLEVE  
FSHATI MUCAJ ,BASHKIA VORE "

Emertimi: PROFILET TERTHORE

**"ARABEL - STUDIO" Sh.p.k**  
Adresa:Njesia Bashkiake nr.7, Rruga "Frosina Plaku",  
Pallati 21, Hyrja 1, Kati 2,Tirane.  
Email: arabelstudio@gmail.com

Drejtesues i projektit

Adm. Ana NISHKU	Nd. Ardi ARKAXHIU	Elek. Altin ALLKAJ
Inxh. Ardi ARKAXHIU	Ark.Rigert HYRA	Top. Mustafa HOXHAI
	Gjeo.Irfan BEGAJ	Hid. Hajredin MURGU

SHKALLA	FLETA
1 : 200	9- 11
Vorë 2019	Format A3

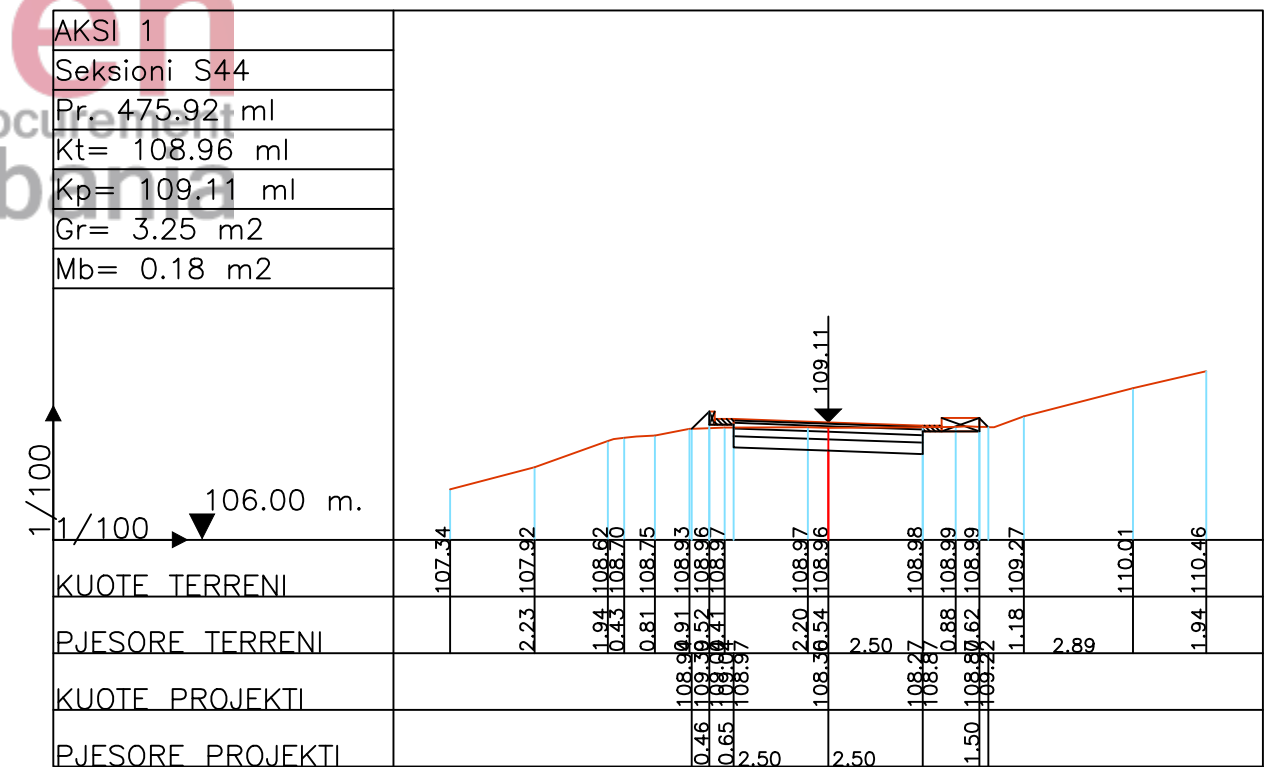
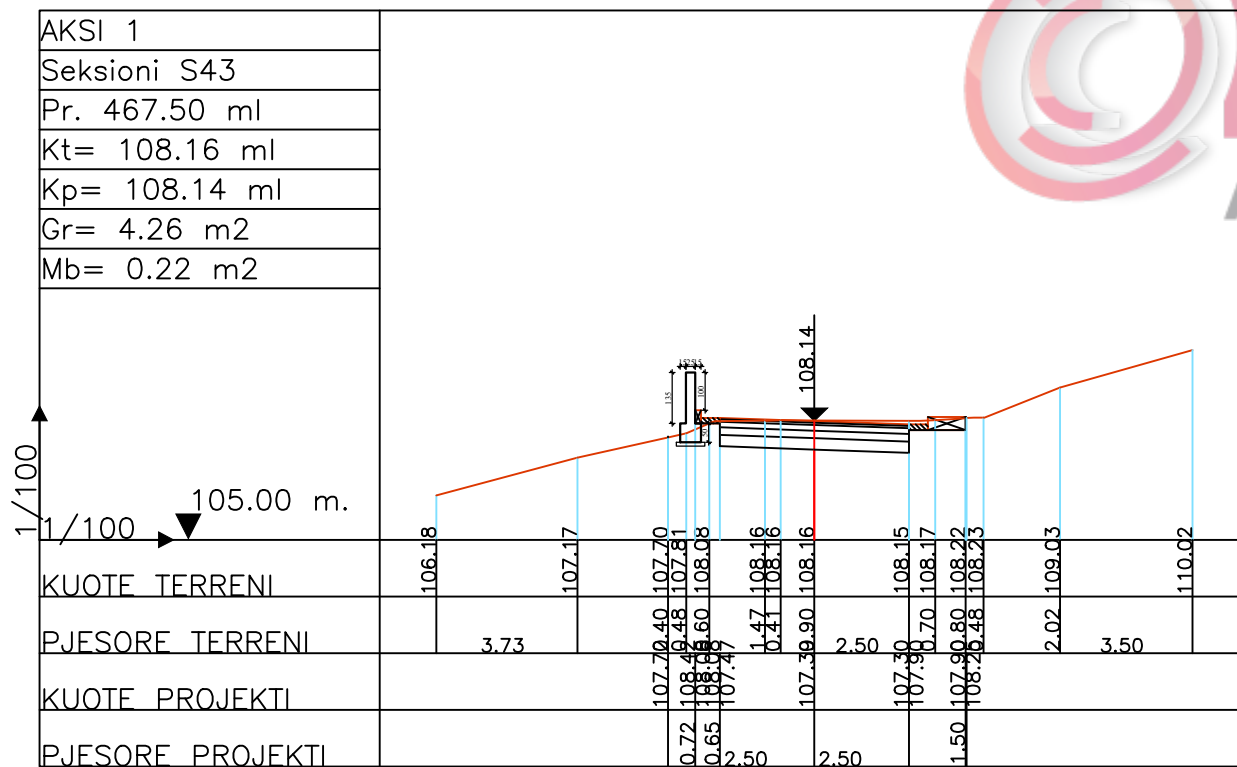
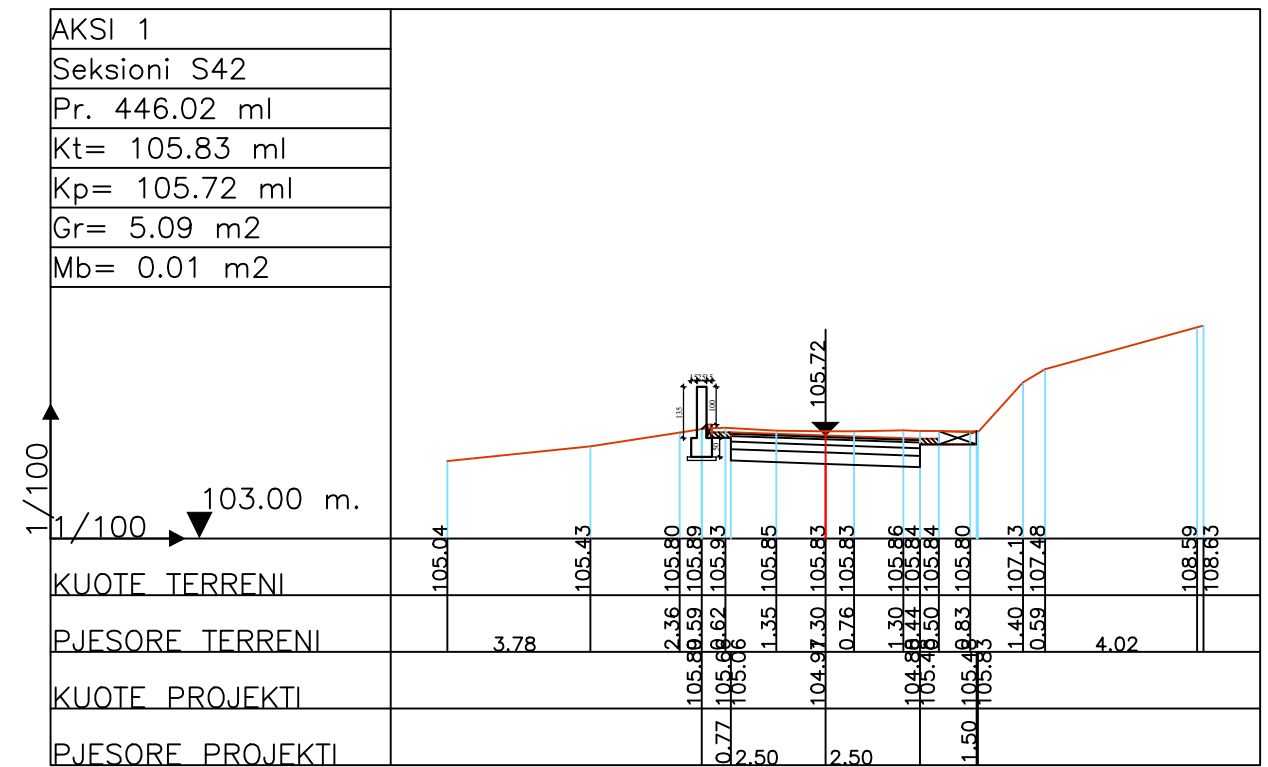
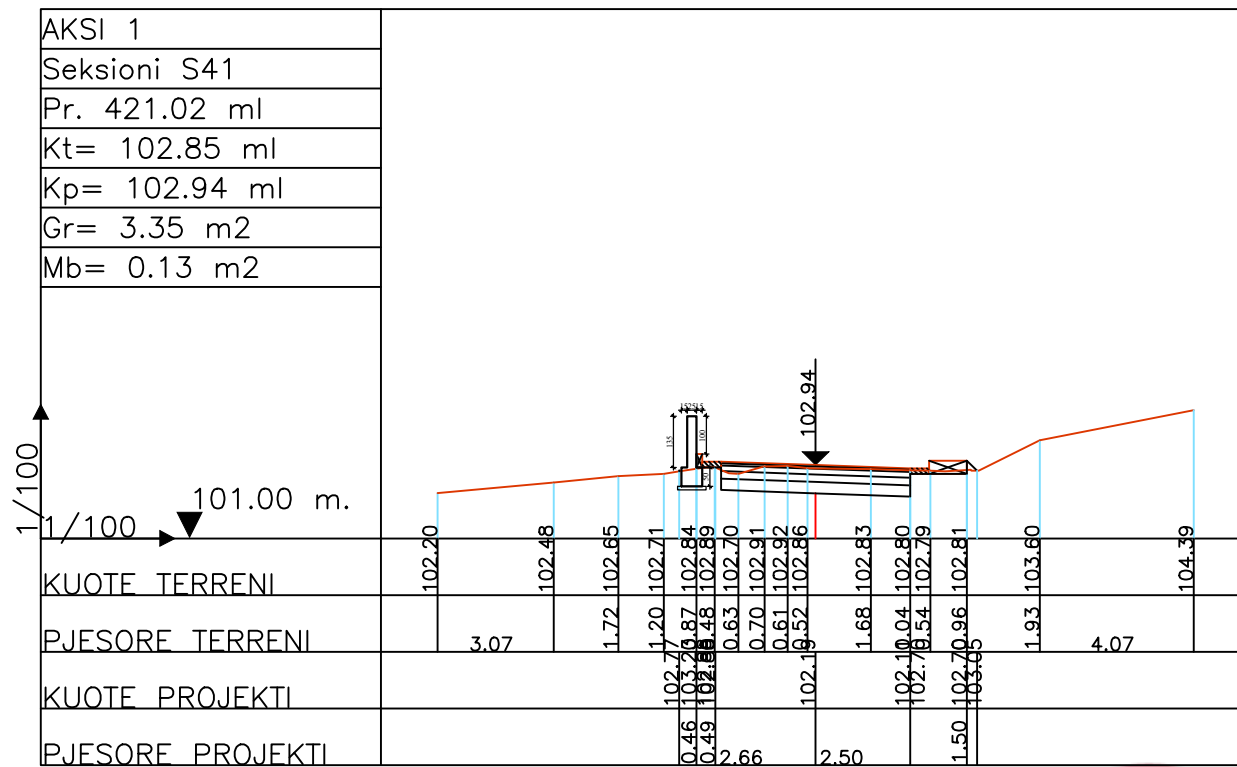

## POROSITESI : BASHKIA VORË

OBJEKTI:  
"RIKONSTRUKSION I RRUGEVE MUCAJ, SHERAJ DHE E VESLEVE  
FSHATI MUCAJ, BASHKIA VORE "

Emertimi: PROFILET TERTHORE



"ARABEL - STUDIO" Sh.p.k  
Adresa: Njesia Bashkiake nr.7, Rruga "Frosina Plaku",  
Pallati 21, Hyrja 1, Kati 2, Tirane.  
Email: arabelstudio@gmail.com

### Drejtesues i projektit

Adm. Ana NISHKU  
Inxh. Ardi ARKAXHIU

### Projektues

Nd. Ardi ARKAXHIU  
Ark. Rigert HYRA  
Gjeo. Irfan BEGAJ  
Elek. Altin ALLKAJ  
Top. Mustafa HOXHAI  
Hid. Hajredin MURGU

### SHKALLA

1 : 200

Vorë 2019

### FLETA

9- 12

Format A3

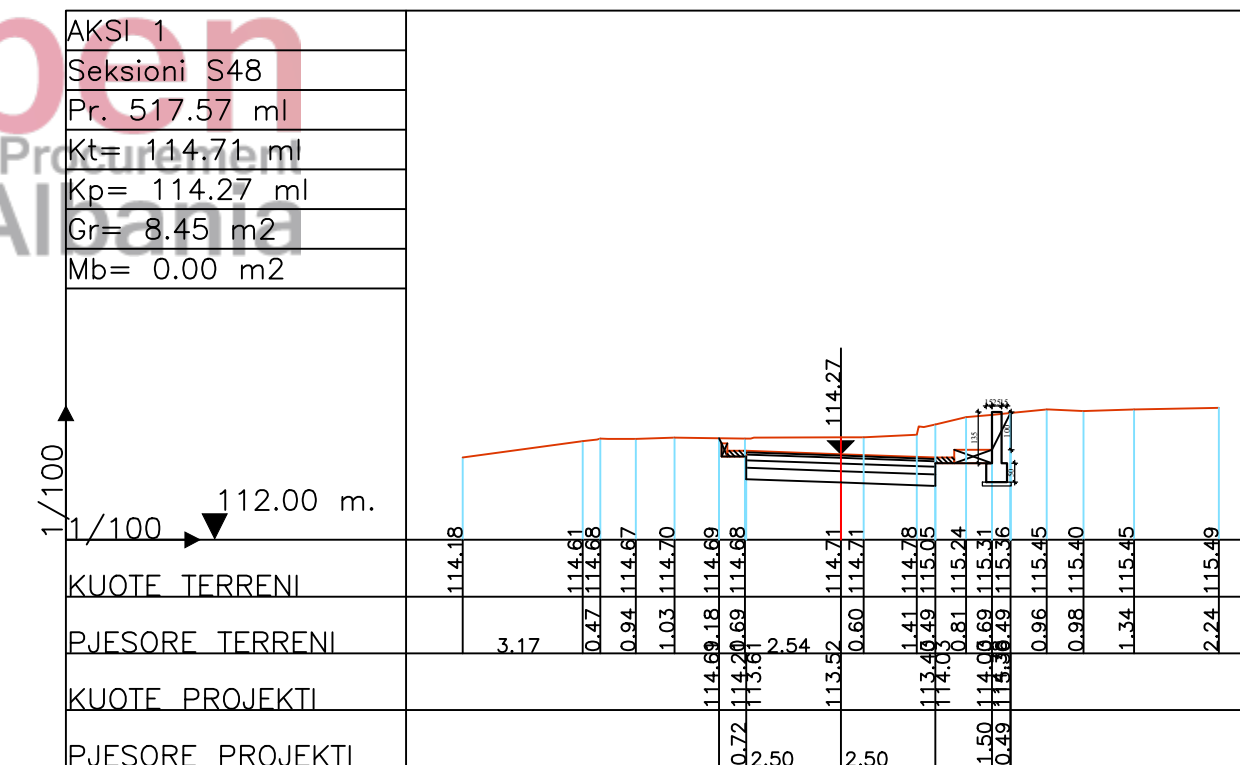
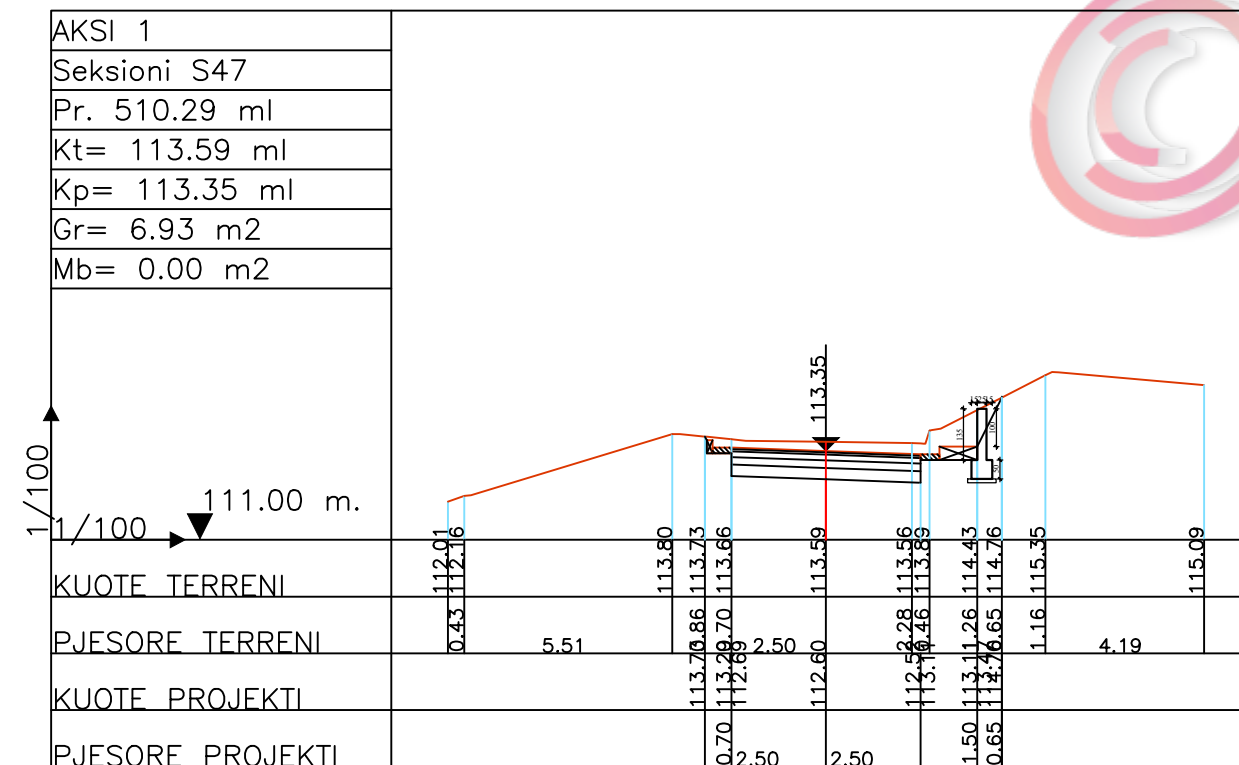
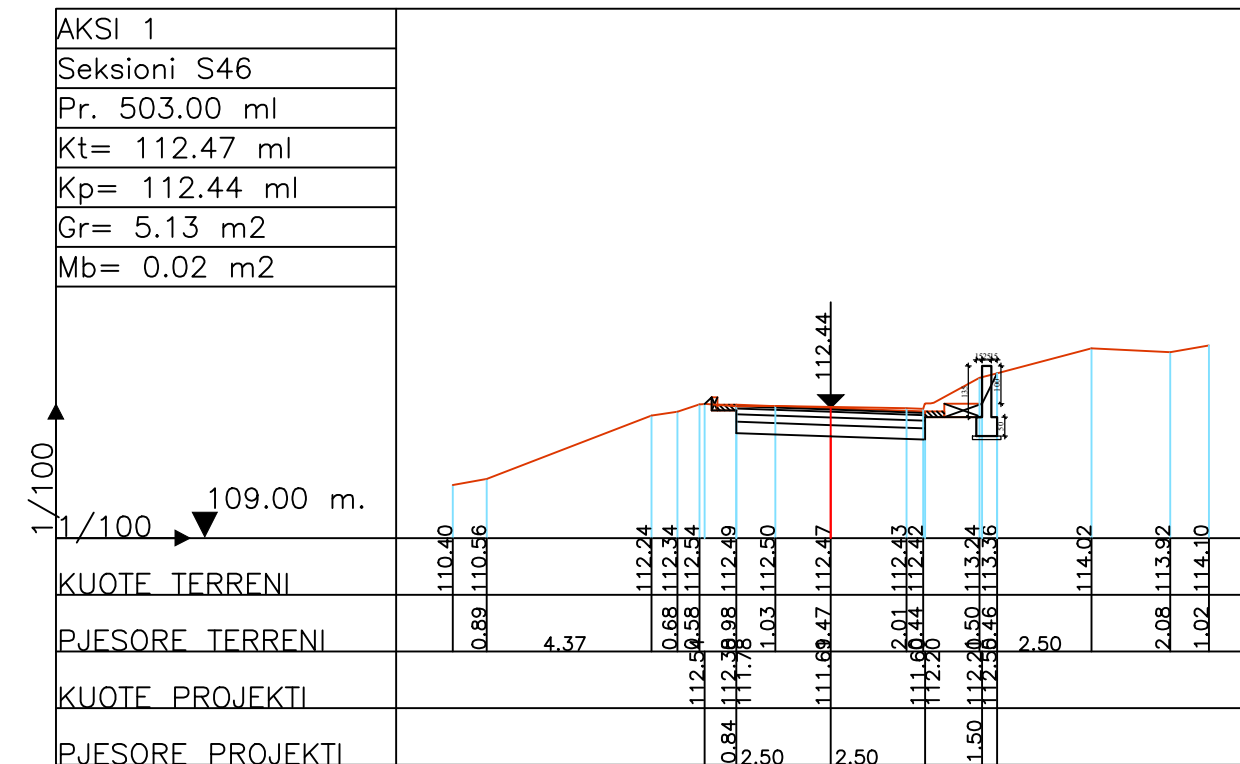
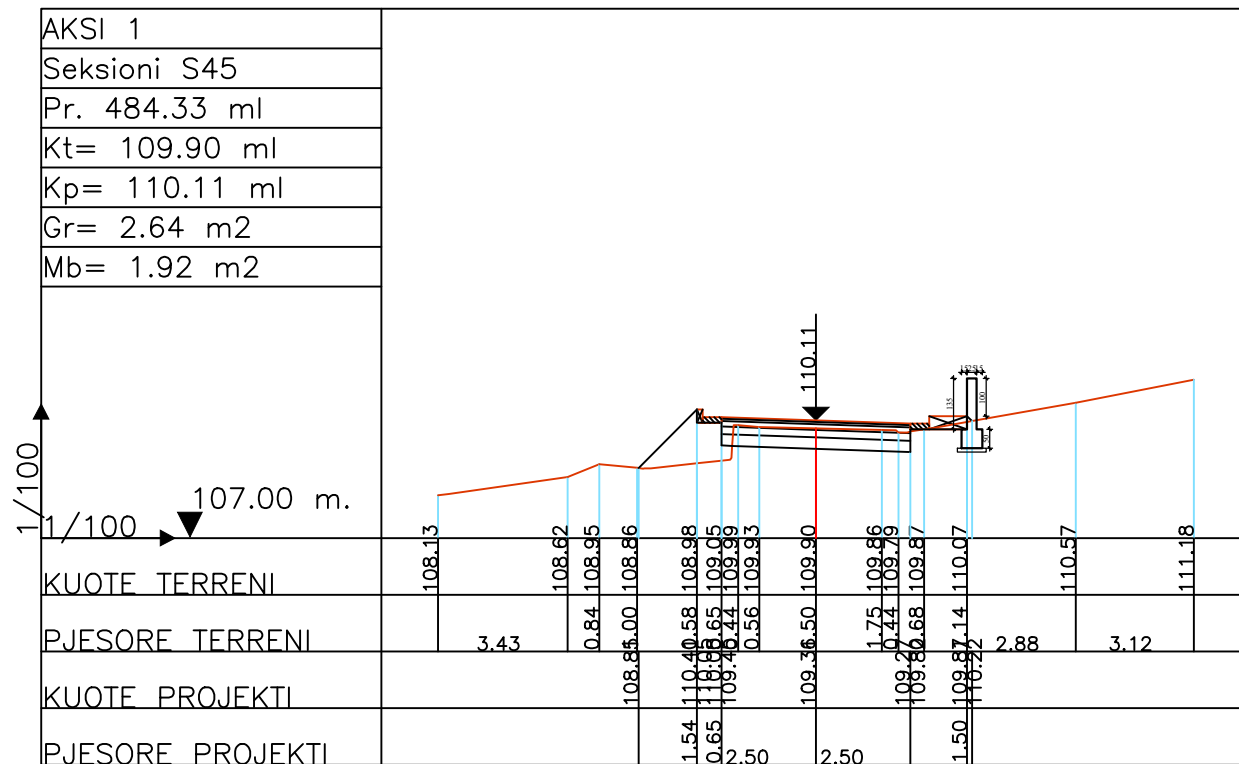

**POROSITESI : BASHKIA VORË**

OBJEKTI:  
"RIKONSTRUKSION I RRUGEVE MUCAJ, SHERAJ DHE E VESLEVE FSHATI MUCAJ ,BASHKIA VORE "

Emertimi: PROFILET TERTHORE

**"ARABEL - STUDIO" Sh.p.k**  
Adresa: Njesia Bashkiake nr.7, Rruga "Frosina Plaku", Pallati 21, Hyrja 1, Kati 2, Tirane.  
Email: arabelstudio@gmail.com

Drejtesues i projektit

Adm. Ana NISHKU  
Inxh. Ardi ARKAXHIU

Projektues

Nd. Ardi ARKAXHIU  
Ark.Rigert HYRA  
Gjeo.Irfan BEGAJ

Elek. Altin ALLKAJ  
Top. Mustafa HOXHAI  
Hid. Hajredin MURGU

SHKALLA

1 : 200

Vorë 2019

FLETA

9- 13

Format A3



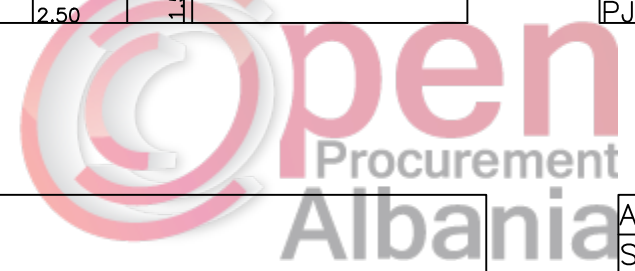
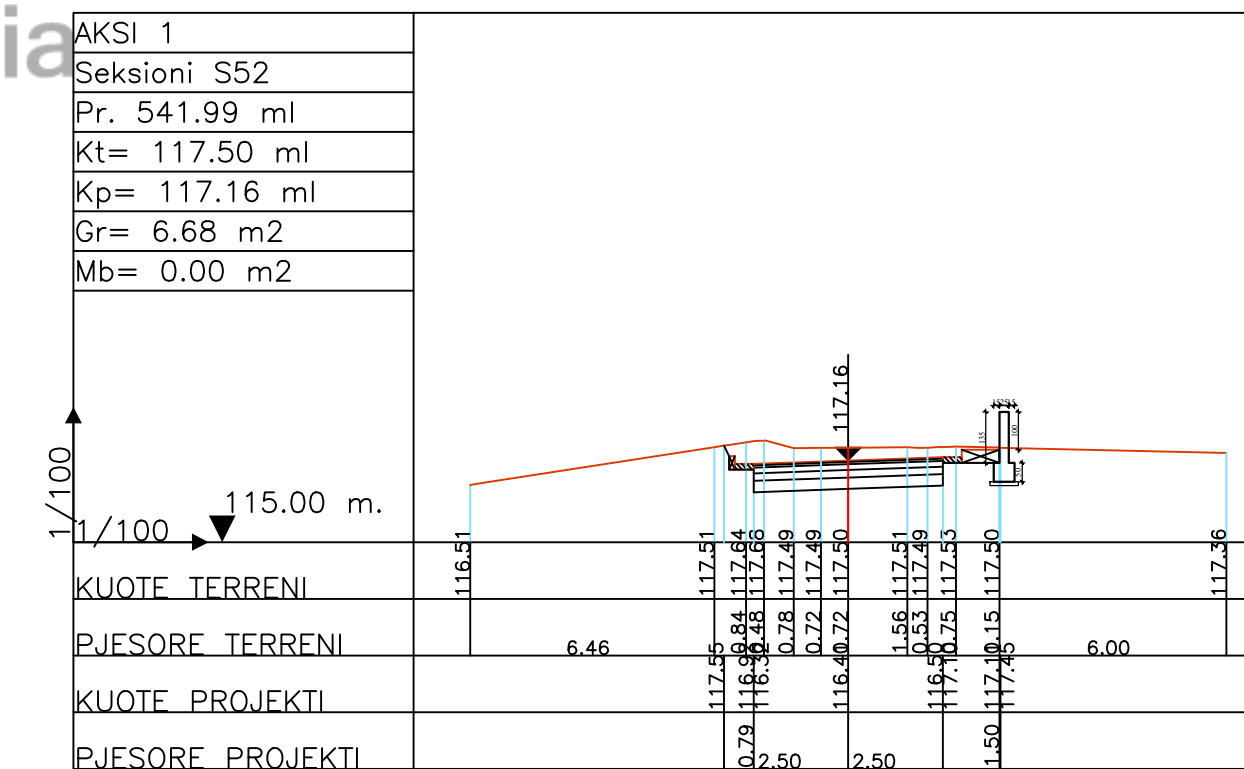
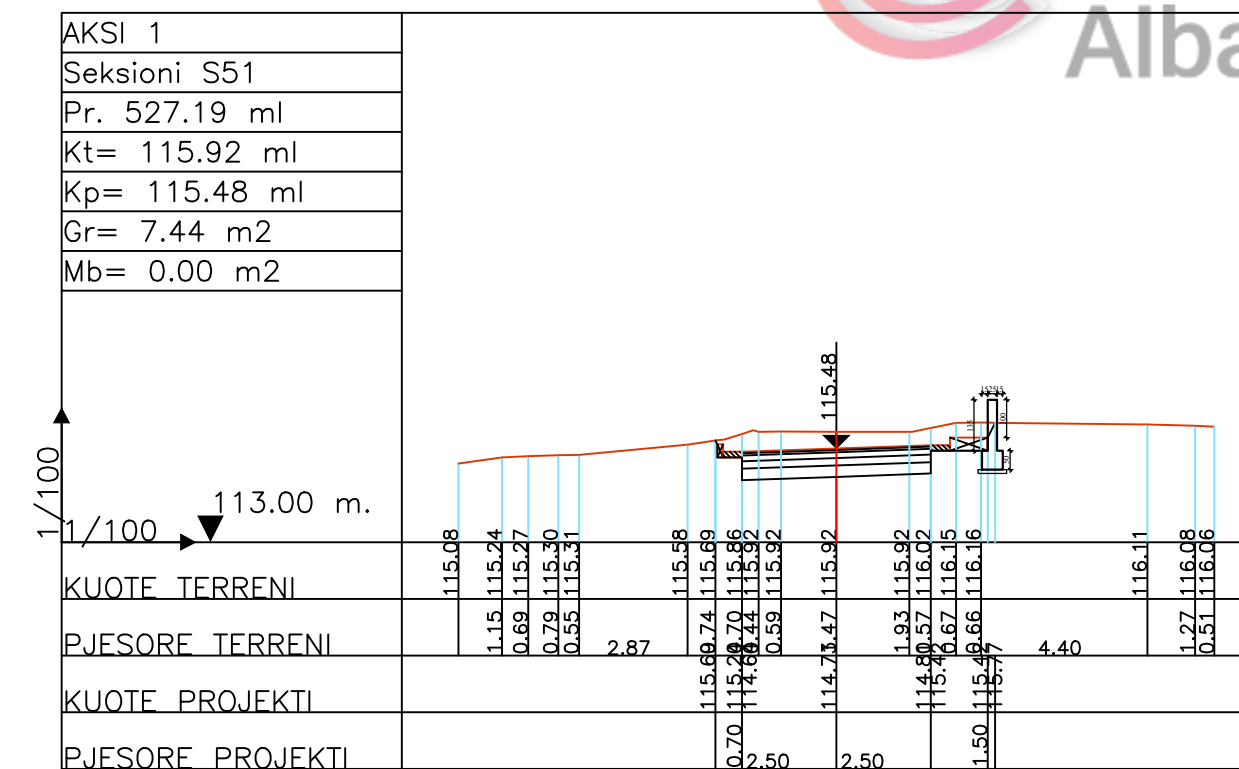
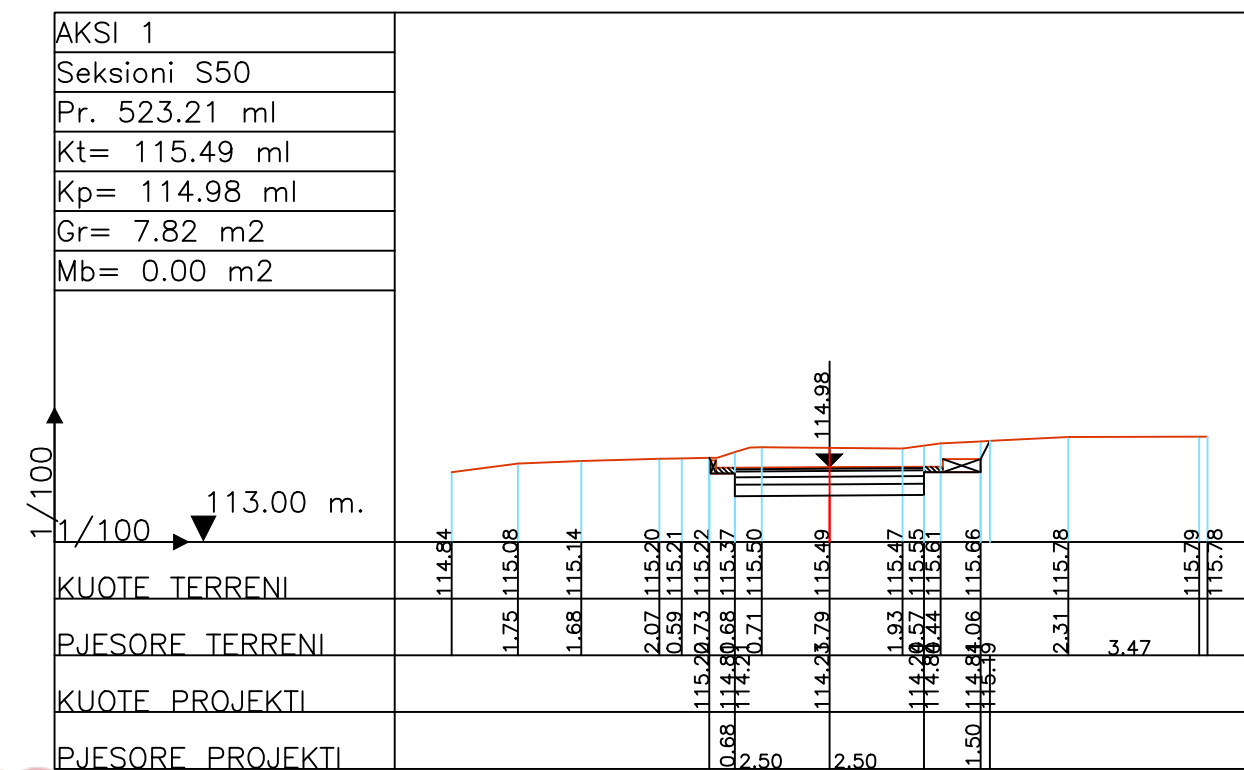
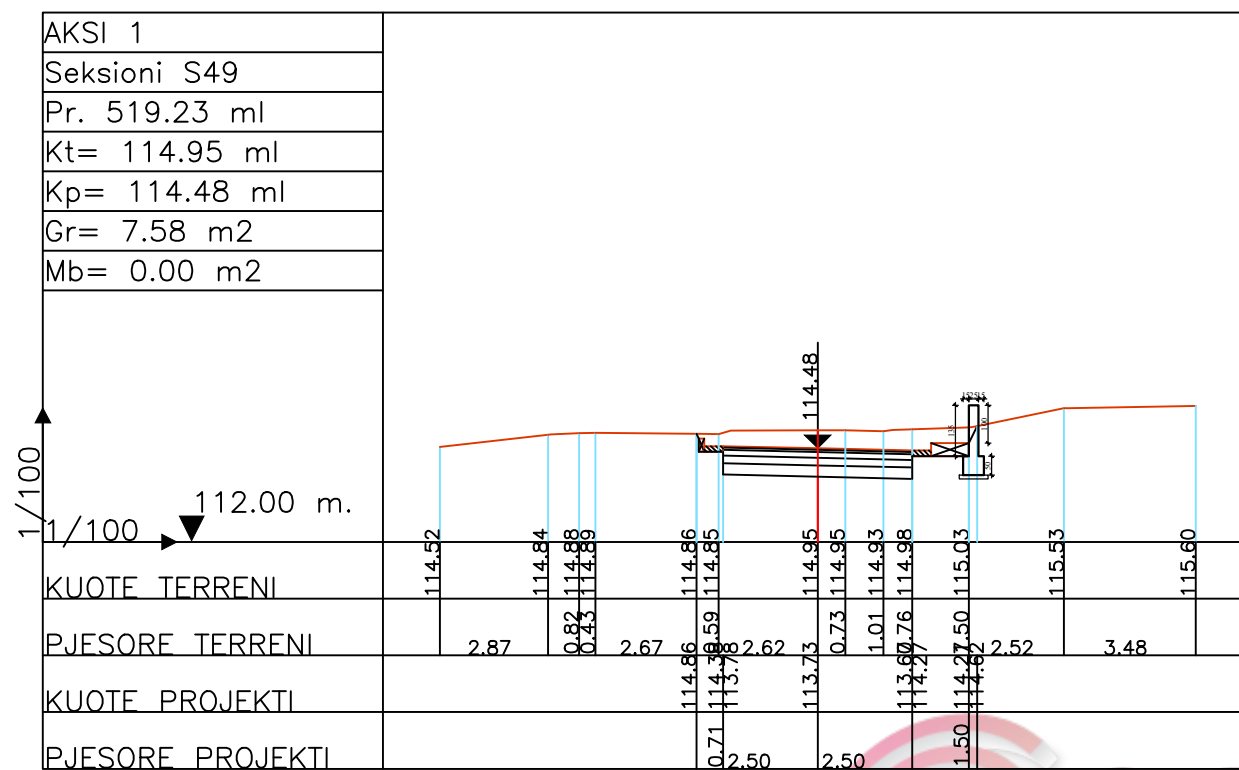

**POROSITESI : BASHKIA VORË**

OBJEKTI:  
"RIKONSTRUKSION I RRUGEVE MUCAJ, SHERAJ DHE E VESLEVE FSHATI MUCAJ ,BASHKIA VORE "

Emertimi: PROFILET TERTHORE

**"ARABEL - STUDIO" Sh.p.k**  
Adresa: Njesia Bashkiake nr.7, Rruga "Frosina Plaku", Pallati 21, Hyrja 1, Kati 2, Tirane.  
Email: arabelstudio@gmail.com

**Drejtesues i projektit**

Adm. Ana NISHKU	Nd. Ardi ARKAXHIU	Elek. Altin ALLKAJ
Inxh. Ardi ARKAXHIU	Ark.Rigert HYRA	Top. Mustafa HOXHAI
	Gjeo.Irfan BEGAJ	Hid. Hajredin MURGU

<b>SHKALLA</b>	<b>FLETA</b>
1 : 200	9- 14
Vorë 2019	Format A3

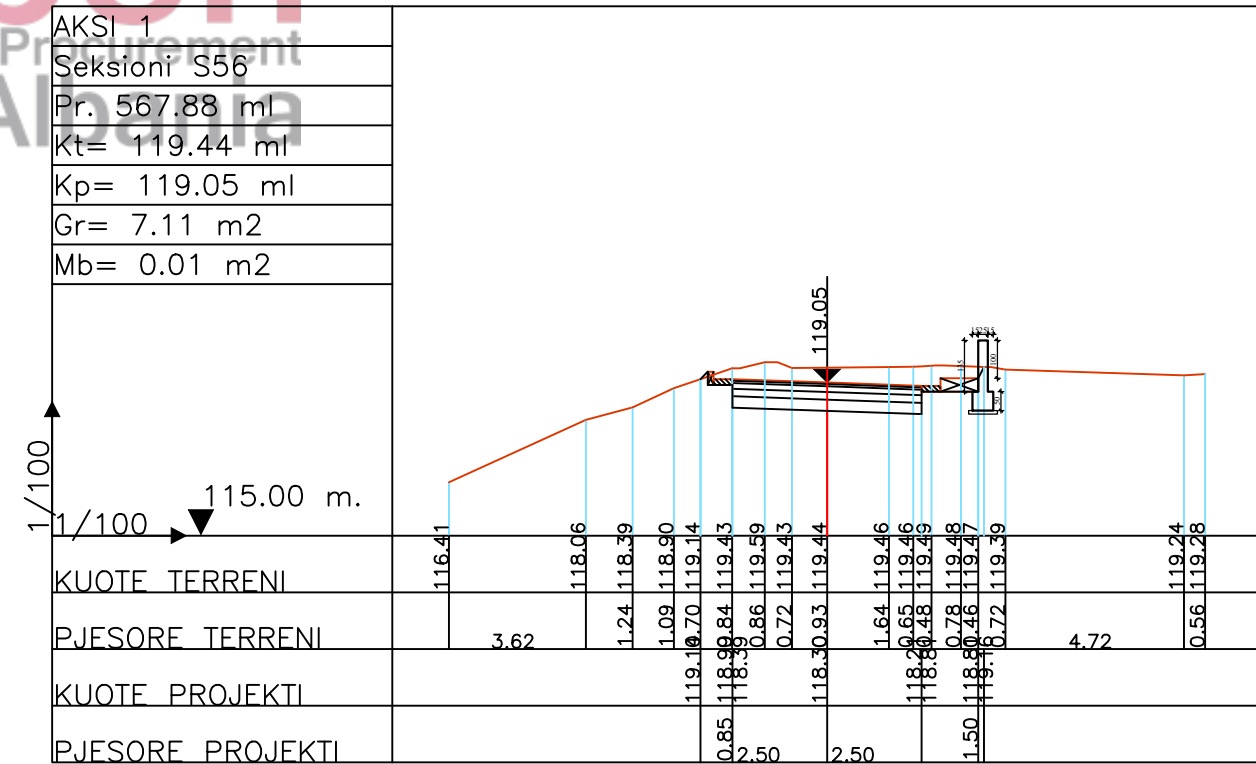
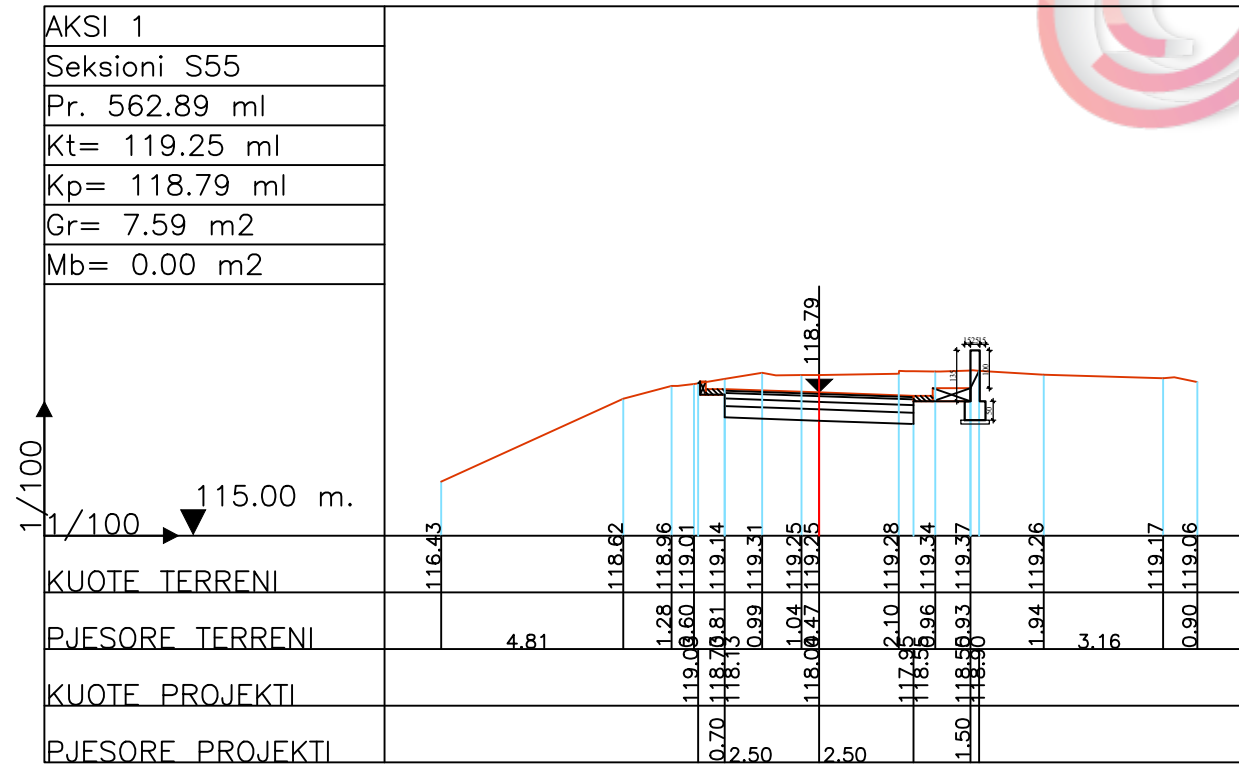
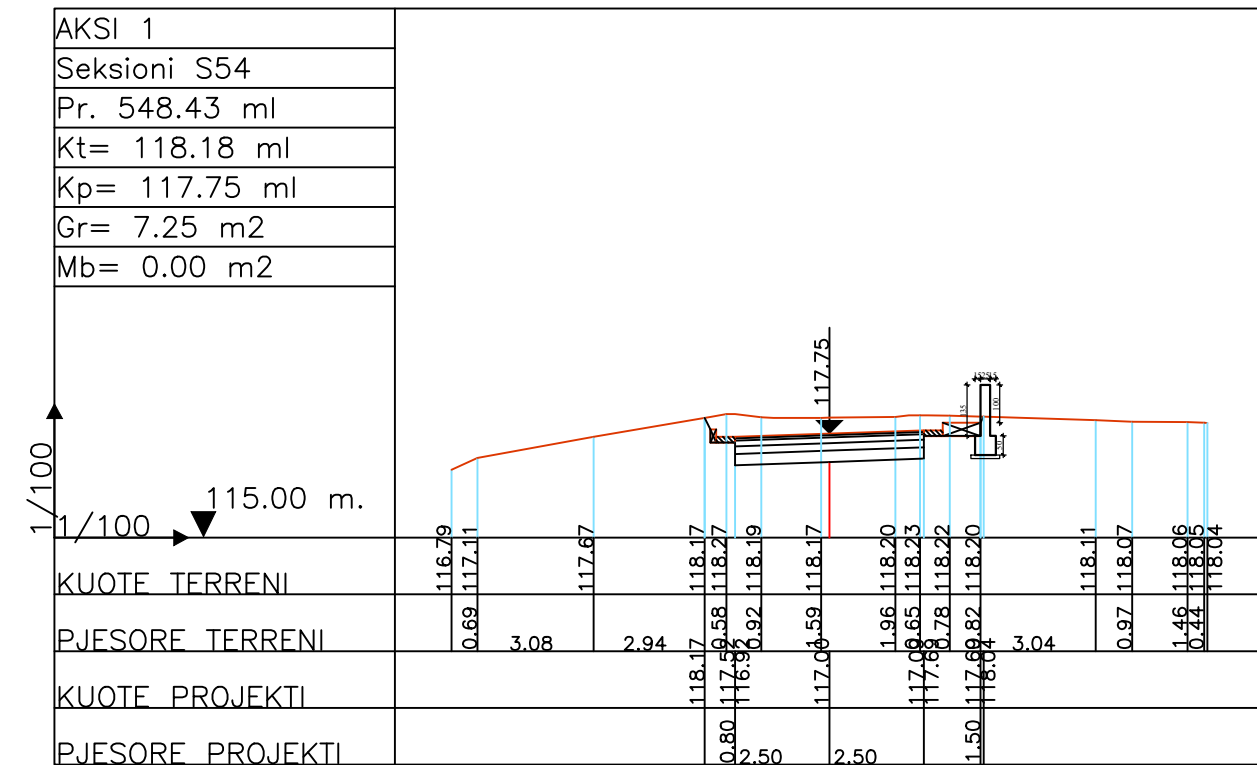
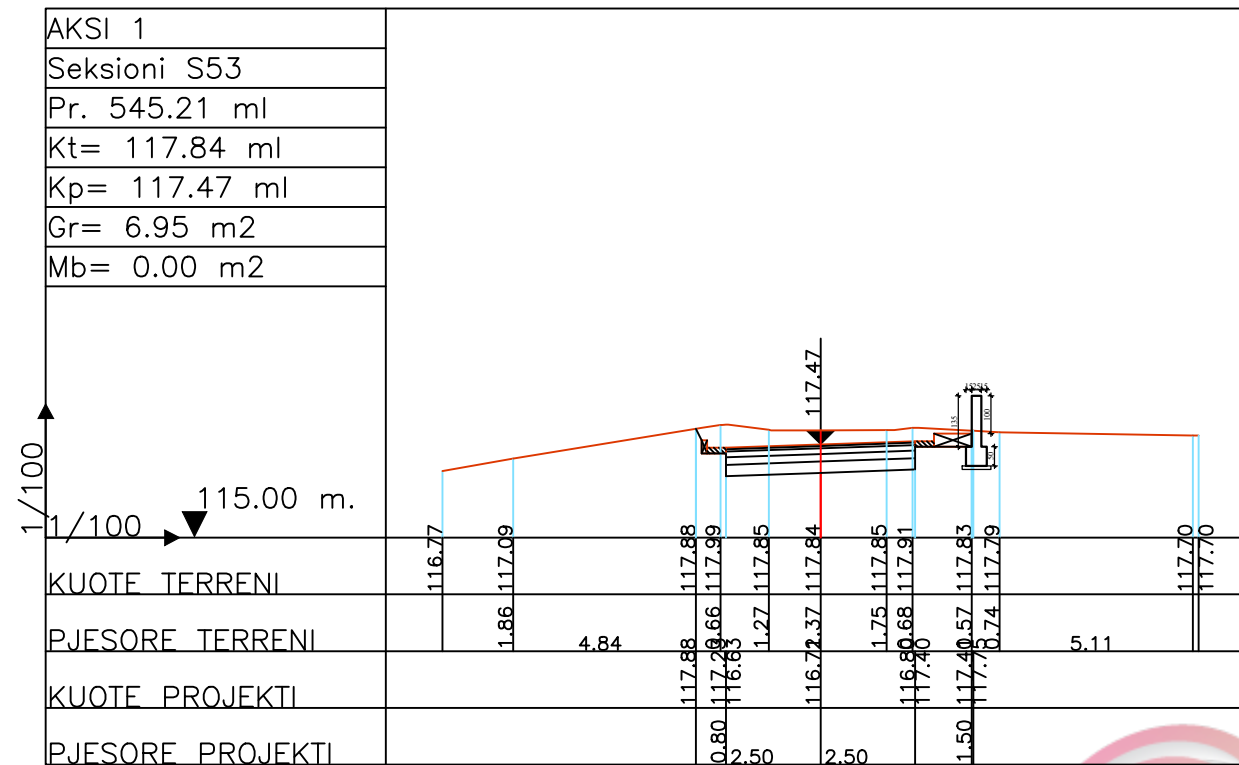

**POROSITESI : BASHKIA VORË**

OBJEKTI:  
"RIKONSTRUKSION I RRUGEVE MUCAJ, SHERAJ DHE E VESLEVE FSHATI MUCAJ ,BASHKIA VORE "

Emertimi: PROFILET TERTHORE

**"ARABEL - STUDIO" Sh.p.k**  
Adresa: Njesia Bashkiake nr.7, Rruga "Frosina Plaku", Pallati 21, Hyrja 1, Kati 2, Tirane.  
Email: arabelstudio@gmail.com

Drejtues i projektit

Adm. Ana NISHKU  
Inxh. Ardi ARKAXHIU

Projektues

Nd. Ardi ARKAXHIU  
Ark.Rigert HYRA  
Gjeo.Irfan BEGAJ

Elek. Altin ALLKAJ  
Top. Mustafa HOXHAI  
Hid. Hajredin MURGU

SHKALLA

1 : 200

Vorë 2019

FLETA

9- 15

Format A3

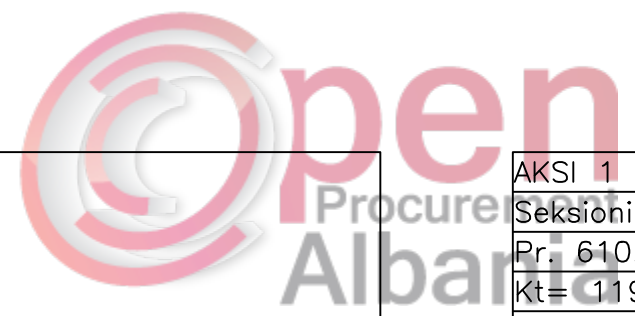
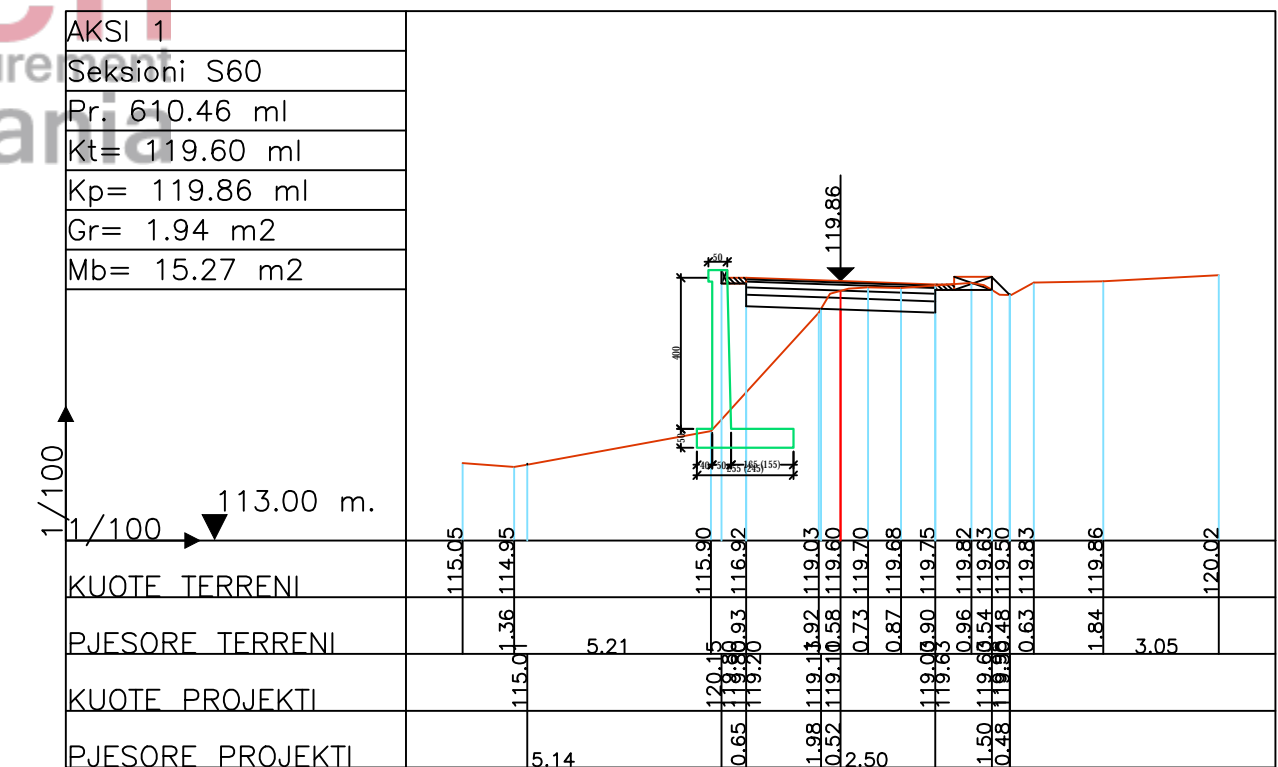
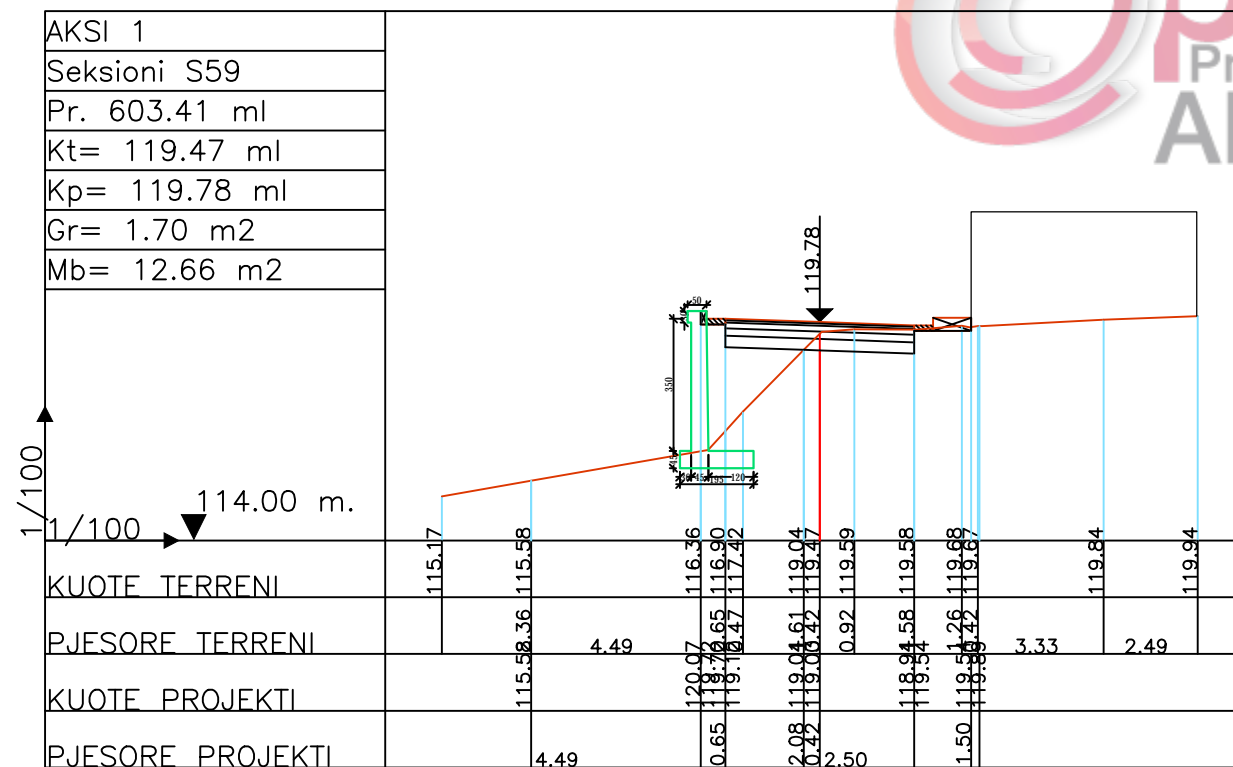
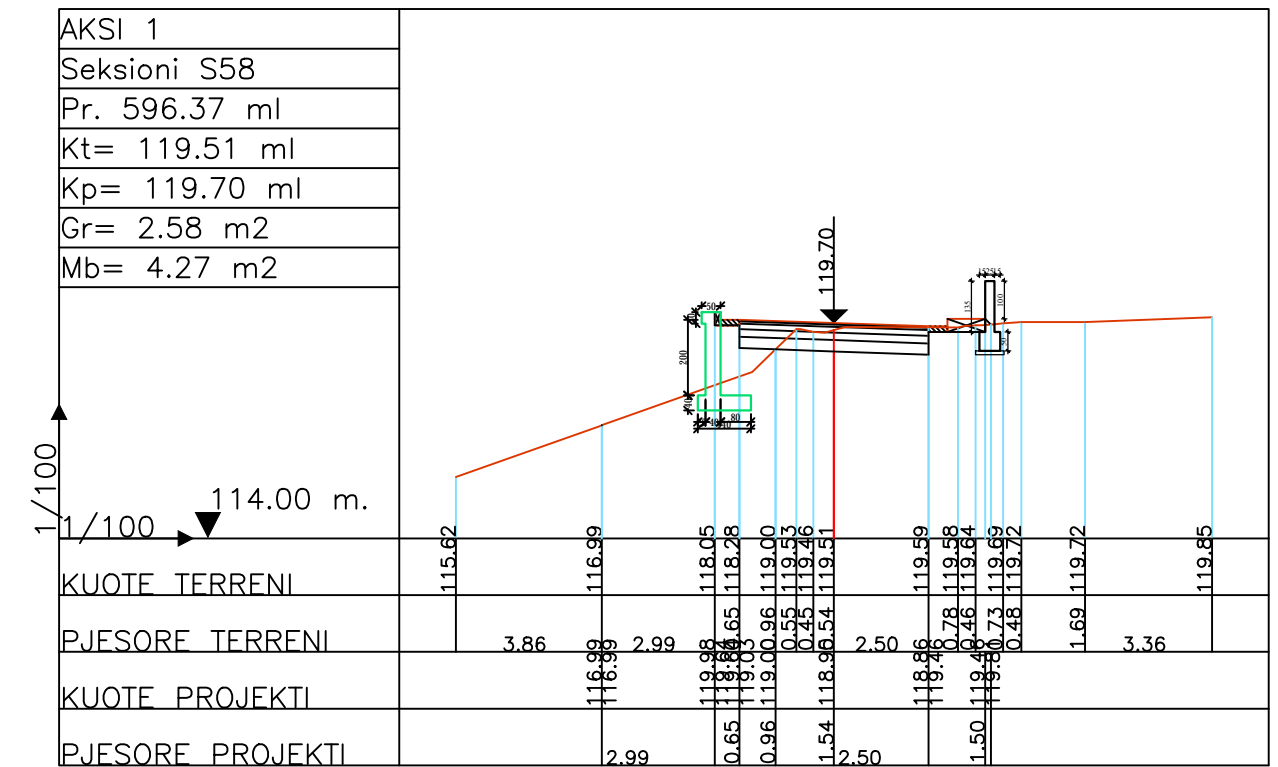
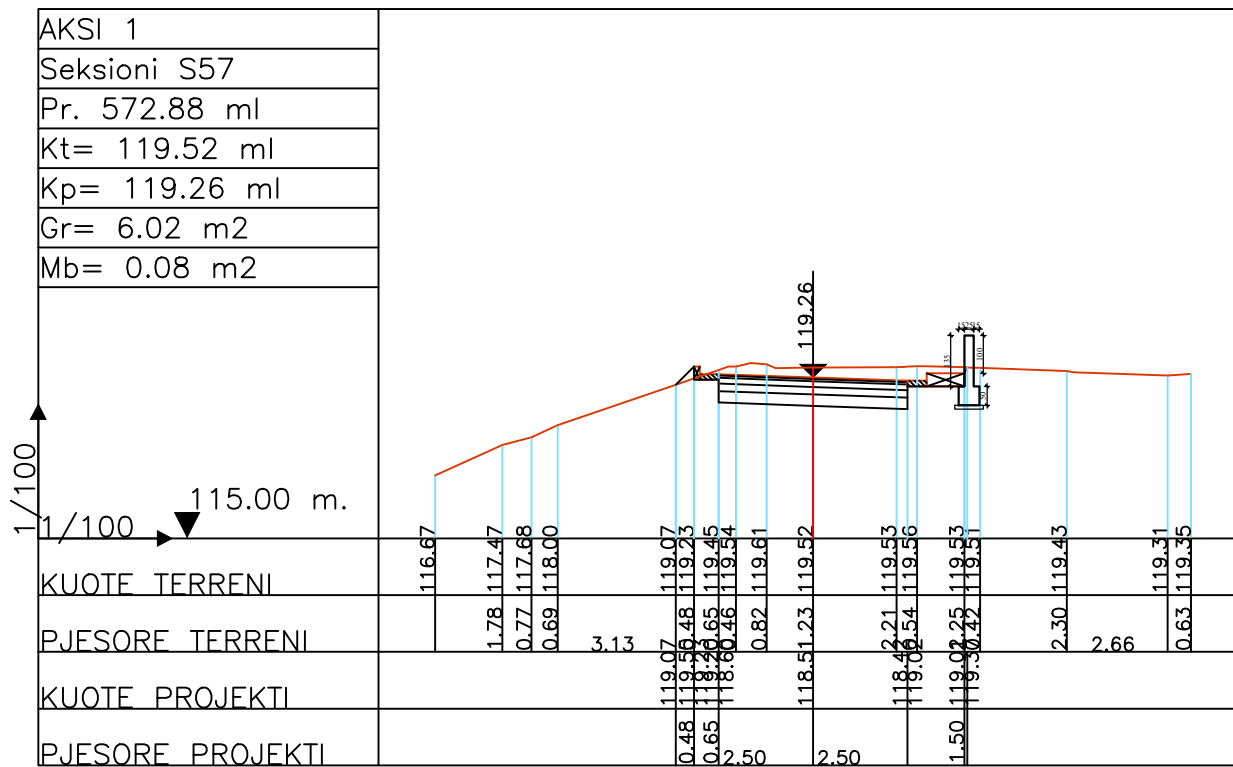

**POROSITESI : BASHKIA VORË**

OBJEKTI:  
"RIKONSTRUKSION I RRUGEVE MUCAJ, SHERAJ DHE E VESLEVE FSHATI MUCAJ, BASHKIA VORE "

Emertimi: PROFILET TERTHORE

**"ARABEL - STUDIO" Sh.p.k**  
Adresa: Njesia Bashkiake nr.7, Rruga "Frosina Plaku", Pallati 21, Hyrja 1, Kati 2, Tirane.  
Email: arabelstudio@gmail.com

Drejtesues i projektit

Adm. Ana NISHKU	Nd. Ardi ARKAXHIU	Elek. Altin ALLKAJ
Inxh. Ardi ARKAXHIU	Ark.Rigert HYRA	Top. Mustafa HOXHAI
	Gjeo.Irfan BEGAJ	Hid. Hajredin MURGU

SHKALLA	FLETA
1 : 200	9- 16
Vorë 2019	Format A3

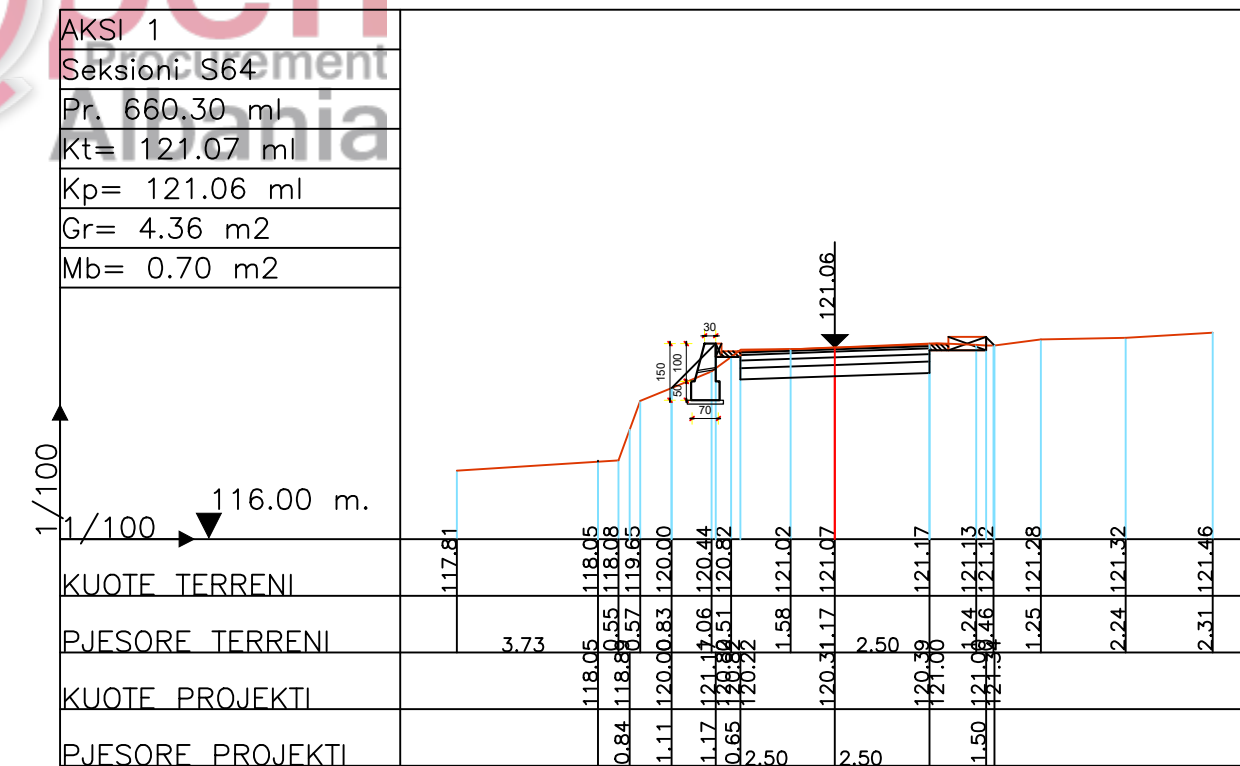
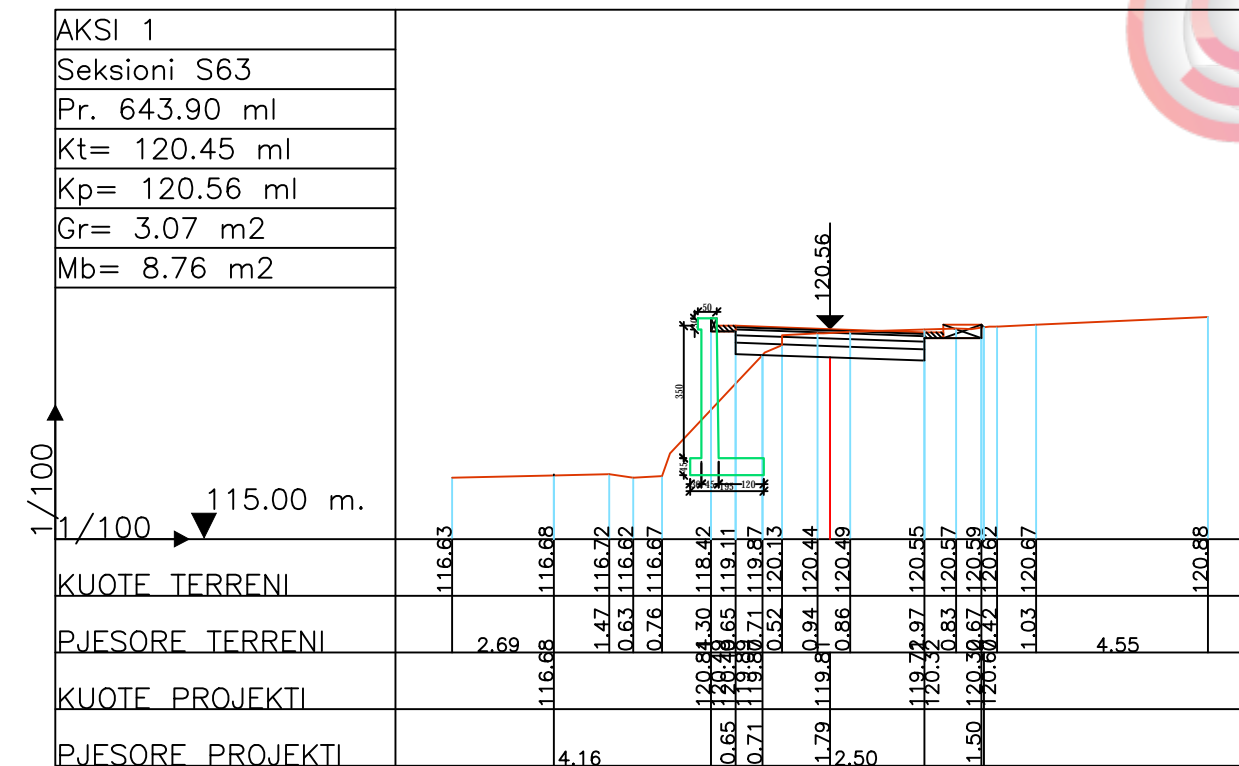
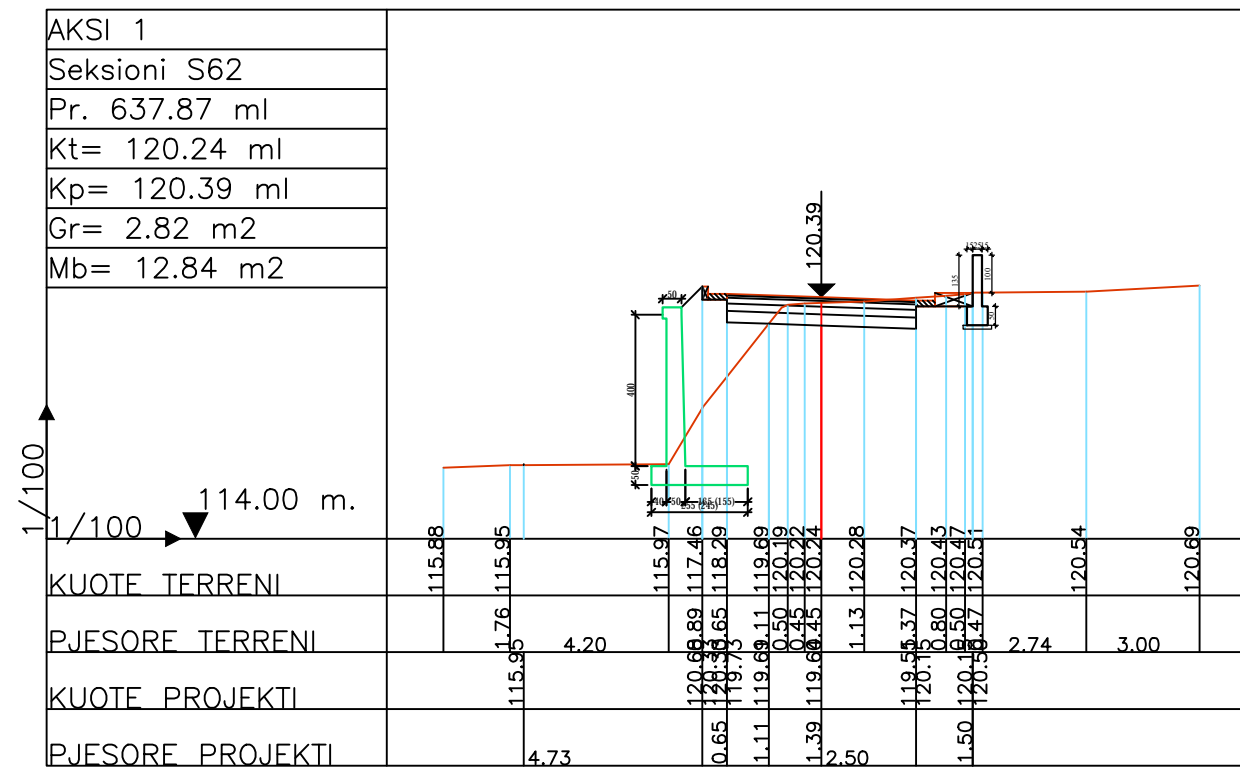
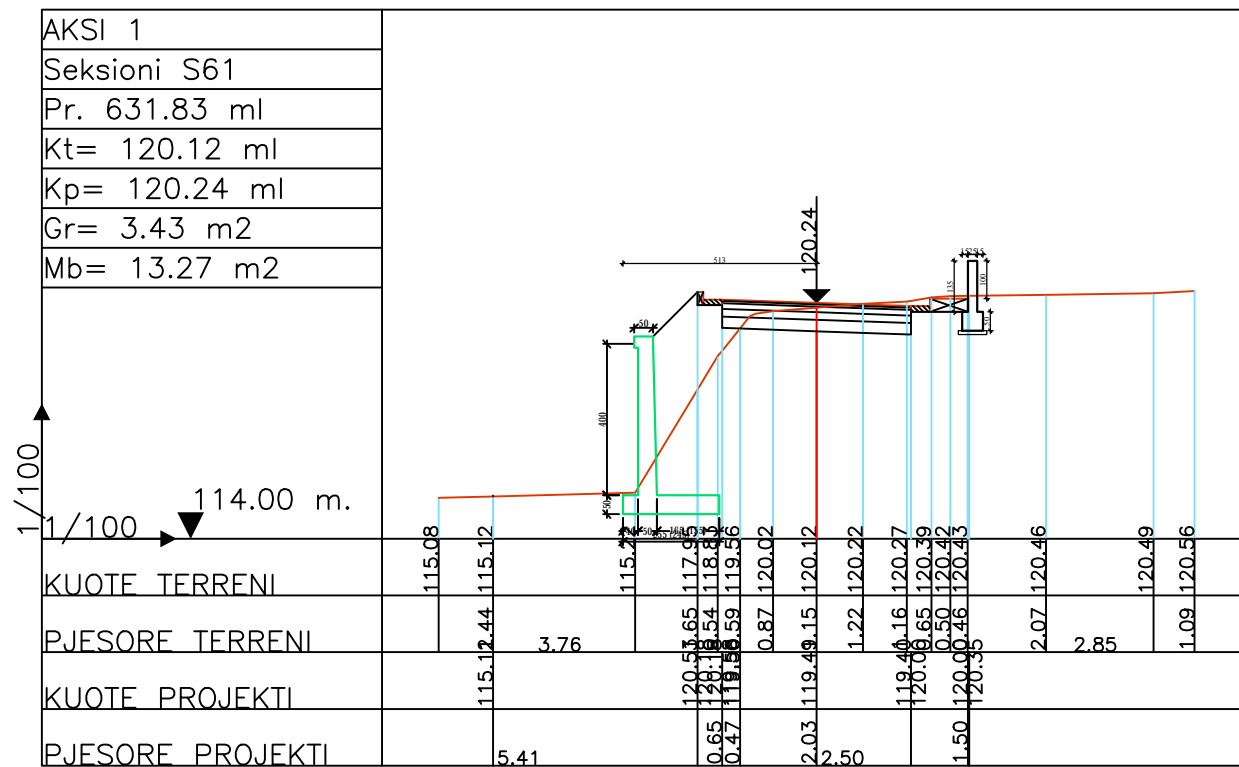

**POROSITESI : BASHKIA VORË**

OBJEKTI:  
"RIKONSTRUKSION I RRUGEVE MUCAJ, SHERAJ DHE E VESLEVE FSHATI MUCAJ ,BASHKIA VORE "

Emertimi: PROFILET TERTHORE

**"ARABEL - STUDIO" Sh.p.k**  
Adresa: Njesia Bashkiake nr.7, Rruga "Frosina Plaku", Pallati 21, Hyrja 1, Kati 2, Tirane.  
Email: arabelstudio@gmail.com

**Drejtues i projektit**  
Adm. Ana NISHKU  
Inxh. Ardi ARKAXHIU

**Projektues**  
Nd. Ardi ARKAXHIU  
Ark.Rigert HYRA  
Gjeo.Irfan BEGAJ

Elek. Altin ALLKAJ  
Top. Mustafa HOXHAI  
Hid. Hajredin MURGU

**SHKALLA**  
1 : 200

**FLETA**  
9- 17

Vorë 2019  
Format A3

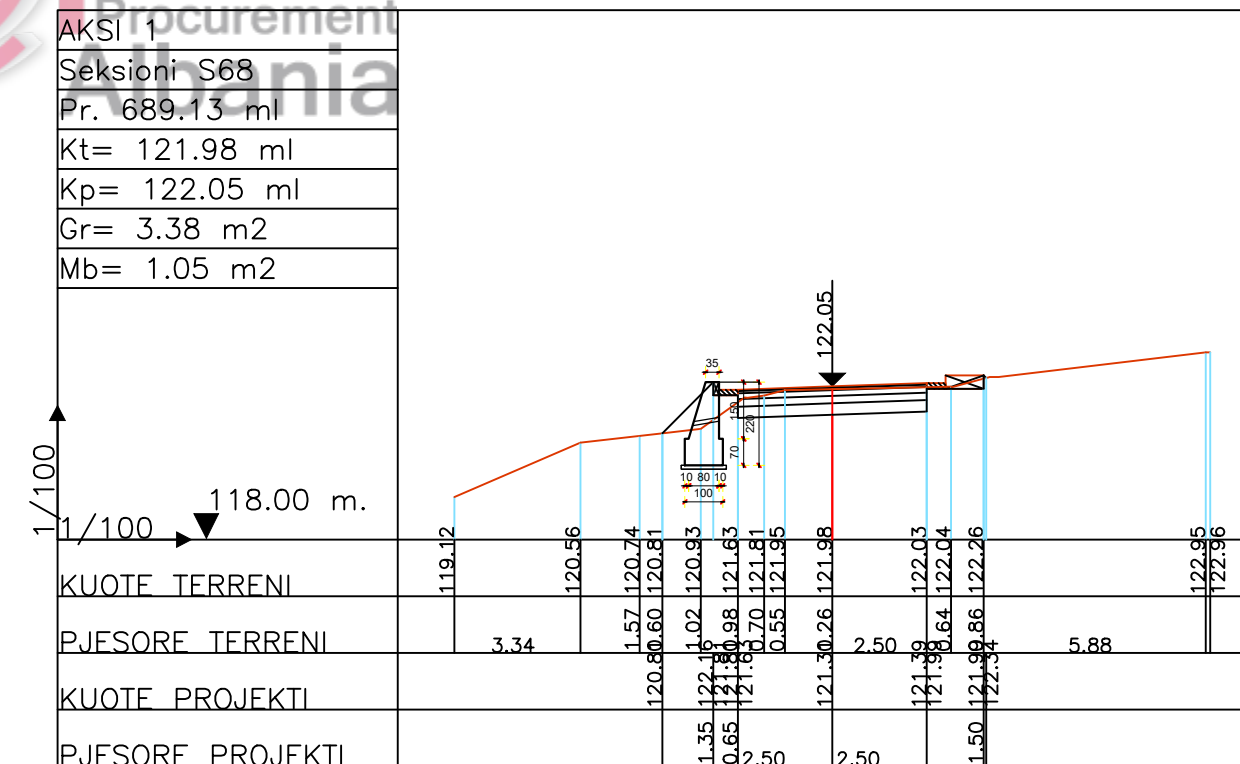
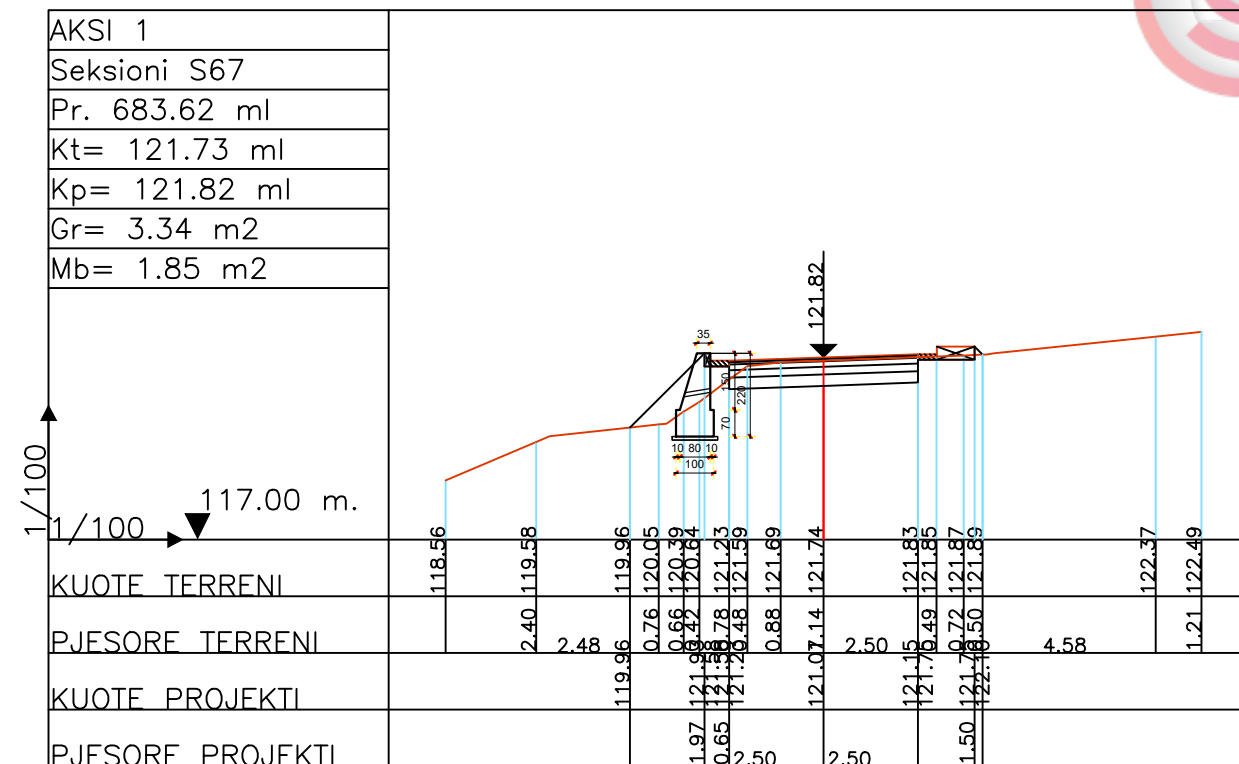
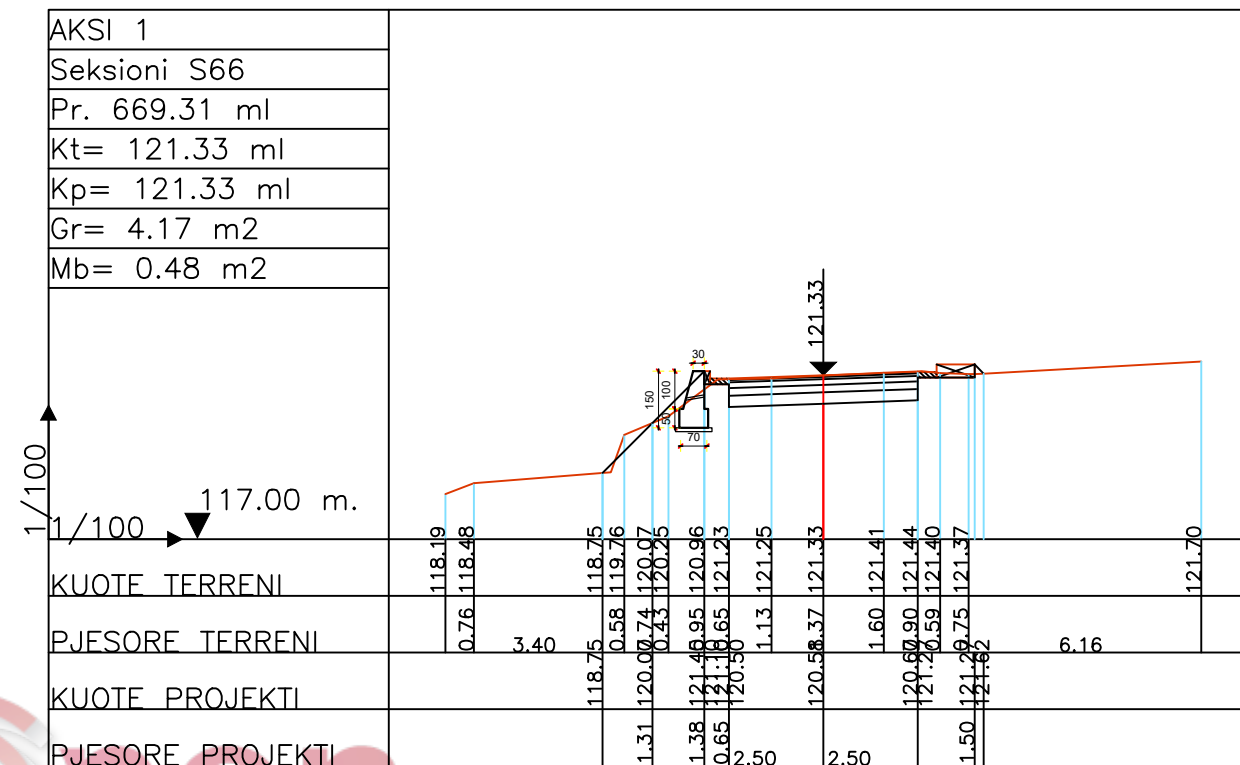
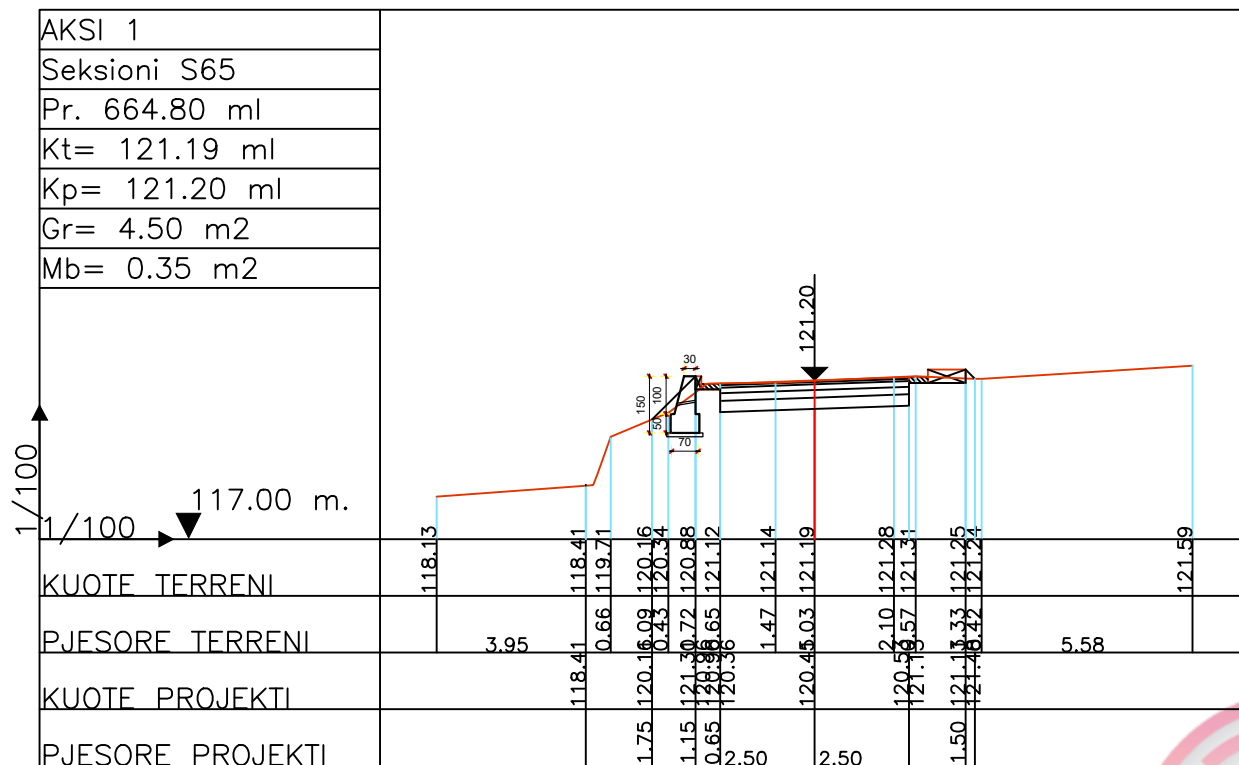

**POROSITESI : BASHKIA VORË**

OBJEKTI:  
"RIKONSTRUKSION I RRUGEVE MUCAJ, SHERAJ DHE E VESLEVE FSHATI MUCAJ ,BASHKIA VORE "

Emertimi: PROFILET TERTHORE

**"ARABEL - STUDIO" Sh.p.k**  
Adresa: Njesia Bashkiake nr.7, Rruga "Frosina Plaku", Pallati 21, Hyrja 1, Kati 2, Tirane.  
Email: arabelstudio@gmail.com

Drejtes i projektit

Adm. Ana NISHKU  
Inxh. Ardi ARKAXHIU

Projektues

Nd. Ardi ARKAXHIU  
Ark.Rigert HYRA  
Gjeo.Irfan BEGAJ

Elek. Altin ALLKAJ  
Top. Mustafa HOXHAI  
Hid. Hajredin MURGU

SHKALLA

1 : 200

Vorë 2019

FLETA

9- 18

Format A3

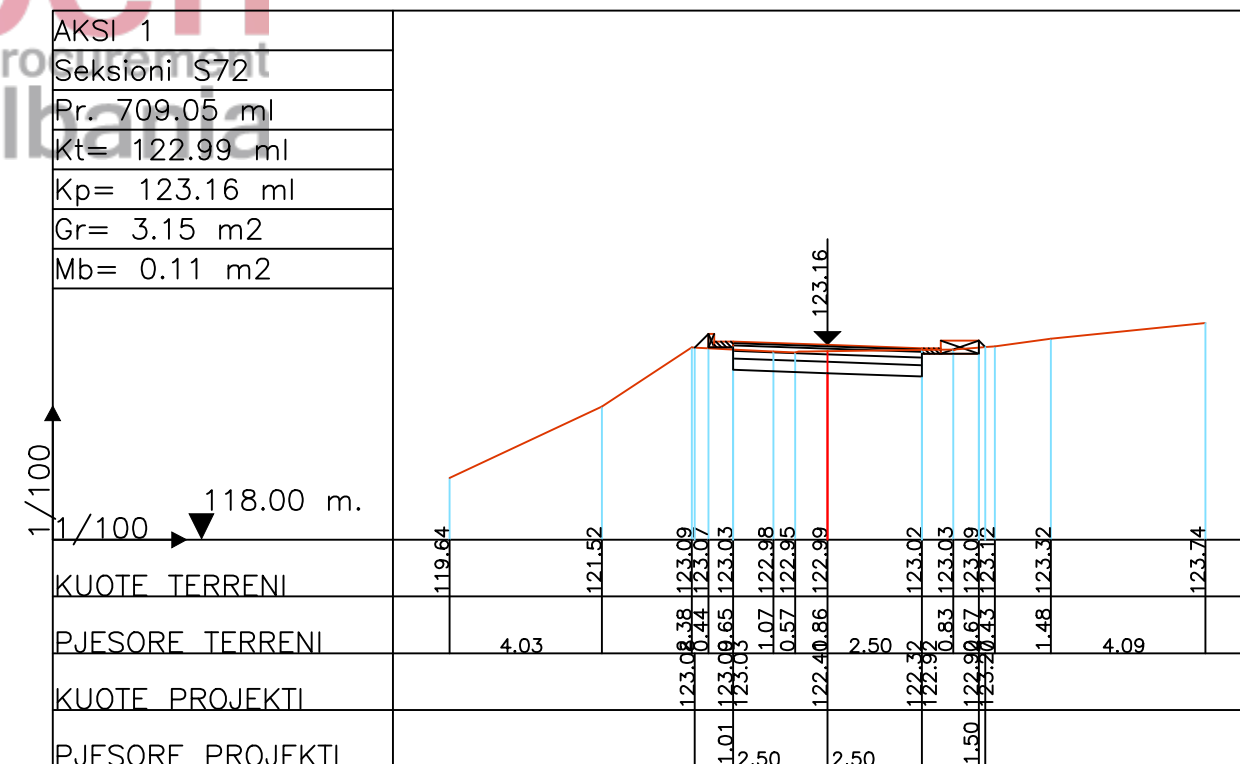
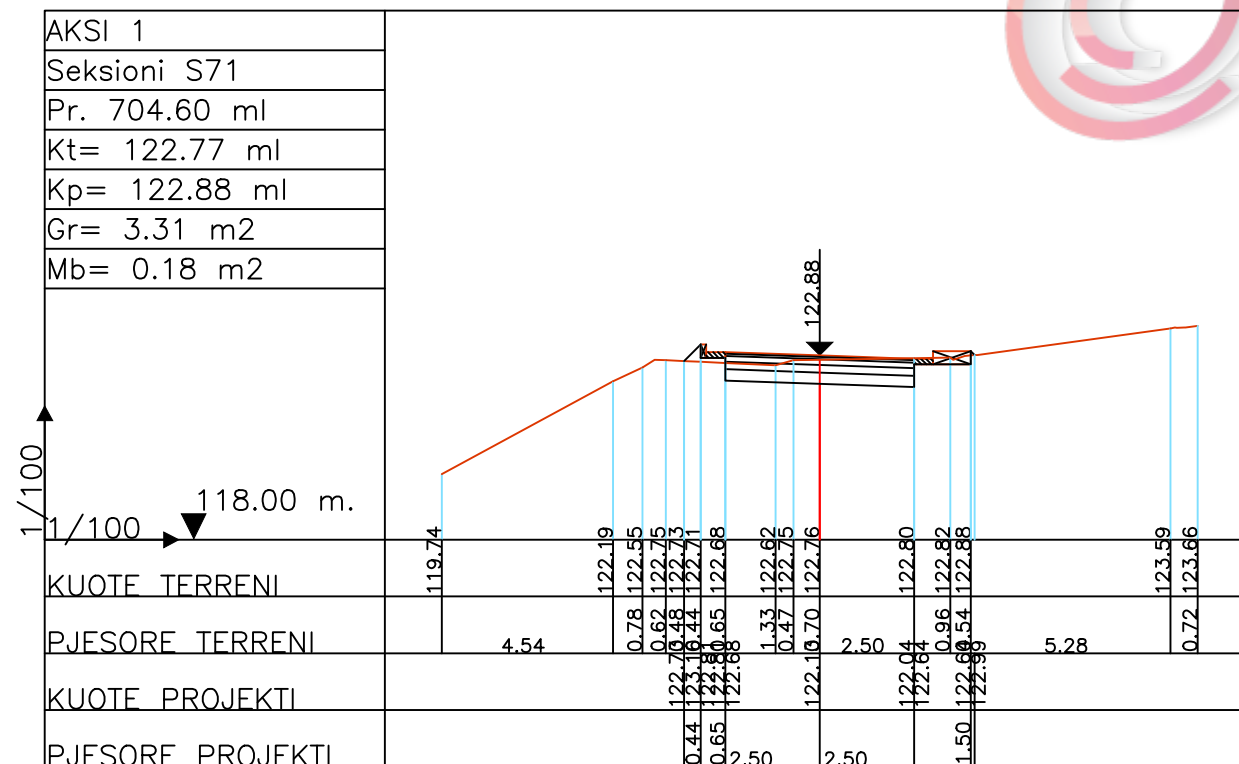
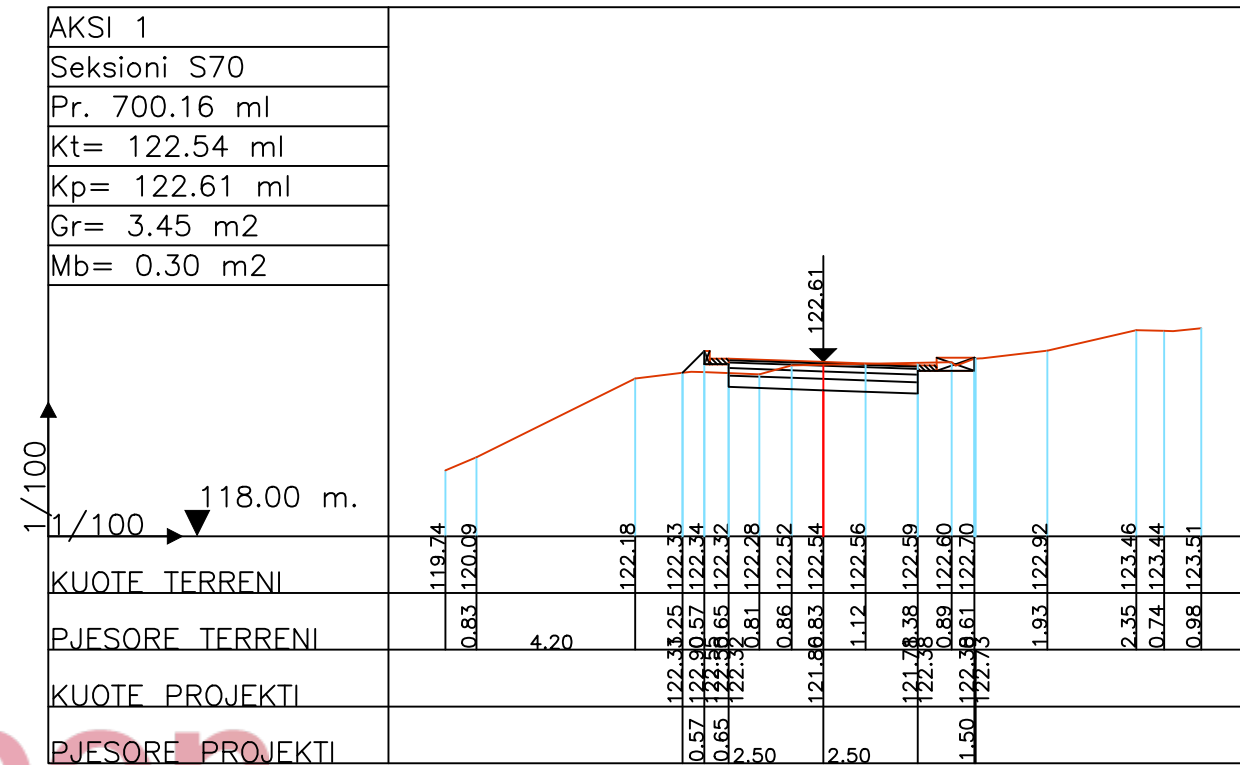
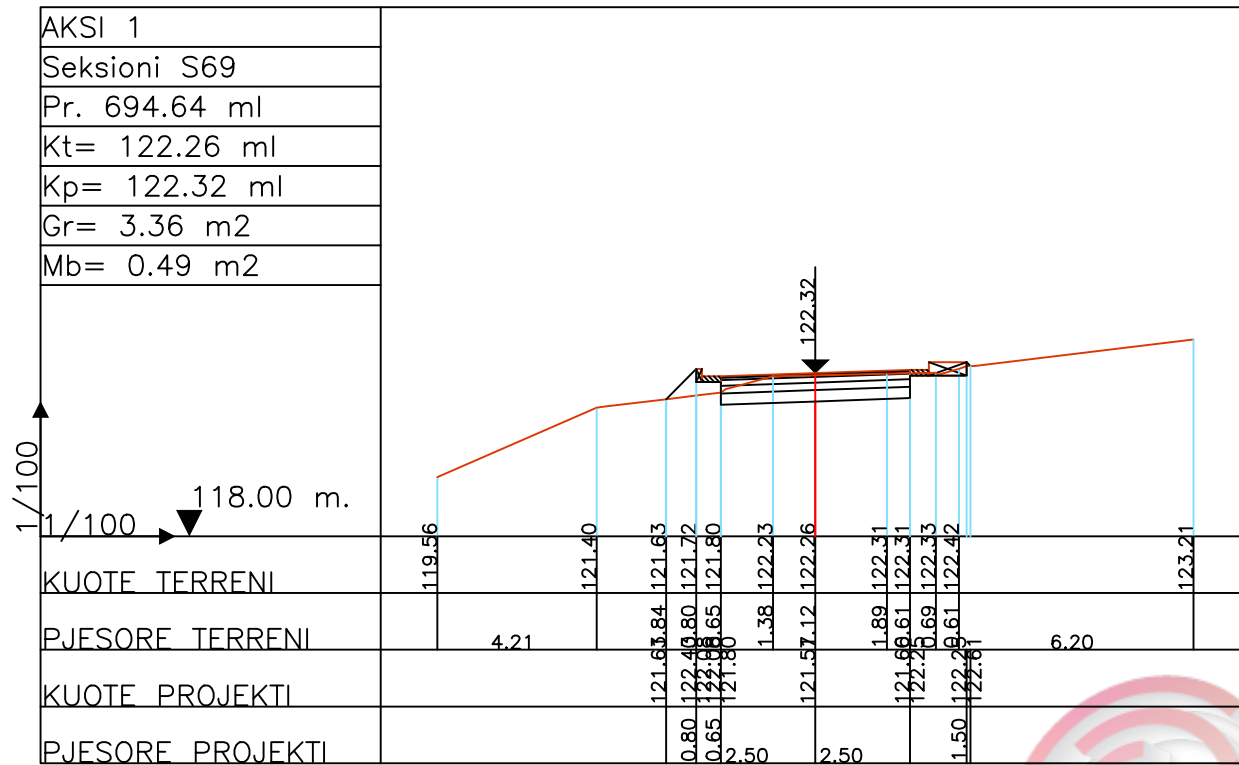

**POROSITESI : BASHKIA VORË**

OBJEKTI:  
"RIKONSTRUKSION I RRUGEVE MUCAJ, SHERAJ DHE E VESLEVE FSHATI MUCAJ ,BASHKIA VORE "

Emertimi: PROFILET TERTHORE

**"ARABEL - STUDIO" Sh.p.k**  
Adresa: Njesia Bashkiake nr.7, Rruga "Frosina Plaku", Pallati 21, Hyrja 1, Kati 2, Tirane.  
Email: arabelstudio@gmail.com

Drejtesues i projektit

Adm. Ana NISHKU	Nd. Ardi ARKAXHIU	Elek. Altin ALLKAJ
Inxh. Ardi ARKAXHIU	Ark.Rigert HYRA	Top. Mustafa HOXHAI
	Gjeo.Irfan BEGAJ	Hid. Hajredin MURGU

SHKALLA	FLETA
1 : 200	9- 19
Vorë 2019	Format A3

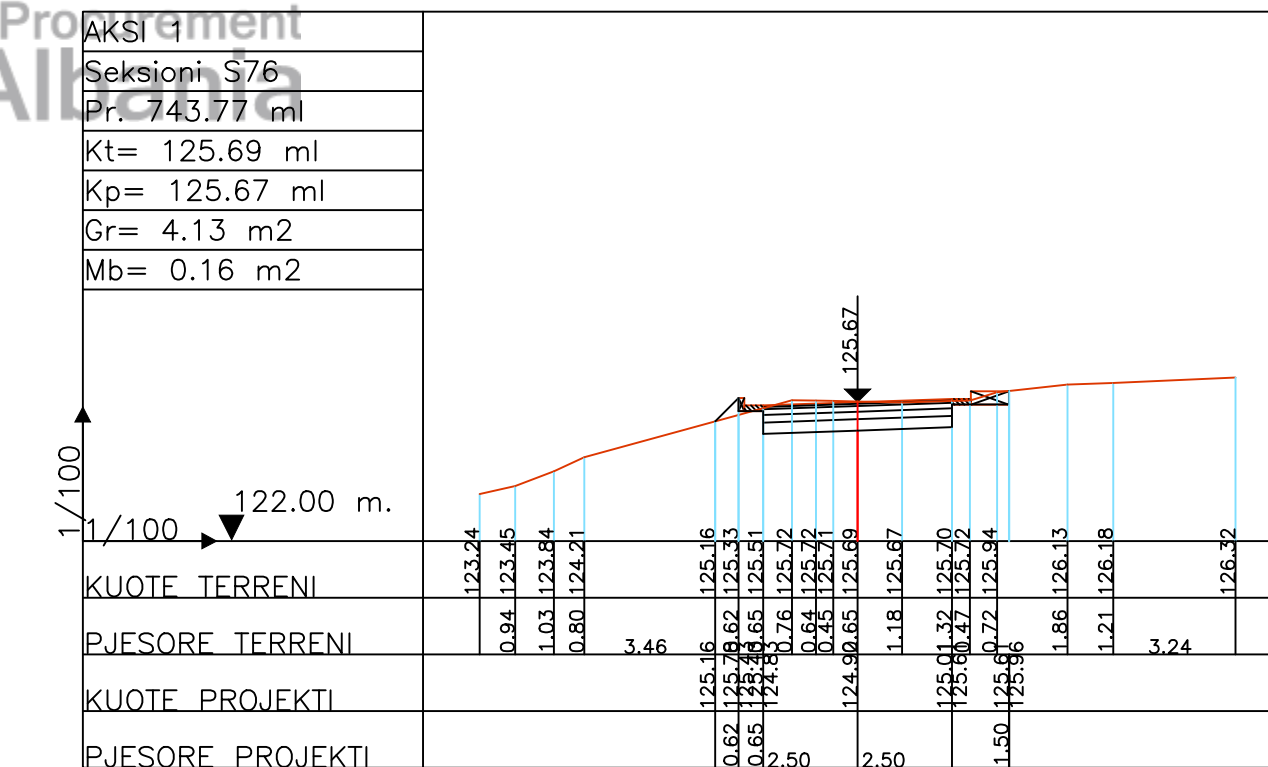
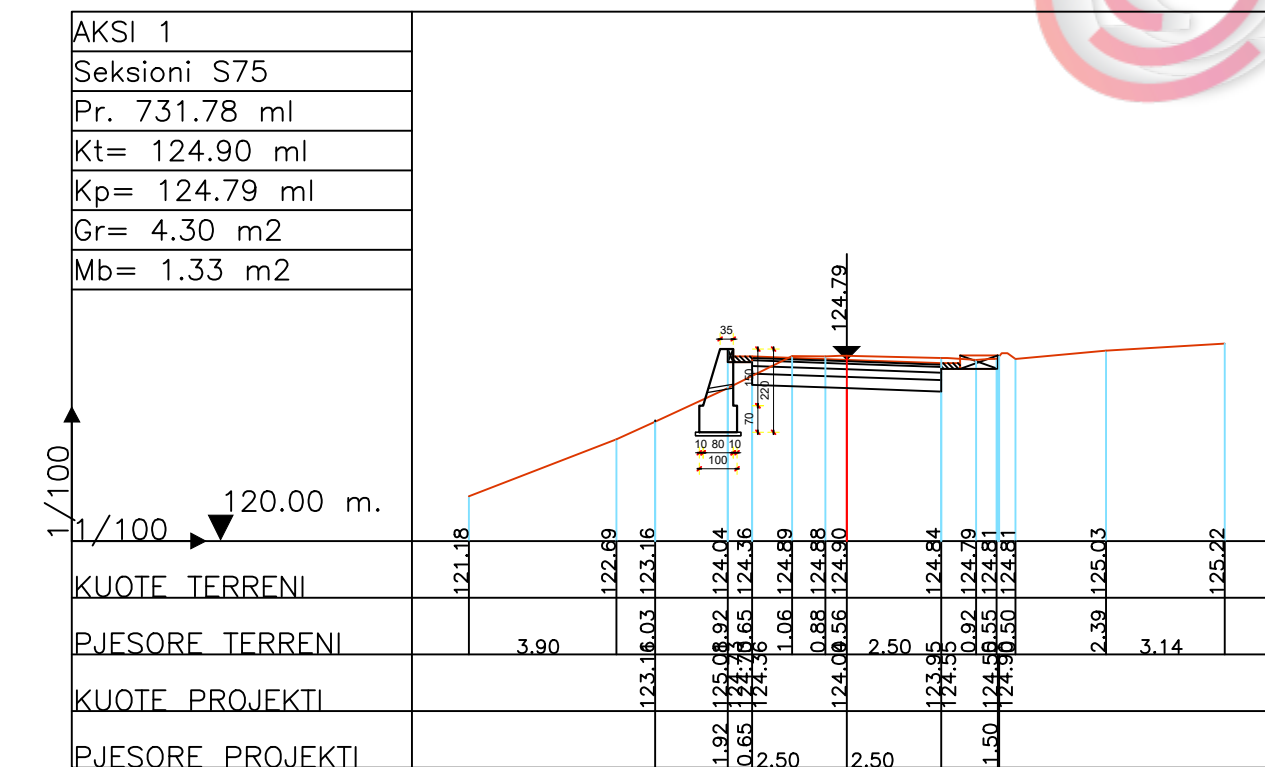
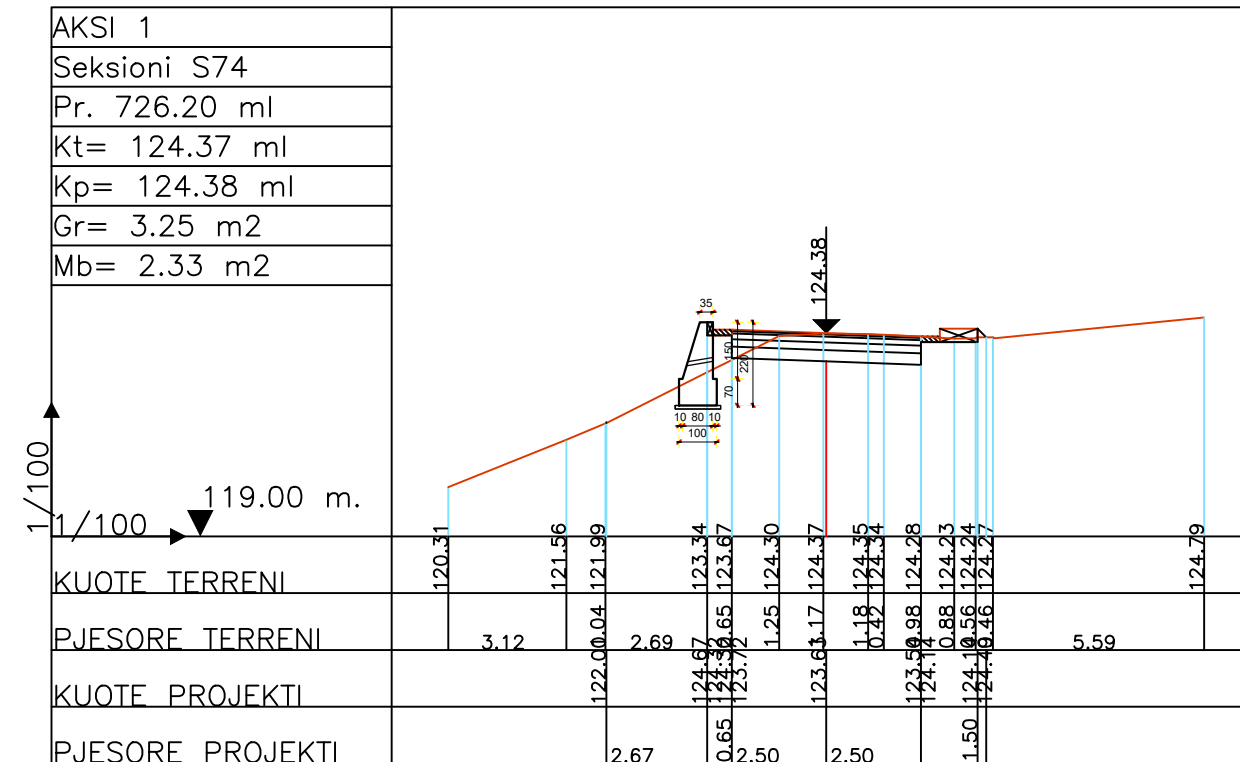
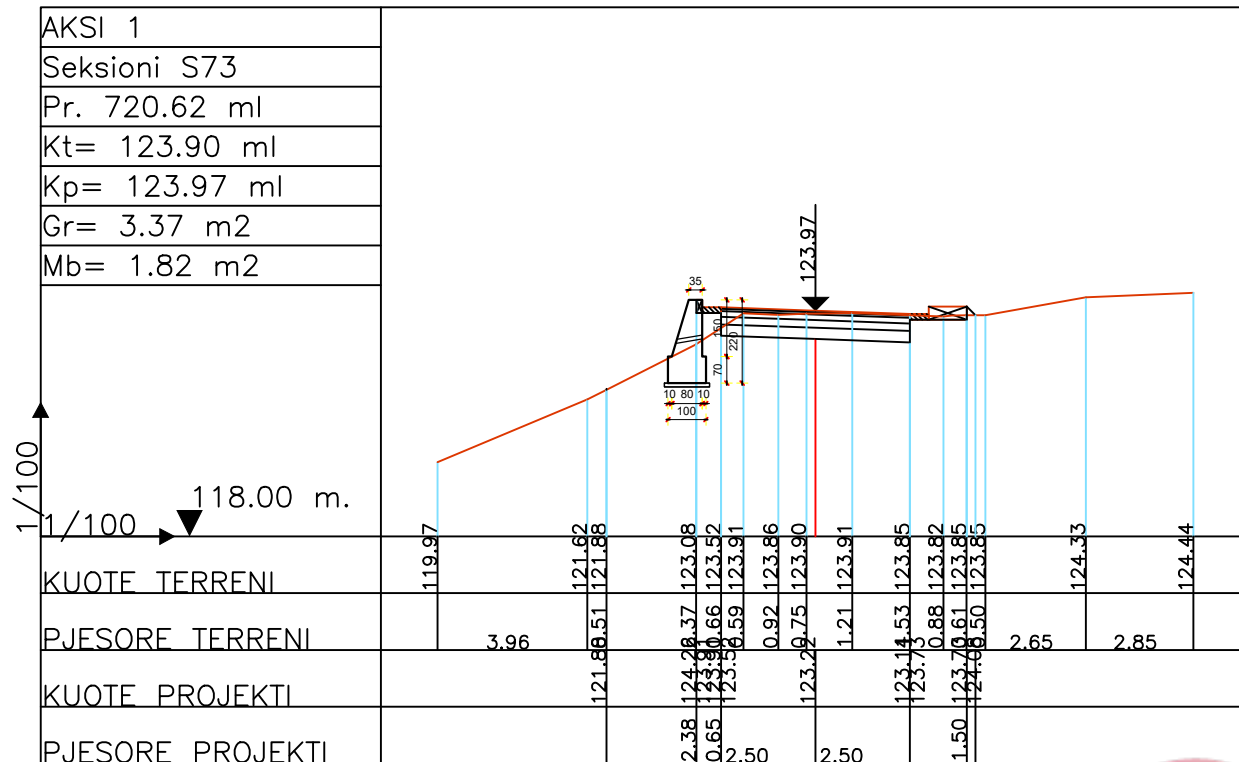

**POROSITESI : BASHKIA VORË**

OBJEKTI:  
"RIKONSTRUKSION I RRUGEVE MUCAJ, SHERAJ DHE E VESLEVE FSHATI MUCAJ ,BASHKIA VORE "

Emertimi: PROFILET TERTHORE

**"ARABEL - STUDIO" Sh.p.k**  
Adresa: Njesia Bashkiake nr.7, Rruga "Frosina Plaku", Pallati 21, Hyrja 1, Kati 2, Tirane.  
Email: arabelstudio@gmail.com

**Drejtes i projektit**

Adm. Ana NISHKU	
Inxh. Ardi ARKAXHIU	

**Projektues**

Nd. Ardi ARKAXHIU	Elek. Altin ALLKAJ
Ark.Rigert HYRA	Top. Mustafa HOXHAI
Gjeo.Irfan BEGAJ	Hid. Hajredin MURGU

<b>SHKALLA</b>	<b>FLETA</b>
1 : 200	9- 20
Vorë 2019	Format A3

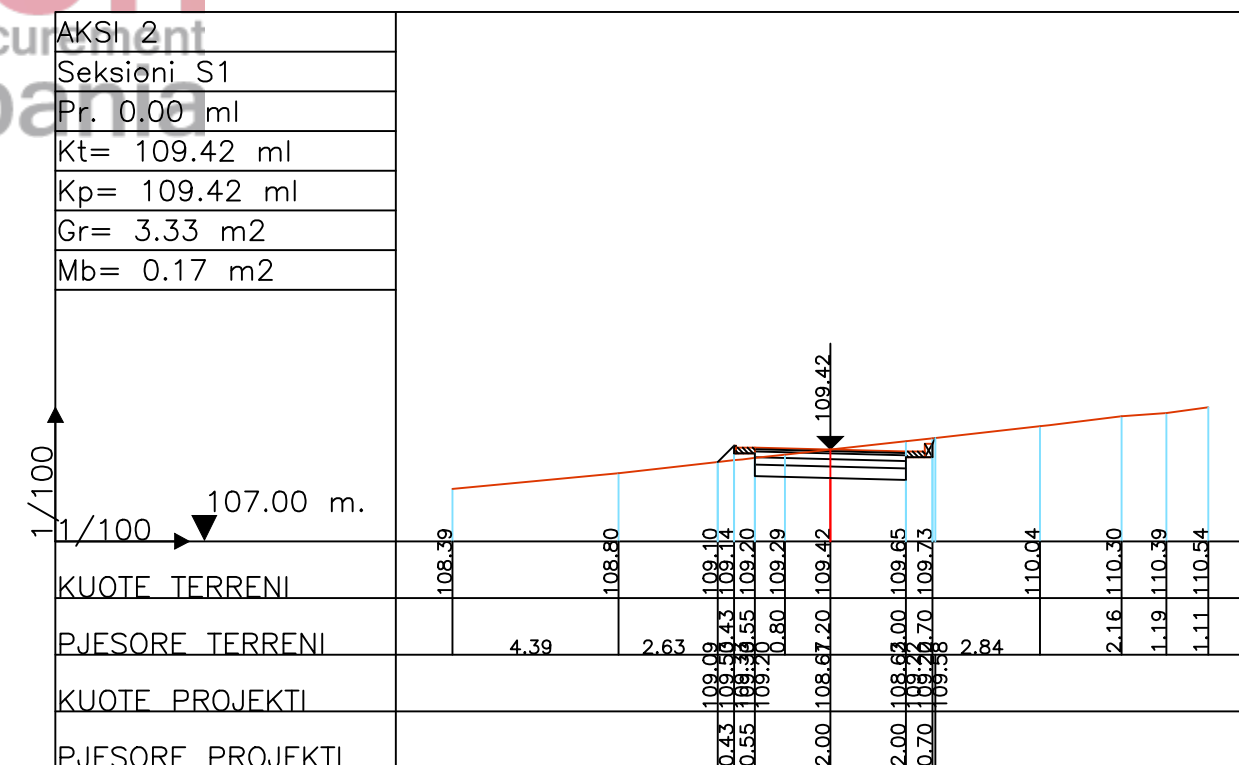
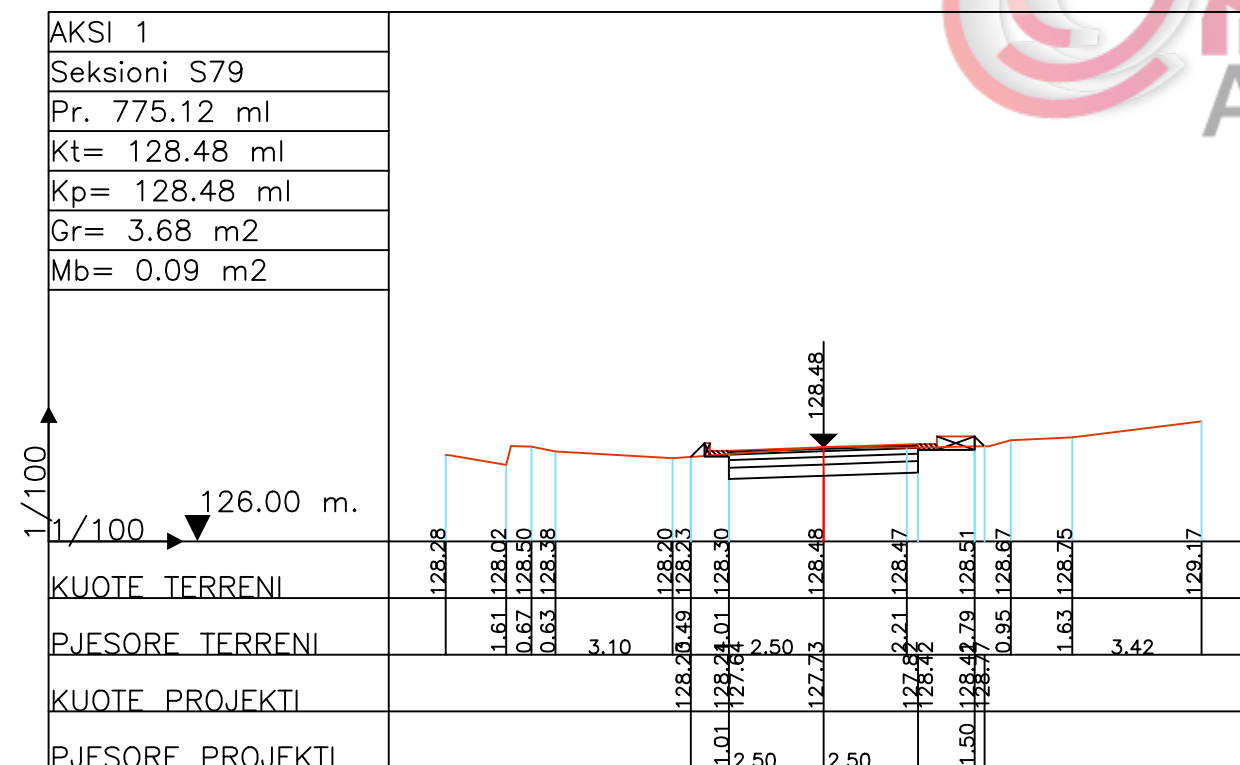
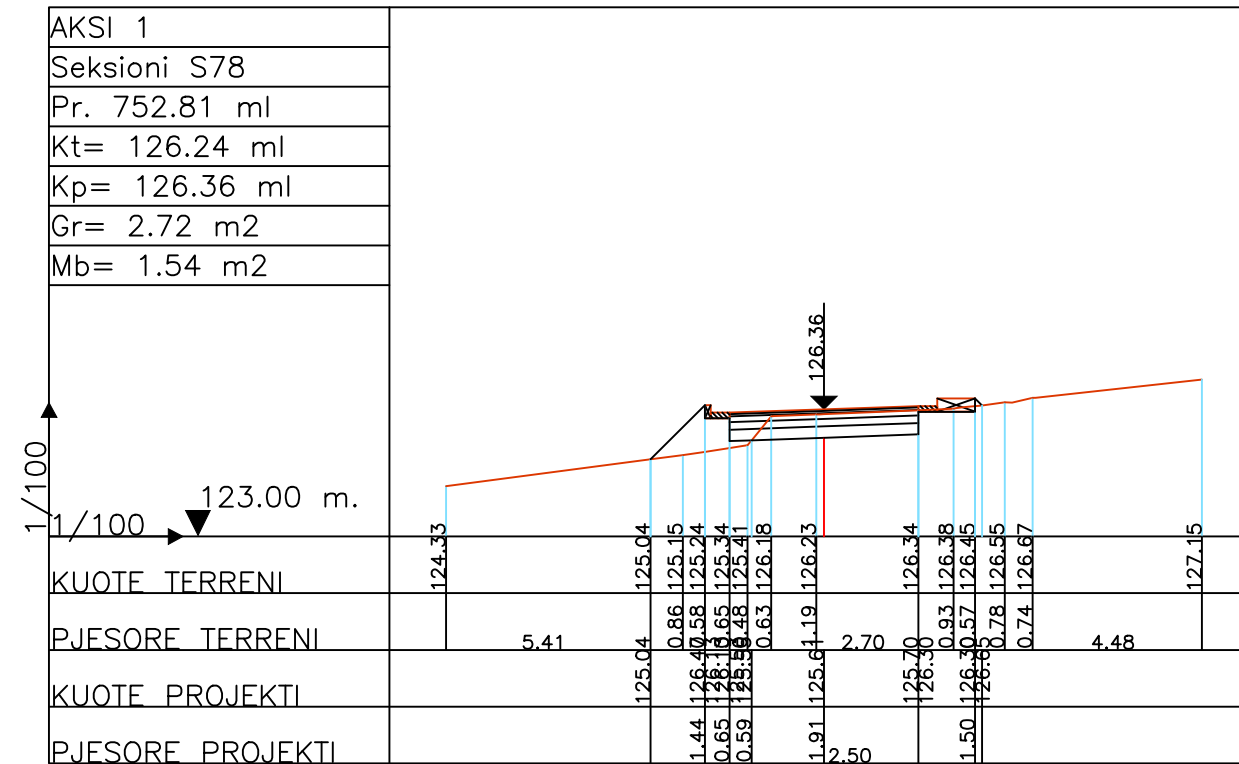
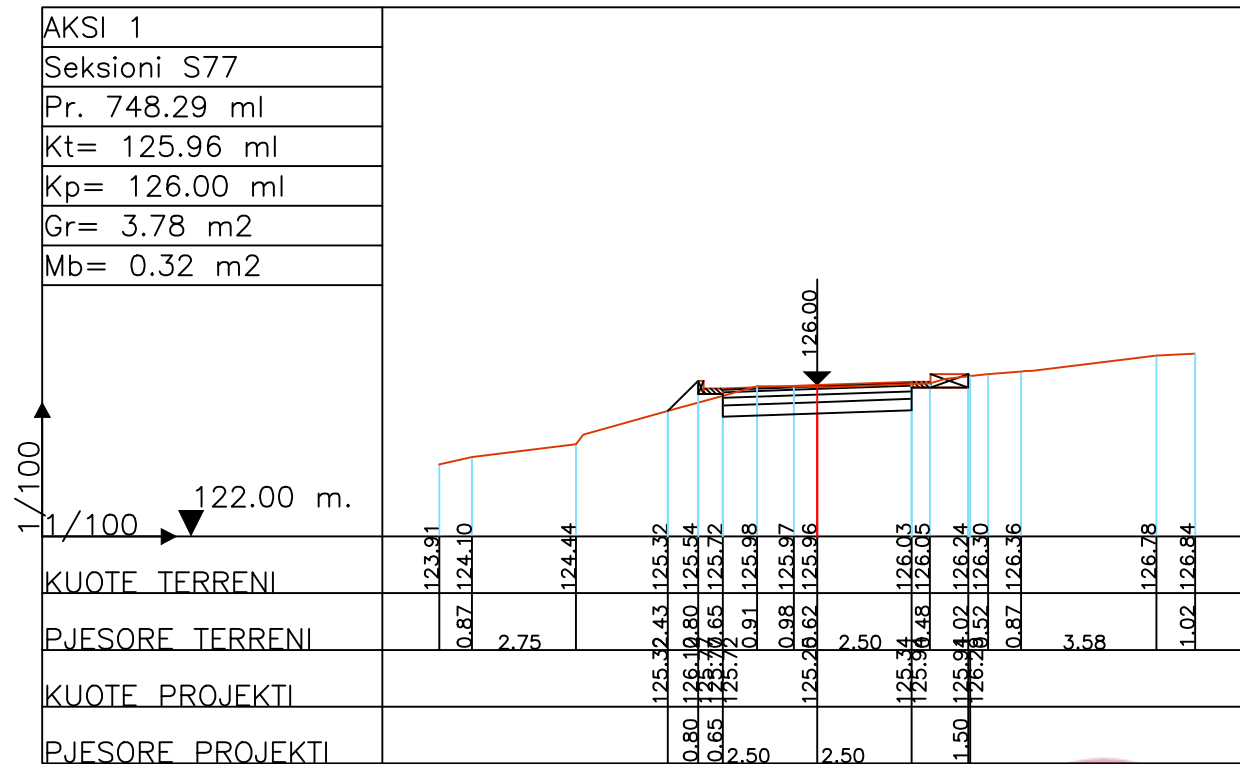

**POROSITESI : BASHKIA VORË**

OBJEKTI:  
"RIKONSTRUKSION I RRUGEVE MUCAJ, SHERAJ DHE E VESLEVE FSHATI MUCAJ ,BASHKIA VORE "

Emertimi: PROFILET TERTHORE

**"ARABEL - STUDIO" Sh.p.k**  
Adresa: Njesia Bashkiake nr.7, Rruga "Frosina Plaku", Pallati 21, Hyrja 1, Kati 2, Tirane.  
Email: arabelstudio@gmail.com

**Drejtes i projektit**

Adm. Ana NISHKU	Nd. Ardi ARKAXHIU	Elek. Altin ALLKAJ
Inxh. Ardi ARKAXHIU	Ark.Rigert HYRA	Top. Mustafa HOXHAI
	Gjeo.Irfan BEGAJ	Hid. Hajredin MURGU

<b>SHKALLA</b>	<b>FLETA</b>
1 : 200	9- 21
Vorë 2019	Format A3



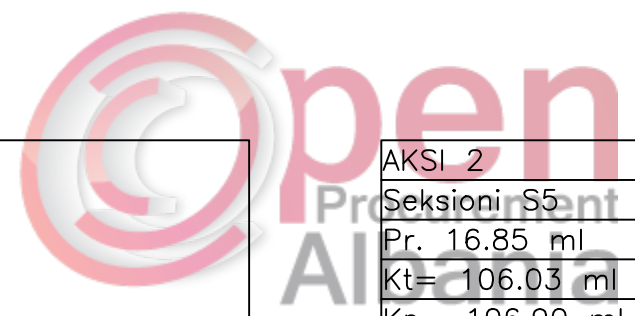
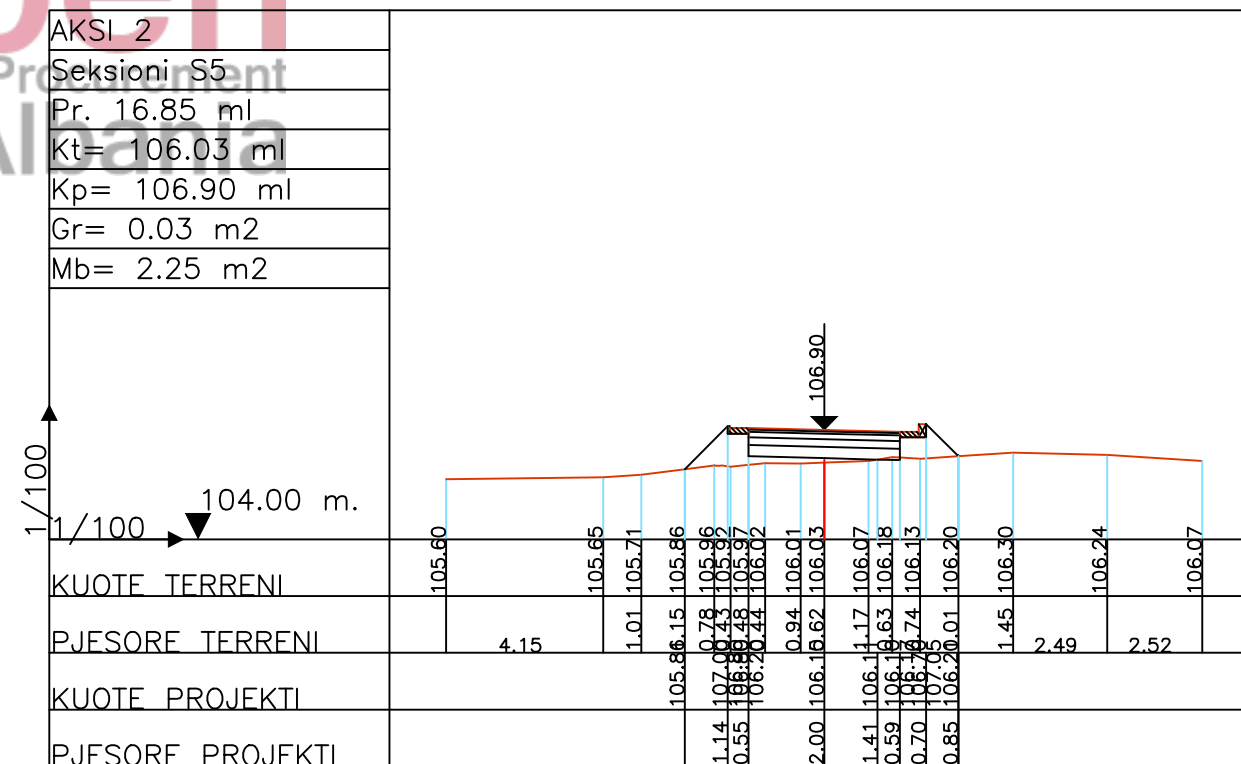
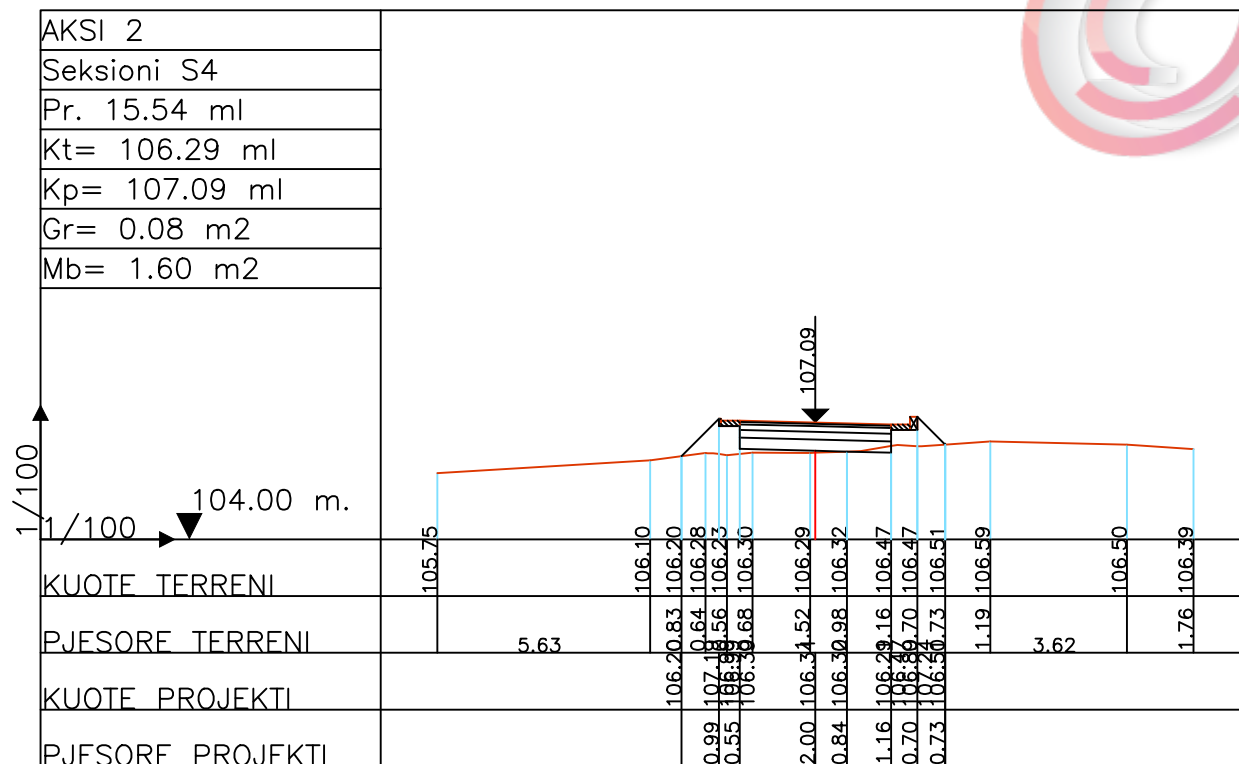
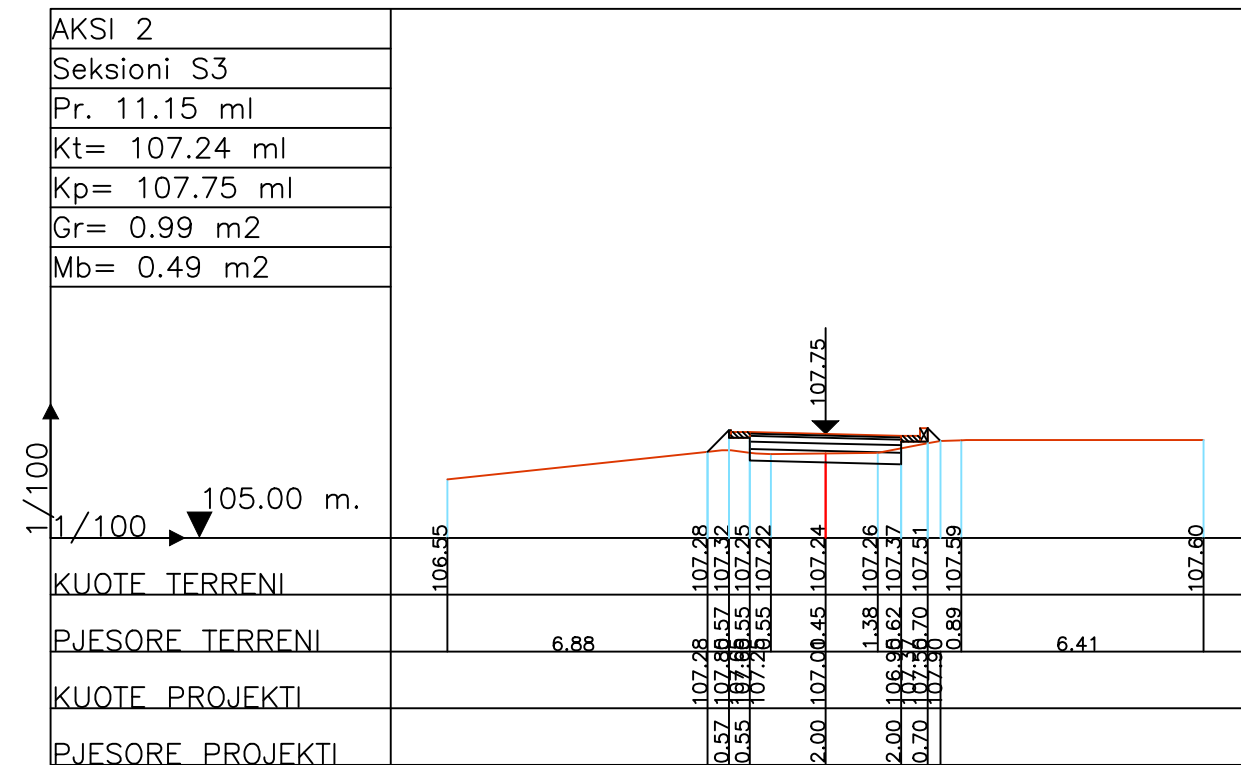
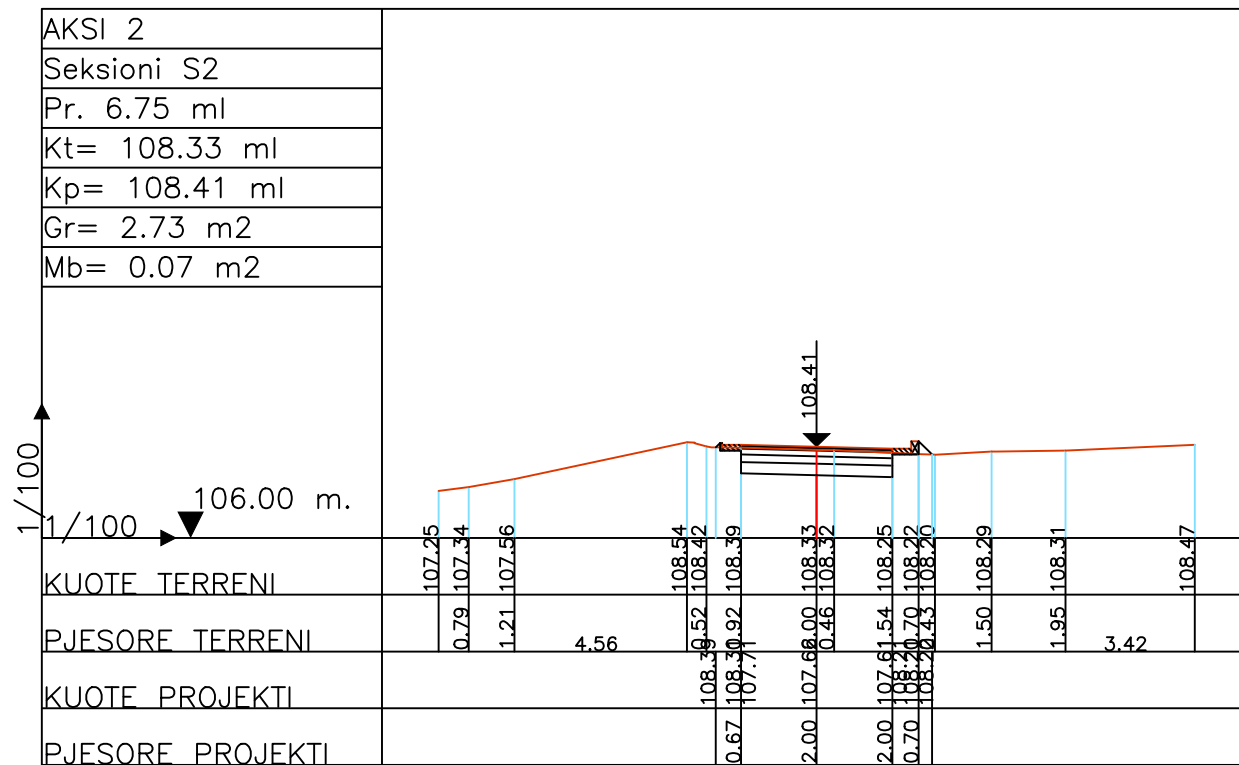

**POROSITESI : BASHKIA VORË**

OBJEKTI:  
"RIKONSTRUKSION I RRUGEVE MUCAJ, SHERAJ DHE E VESLEVE FSHATI MUCAJ ,BASHKIA VORE "

Emertimi: PROFILET TERTHORE

**"ARABEL - STUDIO" Sh.p.k**  
Adresa:Njesia Bashkiake nr.7, Rruga "Frosina Plaku", Pallati 21, Hyrja 1, Kati 2,Tirane.  
Email: arabelstudio@gmail.com

Drejtesues i projektit

Adm. Ana NISHKU	Nd. Ardi ARKAXHIU	Elek. Altin ALLKAJ
Inxh. Ardi ARKAXHIU	Ark.Rigert HYRA	Top. Mustafa HOXHAI
	Gjeo.Irfan BEGAJ	Hid. Hajredin MURGU

SHKALLA	FLETA
1 : 200	9- 22
Vorë 2019	Format A3

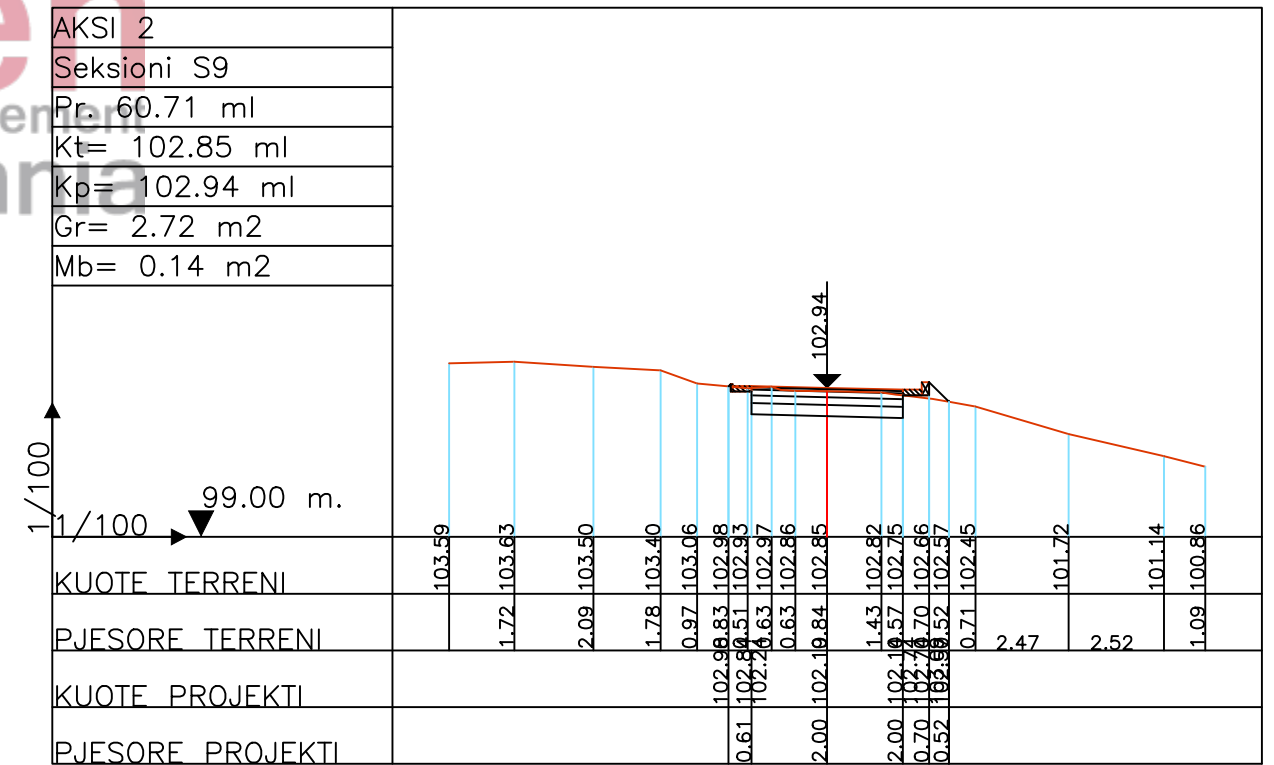
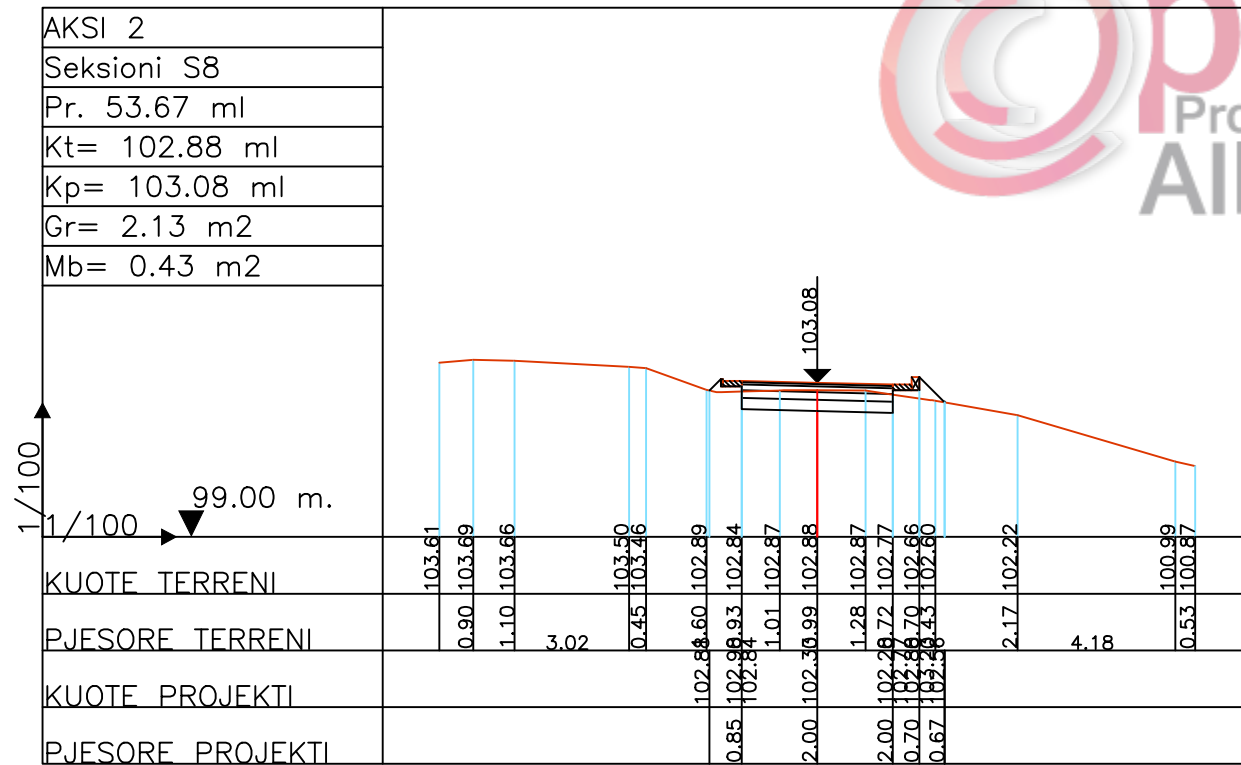
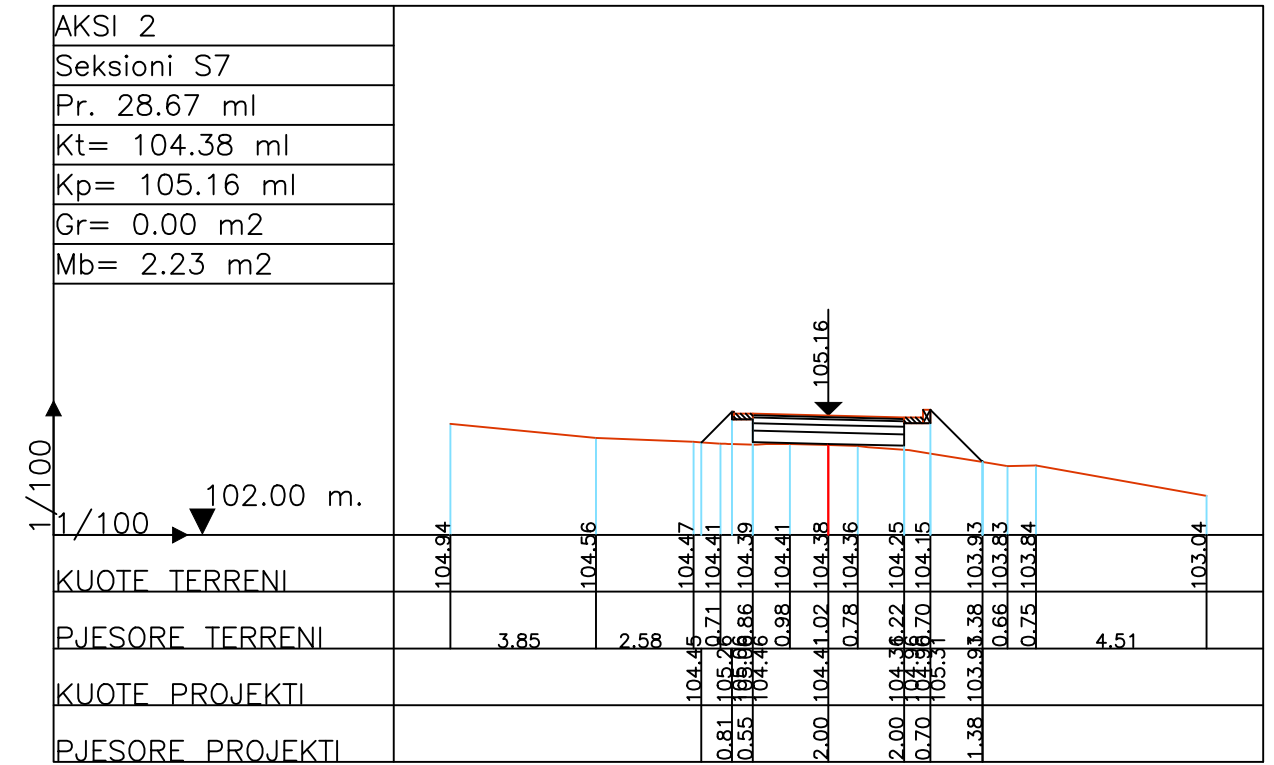
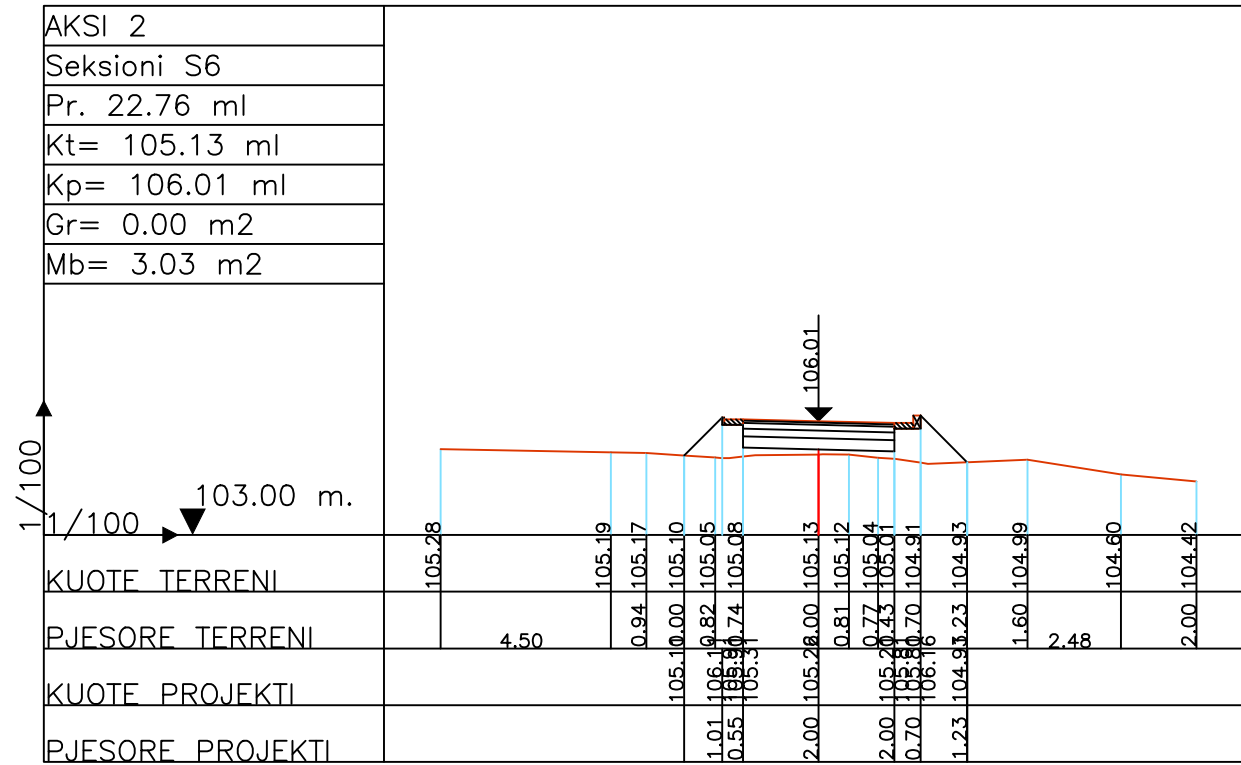

# POROSITESI : BASHKIA VORË

OBJEKTI:  
"RIKONSTRUKSION I RRUGEVE MUCAJ, SHERAJ DHE E VESLEVE  
FSHATI MUCAJ, BASHKIA VORE "

Emertimi: PROFILET TERTHORE



"ARABEL - STUDIO" Sh.p.k  
Adresa: Njesia Bashkiake nr.7, Rruga "Frosina Plaku",  
Pallati 21, Hyrja 1, Kati 2, Tirane.  
Email: arabelstudio@gmail.com

## Drejtesues i projektit

Adm. Ana NISHKU  
Inxh. Ardi ARKAXHIU

## Projektues

Nd. Ardi ARKAXHIU  
Elek. Altin ALLKAJ  
Ark.Rigert HYRA  
Top. Mustafa HOXHAI  
Gjeo.Irfan BEGAJ  
Hid. Hajredin MURGU

## SHKALLA FLETA

1 : 200  
9- 23  
Vorë 2019  
Format A3

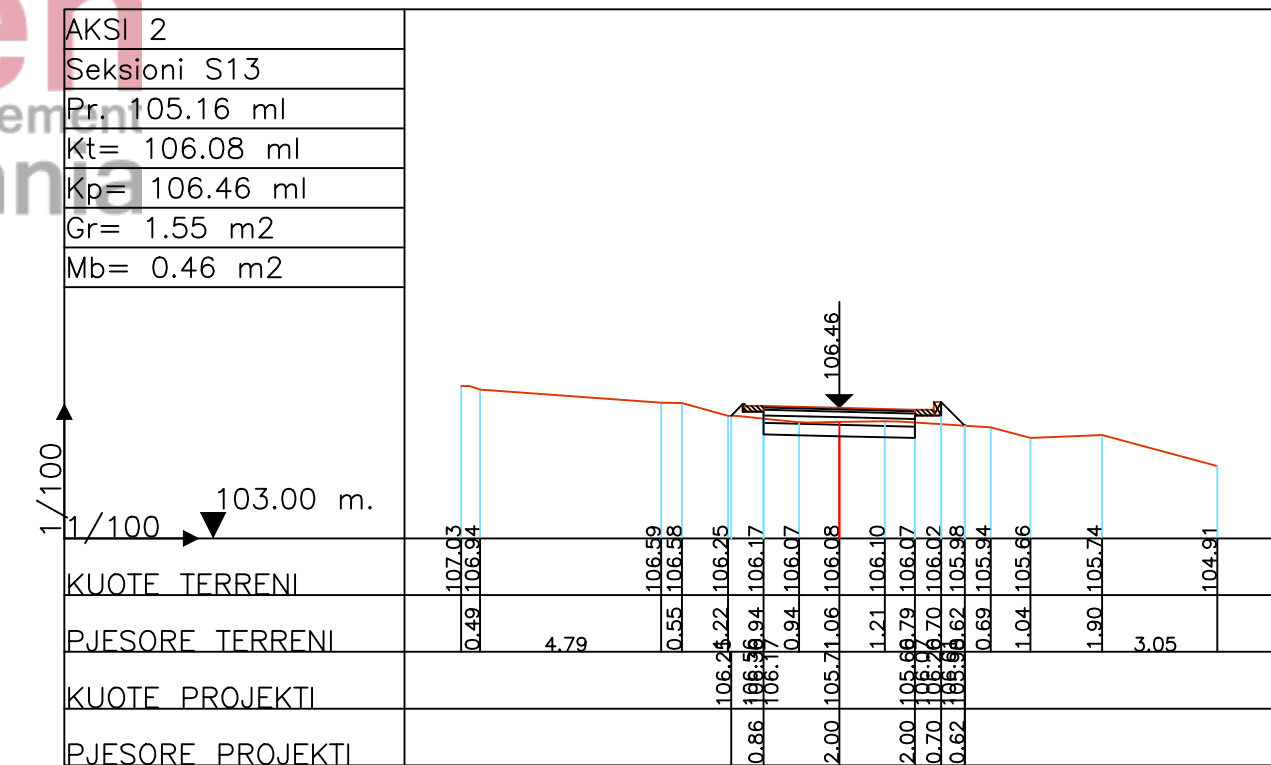
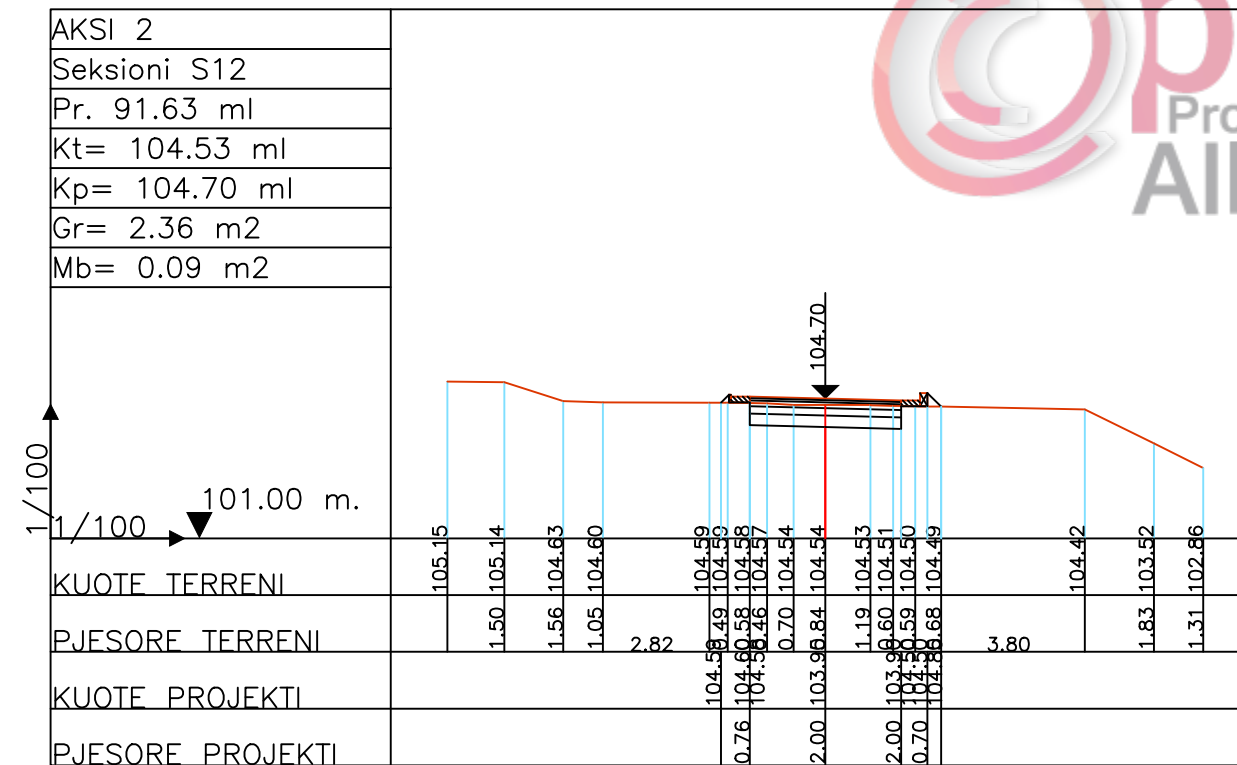
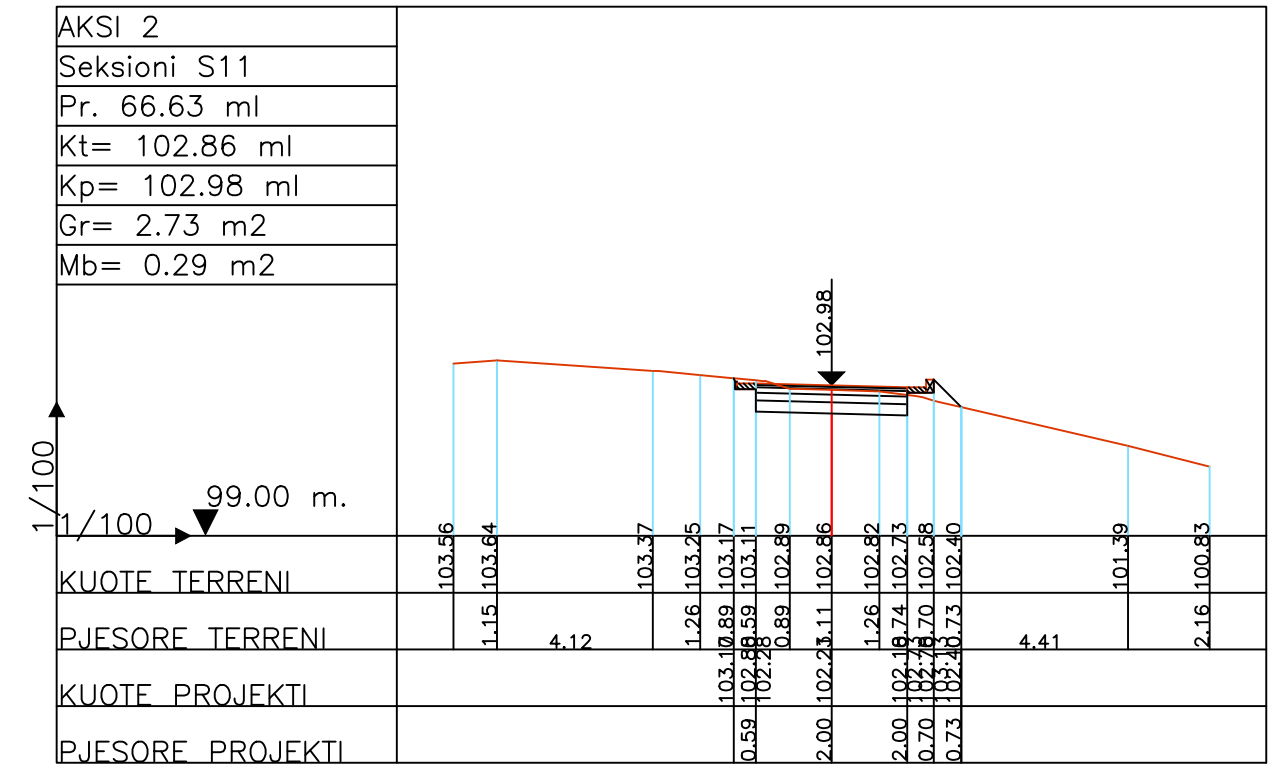
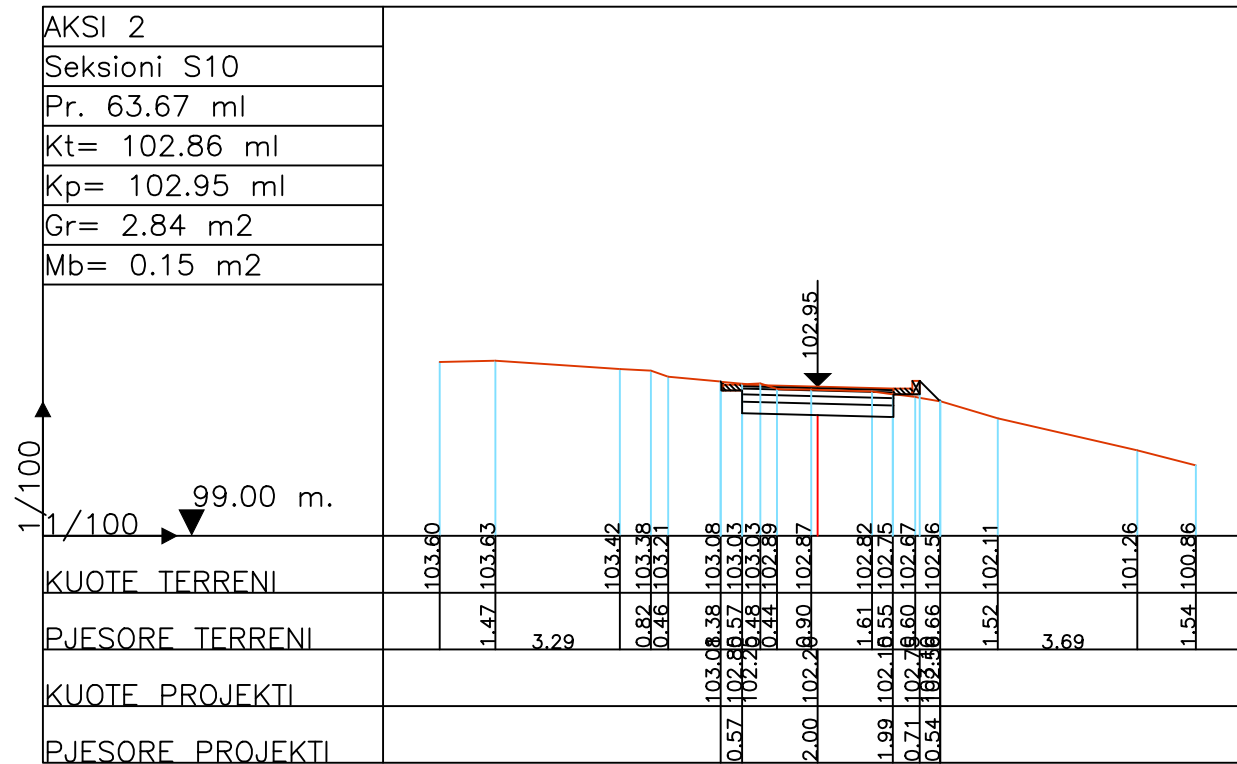

**POROSITESI : BASHKIA VORË**

OBJEKTI:  
"RIKONSTRUKSION I RRUGEVE MUCAJ, SHERAJ DHE E VESLEVE FSHATI MUCAJ ,BASHKIA VORE "

Emertimi: PROFILET TERTHORE

**"ARABEL - STUDIO" Sh.p.k**  
Adresa: Njesia Bashkiake nr.7, Rruga "Frosina Plaku", Pallati 21, Hyrja 1, Kati 2, Tirane.  
Email: arabelstudio@gmail.com

Drejtesues i projektit

Adm. Ana NISHKU  
Inxh. Ardi ARKAXHIU

Projektues

Nd. Ardi ARKAXHIU  
Ark.Rigert HYRA  
Gjeo.Irfan BEGAJ

Elek. Altin ALLKAJ  
Top. Mustafa HOXHAI  
Hid. Hajredin MURGU

SHKALLA  
1 : 200  
Vorë 2019

FLETA  
9- 24  
Format A3

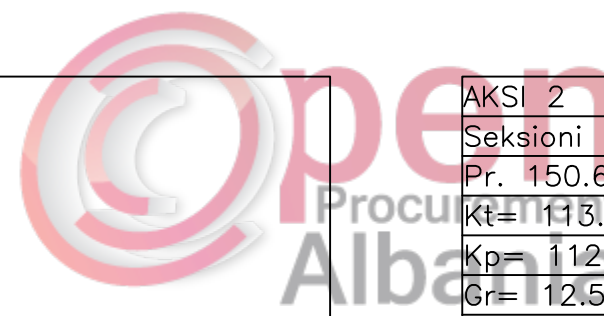
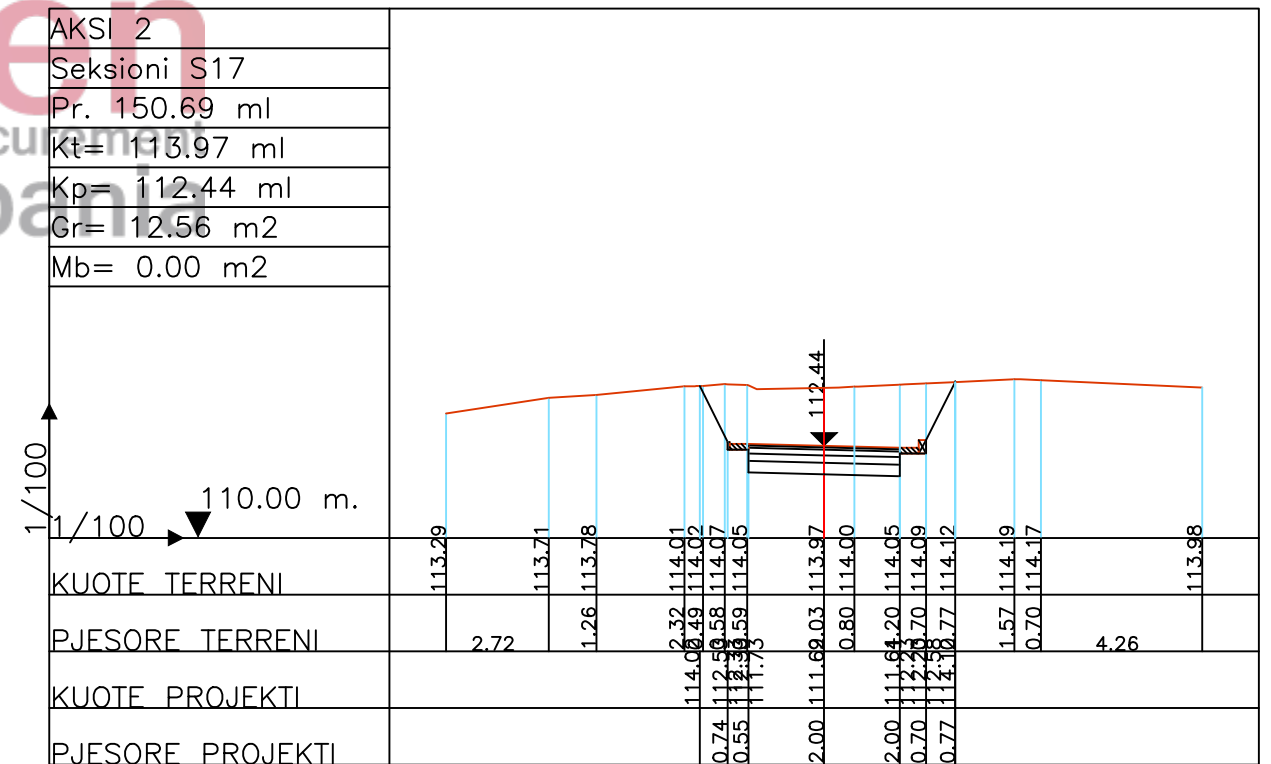
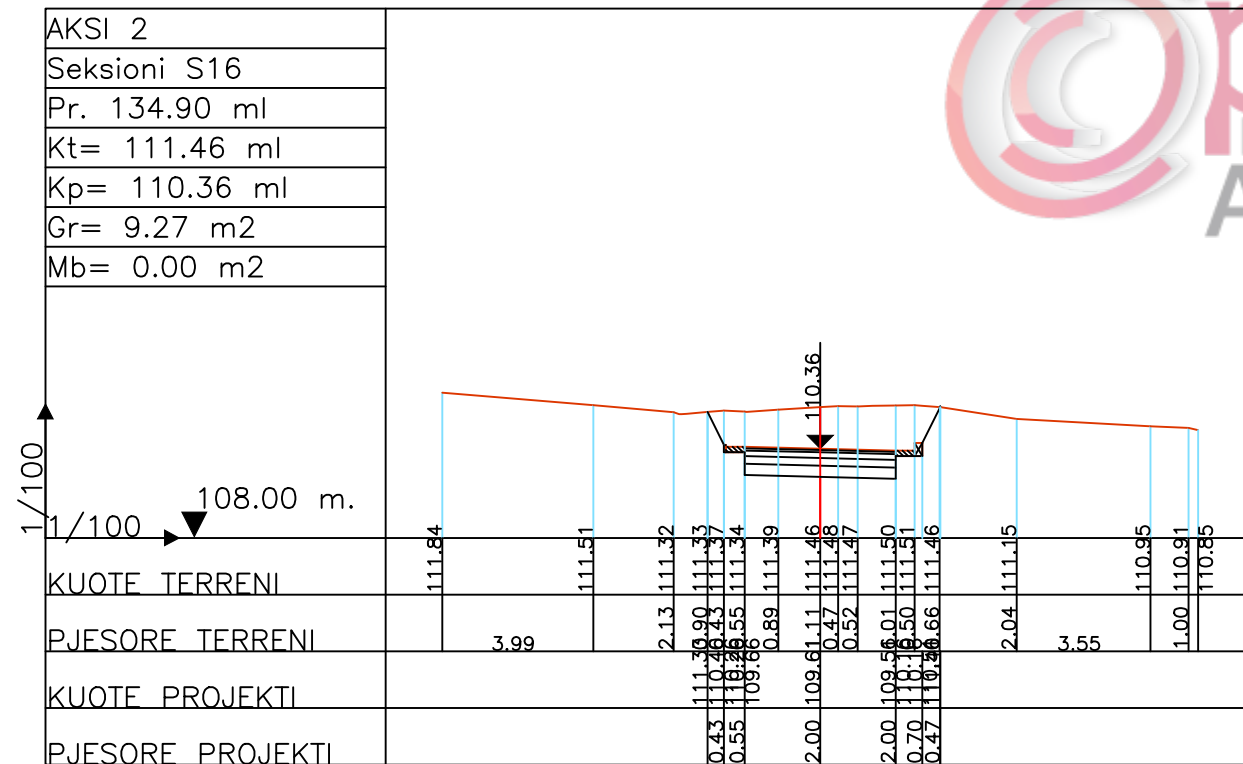
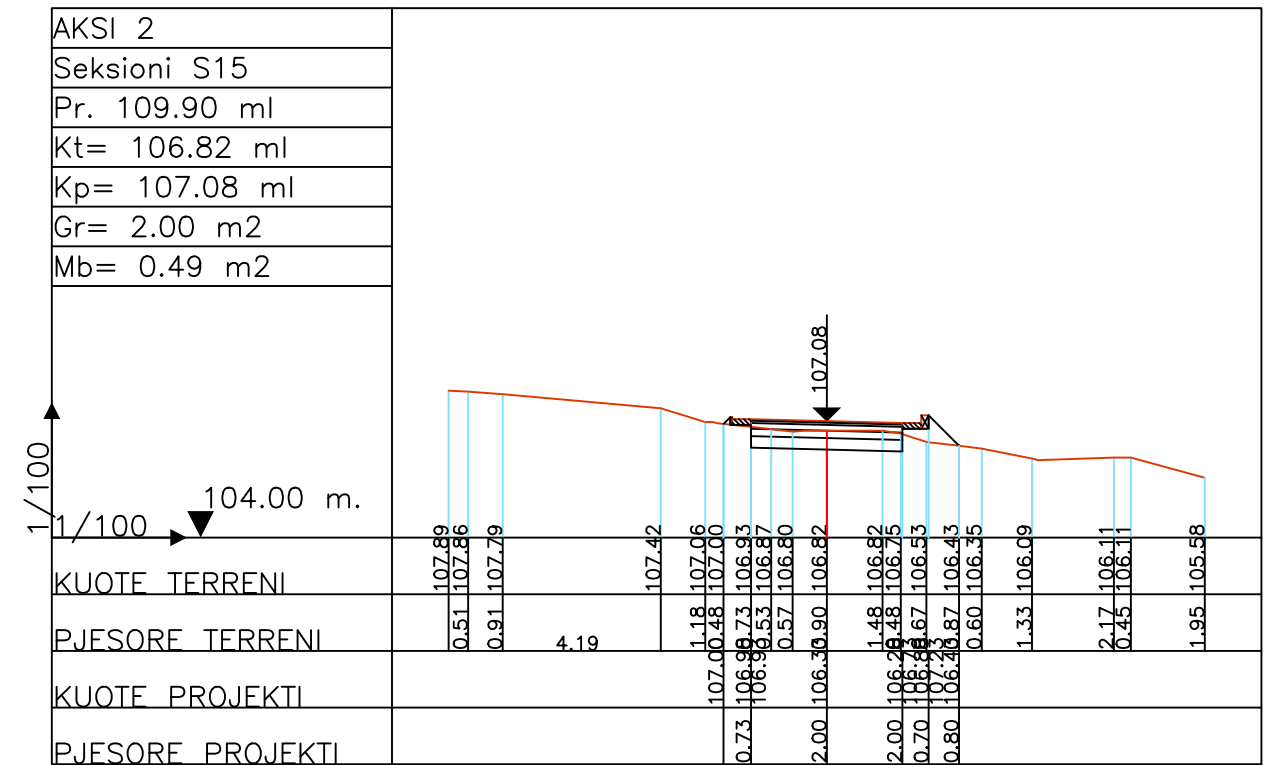
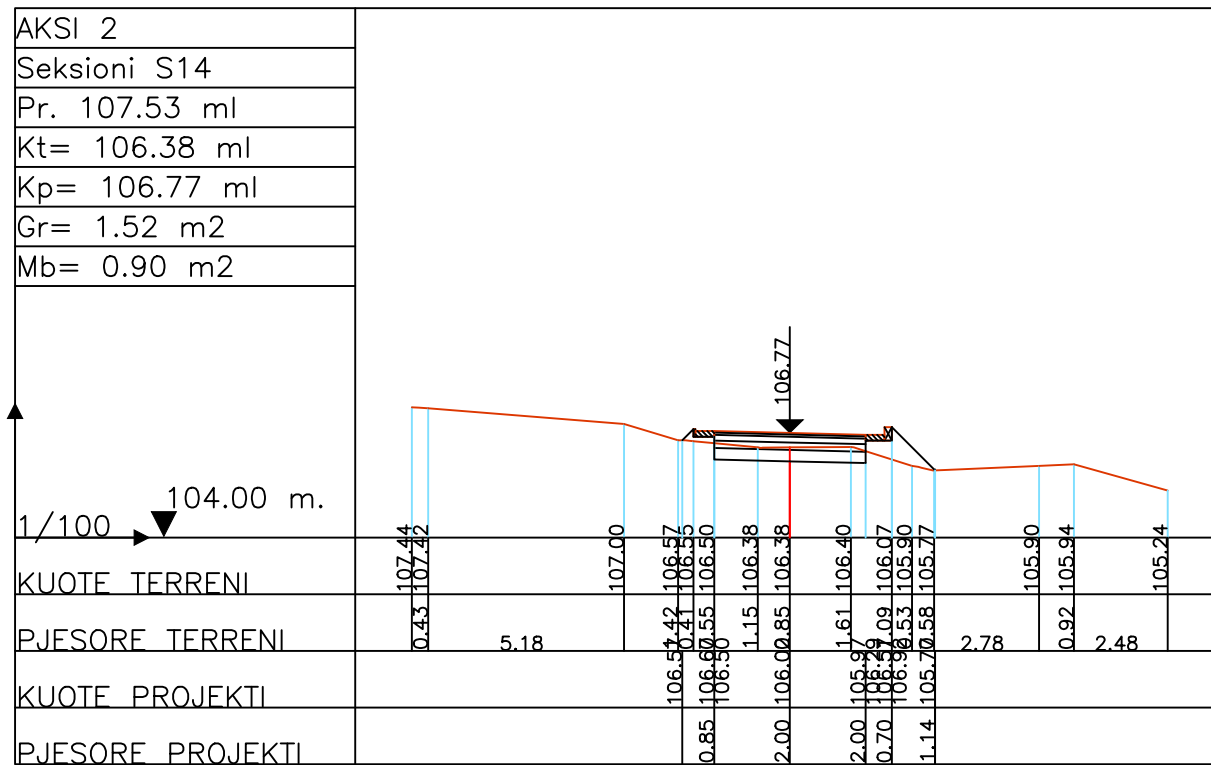

## POROSITESI : BASHKIA VORË

OBJEKTI:  
"RIKONSTRUKSION I RRUGEVE MUCAJ, SHERAJ DHE E VESLEVE FSHATI MUCAJ ,BASHKIA VORE "



Emertimi: PROFILET TERTHORE

### "ARABEL - STUDIO" Sh.p.k

Adresa:Njesia Bashkiake nr.7, Rruga "Frosina Plaku", Pallati 21, Hyrja 1, Kati 2,Tirane.  
Email: arabelstudio@gmail.com

### Drejtues i projektit

Adm. Ana NISHKU  
Inxh. Ardi ARKAXHIU

### Projektues

Nd. Ardi ARKAXHIU  
Ark.Rigert HYRA  
Gjeo.Irfan BEGAJ  
Elek. Altin ALLKAJ  
Top. Mustafa HOXHAI  
Hid. Hajredin MURGU

### SHKALLA

1 : 200

Vorë 2019

### FLETA

9- 25

Format A3

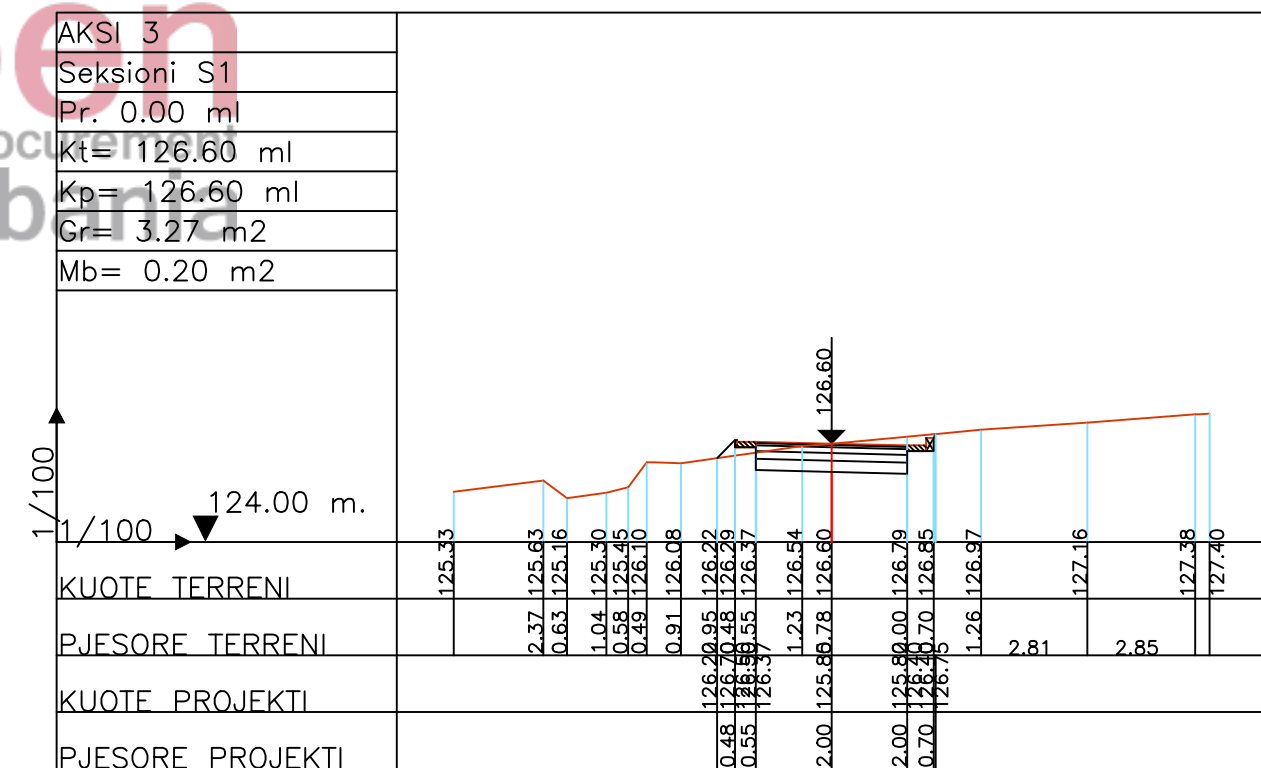
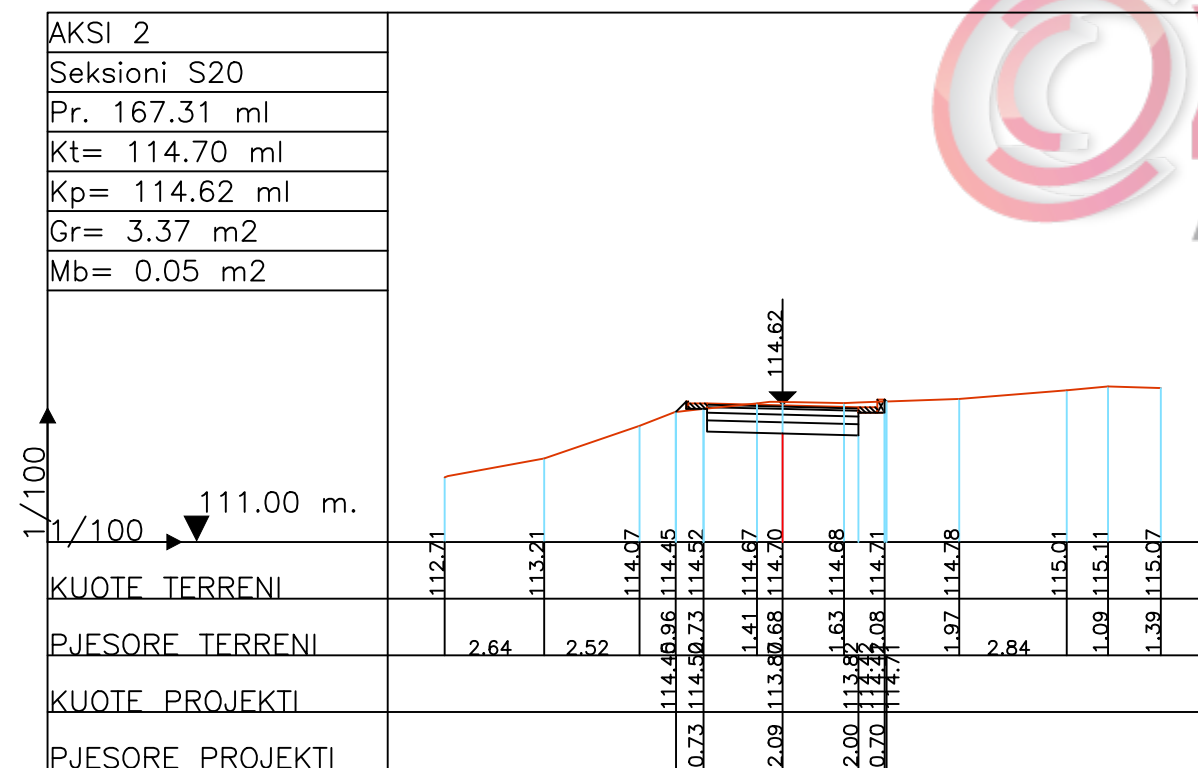
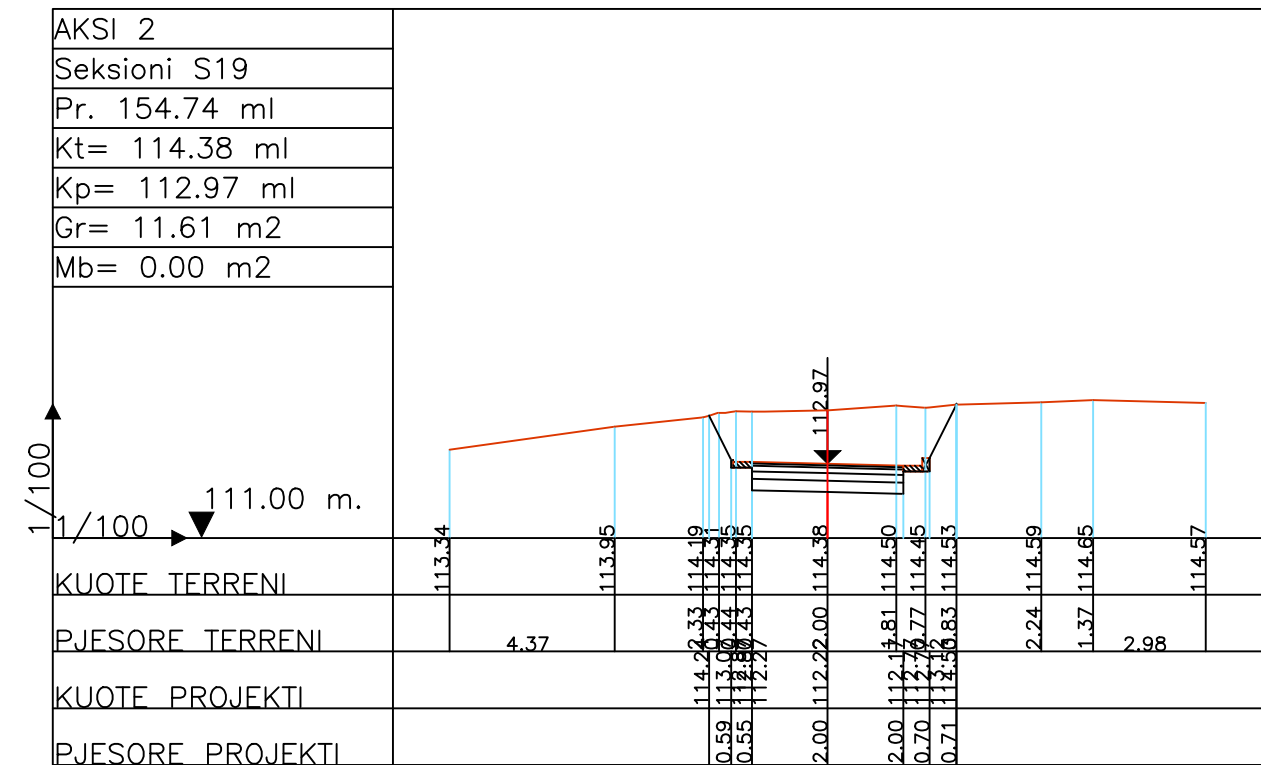
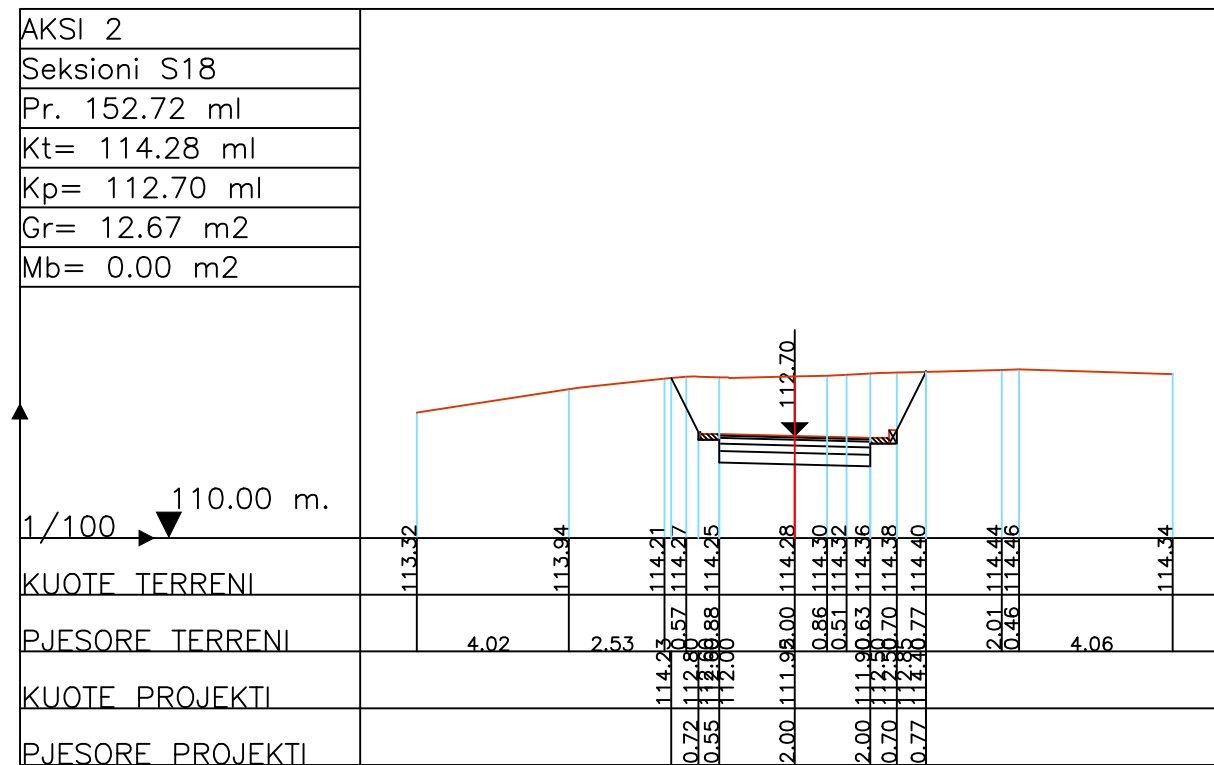

# POROSITESI : BASHKIA VORË

OBJEKTI:  
"RIKONSTRUKSION I RRUGEVE MUCAJ, SHERAJ DHE E VESLEVE  
FSHATI MUCAJ ,BASHKIA VORE "

Emertimi: PROFILET TERTHORE



"ARABEL - STUDIO" Sh.p.k  
Adresa: Njesia Bashkiake nr.7, Rruga "Frosina Plaku",  
Pallati 21, Hyrja 1, Kati 2, Tirane.  
Email: arabelstudio@gmail.com

## Drejtesues i projektit

Adm. Ana NISHKU  
Inxh. Ardi ARKAXHIU

## Projektues

Nd. Ardi ARKAXHIU  
Ark. Rigert HYRA  
Gjeo. Irfan BEGAJ  
Elek. Altin ALLKAJ  
Top. Mustafa HOXHAI  
Hid. Hajredin MURGU

## SHKALLA FLETA

1 : 200 9- 26  
Vorë 2019 Format A3

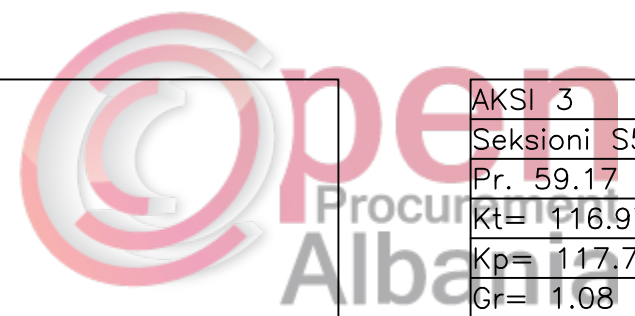
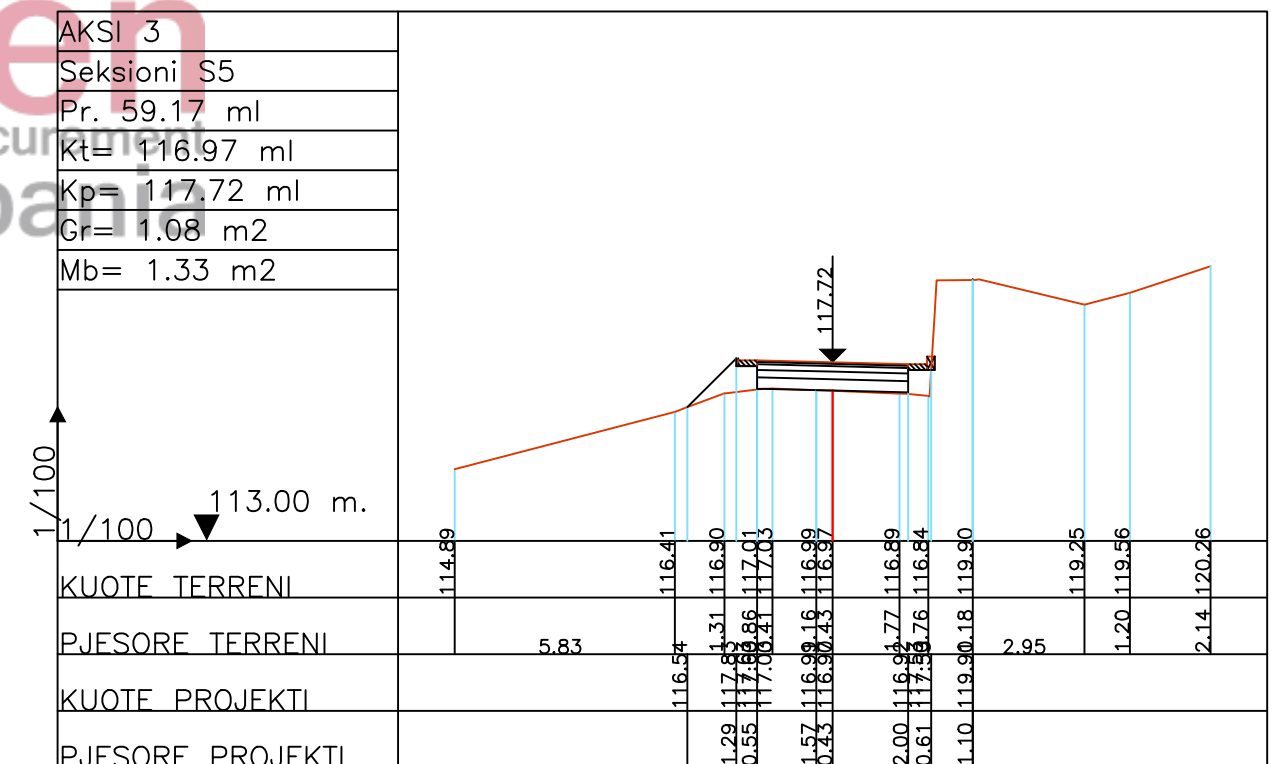
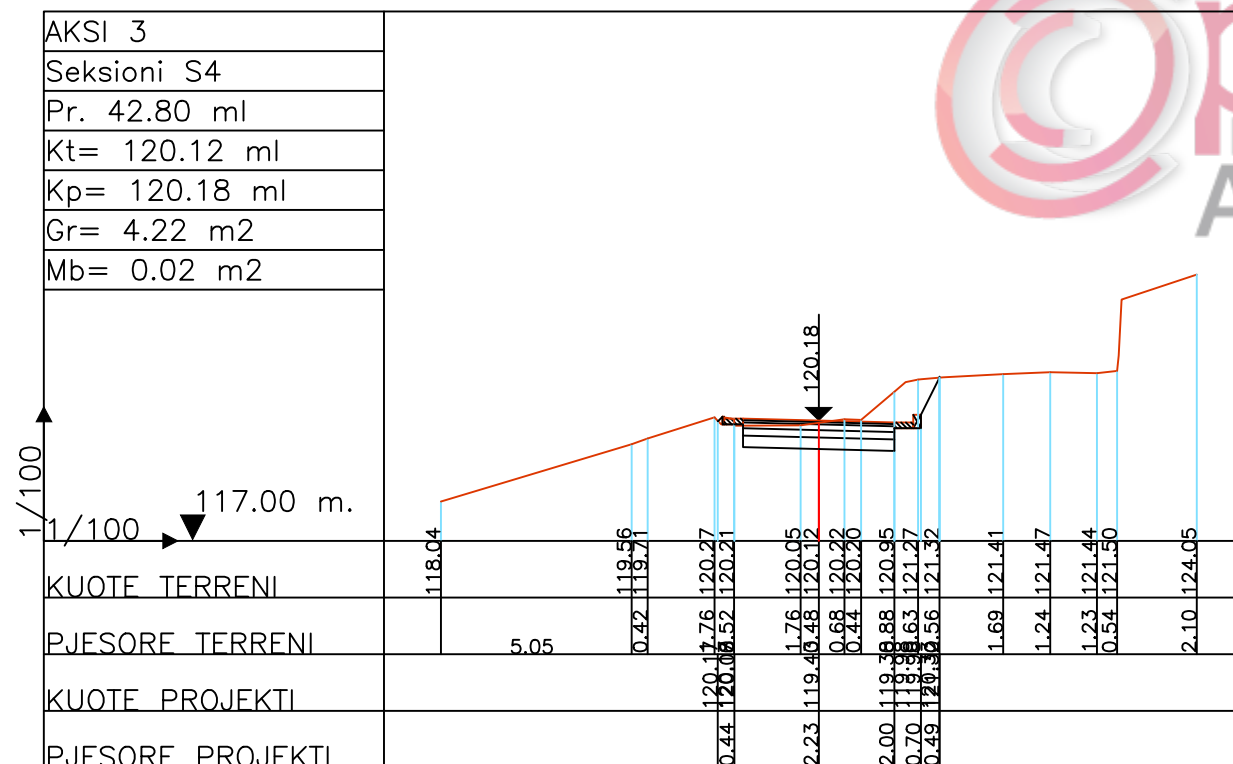
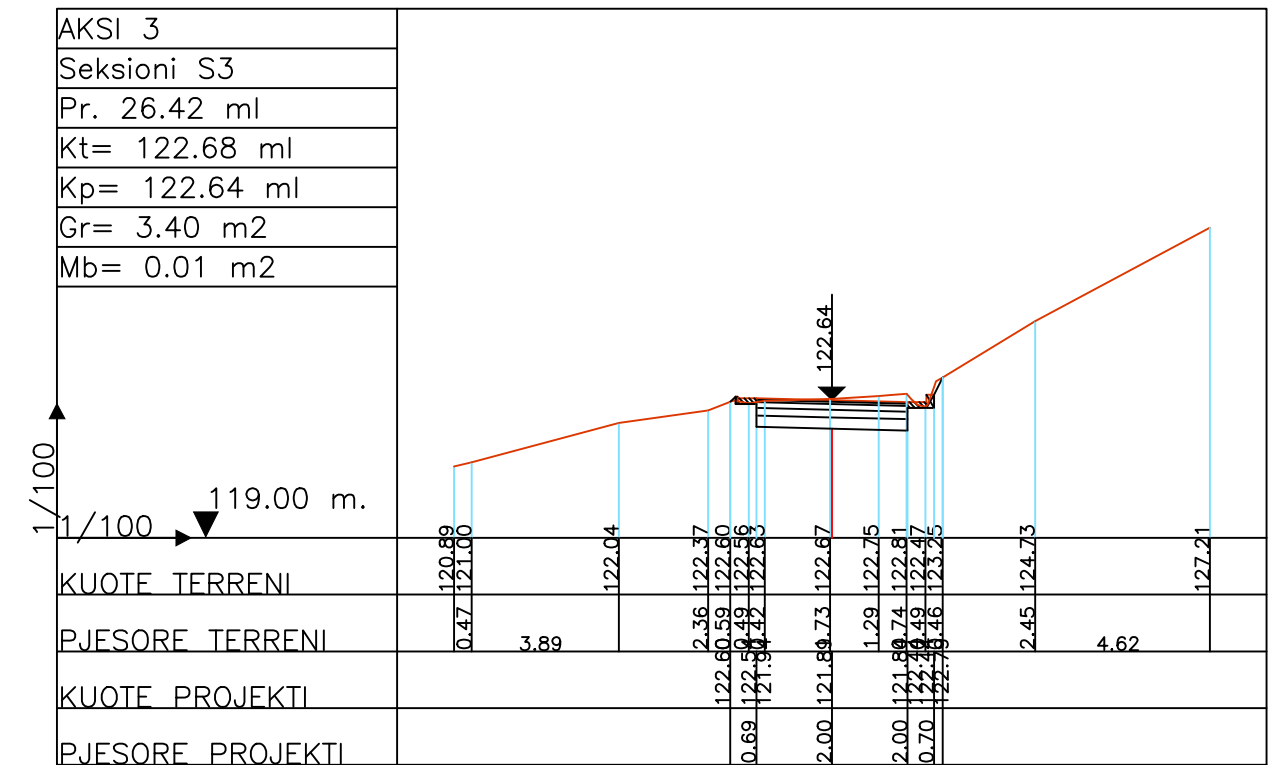
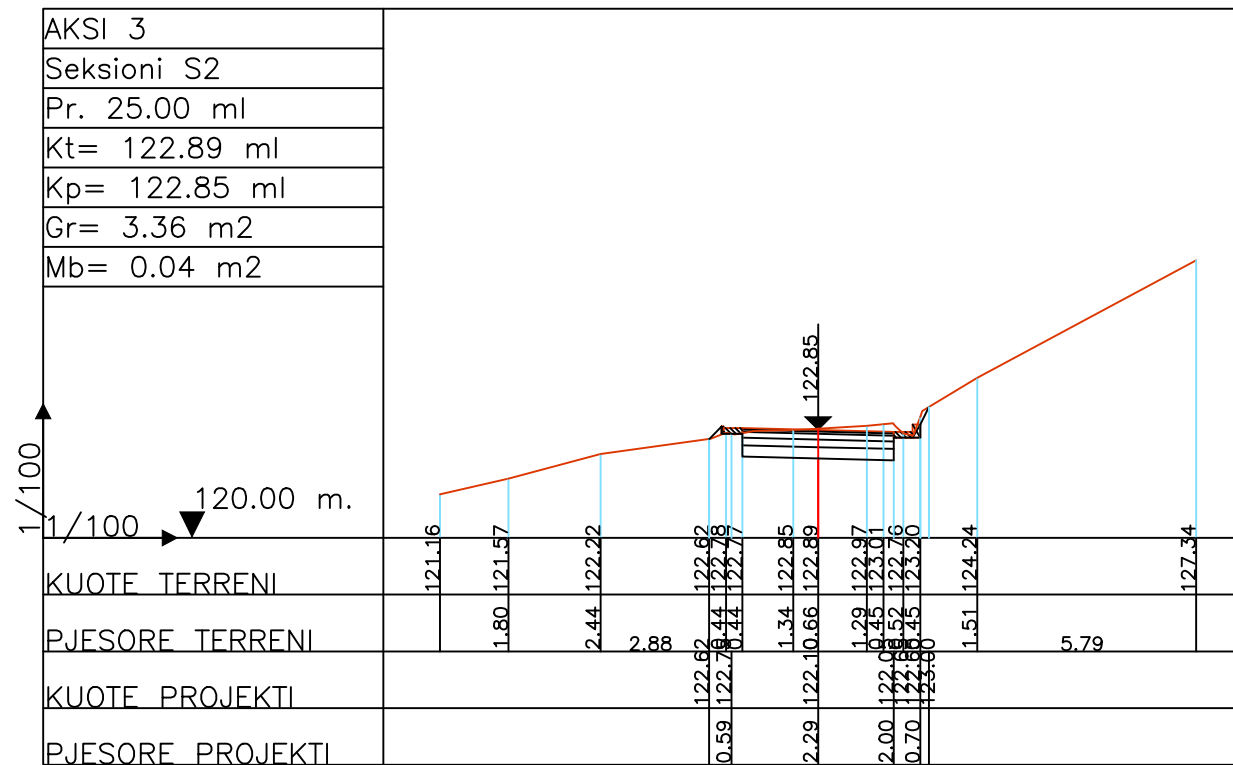

**POROSITESI : BASHKIA VORË**

OBJEKTI:  
"RIKONSTRUKSION I RRUGEVE MUCAJ, SHERAJ DHE E VESLEVE FSHATI MUCAJ ,BASHKIA VORE "

Emertimi: PROFILET TERTHORE

**"ARABEL - STUDIO" Sh.p.k**  
Adresa: Njesia Bashkiake nr.7, Rruga "Frosina Plaku", Pallati 21, Hyrja 1, Kati 2, Tirane.  
Email: arabelstudio@gmail.com

Drejtesues i projektit

Adm. Ana NISHKU  
Inxh. Ardi ARKAXHIU

Projektues

Nd. Ardi ARKAXHIU  
Ark.Rigert HYRA  
Gjeo.Irfan BEGAJ

Elek. Altin ALLKAJ  
Top. Mustafa HOXHAI  
Hid. Hajredin MURGU

SHKALLA  
1 : 200

FLETA  
9- 27

Vorë 2019  
Format A3

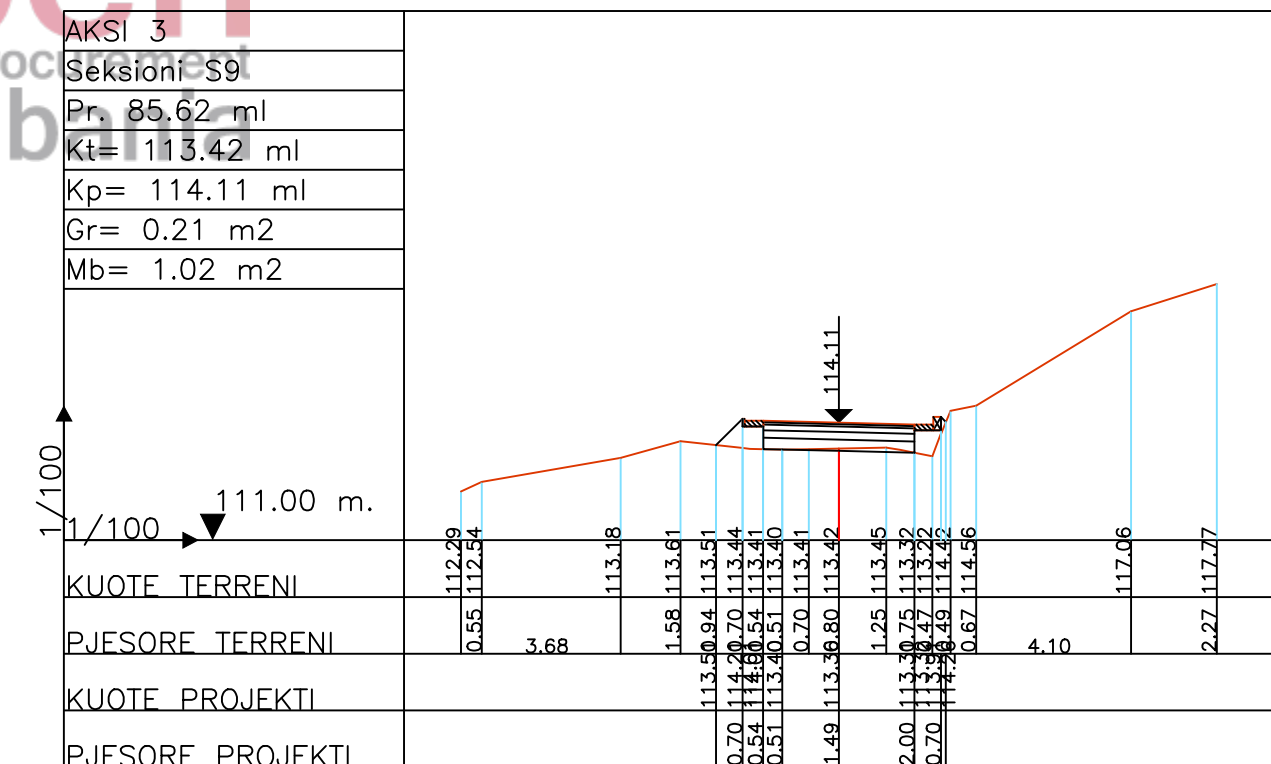
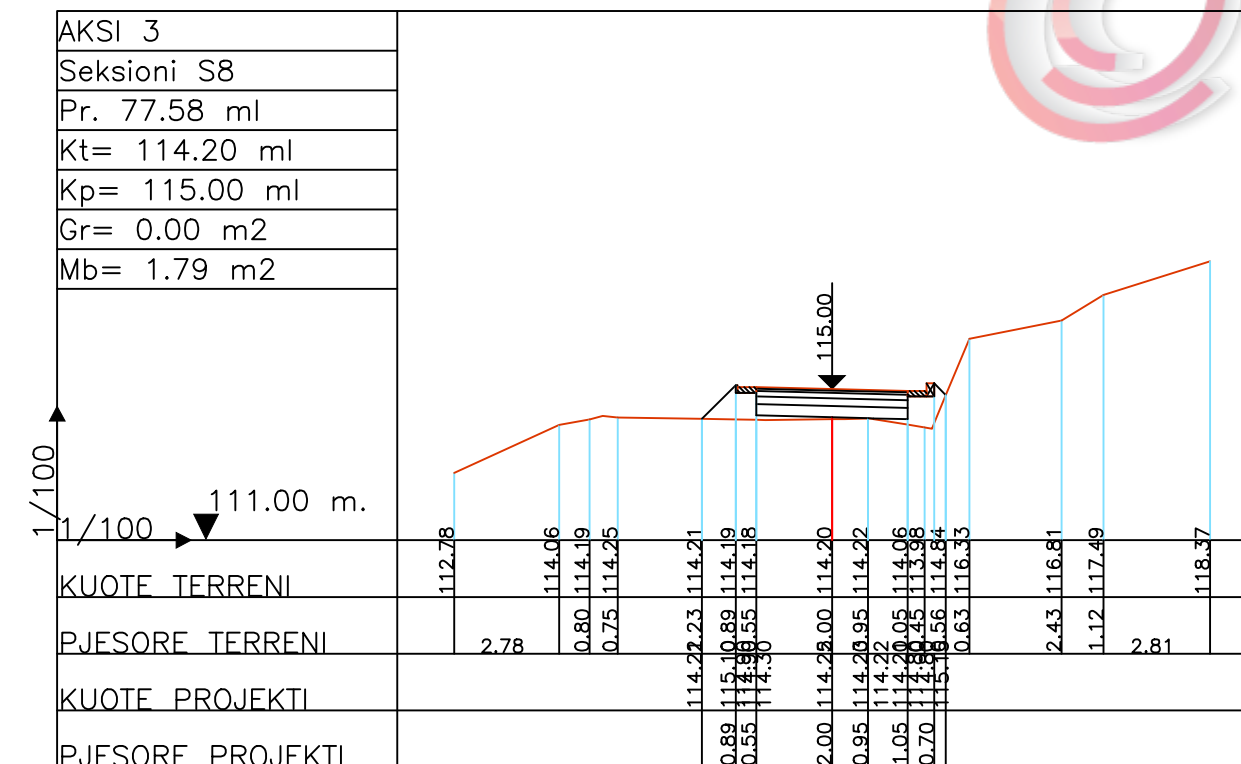
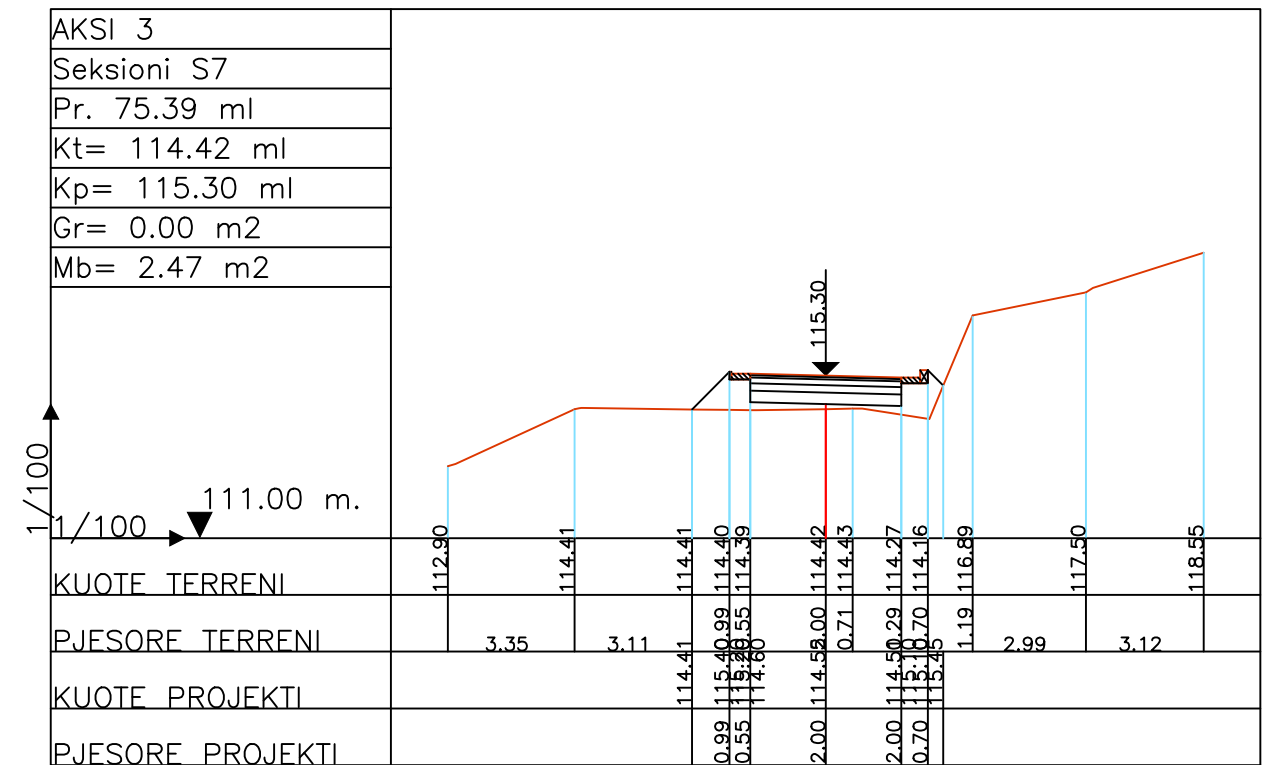
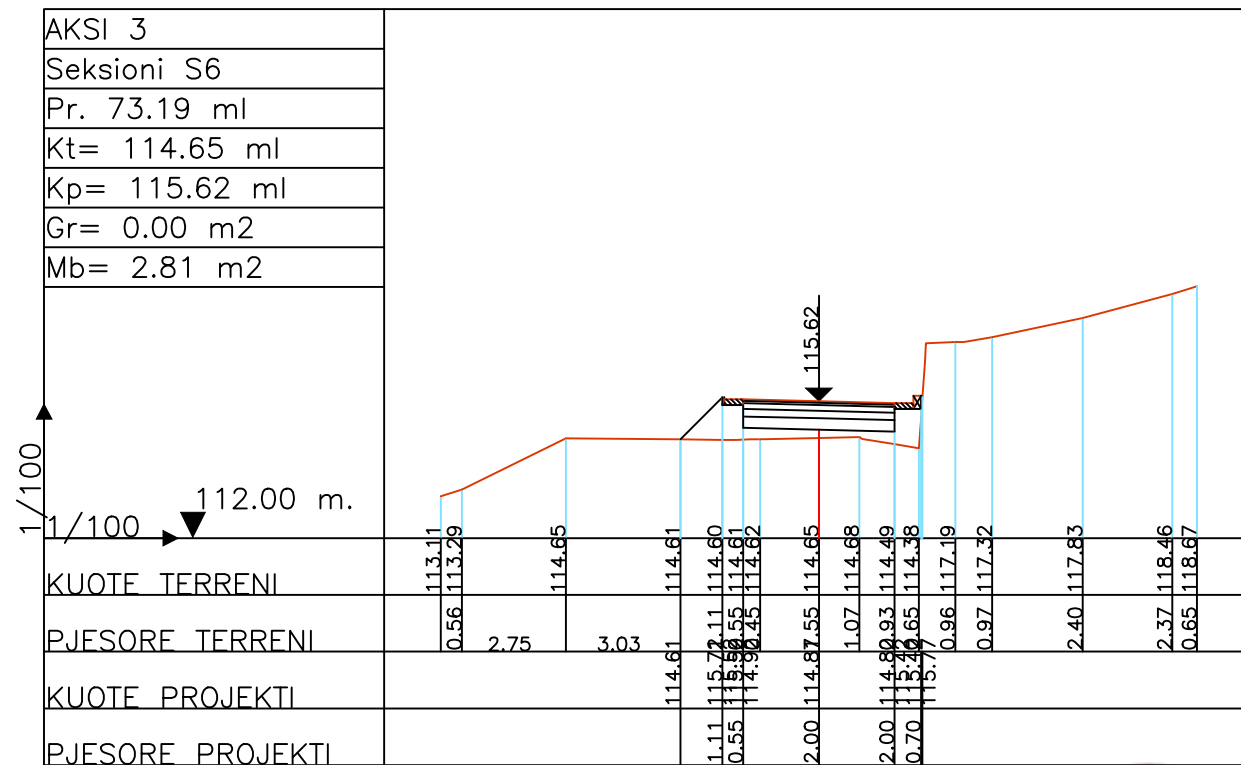

**POROSITESI : BASHKIA VORË**

OBJEKTI:  
"RIKONSTRUKSION I RRUGEVE MUCAJ, SHERAJ DHE E VESLEVE FSHATI MUCAJ ,BASHKIA VORE "

Emertimi: PROFILET TERTHORE

**"ARABEL - STUDIO" Sh.p.k**  
Adresa: Njesia Bashkiake nr.7, Rruga "Frosina Plaku", Pallati 21, Hyrja 1, Kati 2, Tirane.  
Email: arabelstudio@gmail.com

**Drejtes i projektit**

Adm. Ana NISHKU	Nd. Ardi ARKAXHIU	Elek. Altin ALLKAJ
Inxh. Ardi ARKAXHIU	Ark.Rigert HYRA	Top. Mustafa HOXHAI
	Gjeo.Irfan BEGAJ	Hid. Hajredin MURGU

<b>SHKALLA</b>	<b>FLETA</b>
1 : 200	9- 28
Vorë 2019	Format A3

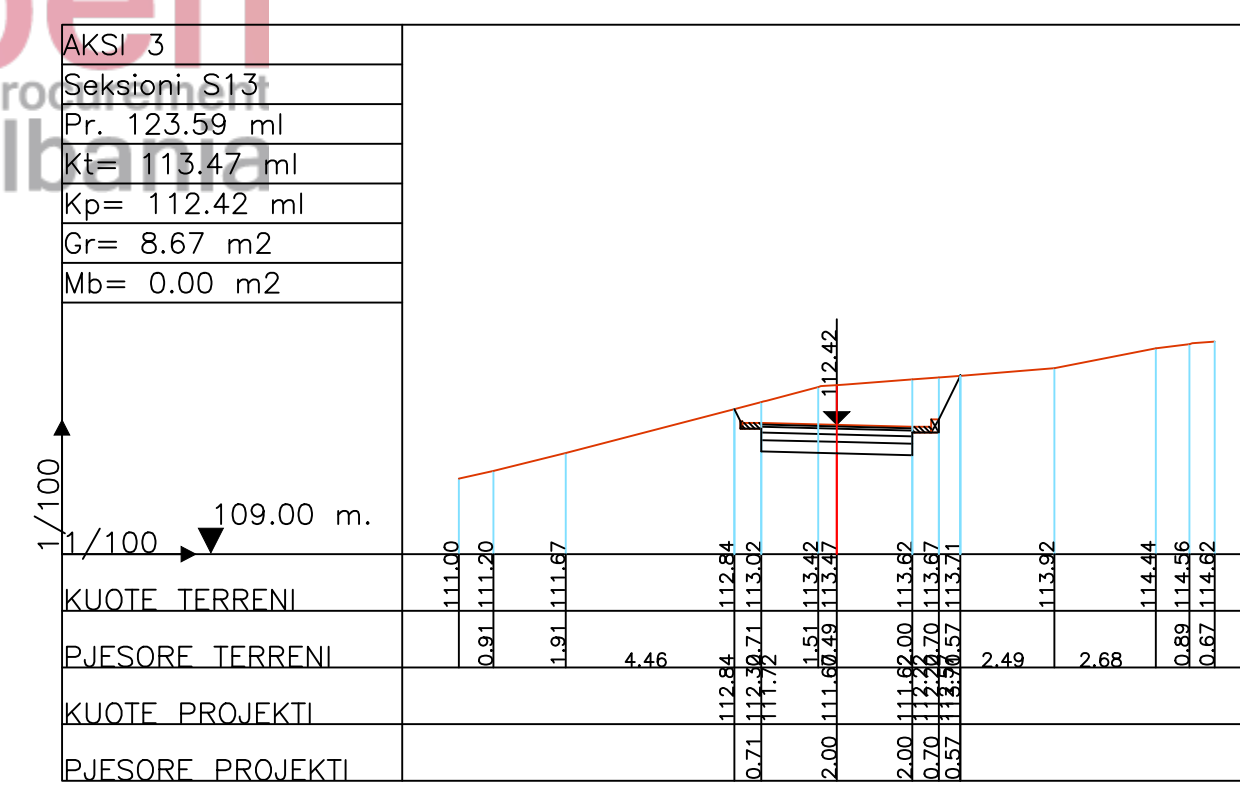
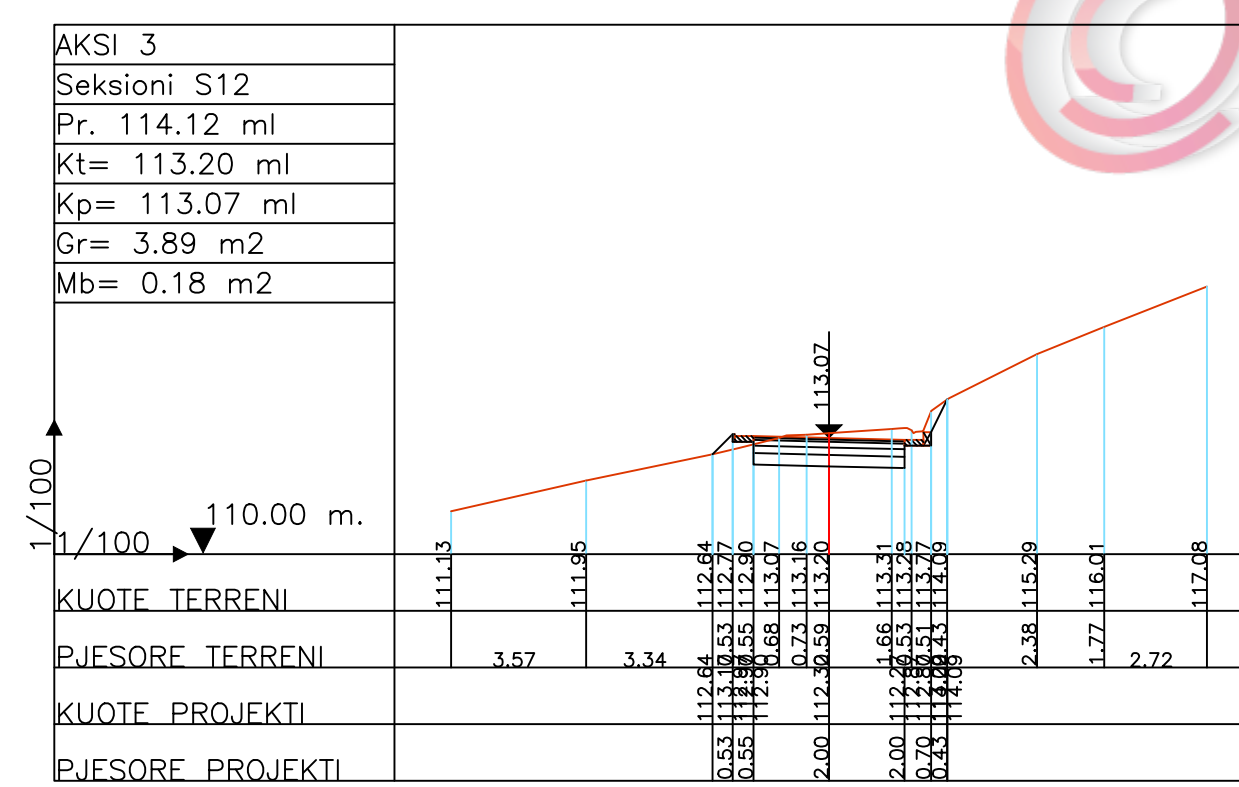
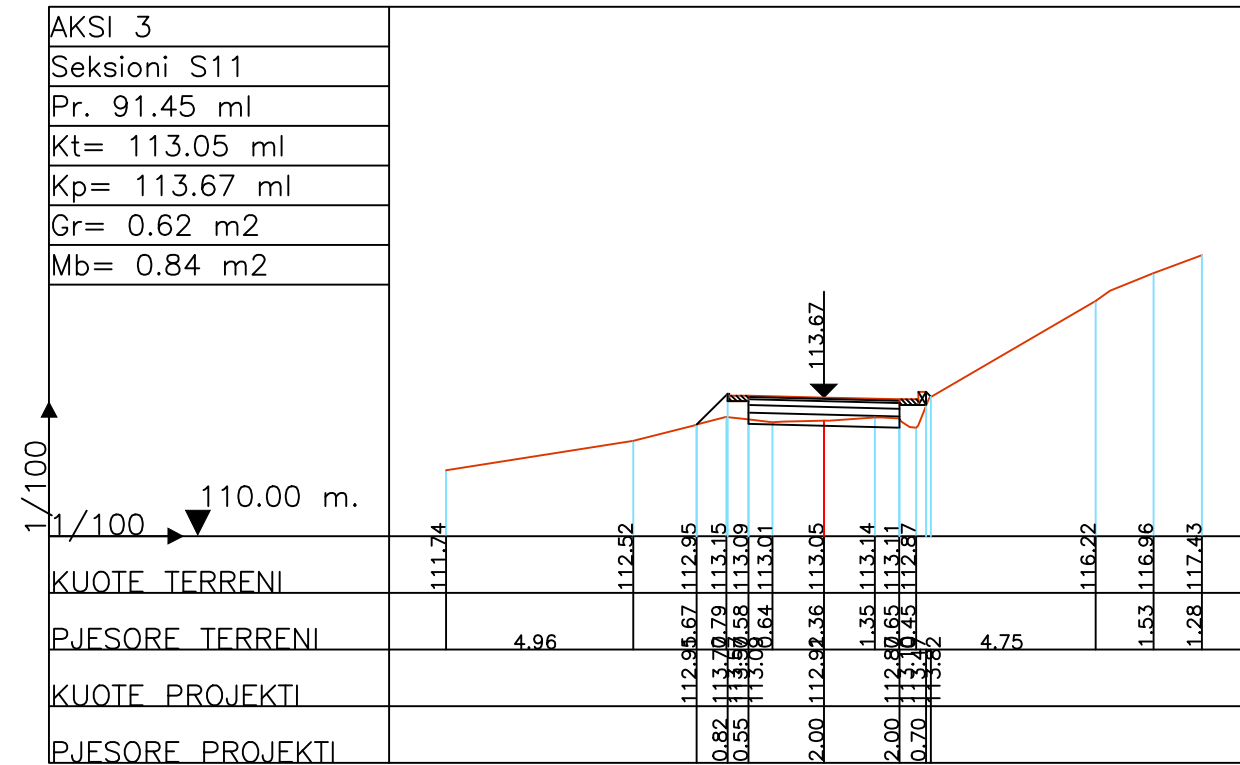
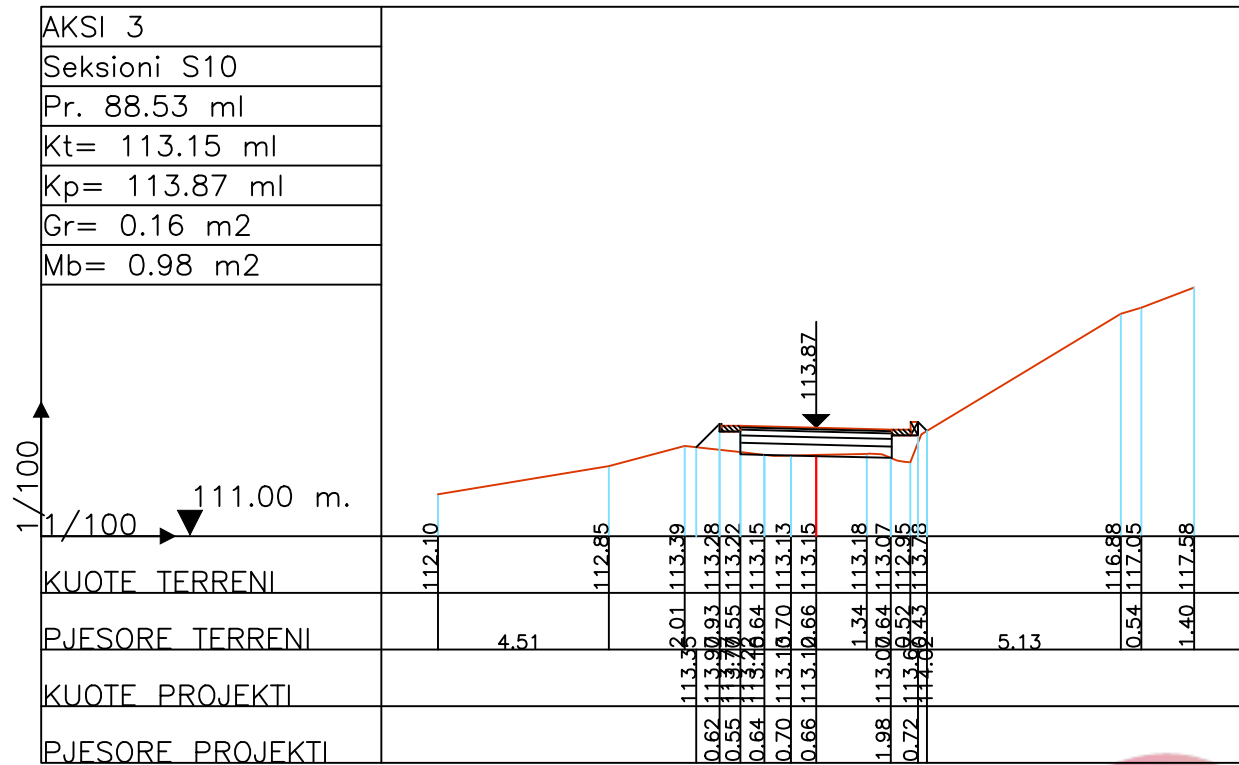

**POROSITESI : BASHKIA VORË**

OBJEKTI:  
"RIKONSTRUKSION I RRUGEVE MUCAJ, SHERAJ DHE E VESLEVE  
FSHATI MUCAJ ,BASHKIA VORE "

Emertimi: PROFILET TERTHORE

**"ARABEL - STUDIO" Sh.p.k**  
Adresa:Njesia Bashkiake nr.7, Rruga "Frosina Plaku",  
Pallati 21, Hyrja 1, Kati 2,Tirane.  
Email: arabelstudio@gmail.com

Drejtesues i projektit

Adm. Ana NISHKU

Inxh. Ardi ARKAXHIU

Projektues

Nd. Ardi ARKAXHIU

Ark.Rigert HYRA

Gjeo.Irfan BEGAJ

Elek. Altin ALLKAJ

Top. Mustafa HOXHAI

Hid. Hajredin MURGU

SHKALLA

1 : 200

Vorë 2019

FLETA

9- 29

Format A3



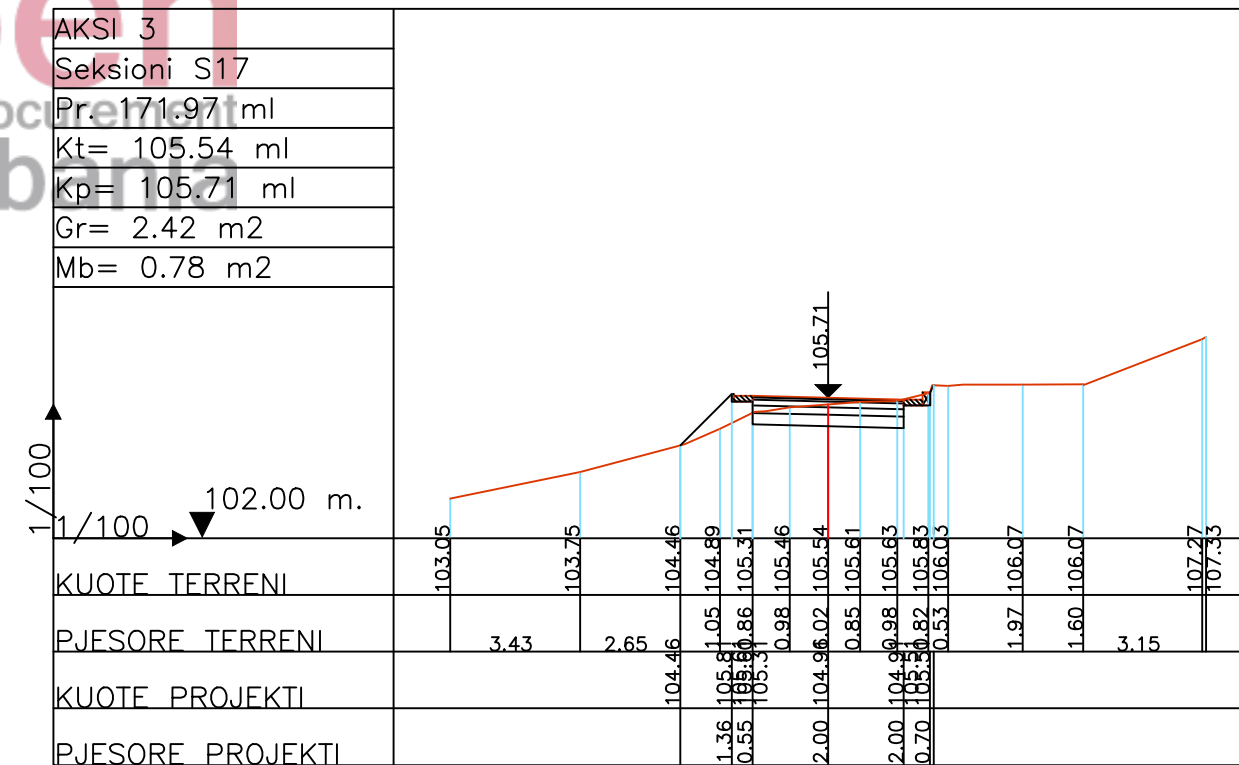
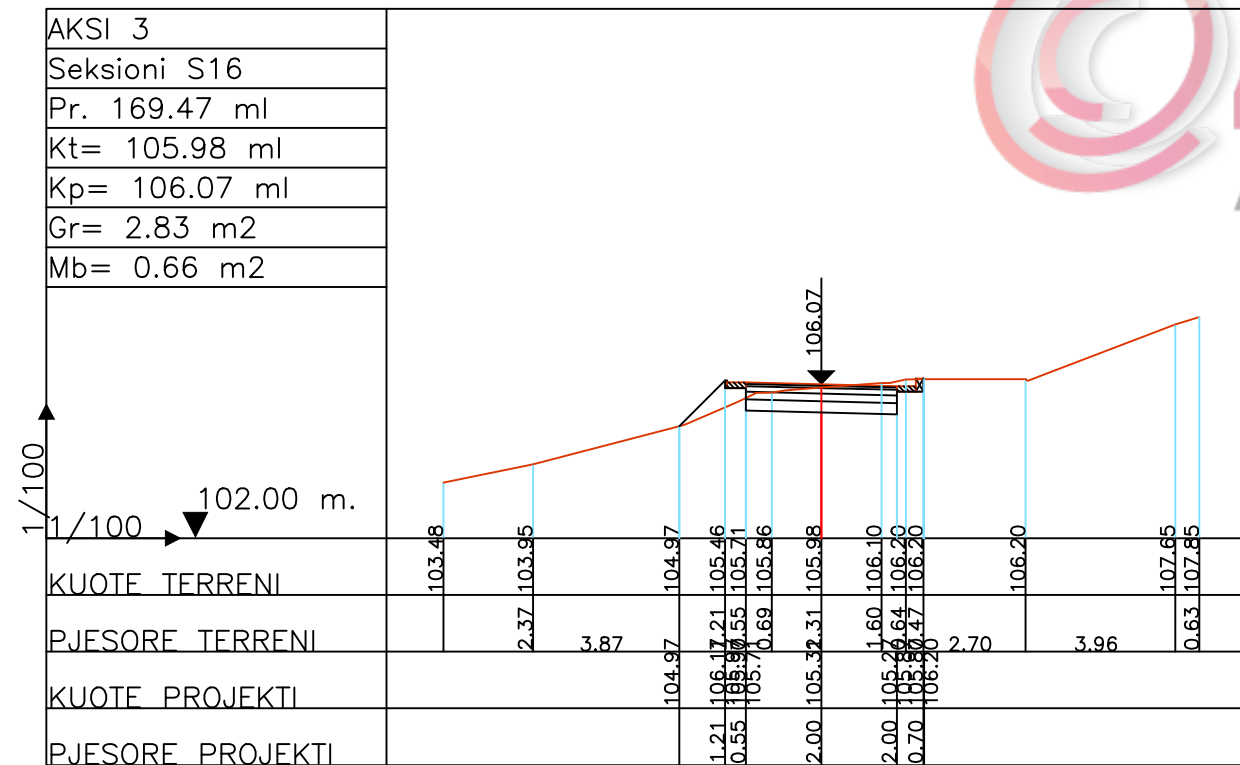
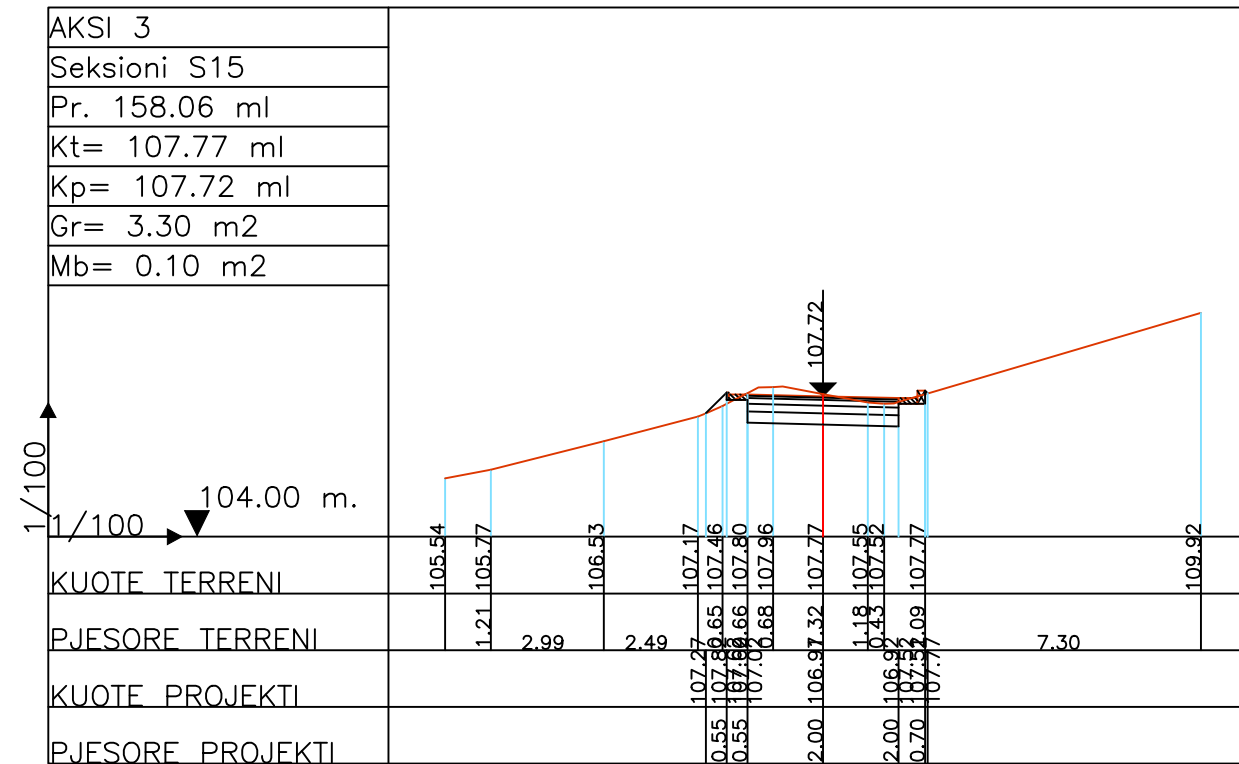
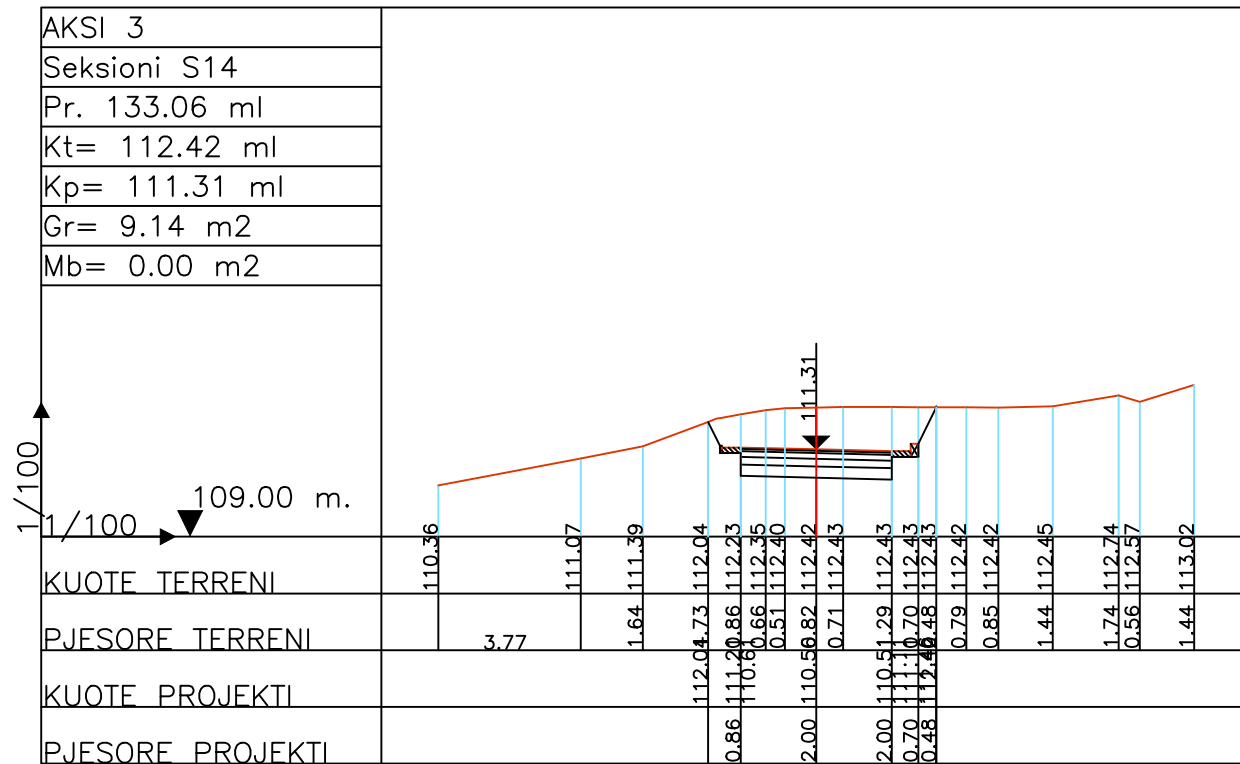

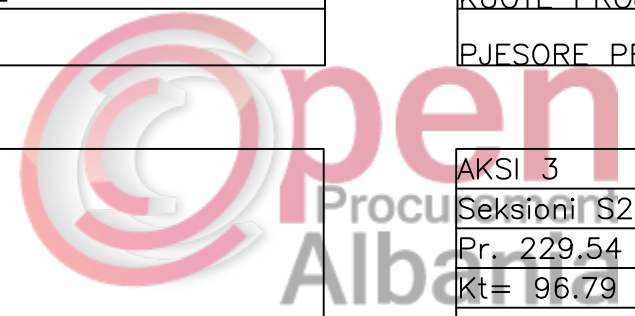
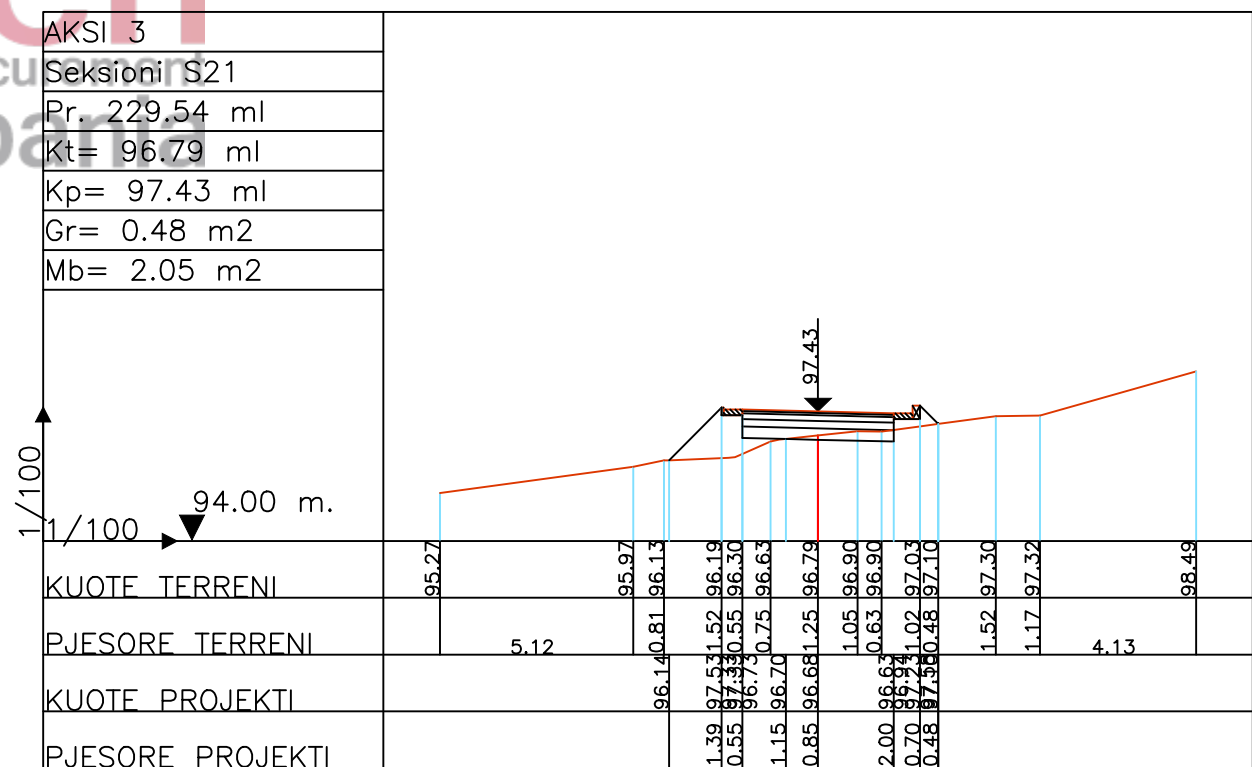
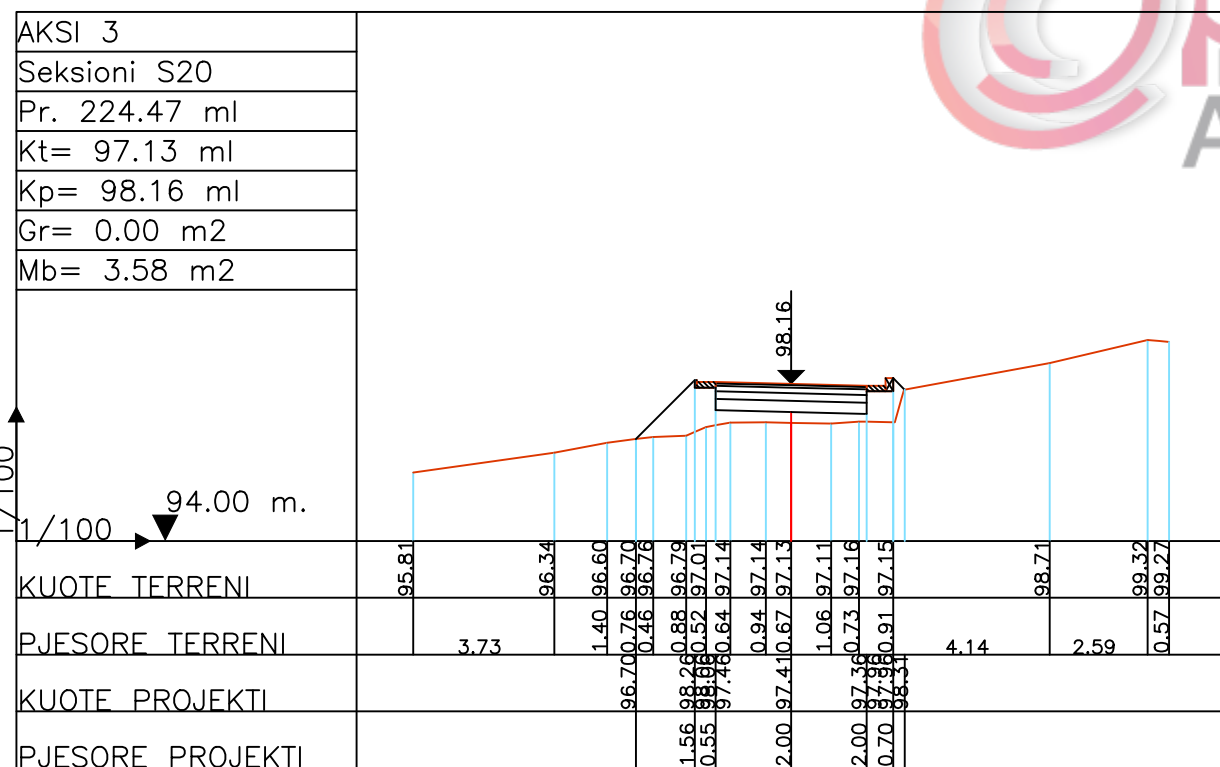
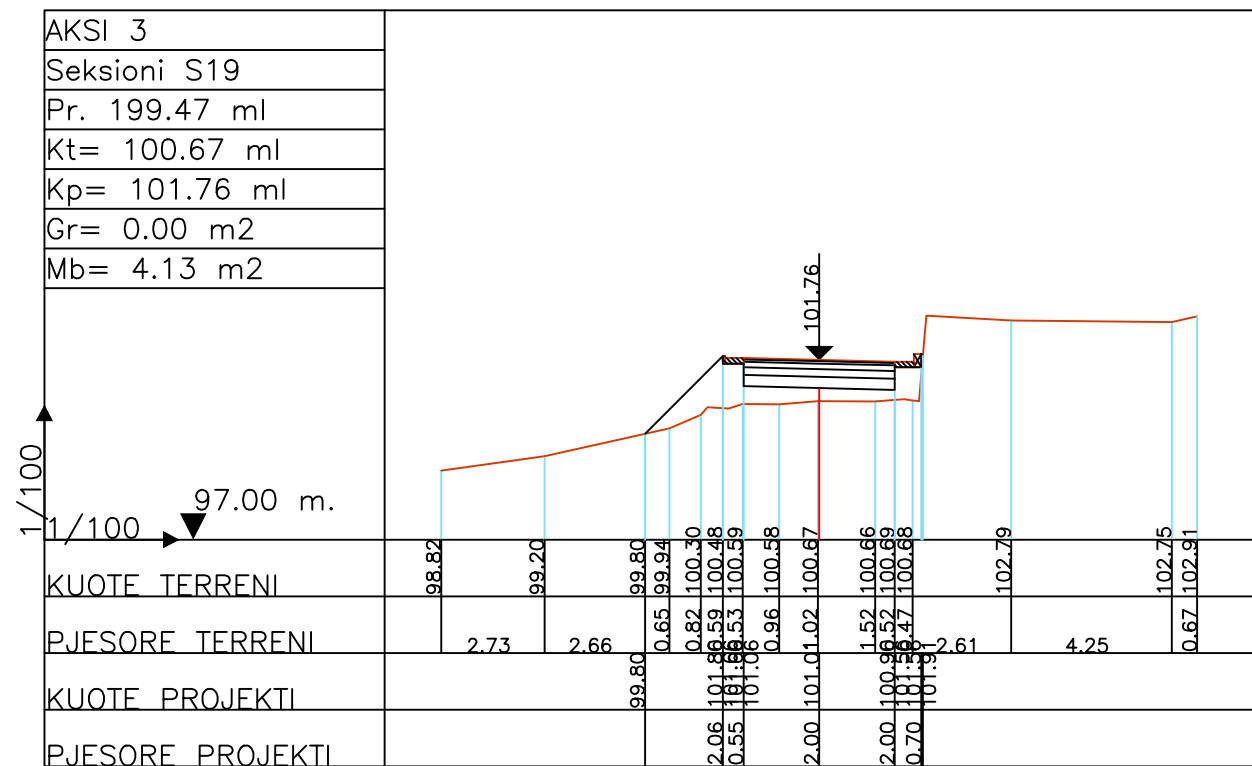
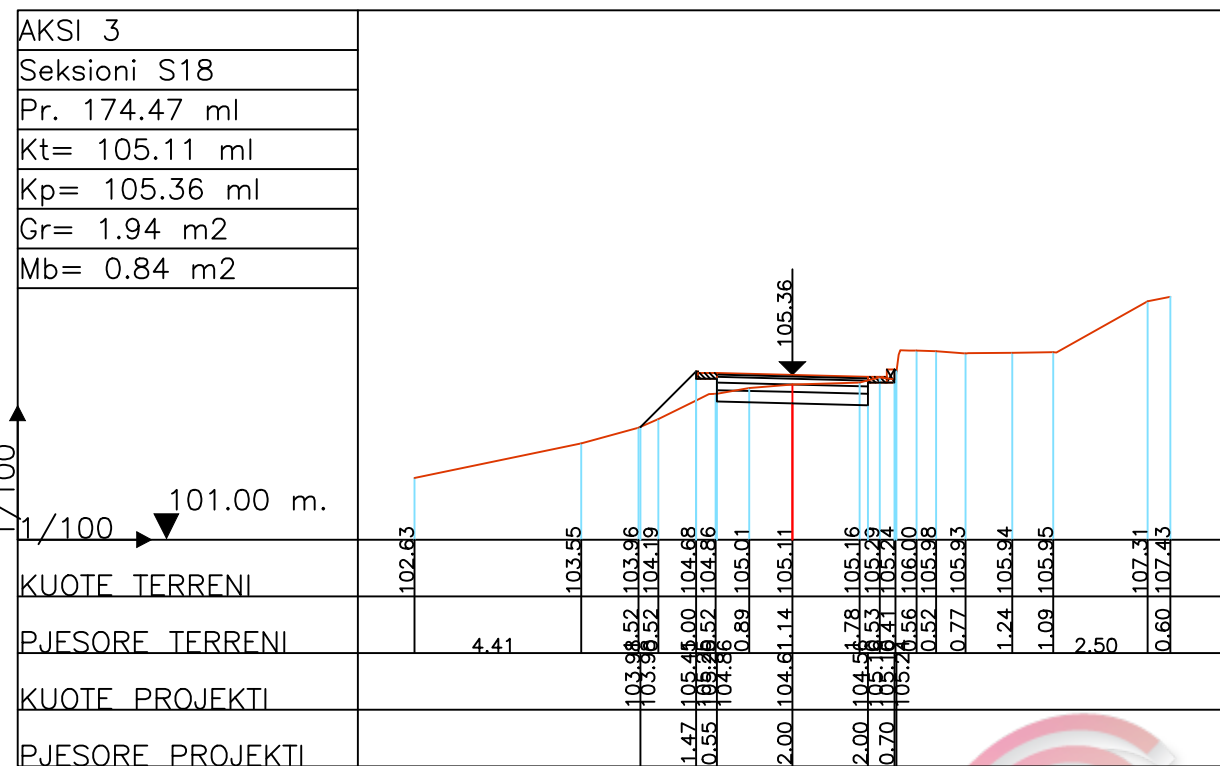

**POROSITESI : BASHKIA VORË**

OBJEKTI:  
"RIKONSTRUKSION I RRUGEVE MUCAJ, SHERAJ DHE E VESLEVE FSHATI MUCAJ ,BASHKIA VORE "

Emertimi: PROFILET TERTHORE

**"ARABEL - STUDIO" Sh.p.k**  
Adresa: Njesia Bashkiake nr.7, Rruga "Frosina Plaku", Pallati 21, Hyrja 1, Kati 2, Tirane.  
Email: arabelstudio@gmail.com

**Drejtes i projektit**

Adm. Ana NISHKU	Nd. Ardi ARKAXHIU	Elek. Altin ALLKAJ
Inxh. Ardi ARKAXHIU	Ark.Rigert HYRA	Top. Mustafa HOXHAI
	Gjeo.Irfan BEGAJ	Hid. Hajredin MURGU

<b>SHKALLA</b>	<b>FLETA</b>
1 : 200	9- 31
Vorë 2019	Format A3

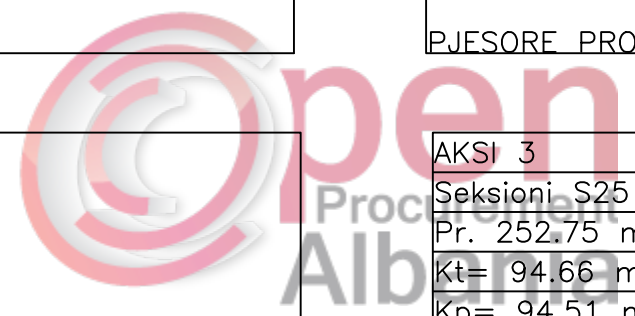
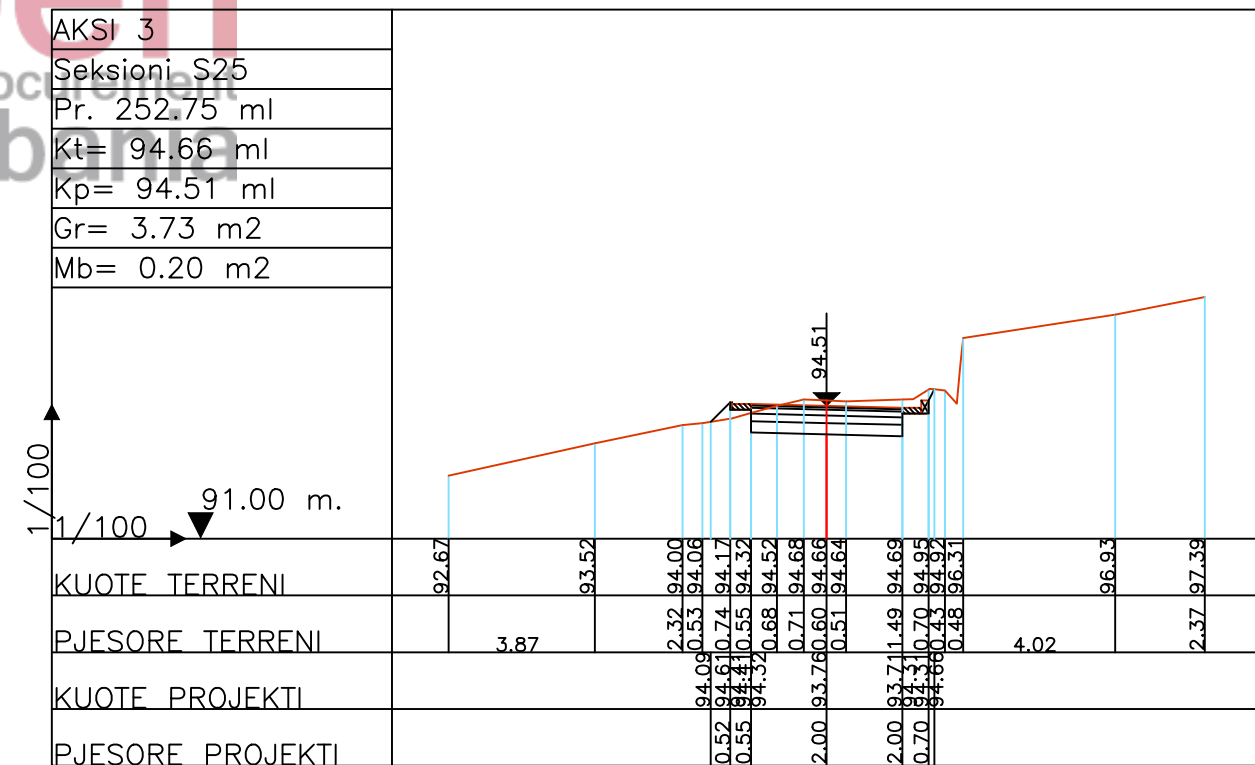
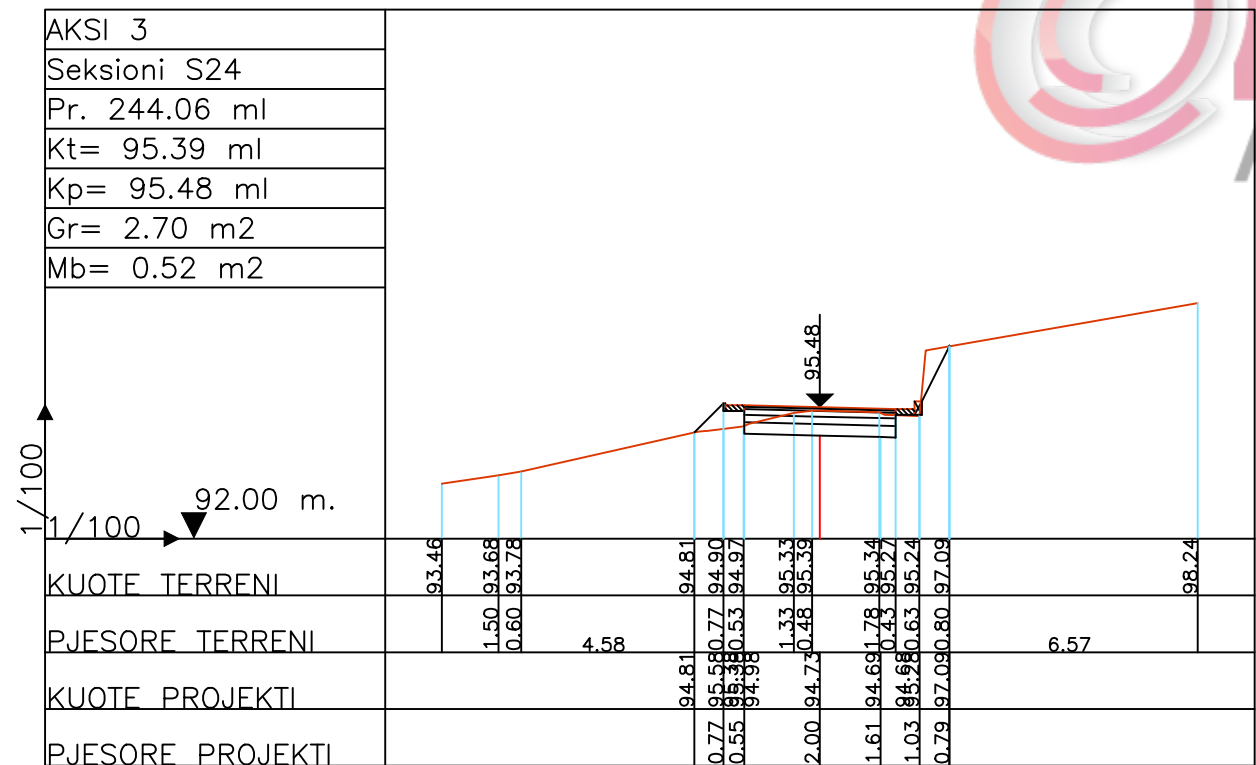
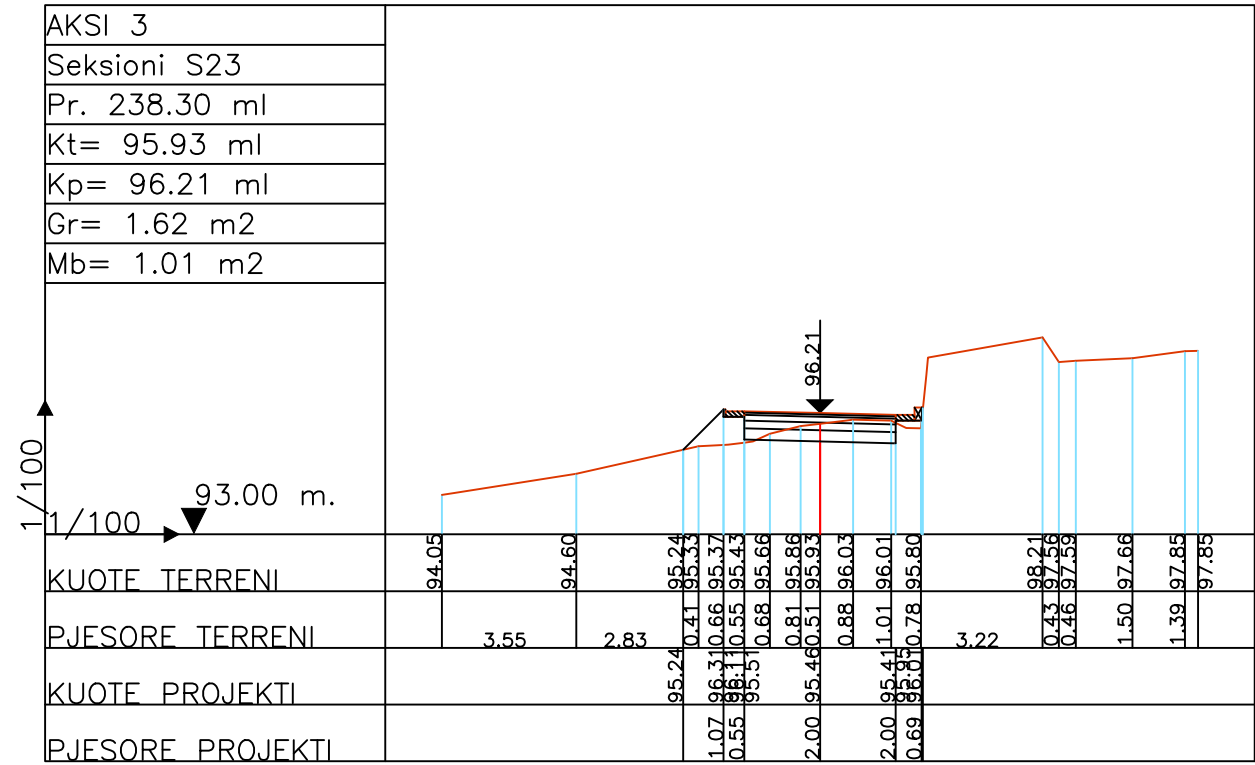
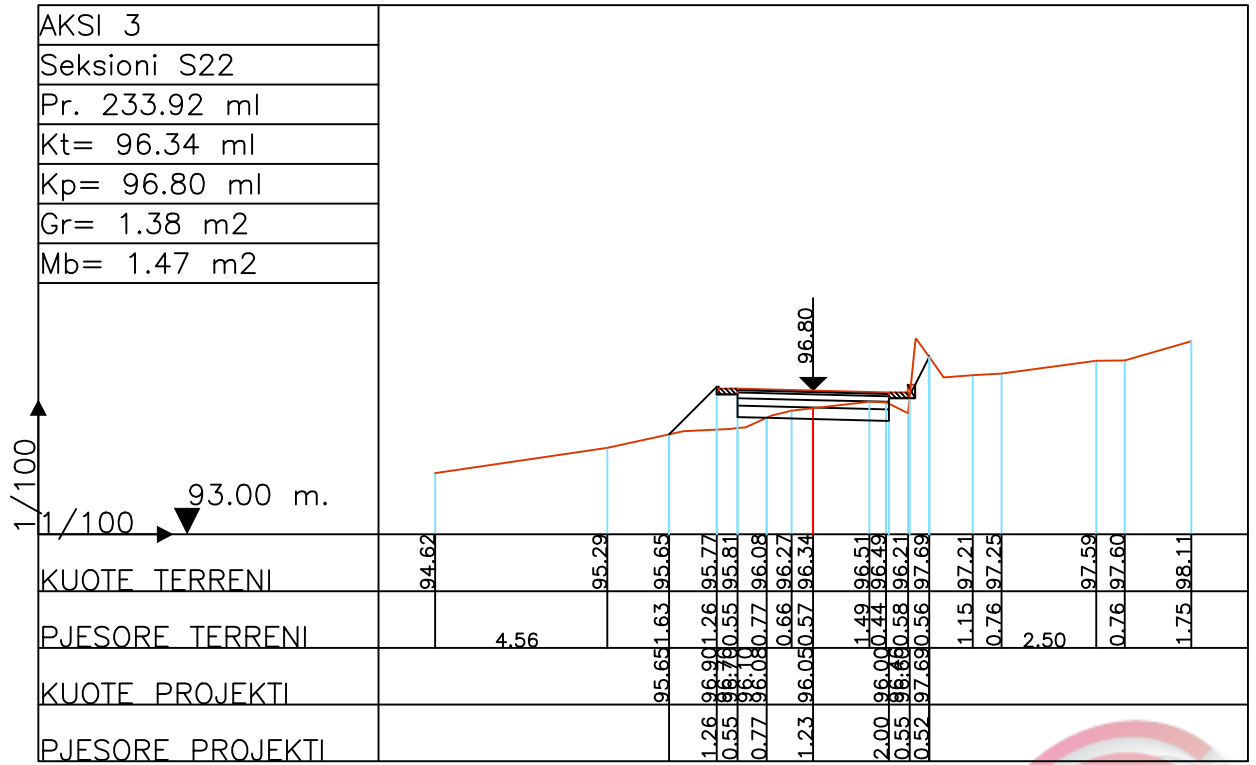

**POROSITESI : BASHKIA VORË**

OBJEKTI:  
"RIKONSTRUKSION I RRUGEVE MUCAJ, SHERAJ DHE E VESLEVE  
FSHATI MUCAJ ,BASHKIA VORE "

Emertimi: PROFILET TERTHORE

**"ARABEL - STUDIO" Sh.p.k**  
Adresa: Njesia Bashkiake nr.7, Rruga "Frosina Plaku",  
Pallati 21, Hyrja 1, Kati 2, Tirane.  
Email: arabelstudio@gmail.com

Drejtesues i projektit

Adm. Ana NISHKU  
Inxh. Ardi ARKAXHIU

Projektues

Nd. Ardi ARKAXHIU  
Ark.Rigert HYRA  
Gjeo.Irfan BEGAJ

Elek. Altin ALLKAJ  
Top. Mustafa HOXHAI  
Hid. Hajredin MURGU

SHKALLA

1 : 200

Vorë 2019

FLETA

9- 32

Format A3

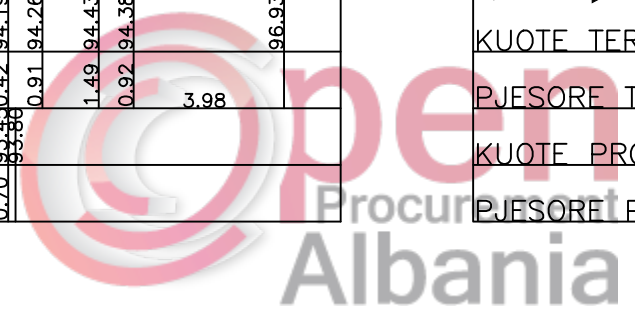
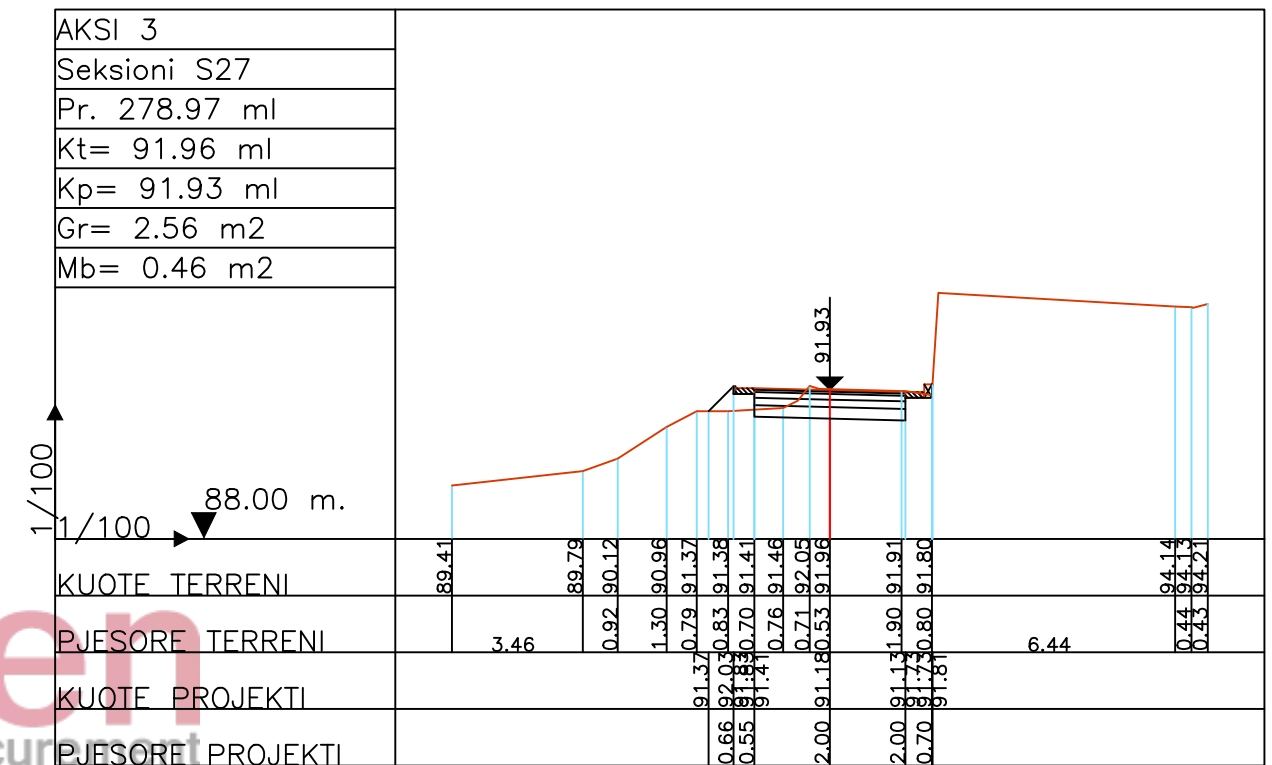
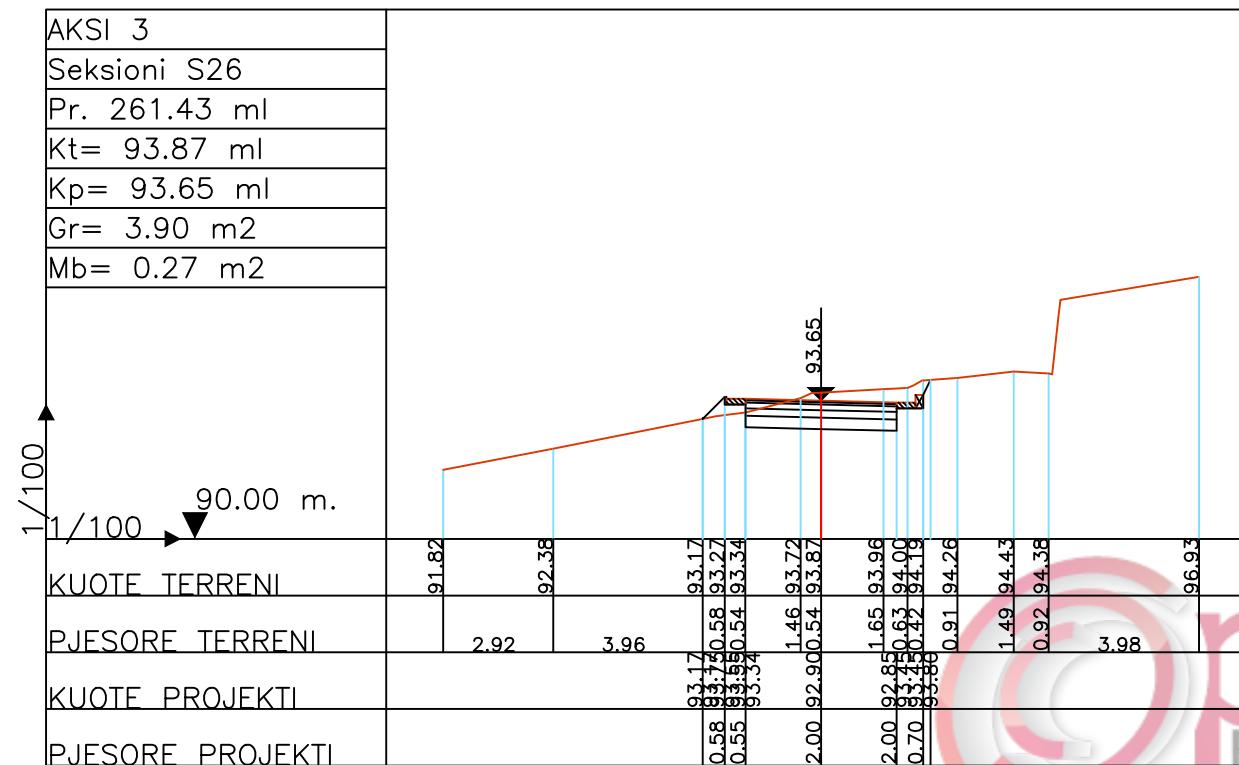

**POROSITESI : BASHKIA VORË**

OBJEKTI:  
"RIKONSTRUKSION I RRUGEVE MUCAJ, SHERAJ DHE E VESLEVE  
FSHATI MUCAJ ,BASHKIA VORE "

Emertimi: PROFILET TERTHORE

**"ARABEL - STUDIO" Sh.p.k**  
Adresa:Njesia Bashkiake nr.7, Rruga "Frosina Plaku",  
Pallati 21, Hyrja 1, Kati 2,Tirane.  
Email: arabelstudio@gmail.com

Drejtesues i projektit		Projektues	
Adm. Ana NISHKU		Nd. Ardi ARKAXHIU	Elek. Altin ALLKAJ
Inxh. Ardi ARKAXHIU		Ark.Rigert HYRA	Top. Mustafa HOXHAI
		Gjeo.Irfan BEGAJ	Hid. Hajredin MURGU

SHKALLA	FLETA
1 : 200	9- 33
Vorë 2019	Format A3

# PROJEKT ZBATIMI

## OBJEKTI:

"RIKONSTRUKSION I RRUGEVE MUCAJ, SHERAJ DHE E VESLEVE  
FSHATI MUCAJ , BASHKIA VORE "

## 12. DETAJE TE RRUGES



**POROSITESI : BASHKIA VORË**

OBJEKTI:  
"RIKONSTRUKSION I RRUGEVE MUCAJ, SHERAJ DHE E VESLEVE  
FSHATI MUCAJ , BASHKIA VORE "

Emertimi: DETAJE TE RRUGES



"ARABEL - STUDIO" Sh.p.k  
Adresa: Njesia Bashkiake nr.7, Rruga "Frosina Plaku",  
Pallati 21, Hyrja 1, Kati 2, Tirane.  
Email: arabelstudio@gmail.com

Drejtues i projektit

Adm. Ana NISHKU  
Inxh. Ardi ARKAXHIU

Projektues

Nd. Ardi ARKAXHIU  
Ark. Rigert HYRA  
Gjeo. Irfan BEGAJ  
Elek. Altin ALLKAJ  
Top. Mustafa HOXHAJ  
Hid. Hajredin MURGU

SHKALLA FLETA

1 :-

12-

Vorë 2019 Format A3

**MURE MBAJTES B/ARME H=2M**  
 $[\sigma]_t=2\text{kg/cm}^2$  DHE  $4\text{kg/cm}^2$ ,  $\varphi_m \geq 35^\circ$   
 SH. 1:25

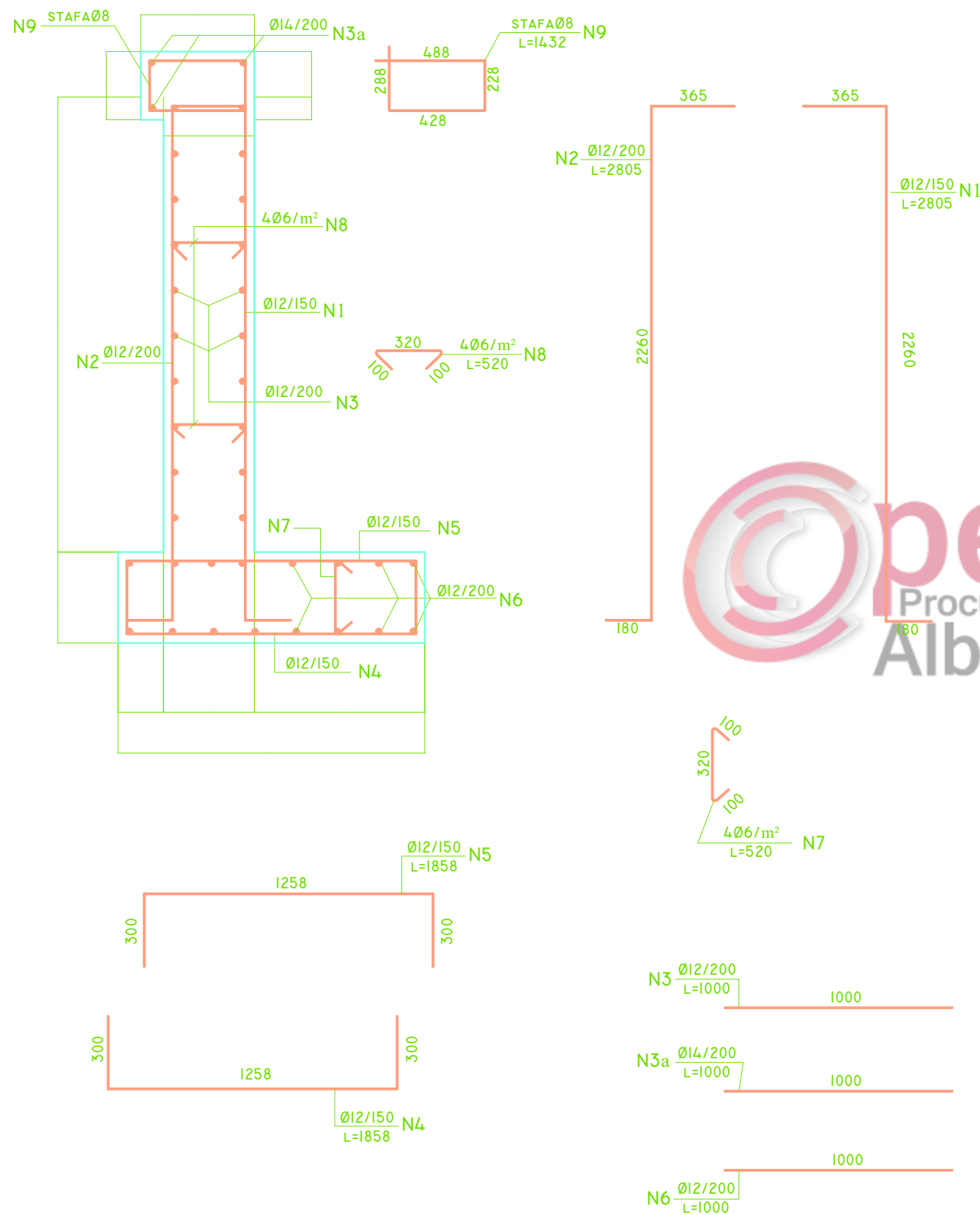

**TABELA E HEKURAVE**  
 PER  $[\sigma]_t=2\text{kg/cm}^2$  DHE  $4\text{kg/cm}^2$

NR.	Ø mm	L mm	SASIA cope	L m	PERMBLEDHJE E ARMATURES.			
					Ø mm	ΣL m	PESHA kg/ml	PESHA kg
1	12	2805	7	19.64	6	7.28	0.222	1.62
2	12	2805	5	14.03	8	7.16	0.395	2.83
3	12	1000	20	20.00	12	95.69	0.888	84.97
3a	14	1000	3	3.00	14	3.00	1.208	3.62
4	12	1858	7	13.01				
5	12	1858	7	13.01				
6	12	1000	16	16.00				
7	6	520	6	3.12				
8	6	520	8	4.16				
9	8	1432	5	7.16				
<b>SHUMA</b>							kg/ml	93.04
<b>BETON Rck=300kg/cm<sup>2</sup></b>							m <sup>3</sup> /ml	1.45



**SHENIME:**

- 1- MURI ESHTË PROJEKTUAR PER:
  - NGARKESE TE LEVIZESHME NE PRIZMIN E SHKATERIMIT  $q=1.7\text{T/m}^2$
  - MBUSHJE MBRAPA TIJ ME MATERIAL SHKEMBOR ME KEND TE FERKIMIT TE MBRENDSEME  $\varphi \geq 35^\circ$ .
  - NGARKESE TE LEJUAR NE TABAN  $[\sigma]=2\text{kg/cm}^2$  DHE  $4\text{kg/cm}^2$
- 2- MURI ESHTË PARASHIKUAR TE NDERTOHE:
  - ME BETON Rck=300kg/cm<sup>2</sup>
  - ARMATURE PREJ CELIKU Feb-44K.
- 3- LARGESIA NGA FAQJA E BETONIT DERI TEK FAQJA E ARMATURES PUNUESE DO TE MERRET 40mm.
- 4- PERMASAT E BETONIT JANE DHENE NE CENTIMETRA (cm), TE ARMATURES SE HEKURIT NE MILIMETRA (mm).
- 5- DETAJI I FIKSIMIT TE PARAPETIT METALIK JEPET ME PROJEKT TE VECANTE.



**POROSITESI : BASHKIA VORË**

OBJEKTI:  
 "RIKONSTRUKSION I RRUGEVE MUCAJ, SHERAJ DHE E VESLEVE FSHATI MUCAJ, BASHKIA VORE"

Emertimi: DETAJE TE RRUGES



**"ARABEL - STUDIO" Sh.p.k**  
 Adresa: Njesia Bashkiake nr.7, Rruga "Frosina Plaku",  
 Pallati 21, Hyrja 1, Kati 2, Tirane.  
 Email: arabelstudio@gmail.com

**Drejtues i projektit**

Adm. Ana NISHKU  
 Inxh. Ardi ARKAXHIU

**Projektues**

Nd. Ardi ARKAXHIU  
 Ark.Rigert HYRA  
 Gjeo.Irfan BEGAJ  
 Elek. Altin ALLKAJ  
 Top. Mustafa HOXHAJ  
 Hid. Hajredin MURGU

**SHKALLA**

1 : 50  
 Vorë 2019

**FLETA**

12- 01  
 Format A3

**MURE MBAJTES B/ARME H=3M**  
 $[\sigma]_t=2\text{kg/cm}^2$  DHE  $4\text{kg/cm}^2$ ,  $\phi_m \geq 35^\circ$

SH. 1:25

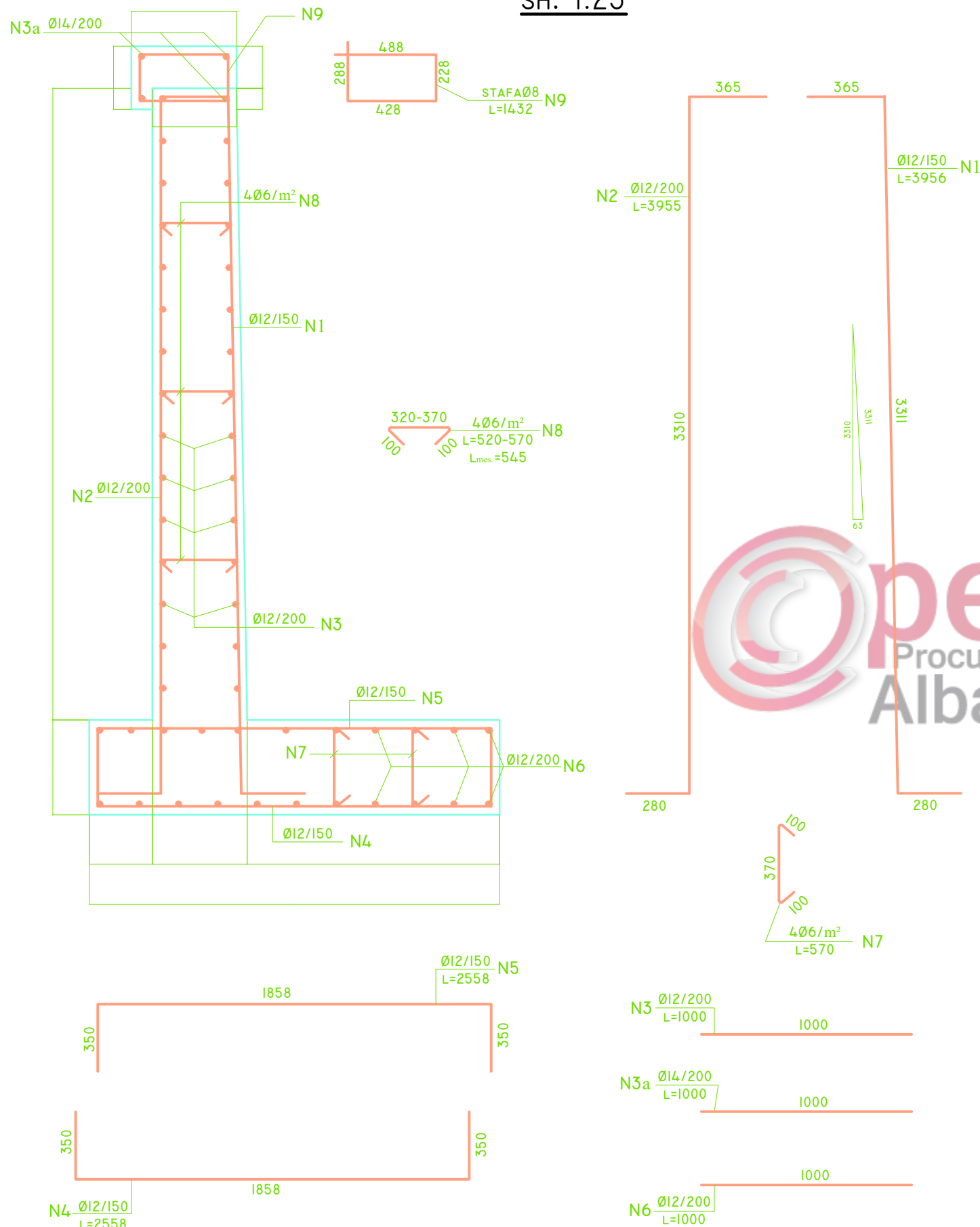

**TABELA E HEKURAVE**  
 PER  $[\sigma]_t=2\text{kg/cm}^2$  DHE  $4\text{kg/cm}^2$

NR.	Ø mm	L mm	SASIA cope	L m	PERMBLEDHJE E ARMATURES.				
					Ø mm	ΣL m	PESHA kg/ml	PESHA kg	
1	12	3956	7	27.69	6	11.10	0.222	2.46	
2	12	3955	5	19.78	8	7.16	0.395	2.83	
3	12	1000	30	30.00	12	135.29	0.888	120.14	
3a	14	1000	3	3.00	14	3.00	1.208	3.62	
4	12	2558	7	17.91					
5	12	2558	7	17.91					
6	12	1000	22	22.00					
7	6	570	8	4.56					
8	6	545	12	6.54					
9	8	1432	5	7.16					
SHUMA							kg/ml	129.05	
BETON Rck=300kg/cm²							m³/ml	2.26	



**SHENIME:**

- MURI ESHTË PROJEKTUAR PER:
  - NGARKESE TE LEVIZESHME NE PRIZMIN E SHKATERIMIT  $q=1.7\text{T/m}^2$
  - MBUSHJE MBRAPA TIJ ME MATERIAL SHKEMBOR ME KEND TE FERKIMIT TE MBRENSHEM  $\phi \geq 35^\circ$ .
  - NGARKESE TE LEJUAR NE TABAN  $[\sigma]=2\text{kg/cm}^2$  DHE  $4\text{kg/cm}^2$
- MURI ESHTË PARASHIKUAR TE NDERTOHE:
  - ME BETON Rck=300kg/cm²
  - ARMATURE PREJ CELIKU Feb-44k.
- LARGESIA NGA FAQJA E BETONIT DERI TEK FAQJA E ARMATURES PUNUESE DO TE MERRET 40mm.
- PERMASAT E BETONIT JANE DHENE NE CENTIMETRA (cm), TE ARMATURES SE HEKURIT NE MILIMETRA (mm).
- DETAJI I FIKSIMIT TE PARAPETIT METALIK JEPET ME PROJEKT TE VECANTE.

**SHENIME:**

- NE KETE OBJEKT DO TE ZBATOHE MURI ME H=3M DHE  $[\sigma]_t=4\text{kg/cm}^2$



**POROSITESI : BASHKIA VORË**

OBJEKTI:  
 "RIKONSTRUKSION I RRUGEVE MUCAJ, SHERAJ DHE E VESLEVE FSHATI MUCAJ, BASHKIA VORE"

Emertimi: DETAJE TE RRUGES



"ARABEL - STUDIO" Sh.p.k  
 Adresa: Njesia Bashkiake nr.7, Rruga "Frosina Plaku", Pallati 21, Hyrja 1, Kati 2, Tirane.  
 Email: arabelstudio@gmail.com

Drejtes i projektit

Adm. Ana NISHKU  
 Inxh. Ardi ARKAXHIU

Projektues

Nd. Ardi ARKAXHIU  
 Ark.Rigert HYRA  
 Gjeo.Irfan BEGAJ  
 Elek. Altin ALLKAJ  
 Top. Mustafa HOXHAJ  
 Hid. Hajredin MURGU

SHKALLA

1 : 50

Vorë 2019

FLETA

12-02

Format A3

**MURE MBAJTES B/ARME H=4M**  
 $[\sigma]_t=2\text{kg/cm}^2$  DHE  $4\text{kg/cm}^2$ ,  $\varphi_m \geq 35^\circ$   
 SH. 1:50

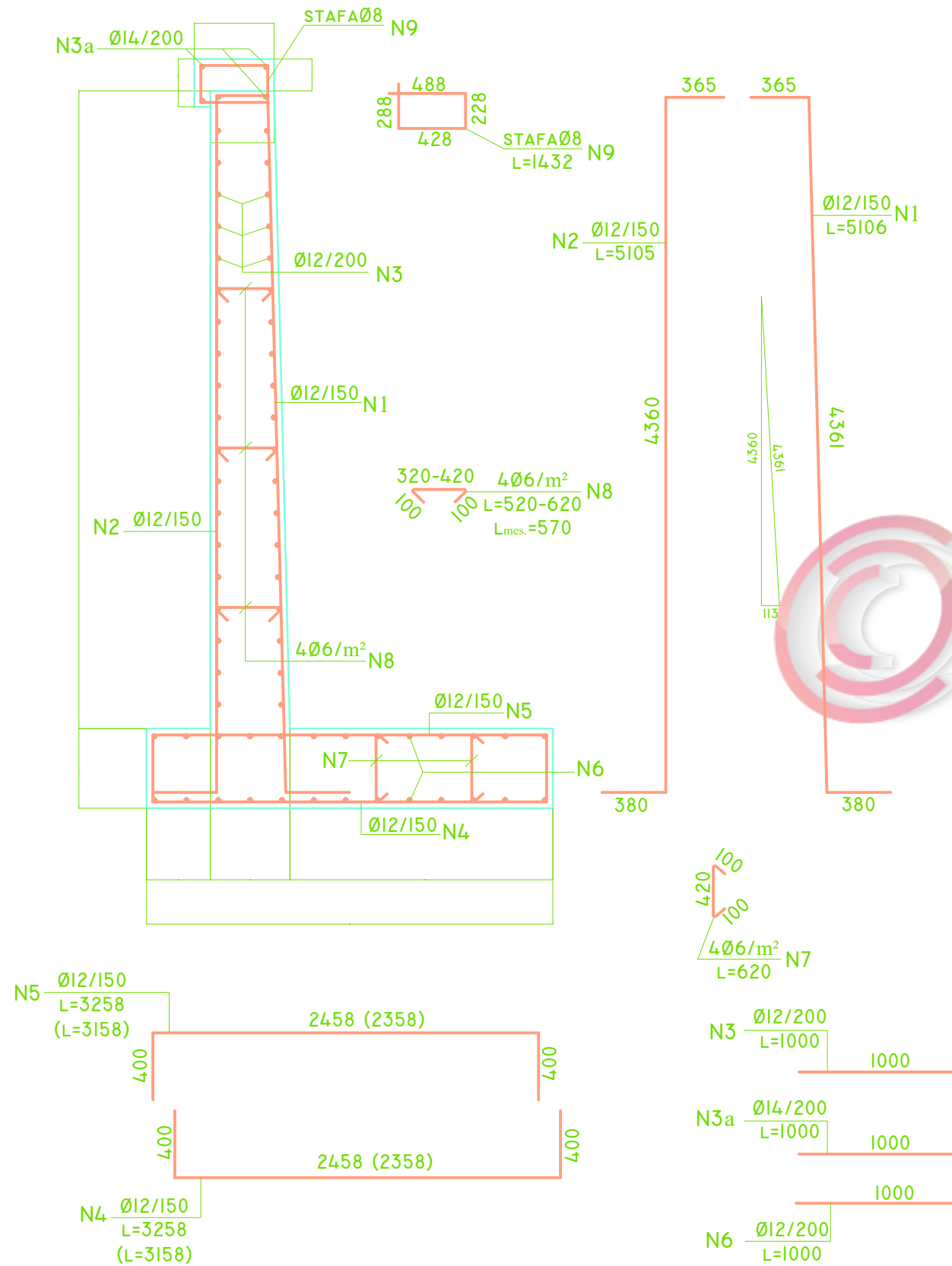

**TABELA E HEKURAVE**  
 PER H=5M,  $[\sigma]_t=2\text{kg/cm}^2$

NR.	Ø mm	L mm	SASIA cope	L m	PERMBLEDHJE E ARMATURES.				
					Ø mm	ΣL m	PESHA kg/ml	PESHA kg	
1	16	6257	7	43.80	6	21.95	0.222	4.87	
2	12	6255	7	43.79	8	7.16	0.395	2.83	
3	12	1000	50	50.00	12	131.79	0.888	117.03	
3a	14	1000	3	3.00	14	3.00	1.208	3.62	
4	16	4458	7	31.21	16	106.22	1.578	167.62	
5	16	4458	7	31.21					
6	12	1000	38	38.00					
7	6	670	15	10.05					
8	6	595	20	11.90					
9	8	1432	5	7.16					
<b>SHUMA</b>							<b>kg/ml</b>	<b>295.97</b>	
<b>BETON Rck=300kg/cm²</b>							<b>m³/ml</b>	<b>4.49</b>	



**POROSITESI : BASHKIA VORË**  
 OBJEKTI:  
 "RIKONSTRUKSION I RRUGEVE MUCAJ, SHERAJ DHE E VESLEVE FSHATI MUCAJ, BASHKIA VORE "

Emertimi: DETAJE TE RRUGES  
  
**"ARABEL - STUDIO" Sh.p.k**  
 Adresa: Njesia Bashkiake nr.7, Rruga "Frosina Plaku",  
 Pallati 21, Hyrja 1, Kati 2, Tirane.  
 Email: arabelstudio@gmail.com

Drejtues i projektit		Projektues	
Adm. Ana NISHKU		Nd. Ardi ARKAXHIU	Elek. Altin ALLKAJ
Inxh. Ardi ARKAXHIU		Ark.Rigert HYRA	Top. Mustafa HOXHAJ
		Gjeo.Irfan BEGAJ	Hid. Hajredin MURGU

SHKALLA	FLETA
1 : 50	12- 03
Vorë 2019	Format A3



# MURE MASIV TIP BETONI C25/30

Sh-1:50

MURE BETONI (RRETHUESE) H=1.35m

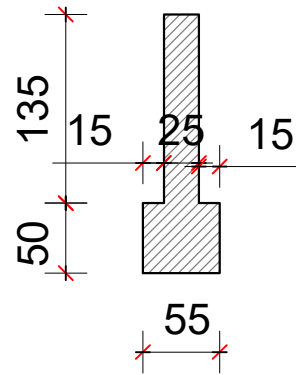

MURE BETONI H=0.5m

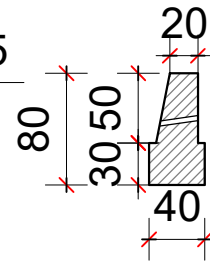

MURE BETONI H=0.8m

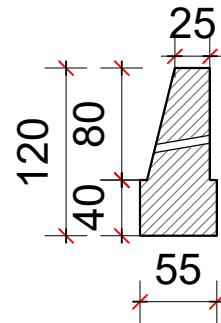

MURE BETONI H=1.0m

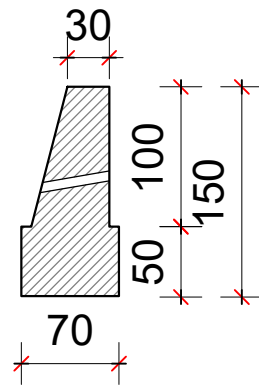

MURE BETONI H=1.5m

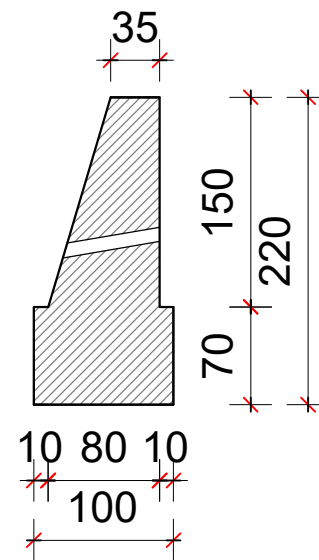

MURE BETONI H=2.0m

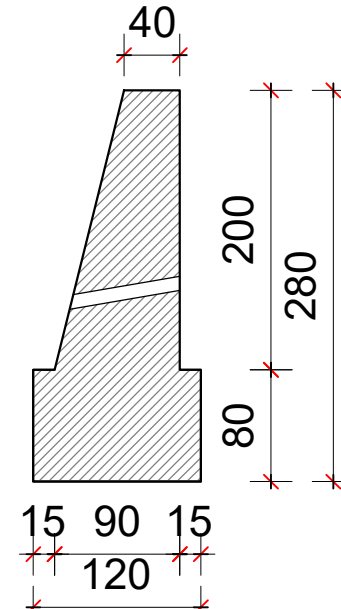

MURE BETONI H=2.5m

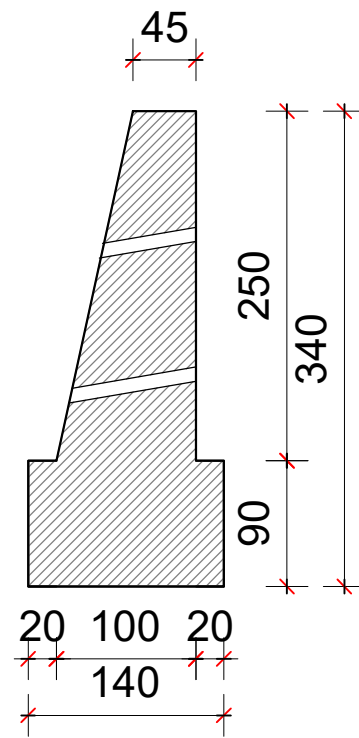

MURE BETONI H=2.7m

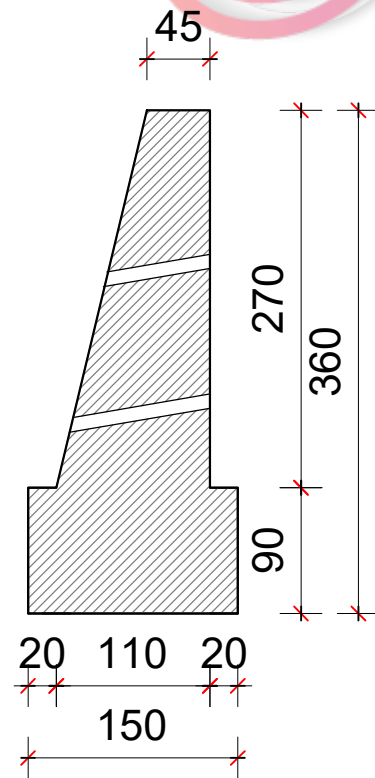

MURE BETONI H=3.0m

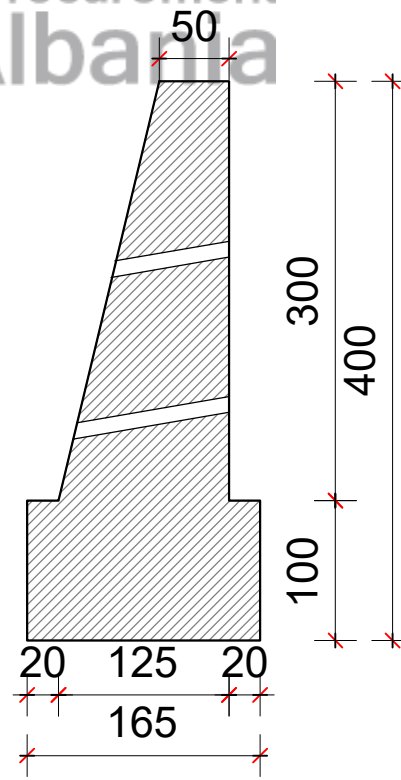

MURE BETONI H=4.0m

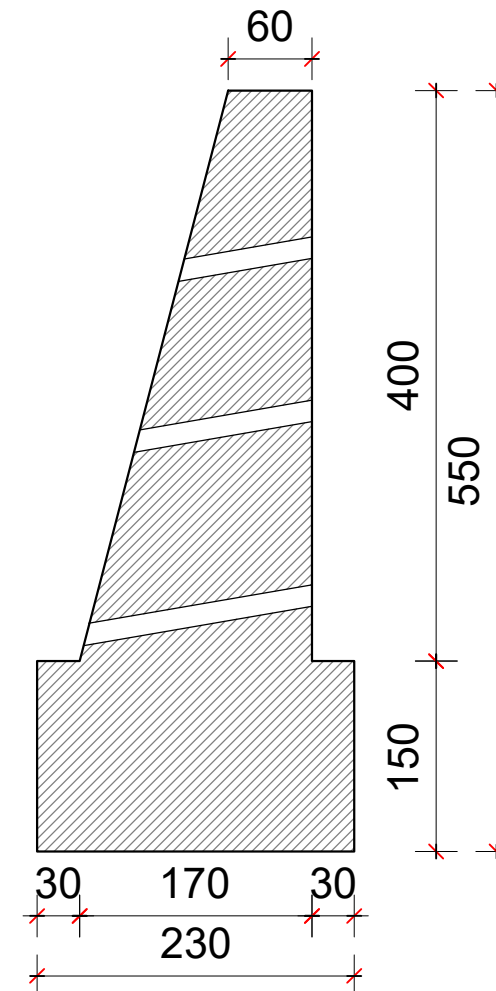

**POROSITESI : BASHKIA VORË**  
 OBJEKTI:  
 "RIKONSTRUKSION I RRUGEVE MUCAJ, SHERAJ DHE E VESLEVE FSHATI MUCAJ , BASHKIA VORE "

Emertimi: DETAJE TE RRUGES  
 "ARABEL - STUDIO" Sh.p.k  
 Adresa: Njesia Bashkiake nr.7, Rruga "Frosina Plaku", Pallati 21, Hyrja 1, Kati 2, Tirane.  
 Email: arabelstudio@gmail.com

Drejtues i projektit		Projektues	
Adm. Ana NISHKU		Nd. Ardi ARKAXHIU	Elek. Altin ALLKAJ
Inxh. Ardi ARKAXHIU		Ark.Rigert HYRA	Top. Mustafa HOXHAI
		Gjeo.Irfan BEGAJ	Hid. Hajredin MURGU

SHKALLA	FLETA
1 : 50	12-04
Vorë 2019	Format A3

# PUSETE KONTROLLI PER UJRAT E SHIUT

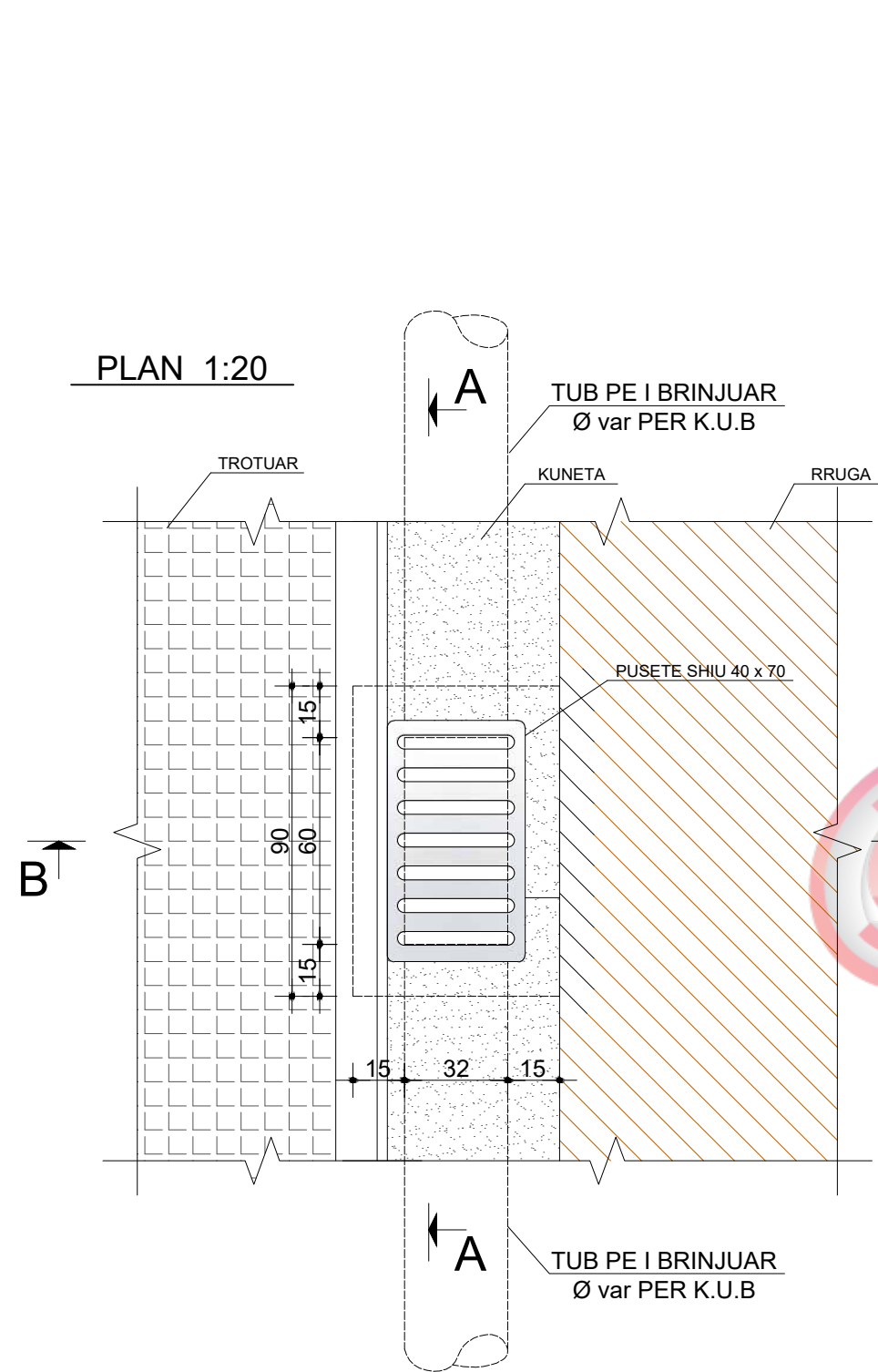

**PRERJE A-A 1:25**

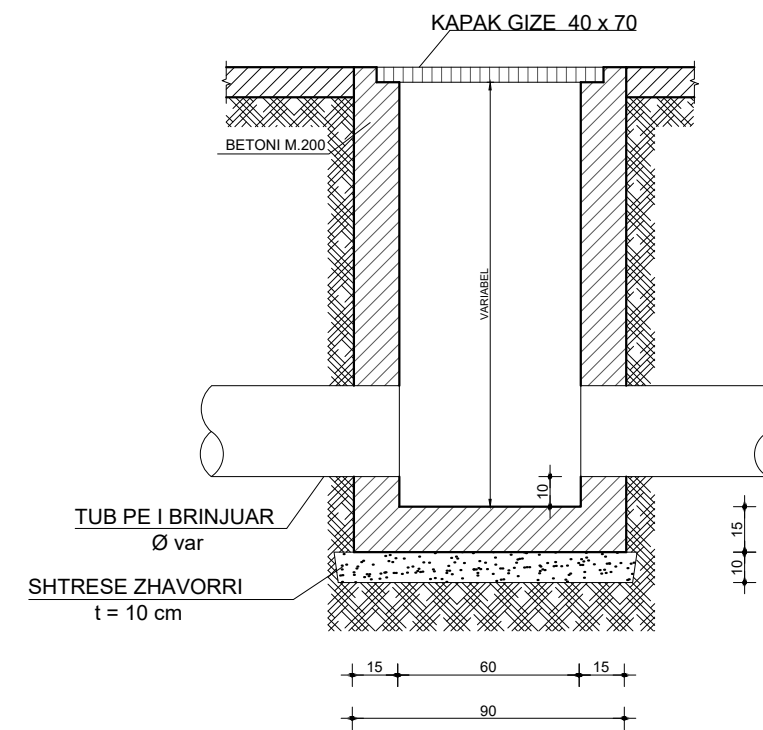

**PRERJE B-B 1:25  
(PER TUBA PE D=315mm)**

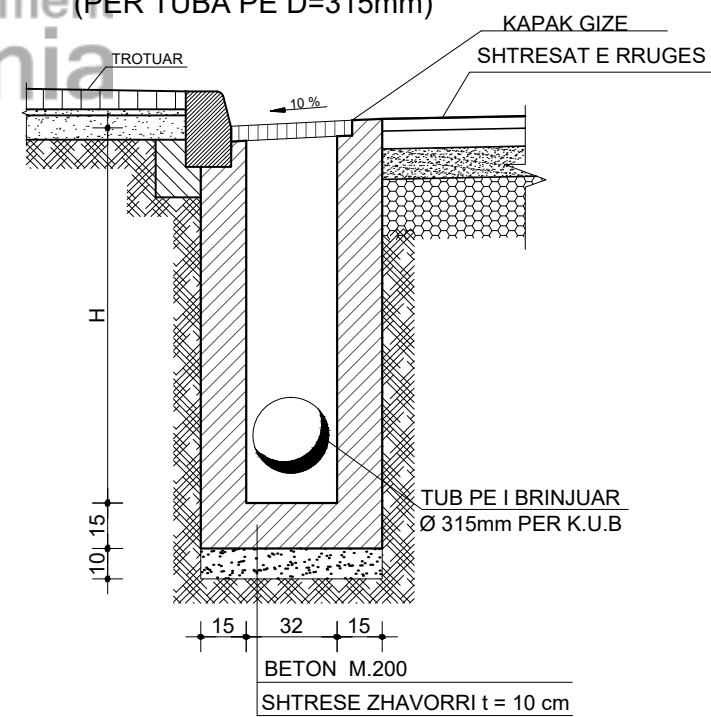

\*Dimensionet ne cm



POROSITESI : BASHKIA VORE

OBJEKTI:  
"RIKONSTRUKSION I RRUGEVE MUCAJ, SHERAJ DHE E VESLEVE  
FSHATI MUCAJ, BASHKIA VORE "

Emertimi: DETAJ PUSETA SHIMBLEDHES



"ARABEL - STUDIO" Sh.  
Adresa: Njesia Bashkiake nr.7, Rruga "Frosina Plaku",  
Pallati 21, Hyrja 1, Kati 2, Tirane.  
Email: arabelstudio@gmail.com

Drejtesues i projektit

Adm. Ana NISHKU  
Inxh. Ardi ARKAXHIU

Projektues

Nd. Ardi ARKAXHIU  
Ark.Rigert HYRA  
Gieo.Irfan BEGAJ  
Elek. Altin ALLKAJ  
Top. Mustafa HOXHAIJ  
Hid. Hajredin MURGU

SHKALLA

SH 1-50

VORE 2018

FLETA

2- 06

Format A3

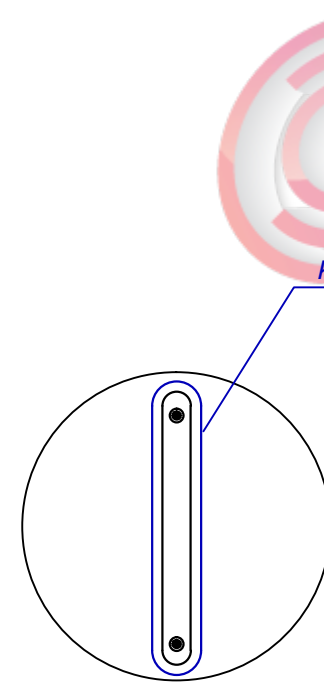
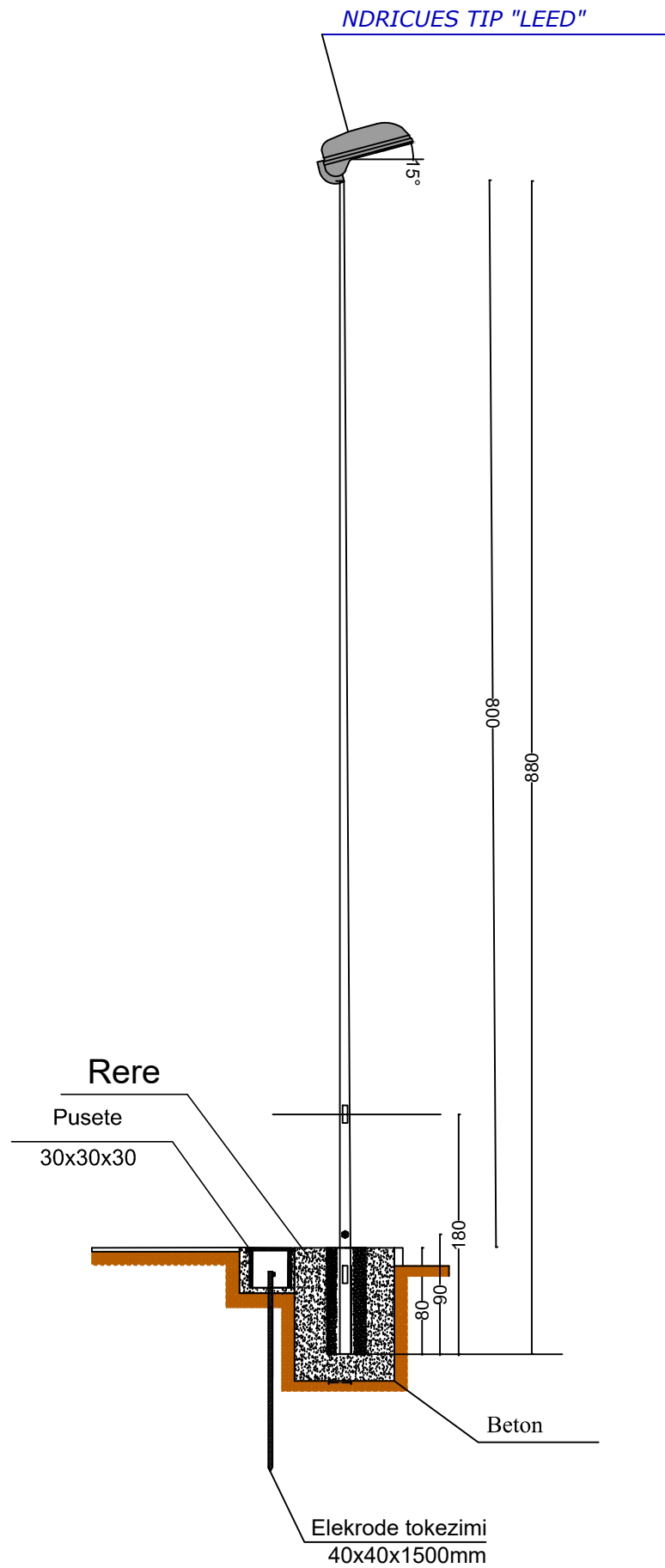

**Open**  
Procurement  
Albania

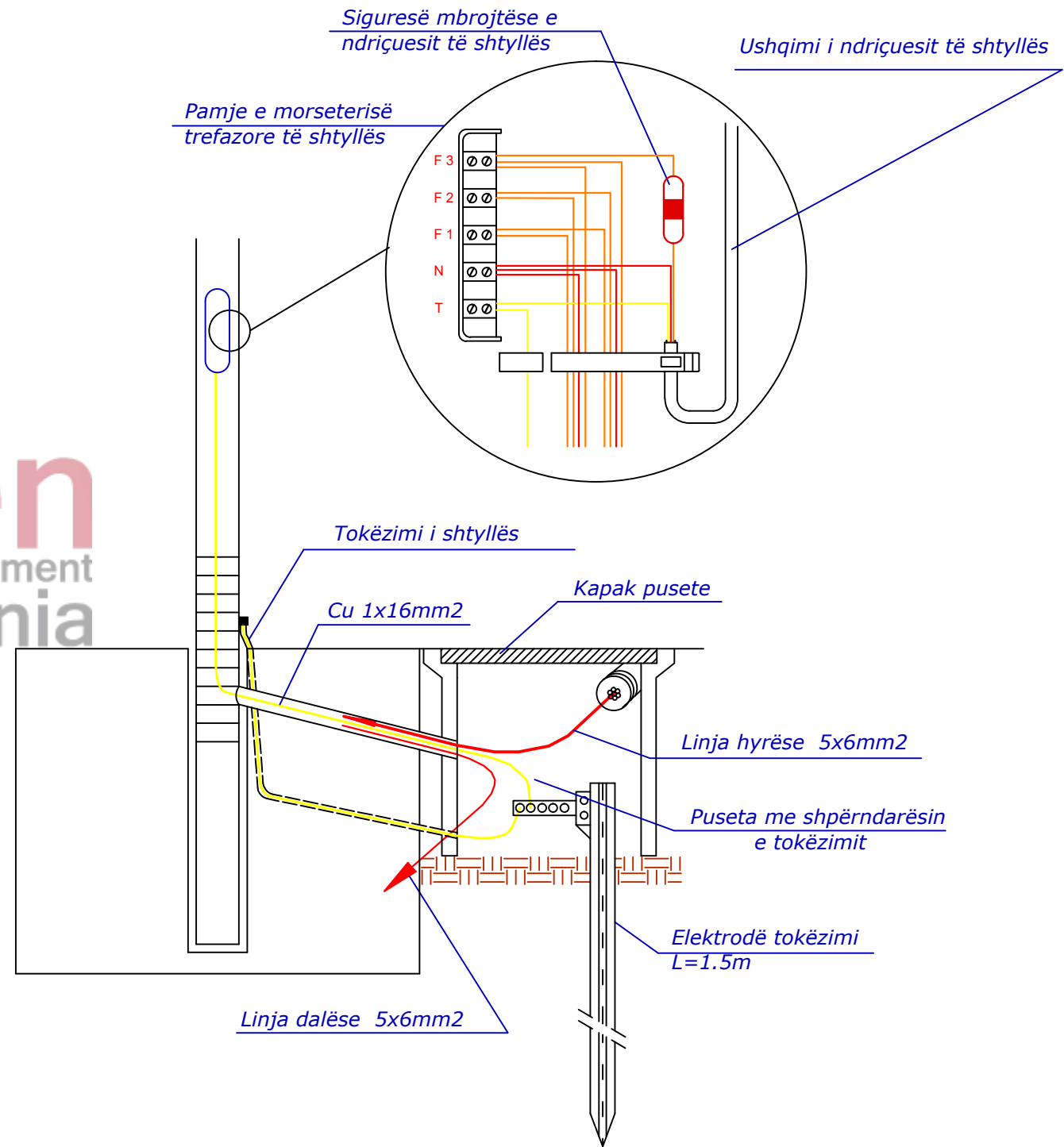

**POROSITESI : BASHKIA VORE**  
OBJEKTI:  
"RIKONSTRUKSION I RRUGEVE MUCAJ, SHERAJ DHE E VESLEVE FSHATI MUCAJ ,BASHKIA VORE "

Emertimi: DETAJE ELEKTRIKE  
"ARABEL – STUDIO" Sh.p.k.  
Adresa: Njesia Bashkiake nr.7, Rruga "Frosina Plaku", Pallati 21, Hyrja 1, Kati 2, Tirane.  
Email: arabelstudio@gmail.com

**Drejtues i projektit**  
Dok. Ana NISHKU  
Inxh. Ardi ARKAXHIU

**Projektues**  
Nd. Ardi ARKAXHIU  
Ark. Rigert HYRA  
Gjeo. Irfan BEGAJ  
Elek. Altin ALLKAJ  
Top. Mustafa HOXHAI  
Hid. Hajredin MURGU

**SHKALLA**  
SH 1-50  
VORE 2018  
**FLETA**  
2- 09  
Format A3

Prerje e kapakut prej gize

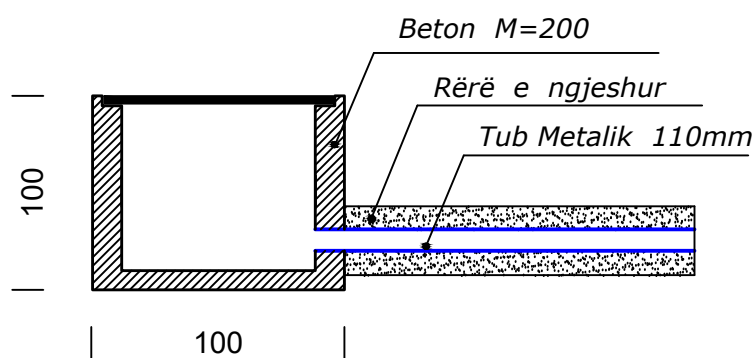

Prerje e vendosjes së pusetave

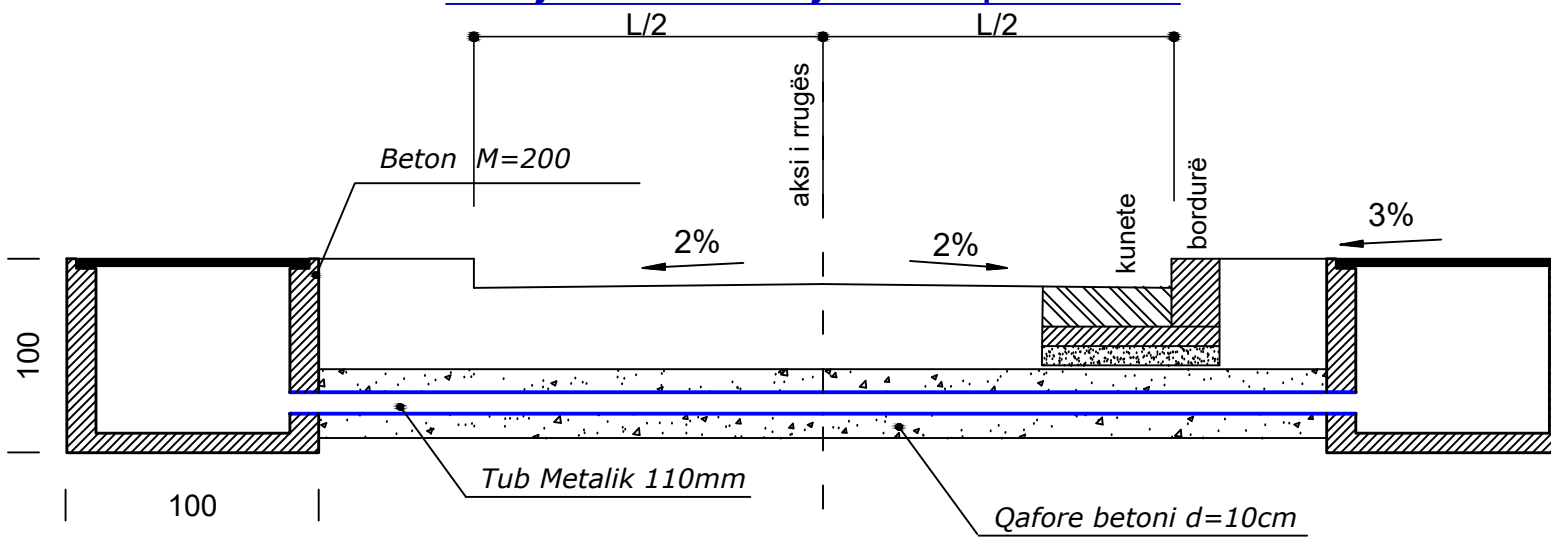

Kapaku i pusetës prej gize

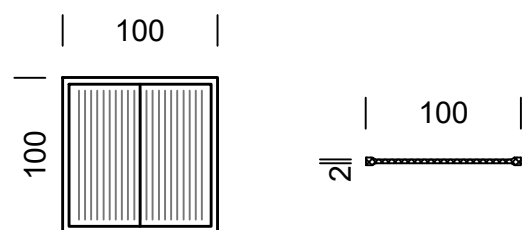

DETAJ I PUSITES 0.5X0.5m PER LINJAT E NDRICIMIT

Kapaku i pusetës prej plastike

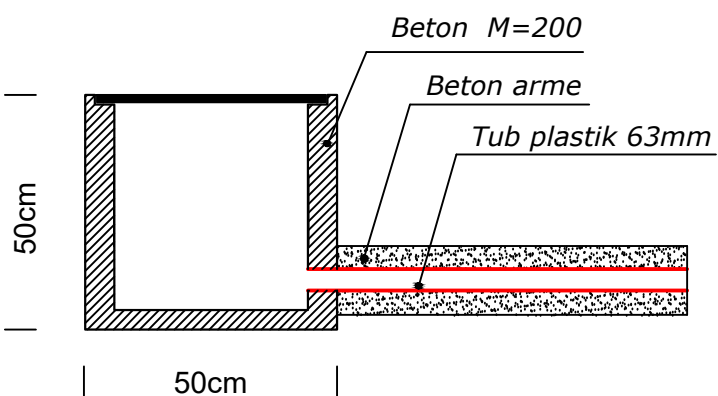

Prerje e vendosjes së pusetave

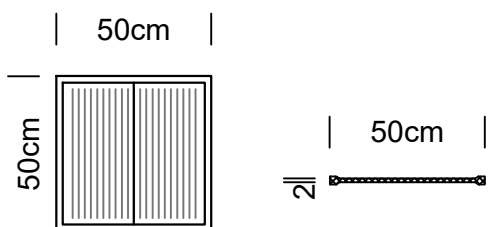
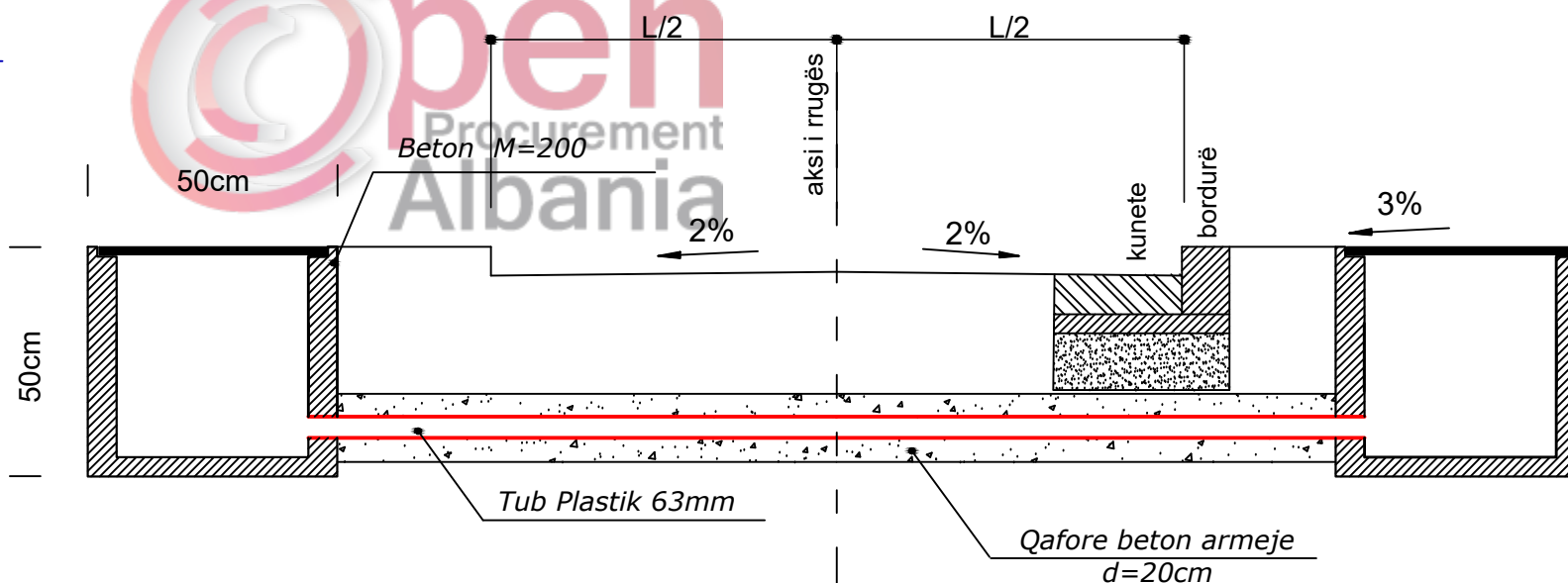

Kapaku i pusetës prej plastike

SHËNIME :

- Gjatë realizimit të intersektimeve kuota e vendosjes së pusetave mund të ndryshojë sipas rastit
- Tubi mund të vendoset me një pjerrësi të lehtë sipas nevojës , por gjithnjë thellësia minimale e vendosjes duhet te jete 50cm nga sip. e asfaltit.



POROSITESI : BASHKIA VORE

OBJEKTI:  
"RIKONSTRUKSION I RRUGEVE MUCAJ, SHERAJ DHE E VESLEVE FSHATI MUCAJ ,BASHKIA VORE "

Emertimi: DETAJE ELEKTRIKE



"ARABEL - STUDIO" Sh.  
Adresa: Njesia Bashkiake nr.7, Rruga "Frosina Plaku",  
Pallati 21, Hyrja 1, Kati 2, Tirane.  
Email: arabelstudio@gmail.com

Drejtes i projektit

Dktm. Ana NISHKU  
Inxh. Ardi ARKAXHIU

Projektues

Nd. Ardi ARKAXHIU  
Ark.Rigert HYRA  
Gjeo.Irfan BEGAJ  
Elek. Altin ALLKAJ  
Top. Mustafa HOXHAI  
Hid. Hajredin MURGU

SHKALLA

SH 1-50  
VORE 2018

FLETA

2- 10  
Format A3

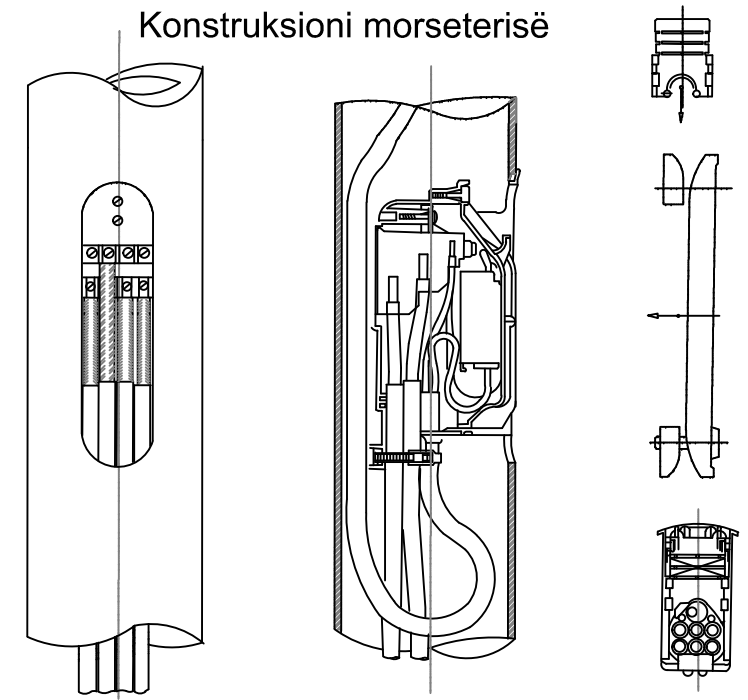
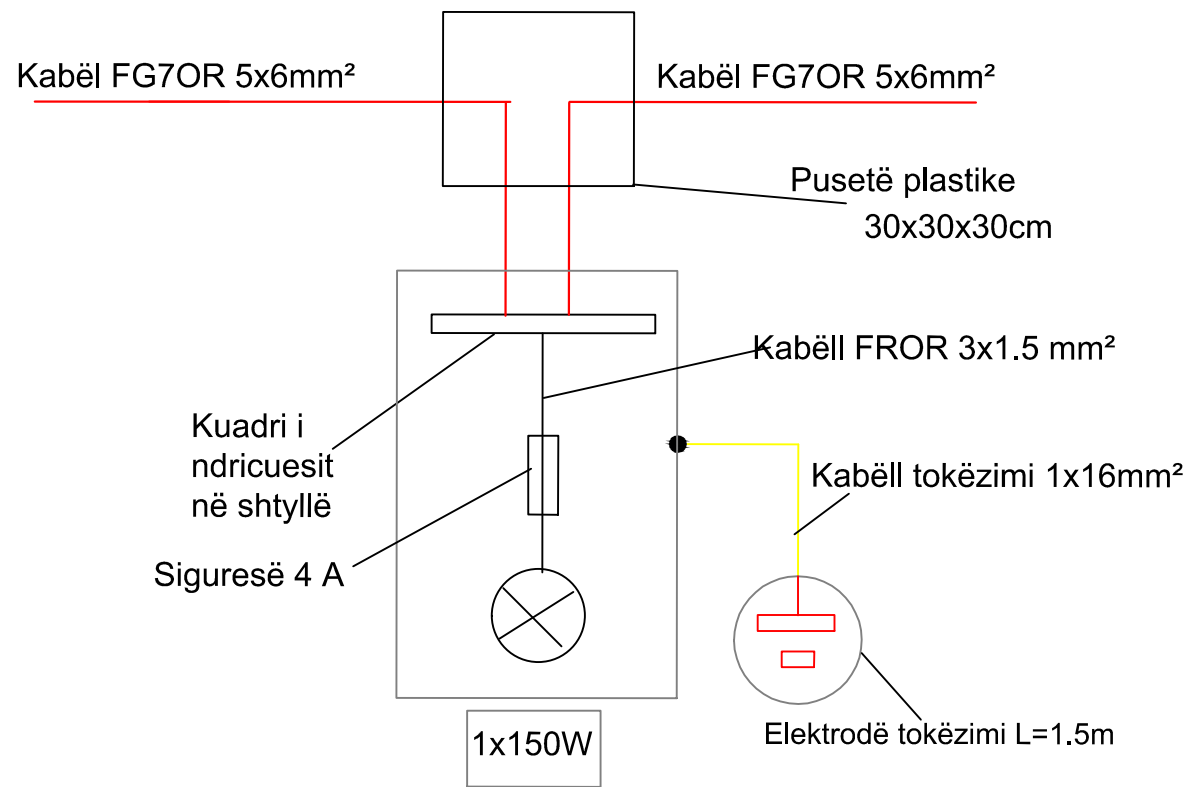

### Detaj i tokëzimit të shtyllës së ndriçimit

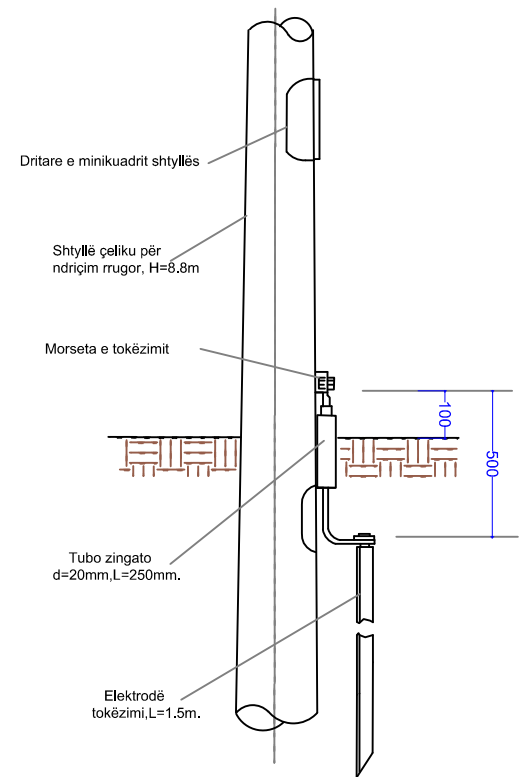

### Hollësi e inkastrimit të kolonës së ndriçuesit me lartësi H=8.0m

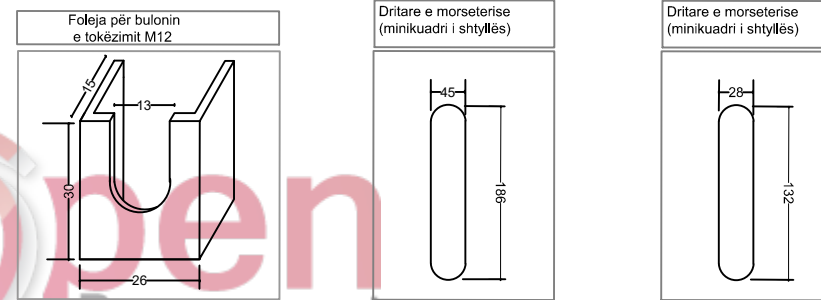
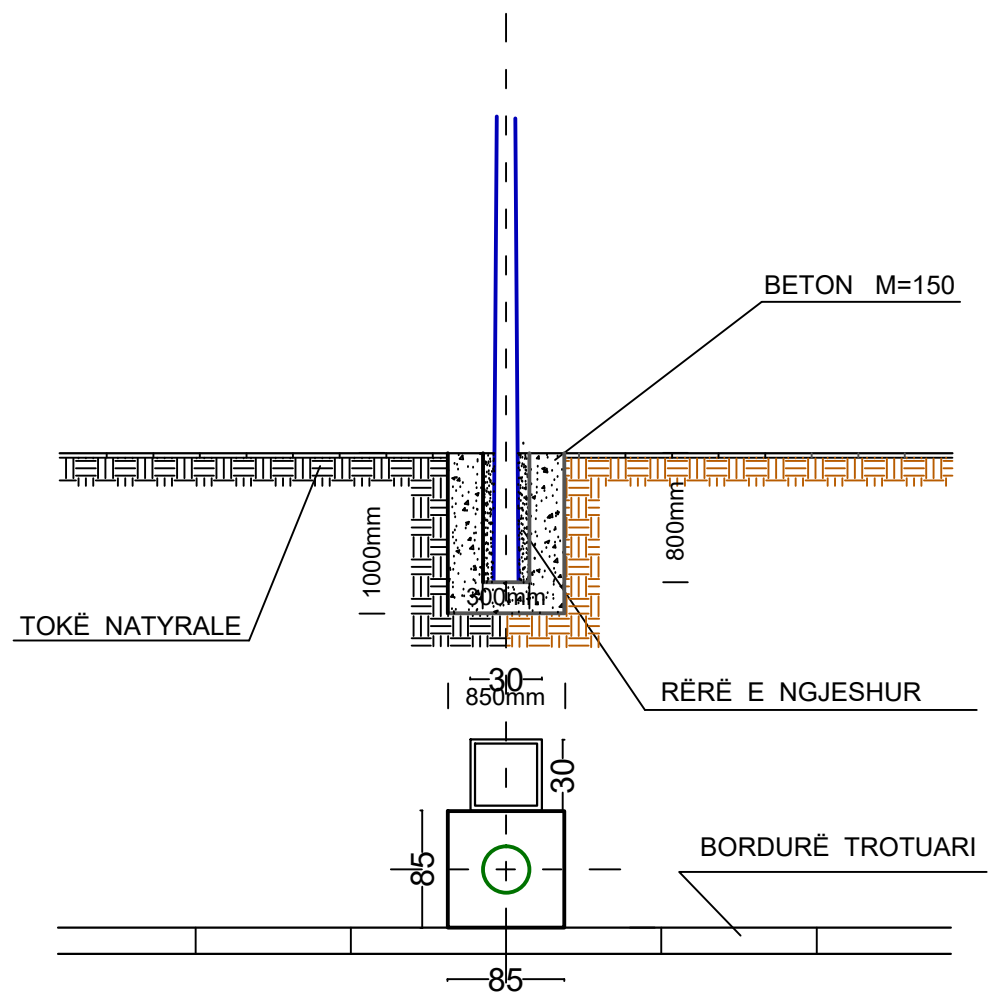

### Hollësi e vendosjes së pusetës

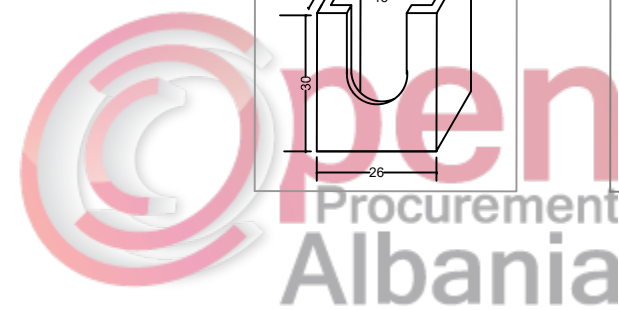
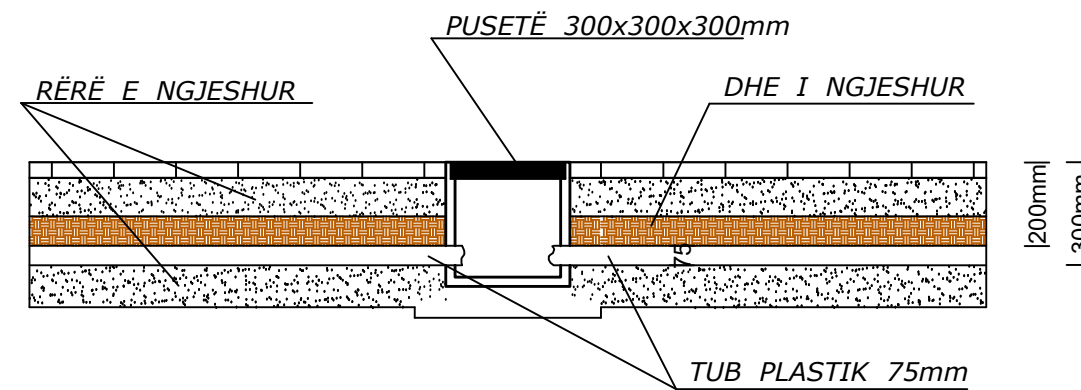

**POROSITESI : BASHKIA VORE**  
**OBJEKTI:**  
 "RIKONSTRUKSION I RRUGEVE MUCAJ, SHERAJ DHE E VESLEVE FSHATI MUCAJ, BASHKIA VORE"

**Emertimi: DETAJE ELEKTRIKE**  
**"ARABEL - STUDIO" Sh.p.k.**  
 Adresa: Njesia Bashkiake nr.7, Rruga "Frosina Plaku", Pallati 21, Hyrja 1, Kati 2, Tirane.  
 Email: arabelstudio@gmail.com

**Drejtes i projektit**  
 Ark. Ana NISHKU  
 Inxh. Ardi ARKAXHIU

**Projektues**

Nd. Ardi ARKAXHIU	Elek. Altin ALLKAJ
Ark. Rigert HYRA	Top. Mustafa HOXHAI
Gjeo. Irfan BEGAJ	Hid. Hajredin MURGU

**SHKALLA** SH 1-50  
**FLETA** 2- 11  
**VORE 2018** Format A3

### Planimetria e instalimit të rrjetit kabllor të ndriçimit,

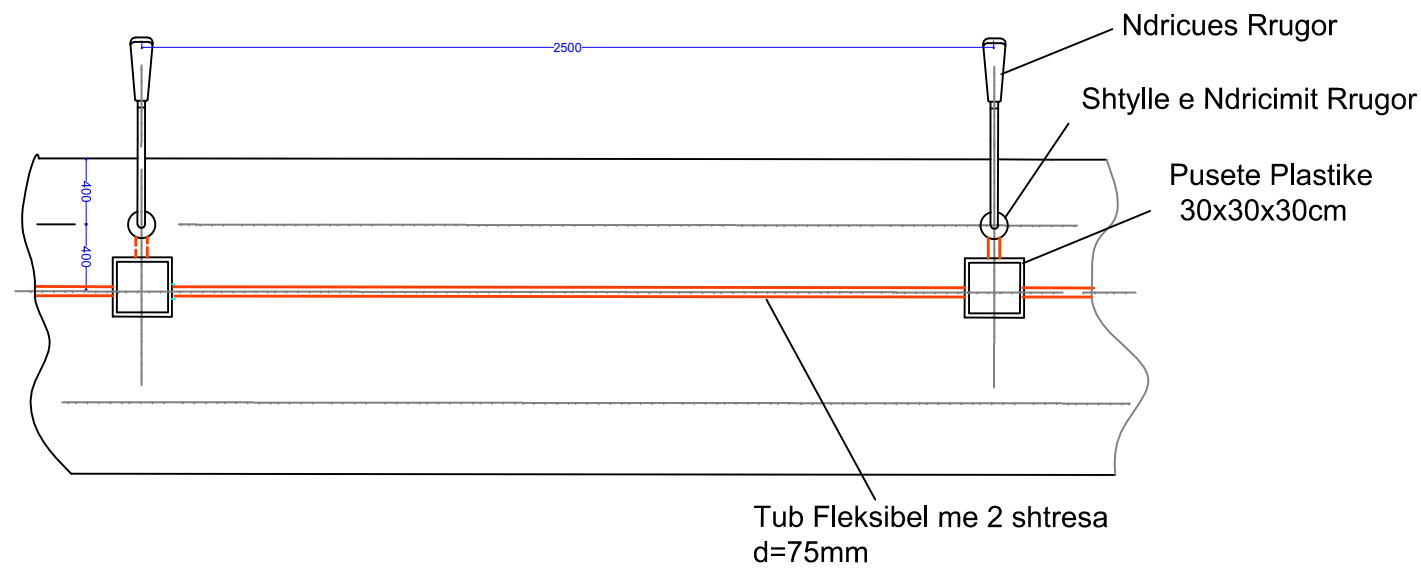

### Shtrimi i kablove te TU ne TP.direkt ne toke

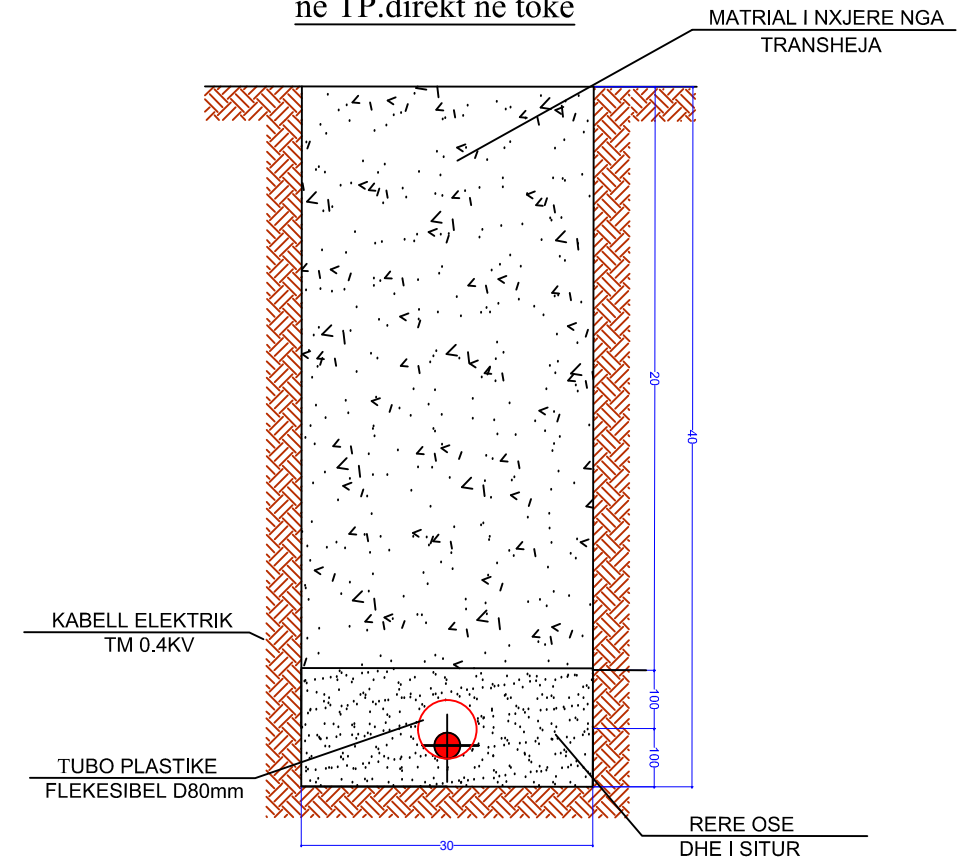

### Detaj i montimit te pusetes dhe tokezimit te shtylles

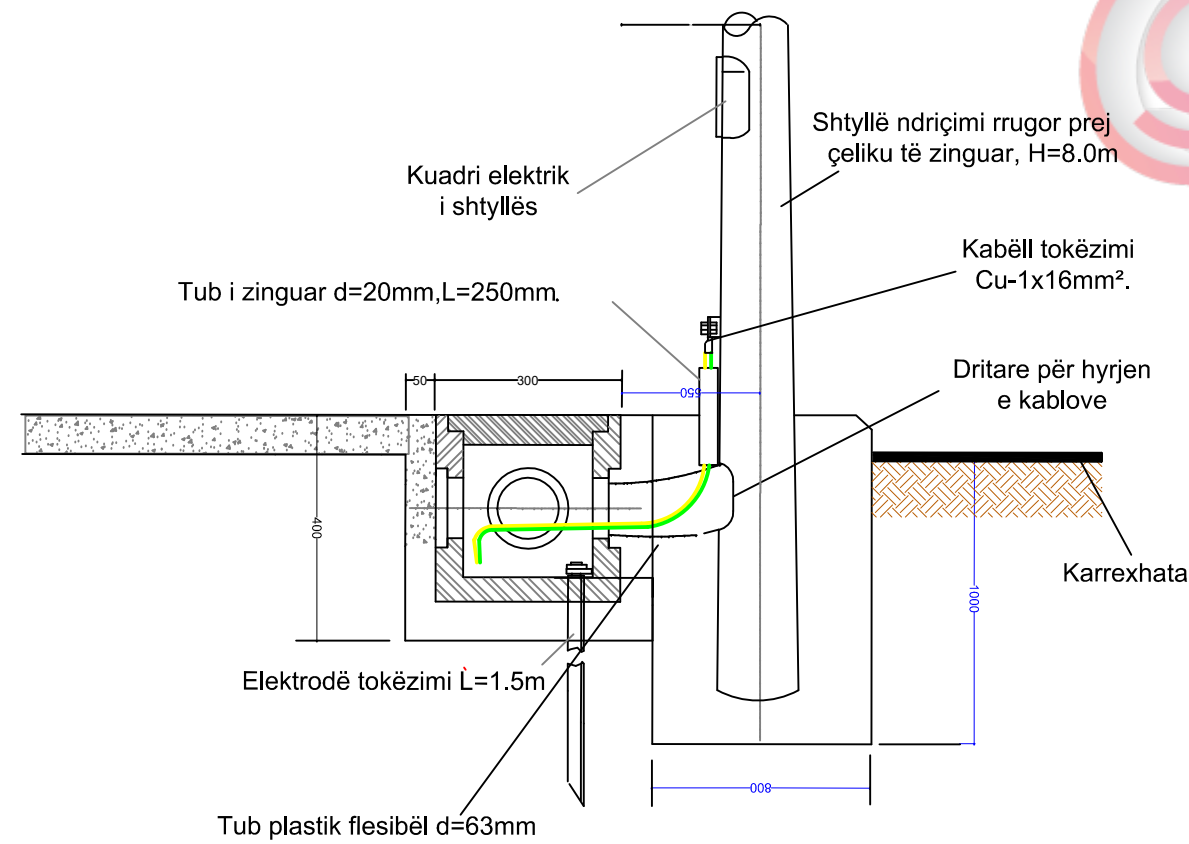

### Shtrimi i kablove te TU ne trasversimin e rrugeve

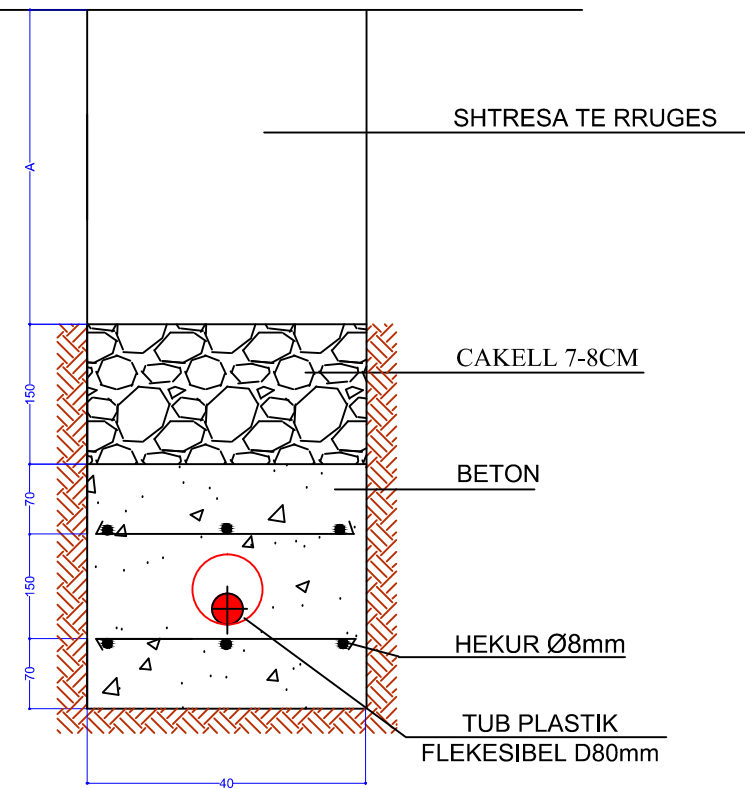

POROSITESI : BASHKIA VORE

OBJEKTI:  
"RIKONSTRUKSION I RRUGEVE MUCAJ,SHERAJ DHE E VESLEVE FSHATI MUCAJ ,BASHKIA VORE "

Emertimi: DETAJE ELEKTRIKE



"ARABEL - STUDIO" Sh.p.k.  
Adresa:Njesia Bashkiake nr.7, Rruga "Frosina Plaku",  
Pallati 21, Hyrja 1, Kati 2,Tirane.  
Email: arabelstudio@gmail.com

Drejtues i projektit

Dok. Ana NISHKU  
Inxh. Ardi ARKAXHIU

Projektues

Nd. Ardi ARKAXHIU	Elek. Altin ALLKAJ
Ark.Rigert HYRA	Top. Mustafa HOXHAJ
Gjeo.Irfan BEGAJ	Hid. Hajredin MURGU

SHKALLA

SH 1-50

VORE 2018

FLETA

2- 12

Format A3

# DETAJI PANDUSIT

PRERJA A-A SHK.1:50

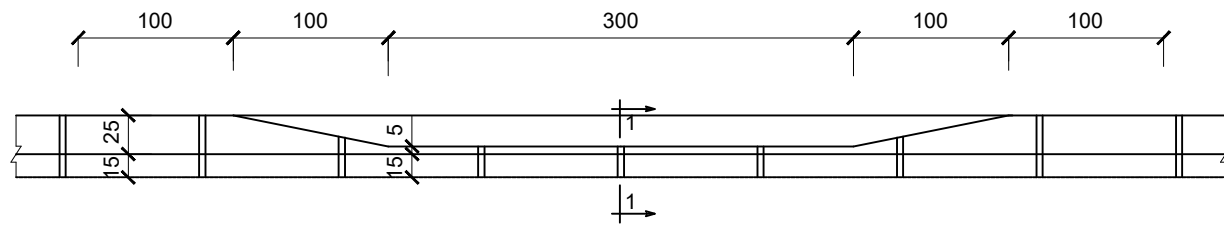

PLAN SHK.1:50

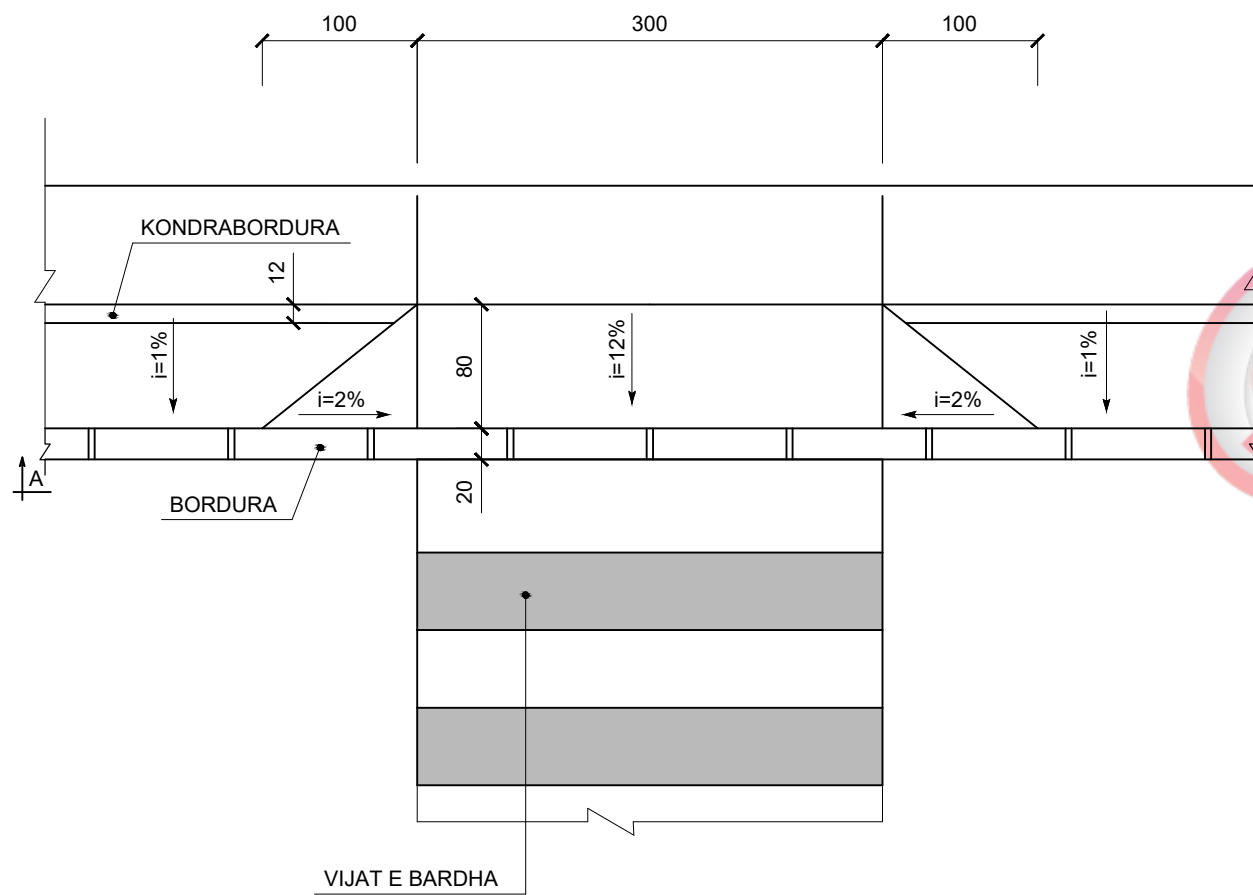

DETAJI I PRERJES SE RRUGES ME PANDUS SH 1:15

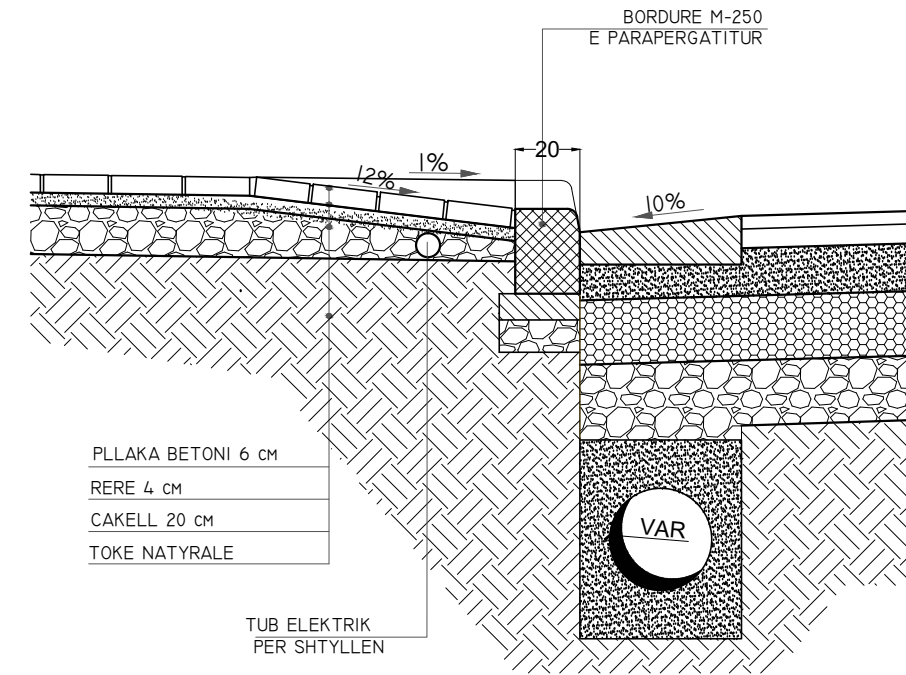

Detaji i Bordurës dhe kunetes Sh 1:15

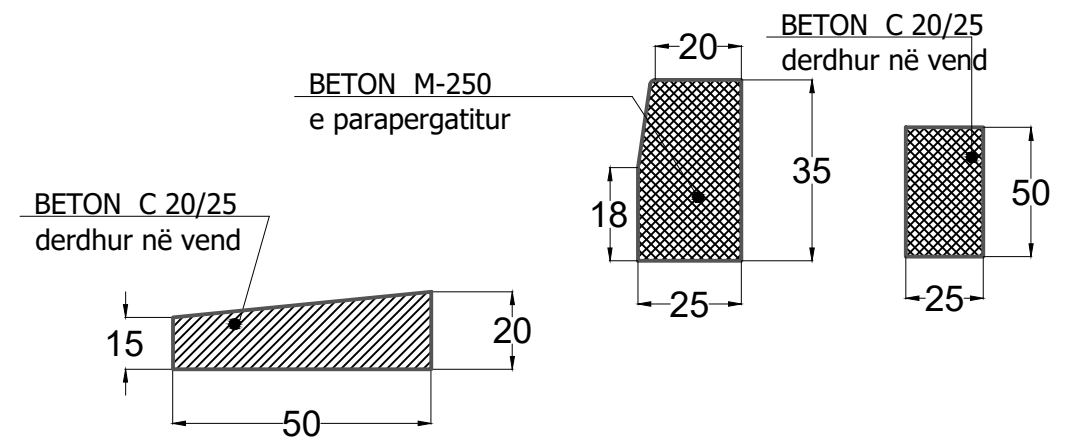

Shënim:  
NE CDO PIKE KU KRYQEZOHET RRUGA KRYESORE ME RRUGET DYTESORE DO TE VENDOSEN PANDUSET E TROTUAREVE

\*Dimensionet ne cm

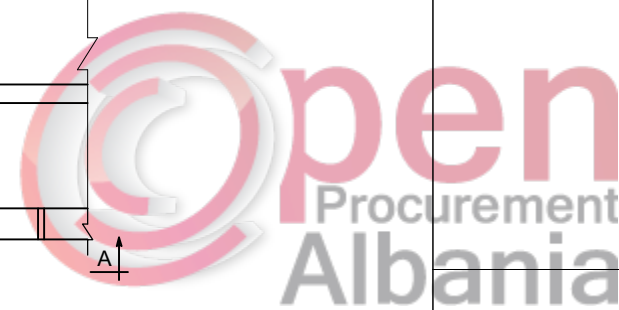

POROSITESI : BASHKIA VORE

OBJEKTI:  
"RIKONSTRUKSION I RRUGEVE MUCAJ, SHERAJ DHE E VESLEVE  
FSHATI MUCAJ ,BASHKIA VORE "

Emertimi: DETAJE TROTUARI



"ARABEL - STUDIO" Sh.  
Adresa: Njesia Bashkiake nr.7, Rruga "Frosina Plaku",  
Pallati 21, Hyrja 1, Kati 2, Tirane.  
Email: arabelstudio@gmail.com

Drejtues i projektit

Ark. Ana NISHKU  
Inxh. Ardi ARKAXHIU

Projektues

Nd. Ardi ARKAXHIU  
Ark. Rigert HYRA  
Gjeo. Irfan BEGAJ  
Elek. Altin ALLKAJ  
Top. Mustafa HOXHAI  
Hid. Hajredin MURGU

SHKALLA

SH 1-50

VORE 2018

FLETA

2- 13

Format A3

## SHENJA LAJMERUESE WARNING SIGN

LAJMERIM PER NDERPRERJE NGA RRUGE DYTESORE, KTHESAT E KURBEZUARA,  
FEMIJET, KEMBESORET DHE PER NDALJE/DHENIE RRUGE  
WARNING SIGN INTERSECTION OF SECONDARY ROAD, WARNING SIGN CURVE,  
WARNING SIGN PEDESTRAIN & CHILDREN'S, STOP & GIVE WAY SIGN

TREKENDESHI: E KUQE REFLEKTUESE  
SFONDI: I ZI  
SIMBOLI: E BARDHE REFLEKTUESE

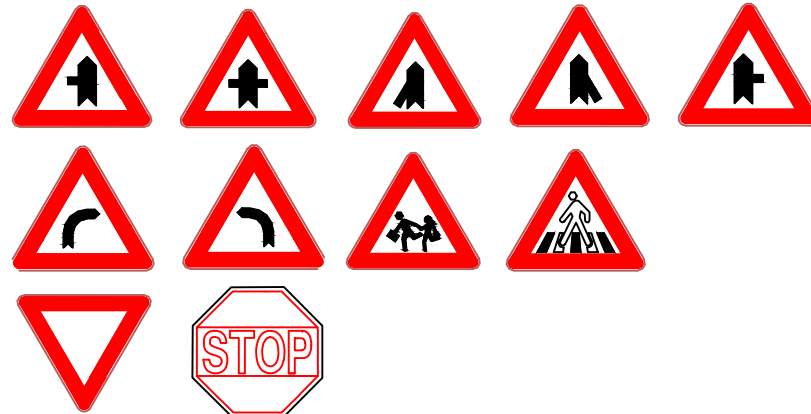

TRIANGLE: RED REFLECTIVE  
BACKGROUND: WHITE REFLECTIVE  
SYMBOL: BLACK

## SHENJA NDALUESE PROHIBIT SIGN

SHENJAT PER KUFIRIN E SHPEJTESISË DHE NDALIM PARAKALIMIN  
SPEED LIMIT SIGN & OVERTAKE PROHIBIT

RRETHI: E KUQE REFLEKTUESE  
SHENJA: E ZEZE REFLEKTUESE  
CIRCLE: RED REFLECTIVE  
SIGN: BLACK REFLECTIVE



## SHENJA DETYRUESE OBLIGATORY SIGN

ANET & SHIGJETAT: E BARDHE REFLEKTUESE  
SFONDI: BLU REFLEKTUESE KL 2

EDGE & ARROW: WHITE REFLECTIVE  
BACKGROUND: BLUE REFLECTIVE CL 2

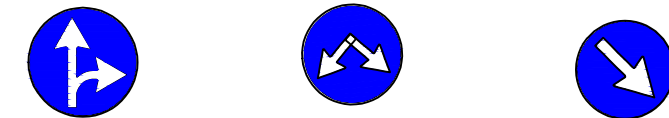

## SHENJA PLOTESUESE COMPLEMENTARY SIGN

SHENJA E KTHESES NE NJE DREJTIM & DY DREJTIME  
CHEVRON SIGNS ONE DIRECTION & TWO DIRECTION

SHENJA : E BARDHE REFLEKTUESE  
SFONDI: E ZEZE  
SIGN : WHITE REFLECTIVE  
BACKGROUND: BLACK



## SHENJA INFORMUESE INFORMATION SIGN

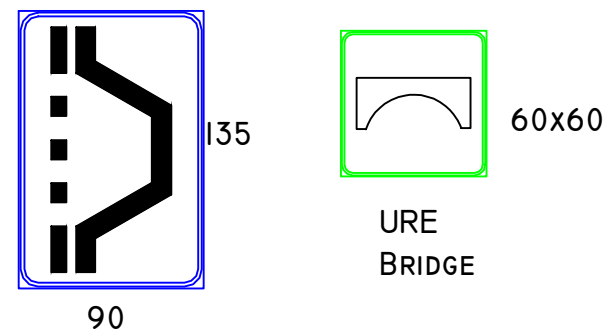

SHENIM: SHENJAT RRUGORE PER NGA FORMA, MADHESIA, NGJYRA REFLEKTIVITETI DUHET TE JENE SIPAS KODIT RRUGOR TE REPUBLIKES SE SHQIPERISE  
MATERIALI PRAPAREFLEKTIV DUHET TE KETE JETEGJATESI 10VJET PER CLASIN 2 DHE 7 VJET PER CLASIN I  
SIMBOLI BRENDA SHENJES RRUGORE DUHET TE JETE I REALIZUAR ME BOJE TE TRAJTUAR ME PJEKJE E CILA NUK HUMBET TREGUESIT PRAPAREFLEKTIV  
SHENJA RRUGORE REALIZOHET ME LLAMARINE ÇELIKU E CILA LYHET ME BOJE OPAKE KUNDRANDRA KOROZIONITDHE TRAJTOHET ME PJEKJE.



POROSITESI : BASHKIA VORE

OBJEKTI:  
"RIKONSTRUKSION I RRUGEVE MUCAJ, SHERAJ DHE E VESLEVE  
FSHATI MUCAJ ,BASHKIA VORE "

Emertimi: DETAJE SINJALISTIKE



"ARABEL – STUDIO" Sh.p.k.  
Adresa: Njesia Bashkiake nr.7, Rruga "Frosina Plaku",  
Pallati 21, Hyrja 1, Kati 2, Tirane.  
Email: arabelstudio@gmail.com

Drejtesues i projektit

Dok. Ana NISHKU  
Inxh. Ardi ARKAXHIU

Projektues

Nd. Ardi ARKAXHIU  
Ark.Rigert HYRA  
Gjeo.Irfan BEGAJ  
Elek. Altin ALLKAJ  
Top. Mustafa HOXHAI  
Hid. Hajredin MURGU

SHKALLA

SH 1-50

VORE 2018

FLETA

2- 14

Format A3



# DETAJE TE SINJALISTIKES

## TIPET E VIZIMEVE TE RRUGES ROAD MARKING LINES TYPE

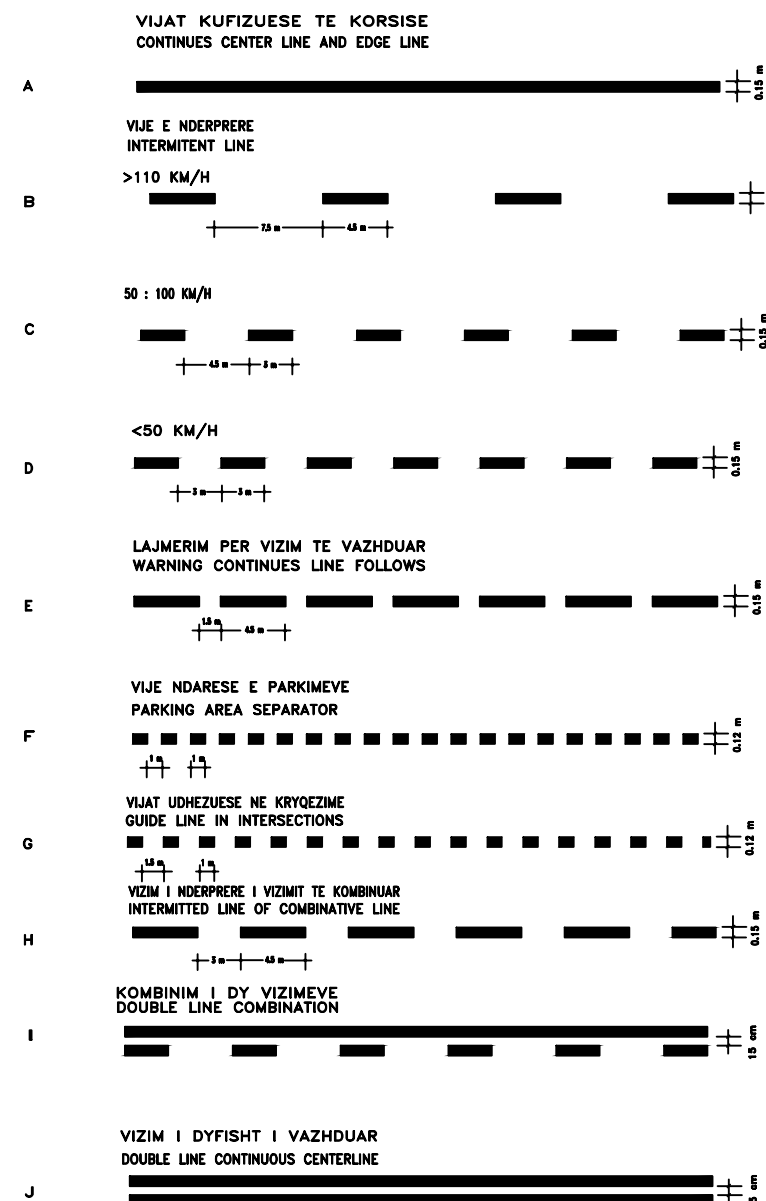

## KALIMET E KEMBESOREVE PEDESTRIANS CROSSING

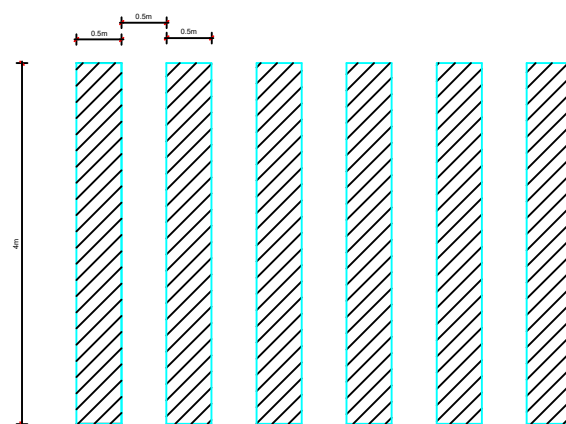

## SHIGJETAT TREGUESE TE RRUGES ROAD MARKING ARROWS

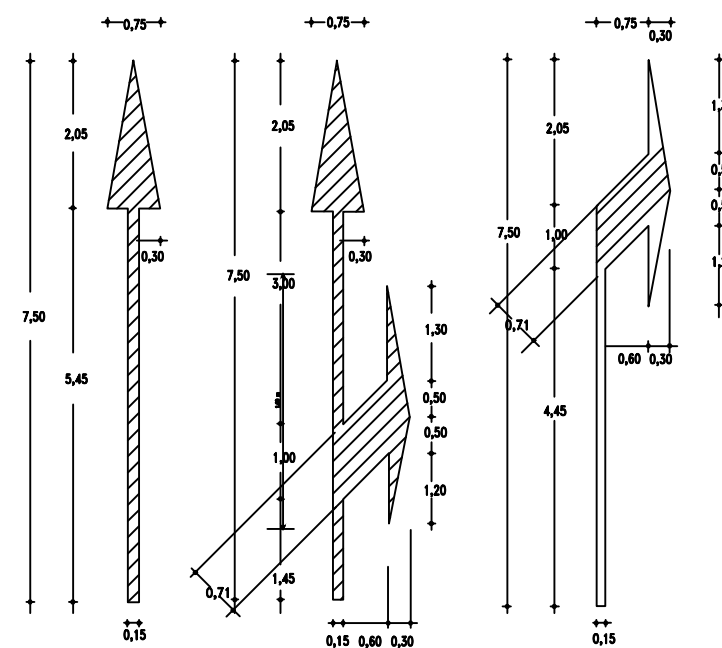

## DHENIE PERPARESIE GIVE WAY ROAD SIGN

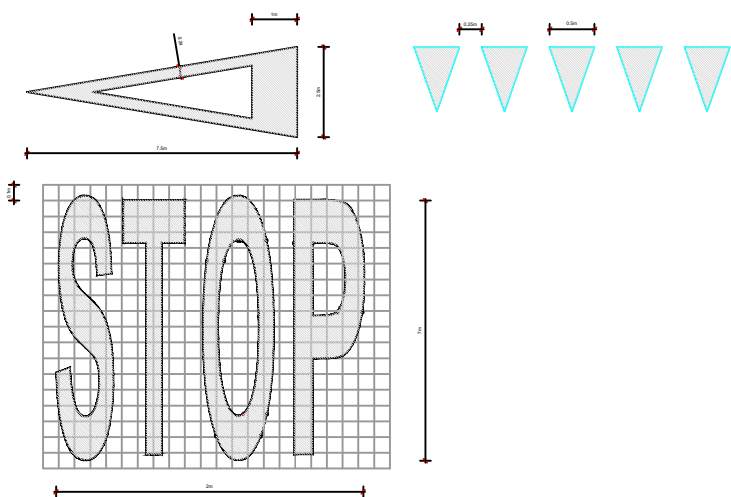

## VIZIMI I RRUGES ROAD PAINTING

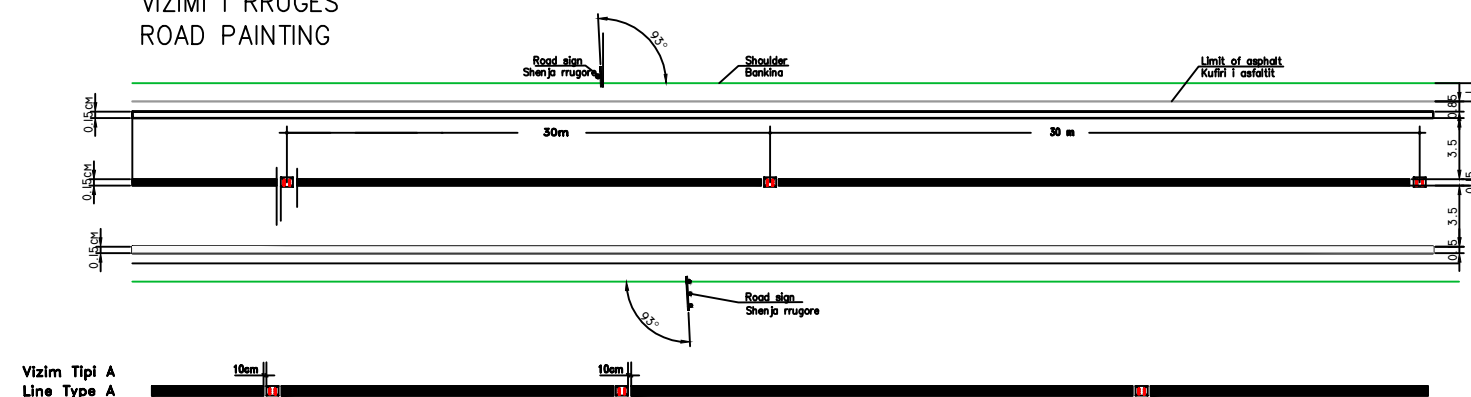

**POROSITESI : BASHKIA VORE**  
OBJEKTI:  
"RIKONSTRUKSION I RRUGEVE MUCAJ, SHERAJ DHE E VESLEVE  
FSHATI MUCAJ ,BASHKIA VORE "

Emertimi: DETAJE SINJALISTIKE  
"ARABEL – STUDIO" Sh.p.k.  
Adresa: Njesia Bashkiake nr.7, Rruga "Frosina Plaku",  
Pallati 21, Hyrja 1, Kati 2, Tirane.  
Email: arabelstudio@gmail.com

Drejtues i projektit  
Dok. Ana NISHKU  
Inxh. Ardi ARKAXHIU

Projektues  
Nd. Ardi ARKAXHIU  
Ark.Rigert HYRA  
Gjeo.Irfan BEGAJ  
Elek. Altin ALLKAJ  
Top. Mustafa HOXHAJ  
Hid. Hajredin MURGU

SHKALLA  
SH 1-50  
VORE 2018  
FLETA  
2- 15  
Format A3

# DETAJE TE SINJALISTIKES

## VENDOSJA E SHENJES RRUGORE

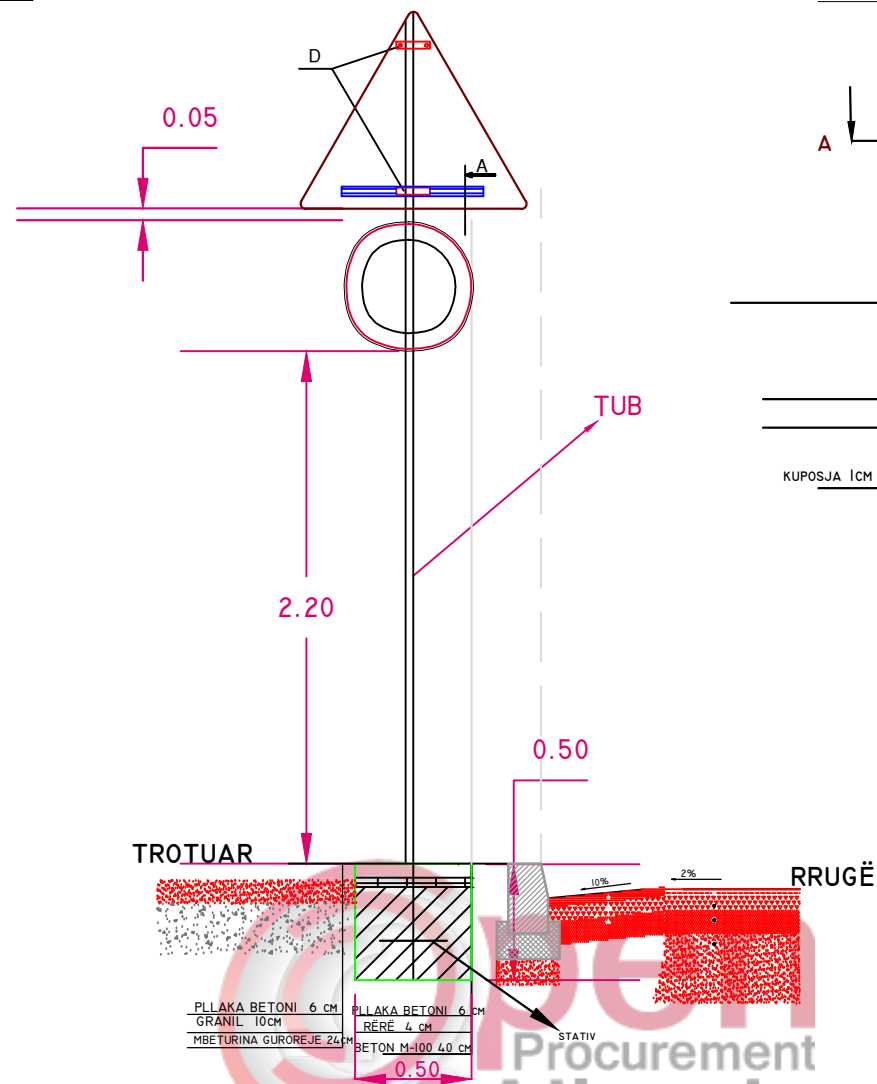
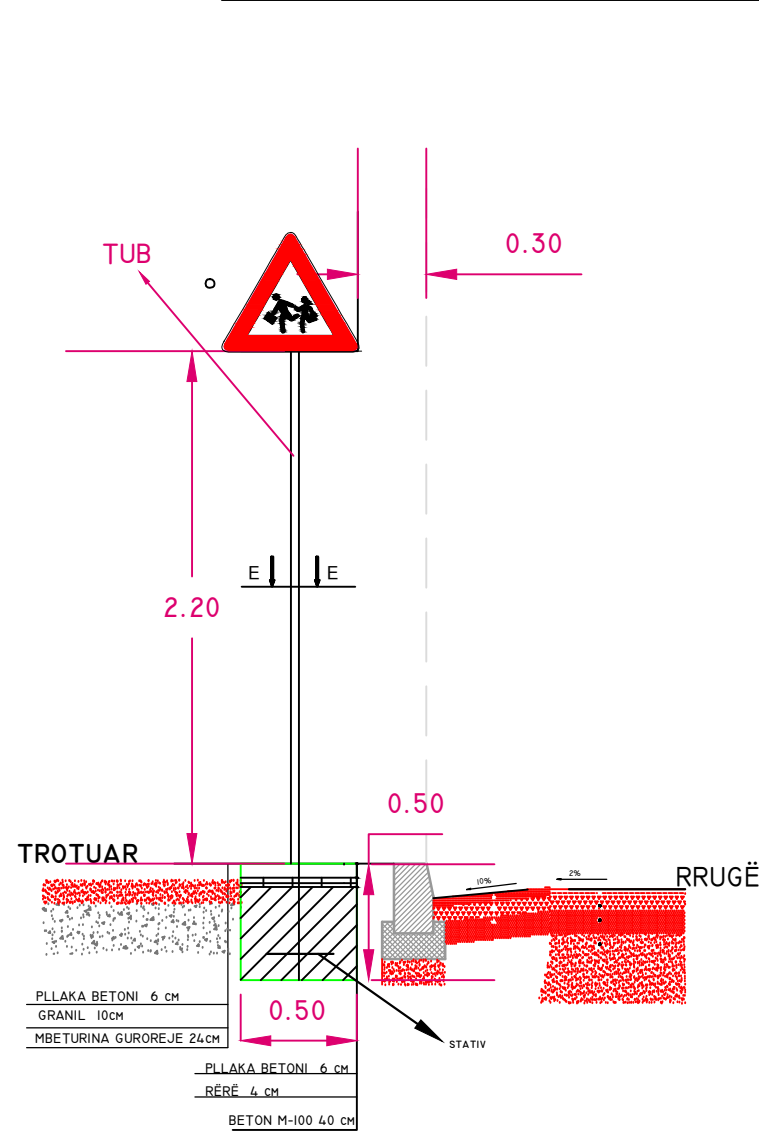

## PRERJA TERTHORE E TABELËS

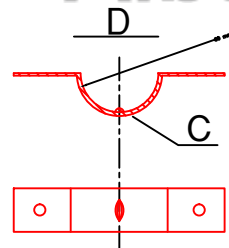
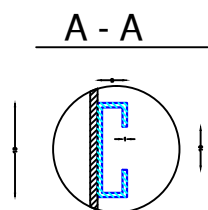
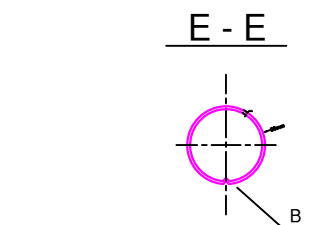
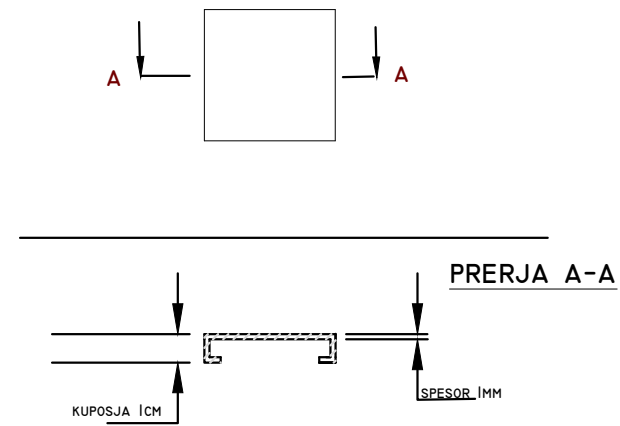

## DETAJE Kurrizë artificiale h=5cm

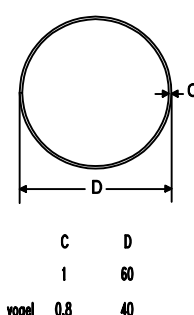
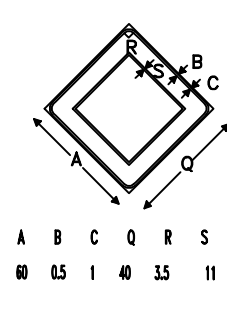
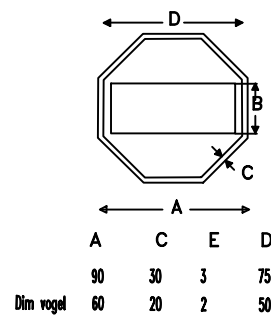
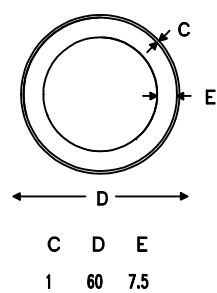
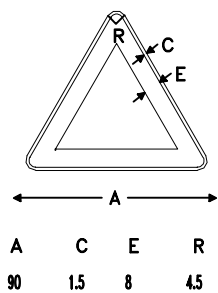
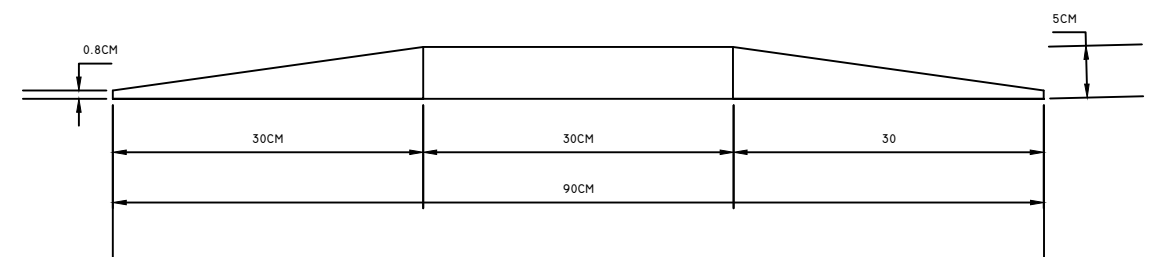

A	C	E	R
90	1.5	8	4.5

C	D	E
1	60	7.5

A	C	E	D
90	30	3	75
Dim vogel	60	20	2
			50

A	B	C	Q	R	S
60	0.5	1	40	3.5	11

C	D
1	60
Dim vogel	0.8
	40



**POROSITESI : BASHKIA VORE**  
**OBJEKTI:**  
 "RIKONSTRUKSION I RRUGEVE MUCAJ, SHERAJ DHE E VESLEVE FSHATI MUCAJ , BASHKIA VORE "

**Emertimi: DETAJE SINJALISTIKE**  
**"ARABEL - STUDIO" Sh.p.k**  
 Adresa: Njesia Bashkiake nr.7, Rruga "Frosina Plaku",  
 Pallati 21, Hyrja 1, Kati 2, Tirane.  
 Email: arabelstudio@gmail.com

**Drejtues i projektit**  
 Ark. Ana NISHKU  
 Inxh. Ardi ARKAXHIU

**Projektues**  
 Nd. Ardi ARKAXHIU  
 Ark. Rigert HYRA  
 Gjeo. Irfan BEGAJ  
 Elek. Altin ALLKAJ  
 Top. Mustafa HOXHAI  
 Hid. Hajredin MURGU

**SHKALLA**  
 SH 1-50  
 VORE 2018  
**FLETA**  
 2- 16  
 Format A3