



REPUBLIKA E SHQIPERISË
BASHKIA VORË

MIRATOHET
BASHKIA VORE
KRYETARI/ I DELEGUARI I TIJ
ZNJ.ADELINA ZELA
SEKRETARI I PERGJITHSHEM

PROJEKT ZBATIMI

OBJEKTI:
"NDERTIMI I KANALIT DOMJE DHE NDRICIMI RRUGES"
BASHKIA VORË

	POROSITESI : BASHKIA VORË	Emertimi: KAPAKU	Drejtues i projektit		Projektues		SHKALLA	FLETA
	OBJEKTI: "NDERTIMI I KANALIT DOMJE DHE NDRICIMI RRUGES"	 "ARABEL - STUDIO" Sh.p.k Adresa:Njesia Bashkiake nr.7, Rruga "Frosina Plaku", Pallati 21, Hyrja 1, Kati 2,Tirane. Email: arabelstudio@gmail.com	Adm. Ana NISHKU	Nd. Ardi ARKAXHIU	Elek. Altin ALLKAJ	-	0 - 00	
			Inxh. Ardi ARKAXHIU	Ark.Rigert HYRA	Top. Mustafa HOXHAJ	Vorë 2019	Format A3	
				Gjeo.Irfan BEGAJ	Hid. Hajredin MURGU			



REPUBLIKA E SHQIPERISË
BASHKIA VORË

PROJEKT ZBATIMI

OBJEKTI:
"NDERTIMI I KANALIT DOMJE DHE NDRICIMI RRUGES"
BASHKIA VORË

1.HOROGRAFIA E KANALIT

	POROSITESI : BASHKIA VORË	Emertimi: KAPAKU	Drejtues i projektit		Projektues		SHKALLA	FLETA
	OBJEKTI: "NDERTIMI I KANALIT DOMJE DHE NDRICIMI RRUGES"	 "ARABEL - STUDIO" Sh.p.k Adresa:Njesia Bashkiake nr.7, Rruga "Frosina Plaku", Pallati 21, Hyrja 1, Kati 2,Tirane. Email: arabelstudio@gmail.com	Adm. Ana NISHKU	Nd. Ardi ARKAXHIU	Elek. Altin ALLKAJ	-	1 - 00	
			Inxh. Ardi ARKAXHIU	Ark.Rigert HYRA	Top. Mustafa HOXHAJ	Vorë 2019	Format A3	
				Gjeo.Irfan BEGAJ	Hid. Hajredin MURGU			



POROSITESI : BASHKIA VORË

OBJEKTI:
"NDERTIMI I KANALIT DOMJE DHE NDRICIMI RRUGES"

Emertimi: HOROGRAFIA



"ARABEL - STUDIO" Sh.p.k
Adresa: Njesia Bashkiake nr.7, Rruga "Frosina Plaku",
Pallati 21, Hyrja 1, Kati 2, Tirane.
Email: arabelstudio@gmail.com

Drejtues i projektit

Adm. Ana NISHKU
Inxh. Ardi ARKAXHIU

Projektues

Nd. Ardi ARKAXHIU	Elek. Altin ALLKAJ
Ark.Rigert HYRA	Top. Mustafa HOXHAJ
Gjeo.Irfan BEGAJ	Hid. Hajredin MURGU

SHKALLA

1-2500

Vorë 2019

FLETA

1 - 01

Format A3



REPUBLIKA E SHQIPERISË
BASHKIA VORË

PROJEKT ZBATIMI

OBJEKTI:
"NDERTIMI I KANALIT DOMJE DHE NDRICIMI RRUGES"
BASHKIA VORË

3. PLANPIKETIMI

	POROSITESI : BASHKIA VORË	Emertimi: PLANPIKETIMI	Drejtes i projektit		Projektues		SHKALLA	FLETA
	OBJEKTI: "NDERTIMI I KANALIT DOMJE DHE NDRICIMI RRUGES"	 "ARABEL - STUDIO" Sh.p.k Adresa: Njesia Bashkiake nr.7, Rruga "Frosina Plaku", Pallati 21, Hyrja 1, Kati 2, Tirane. Email: arabelstudio@gmail.com	Adm. Ana NISHKU		Nd. Ardi ARKAXHIU	Elek. Altin ALLKAJ	-	3 - 00
			Inxh. Ardi ARKAXHIU		Ark.Rigert HYRA	Top. Mustafa HOXHAJ	Vorë 2018	Format A3
					Gjeo.Irfan BEGAJ	Hid. Hajredin MURGU		

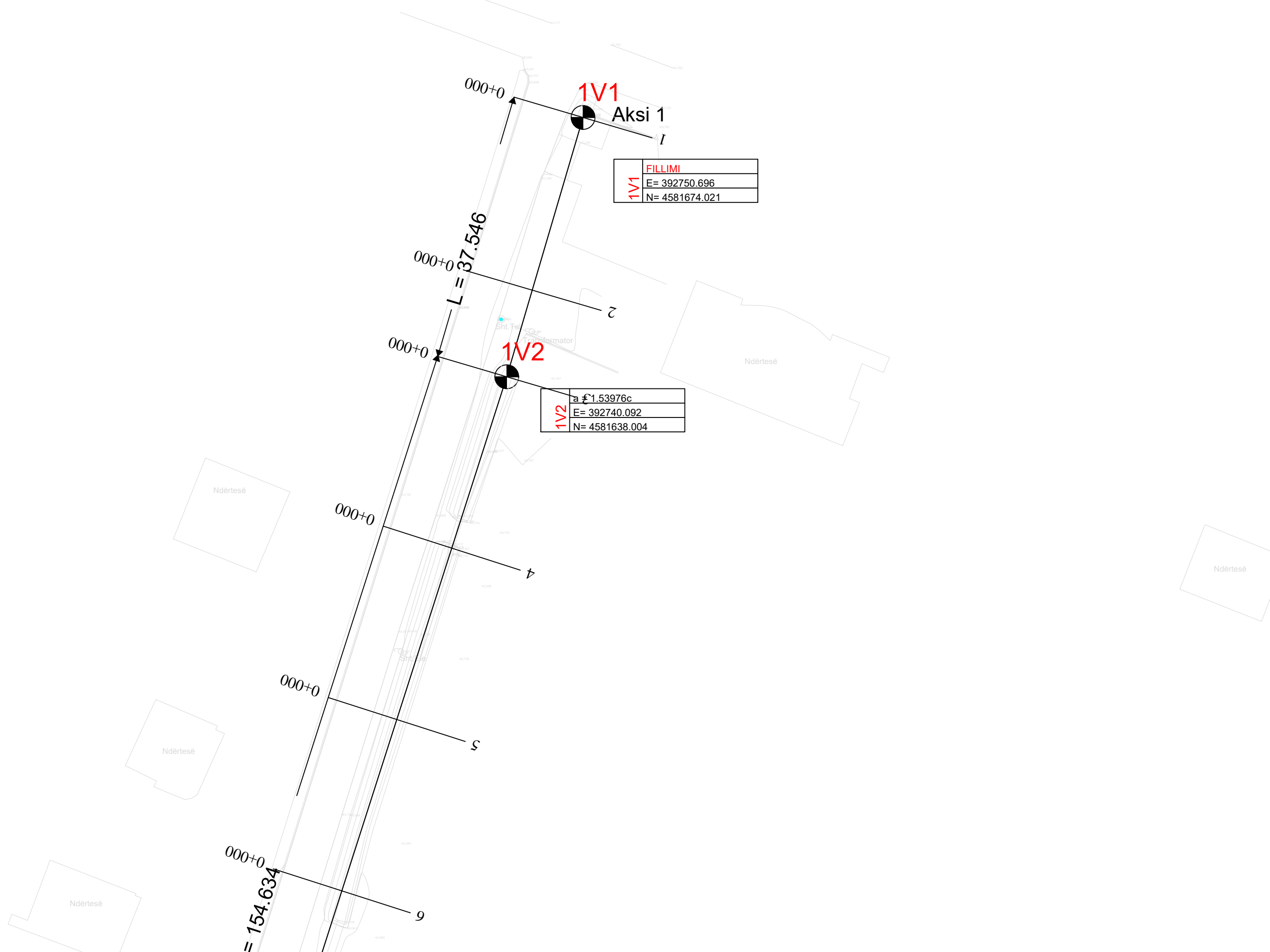

1V1	FILLIMI
	E= 392750.696
	N= 4581674.021

1V2	a £1.53976c
	E= 392740.092
	N= 4581638.004



POROSITESI : BASHKIA VORË

OBJEKTI:
"NDERTIMI I KANALIT DOMJE DHE NDRICIMI RRUGES"

Emertimi: PLANPIKETIMI



"ARABEL - STUDIO" Sh.p.k
Adresa:Njesia Bashkiake nr.7, Rruga "Frosina Plaku",
Pallati 21, Hyrja 1, Kati 2,Tirane.
Email: arabelstudio@gmail.com

Drejtues i projektit

Adm. Ana NISHKU
Inxh. Ardi ARKAXHIU

Projektues

Nd. Ardi ARKAXHIU	Elek. Altin ALLKAJ
Ark.Rigert HYRA	Top. Mustafa HOXHAJ
Gjeo.Irfan BEGAJ	Hid. Hajredin MURGU

SHKALLA FLETA

1-500	3-01
Vorë 2018	Format A3

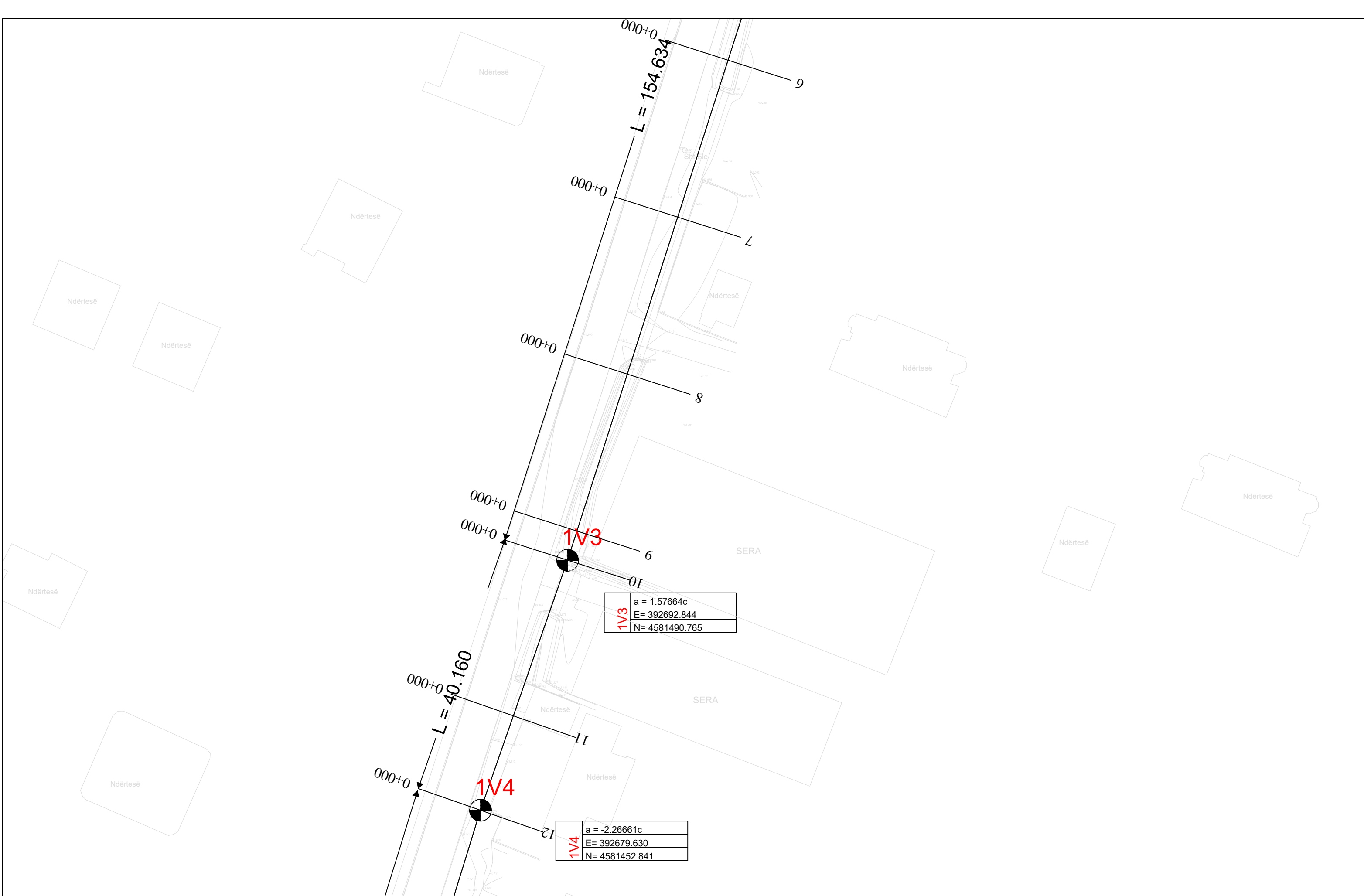

1V3	a = 1.57664c
	E= 392692.844
	N= 4581490.765

1V4	a = -2.26661c
	E= 392679.630
	N= 4581452.841



POROSITESI : BASHKIA VORË

OBJEKTI:
"NDERTIMI I KANALIT DOMJE DHE NDRICIMI RRUGES"

Emertimi: PLANPIKETIMI



"ARABEL - STUDIO" Sh.p.k
Adresa: Njesia Bashkiake nr.7, Rruga "Frosina Plaku",
Pallati 21, Hyrja 1, Kati 2, Tirane.
Email: arabelstudio@gmail.com

Drejtesues i projektit

Adm. Ana NISHKU
Inxh. Ardi ARKAXHIU

Projektues

Nd. Ardi ARKAXHIU
Ark.Rigert HYRA
Gjeo.Irfan BEGAJ
Elek. Altin ALLKAJ
Top. Mustafa HOXHAJ
Hid. Hajredin MURGU

SHKALLA

1-500
Vorë 2018

FLETA

3-02
Format A3

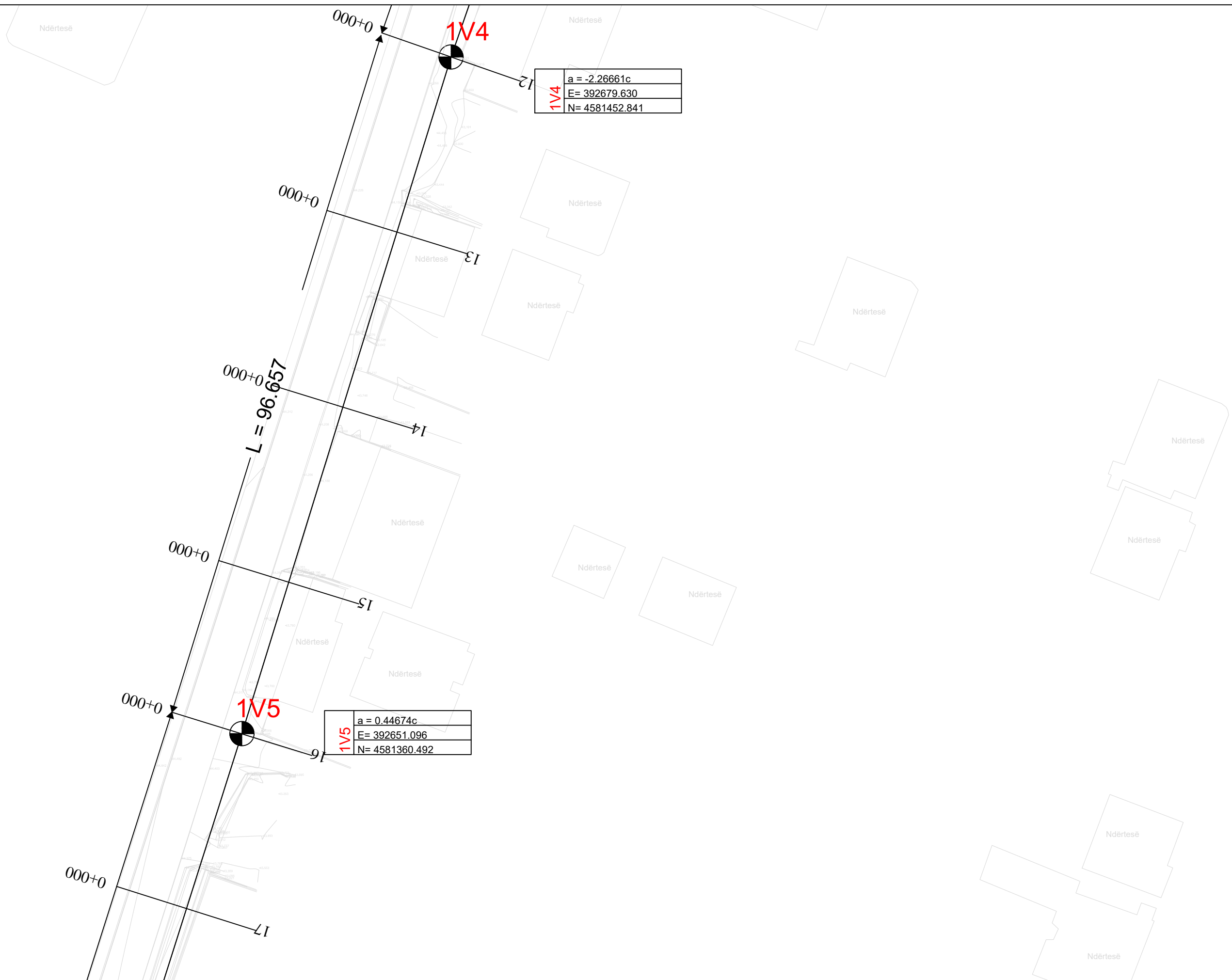

POROSITESI : BASHKIA VORË

OBJEKTI:
"NDERTIMI I KANALIT DOMJE DHE NDRICIMI RRUGES"

Emertimi: PLANPIKETIMI



"ARABEL - STUDIO" Sh.p.k
Adresa: Njesia Bashkiake nr.7, Rruga "Frosina Plaku",
Pallati 21, Hyrja 1, Kati 2, Tirane.
Email: arabelstudio@gmail.com

Drejtesues i projektit

Adm. Ana NISHKU
Inxh. Ardi ARKAXHIU

Projektues

Nd. Ardi ARKAXHIU	Elek. Altin ALLKAJ
Ark.Rigert HYRA	Top. Mustafa HOXHAJ
Gjeo.Irfan BEGAJ	Hid. Hajredin MURGU

SHKALLA

1-500
Vorë 2018

FLETA

3-03
Format A3

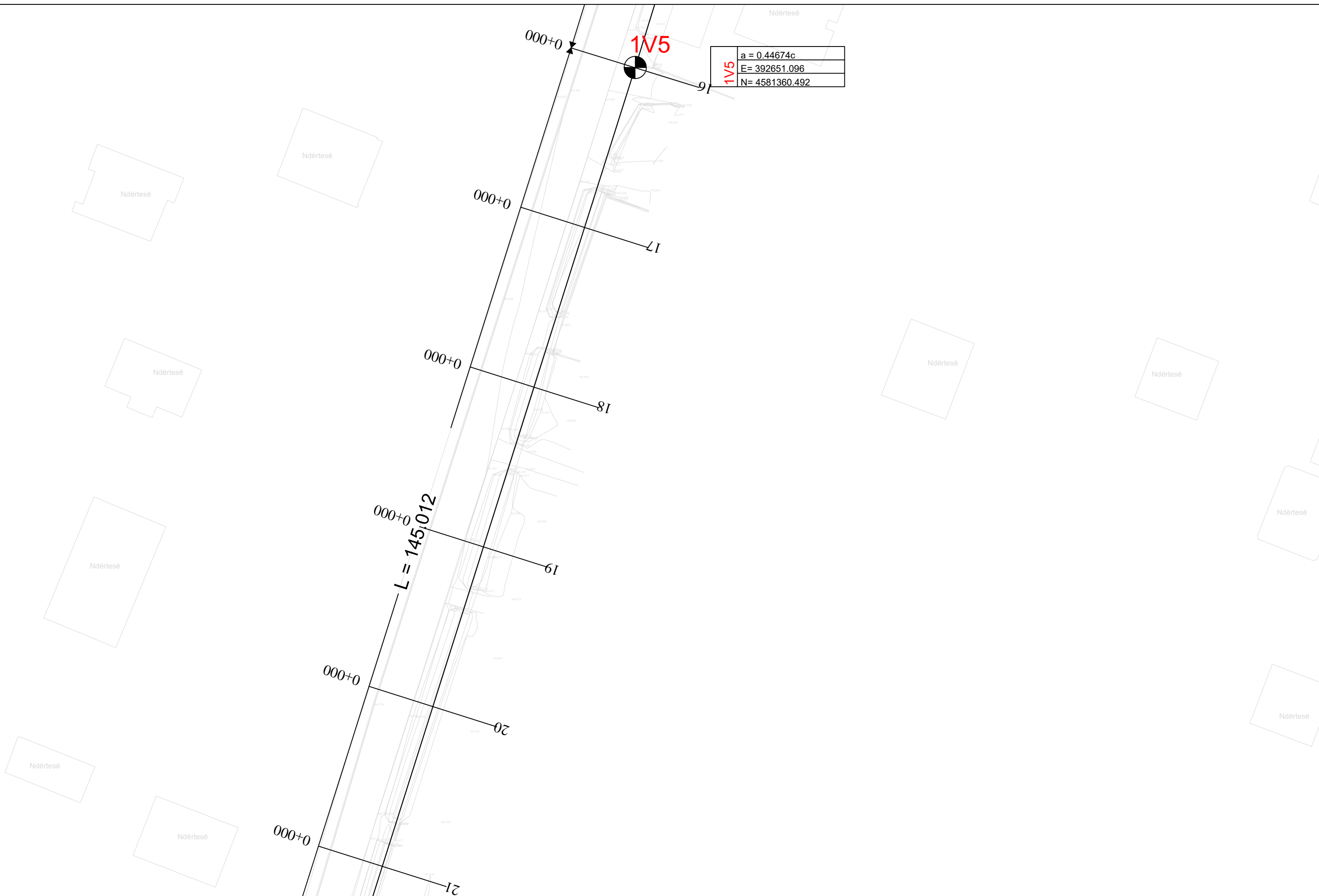

POROSITESI : BASHKIA VORË

OBJEKTI:
"NDERTIMI I KANALIT DOMJE DHE NDRICIMI RRUGES"

Emertimi: PLANPIKETIMI



"ARABEL - STUDIO" Sh.p.k
Adresa: Njesia Bashkiake nr.7, Rruga "Frosina Plaku",
Pallati 21, Hyrja 1, Kati 2, Tirane.
Email: arabelstudio@gmail.com

Drejtesues i projektit

Adm. Ana NISHKU
Inxh. Ardi ARKAXHIU

Projektues

Nd. Ardi ARKAXHIU	Elek. Altin ALLKAJ
Ark.Rigert HYRA	Top. Mustafa HOXHAJ
Gjeo.Irfan BEGAJ	Hid. Hajredin MURGU

SHKALLA

1-500
Vorë 2018

FLETA

3-04
Format A3

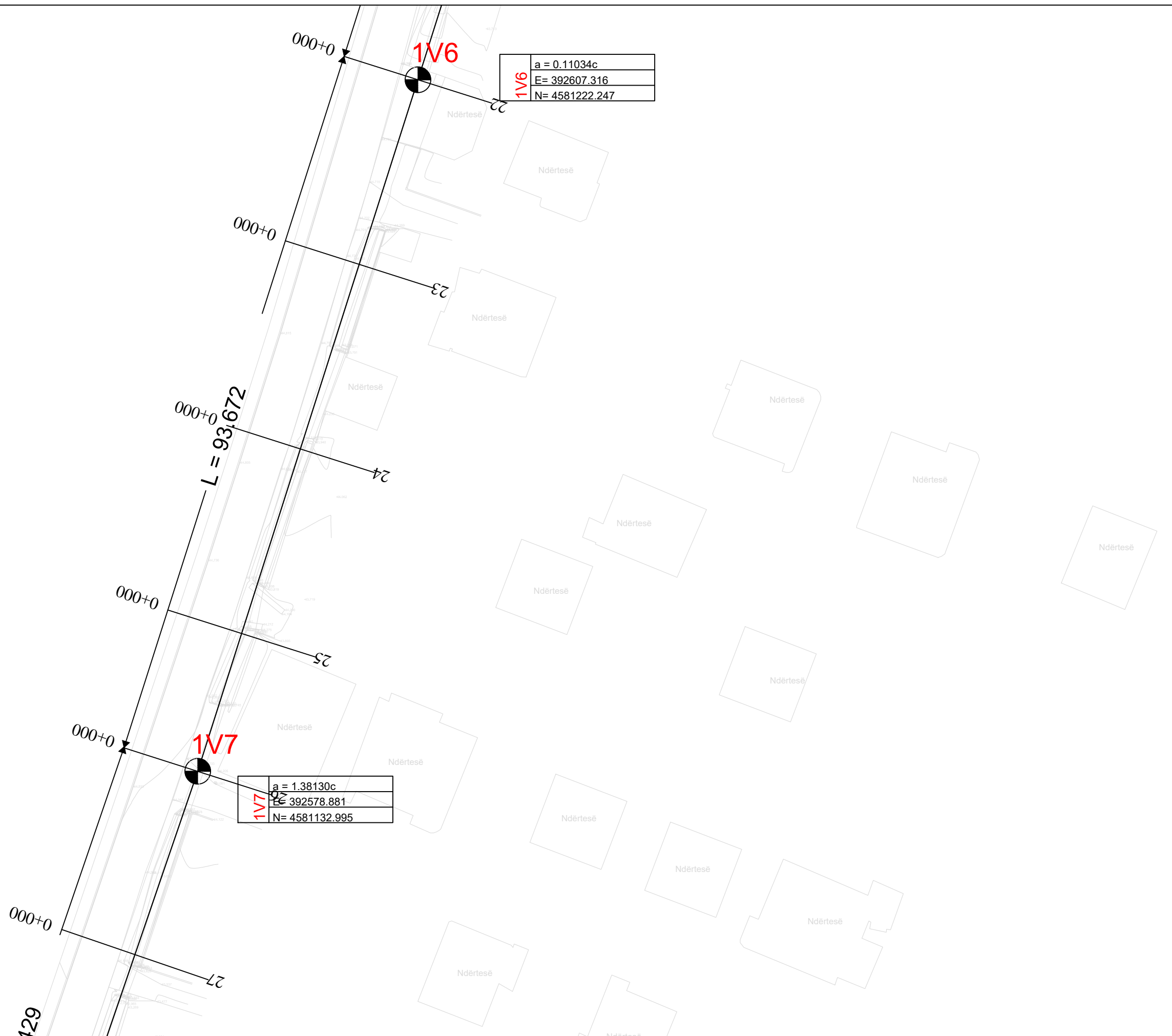

1V6	a = 0.11034c
	E= 392607.316
	N= 4581222.247

1V7	a = 1.38130c
	E= 392578.881
	N= 4581132.995



POROSITESI : BASHKIA VORË

OBJEKTI:
"NDERTIMI I KANALIT DOMJE DHE NDRICIMI RRUGES"

Emertimi: PLANPIKETIMI



"ARABEL - STUDIO" Sh.p.k
Adresa: Njesia Bashkiake nr.7, Rruga "Frosina Plaku",
Pallati 21, Hyrja 1, Kati 2, Tirane.
Email: arabelstudio@gmail.com

Drejtesues i projektit

Adm. Ana NISHKU
Inxh. Ardi ARKAXHIU

Projektues

Nd. Ardi ARKAXHIU	Elek. Altin ALLKAJ
Ark.Rigert HYRA	Top. Mustafa HOXHAI
Gjeo.Irfan BEGAJ	Hid. Hajredin MURGU

SHKALLA FLETA

1-500	3-05
Vorë 2018	Format A3

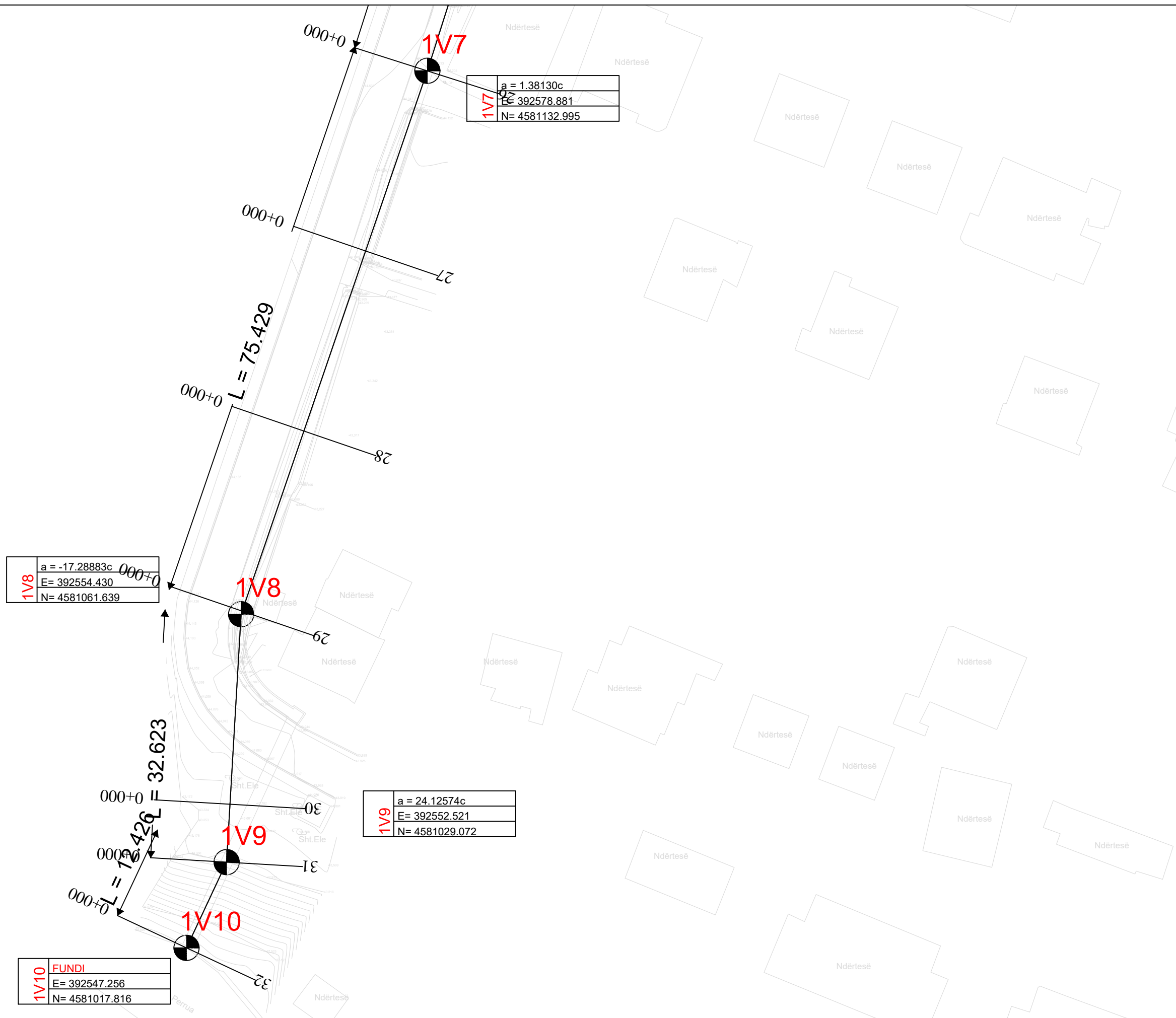

POROSITESI : BASHKIA VORË

OBJEKTI:
"NDERTIMI I KANALIT DOMJE DHE NDRICIMI RRUGES"

Emertimi: PLANPIKETIMI

"ARABEL - STUDIO" Sh.p.k

Adresa: Njesia Bashkiake nr.7, Rruga "Frosina Plaku",
Pallati 21, Hyrja 1, Kati 2, Tirane.
Email: arabelstudio@gmail.com

Drejtesues i projektit

Adm. Ana NISHKU

Inxh. Ardi ARKAXHIU

Projektues

Nd. Ardi ARKAXHIU	Elek. Altin ALLKAJ
Ark.Rigert HYRA	Top. Mustafa HOXHAJ
Gjeo.Irfan BEGAJ	Hid. Hajredin MURGU

SHKALLA	FLETA
1-500	3-06
Vorë 2018	Format A3



REPUBLIKA E SHQIPERISË
BASHKIA VORË

PROJEKT ZBATIMI

OBJEKTI:
"NDERTIMI I KANALIT DOMJE DHE NDRICIMI RRUGES"
BASHKIA VORË

3.PLANIMETRIA E KANALIT TE MBULUAR



POROSITESI : BASHKIA VORË

OBJEKTI:
"NDERTIMI I KANALIT DOMJE DHE NDRICIMI RRUGES"

Emertimi: PLANIMETRIA E KANALIT



"ARABEL - STUDIO" Sh.p.k
Adresa:Njesia Bashkiake nr.7, Rruga "Frosina Plaku",
Pallati 21, Hyrja 1, Kati 2,Tirane.
Email: arabelstudio@gmail.com

Drejtues i projektit

Adm. Ana NISHKU

Inxh. Ardi ARKAXHIU

Projektues

Nd. Ardi ARKAXHIU

Ark.Rigert HYRA

Gjeo.Irfan BEGAJ

Elek. Altin ALLKAJ

Top. Mustafa HOXHAJ

Hid. Hajredin MURGU

SHKALLA

-

Vorë 2018

FLETA

3 - 00

Format A3

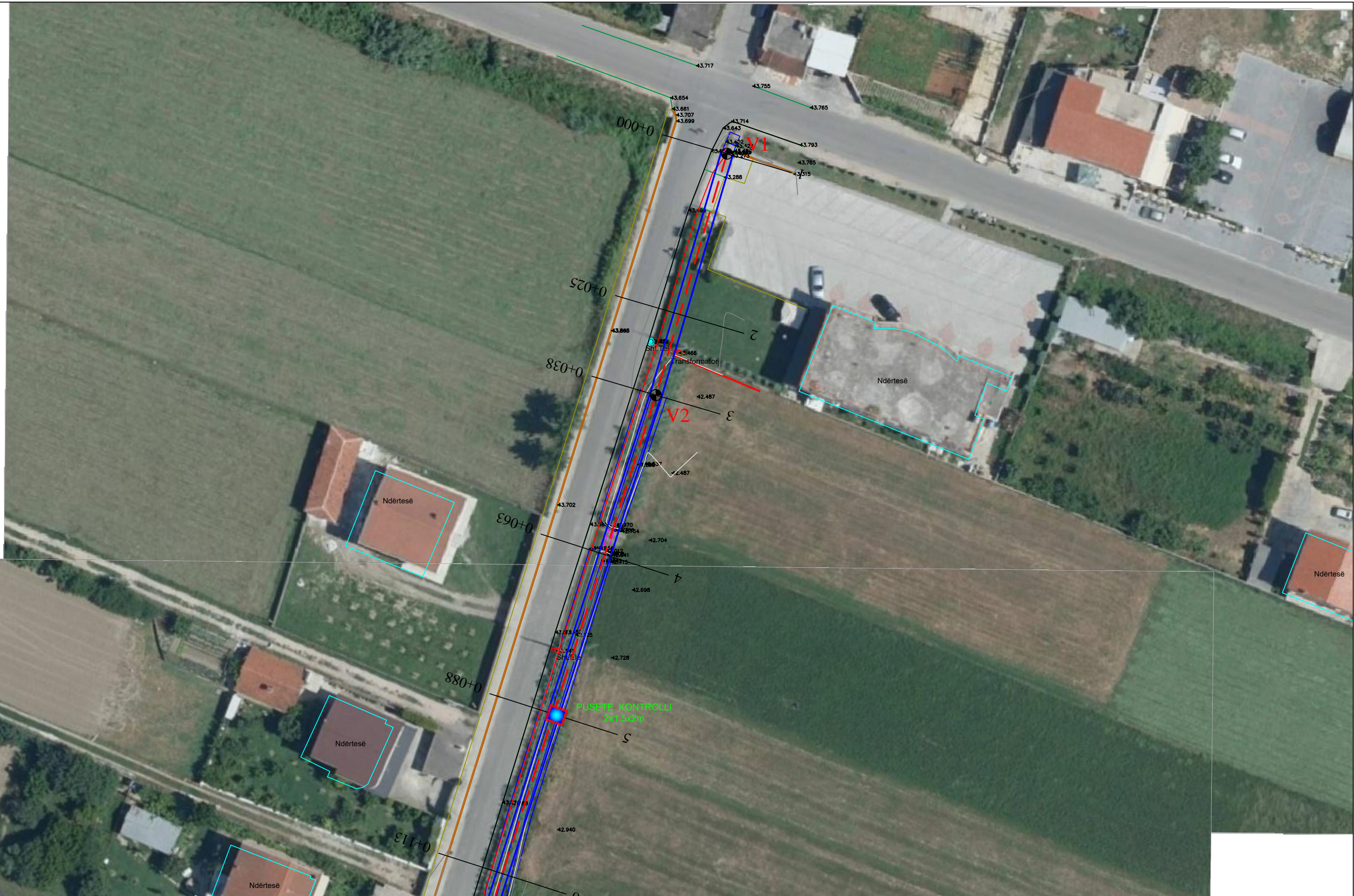

POROSITESI : BASHKIA VORË

OBJEKTI:
"NDERTIMI I KANALIT DOMJE DHE NDRICIMI RRUGES"

Emertimi: PLANIMETRIA E KANALIT



"ARABEL - STUDIO" Sh.p.k
Adresa: Njesia Bashkiake nr.7, Rruga "Frosina Plaku",
Pallati 21, Hyrja 1, Kati 2, Tirane.
Email: arabelstudio@gmail.com

Drejtesues i projektit

Adm. Ana NISHKU
Inxh. Ardi ARKAXHIU

Projektues

Nd. Ardi ARKAXHIU
Ark.Rigert HYRA
Gjeo.Irfan BEGAJ
Elek. Altin ALLKAJ
Top. Mustafa HOXHAJ
Hid. Hajredin MURGU

SHKALLA

SH- 1:500

Vorë 2018

FLETA

3 - 01

Format A3

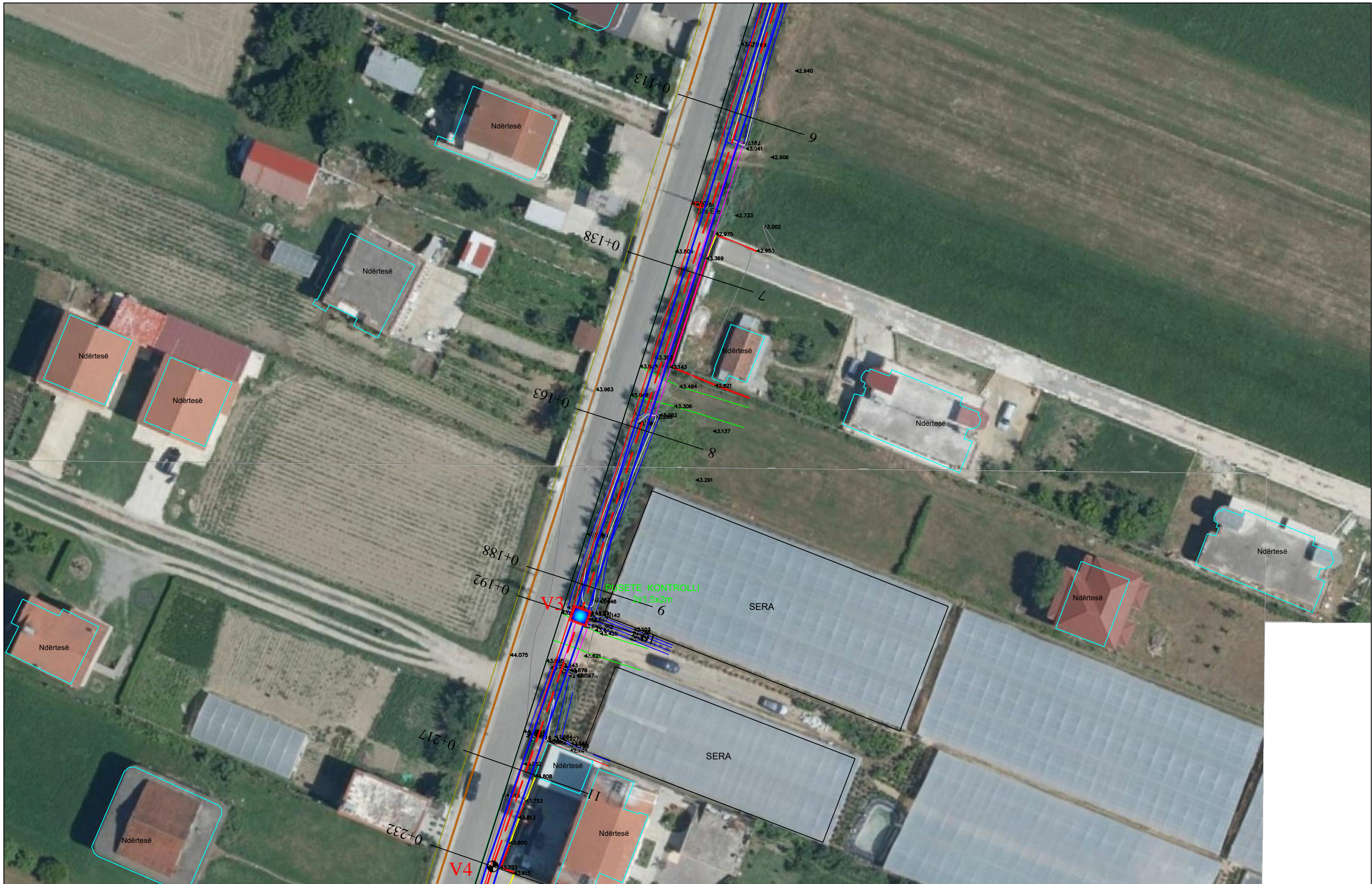

POROSITESI : BASHKIA VORË

OBJEKTI:
"NDERTIMI I KANALIT DOMJE DHE NDRICIMI RRUGES"

Emertimi: PLANIMETRIA E KANALIT



"ARABEL - STUDIO" Sh.p.k
Adresa: Njesia Bashkiake nr.7, Rruga "Frosina Plaku",
Pallati 21, Hyrja 1, Kati 2, Tirane.
Email: arabelstudio@gmail.com

Drejtesues i projektit

Adm. Ana NISHKU
Inxh. Ardi ARKAXHIU

Projektues

Nd. Ardi ARKAXHIU
Ark.Rigert HYRA
Gjeo.Irfan BEGAJ
Elek. Altin ALLKAJ
Top. Mustafa HOXHAJ
Hid. Hajredin MURGU

SHKALLA

SH- 1:500
Vorë 2018

FLETA

3 - 02
Format A3

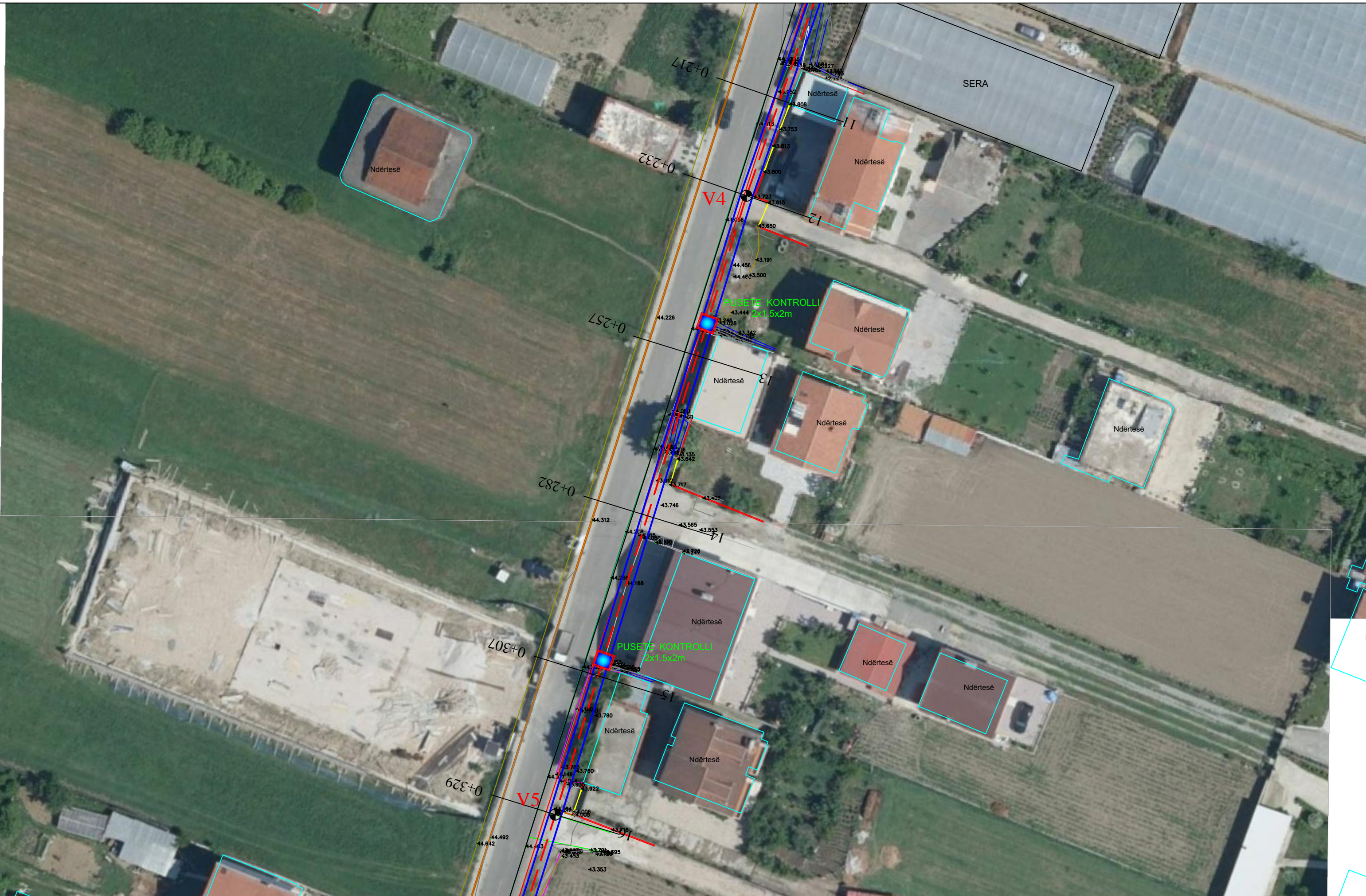

POROSITESI : BASHKIA VORË

OBJEKTI:
"NDERTIMI I KANALIT DOMJE DHE NDRICIMI RRUGES"

Emertimi: PLANIMETRIA E KANALIT



"ARABEL - STUDIO" Sh.p.k
Adresa: Njesia Bashkiake nr.7, Rruga "Frosina Plaku",
Pallati 21, Hyrja 1, Kati 2, Tirane.
Email: arabelstudio@gmail.com

Drejtesues i projektit

Adm. Ana NISHKU

Inxh. Ardi ARKAXHIU

Projektues

Nd. Ardi ARKAXHIU

Ark.Rigert HYRA

Gjeo.Irfan BEGAJ

Elek. Altin ALLKAJ

Top. Mustafa HOXHAJ

Hid. Hajredin MURGU

SHKALLA

SH- 1:500

Vorë 2018

FLETA

3 - 03

Format A3

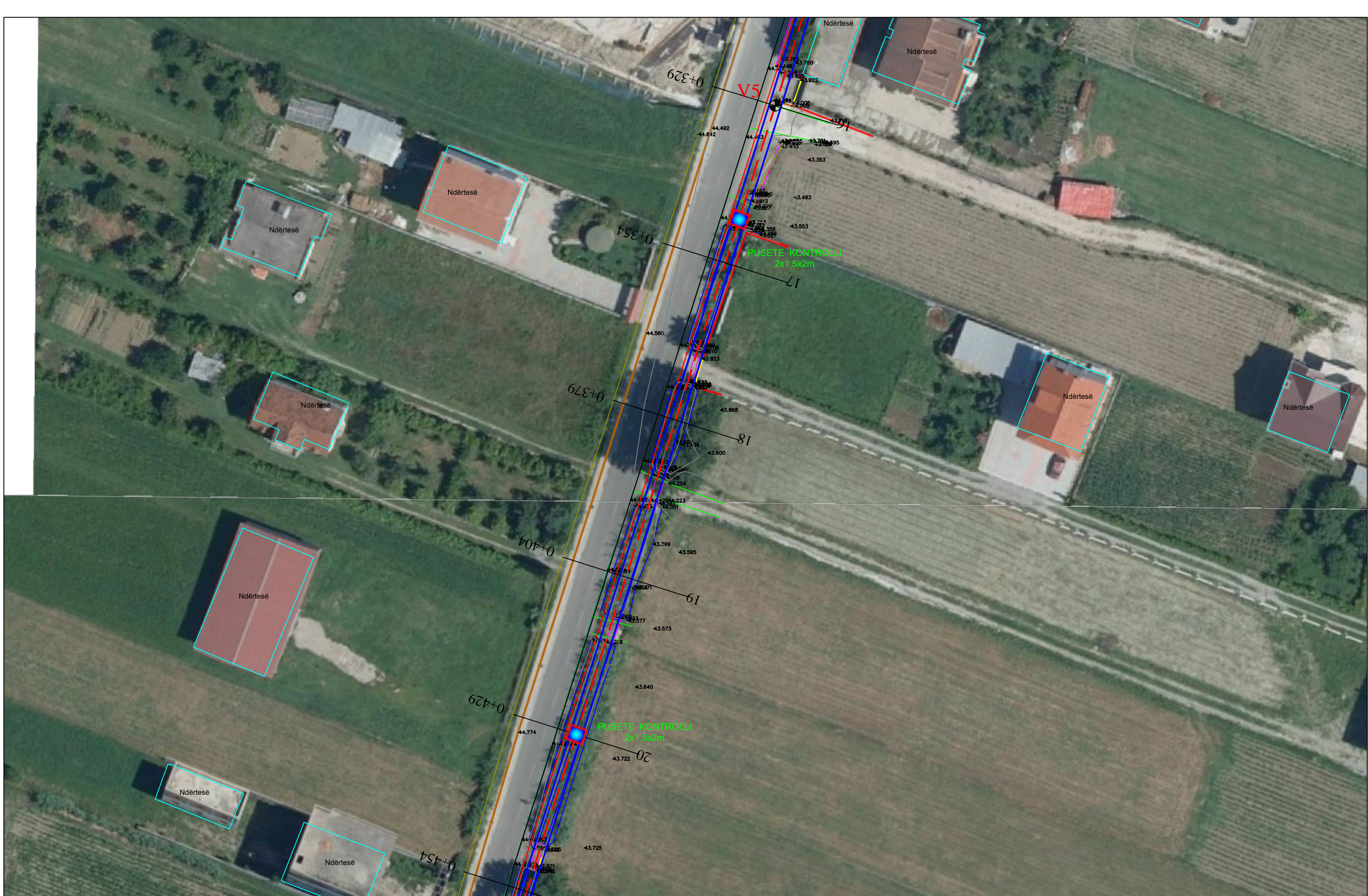

POROSITESI : BASHKIA VORË

OBJEKTI:
"NDERTIMI I KANALIT DOMJE DHE NDRICIMI RRUGES"

Emertimi: PLANIMETRIA E KANALIT



"ARABEL - STUDIO" Sh.p.k

Adresa: Njesia Bashkiake nr.7, Rruga "Frosina Plaku",
Pallati 21, Hyrja 1, Kati 2, Tirane.
Email: arabelstudio@gmail.com

Drejtesues i projektit

Adm. Ana NISHKU

Inxh. Ardi ARKAXHIU

Projektues

Nd. Ardi ARKAXHIU

Ark.Rigert HYRA

Gjeo.Irfan BEGAJ

Elek. Altin ALLKAJ

Top. Mustafa HOXHAJ

Hid. Hajredin MURGU

SHKALLA

SH- 1:500

Vorë 2018

FLETA

3 - 04

Format A3



POROSITESI : BASHKIA VORË

OBJEKTI:
"NDERTIMI I KANALIT DOMJE DHE NDRICIMI RRUGES"

Emertimi: PLANIMETRIA E KANALIT



"ARABEL - STUDIO" Sh.p.k
Adresa: Njesia Bashkiake nr.7, Rruga "Frosina Plaku",
Pallati 21, Hyrja 1, Kati 2, Tirane.
Email: arabelstudio@gmail.com

Drejtesues i projektit

Adm. Ana NISHKU

Inxh. Ardi ARKAXHIU

Projektues

Nd. Ardi ARKAXHIU

Ark.Rigert HYRA

Gjeo.Irfan BEGAJ

Elek. Altin ALLKAJ

Top. Mustafa HOXHAJ

Hid. Hajredin MURGU

SHKALLA

SH- 1:500

Vorë 2018

FLETA

3 - 05

Format A3

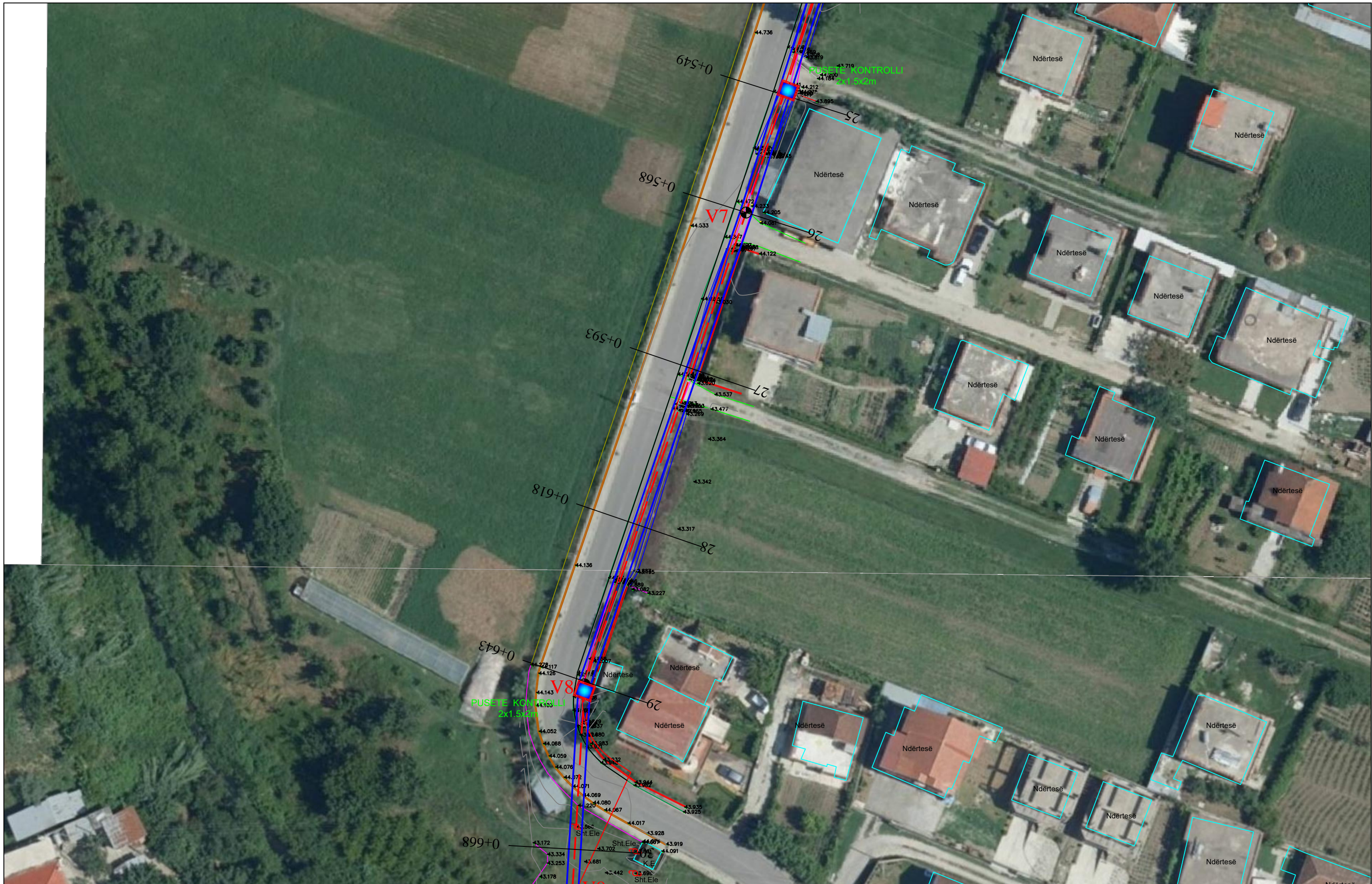

POROSITESI : BASHKIA VORË

OBJEKTI:
"NDERTIMI I KANALIT DOMJE DHE NDRICIMI RRUGES"

Emertimi: PLANIMETRIA E KANALIT



"ARABEL - STUDIO" Sh.p.k

Adresa: Njesia Bashkiake nr.7, Rruga "Frosina Plaku",
Pallati 21, Hyrja 1, Kati 2, Tirane.
Email: arabelstudio@gmail.com

Drejtesues i projektit

Adm. Ana NISHKU

Inxh. Ardi ARKAXHIU

Projektues

Nd. Ardi ARKAXHIU

Ark.Rigert HYRA

Gjeo.Irfan BEGAJ

Elek. Altin ALLKAJ

Top. Mustafa HOXHAJ

Hid. Hajredin MURGU

SHKALLA

SH- 1:500

Vorë 2018

FLETA

3 - 06

Format A3

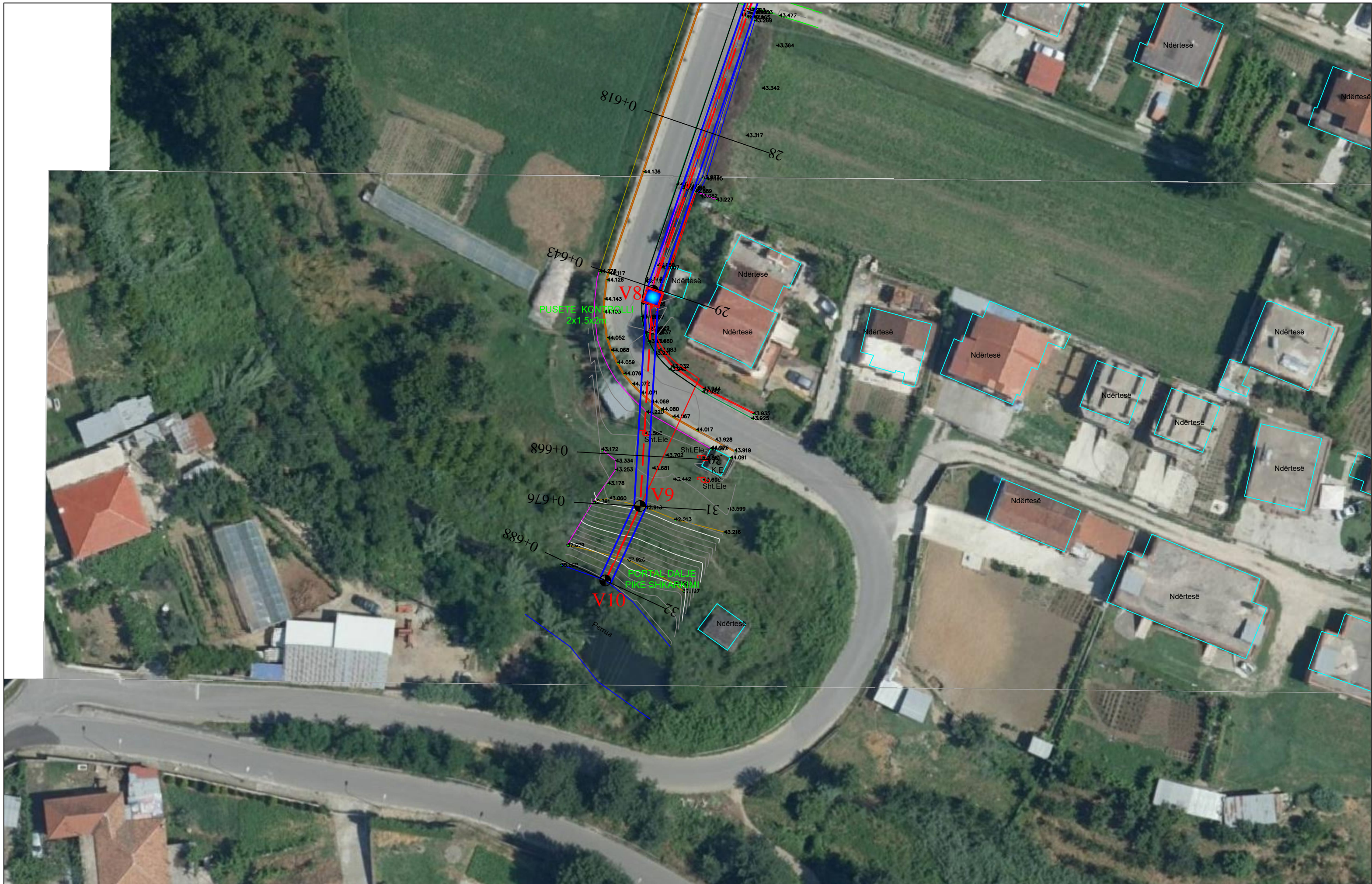

POROSITESI : BASHKIA VORË

OBJEKTI:
"NDERTIMI I KANALIT DOMJE DHE NDRICIMI RRUGES"

Emertimi: PLANIMETRIA E KANALIT



"ARABEL - STUDIO" Sh.p.k
Adresa: Njesia Bashkiake nr.7, Rruga "Frosina Plaku",
Pallati 21, Hyrja 1, Kati 2, Tirane.
Email: arabelstudio@gmail.com

Drejtesues i projektit

Adm. Ana NISHKU
Inxh. Ardi ARKAXHIU

Projektues

Nd. Ardi ARKAXHIU
Ark.Rigert HYRA
Gjeo.Irfan BEGAJ
Elek. Altin ALLKAJ
Top. Mustafa HOXHAI
Hid. Hajredin MURGU

SHKALLA

SH- 1:500
Vorë 2018

FLETA

3 - 07
Format A3



REPUBLIKA E SHQIPERISË
BASHKIA VORË

PROJEKT ZBATIMI

OBJEKTI:
"NDERTIMI I KANALIT DOMJE DHE NDRICIMI RRUGES"
BASHKIA VORË

4 . P L A N I M E T R I A K . U . B



POROSITESI : BASHKIA VORË

OBJEKTI:
"NDERTIMI I KANALIT DOMJE DHE NDRICIMI RRUGES"

Emertimi: PLANIMETRIA E KANALIT



"ARABEL - STUDIO" Sh.p.k
Adresa: Njesia Bashkiake nr.7, Rruga "Frosina Plaku",
Pallati 21, Hyrja 1, Kati 2, Tirane.
Email: arabelstudio@gmail.com

Drejtues i projektit

Adm. Ana NISHKU

Inxh. Ardi ARKAXHIU

Projektues

Nd. Ardi ARKAXHIU

Ark.Rigert HYRA

Gjeo.Irfan BEGAJ

Elek. Altin ALLKAJ

Top. Mustafa HOXHAJ

Hid. Hajredin MURGU

SHKALLA

-

Vorë 2018

FLETA

4 - 00

Format A3

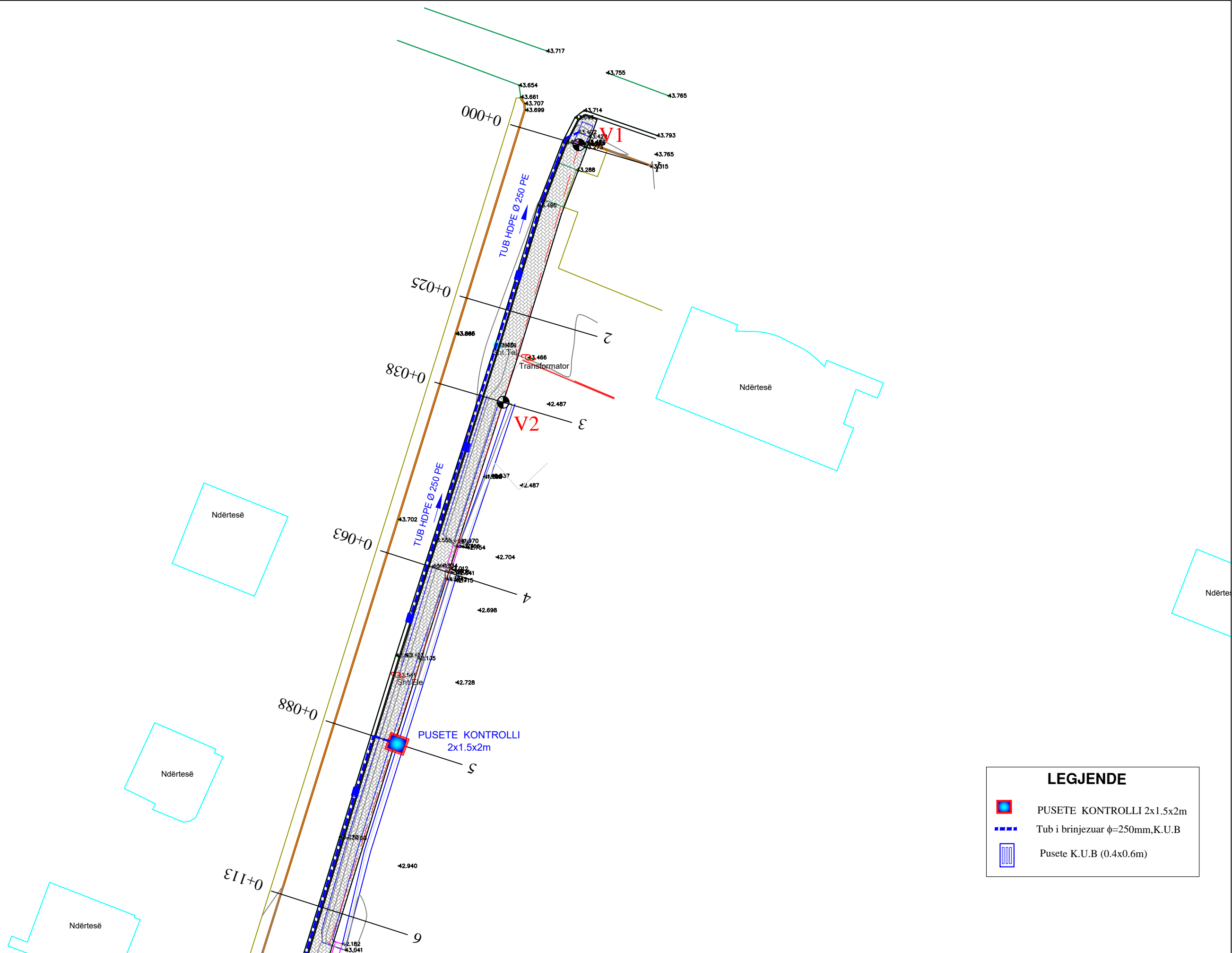

LEGJENDE	
	PUSETE KONTROLLI 2x1.5x2m
	Tub i brinjezuar $\phi=250\text{mm}$, K.U.B
	Pusete K.U.B (0.4x0.6m)



POROSITESI : BASHKIA VORË

OBJEKTI:
"NDERTIMI I KANALIT DOMJE DHE NDRICIMI RRUGES"

Emertimi: PLANIMETRIA KUB

"ARABEL - STUDIO" Sh.p.k
Adresa: Njesia Bashkiake nr.7, Rruga "Frosina Plaku",
Pallati 21, Hyrja 1, Kati 2, Tirane.
Email: arabelstudio@gmail.com

Drejtesues i projektit

Adm. Ana NISHKU

Inxh. Ardi ARKAXHIU

Projektues

Nd. Ardi ARKAXHIU	Elek. Altin ALLKAJ
Ark.Rigert HYRA	Top. Mustafa HOXHAI
Gjeo.Irfan BEGAJ	Hid. Hajredin MURGU

SHKALLA	FLETA
SH- 1:500	4 - 01
Vorë 2018	Format A3

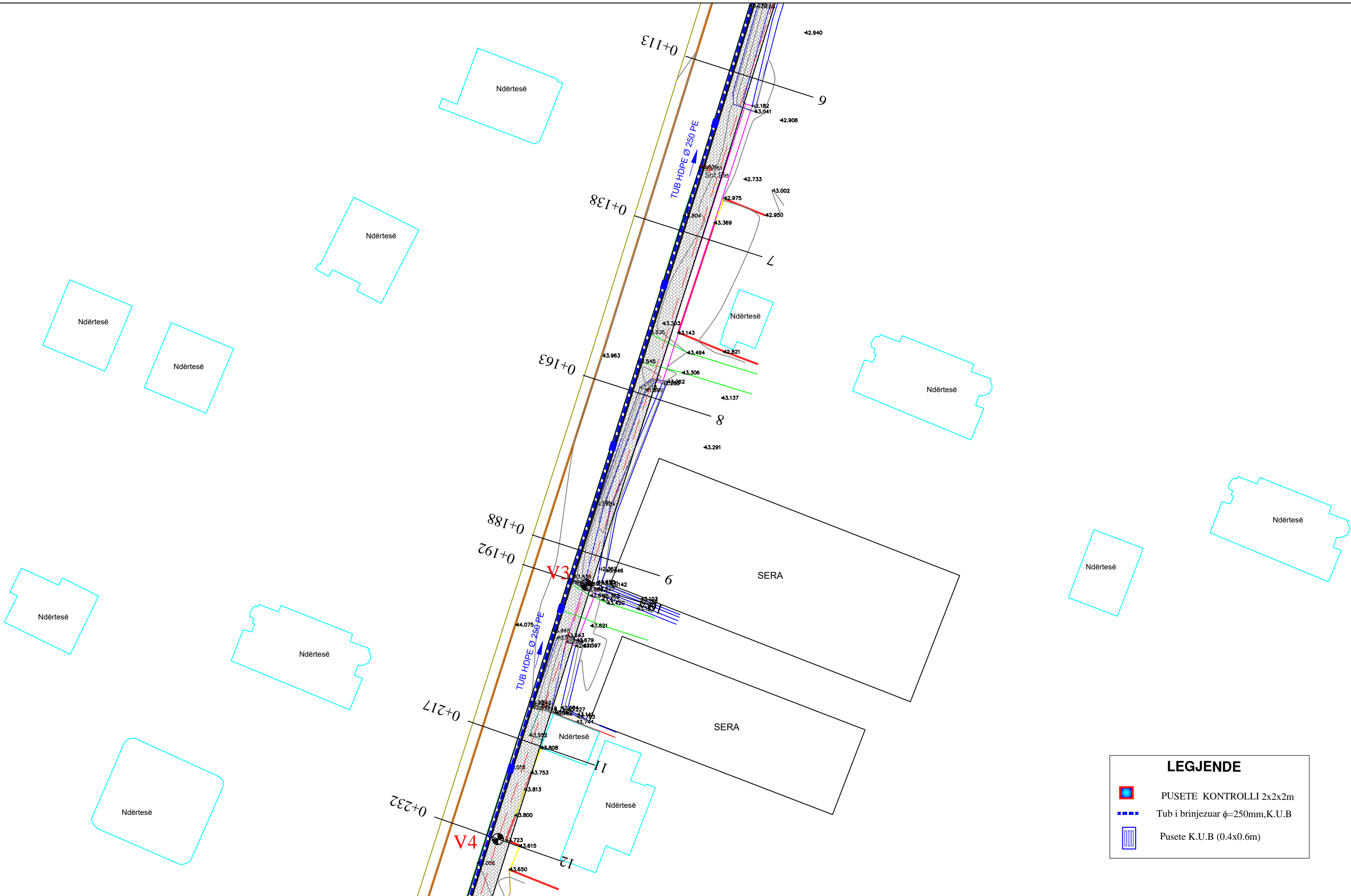

LEGJENDE	
	PUSETE KONTROLLI 2x2x2m
	Tub i brinjeluar $\phi=250\text{mm}$, K.U.B
	Pusete K.U.B (0.4x0.6m)



POROSITESI : BASHKIA VORË

OBJEKTI:
"NDERTIMI I KANALIT DOMJE DHE NDRICIMI RRUGES"

Emertimi: PLANIMETRIA KUB



"ARABEL - STUDIO" Sh.p.k
Adresa: Njesia Bashkiake nr.7, Rruga "Frosina Plaku",
Pallati 21, Hyrja 1, Kati 2, Tirane.
Email: arabelstudio@gmail.com

Drejtesues i projektit

Adm. Ana NISHKU
Inxh. Ardi ARKAXHIU

Projektues

Nd. Ardi ARKAXHIU
Ark.Rigert HYRA
Gjeo.Irfan BEGAJ
Elek. Altin ALLKAJ
Top. Mustafa HOXHAI
Hid. Hajredin MURGU

SHKALLA

SH- 1:500
Vorë 2018

FLETA

4 - 02
Format A3

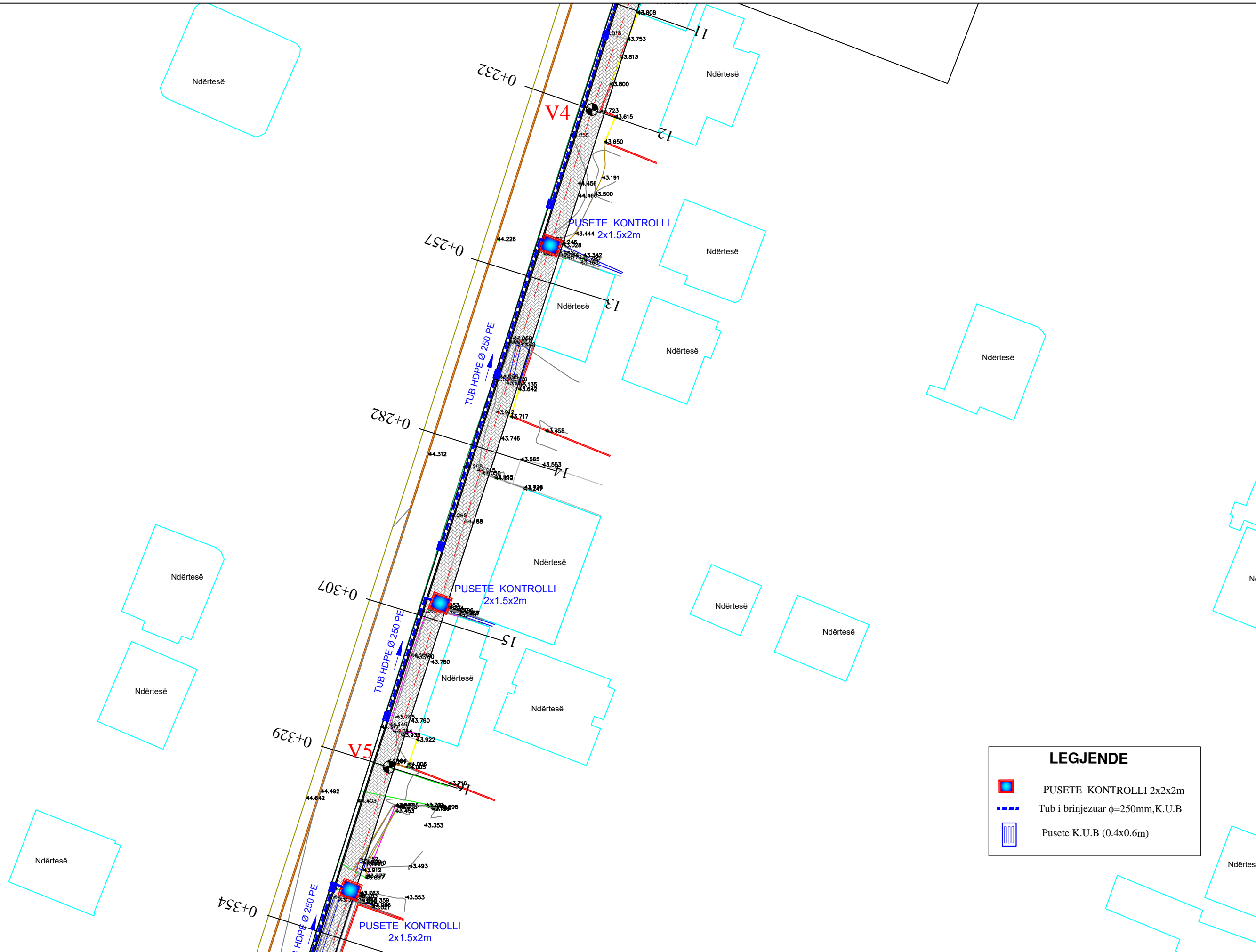

LEGJENDE

- PUSETE KONTROLLI 2x2x2m
- Tub i brinjezuar $\phi=250$ mm, K.U.B
- Puseste K.U.B (0.4x0.6m)



POROSITESI : BASHKIA VORË

OBJEKTI:
"NDERTIMI I KANALIT DOMJE DHE NDRICIMI RRUGES"

Emertimi: PLANIMETRIA KUB



"ARABEL - STUDIO" Sh.p.k
Adresa: Njesia Bashkiake nr.7, Rruga "Frosina Plaku",
Pallati 21, Hyrja 1, Kati 2, Tirane.
Email: arabelstudio@gmail.com

Drejtuues i projektit

Adm. Ana NISHKU

Inxh. Ardi ARKAXHIU

Projektues

Nd. Ardi ARKAXHIU	Elek. Altin ALLKAJ
Ark. Rigert HYRA	Top. Mustafa HOXHAI
Gjeo. Ifan BEGAJ	Hid. Hajredin MURGU

SHKALLA	FLETA
SH- 1:500	4 - 03
Vorë 2018	Format A3

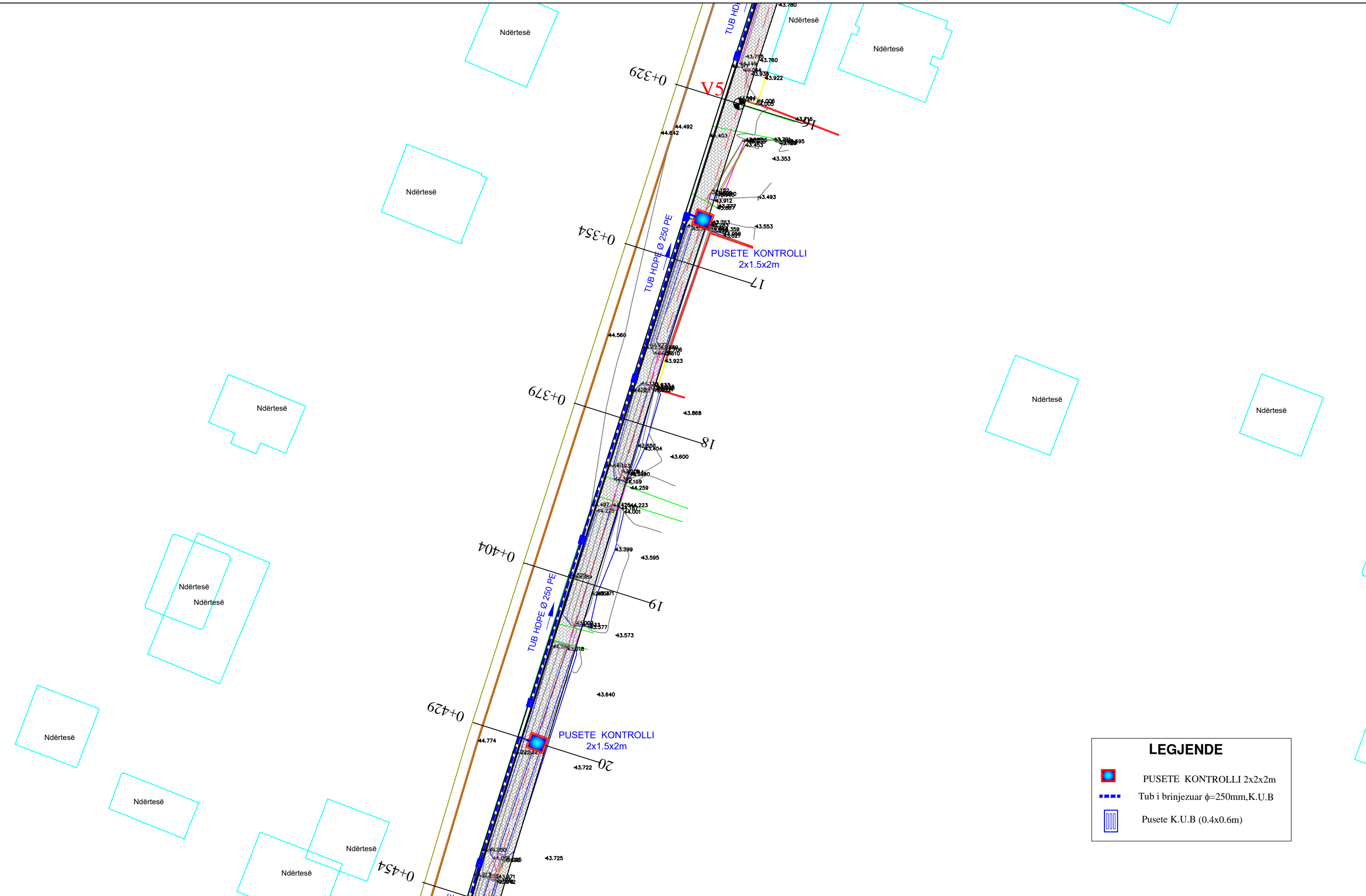

LEGJENDE

	PUSETE KONTROLLI 2x2x2m
	Tub i brinjëzuar φ=250mm,K.U.B
	Pusete K.U.B (0.4x0.6m)

	POROSITESI : BASHKIA VORË	Emertimi: PLANIMETRIA KUB	Drejtues i projektit Adm. Ana NISHKU	Projektues Nd. Ardi ARKAXHIU Elek. Altin ALLKAJ		SHKALLA SH- 1:500	FLETA 4 - 04
	OBJEKTI: "NDERTIMI I KANALIT DOMJE DHE NDRICIMI RRUGES"	"ARABEL - STUDIO" Sh.p.k Adresa:Njesia Bashkiake nr.7, Rruga "Frosina Plaku", Pallati 21, Hyrja 1, Kati 2,Tirane. Email: arabelstudio@gmail.com	Inxh. Ardi ARKAXHIU	Ark.Rigert HYRA Gjeo.Irfan BEGAJ		Hid. Hajredin MURGU	Vorë 2018

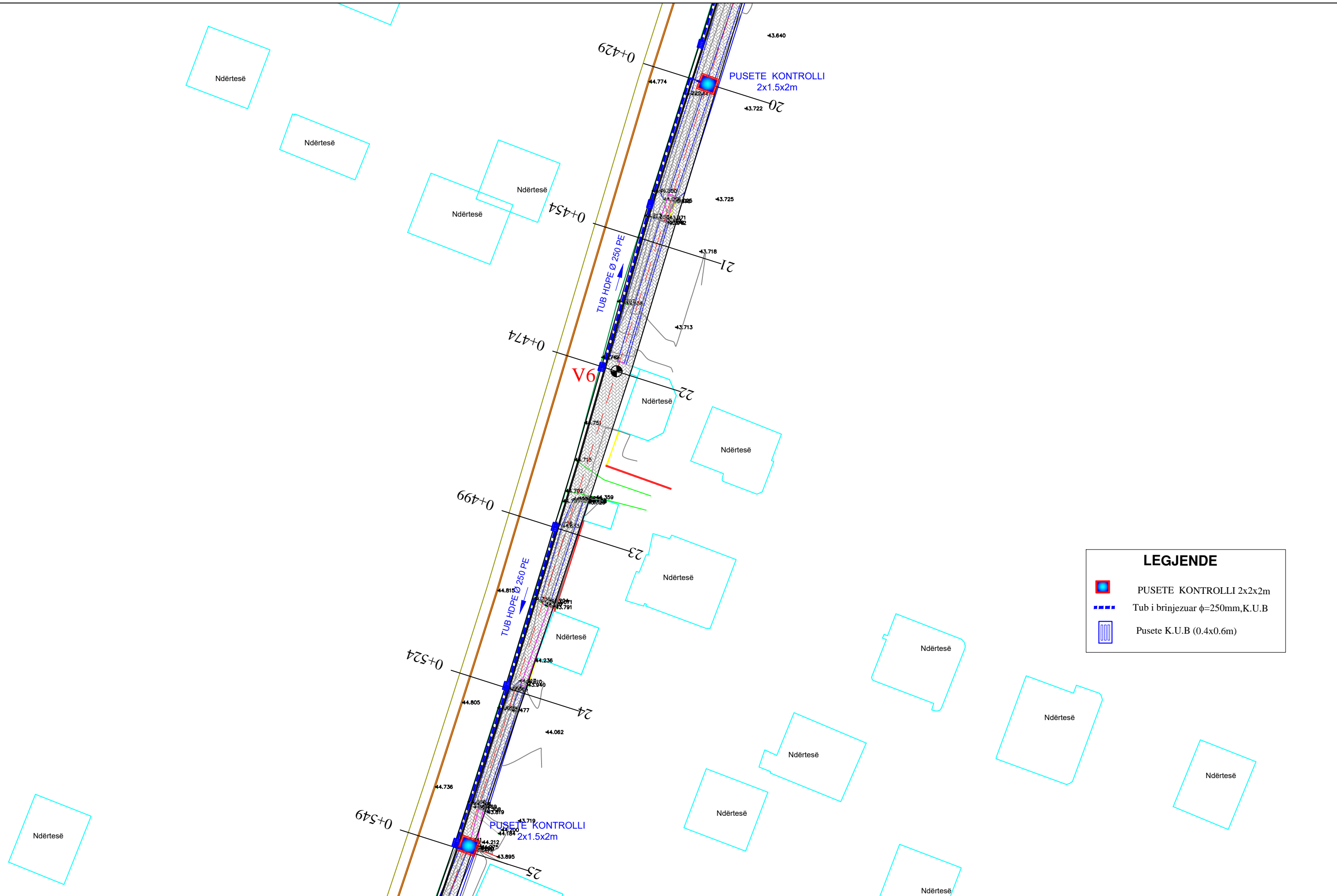

LEGJENDE	
	PUSETE KONTROLLI 2x2x2m
	Tub i brinjezuar $\phi=250\text{mm}$, K.U.B
	Pusete K.U.B (0.4x0.6m)

 **POROSITESI : BASHKIA VORË**

OBJEKTI:
"NDERTIMI I KANALIT DOMJE DHE NDRICIMI RRUGES"

Emertimi: PLANIMETRIA KUB

 **"ARABEL - STUDIO" Sh.p.k**
Adresa: Njesia Bashkiake nr.7, Rruga "Frosina Plaku",
Pallati 21, Hyrja 1, Kati 2, Tirane.
Email: arabelstudio@gmail.com

Drejtimes i projektit

Adm. Ana NISHKU

Inxh. Ardi ARKAXHIU

Projektues

Nd. Ardi ARKAXHIU	Elek. Altin ALLKAJ
Ark.Rigert HYRA	Top. Mustafa HOXHAI
Gjeo.Irfan BEGAJ	Hid. Hajredin MURGU

SHKALLA	FLETA
SH- 1:500	4 - 05
Vorë 2018	Format A3

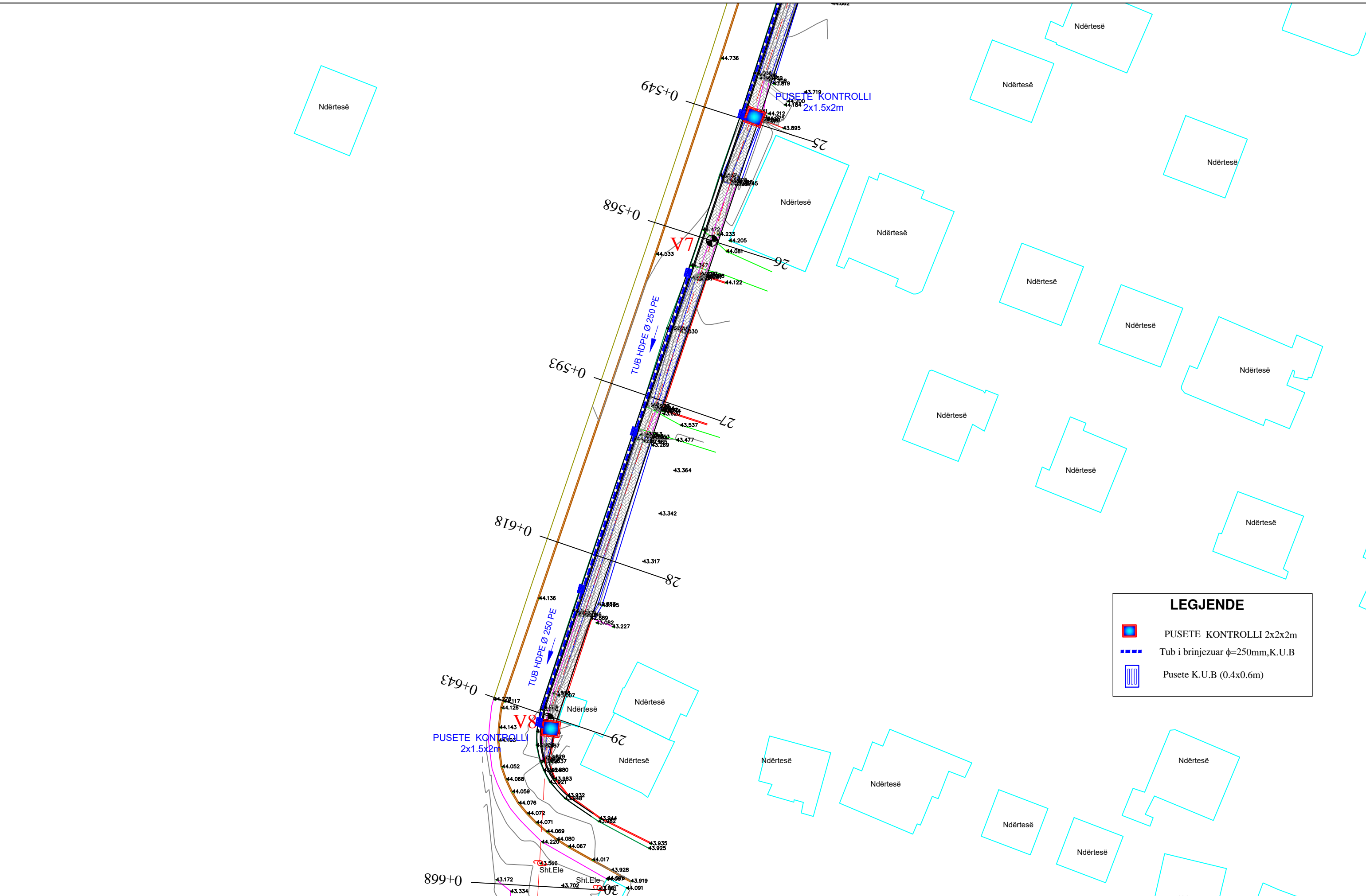

LEGJENDE	
	PUSETE KONTROLLI 2x2x2m
	Tub i brinjezuar $\phi=250\text{mm}$, K.U.B
	Pusete K.U.B (0.4x0.6m)



POROSITESI : BASHKIA VORË

OBJEKTI:
"NDERTIMI I KANALIT DOMJE DHE NDRICIMI RRUGES"

Emertimi: PLANIMETRIA KUB



"ARABEL - STUDIO" Sh.p.k
Adresa: Njesia Bashkiake nr.7, Rruga "Frosina Plaku",
Pallati 21, Hyrja 1, Kati 2, Tirane.
Email: arabelstudio@gmail.com

Drejtes i projektit

Adm. Ana NISHKU
Inxh. Ardi ARKAXHIU

Projektues

Nd. Ardi ARKAXHIU	Elek. Altin ALLKAJ
Ark.Rigert HYRA	Top. Mustafa HOXHAJ
Gjeo.Irfan BEGAJ	Hid. Hajredin MURGU

SHKALLA FLETA

SH- 1:500	4 - 06
Vorë 2018	Format A3

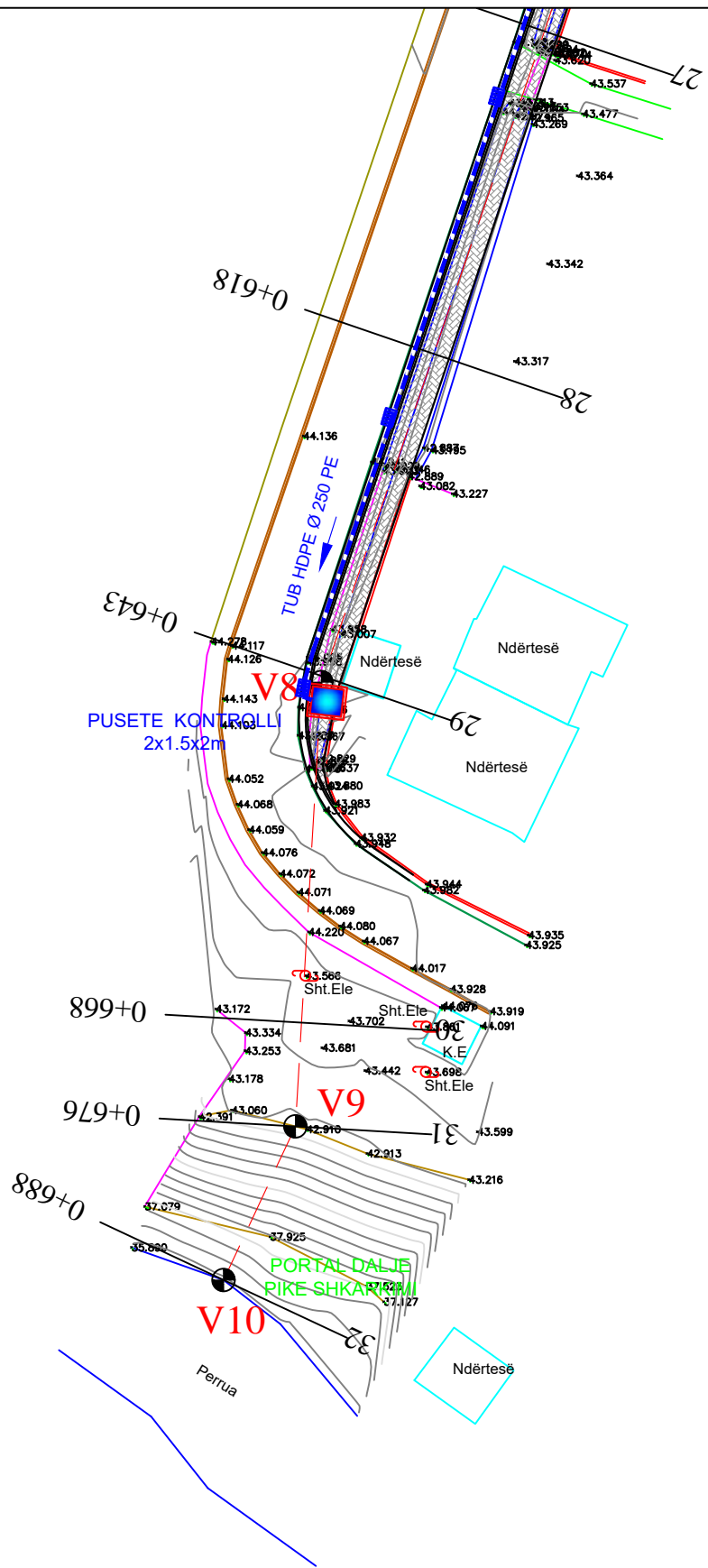

LEGJENDE	
	PUSETE KONTROLLI 2x2x2m
	Tub i brinjezuar $\phi=250\text{mm}$, K.U.B
	Pusete K.U.B (0.4x0.6m)



POROSITESI : BASHKIA VORË

OBJEKTI:
"NDERTIMI I KANALIT DOMJE DHE NDRICIMI RRUGES"

Emertimi: PLANIMETRIA KUB



"ARABEL - STUDIO" Sh.p.k
Adresa: Njesia Bashkiake nr.7, Rruga "Frosina Plaku",
Pallati 21, Hyrja 1, Kati 2, Tirane.
Email: arabelstudio@gmail.com

Drejtesues i projektit

Adm. Ana NISHKU

Inxh. Ardi ARKAXHIU

Projektues

Nd. Ardi ARKAXHIU

Ark.Rigert HYRA

Gjeo.Irfan BEGAJ

Elek. Altin ALLKAJ

Top. Mustafa HOXHAI

Hid. Hajredin MURGU

SHKALLA

SH- 1:500

Vorë 2018

FLETA

4 - 07

Format A3



REPUBLIKA E SHQIPERISË
BASHKIA VORË

PROJEKT ZBATIMI

OBJEKTI:
"NDERTIMI I KANALIT DOMJE DHE NDRICIMI RRUGES"
BASHKIA VORË

4.1.PLANIMETRIA NDRICIMIT RRUGES



POROSITESI : BASHKIA VORË

OBJEKTI:
"NDERTIMI I KANALIT DOMJE DHE NDRICIMI RRUGES"

Emertimi: PLANIMETRIA NDRICIMIT



"ARABEL - STUDIO" Sh.p.k
Adresa:Njesia Bashkiake nr.7, Rruga "Frosina Plaku",
Pallati 21, Hyrja 1, Kati 2,Tirane.
Email: arabelstudio@gmail.com

Drejtues i projektit

Adm. Ana NISHKU

Inxh. Ardi ARKAXHIU

Projektues

Nd. Ardi ARKAXHIU

Ark.Rigert HYRA

Gjeo.Irfan BEGAJ

Elek. Altin ALLKAJ

Top. Mustafa HOXHAJ

Hid. Hajredin MURGU

SHKALLA

-

Vorë 2018



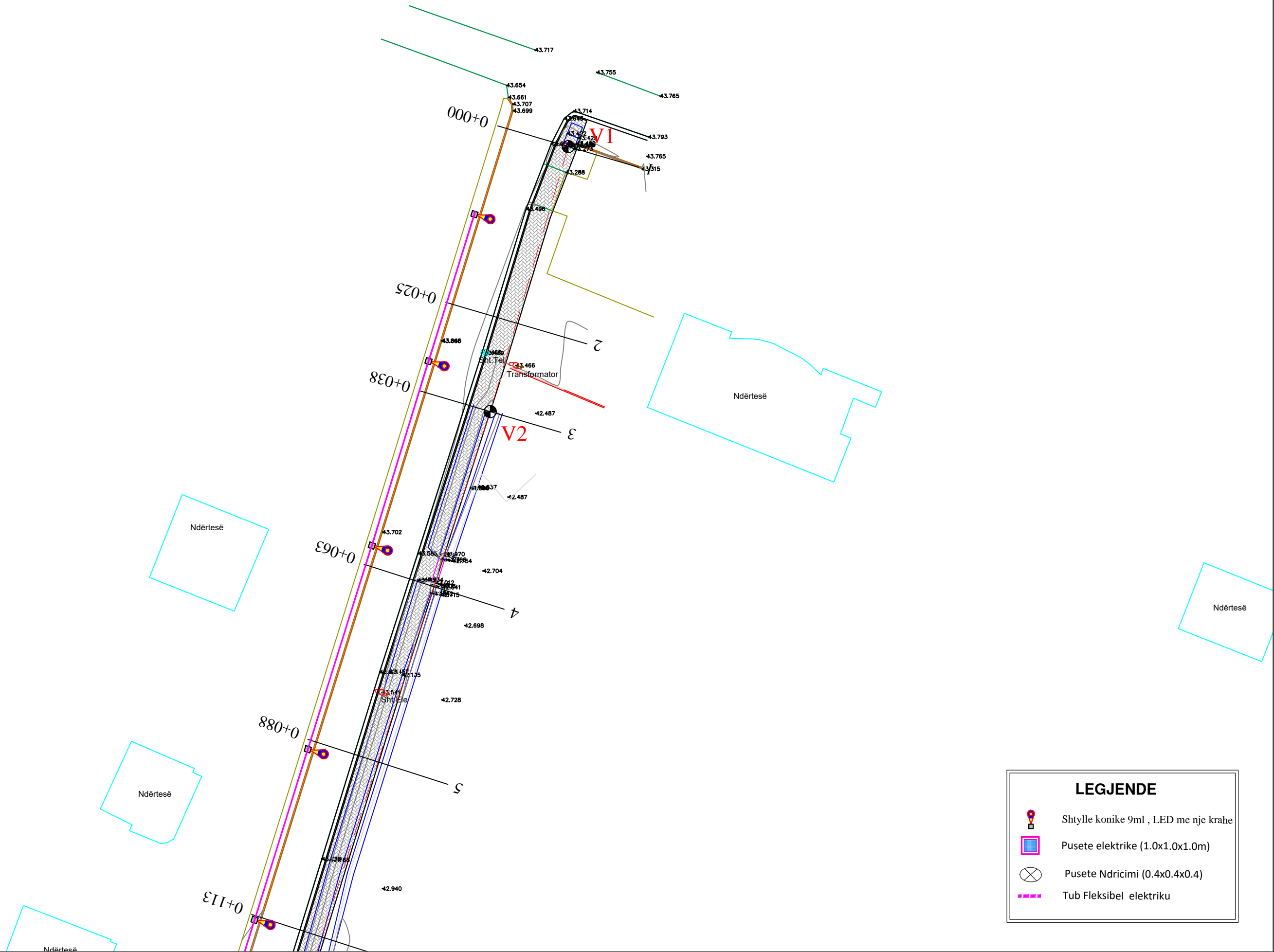

FLETA

4.1 - 00

Format A3



LEGJENDE

-  Shtylle konike 9ml , LED me nje krahe
-  Pusete elektrike (1.0x1.0x1.0m)
-  Pusete Ndricimi (0.4x0.4x0.4)
-  Tub Fleksibel elektriku



POROSITESI : BASHKIA VORË

OBJEKTI:
"NDERTIMI I KANALIT DOMJE DHE NDRICIMI RRUGES"

Emertimi: PLANIMETRIA NDRICIMIT



"ARABEL - STUDIO" Sh.p.k
Adresa: Njesia Bashkiake nr.7, Rruga "Frosina Plaku",
Pallati 21, Hyrja 1, Kati 2, Tirane.
Email: arabelstudio@gmail.com

Drejtimes i projektit

Adm. Ana NISHKU
Inxh. Ardi ARKAXHIU

Projektues

Nd. Ardi ARKAXHIU
Ark.Rigert HYRA
Gjeo.Irfan BEGAJ
Elek. Altin ALLKAJ
Top. Mustafa HOXHAJ
Hid. Hajredin MURGU

SHKALLA

SH- 1:500

Vorë 2018

FLETA

4 - 01

Format A3

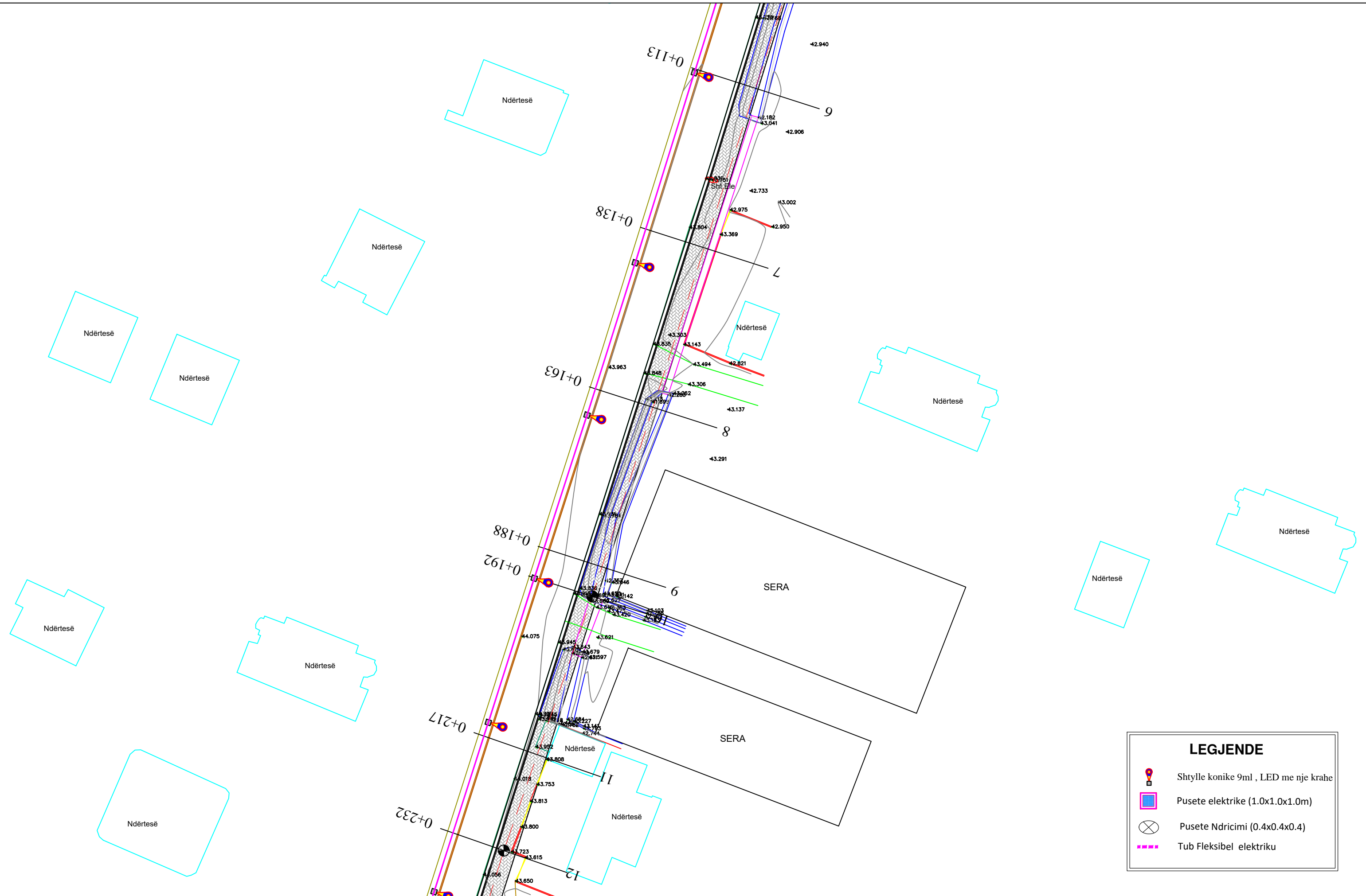

LEGJENDE	
	Shtylle konike 9m1 , LED me nje krahe
	Pusete elektrike (1.0x1.0x1.0m)
	Pusete Ndricimi (0.4x0.4x0.4)
	Tub Fleksibel elektriku



POROSITESI : BASHKIA VORË

OBJEKTI:
"NDERTIMI I KANALIT DOMJE DHE NDRICIMI RRUGES"

Emertimi: PLANIMETRIA NDRICIMIT

"ARABEL - STUDIO" Sh.p.k
Adresa: Njesia Bashkiake nr.7, Rruga "Frosina Plaku",
Pallati 21, Hyrja 1, Kati 2, Tirane.
Email: arabelstudio@gmail.com

Drejtuues i projektit

Adm. Ana NISHKU

Inxh. Ardi ARKAXHIU

Projektues

Nd. Ardi ARKAXHIU	Elek. Altin ALLKAJ
Ark.Rigert HYRA	Top. Mustafa HOXHAI
Gjeo.Irfan BEGAJ	Hid. Hajredin MURGU

SHKALLA	FLETA
SH- 1:500	4 - 01
Vorë 2018	Format A3

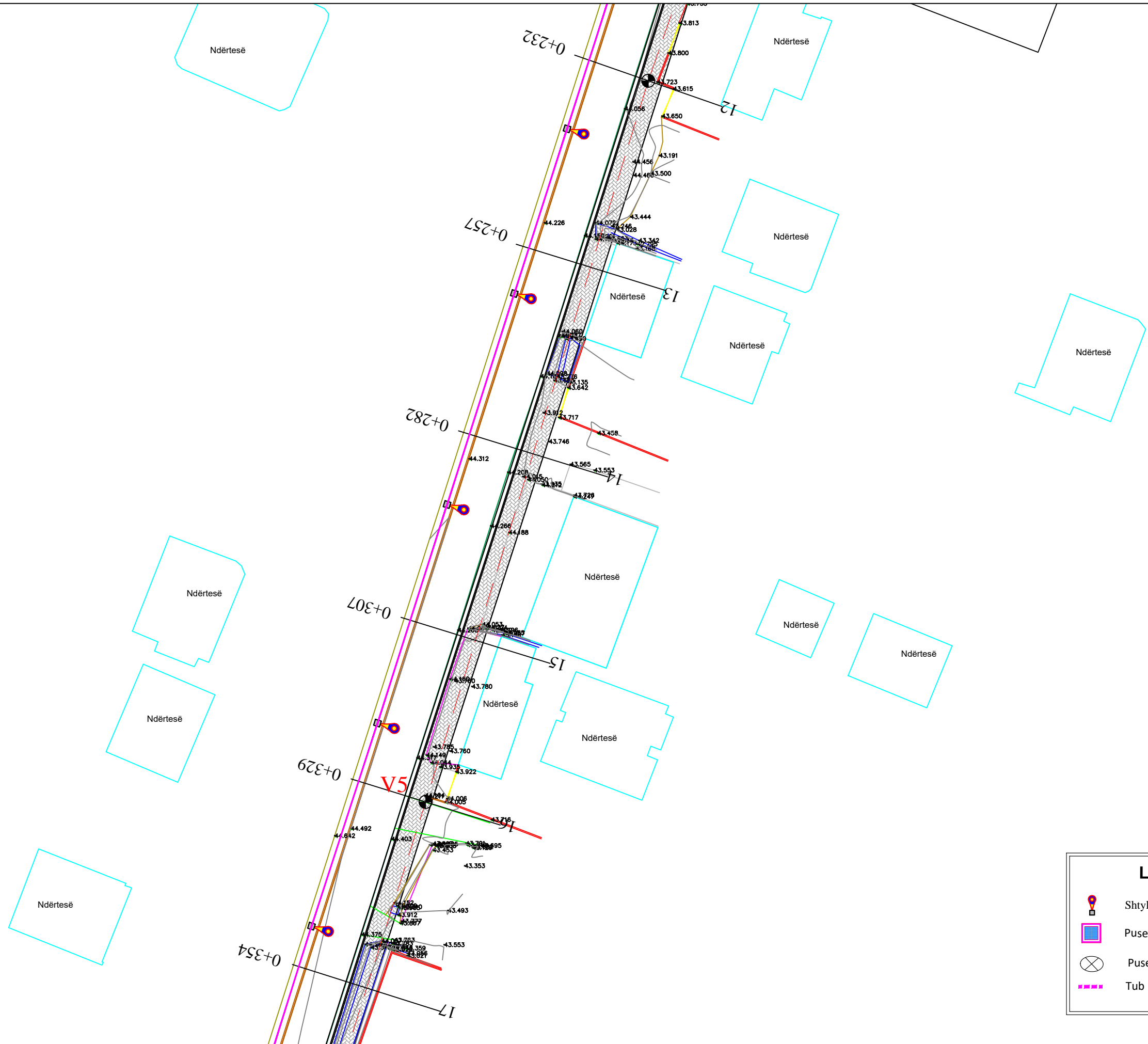

LEGJENDE	
	Shtylle konike 9m1 , LED me nje krahe
	Pusete elektrike (1.0x1.0x1.0m)
	Pusete Ndricimi (0.4x0.4x0.4)
	Tub Fleksibel elektriku



POROSITESI : BASHKIA VORË

OBJEKTI:
"NDERTIMI I KANALIT DOMJE DHE NDRICIMI RRUGES"

Emertimi: PLANIMETRIA NDRICIMIT

"ARABEL - STUDIO" Sh.p.k
Adresa: Njesia Bashkiake nr.7, Rruga "Frosina Plaku",
Pallati 21, Hyrja 1, Kati 2, Tirane.
Email: arabelstudio@gmail.com

Drejtesues i projektit

Adm. Ana NISHKU
Inxh. Ardi ARKAXHIU

Projektues

Nd. Ardi ARKAXHIU
Ark.Rigert HYRA
Gjeo.Irfan BEGAJ

Elek. Altin ALLKAJ
Top. Mustafa HOXHAI
Hid. Hajredin MURGU

SHKALLA	FLETA
SH- 1:500	4 - 01
Vorë 2018	Format A3

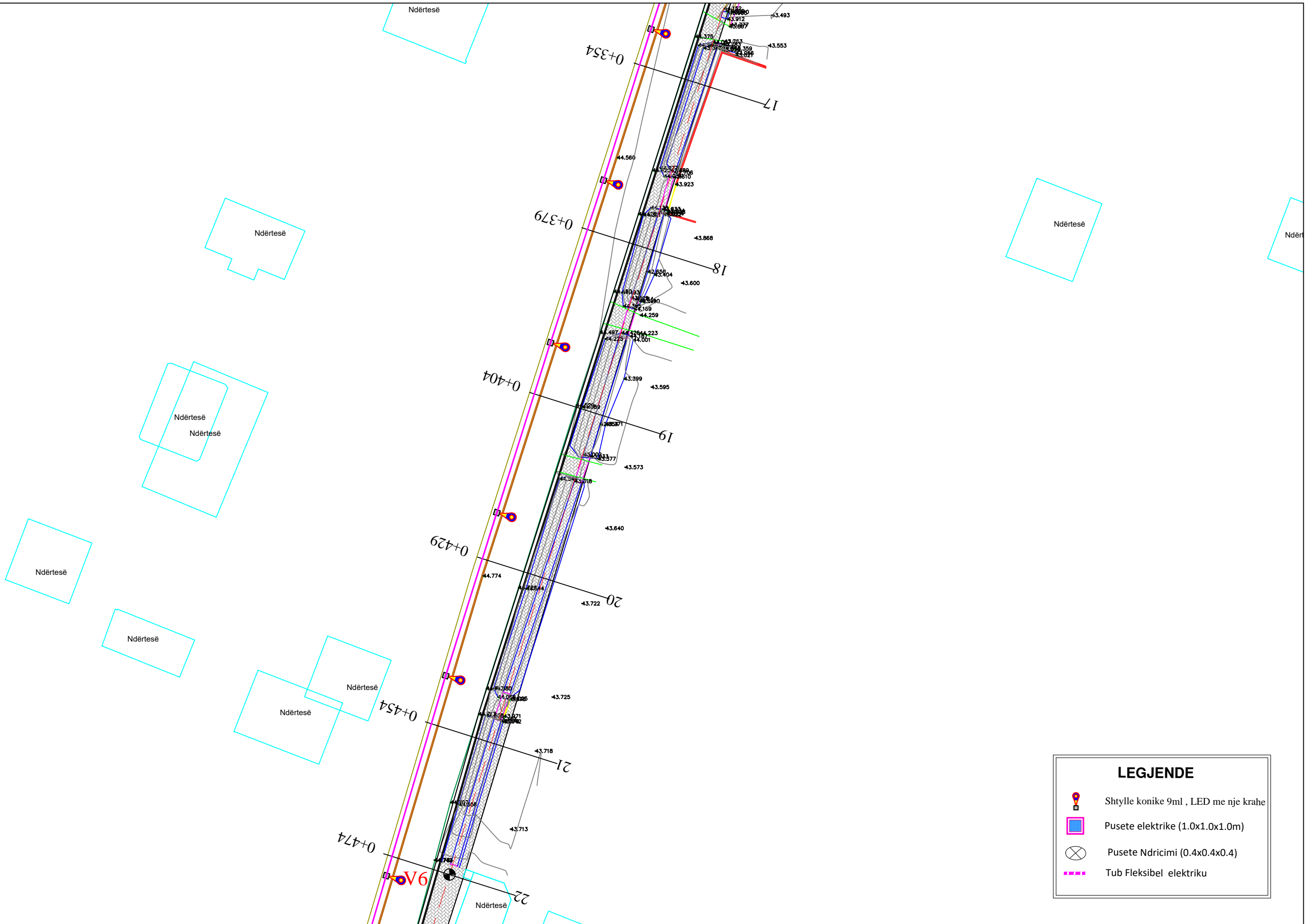



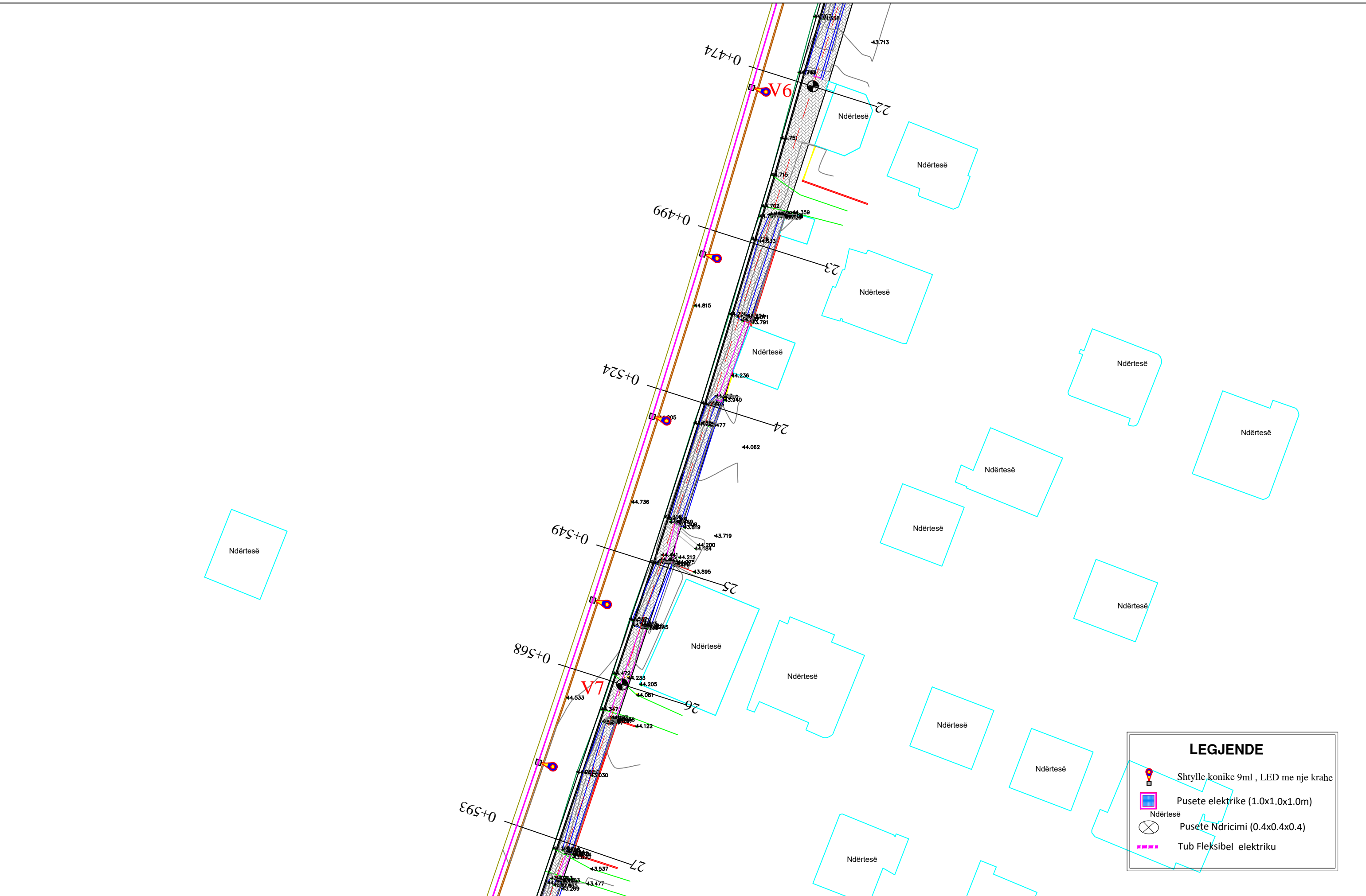

LEGJENDE	
	Shtylle konike 9ml , LED me nje krahe
	Pusete elektrike (1.0x1.0x1.0m)
	Pusete Ndricimi (0.4x0.4x0.4)
	Tub Fleksibel elektriku

 POROSITESI : BASHKIA VORË	Emertimi: PLANIMETRIA NDRICIMIT "ARABEL - STUDIO" Sh.p.k Adresa: Njesia Bashkiake nr.7, Rruga "Frosina Plaku", Pallati 21, Hyrja 1, Kati 2, Tirane. Email: arabelstudio@gmail.com		Drejtues i projektit Adm. Ana NISHKU Inxh. Ardi ARKAXHIU		Projektues Nd. Ardi ARKAXHIU Ark.Rigert HYRA Gjeo.Irfan BEGAJ Elek. Altin ALLKAJ Top. Mustafa HOXHAI Hid. Hajredin MURGU		SHKALLA SH- 1:500 Vorë 2018	FLETA 4 - 01 Format A3
	OBJEKTI: "NDERTIMI I KANALIT DOMJE DHE NDRICIMI RRUGES"							



LEGJENDE

-  Shtyllë konike 9m , LED me nje krahe
-  Pusete elektrike (1.0x1.0x1.0m)
-  Pusete Ndricimi (0.4x0.4x0.4)
-  Tub Fleksibel elektriku



POROSITESI : BASHKIA VORË

OBJEKTI:
"NDERTIMI I KANALIT DOMJE DHE NDRICIMI RRUGES"

Emertimi: PLANIMETRIA NDRICIMIT

"ARABEL - STUDIO" Sh.p.k
Adresa: Njesia Bashkiake nr.7, Rruga "Frosina Plaku",
Pallati 21, Hyrja 1, Kati 2, Tirane.
Email: arabelstudio@gmail.com

Drejtuës i projektit

Adm. Ana NISHKU
Inxh. Ardi ARKAXHIU

Projektues

Nd. Ardi ARKAXHIU	Elek. Altin ALLKAJ
Ark.Rigert HYRA	Top. Mustafa HOXHAJ
Gjeo.Irfan BEGAJ	Hid. Hajredin MURGU

SHKALLA	FLETA
SH- 1:500	4 - 01
Vorë 2018	Format A3

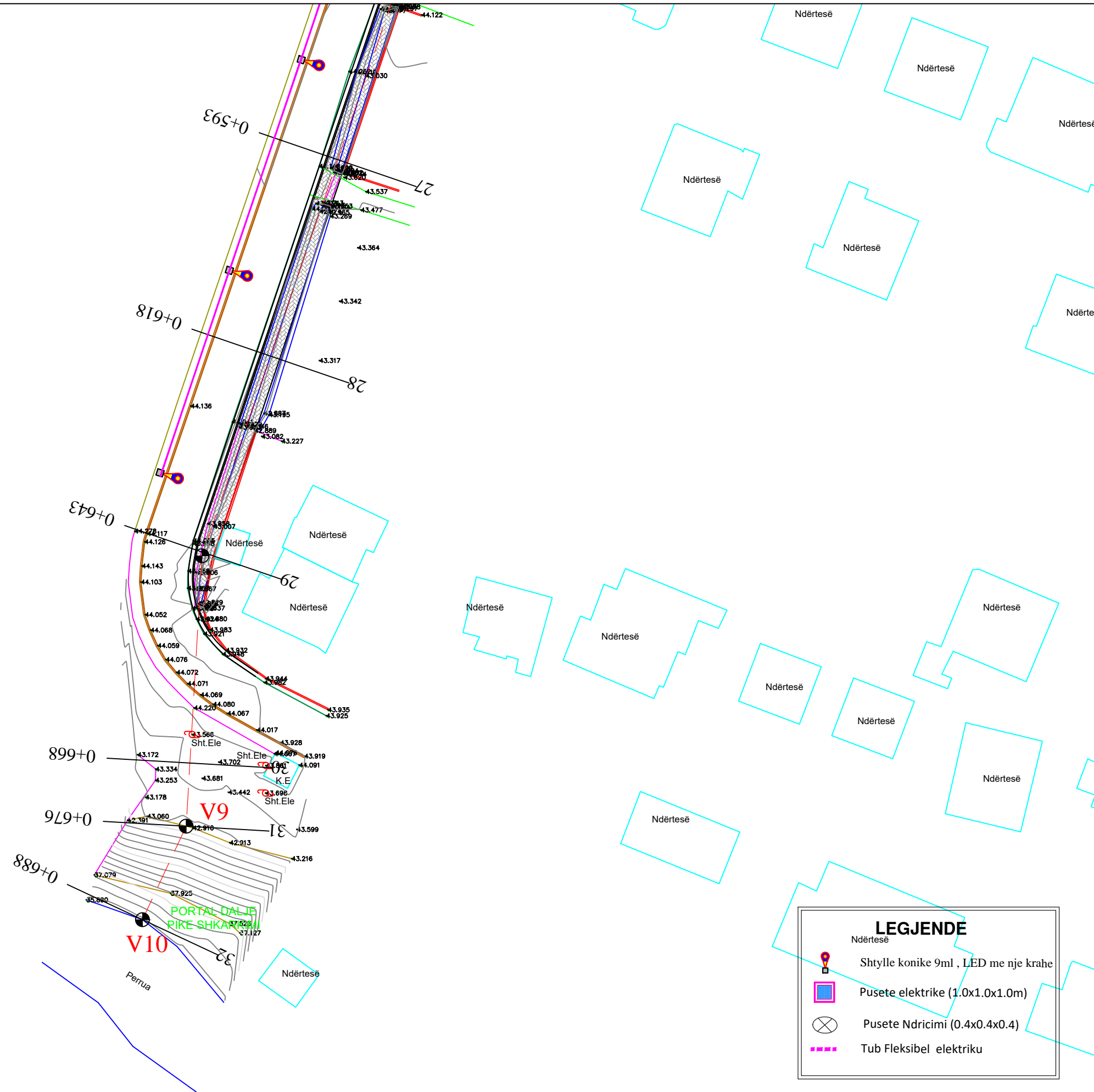

LEGJENDE

- Ndertesë
- Shtylle konike 9ml , LED me nje krahe
- Pusete elektrike (1.0x1.0x1.0m)
- Pusete Ndricimi (0.4x0.4x0.4)
- Tub Fleksibel elektrik



POROSITESI : BASHKIA VORË

OBJEKTI:
"NDERTIMI I KANALIT DOMJE DHE NDRICIMI RRUGES"

Emertimi: PLANIMETRIA NDRICIMIT

"ARABEL - STUDIO" Sh.p.k
Adresa:Njesia Bashkiake nr.7, Rruga "Frosina Plaku",
Pallati 21, Hyrja 1, Kati 2,Tirane.
Email: arabelstudio@gmail.com

Drejtuues i projektit

Adm. Ana NISHKU

Inxh. Ardi ARKAXHIU

Projektues

Nd. Ardi ARKAXHIU	Elek. Altin ALLKAJ
Ark.Rigert HYRA	Top. Mustafa HOXHAJ
Gjeo.Irfan BEGAJ	Hid. Hajredin MURGU

SHKALLA	FLETA
SH- 1:500	4 - 01
Vorë 2018	Format A3



REPUBLIKA E SHQIPERISË
BASHKIA VORË

PROJEKT ZBATIMI

OBJEKTI:
"NDERTIMI I KANALIT DOMJE DHE NDRICIMI RRUGES"
BASHKIA VORË

4.2.PLANIMETRIA E SINJALISTIKES



POROSITESI : BASHKIA VORË

OBJEKTI:
"NDERTIMI I KANALIT DOMJE DHE NDRICIMI RRUGES"

Emertimi: PLANIMETRIA SINJALISTIKES



"ARABEL - STUDIO" Sh.p.k
Adresa:Njesia Bashkiake nr.7, Rruga "Frosina Plaku",
Pallati 21, Hyrja 1, Kati 2,Tirane.
Email: arabelstudio@gmail.com

Drejtues i projektit

Adm. Ana NISHKU

Inxh. Ardi ARKAXHIU

Projektues

Nd. Ardi ARKAXHIU

Ark.Rigert HYRA

Gjeo.Irfan BEGAJ

Elek. Altin ALLKAJ

Top. Mustafa HOXHAJ

Hid. Hajredin MURGU

SHKALLA

-

Vorë 2018

FLETA

4.2 - 00

Format A3

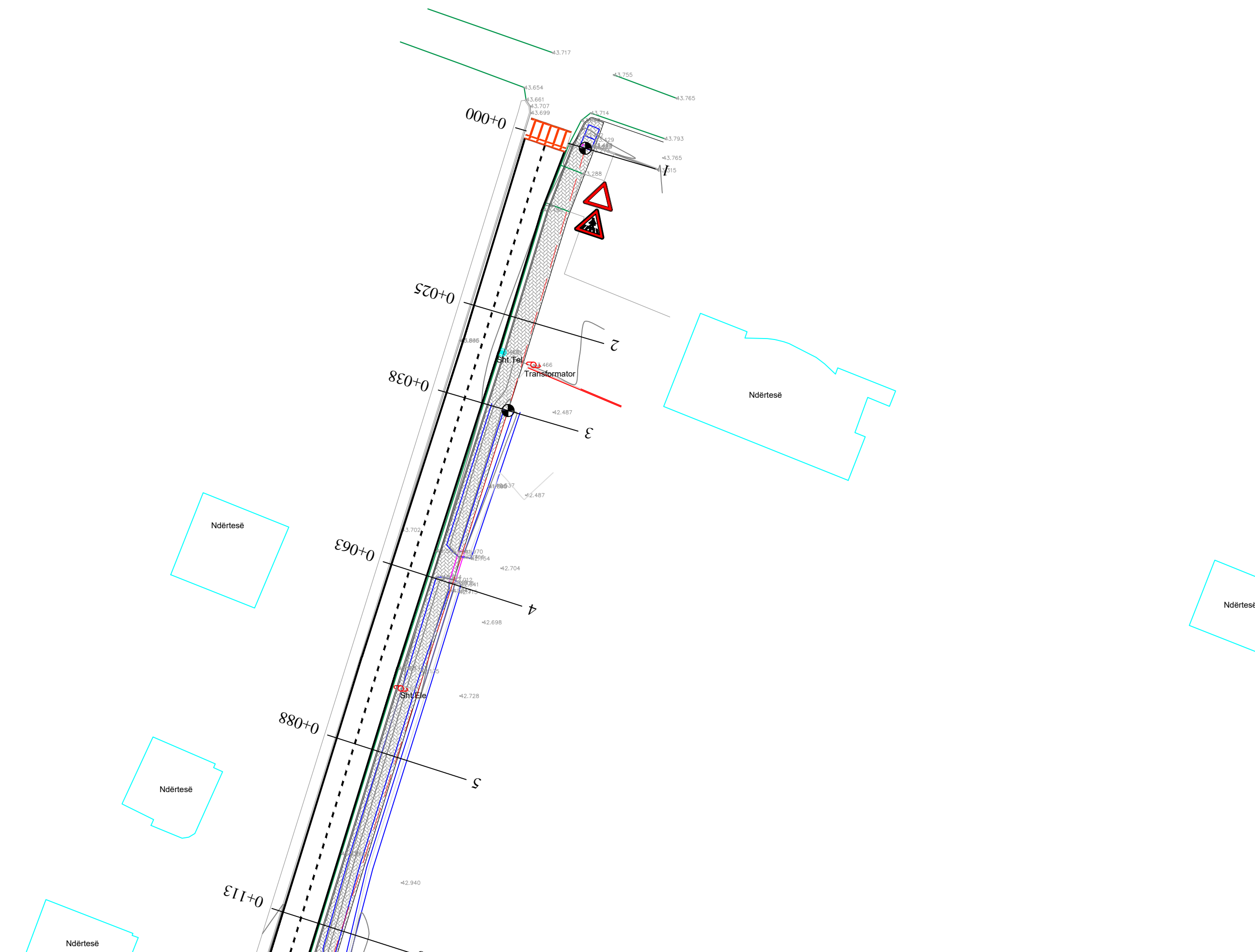

POROSITESI : BASHKIA VORË

OBJEKTI:
"NDERTIMI I KANALIT DOMJE DHE NDRICIMI RRUGES"

Emertimi: PLANIMETRIA SINJALISTIKES



"ARABEL - STUDIO" Sh.p.k
Adresa: Njesia Bashkiake nr.7, Rruga "Frosina Plaku",
Pallati 21, Hyrja 1, Kati 2, Tirane.
Email: arabelstudio@gmail.com

Drejtesues i projektit

Adm. Ana NISHKU
Inxh. Ardi ARKAXHIU

Projektues

Nd. Ardi ARKAXHIU
Ark. Rigert HYRA
Gjeo. Ifan BEGAJ
Elek. Altin ALLKAJ
Top. Mustafa HOXHAJ
Hid. Hajredin MURGU

SHKALLA FLETA

SH- 1:500 4 - 01
Vorë 2018 Format A3

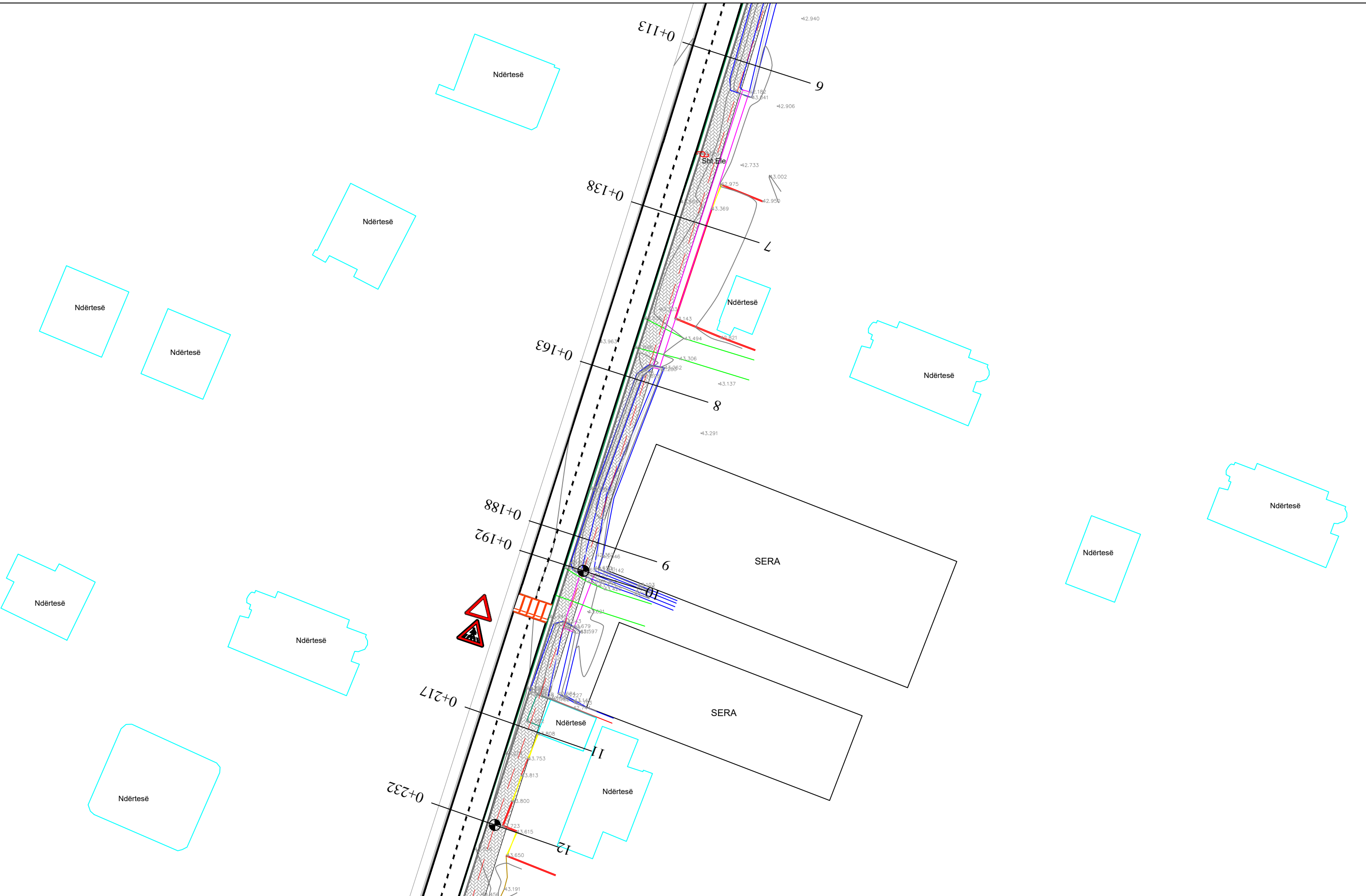

POROSITESI : BASHKIA VORË

OBJEKTI:
"NDERTIMI I KANALIT DOMJE DHE NDRICIMI RRUGES"

Emertimi: PLANIMETRIA SINJALISTIKES



"ARABEL - STUDIO" Sh.p.k
Adresa: Njesia Bashkiake nr.7, Rruga "Frosina Plaku",
Pallati 21, Hyrja 1, Kati 2, Tirane.
Email: arabelstudio@gmail.com

Drejtuues i projektit

Adm. Ana NISHKU
Inxh. Ardi ARKAXHIU

Projektues

Nd. Ardi ARKAXHIU
Ark. Rigert HYRA
Gjeo. Ifan BEGAJ
Elek. Altin ALLKAJ
Top. Mustafa HOXHAI
Hid. Hajredin MURGU

SHKALLA

SH- 1:500

Vorë 2018

FLETA

4 - 02

Format A3



POROSITESI : BASHKIA VORË

OBJEKTI:
"NDERTIMI I KANALIT DOMJE DHE NDRICIMI RRUGES"

Emertimi: PLANIMETRIA SINJALISTIKES



"ARABEL - STUDIO" Sh.p.k
Adresa: Njesia Bashkiake nr.7, Rruga "Frosina Plaku",
Pallati 21, Hyrja 1, Kati 2, Tirane.
Email: arabelstudio@gmail.com

Drejtuues i projektit

Adm. Ana NISHKU
Inxh. Ardi ARKAXHIU

Projektues

Nd. Ardi ARKAXHIU
Ark.Rigert HYRA
Gjeo.Irfan BEGAJ
Elek. Altin ALLKAJ
Top. Mustafa HOXHAI
Hid. Hajredin MURGU

SHKALLA

SH- 1:500
Vorë 2018

FLETA

4 - 03
Format A3

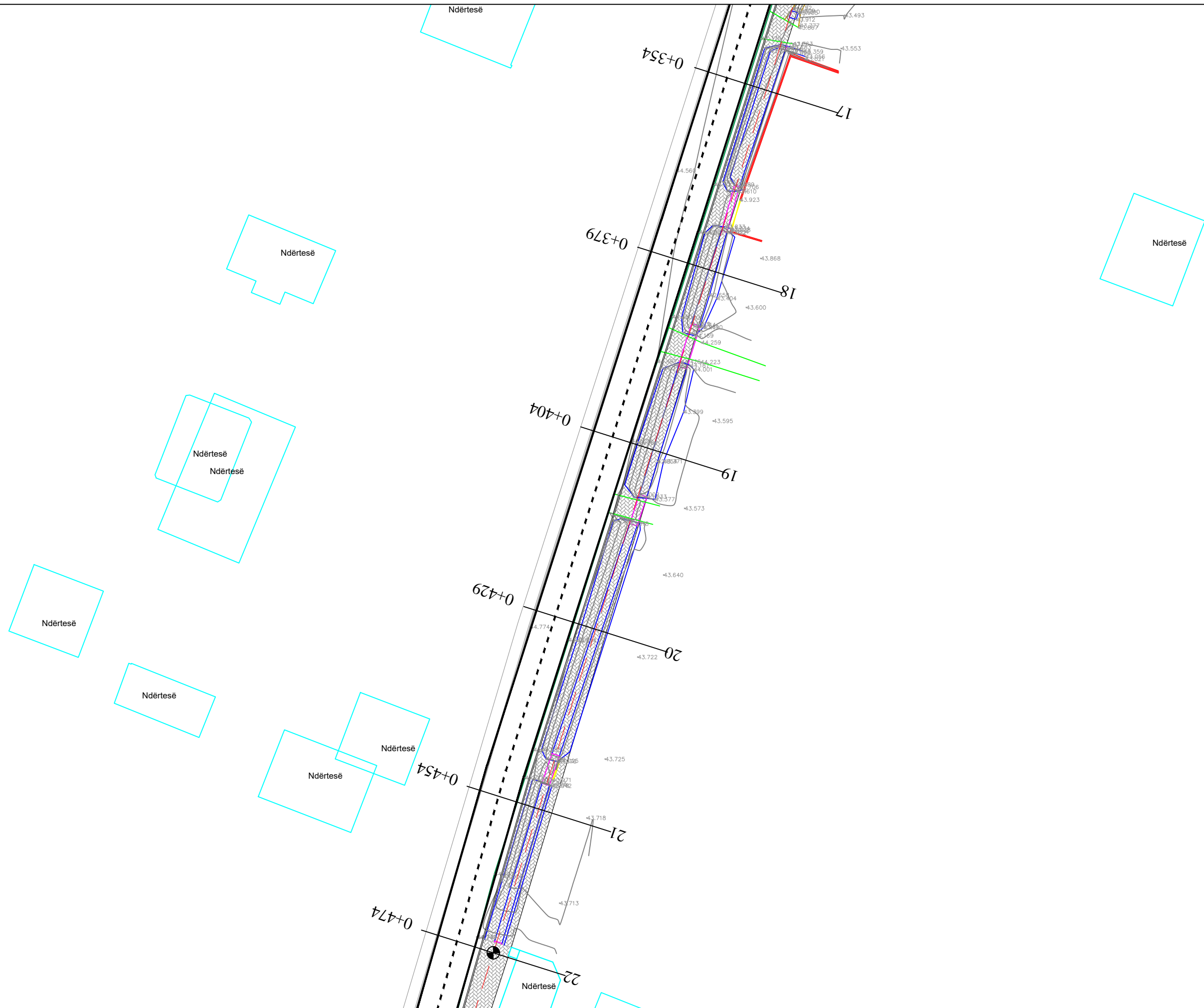

POROSITESI : BASHKIA VORË

OBJEKTI:
"NDERTIMI I KANALIT DOMJE DHE NDRICIMI RRUGES"

Emertimi: PLANIMETRIA SINJALISTIKES



"ARABEL - STUDIO" Sh.p.k
Adresa: Njesia Bashkiake nr.7, Rruga "Frosina Plaku",
Pallati 21, Hyrja 1, Kati 2, Tirane.
Email: arabelstudio@gmail.com

Drejtues i projektit

Adm. Ana NISHKU

Inxh. Ardi ARKAXHIU

Projektues

Nd. Ardi ARKAXHIU

Ark.Rigert HYRA

Gjeo.Irfan BEGAJ

Elek. Altin ALLKAJ

Top. Mustafa HOXHAI

Hid. Hajredin MURGU

SHKALLA

SH- 1:500

Vorë 2018

FLETA

4 - 04

Format A3

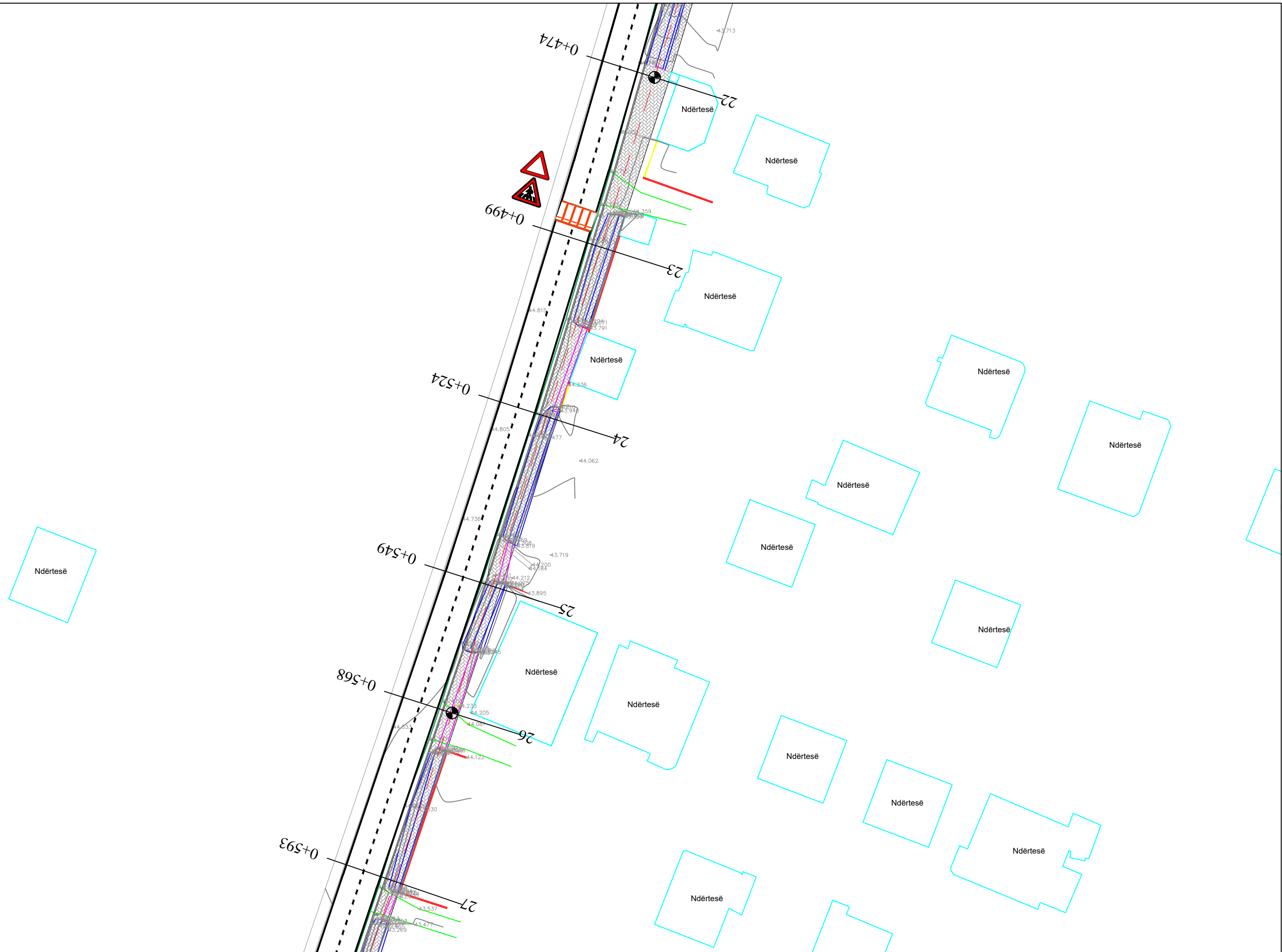

POROSITESI : BASHKIA VORË

OBJEKTI:
"NDERTIMI I KANALIT DOMJE DHE NDRICIMI RRUGES"

Emertimi: PLANIMETRIA SINJALISTIKES



"ARABEL - STUDIO" Sh.p.k
Adresa: Njesia Bashkiake nr.7, Rruga "Frosina Plaku",
Pallati 21, Hyrja 1, Kati 2, Tirane.
Email: arabelstudio@gmail.com

Drejtesues i projektit

Adm. Ana NISHKU

Inxh. Ardi ARKAXHIU

Projektues

Nd. Ardi ARKAXHIU

Ark.Rigert HYRA

Gjeo.Irfan BEGAJ

Elek. Altin ALLKAJ

Top. Mustafa HOXHAI

Hid. Hajredin MURGU

SHKALLA

SH- 1:500

Vorë 2018

FLETA

4 - 05

Format A3

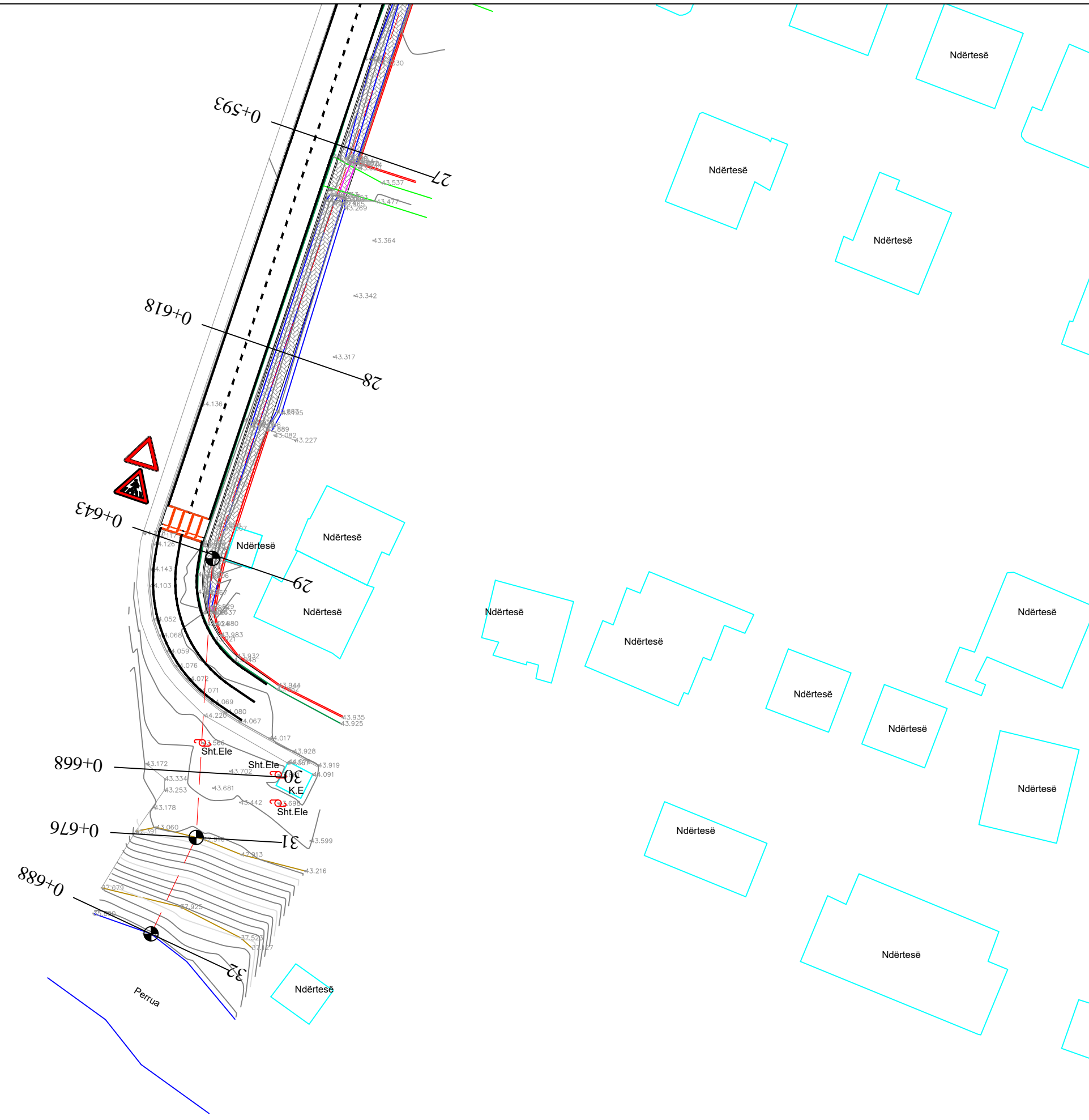

POROSITESI : BASHKIA VORË

OBJEKTI:
"NDERTIMI I KANALIT DOMJE DHE NDRICIMI RRUGES"

Emertimi: PLANIMETRIA SINJALISTIKES

"ARABEL - STUDIO" Sh.p.k
Adresa: Njesia Bashkiake nr.7, Rruga "Frosina Plaku",
Pallati 21, Hyrja 1, Kati 2, Tirane.
Email: arabelstudio@gmail.com

Drejtesues i projektit

Adm. Ana NISHKU
Inxh. Ardi ARKAXHIU

Projektues

Nd. Ardi ARKAXHIU
Ark.Rigert HYRA
Gjeo.Irfan BEGAJ

Elek. Altin ALLKAJ
Top. Mustafa HOXHAJ
Hid. Hajredin MURGU

SHKALLA
SH- 1:500
Vorë 2018

FLETA
4 - 06
Format A3



REPUBLIKA E SHQIPERISË
BASHKIA VORË

PROJEKT ZBATIMI

OBJEKTI:
"NDERTIMI I KANALIT DOMJE DHE NDRICIMI RRUGES"
BASHKIA VORË

5. PROFILI GJATESOR

	POROSITESI : BASHKIA VORË	Emertimi: PROFILI GJATESOR	Drejtues i projektit			Projektues			SHKALLA	FLETA
	OBJEKTI: "NDERTIMI I KANALIT DOMJE DHE NDRICIMI RRUGES"	 "ARABEL - STUDIO" Sh.p.k Adresa: Njesia Bashkiake nr.7, Rruga "Frosina Plaku", Pallati 21, Hyrja 1, Kati 2, Tirane. Email: arabelstudio@gmail.com	Adm. Ana NISHKU		Nd. Ardi ARKAXHIU		Elek. Altin ALLKAJ		-	5 - 00
			Inxh. Ardi ARKAXHIU		Ark.Rigert HYRA		Top. Mustafa HOXHAJ		Vorë 2018	Format A3
					Gjeo.Irfan BEGAJ		Hid. Hajredin MURGU			

D= -0.54
p= -0.08%
L= 679.03 m.

TOMBINO B/A Ø=1500 mm v= 1.18 m/s q= 1797 l/s

- LEGJENDA:
- VIJE TERRENI
 - VIJE GERMIMIT
 - TOMBINO Φ=1500
 - VIJE E ASFALTIT

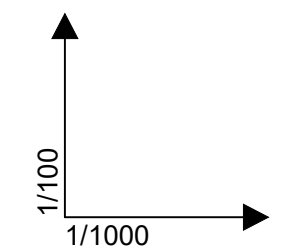

KUOTE REFERIMI

SEKSIONI	S1	S2	S3	S4	S5	S6	S7	S8	S9	S10	S11	S12	S13	S14	S15	S16
KUOTE TERRENI	41.55	43.38	41.88	41.97	42.15	42.27	42.59	41.81	42.29	42.74	43.90	43.89	44.13	43.92	43.15	44.20
KUOTE PROJEKTI	41.60	41.58	41.57	41.55	41.53	41.51	41.49	41.47	41.45	41.45	41.43	41.42	41.40	41.38	41.36	41.34
THELLESIA E GERMIMIT	-0.05	-1.80	-0.30	-0.42	-0.61	-0.76	-1.10	-0.34	-0.84	-1.30	-2.47	-2.48	-2.73	-2.54	-1.79	-2.86
DISTANCE PJESORE		25.00	12.55	25.00	25.00	25.00	25.00	25.00	4.63	25.00	15.16	25.00	25.00	25.00	21.66	25.00
DISTANCE PROGRESIVE	0.00	25.00	37.55	62.55	87.55	112.55	137.55	162.55	167.18	192.18	217.18	232.34	257.34	282.34	307.34	329.00



POROSITESI : BASHKIA VORË

OBJEKTI:
"NDERTIMI I KANALIT DOMJE DHE NDRICIMI RRUGES"

Emertimi: PROFILI GJATESOR



"ARABEL - STUDIO" Sh.p.k
Adresa: Njesia Bashkiake nr.7, Rruga "Frosina Plaku"
Pallati 21, Hyrja 1, Kati 2, Tirane.
Email: arabelstudio@gmail.com

Drejtues i projektit

Adm. Ana NISHKU
Inxh. Ardi ARKAXHIU

Projektues

Nd. Ardi ARKAXHIU
Ark.Rigert HYRA
Gjeo.Irfan BEGAJ

Elek. Altin ALLKAJ
Top. Mustafa HOXHAI
Hid. Hajredin MURGU

SHKALLA

H 1-1000
V 1-100

Vorë 2019

FLETA

5-01

Format A3

PJERRESIA 4
1:8%
03 m.

ELEMENTI HIDRAULIK TOMBINO B/A Ø=1500 mm v= 1.18 m/s q= 1797 l/s

LEGJENDA:
 — VIJE TERRENI
 — VIJE GERMIMIT
 — TOMBINO Ø=1500
 — VIJE E ASFALTIT

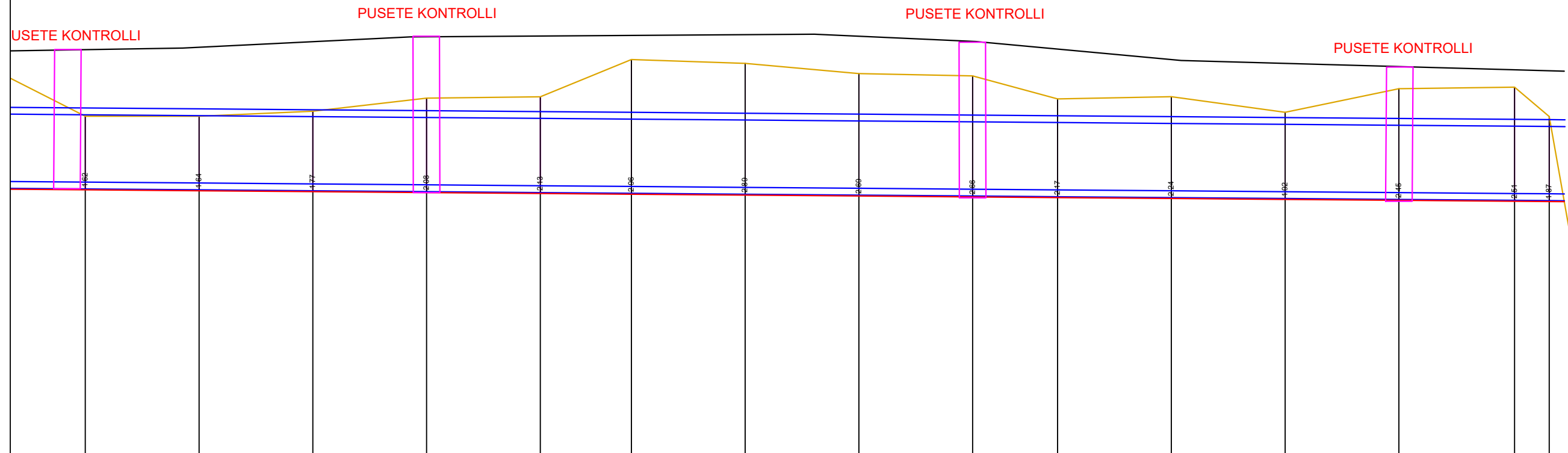

KUOTE REFERIMI	S17	S18	S19	S20	S21	S22	S23	S24	S25	S26	S27	S28	S29	S30	S31	S32
SEKSIONI	S17	S18	S19	S20	S21	S22	S23	S24	S25	S26	S27	S28	S29	S30	S31	S32
KUOTE TERRENI	42.94	42.94	43.05	43.34	43.37	44.19	44.10	43.88	43.83	43.32	43.37	43.02	43.54	43.58	42.93	35.89
KUOTE PROJEKTI	41.32	41.30	41.28	41.26	41.24	41.22	41.20	41.18	41.16	41.15	41.13	41.11	41.09	41.07	41.06	
THELLESIA E GERMIMIT	-1.62	-1.64	-1.77	-2.08	-2.13	-2.96	-2.89	-2.69	-2.66	-2.17	-2.24	-1.92	-2.45	-2.51	-1.87	
DISTANCE PJESORE	25.00	25.00	25.00	25.00	25.00	20.01	25.00	25.00	25.00	18.67	25.00	25.00	25.00	25.43	7.62	12.43
DISTANCE PROGRESIVE	354.00	379.00	404.00	429.00	454.00	474.01	499.01	524.01	549.01	567.68	592.68	617.68	642.68	668.11	675.73	688.16

 POROSITESI : BASHKIA VORË OBJEKTI: "NDERTIMI I KANALIT DOMJE DHE NDRICIMI RRUGES"	Emertimi: PROFILI GJATESOR  "ARABEL - STUDIO" Sh.p.k Adresa: Njesia Bashkiake nr.7, Rruga "Frosina Plaku", Pallati 21, Hyrja 1, Kati 2, Tirane. Email: arabelstudio@gmail.com	Drejtues i projektit Adm. Ana NISHKU Inxh. Ardi ARKAXHIU	Projektues Nd. Ardi ARKAXHIU Ark.Rigert HYRA Gjeo.Irfan BEGAJ Elek. Altin ALLKAJ Top. Mustafa HOXHAI Hid. Hajredin MURGU	SHKALLA H 1-1000 V 1-100 Vorë 2019	FLETA 5-02 Format A3
-----------------------------------------------------------------------------------------------------------------------------------------------------------------------------------	--------------------------------------------------------------------------------------------------------------------------------------------------------------------------------------------------------------------------------------------------------------------------------------	----------------------------------------------------------------	--------------------------------------------------------------------------------------------------------------------------------------------	---------------------------------------------	----------------------------



REPUBLIKA E SHQIPERISË
BASHKIA VORË

PROJEKT ZBATIMI

OBJEKTI:
"NDERTIMI I KANALIT DOMJE DHE NDRICIMI RRUGES"
BASHKIA VORË

6. SEKSIONI TERTHOR TIP



POROSITESI : BASHKIA VORË

OBJEKTI:
"NDERTIMI I KANALIT DOMJE DHE NDRICIMI RRUGES"



Emertimi: SEKSIONI TIP

"ARABEL - STUDIO" Sh.p.k

Adresa: Njesia Bashkiake nr.7, Rruga "Frosina Plaku",
Pallati 21, Hyrja 1, Kati 2, Tirane.
Email: arabelstudio@gmail.com

Drejtuues i projektit

Adm. Ana NISHKU

Inxh. Ardi ARKAXHIU

Projektues

Nd. Ardi ARKAXHIU

Ark.Rigert HYRA

Gjeo.Irfan BEGAJ

Elek. Altin ALLKAJ

Top. Mustafa HOXHAI

Hid. Hajredin MURGU

SHKALLA

-

Vorë 2018

FLETA

6 - 00

Format A3

PROFIL TERTHORE TIP SH-1:50

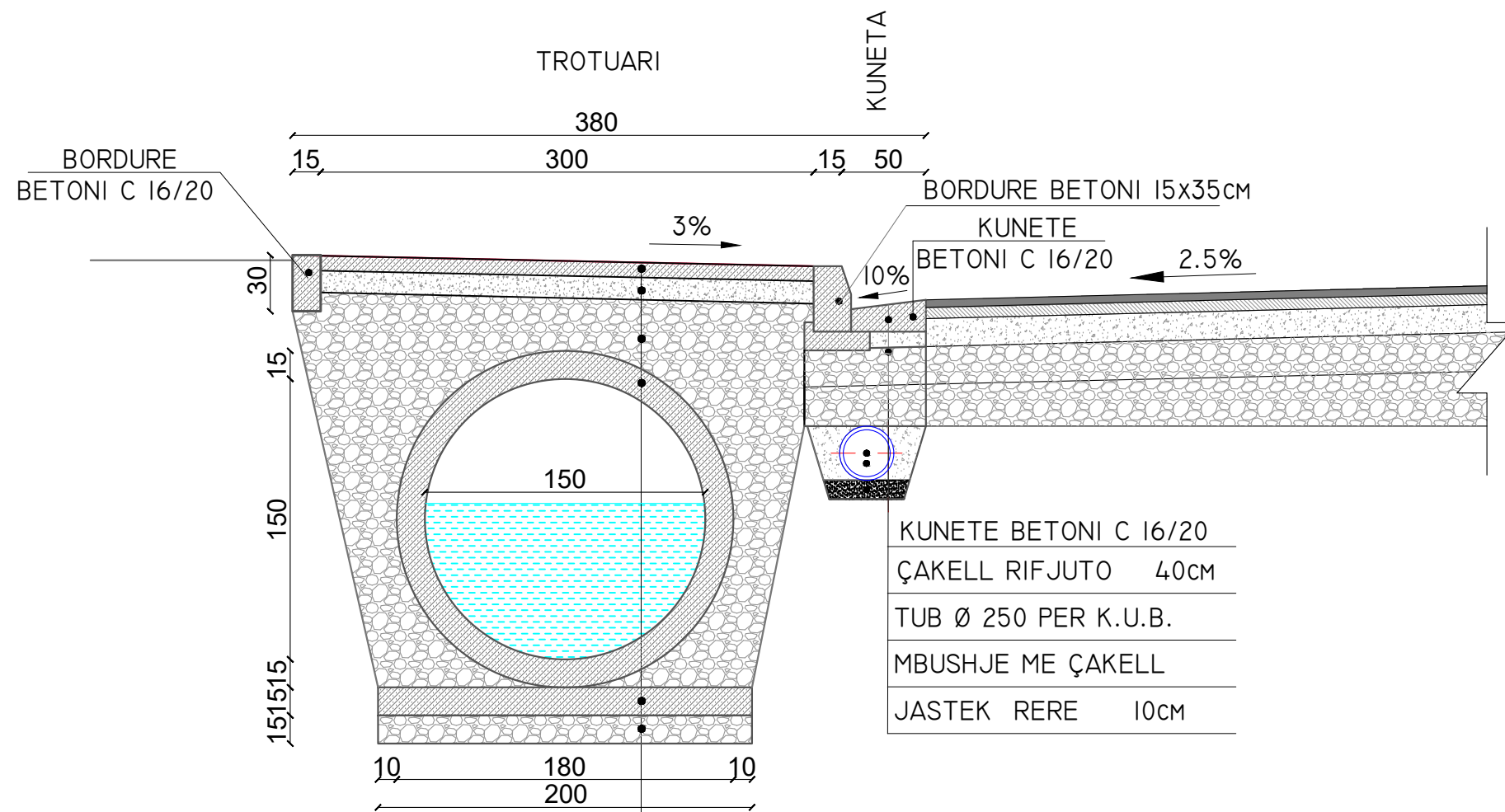

KUNETE BETONI C 16/20	
ÇAKELL RIFJUTO	40cm
TUB Ø 250 PER K.U.B.	
MBUSHJE ME ÇAKELL	
JASTEK RERE	10cm

TROTUAR, ME 6 CM BETON, ME LLUSTER 6CM	
ÇAKELL RIFJUTO	10cm
MBUSHJE ME ÇAKELL	VAR
TOMBINO B/A FI500MM	
SHTRESE BETONI C 16/20	15cm
ÇAKELL RIFJUTO	10cm

PROFIL TERTHORE TIP

Riparime Rrugeve me Asfalt

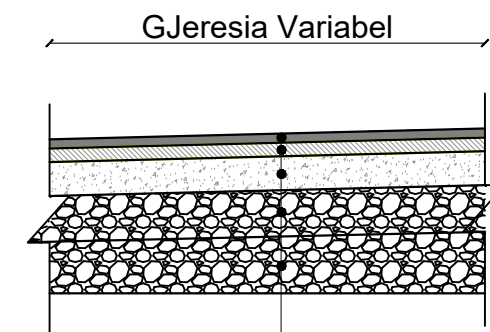

SHTRESE ASFALTOBETONI	4cm
SHTRESE BINDERI	6cm
SHTRESE STABILIZANTI	15cm
ÇAKELL MAKINERIE	20cm
ÇAKELL GUR KAVE	30cm



POROSITESI : BASHKIA VORË

OBJEKTI:
"NDERTIMI I KANALIT DOMJE DHE NDRICIMI RRUGES"



Emertimi: SEKSIONI TIP

"ARABEL - STUDIO" Sh.p.k

Adresa: Njesia Bashkiake nr.7, Rruga "Frosina Plaku",
Pallati 21, Hyrja 1, Kati 2, Tirane.
Email: arabelstudio@gmail.com

Drejtesues i projektit

Adm. Ana NISHKU

Inxh. Ardi ARKAXHIU

Projektues

Nd. Ardi ARKAXHIU

Ark.Rigert HYRA

Gjeo.Irfan BEGAJ

Elek. Altin ALLKAJ

Top. Mustafa HOXHAI

Hid. Hajredin MURGU

SHKALLA

-

Vorë 2018

FLETA

6 - 01

Format A3



REPUBLIKA E SHQIPERISË
BASHKIA VORË

PROJEKT ZBATIMI

OBJEKTI:
"NDERTIMI I KANALIT DOMJE DHE NDRICIMI RRUGES"
BASHKIA VORË

7. SEKSIONET TERTHORE

POROSITESI : BASHKIA VORË

OBJEKTI: "NDERTIMI I KANALIT DOMJE DHE NDRICIMI RRUGES"

Emertimi: PROFILET TERTHORE



"ARABEL - STUDIO" Sh.p.k

Adresa: Njesia Bashkiake nr.7, Rruga "Frosina Plaku",
Pallati 21, Hyrja 1, Kati 2, Tirane.
Email: arabelstudio@gmail.com

Drejtues i projektit

Adm. Ana NISHKU

Inxh. Ardi ARKAXHIU

Projektues

Nd. Ardi ARKAXHIU

Ark.Rigert HYRA

Gjeo.Irfan BEGAJ

Elek. Altin ALLKAJ

Top. Mustafa HOXHAI

Hid. Hajredin MURGU

SHKALLA

1 : 200

Vorë 2018

FLETA

7- 09

Format A3

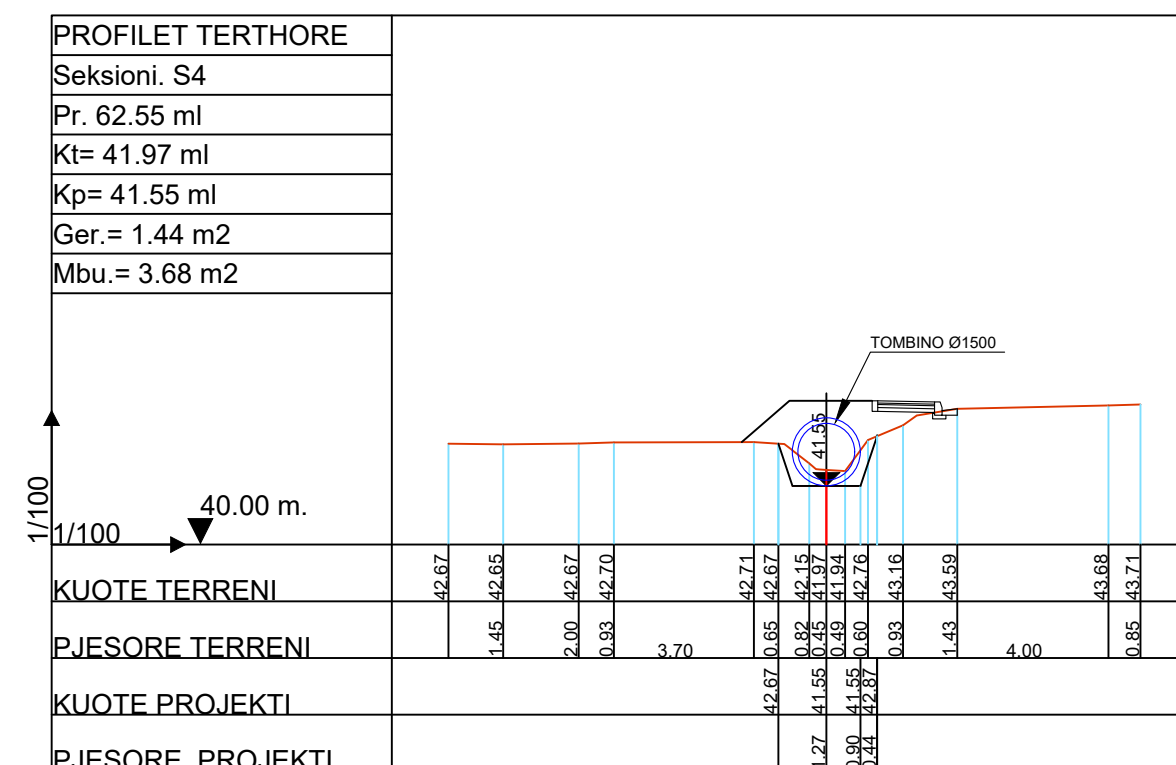
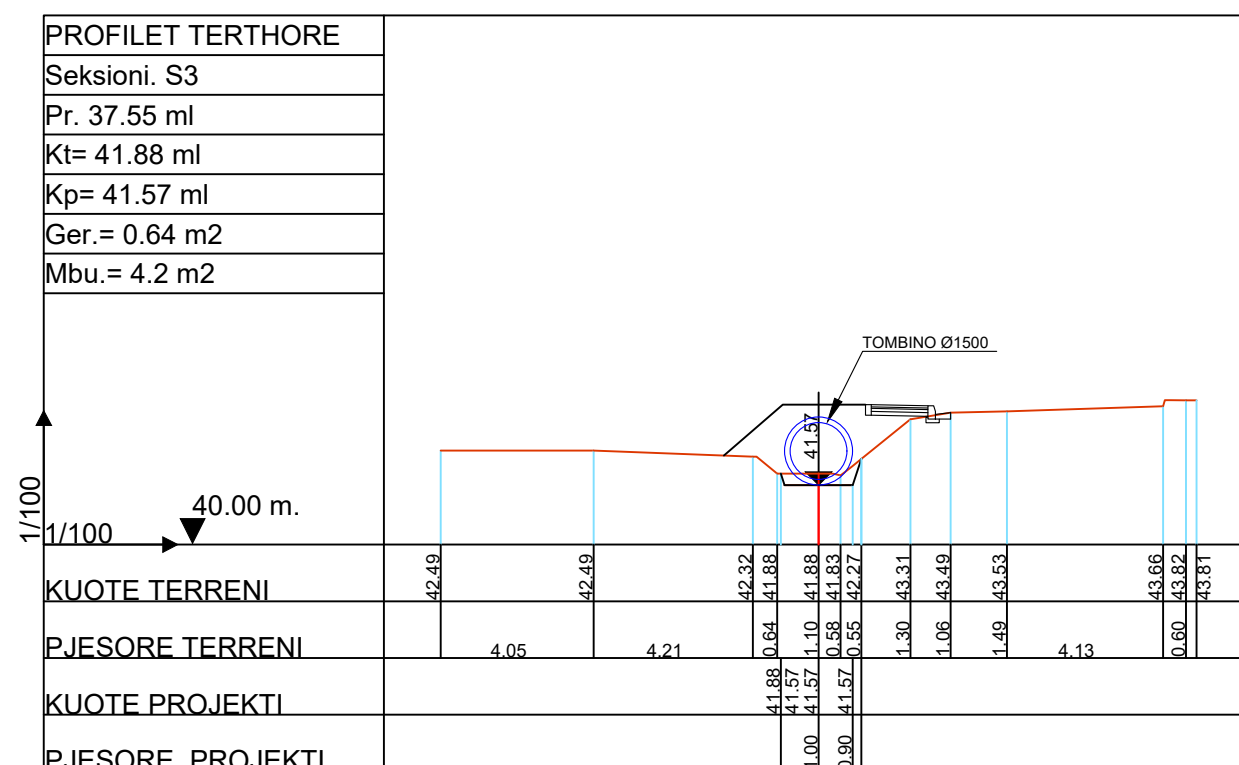
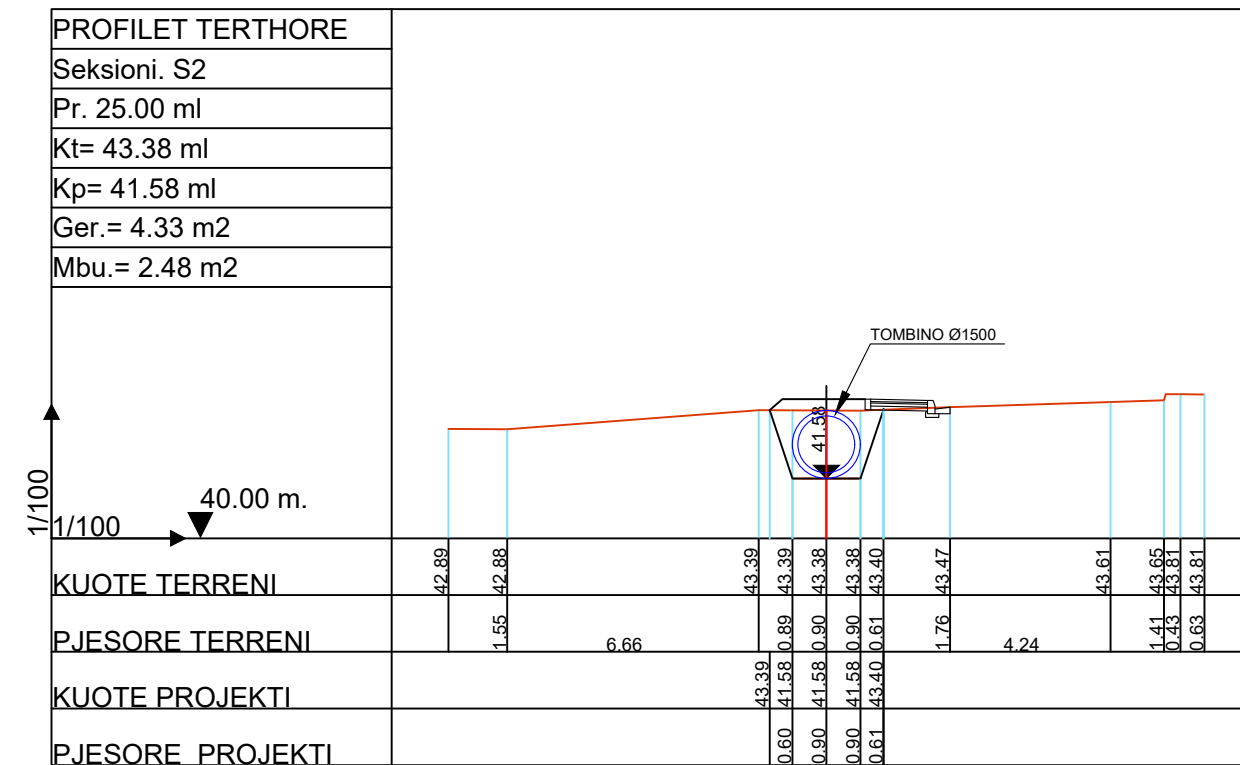
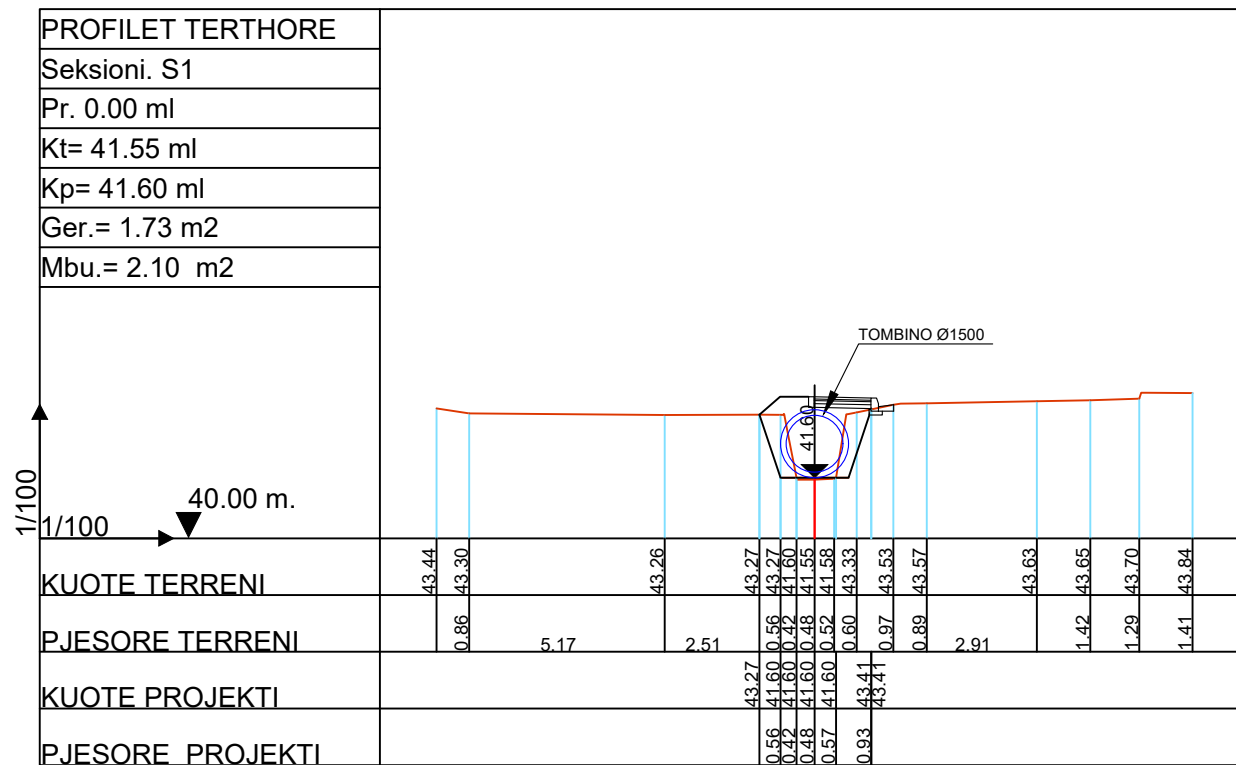

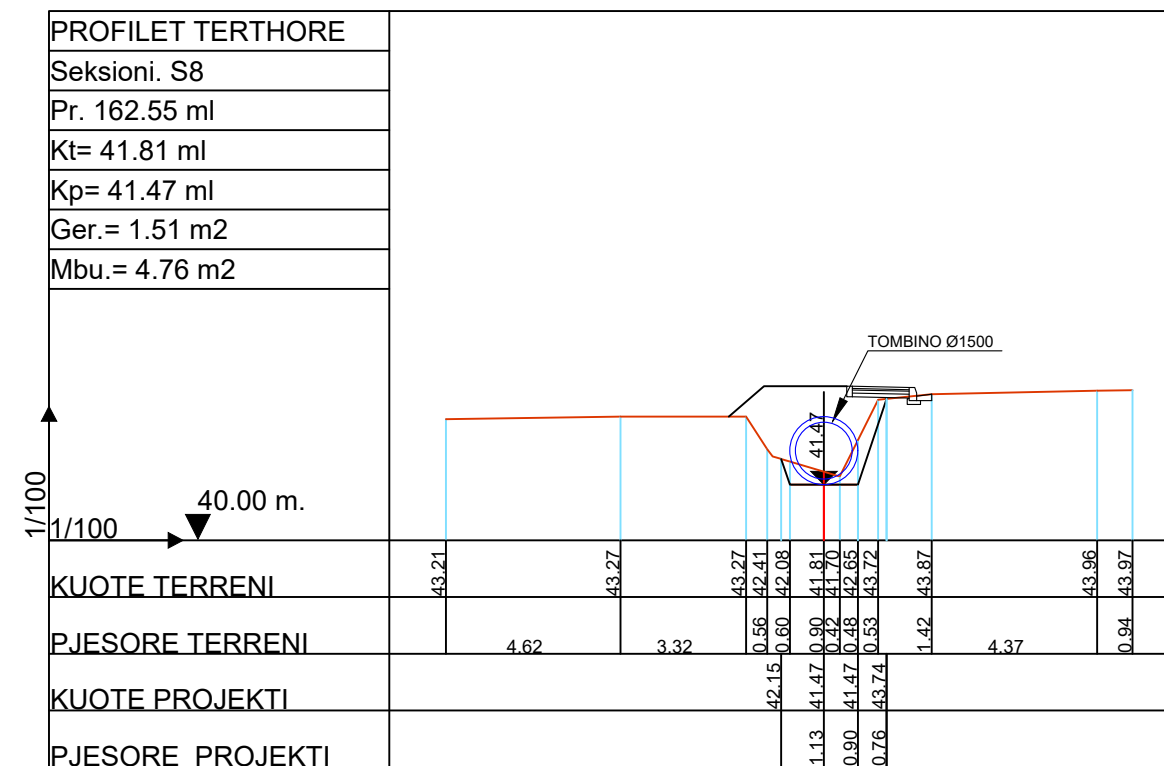
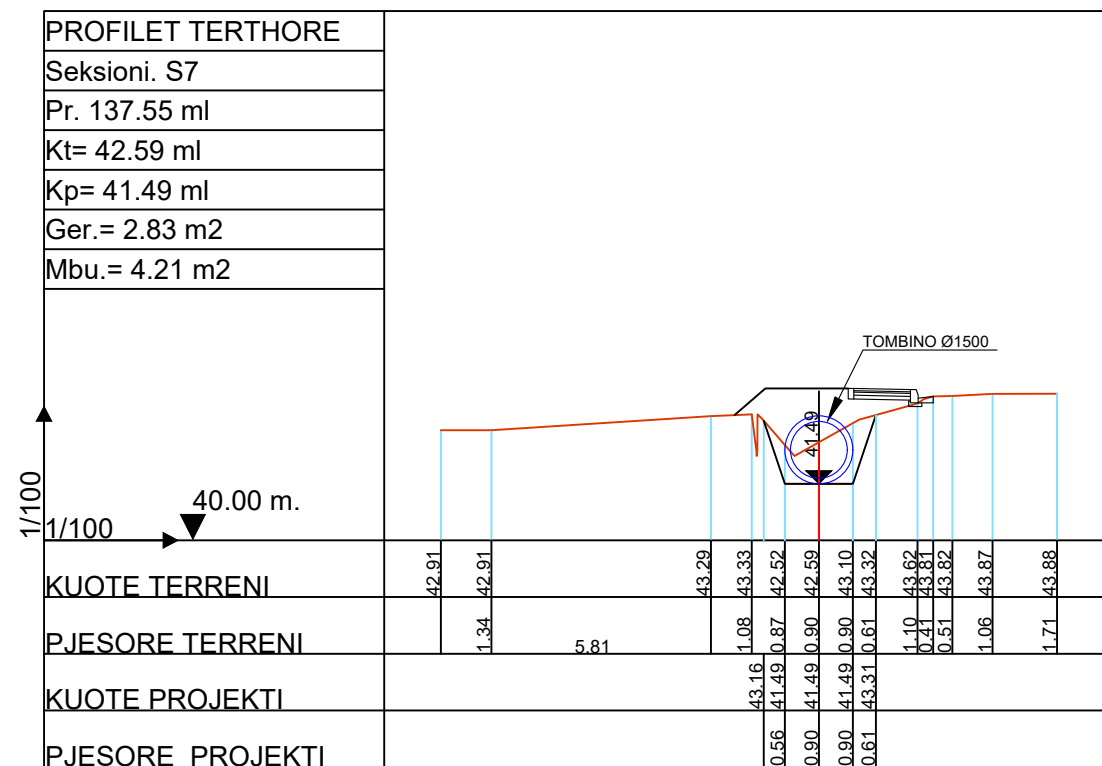
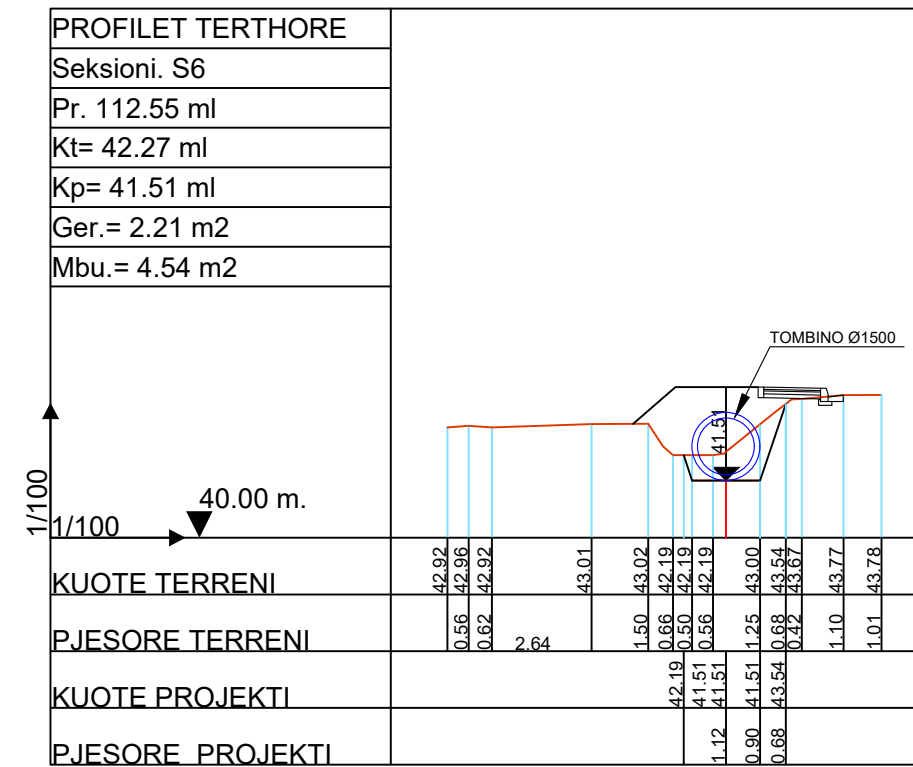
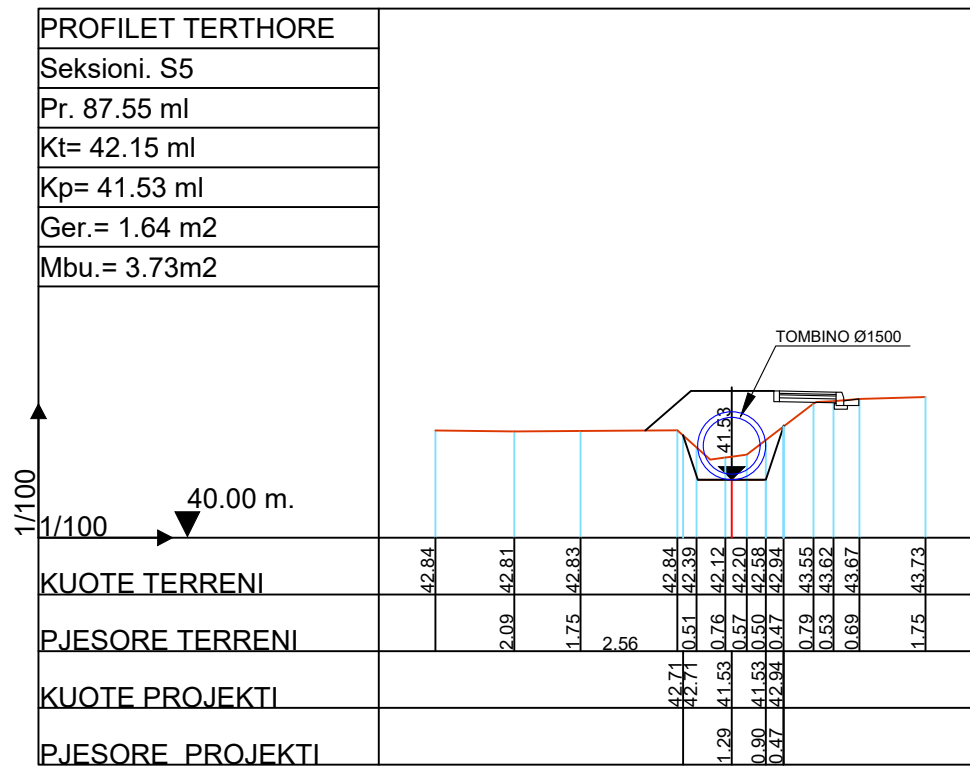

POROSITESI : BASHKIA VORË
 OBJEKTI: "NDERTIMI I KANALIT DOMJE DHE NDRICIMI RRUGES"

Emertimi: PROFILET TERTHORE



"ARABEL - STUDIO" Sh.p.k
 Adresa: Njesia Bashkiake nr.7, Rruga "Frosina Plaku",
 Pallati 21, Hyrja 1, Kati 2, Tirane.
 Email: arabelstudio@gmail.com

Drejtes i projektit		Projektues	
Adm. Ana NISHKU		Nd. Ardi ARKAXHIU	Elek. Altin ALLKAJ
Inxh. Ardi ARKAXHIU		Ark.Rigert HYRA	Top. Mustafa HOXHAI
		Gjeo.Irfan BEGAJ	Hid. Hajredin MURGU

SHKALLA	FLETA
1 : 200	7- 03
Vorë 2018	Format A3

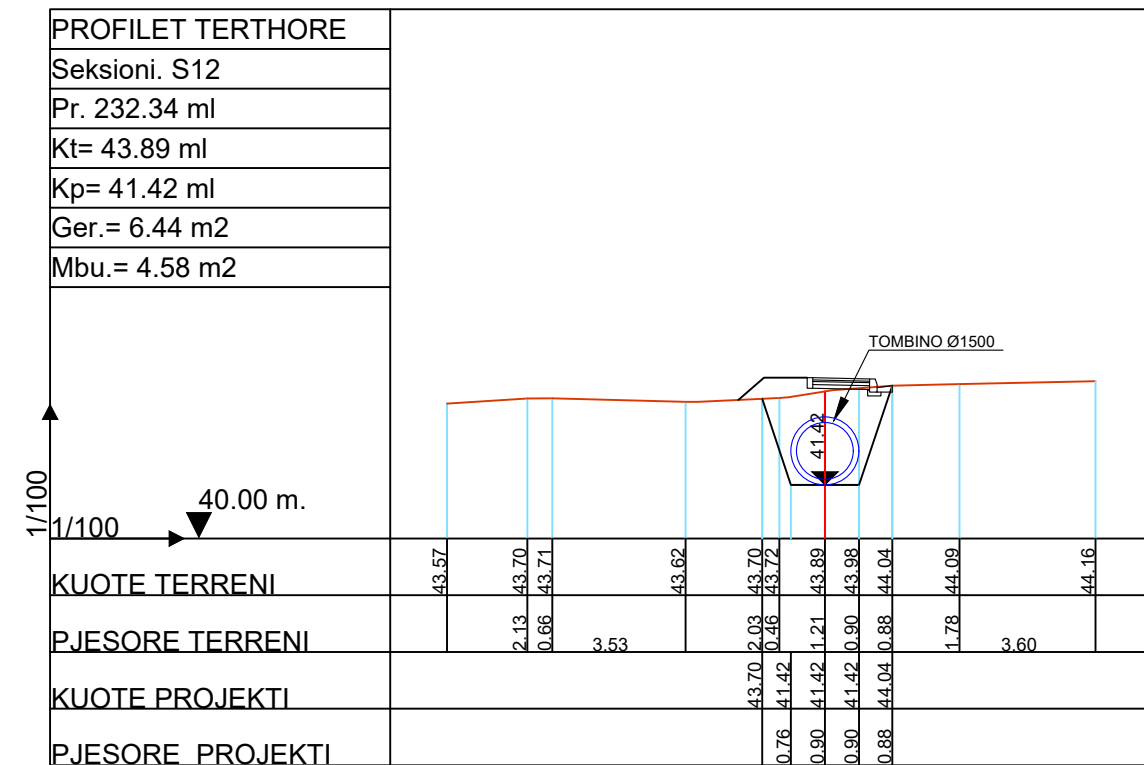
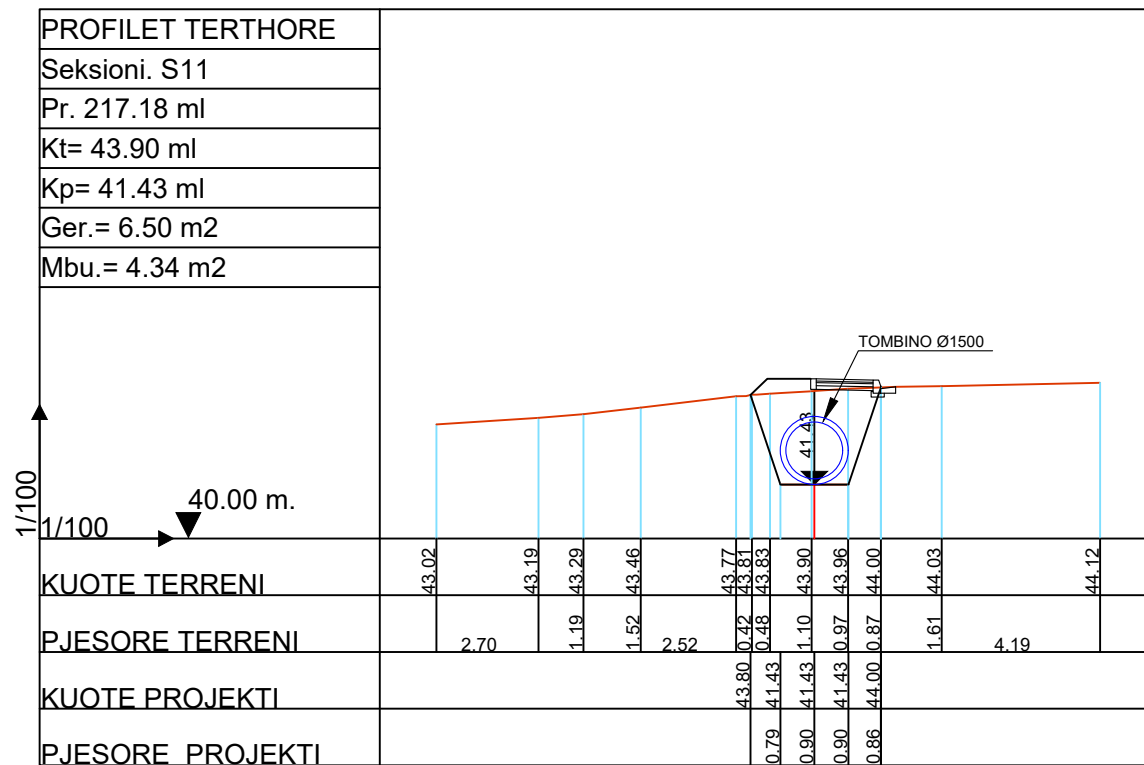
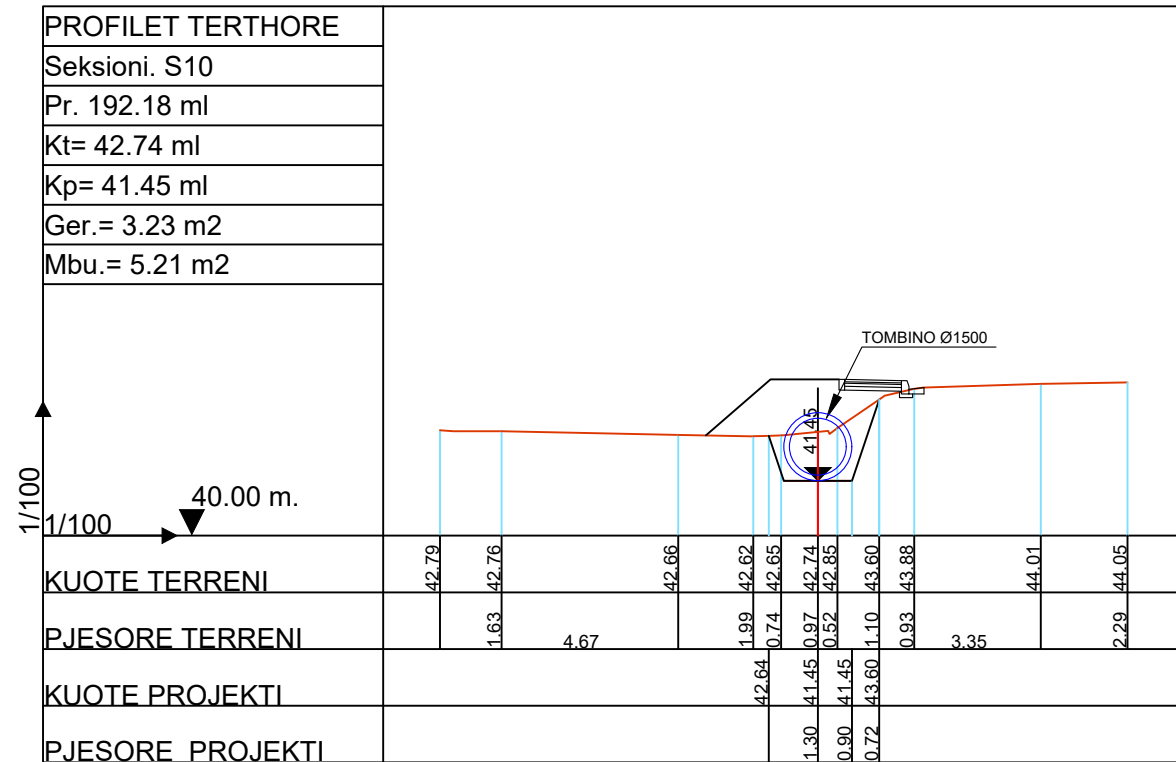
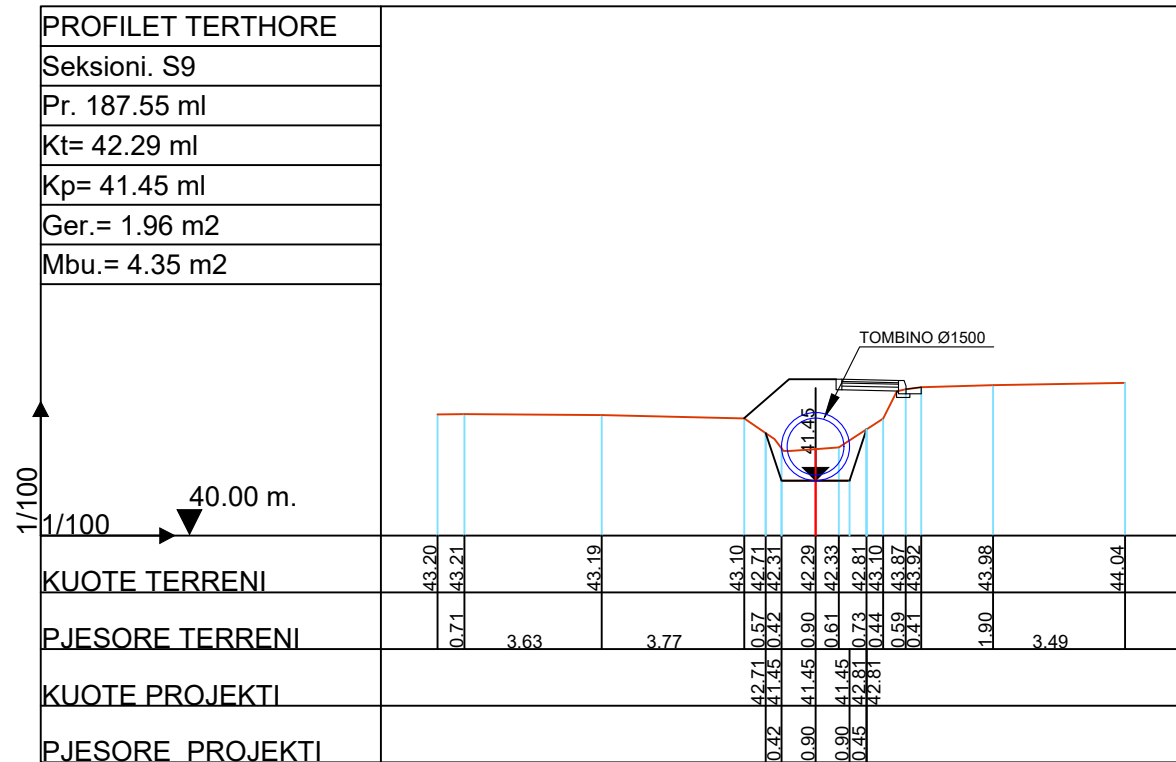

POROSITESI : BASHKIA VORË
 OBJEKTI: "NDERTIMI I KANALIT DOMJE DHE NDRICIMI RRUGES"

Emertimi: PROFILET TERTHORE

"ARABEL - STUDIO" Sh.p.k
 Adresa: Njesia Bashkiake nr.7, Rruga "Frosina Plaku",
 Pallati 21, Hyrja 1, Kati 2, Tirane.
 Email: arabelstudio@gmail.com

Drejtesues i projektit		Projektues	
Adm. Ana NISHKU		Nd. Ardi ARKAXHIU	Elek. Altin ALLKAJ
Inxh. Ardi ARKAXHIU		Ark.Rigert HYRA	Top. Mustafa HOXHAJ
		Gjeo.Irfan BEGAJ	Hid. Hajredin MURGU

SHKALLA	FLETA
1 : 200	7- 04
Vorë 2018	Format A3

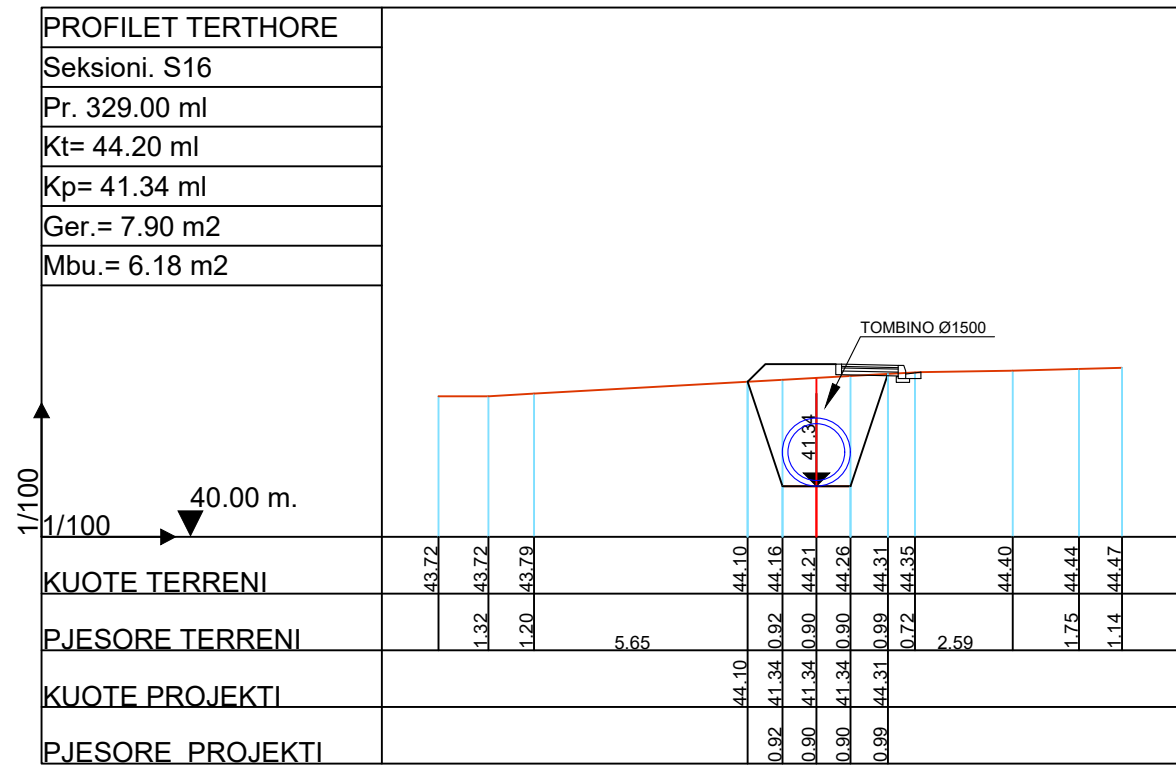
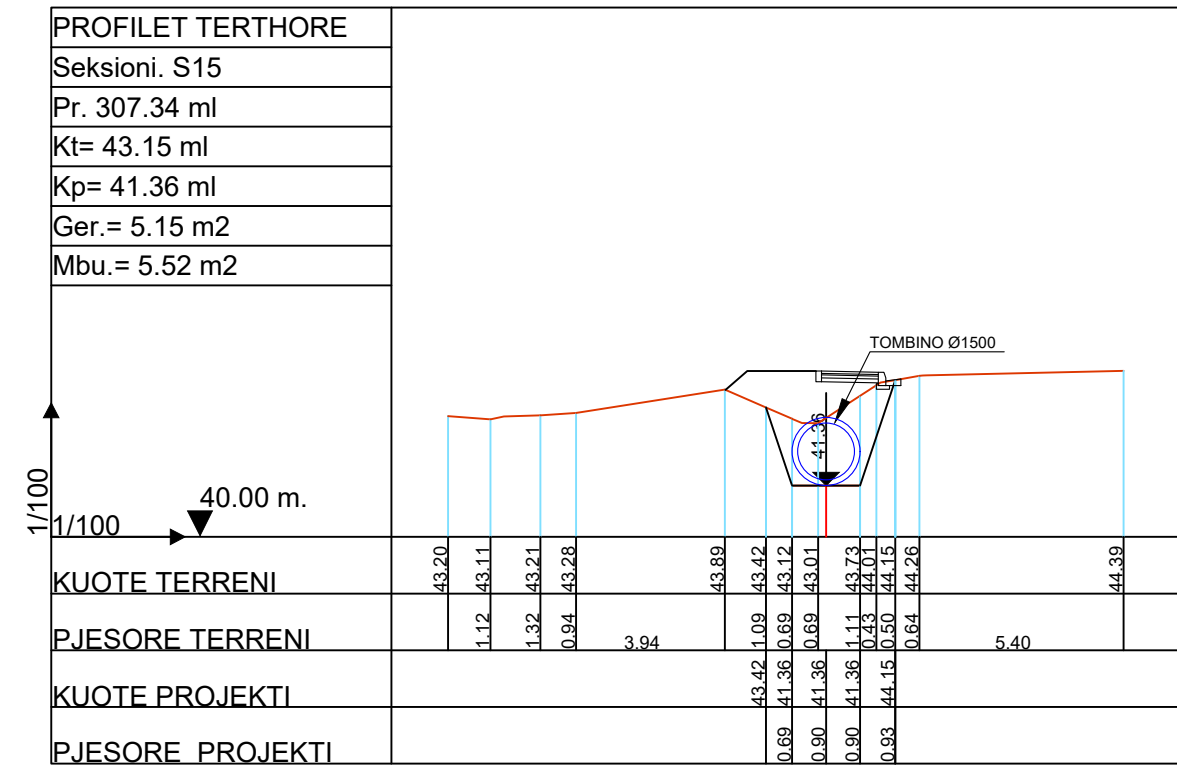
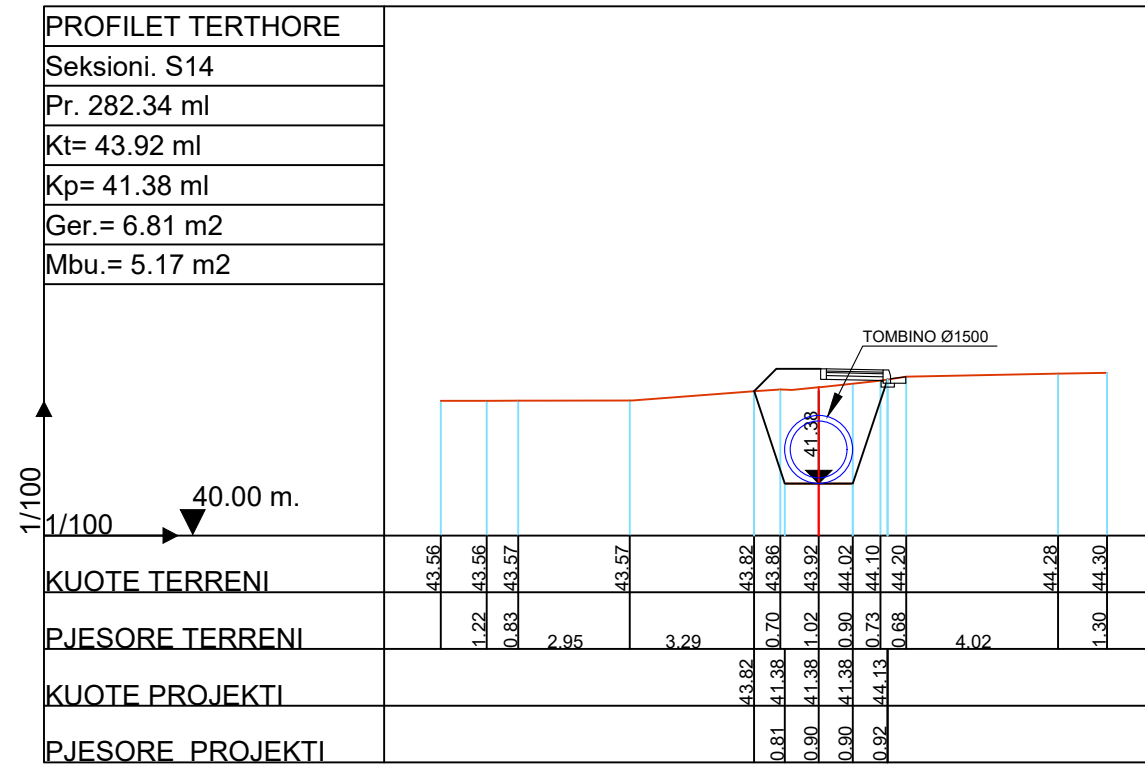
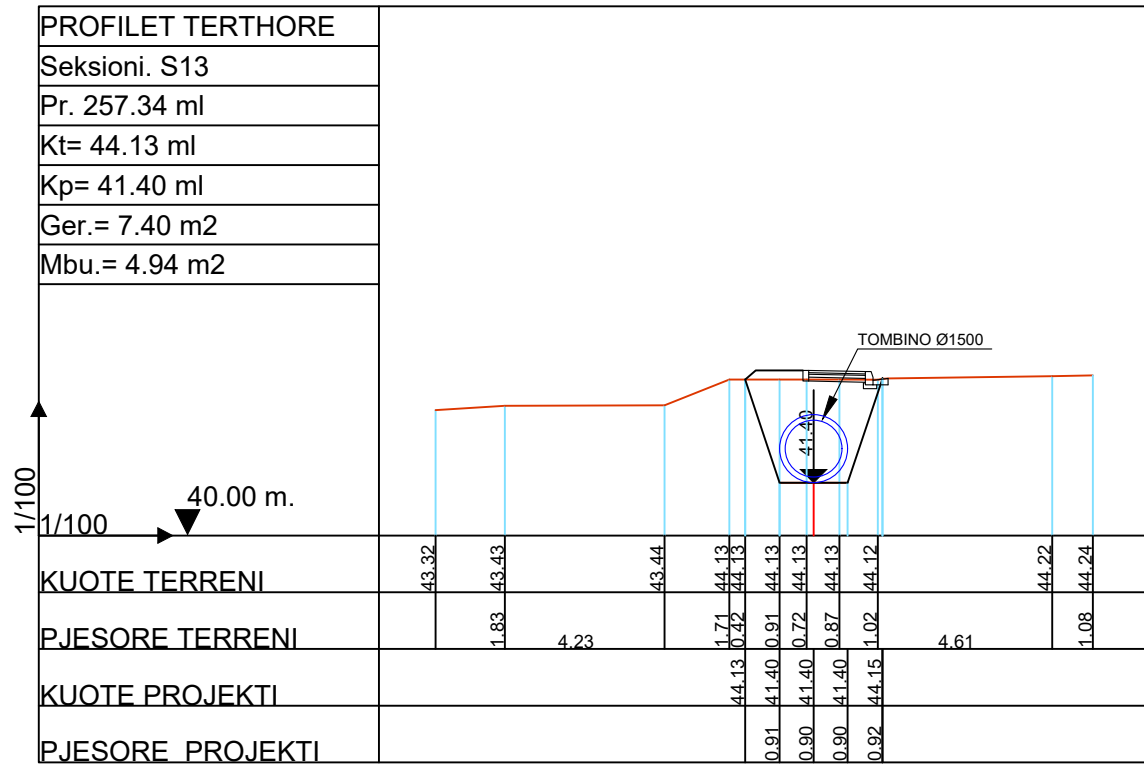

POROSITESI : BASHKIA VORË
 OBJEKTI: "NDERTIMI I KANALIT DOMJE DHE NDRICIMI RRUGES"

Emertimi: PROFILET TERTHORE



"ARABEL - STUDIO" Sh.p.k
 Adresa: Njesia Bashkiake nr.7, Rruga "Frosina Plaku",
 Pallati 21, Hyrja 1, Kati 2, Tirane.
 Email: arabelstudio@gmail.com

Drejtes i projektit		Projektues	
Adm. Ana NISHKU		Nd. Ardi ARKAXHIU	Elek. Altin ALLKAJ
Inxh. Ardi ARKAXHIU		Ark.Rigert HYRA	Top. Mustafa HOXHAI
		Gjeo.Irfan BEGAJ	Hid. Hajredin MURGU

SHKALLA	FLETA
1 : 200	7- 05
Vorë 2018	Format A3

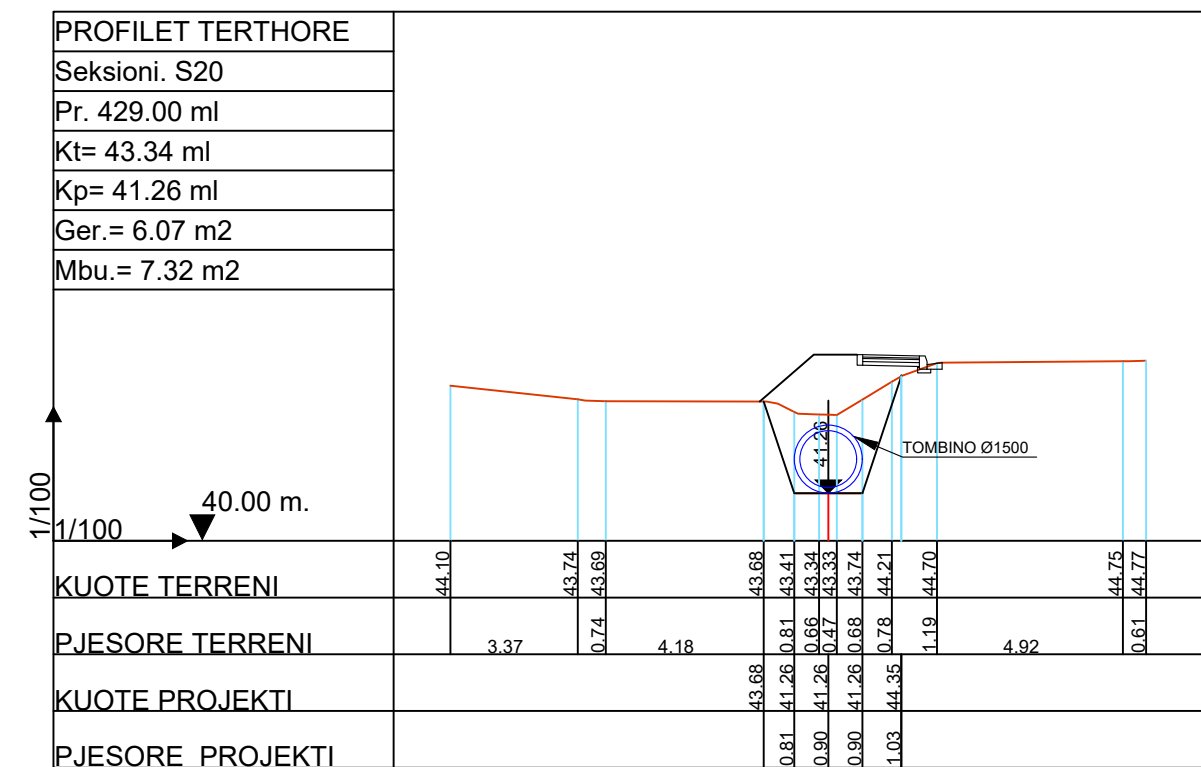
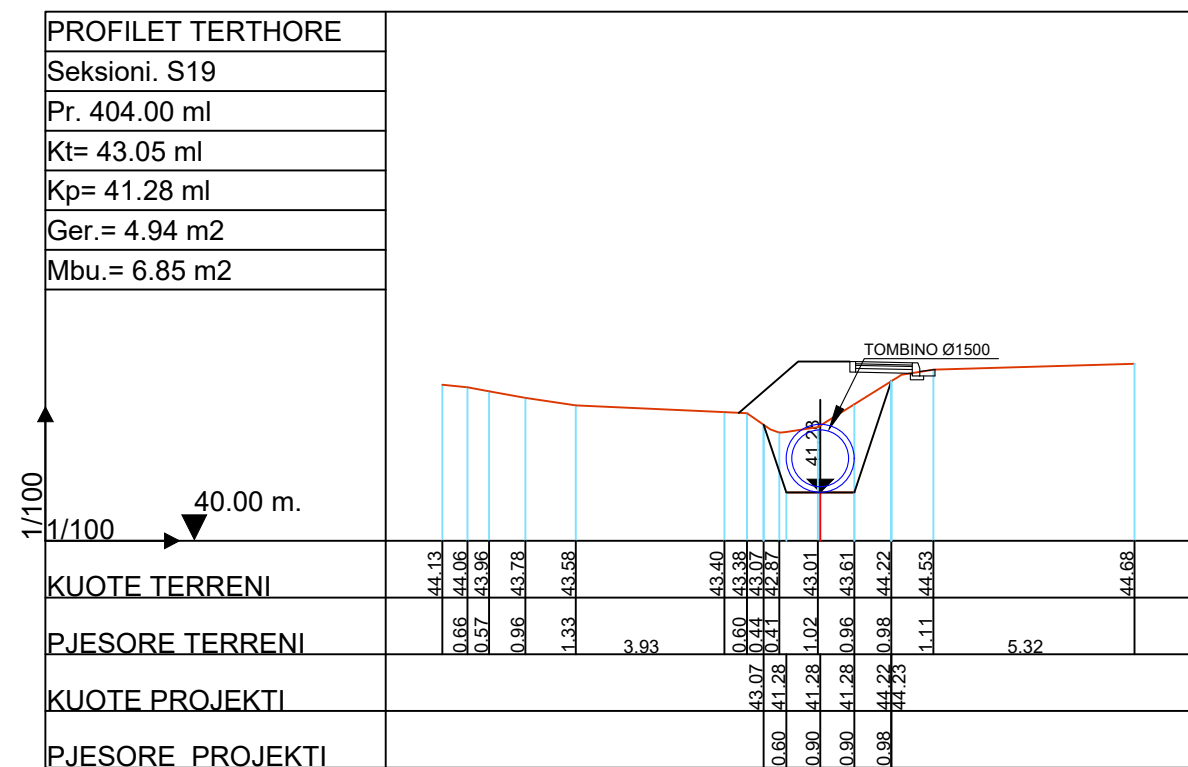
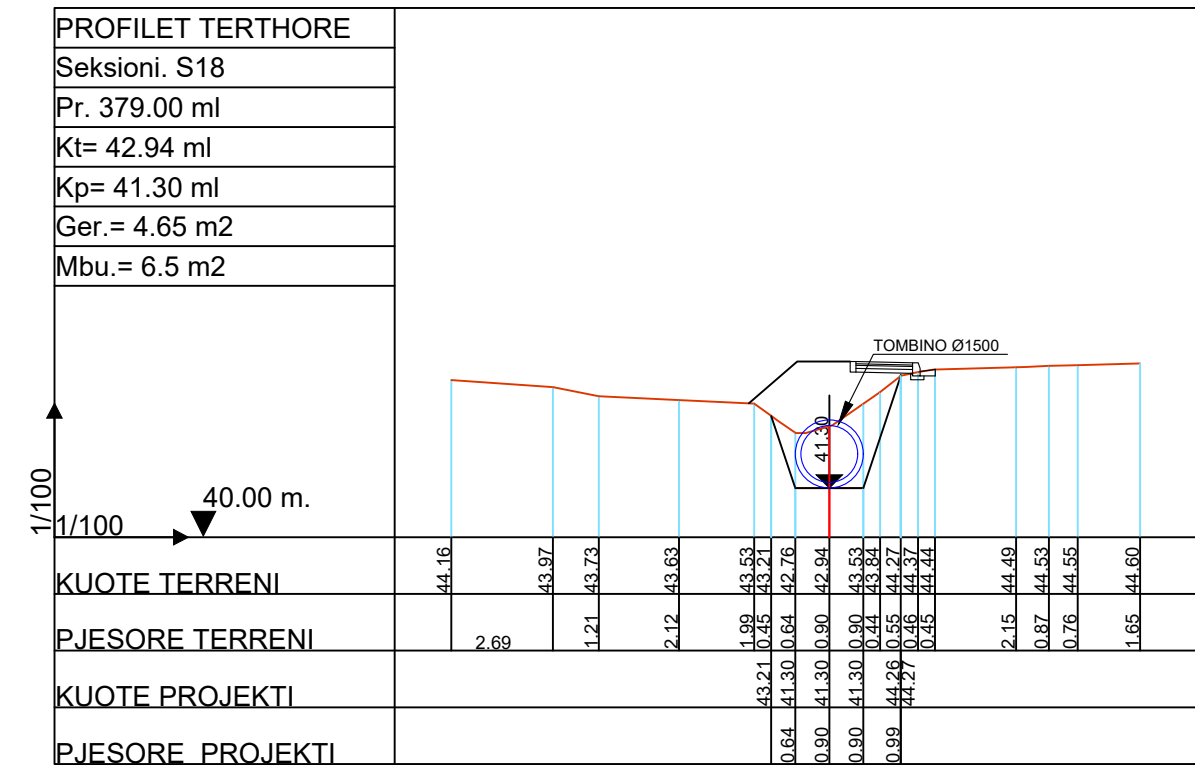
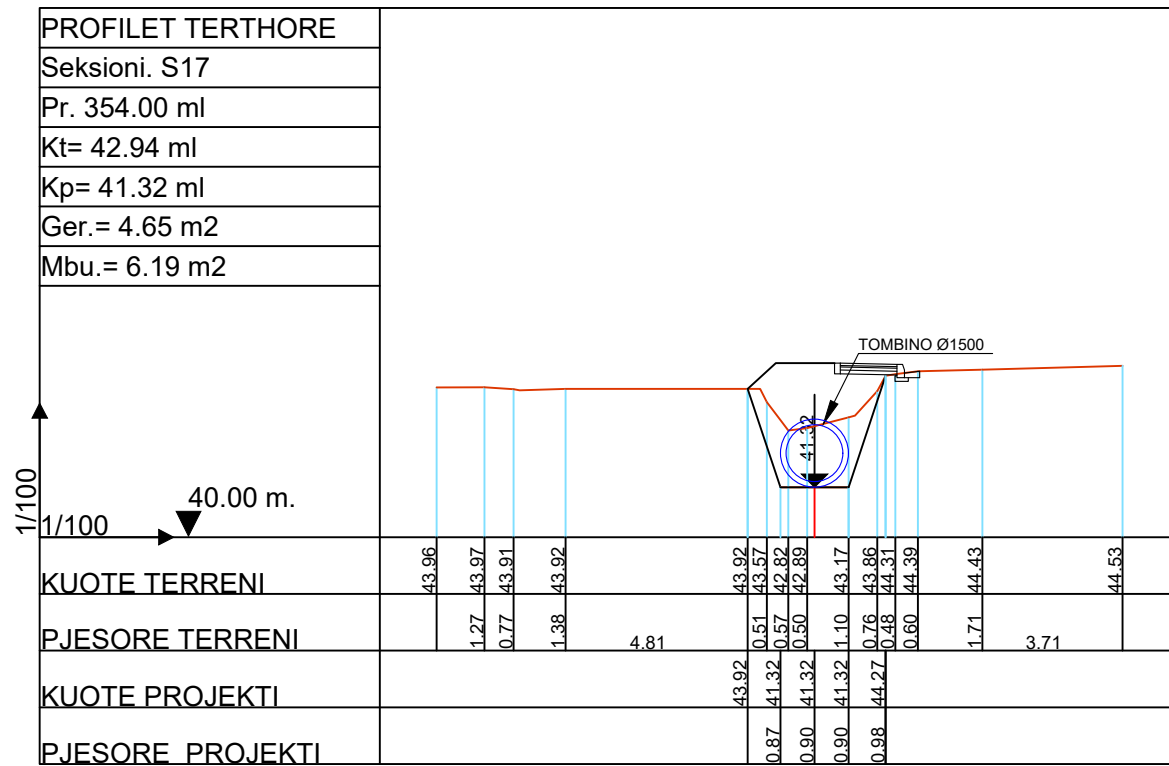

POROSITESI : BASHKIA VORË
 OBJEKTI: "NDERTIMI I KANALIT DOMJE DHE NDRICIMI RRUGES"



"ARABEL - STUDIO" Sh.p.k
 Adresa: Njesia Bashkiake nr.7, Rruga "Frosina Plaku",
 Pallati 21, Hyrja 1, Kati 2, Tirane.
 Email: arabelstudio@gmail.com

Drejgues i projektit

Adm. Ana NISHKU
 Inxh. Ardi ARKAXHIU

Projektues

Nd. Ardi ARKAXHIU
 Ark.Rigert HYRA
 Gjeo.Irfan BEGAJ
 Elek. Altin ALLKAJ
 Top. Mustafa HOXHAJ
 Hid. Hajredin MURGU

SHKALLA

1 : 200

Vorë 2018

FLETA

7- 06

Format A3

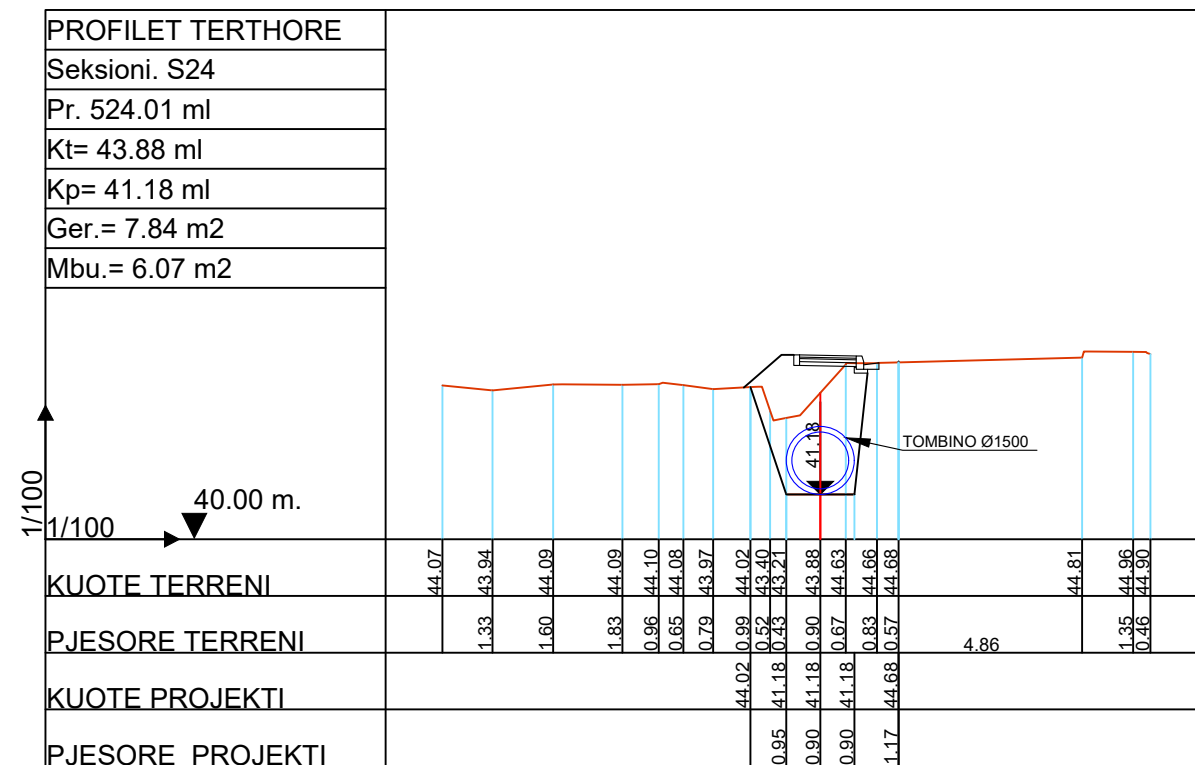
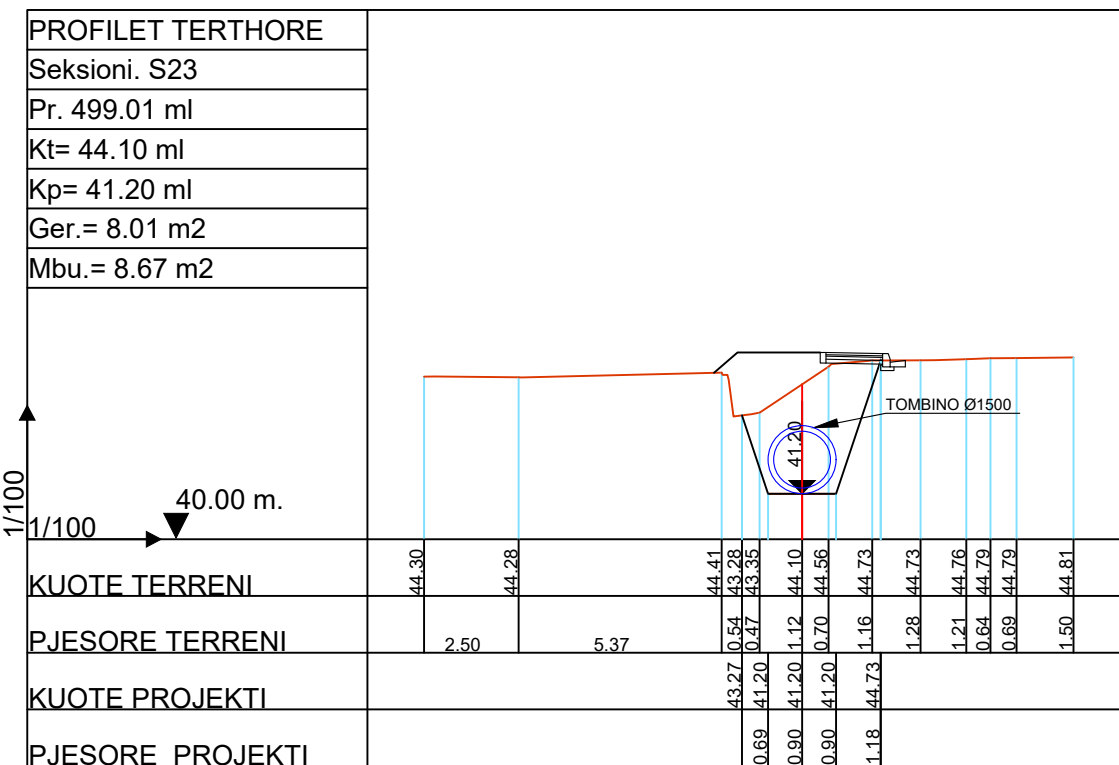
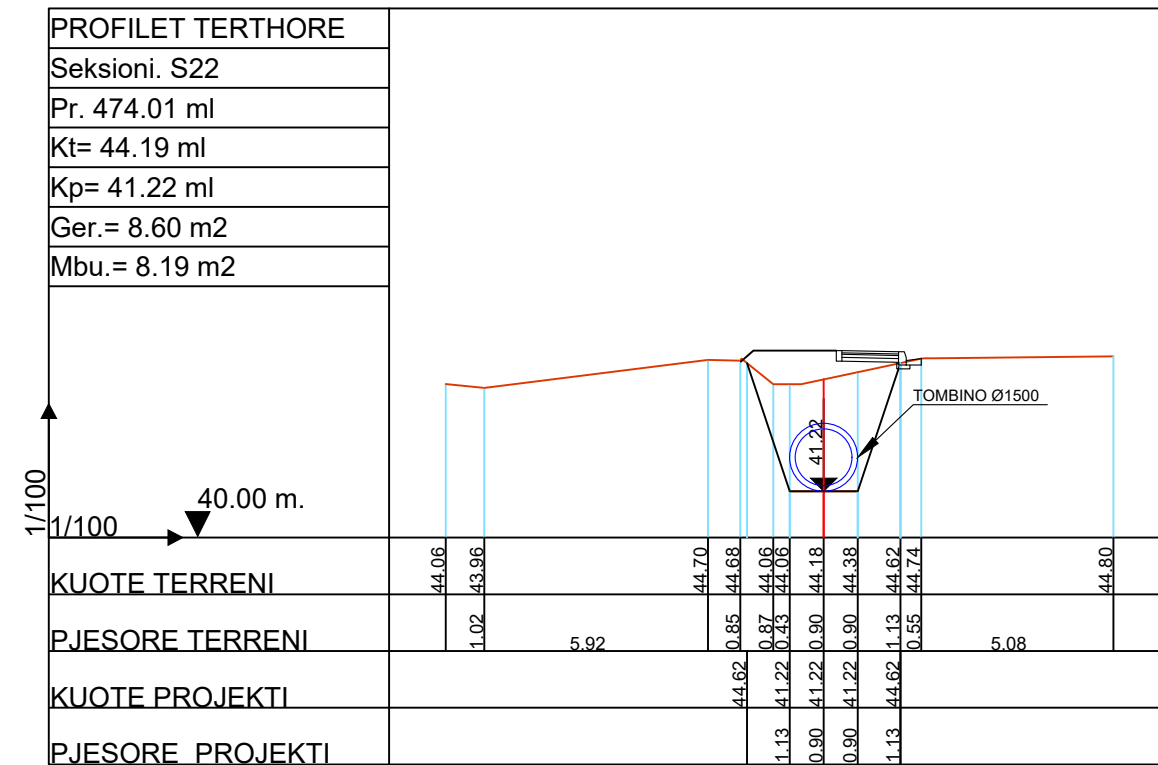
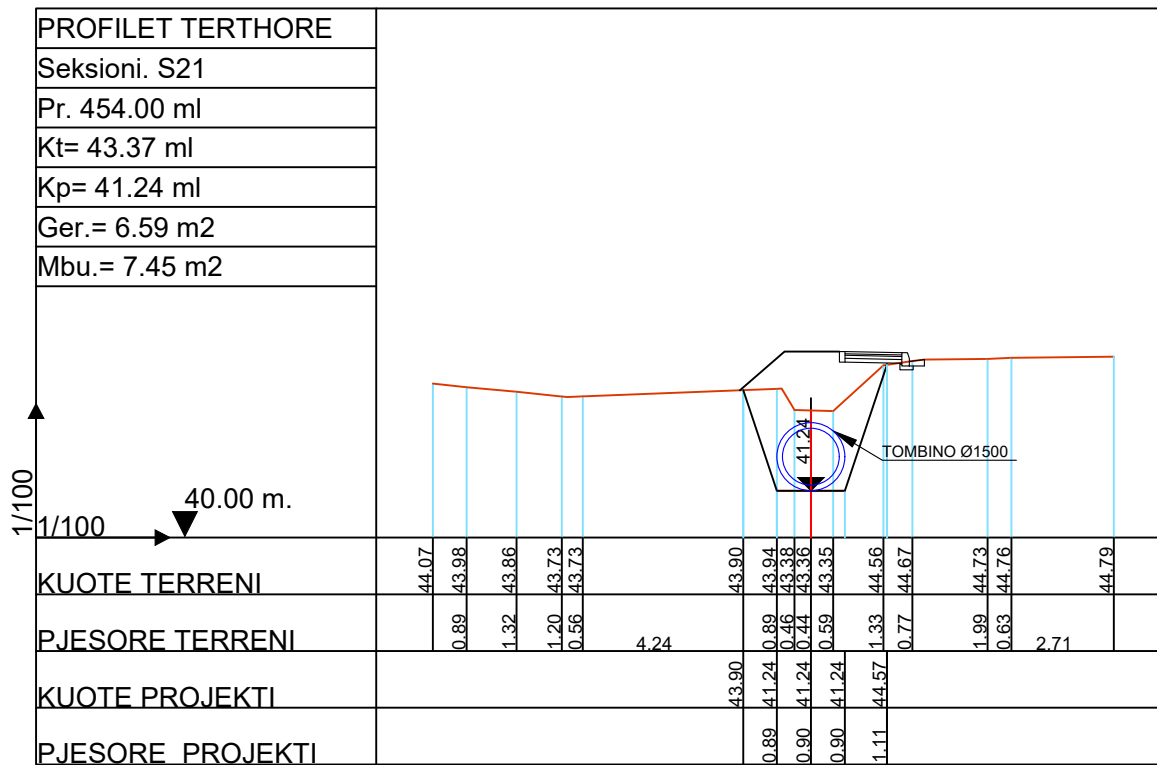

POROSITESI : BASHKIA VORË
 OBJEKTI: "NDERTIMI I KANALIT DOMJE DHE NDRICIMI RRUGES"

Emertimi: PROFILET TERTHORE



"ARABEL - STUDIO" Sh.p.k
 Adresa: Njesia Bashkiake nr.7, Rruga "Frosina Plaku",
 Pallati 21, Hyrja 1, Kati 2, Tirane.
 Email: arabelstudio@gmail.com

Drejtues i projektit		Projektues	
Adm. Ana NISHKU		Nd. Ardi ARKAXHIU	Elek. Altin ALLKAJ
Inxh. Ardi ARKAXHIU		Ark.Rigert HYRA	Top. Mustafa HOXHAJ
		Gjeo.Irfan BEGAJ	Hid. Hajredin MURGU

SHKALLA	FLETA
1 : 200	7- 07
Vorë 2018	Format A3

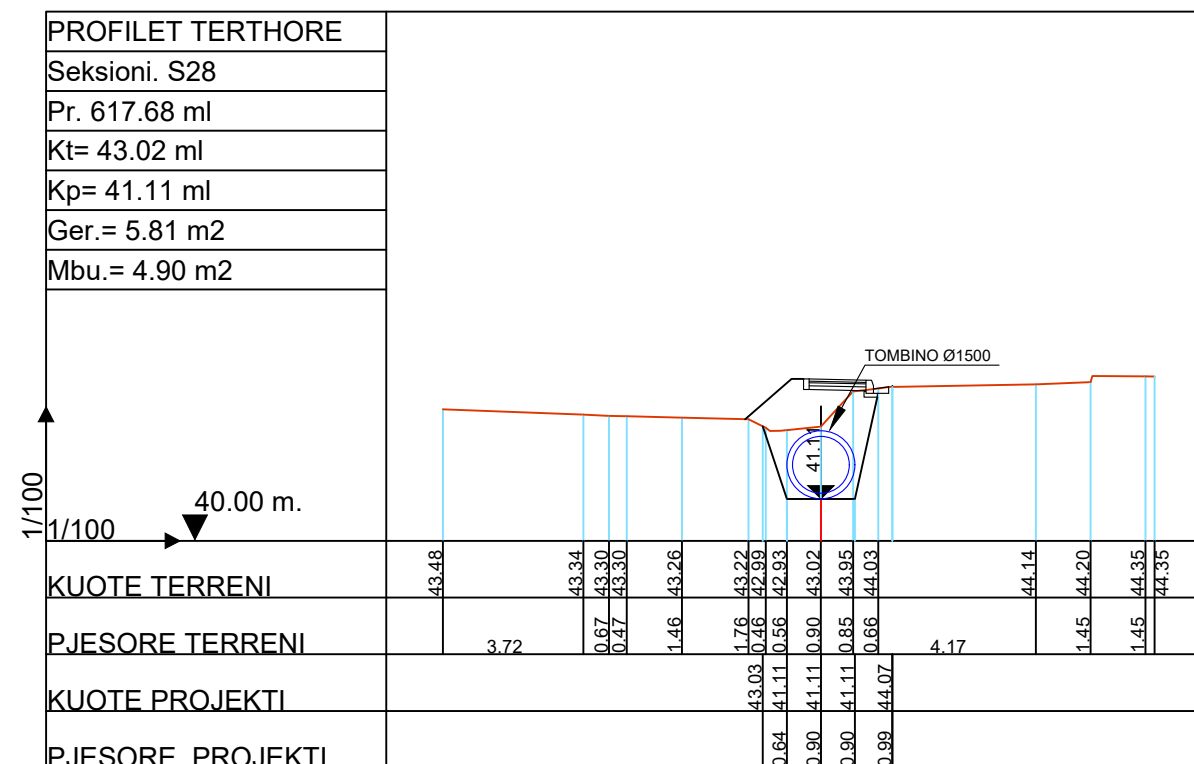
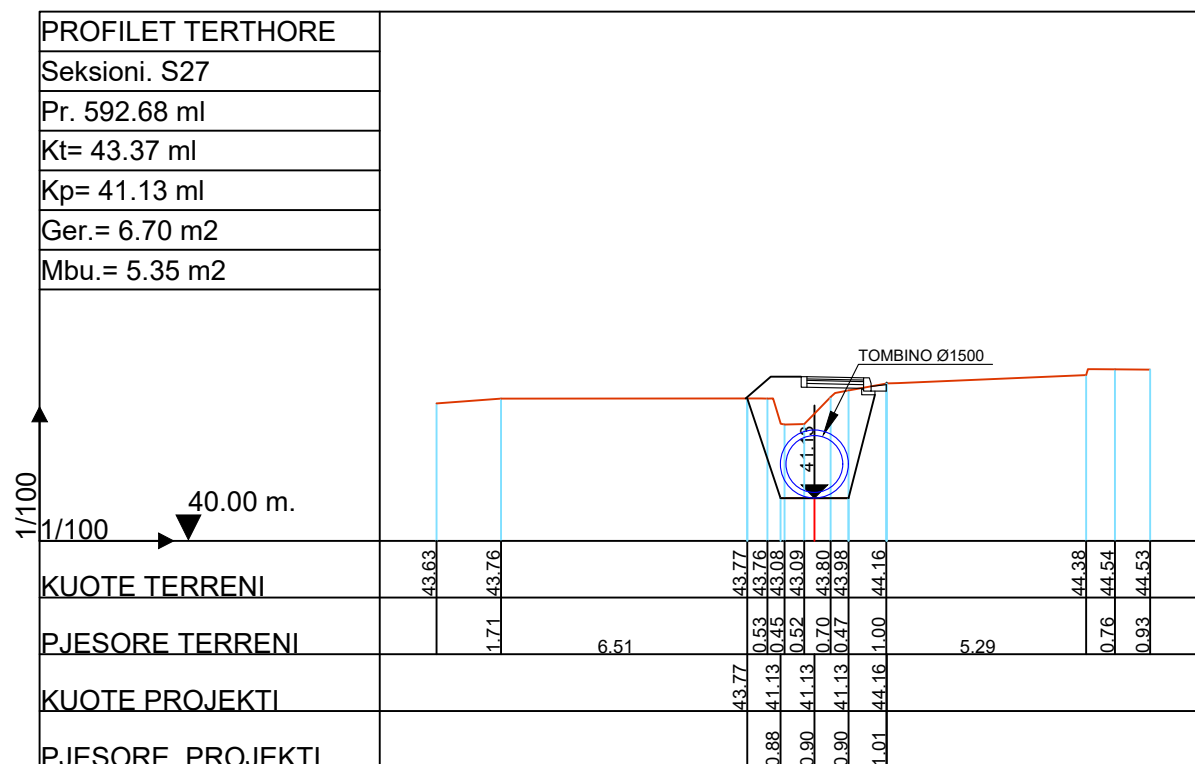
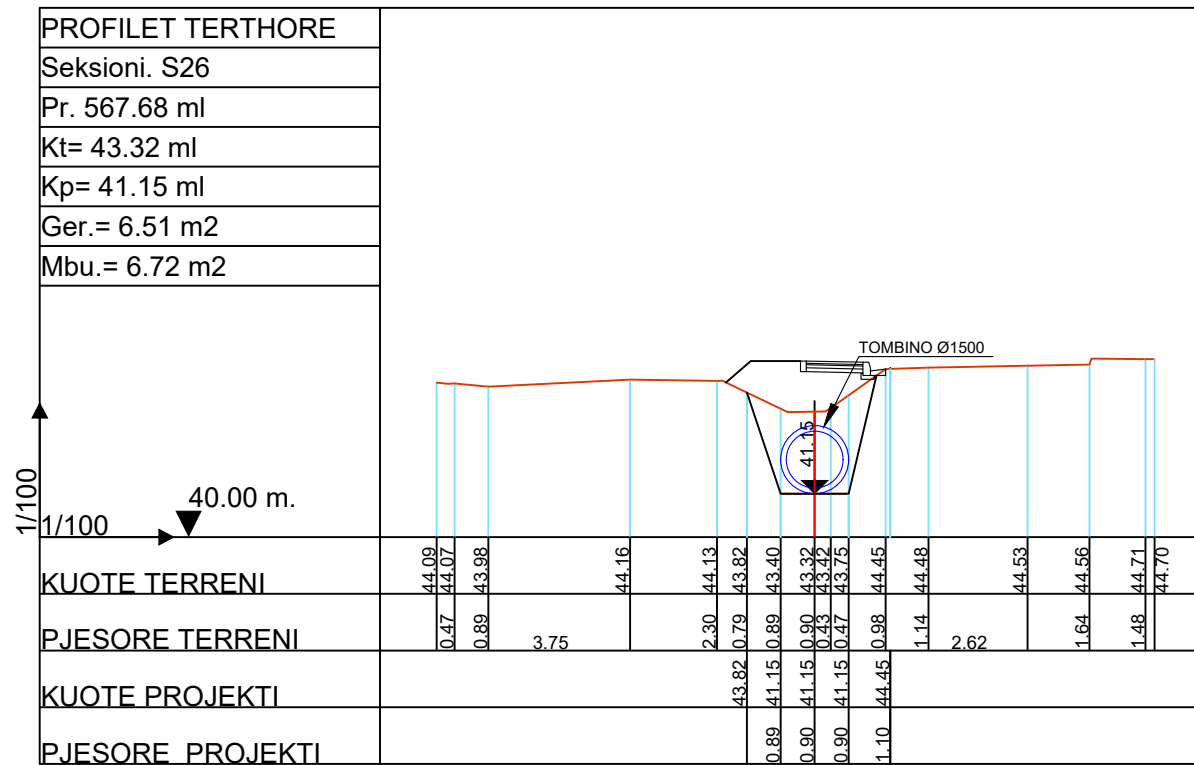
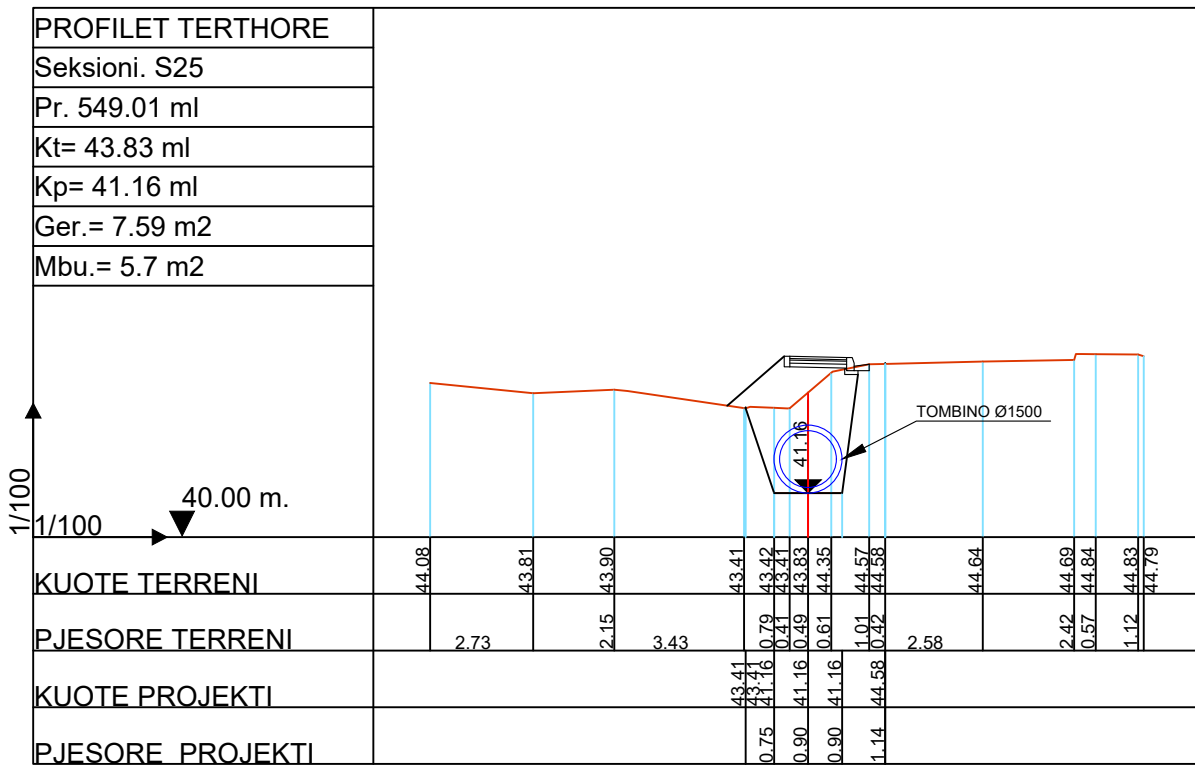

POROSITESI : BASHKIA VORË
 OBJEKTI: "NDERTIMI I KANALIT DOMJE DHE NDRICIMI RRUGES"

Emertimi: PROFILET TERTHORE



"ARABEL - STUDIO" Sh.p.k
 Adresa: Njesia Bashkiake nr.7, Rruga "Frosina Plaku",
 Pallati 21, Hyrja 1, Kati 2, Tirane.
 Email: arabelstudio@gmail.com

Drejtes i projektit		Projektues	
Adm. Ana NISHKU		Nd. Ardi ARKAXHIU	Elek. Altin ALLKAJ
Inxh. Ardi ARKAXHIU		Ark.Rigert HYRA	Top. Mustafa HOXHAI
		Gjeo.Irfan BEGAJ	Hid. Hajredin MURGU

SHKALLA	FLETA
1 : 200	7- 08
Vorë 2018	Format A3

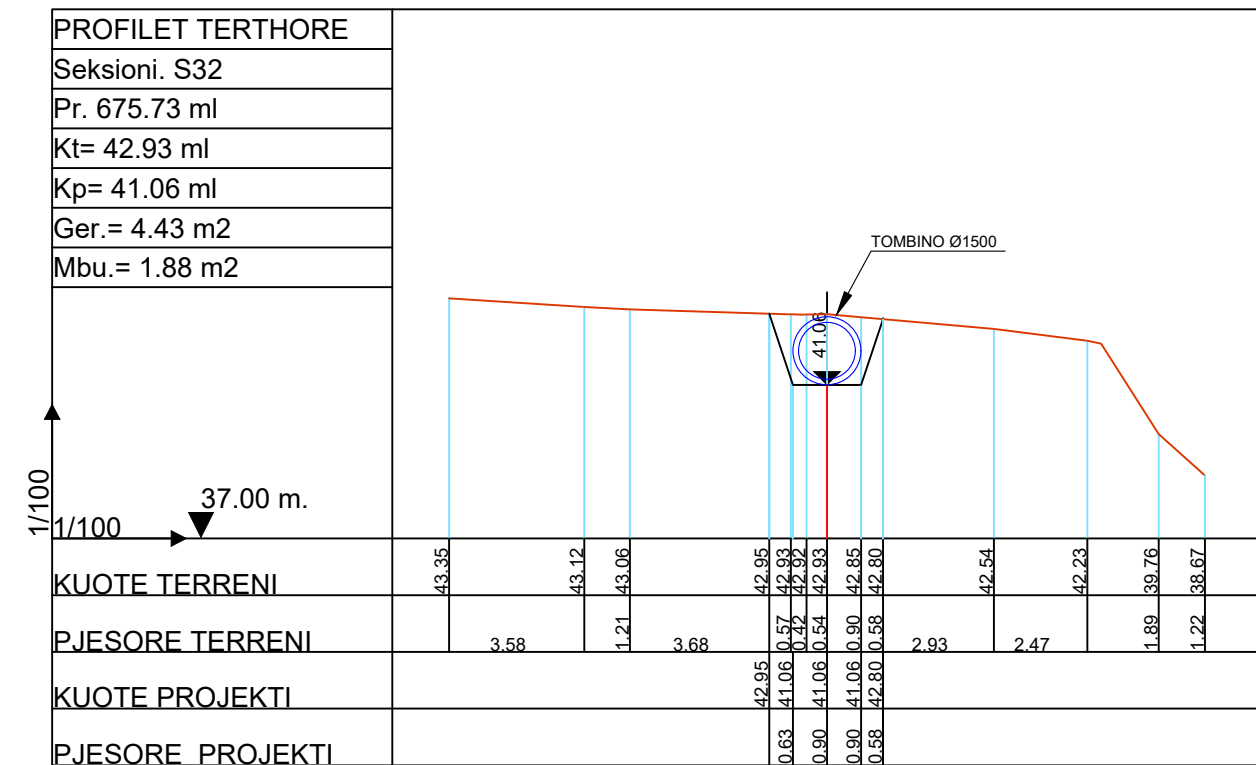
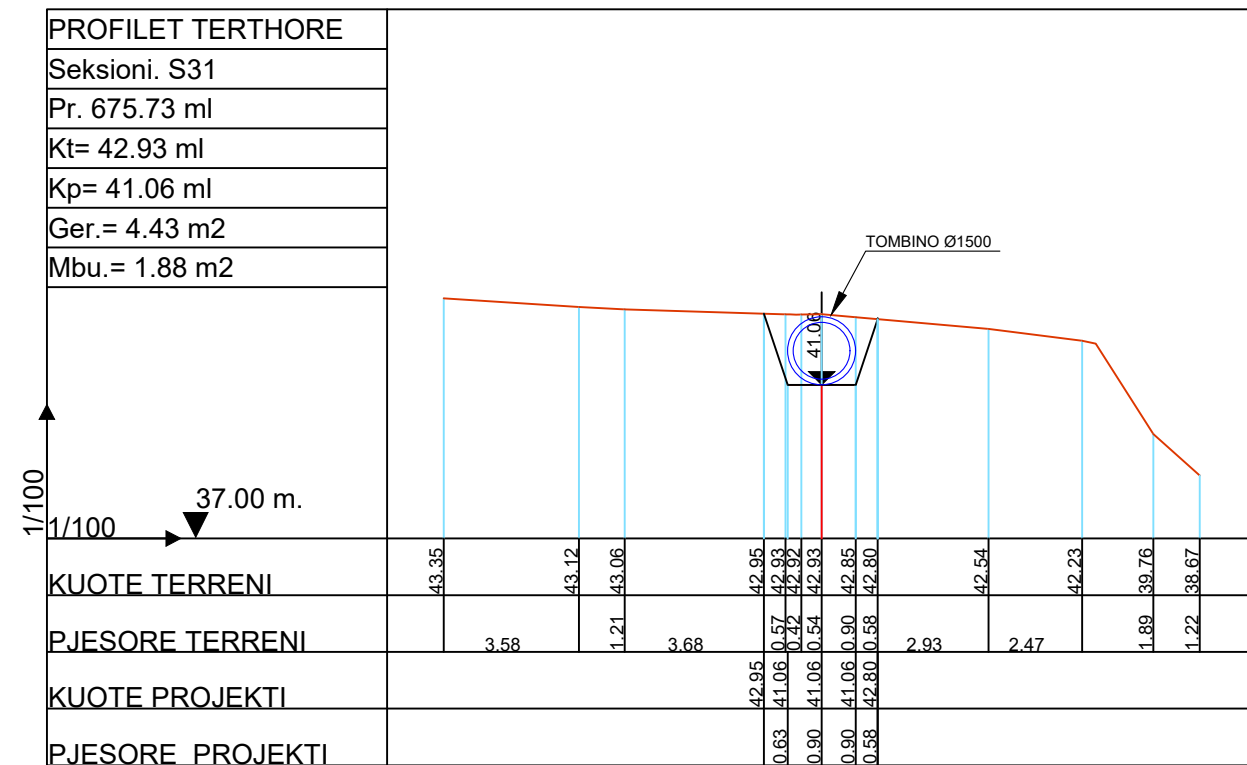
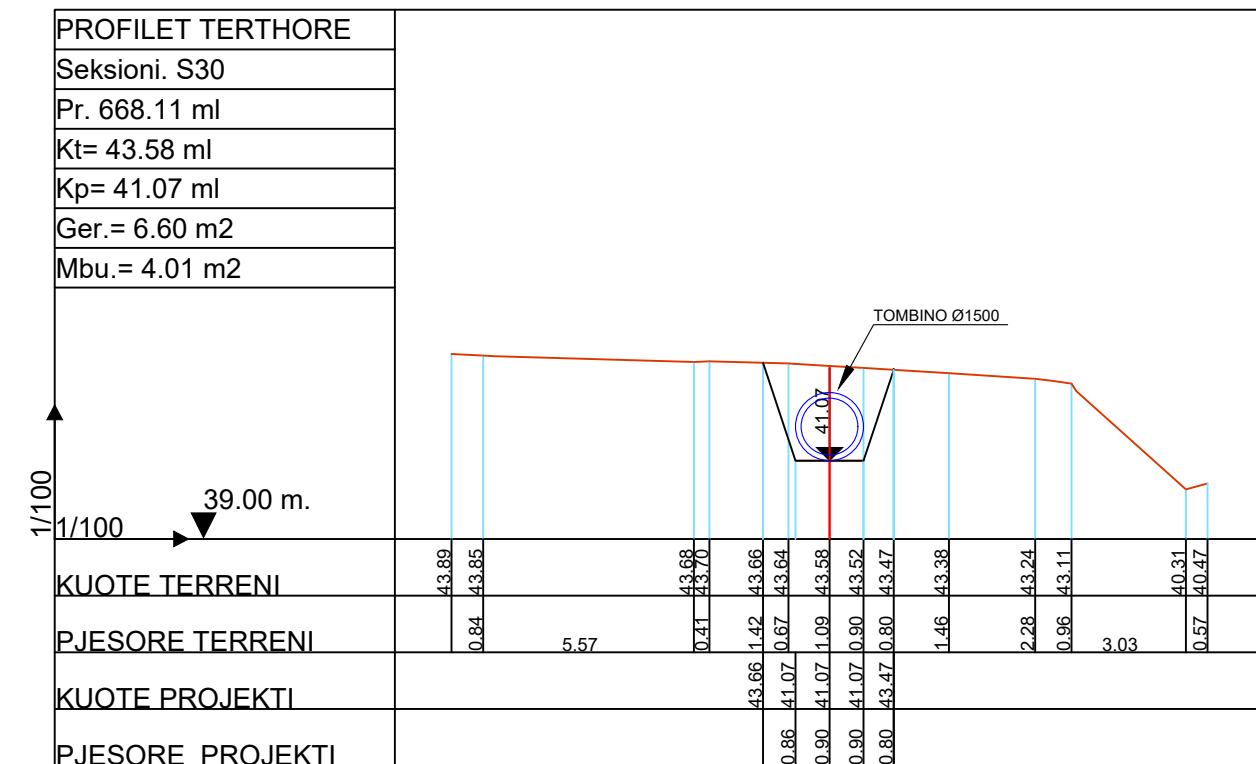
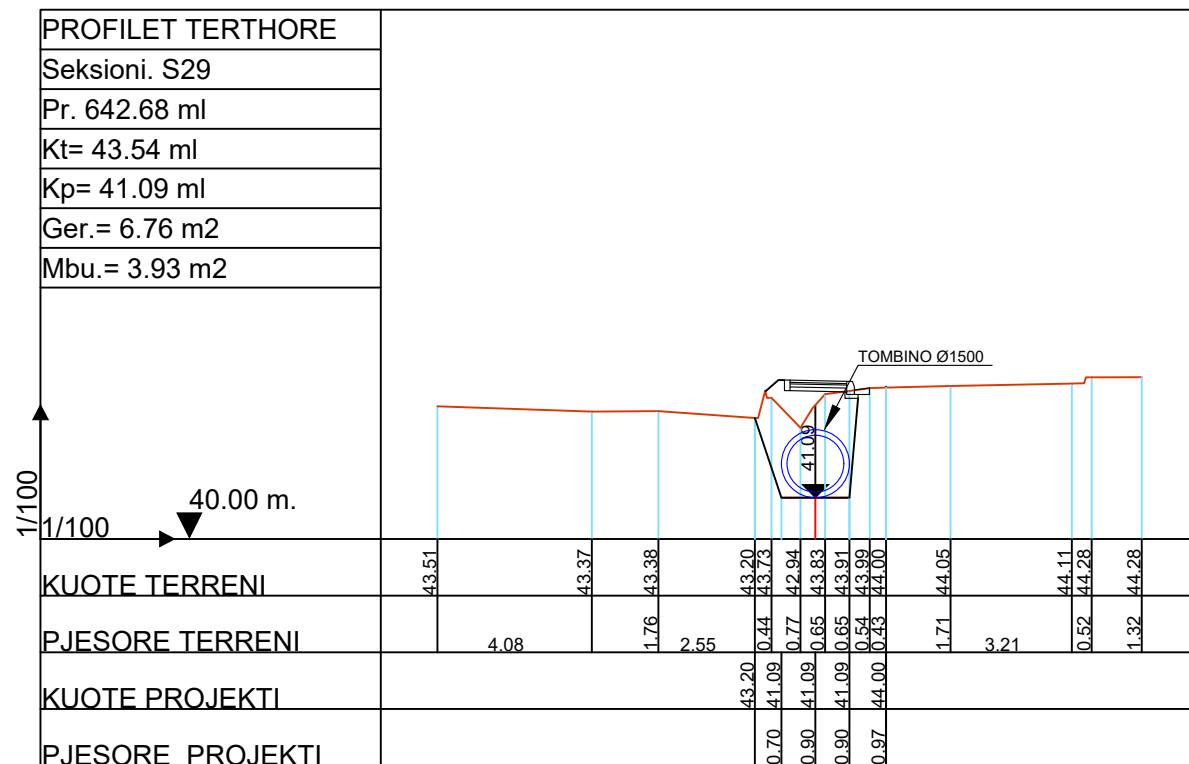

POROSITESI : BASHKIA VORË
 OBJEKTI: "NDERTIMI I KANALIT DOMJE DHE NDRICIMI RRUGES"

Emertimi: PROFILET TERTHORE
"ARABEL - STUDIO" Sh.p.k
 Adresa: Njesia Bashkiake nr.7, Rruga "Frosina Plaku",
 Pallati 21, Hyrja 1, Kati 2, Tirane.
 Email: arabelstudio@gmail.com

Drejtes i projektit
 Adm. Ana NISHKU
 Inxh. Ardi ARKAXHIU

Projektues
 Nd. Ardi ARKAXHIU
 Ark.Rigert HYRA
 Gjeo.Irfan BEGAJ

Elek. Altin ALLKAJ
 Top. Mustafa HOXHAJ
 Hid. Hajredin MURGU

SHKALLA
 1 : 200

FLETA
 7- 09

Vorë 2018
 Format A3



REPUBLIKA E SHQIPERISË
BASHKIA VORË

PROJEKT ZBATIMI

OBJEKTI:
"NDERTIMI I KANALIT DOMJE DHE NDRICIMI RRUGES"
BASHKIA VORË

6.DETAJET DHE VEPRAT E ARTIT



POROSITESI : BASHKIA VORË

OBJEKTI:
"NDERTIMI I KANALIT DOMJE DHE NDRICIMI RRUGES"

Emertimi: SEKSIONI TIP



"ARABEL - STUDIO" Sh.p.k

Adresa:Njesia Bashkiake nr.7, Rruga "Frosina Plaku",
Pallati 21, Hyrja 1, Kati 2,Tirane.
Email: arabelstudio@gmail.com

Drejtuës i projektit

Adm. Ana NISHKU

Inxh. Ardi ARKAXHIU

Projektues

Nd. Ardi ARKAXHIU

Ark.Rigert HYRA

Gjeo.Irfan BEGAJ

Elek. Altin ALLKAJ

Top. Mustafa HOXHAI

Hid. Hajredin MURGU

SHKALLA

-

Vorë 2018

FLETA

6 - 00

Format A3

ARMIMI I TUBAVE ME D=150

PER MBUSHJE 4.5M

PRERJE TERTHORE

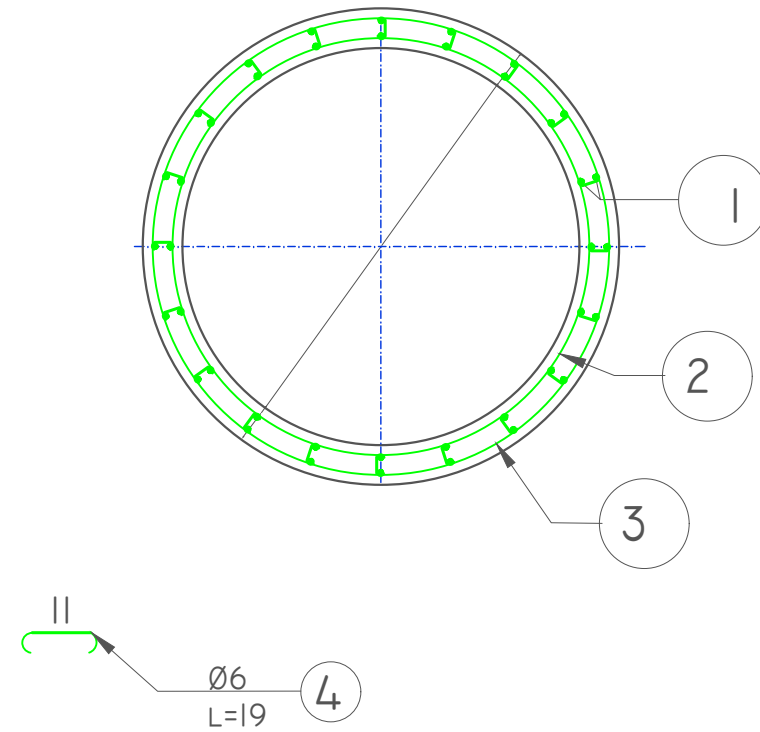

PRERJE GJATESORE

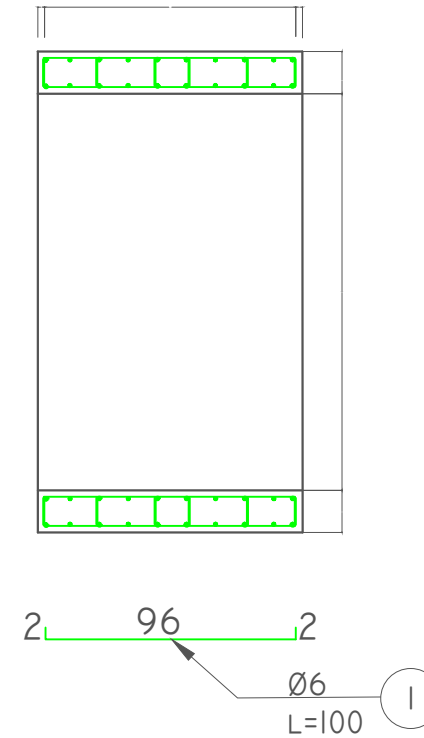

SASIA E HEKURIT PER NJE TUB

POZ NR	Ø mm	L cm	SASIA COPE	L m	ARMATURA PER NJE ELEMENT			
					Ø mm	Σ Lm	PESHA kg/ml	PESHA kg
1	6	100	40	40	6	49.50	0.222	11
2	12	4212	1	42.12	12	89.10	0.888	79.1
3	12	4693	1	46.93				
4	6	19	50	9.5				
HEKUR FeB 44K PER NJE TUB							kg	90.1
BETON M-200 PER NJE TUB							m ³	0.72

ARMATURA SPIRALE

E JASHEME

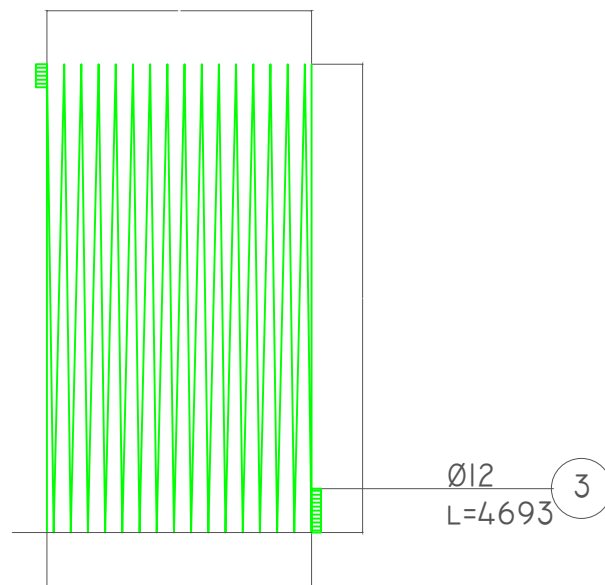

E BRENDESHME

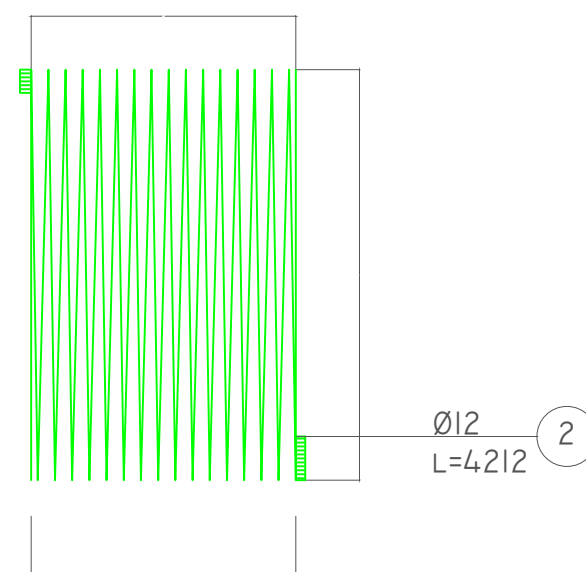

POROSITESI : BASHKIA VORË

OBJEKTI:
"NDERTIMI I KANALIT DOMJE DHE NDRICIMI RRUGES"

Emertimi: ARMIMI I TOMBINOS 1500mm



"ARABEL - STUDIO" Sh.p.k
Adresa: Njesia Bashkiake nr.7, Rruga "Frosina Plaku",
Pallati 21, Hyrja 1, Kati 2, Tirane.
Email: arabelstudio@gmail.com

Drejtues i projektit

Adm. Ana NISHKU
Inxh. Ardi ARKAXHIU

Projektues

Nd. Ardi ARKAXHIU
Ark.Rigert HYRA
Gjeo.Irfan BEGAJ
Elek. Altin ALLKAJ
Top. Mustafa HOXHAI
Hid. Hajredin MURGU

SHKALLA

-

Vorë 2018

FLETA

6 - 01

Format A3

ARMIMI I PUSITES KONTROLLI

2x1.5x2m

PRERJA TERTHORE



TABELA E VOLUMEVE								
No.	Ø mm	L cm	Pieces pc	ΣL ml	Summary Steel Table			
					Ø mm	ΣL ml	U. Weightkg/m	Total Weight kg
1	12	270	86	208.12	12	880.7	0.887	781.2
2	12	214	88	188.32				
3	12	232	80	185.60				
4	12	232	80	185.6000				
Steel 420S / Hekur S420							Kg	781.23
Concrete C20/25 / Beton C20/25							m³	5.50



POROSITESI : BASHKIA VORE

OBJEKTI: "NDERTIMI I KANALIT DOMJE DHE NDRICIMI RRUGES"

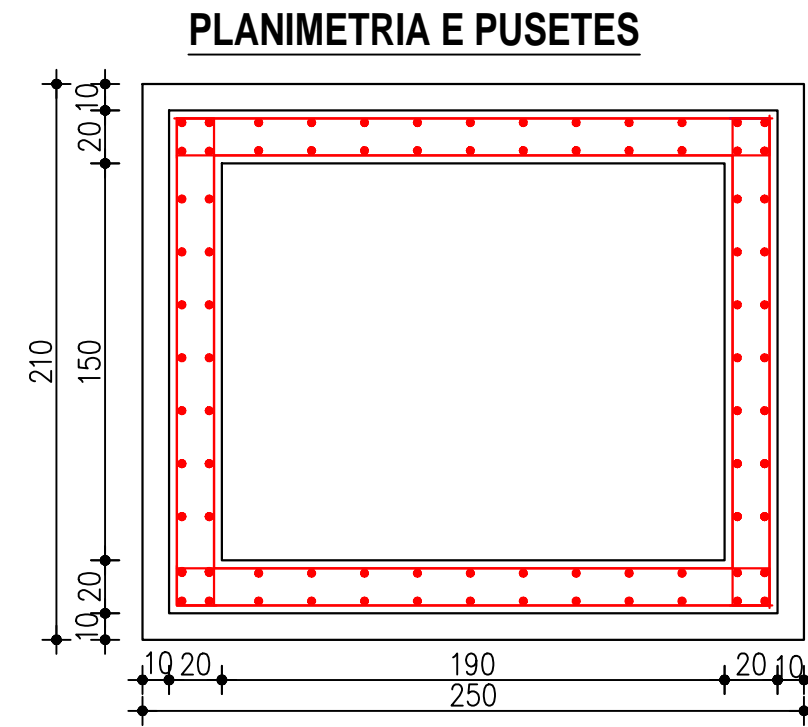
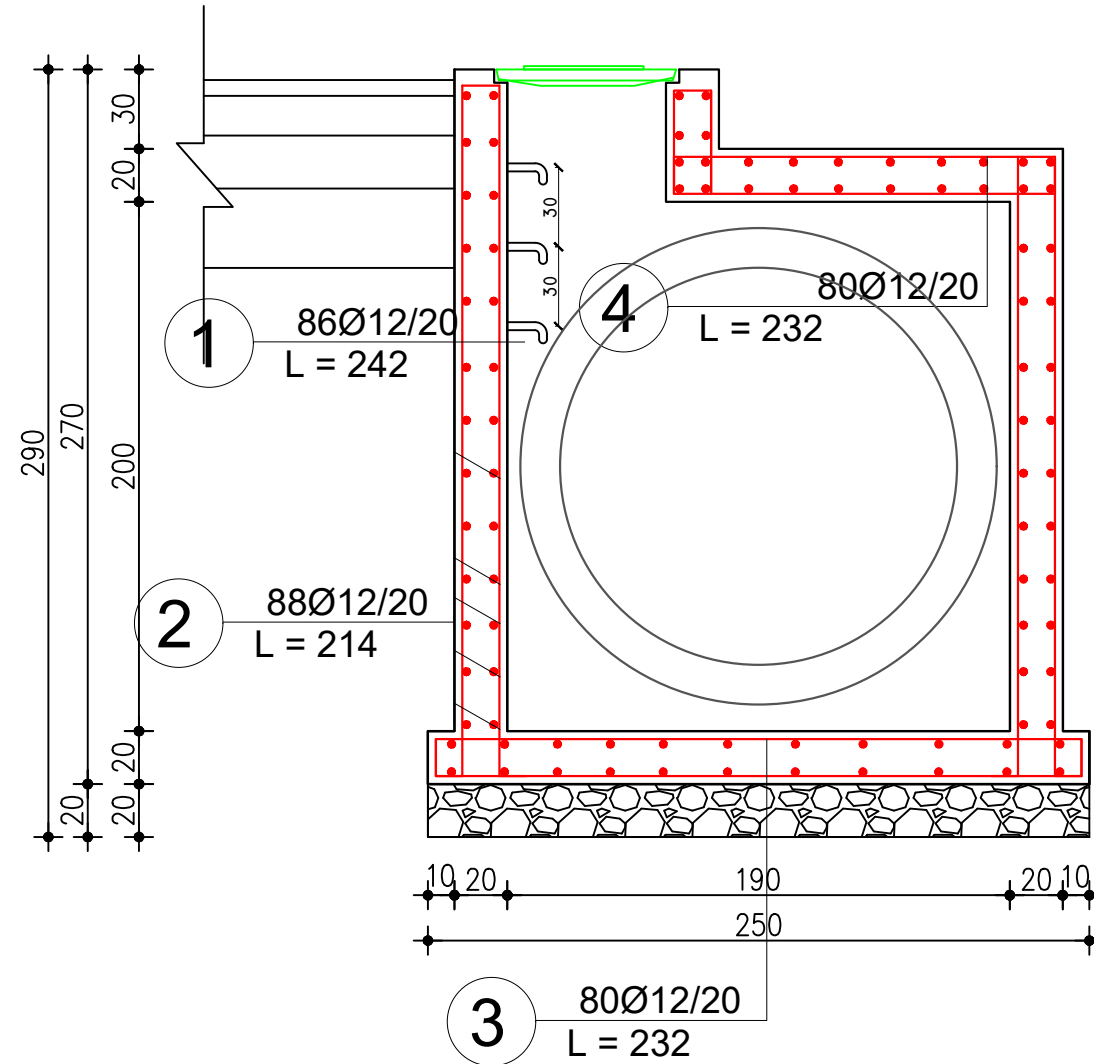
Emertimi: ARMIMI I PUSITES



"ARABEL - STUDIO" Sh.p.k
 Adresa: Njesia Bashkiake nr.7, Rruga "Frosina Plaku",
 Pallati 21, Hyrja 1, Kati 2, Tirane.
 Email: arabelstudio@gmail.com

Drejtesues i projektit

Adm. Ana NISHKU

Inxh. Ardi ARKAXHIU

Projektues

Nd. Ardi ARKAXHIU

Ark.Rigert HYRA

Gjeo.Irfan BEGAJ

Elek. Altin ALLKAJ

Top. Mustafa HOXHAI

Hid. Hajredin MURGU

SHKALLA

SH 1-50

VORE 2018

FLETA

6-02

Format A3

PUSETE KONTROLLI PER UJRAT E SHIUT

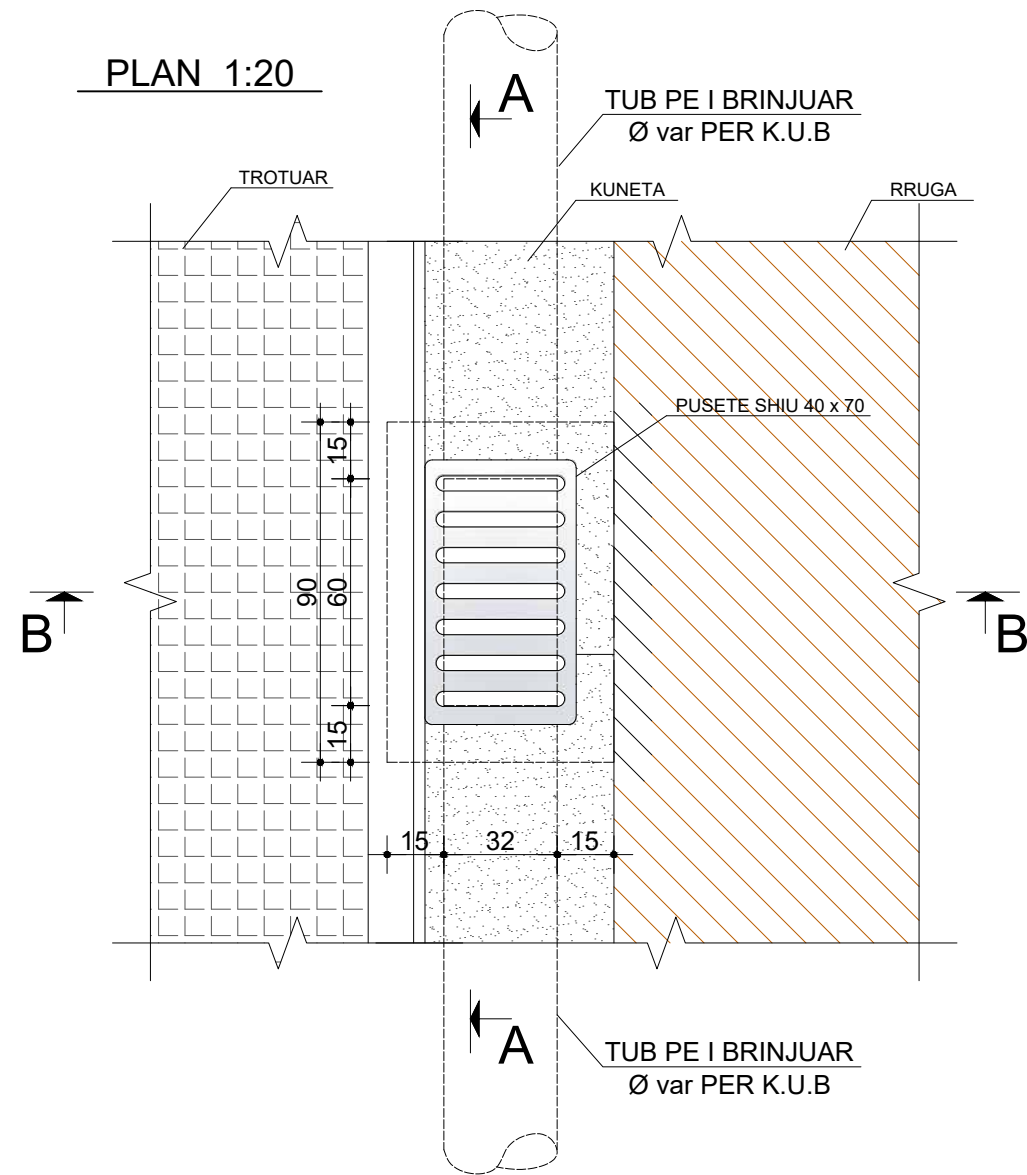

PRERJE A-A 1:25

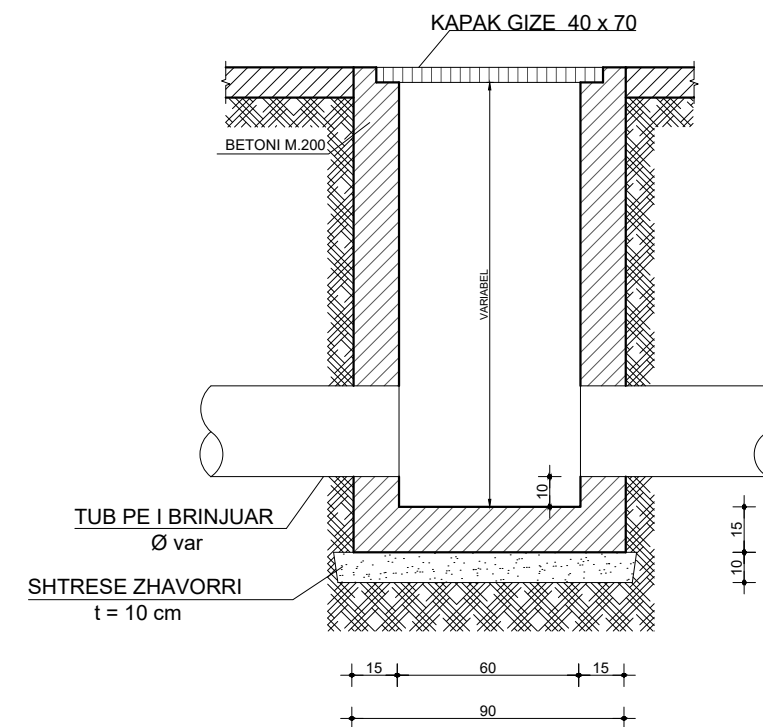

**PRERJE B-B 1:25
(PER TUBA PE D=315mm)**

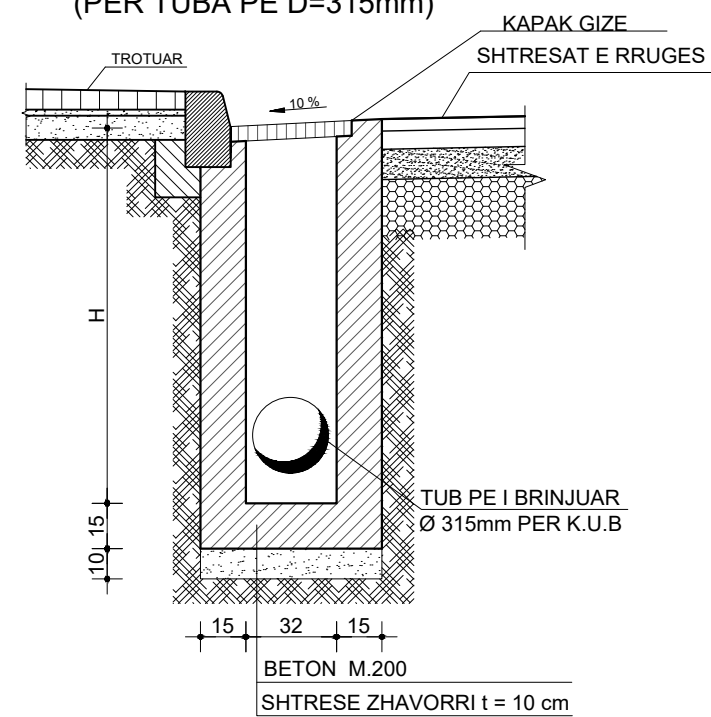

*Dimensionet ne cm



POROSITESI : BASHKIA VORE

OBJEKTI: "NDERTIMI I KANALIT DOMJE DHE NDRICIMI RRUGES"

Emertimi: DETAJ PUSETA SHIMBLEDEHESE



"ARABEL - STUDIO" Sh.p.k

Adresa: Njesia Bashkiake nr.7, Rruga "Frosina Plaku",
Pallati 21, Hyrja 1, Kati 2, Tirane.
Email: arabelstudio@gmail.com

Drejtesues i projektit

Adm. Ana NISHKU

Inxh. Ardi ARKAXHIU

Projektues

Nd. Ardi ARKAXHIU

Ark.Rigert HYRA

Gieo.Irfan BEGAJ

Elek. Altin ALLKAJ

Top. Mustafa HOXHAI

Hid. Hajredin MURGU

SHKALLA

SH 1-50

VORE 2018

FLETA

6.03

Format A3

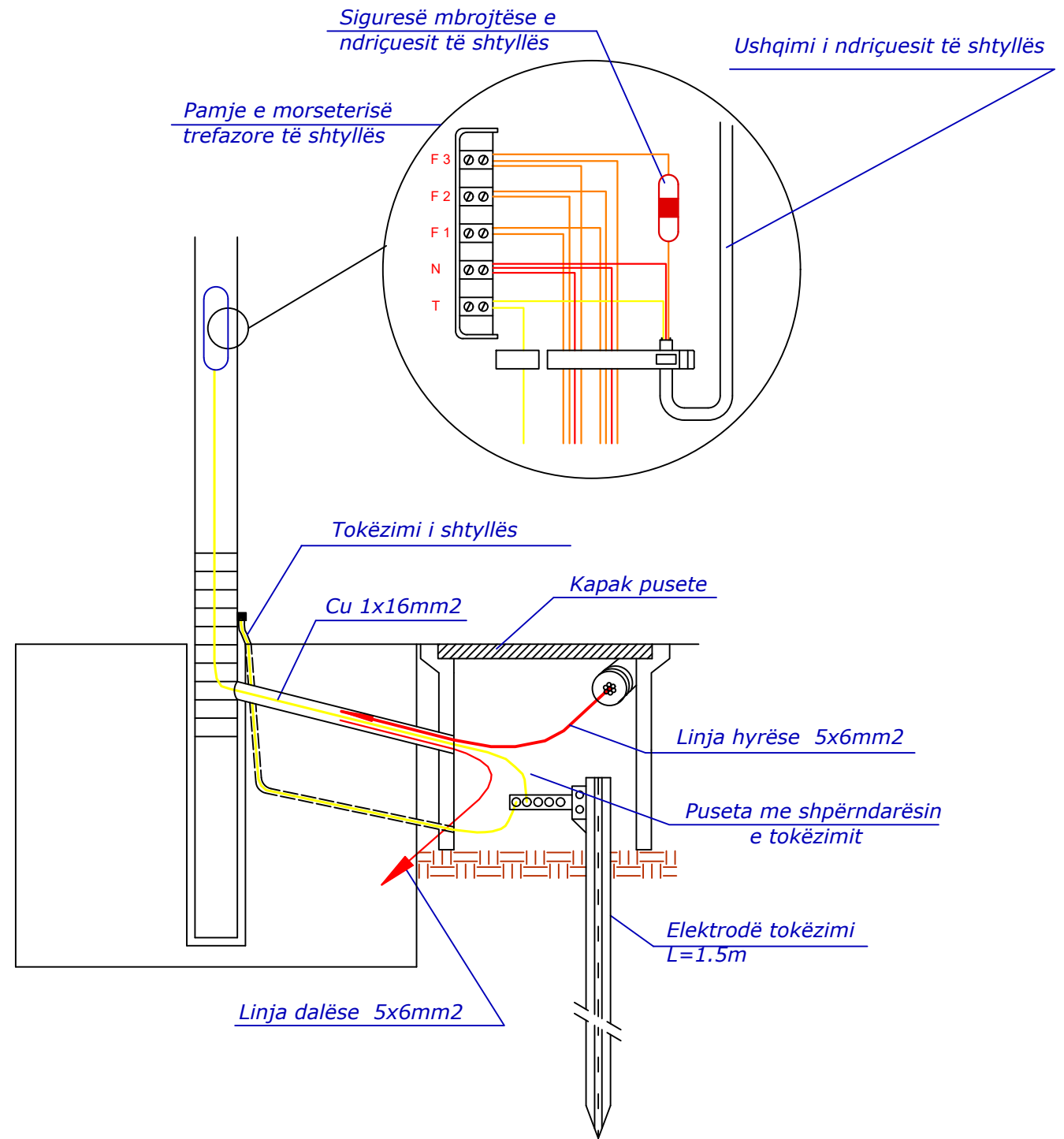
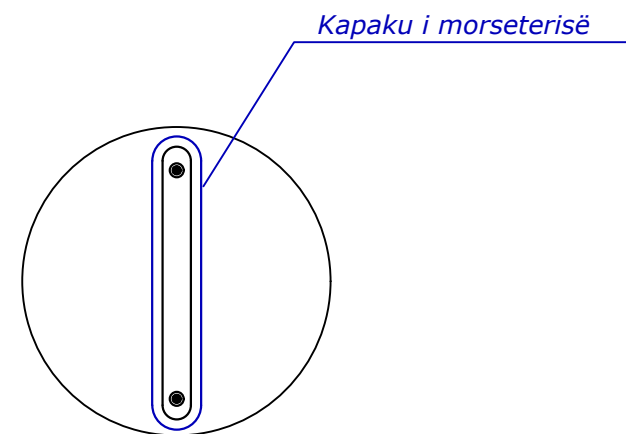
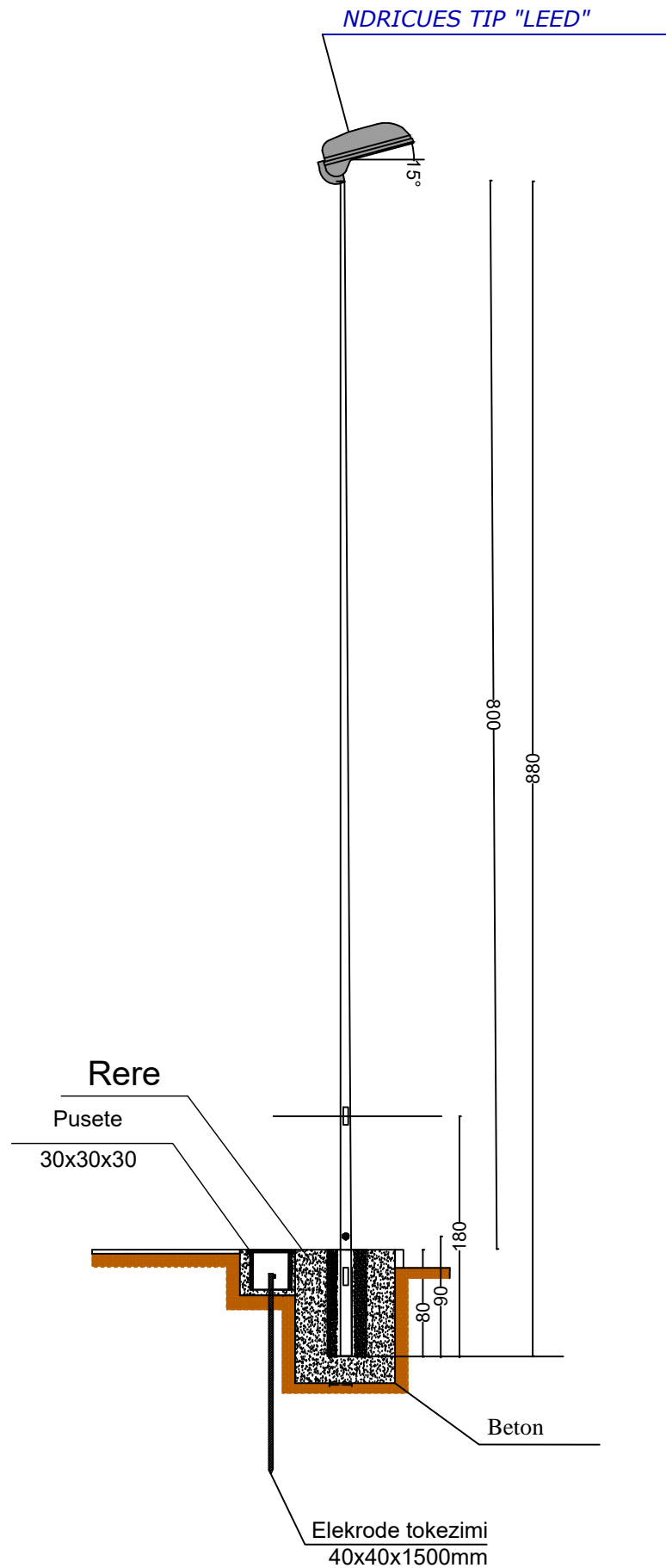

POROSITESI : BASHKIA VORE
 OBJEKTI: "NDERTIMI I KANALIT DOMJE DHE NDRICIMI RRUGES"

Emertimi: DETAJE ELEKTRIKE
"ARABEL - STUDIO" Sh.p.k
 Adresa: Njesia Bashkiake nr.7, Rruga "Frosina Plaku",
 Pallati 21, Hyrja 1, Kati 2, Tirane.
 Email: arabelstudio@gmail.com

Drejtues i projektit
 Adm. Ana NISHKU
 Inxh. Ardi ARKAXHIU

Projektues
 Nd. Ardi ARKAXHIU
 Ark.Rigert HYRA
 Gjeo.Irfan BEGAJ
 Elek. Altin ALLKAJ
 Top. Mustafa HOXHAI
 Hid. Hajredin MURGU

SHKALLA	FLETA
SH 1-50	6-04
VORE 2018	Format A3

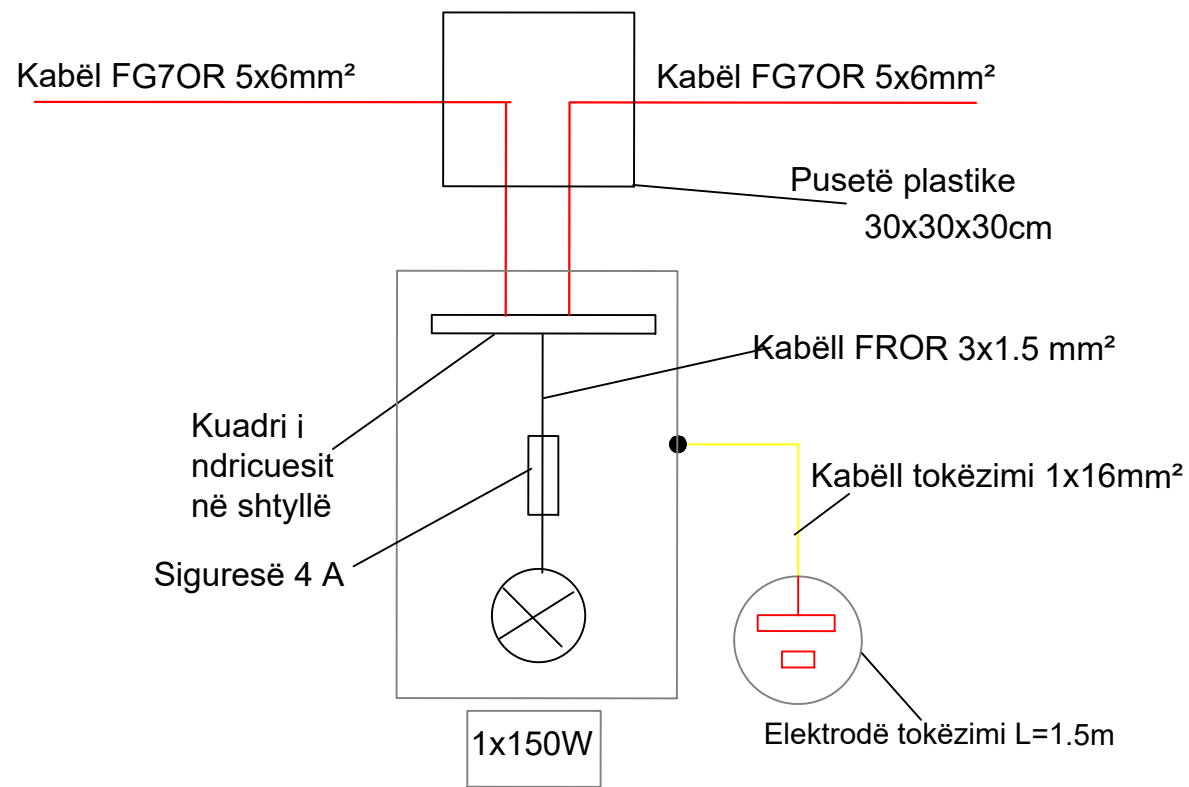

Hollësi e inkastrimit të kolonës së ndriçuesit me lartësi H=8.0m

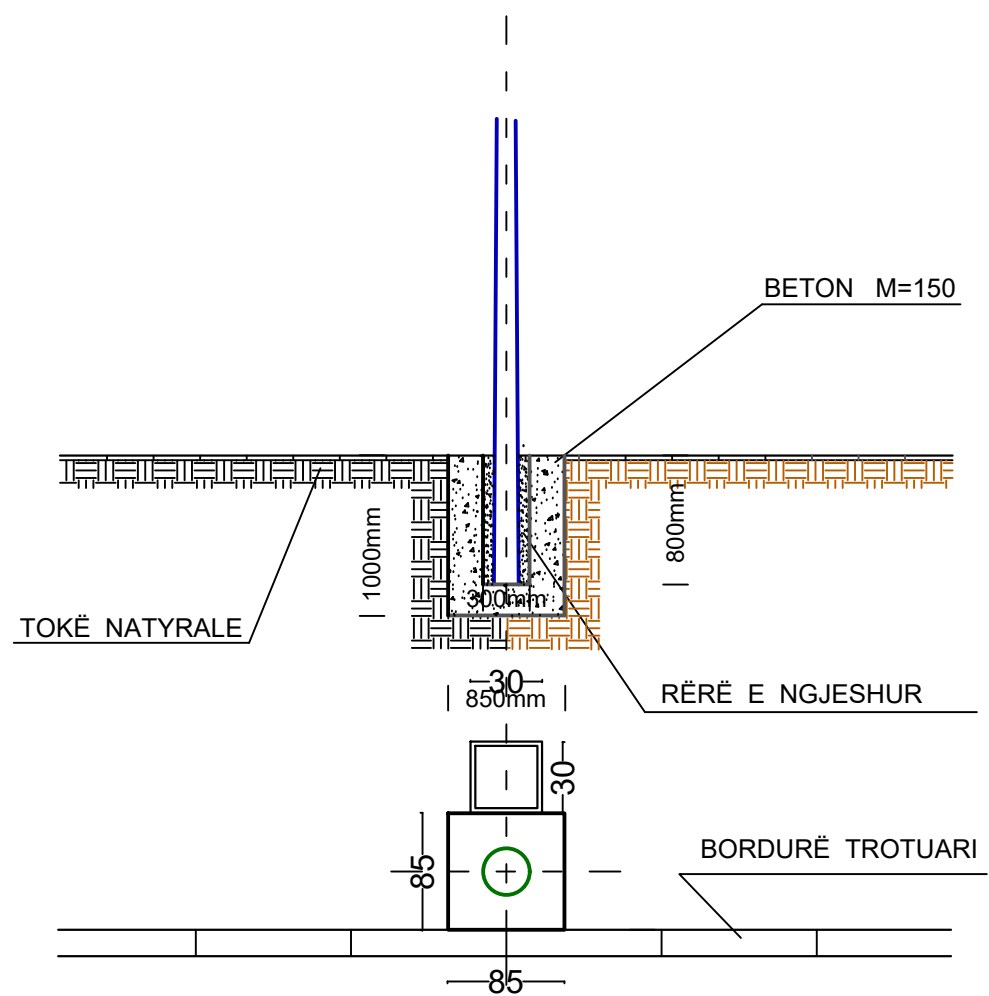

Konstruksioni morseterisë

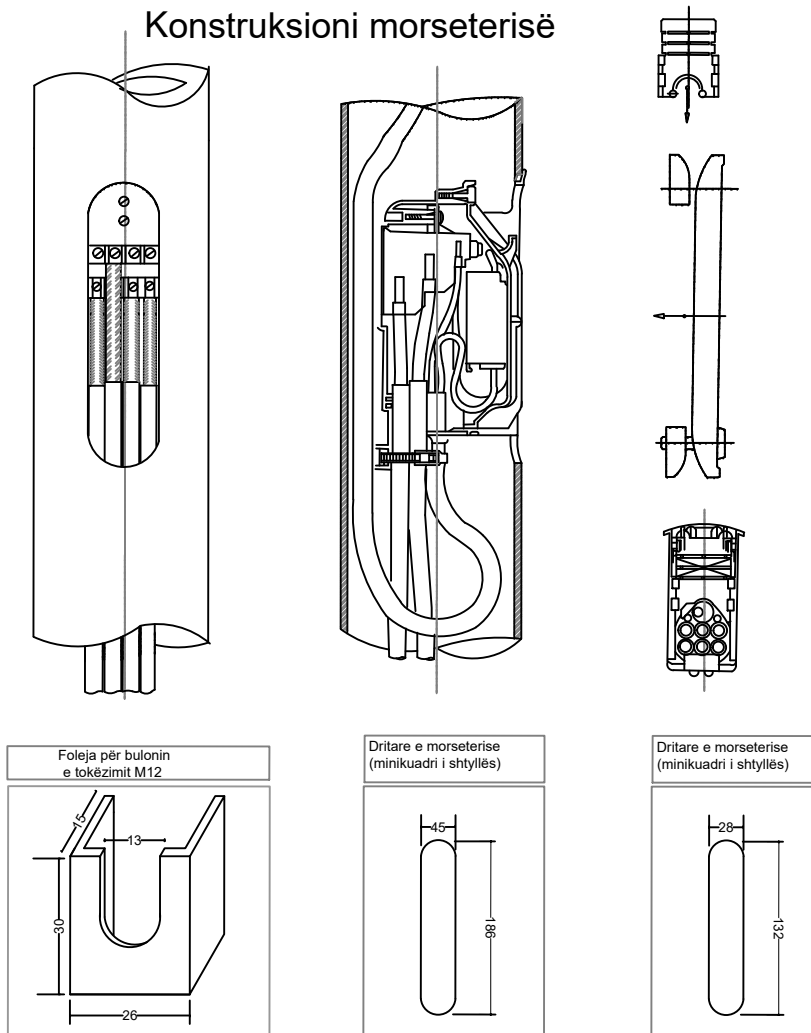

Detaj i tokëzimit të shtyllës së ndriçimit

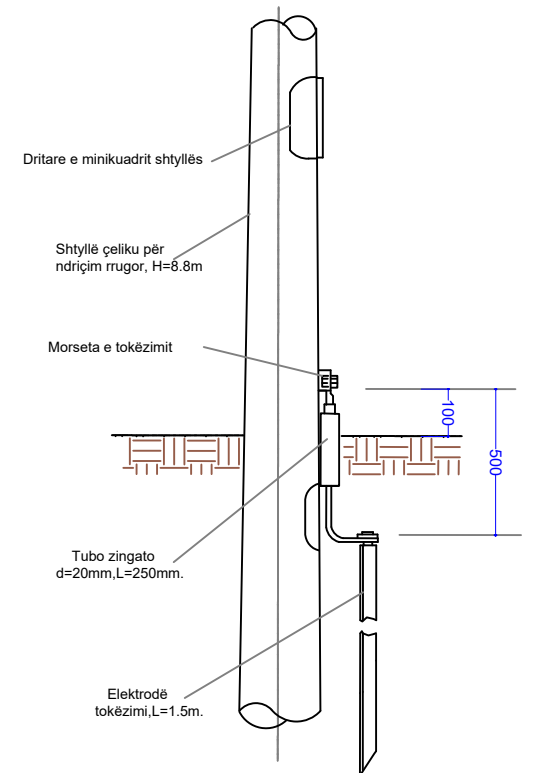

Hollësi e vendosjes së pusetës

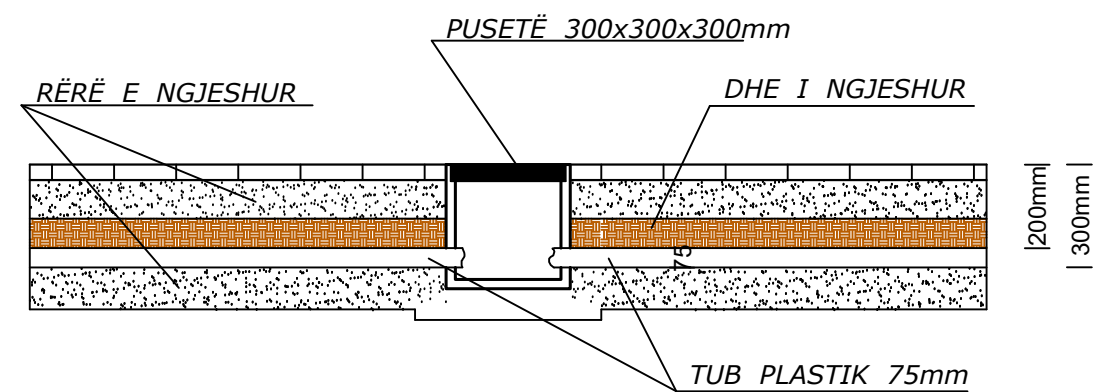

POROSITESI : BASHKIA VORE

OBJEKTI: "NDERTIMI I KANALIT DOMJE DHE NDRICIMI RRUGES"

Emertimi: DETAJE ELEKTRIKE



"ARABEL - STUDIO" Sh.p.k

Adresa: Njesia Bashkiake nr.7, Rruga "Frosina Plaku",
Pallati 21, Hyrja 1, Kati 2, Tirane.
Email: arabelstudio@gmail.com

Drejtues i projektit

Adm. Ana NISHKU

Inxh. Ardi ARKAXHIU

Projektues

Nd. Ardi ARKAXHIU

Ark.Rigert HYRA

Gjeo.Irfan BEGAJ

Elek. Altin ALLKAJ

Top. Mustafa HOXHAI

Hid. Hajredin MURGU

SHKALLA

SH 1-50

VORE 2018

FLETA

6-05

Format A3

Planimetria e instalimit të rrjetit kabllor të ndriçimit,

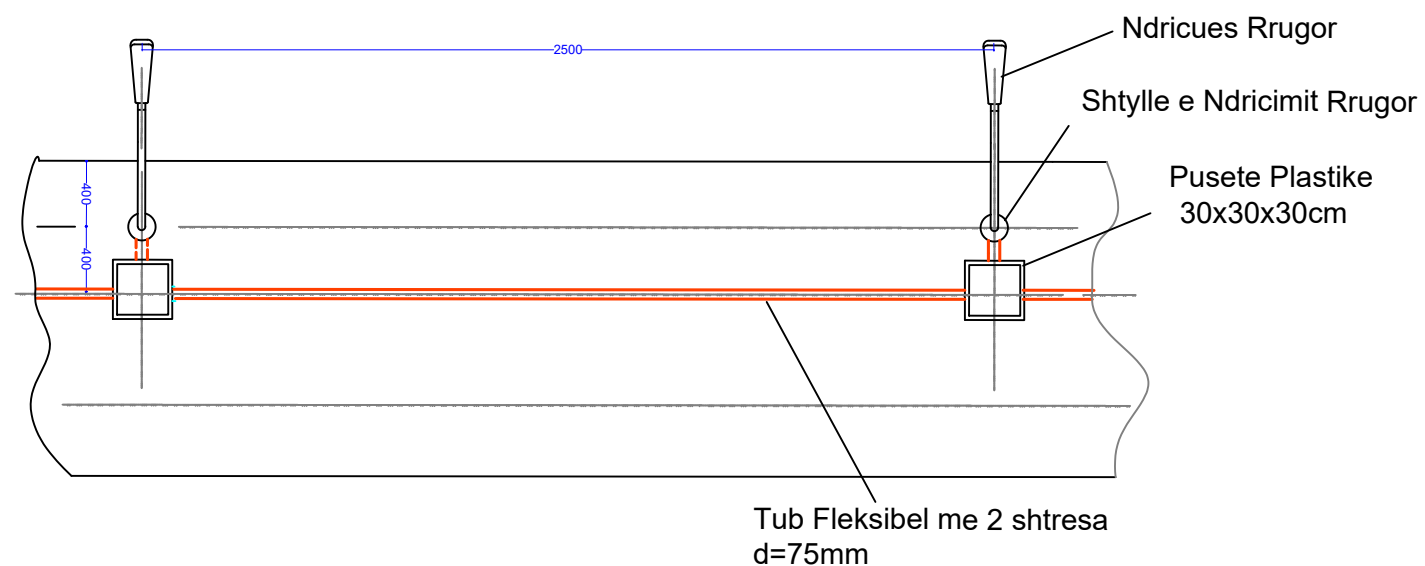

Detaj i montimit te pusetes dhe tokezimit te shtylles

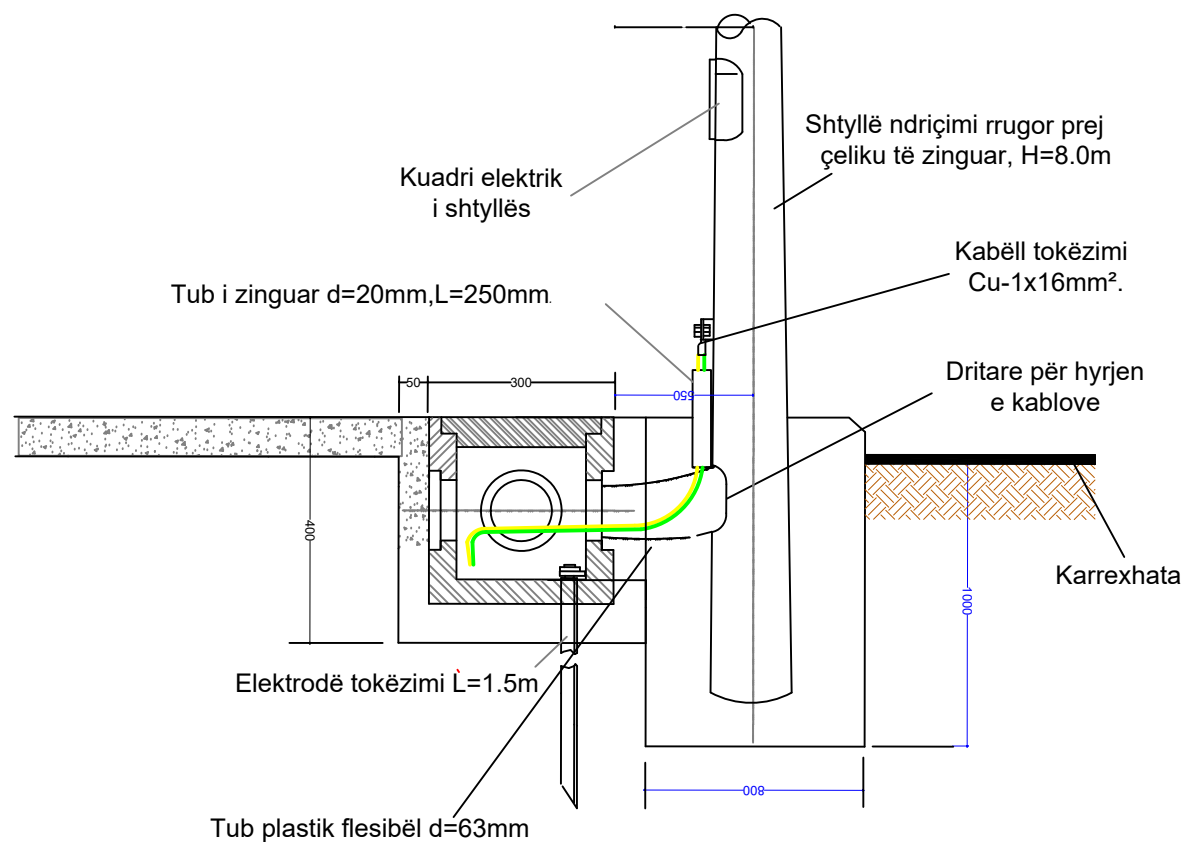

Shtrimi i kablove te TU ne TP.direkt ne toke

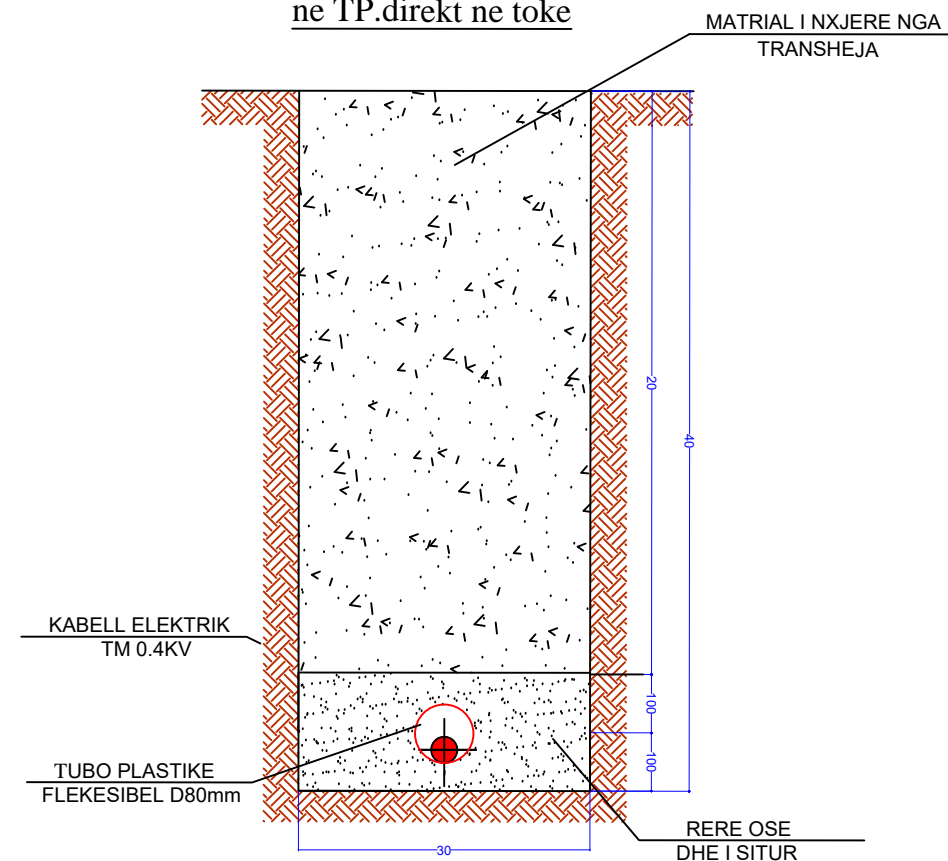

Shtrimi i kablove te TU ne trasversimin e rrugeve

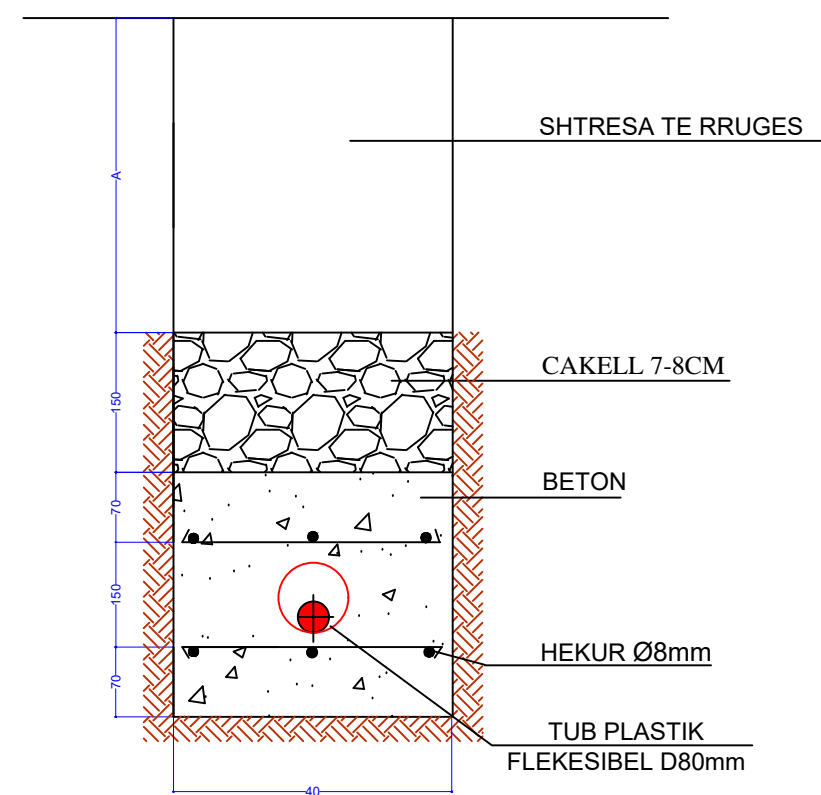

POROSITESI : BASHKIA VORE

OBJEKTI: "NDERTIMI I KANALIT DOMJE DHE NDRICIMI RRUGES"

Emertimi: DETAJE ELEKTRIKE



"ARABEL - STUDIO" Sh.p.k

Adresa: Njesia Bashkiake nr.7, Rruga "Frosina Plaku",
Pallati 21, Hyrja 1, Kati 2, Tirane.
Email: arabelstudio@gmail.com

Drejtues i projektit

Adm. Ana NISHKU

Inxh. Ardi ARKAXHIU

Projektues

Nd. Ardi ARKAXHIU

Ark.Rigert HYRA

Gjeo.Irfan BEGAJ

Elek. Altin ALLKAJ

Top. Mustafa HOXHAI

Hid. Hajredin MURGU

SHKALLA

SH 1-50

VORE 2018

FLETA

6-06

Format A3

DETAJI PANDUSIT

PRERJA A-A SHK.1:50

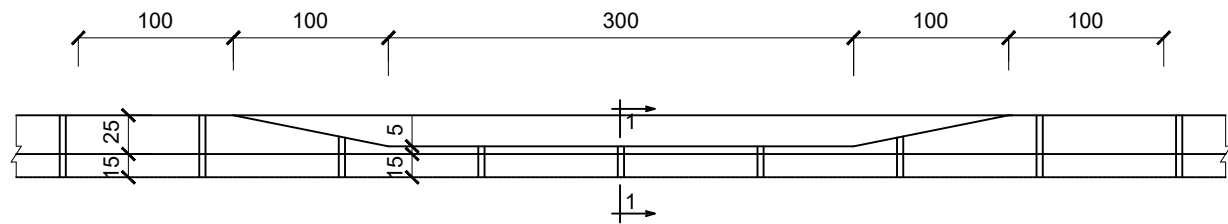

PLAN SHK.1:50

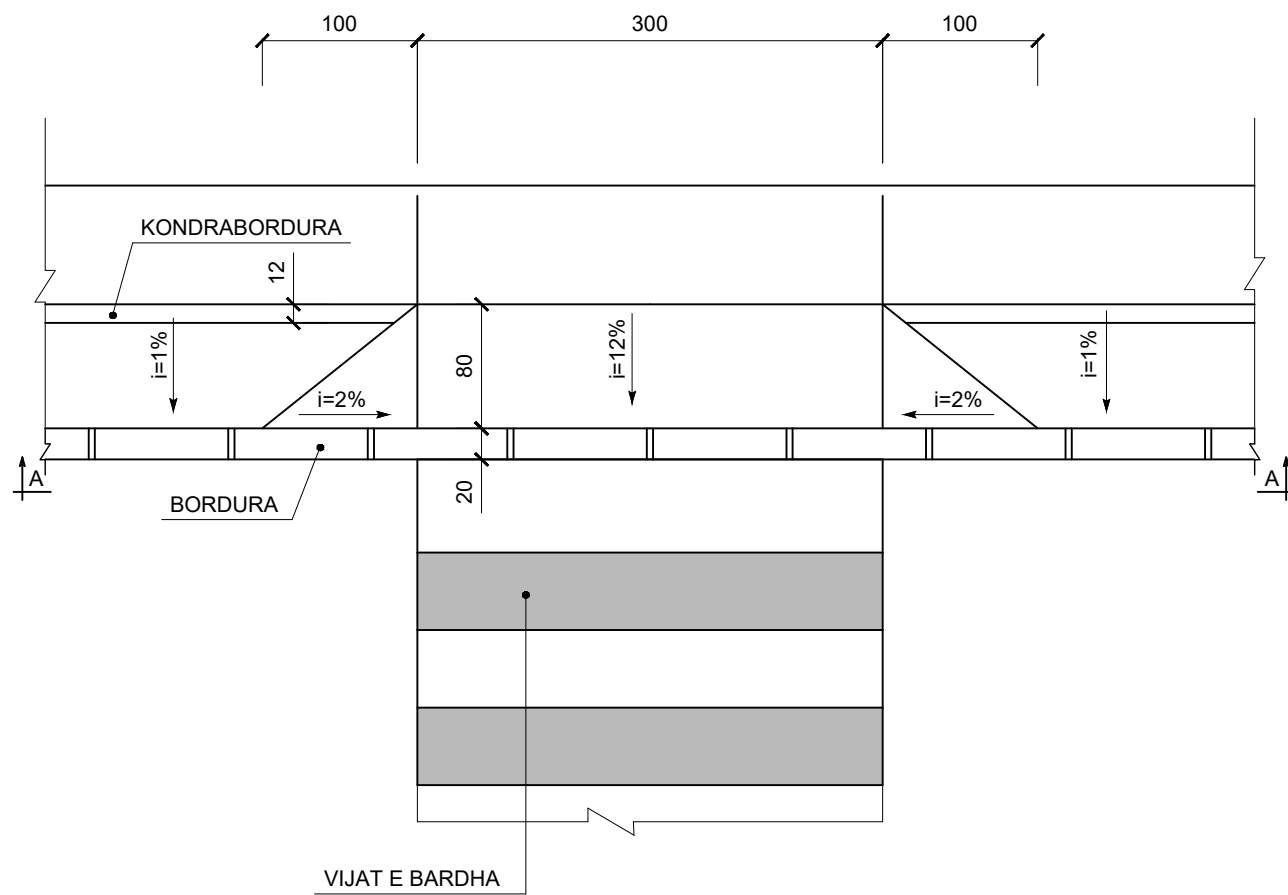

DETAJI I PRERJES SE RRUGES ME PANDUS SH 1:15

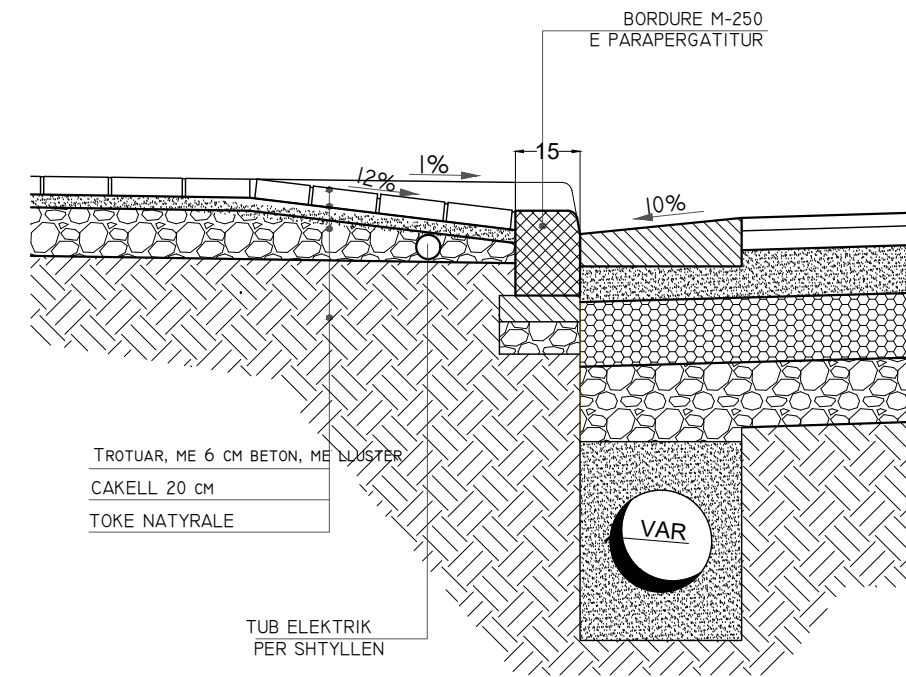

Detaji i Bordurës dhe kunetes Sh 1:15

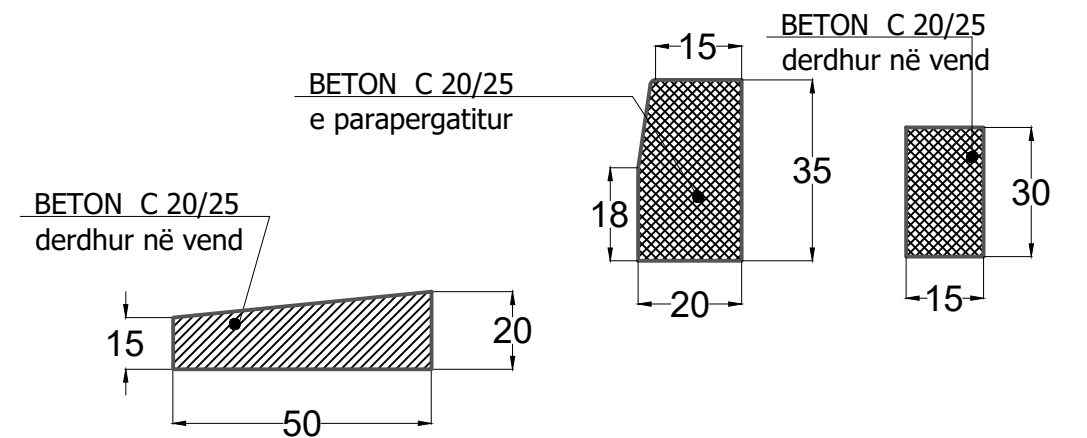

Shënim:
NE CDO PIKE KU KRYQEZOHET RRUGA KRYESORE ME RRUGET DYTESORE DO TE VENDOSEN PANDUSET E TROTUAREVE

*Dimensionet ne cm



POROSITESI : BASHKIA VORE

OBJEKTI: "NDERTIMI I KANALIT DOMJE DHE NDRICIMI RRUGES"

Emertimi: DETAJE TROTUARI



"ARABEL - STUDIO" Sh.p.k

Adresa: Njesia Bashkiake nr.7, Rruga "Frosina Plaku",
Pallati 21, Hyrja 1, Kati 2, Tirane.
Email: arabelstudio@gmail.com

Drejtues i projektit

Adm. Ana NISHKU

Inxh. Ardi ARKAXHIU

Projektues

Nd. Ardi ARKAXHIU

Ark.Rigert HYRA

Gjeo.Irfan BEGAJ

Elek. Altin ALLKAJ

Top. Mustafa HOXHAI

Hid. Hajredin MURGU

SHKALLA

SH 1-50

VORE 2018

FLETA

6-07

Format A3

DETAJE TE SINJALISTIKES

SHENJA LAJMERUESE WARNING SIGN

LAJMERIM PER NDERPRERJE NGA RRUGE DYTESORE, KTHESAT E KURBEZUARA,
FEMIJET, KEMBESORET DHE PER NDALJE/DHENIE RRUGE
WARNING SIGN INTERSECTION OF SECONDARY ROAD, WARNING SIGN CURVE,
WARNING SIGN PEDESTRAIN & CHILDREN'S, STOP & GIVE WAY SIGN

TREKENDESHI: E KUQE REFLEKTUESE
SFONDI: I ZI
SIMBOLI: E BARDHE REFLEKTUESE

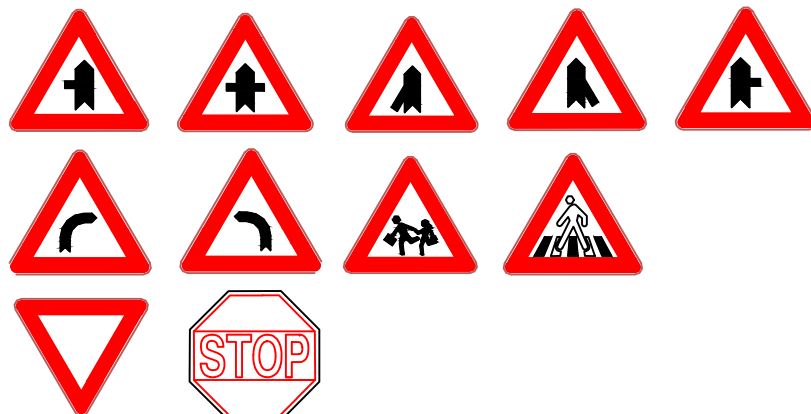

TRIANGLE: RED REFLECTIVE
BACKGROUND: WHITE REFLECTIVE
SYMBOL: BLACK

SHENJA NDALUESE PROHIBIT SIGN

SHENJAT PER KUFIRIN E SHPEJTESISE DHE NDALIM PARAKALIMIN
SPEED LIMIT SIGN & OVERTAKE PROHIBIT

RRETHI: E KUQE REFLEKTUESE
SHENJA: E ZEZE REFLEKTUESE
CIRCLE: RED REFLECTIVE
SIGN: BLACK REFLECTIVE

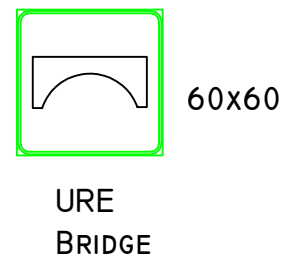
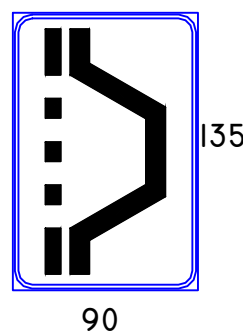
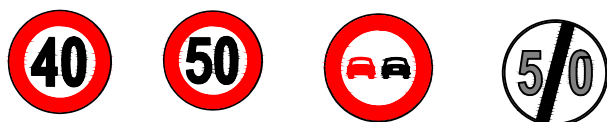

SHENJA DETYRUESE OBLIGATORY SIGN

ANET & SHIGJETAT: E BARDHE REFLEKTUESE
SFONDI: BLU REFLEKTUESE KL 2

EDGE & ARROW: WHITE REFLECTIVE
BACKGROUND: BLUE REFLECTIVE CL 2



SHENJA PLOTESUESE COMPLEMENTARY SIGN

SHENJA E KTHESES NE NJE DREJTIM & DY DREJTIME CHEVRON SIGNS ONE DIRECTION & TWO DIRECTION

SHENJA : E BARDHE REFLEKTUESE
SFONDI: E ZEZE
SIGN : WHITE REFLECTIVE
BACKGROUND: BLACK



SHENJA INFORMUESE INFORMATION SIGN

SHENIM: SHENJAT RRUGORE PER NGA FORMA, MADHESIA, NGJYRA REFLEKTIVITETI DUHET TE JENE SIPAS KODIT RRUGOR TE REPUBLIKES SE SHQIPERISE
MATERIALI PRAPAREFLEKTIV DUHET TE KETE JETEGJATESI 10VJET PER CLASIN 2 DHE 7 VJET PER CLASIN 1
SIMBOLI BRENDA SHENJES RRUGORE DUHET TE JETE I REALIZUAR ME BOJE TE TRAJTUAR ME PJEKJE E CILA NUK HUMBET TREGUESIT PRAPAREFLEKTIV
SHENJA RRUGORE REALIZOHET ME LLAMARINE ÇELIKU E CILA LYHET ME BOJE OPAKE KUNDRANDRA KOROZIONITDHE TRAJTOHET ME PJEKJE.



POROSITESI : BASHKIA VORË

OBJEKTI:
"NDERTIMI I KANALIT DOMJE DHE NDRICIMI RRUGES"

Emertimi: DETAJ SINJALISTIKE



"ARABEL - STUDIO" Sh.p.k
Adresa: Njesia Bashkiake nr.7, Rruga "Frosina Plaku",
Pallati 21, Hyrja 1, Kati 2, Tirane.
Email: arabelstudio@gmail.com

Drejtues i projektit

Adm. Ana NISHKU

Inxh. Ardi ARKAXHIU

Projektues

Nd. Ardi ARKAXHIU

Ark.Rigert HYRA

Gjeo.Irfan BEGAJ

Elek. Altin ALLKAJ

Top. Mustafa HOXHAI

Hid. Hajredin MURGU

SHKALLA

-

Vorë 2018

FLETA

6 - 08

Format A3

DETAJE TE SINJALISTIKES

TIPET E VIZIMEVE TE RRUGES ROAD MARKING LINES TYPE

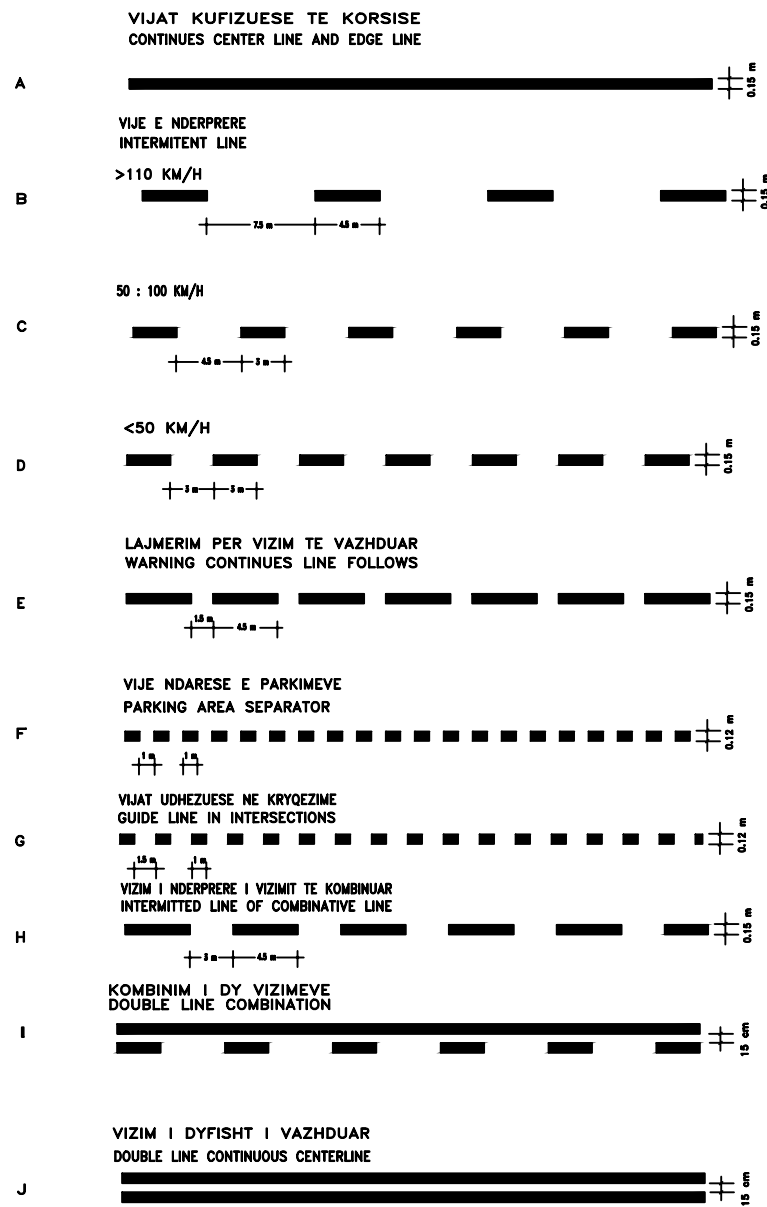

KALIMET E KEMBESOREVE PEDESTRIANS CROSSING

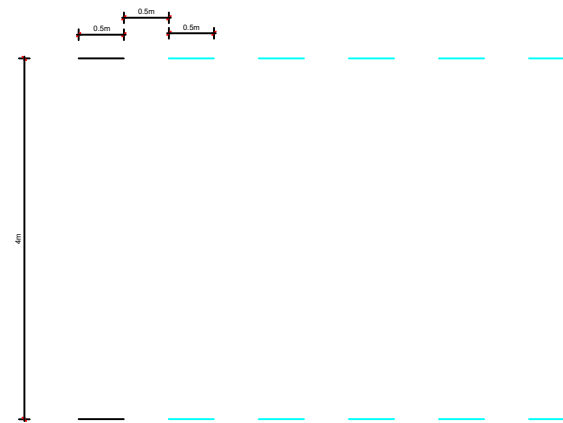

SHIGJETAT TREGUESE TE RRUGES ROAD MARKING ARROWS

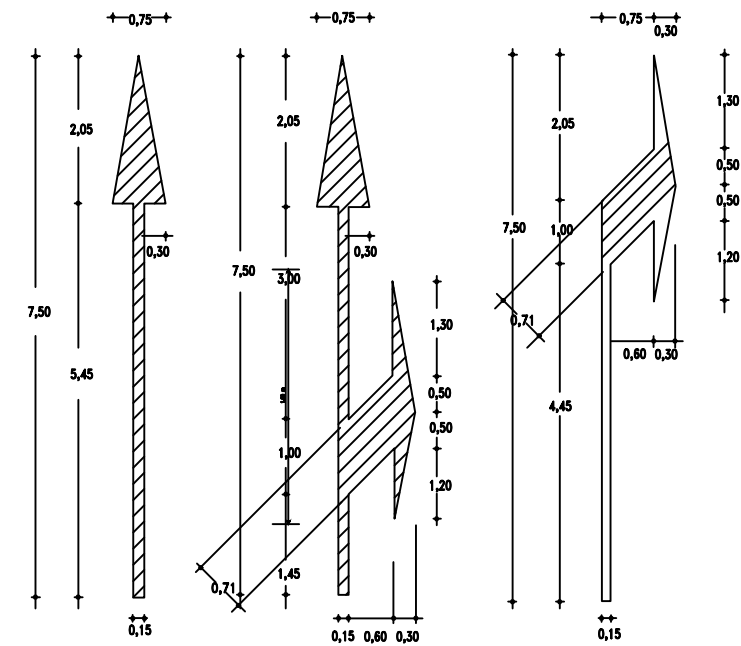

DHENIE PERPARESE GIVE WAY ROAD SIGN

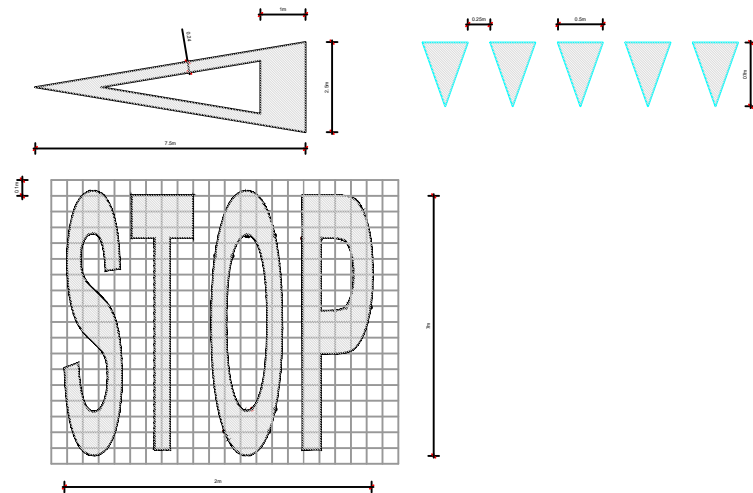

VIZIMI I RRUGES ROAD PAINTING

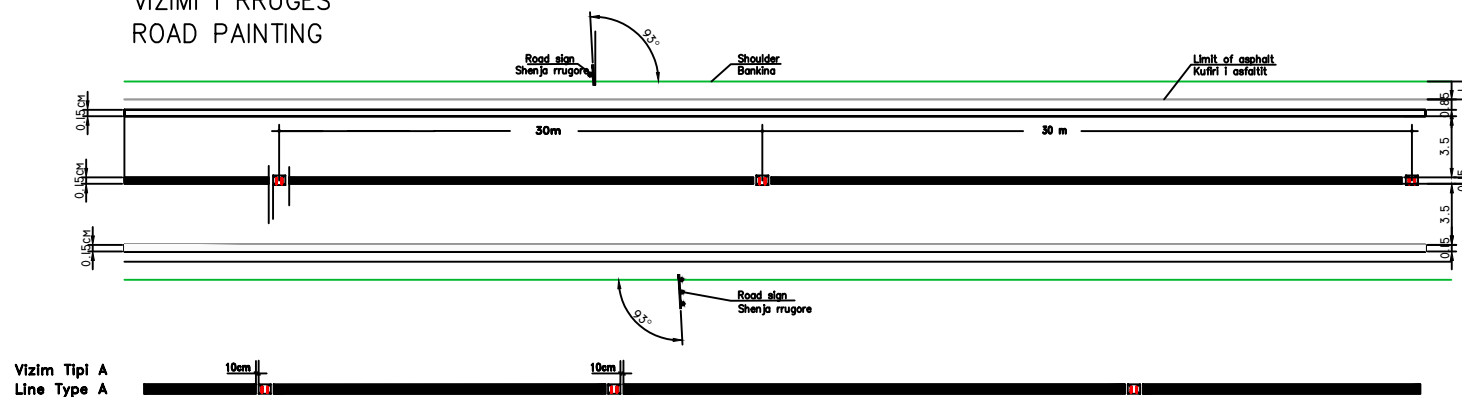

POROSITESI : BASHKIA VORË

OBJEKTI:
"NDERTIMI I KANALIT DOMJE DHE NDRICIMI RRUGES"

Emertimi: DETAJ SINJALISTIKE



"ARABEL - STUDIO" Sh.p.k

Adresa: Njesia Bashkiake nr.7, Rruga "Frosina Plaku",
Pallati 21, Hyrja 1, Kati 2, Tirane.
Email: arabelstudio@gmail.com

Drejtues i projektit

Adm. Ana NISHKU

Inxh. Ardi ARKAXHIU

Projektues

Nd. Ardi ARKAXHIU

Ark.Rigert HYRA

Gjeo.Irfan BEGAJ

Elek. Altin ALLKAJ

Top. Mustafa HOXHAIJ

Hid. Hajredin MURGU

SHKALLA

-

Vorë 2018

FLETA

6 - 09

Format A3

DETAJE TE SINJALISTIKES

VENDOSJA E SHENJES RRUGORE

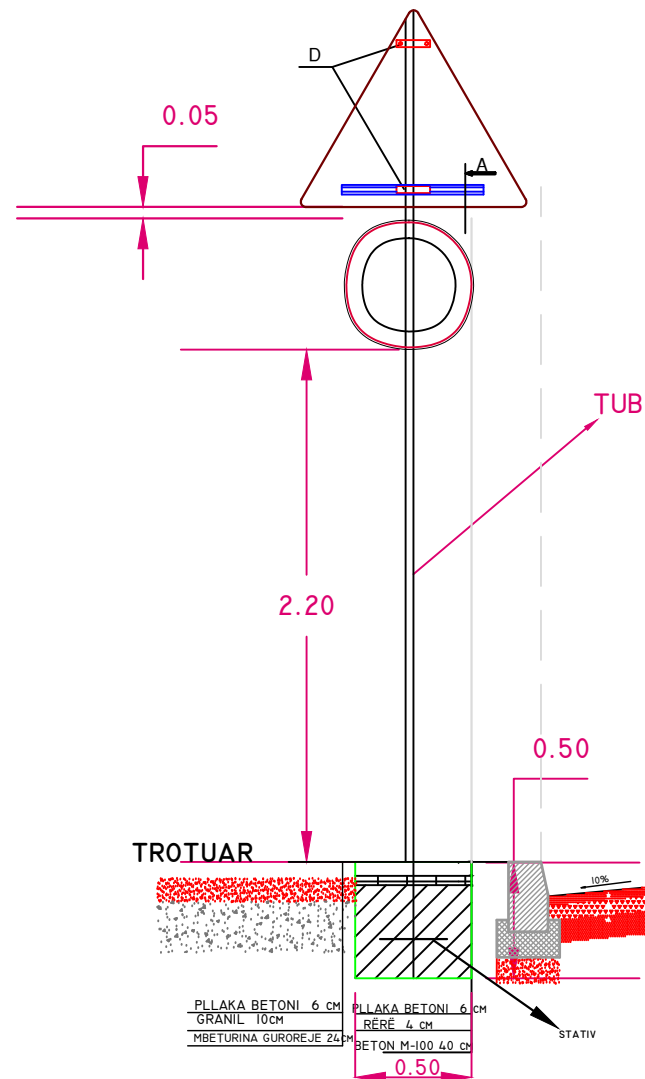
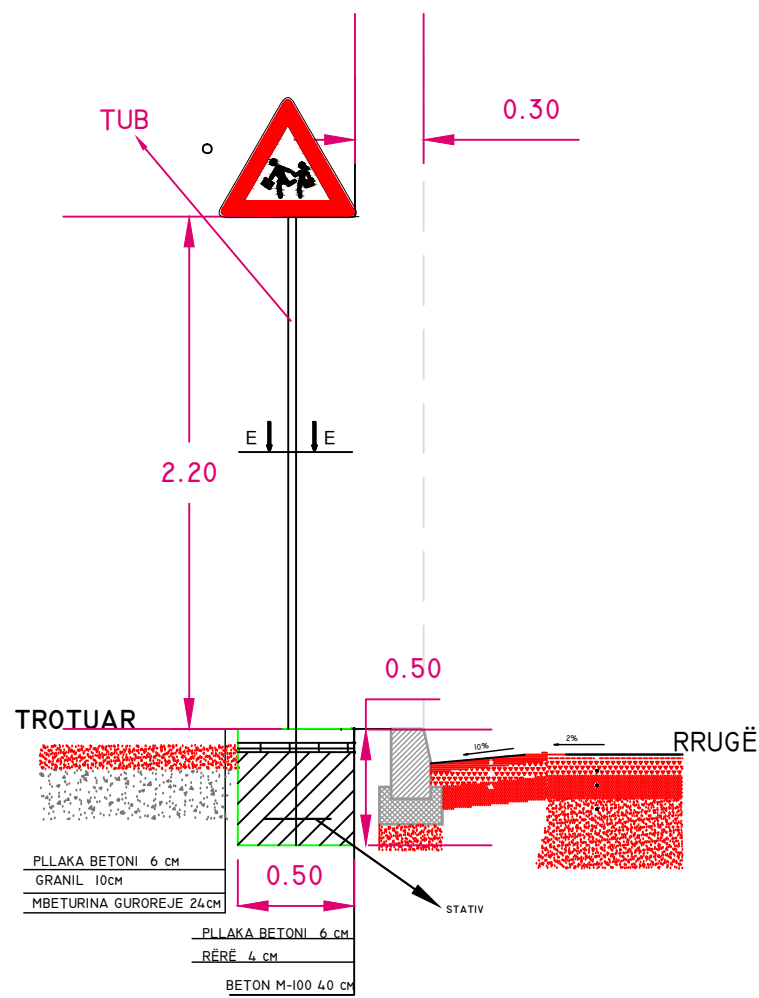

PRERJA TERTHORE E TABELËS

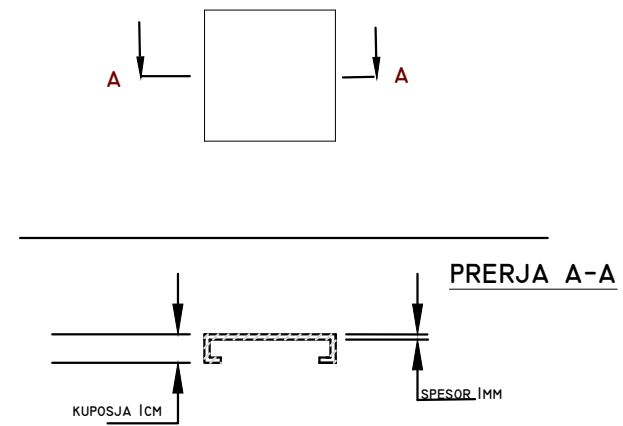

E - E

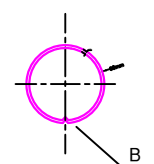

A - A

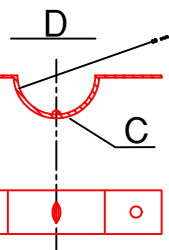
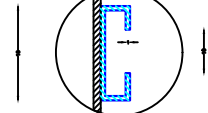

DETAJE Kurrizë artificiale h=5cm

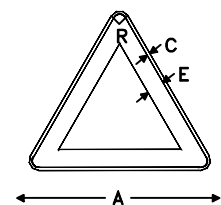
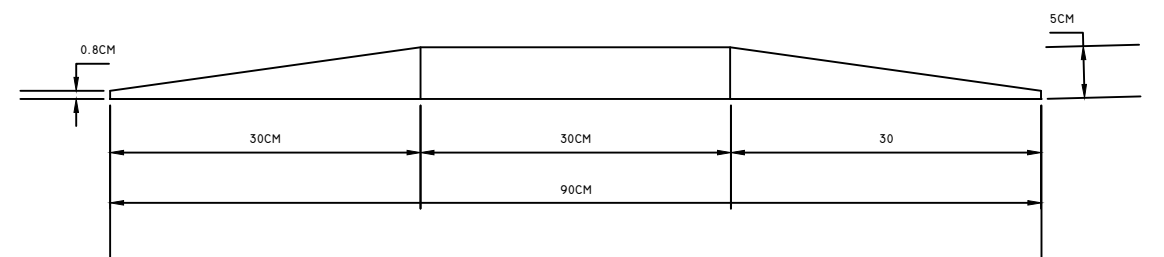

A C E R
90 1.5 8 4.5

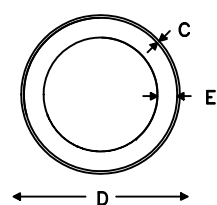

C D E
1 60 7.5

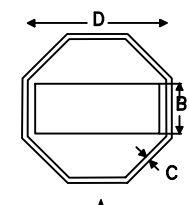

A C E D
90 30 3 75
Dim vogel 60 20 2 50

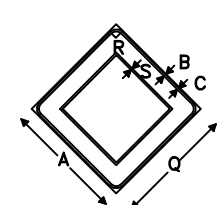

A B C Q R S
60 0.5 1 40 3.5 11

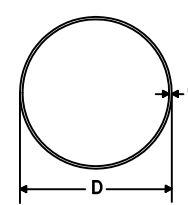

C D
1 60
Dim vogel 0.8 40

POROSITESI : BASHKIA VORË

OBJEKTI:
"NDERTIMI I KANALIT DOMJE DHE NDRICIMI RRUGES"

Emertimi: DETAJ SINJALISTIKE



"ARABEL - STUDIO" Sh.p.k
Adresa: Njesia Bashkiake nr.7, Rruga "Frosina Plaku",
Pallati 21, Hyrja 1, Kati 2, Tirane.
Email: arabelstudio@gmail.com

Drejtues i projektit

Adm. Ana NISHKU
Inxh. Ardi ARKAXHIU

Projektues

Nd. Ardi ARKAXHIU
Ark.Rigert HYRA
Gjeo.Irfan BEGAJ
Elek. Altin ALLKAJ
Top. Mustafa HOXHAI
Hid. Hajredin MURGU

SHKALLA

-
Vorë 2018

FLETA

6 - 10
Format A3

DETAJE TE SINJALISTIKES

Kurrize rruge me asfaltobeton h =7cm me vizime me boje bikomponente

PLANIMETRIA

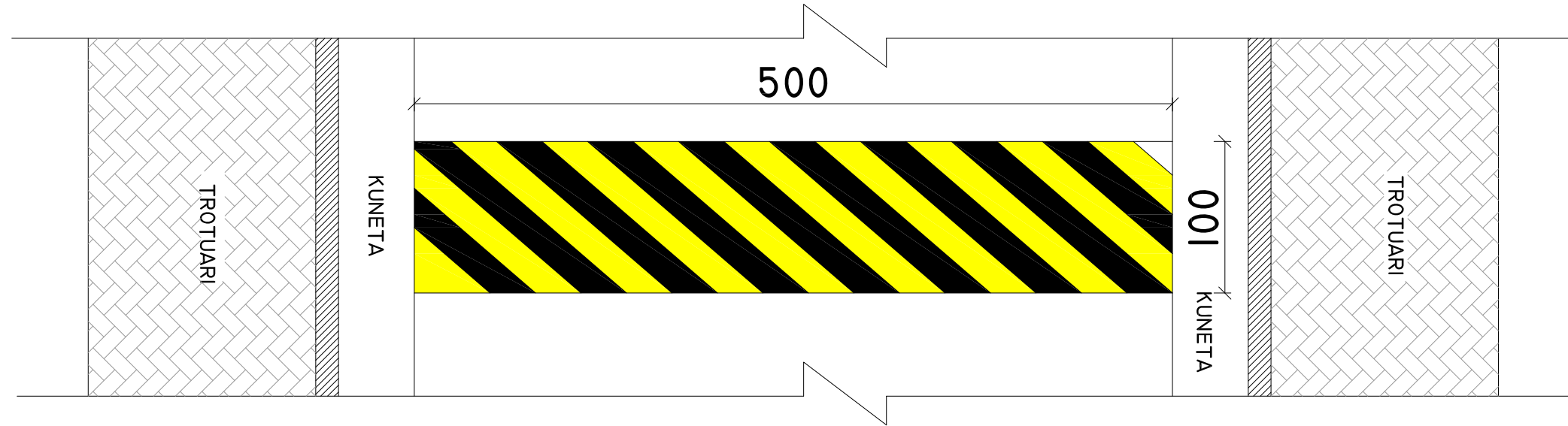

PRERJE TERTHORE

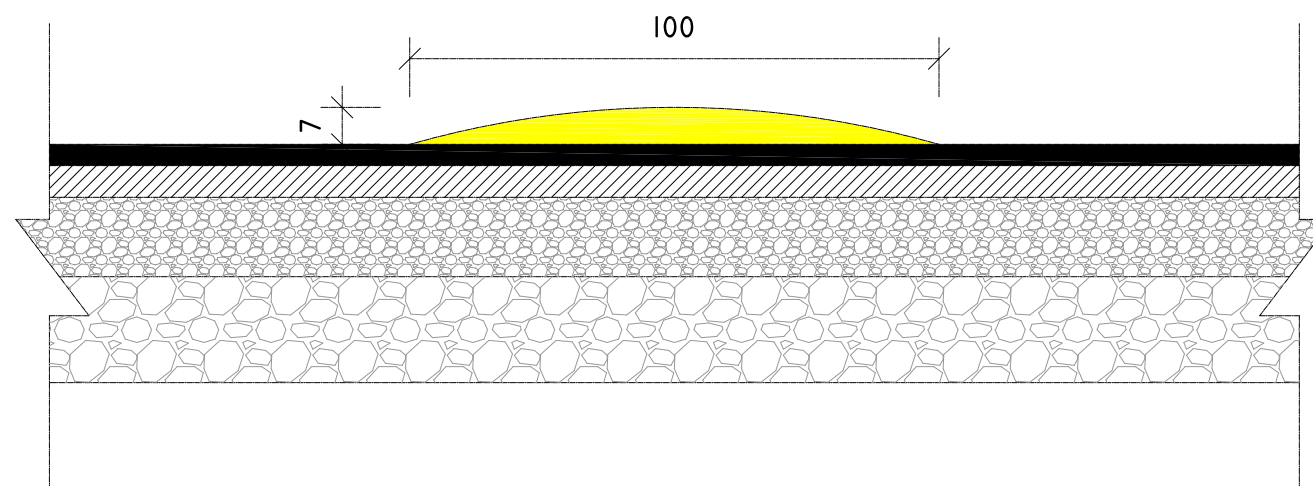

POROSITESI : BASHKIA VORË

OBJEKTI:
"NDERTIMI I KANALIT DOMJE DHE NDRICIMI RRUGES"

Emertimi: DETAJ SINJALISTIKE



"ARABEL - STUDIO" Sh.p.k
Adresa: Njesia Bashkiake nr.7, Rruga "Frosina Plaku"
Pallati 21, Hyrja 1, Kati 2, Tirane.
Email: arabelstudio@gmail.com

Drejtues i projektit

Adm. Ana NISHKU

Inxh. Ardi ARKAXHIU

Projektues

Nd. Ardi ARKAXHIU

Ark.Rigert HYRA

Gjeo.Irfan BEGAJ

Elek. Altin ALLKAJ

Top. Mustafa HOXHAI

Hid. Hajredin MURGU

SHKALLA

-

Vorë 2018

FLETA

6 - 11

Format A3