

*OBJEKTI: "Ndertimi i kendeve sportive per shkollat 9- vjecare dhe  
shkollen e mesme" Sali Nivica"  
Faza II*



Per Sektorin e Zhvillimit Urban dhe Kadastres

Ing. Violeta Kanushi  
Topo. Petrit H. Hoxha

Miratohet  
Kryetari  
**DURIM RROSHI**



BASHKIA MEMALIAJ

Per C.E.C Group  
Ing. Vangjush Mbrice

C.E.C Group   
Civil Engineering Consultants

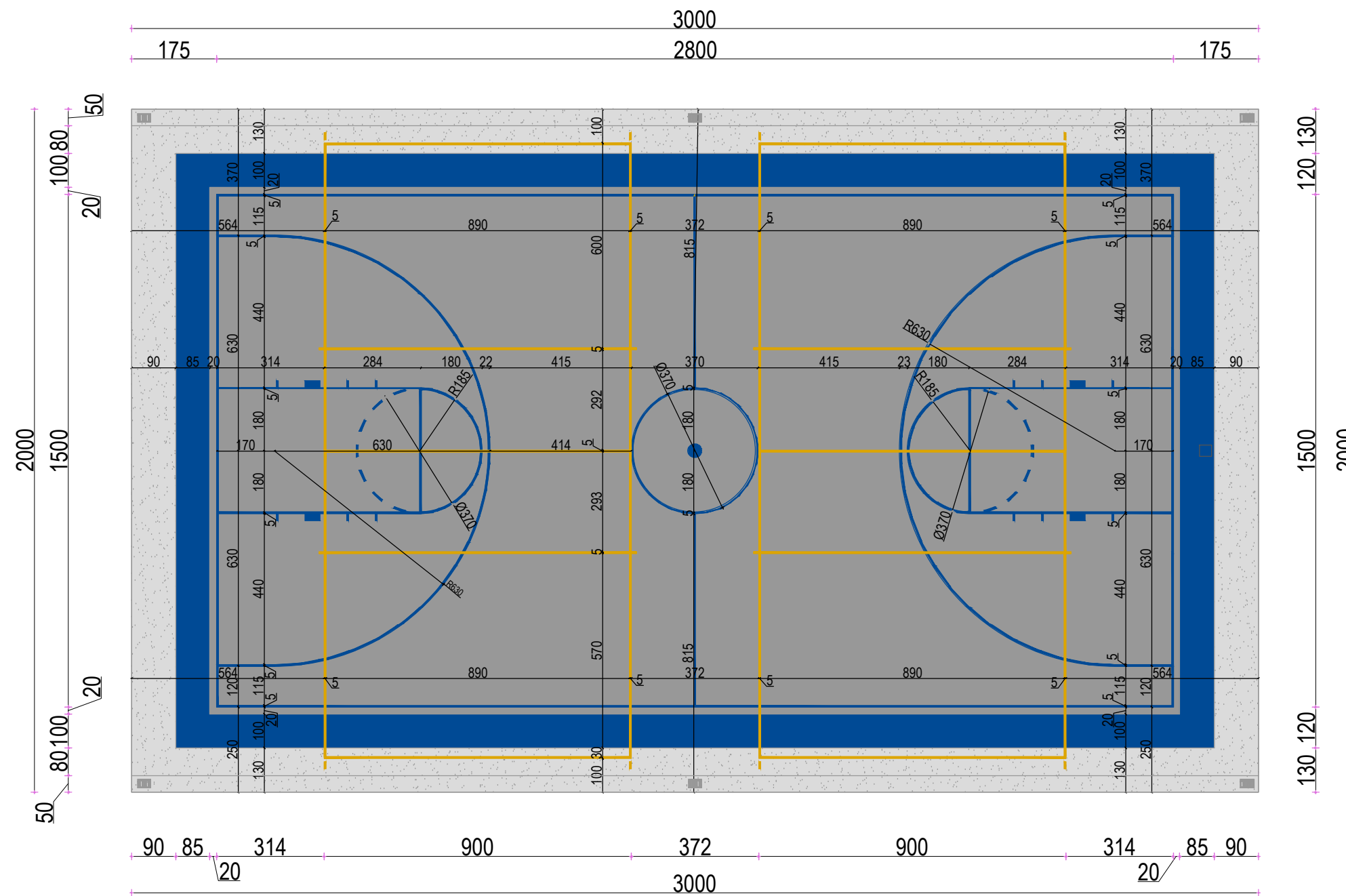

Shenime

Investitor  
Bashkia Memaliaj



Emertimi i projektit

NDERTIMI I KENDEVE SPORTIVE PER SHKOLLAT  
9-VJECARE - "NIMETE PROGONATI" DHE E MESME  
"SALI NIVICA"  
FAZA II

Faza e Projektit

PROJEKT ZBATIM

Projekti i  
infrastruktures

Konsulentit



Projektoi	Emer Mbiemer	Firma
Insh. Nderim	Vangjosh MBRUÇE	
Insh. Nderim	Andren MBRUÇE	

Dwg.Nr. A1-01

Emertimi fletes:  
Planimetria e fushes

Shkalla:  
A3 - 1:250

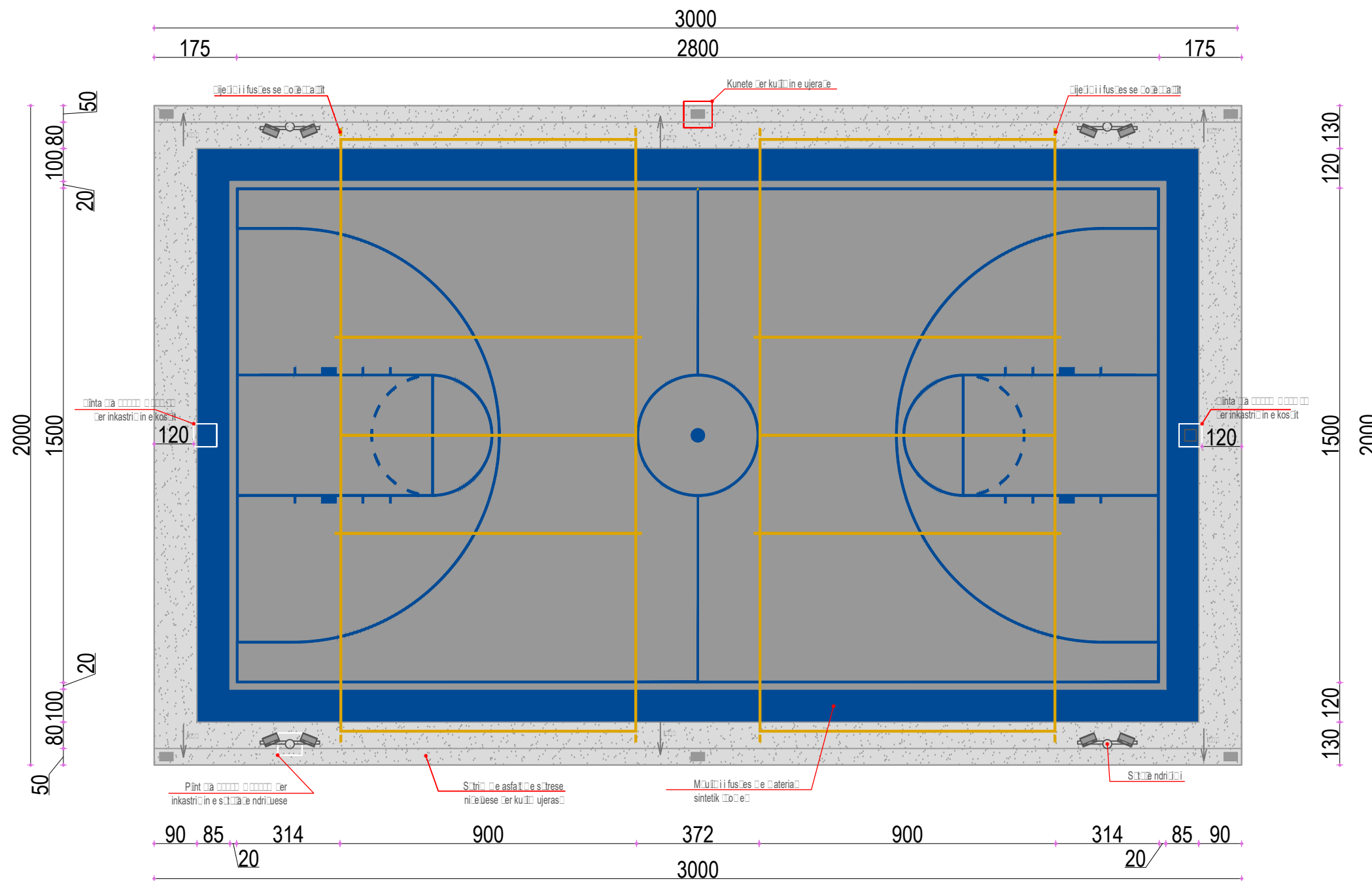

Shenime

Investitor  
Bashkia Memaliaj



Emertimi i projektit

NDERTIMI I KENDEVE SPORTIVE PER SHKOLLAT  
9-VJECARE - "NIMETE PROGONATI" DHE E MESME  
"SAJ NIVICA"  
FAZA II

Faza e Projektit

PROJEKT ZBATIM

Projekti i  
infrastruktures

Konsulent



Projektoi	Emër Mbiemër	Firma
Insh. Nderim	Vangjush MBRUÇE	
Insh. Nderim	Andren MBRUÇE	

Dwg.Nr. A1.02

Emertimi fletës:  
Planimetria e fushës

Shkalla:

A3 - 1:250

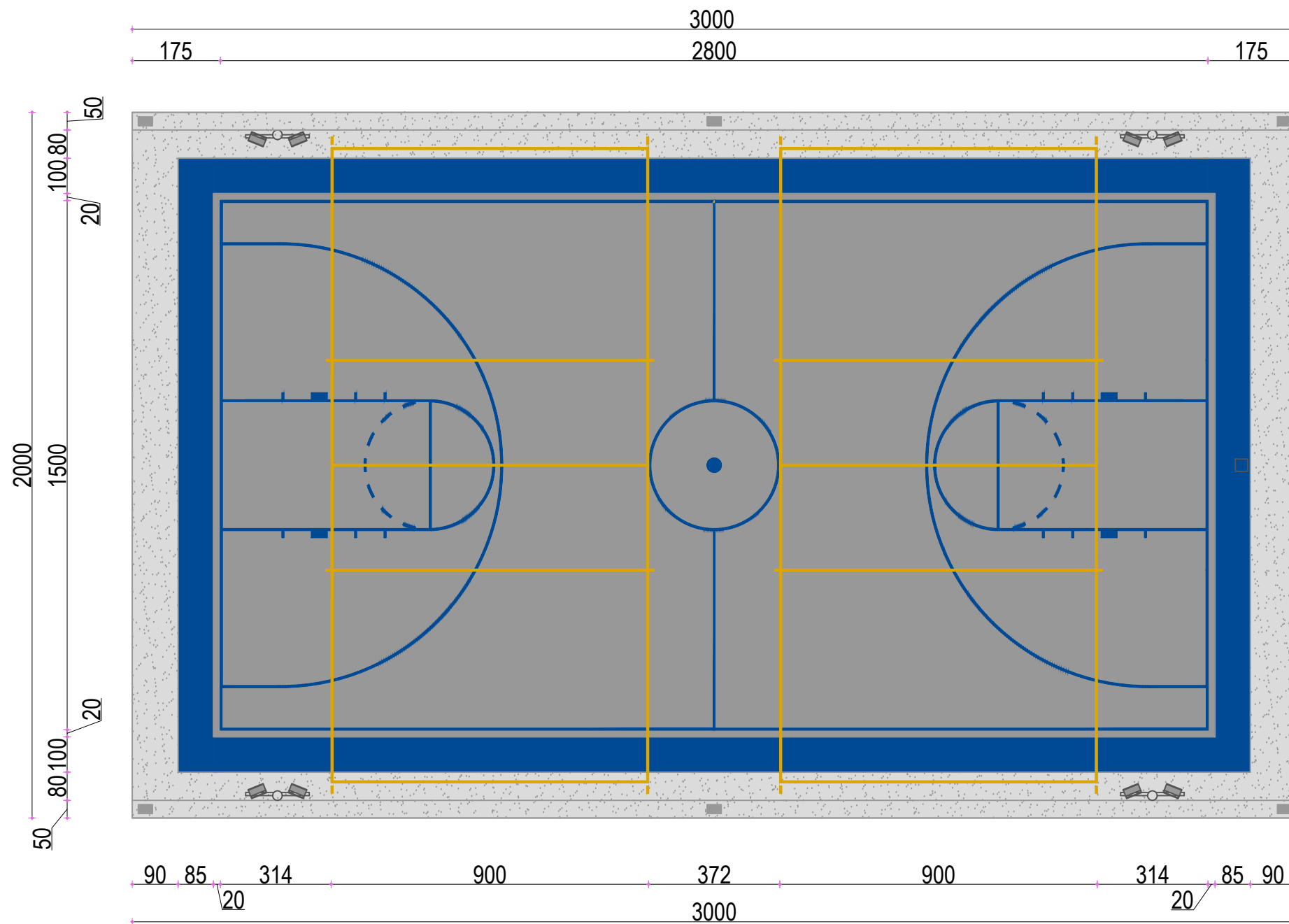

Perqjedja e ngraje te shtriit sintetike dhe djeqese te fusqes

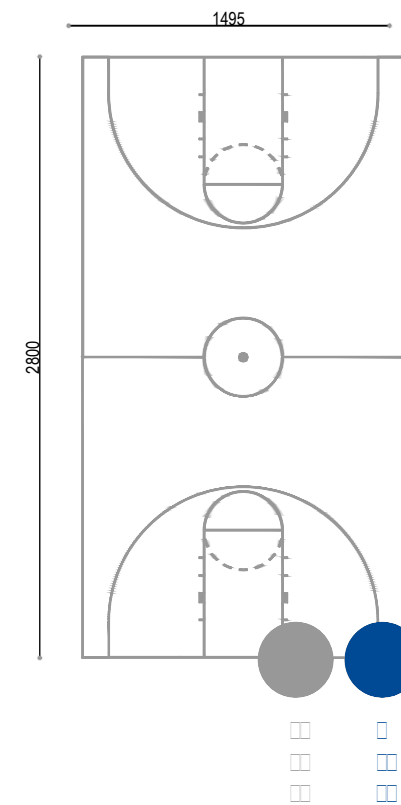

Perqjedja e ngraje te shtriit sintetike

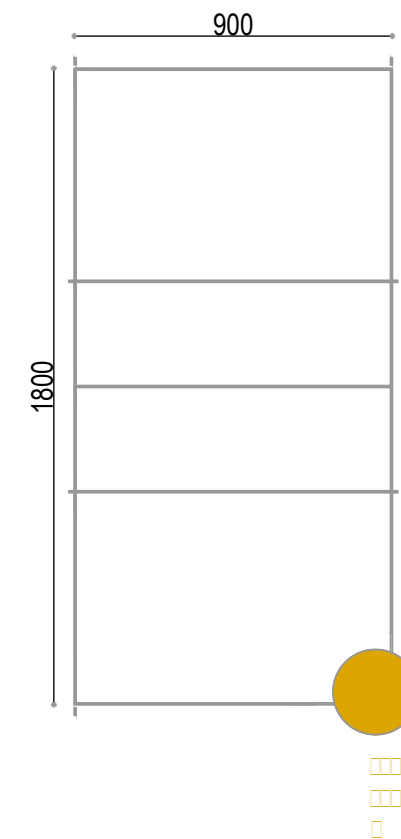

### Shtrese e fusqes

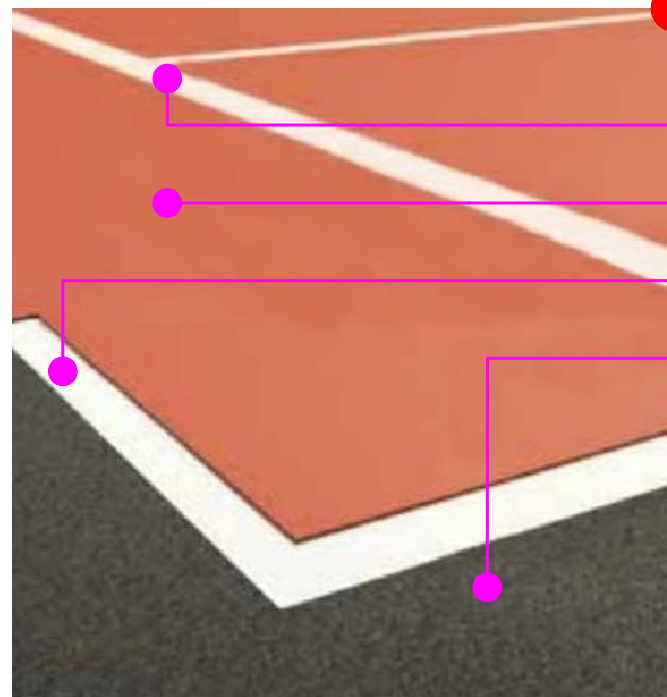

- Resine sintetike e rrethet
- Resine sintetike
- Shtrese e fusqes dhe aortuese
- Asfalteton

### Shenim:

Shtrese sintetike sportive, e perbere nga perzierje rezine akrilike sintetike e lidhur me inerte me rezistence te larte, mikrokokrizat e gomes i japin elasticitet shtreses.

- a) verifikimi i nivelimit te shtreses se betonit dhe pastrimi rigoroz paraparak
- b) aplikimi me spatul metalike ose gome te jne baze mbushesi
- c) pas tharjes aplikohet shtresa e resines me ngjyre.
- d) realizim i vijave kufizuese aplikohet me boje qe permban rreshire akrilike e holluar me uje.

### Shenime

Investitor  
Bashkia Memaliaj



Emertimi i projektit

NDERTIMI I KENDEVE SPORTIVE PER SHKOLLAT  
9-VJEKARE - "NIMETE PROGONATI" DHE E MESME  
"SALI NIVICA"  
FAZA II

Faza e Projektit

PROJEKT ZBATIM

### Projekti i infrastruktures

Konsulentit



Projektoi	Emer Mbiemer	Firma
Insh. Nderim	Vangjush MBRICJE	
Insh. Nderim	Andren MBRICJE	

Dwg.Nr. A1.03

Emertimi fletes:  
Detaje shtrimi

Shkalla:

A3 - 1:250

# Plani i themeleve

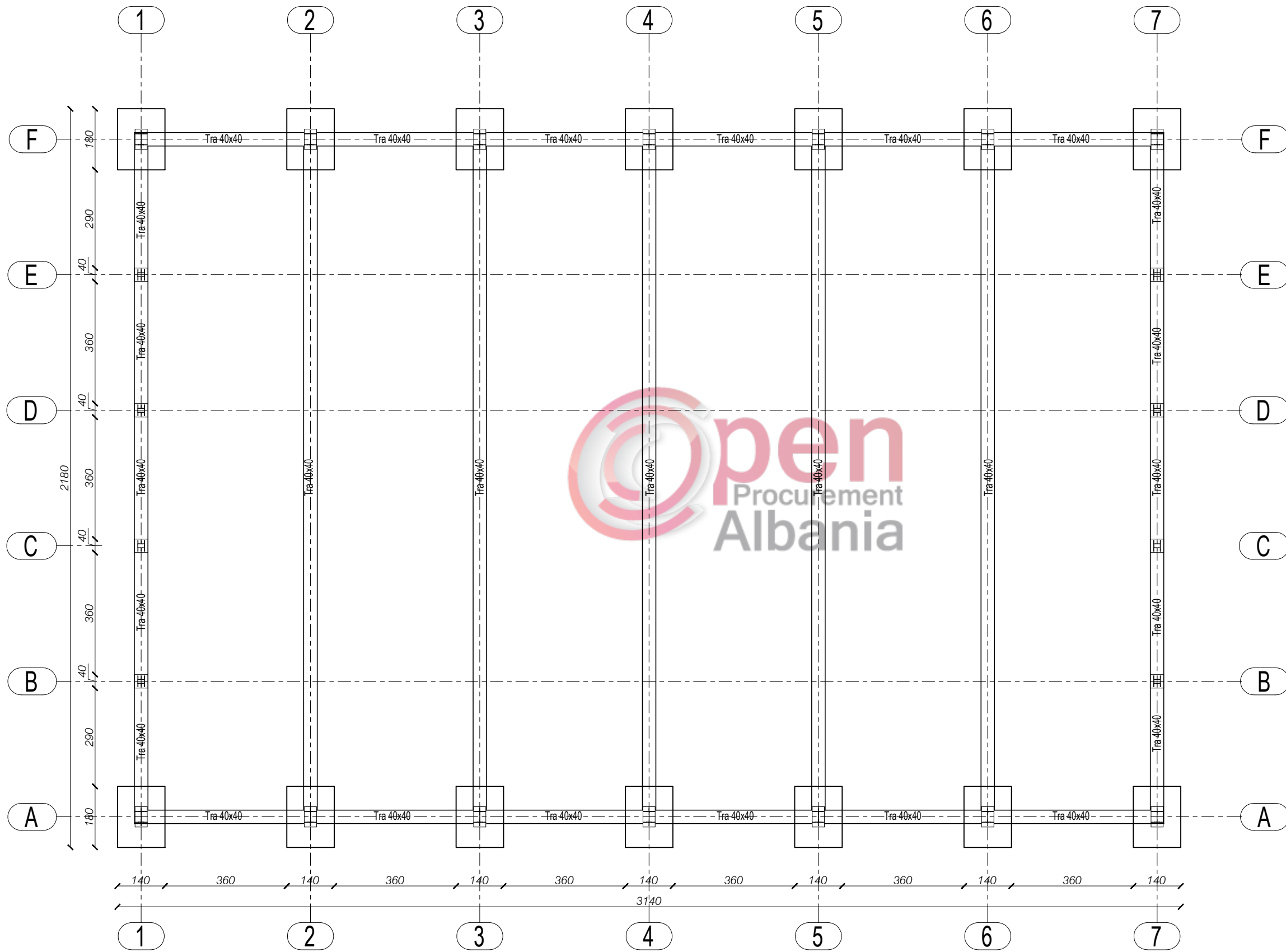

## Shenime

Investitor  
Bashkia Memaliaj



Emertimi i projektit

NDERTIMI I KENDEVE SPORTIVE PER SHKOLLAT:  
9-VJECARE - "NIMETE PRAGONATI" DHE  
E MESME - "SALI NIVICA"  
FAZA II

Faza e Projektit

PROJEKT ZBATIM

Projekti i  
infrastruktures

Konsulent



Projektoi	Emer Mbiemer	Firma
Insh. Nderim	Vangjush MBRICJE	
Insh. Nderim	Andren MBRICJE	

Dwg.Nr. B1.00

Emertimi fletes:  
Plani i themeleve

# Pamje 3D

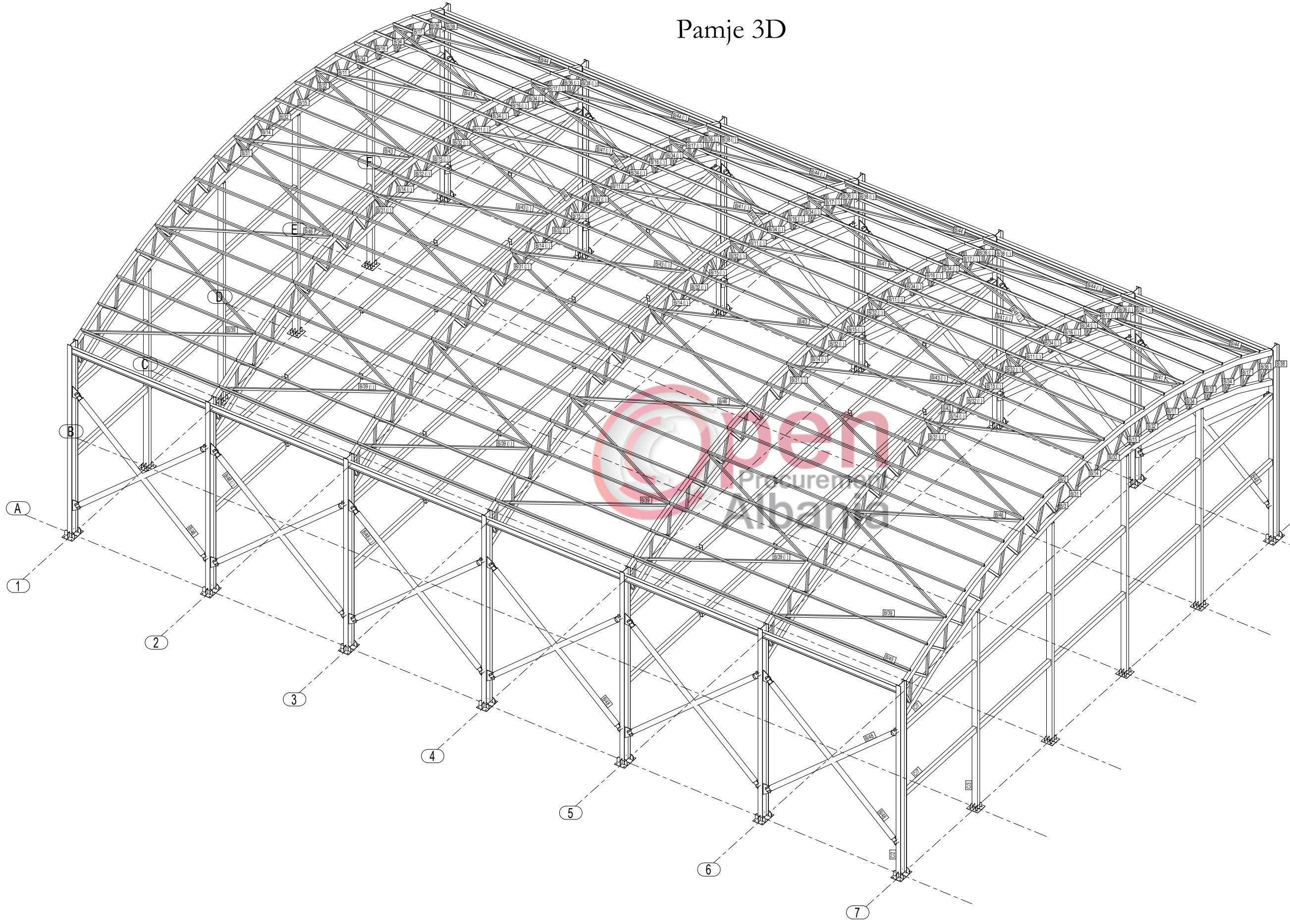

## Shenime

Investitor  
Bashkia Memaliaj



Emertimi i projektit

NDERTIMI I KENDEVE SPORTIVE PER SHKOLLAT:  
9-VJECARE - "NIMETE PROGONATI" DHE  
E MESME - "SALI NIVICA"  
FAZA II

Faza e Projektit

PROJEKT ZBATIM

Projekti i  
infrastruktures

Konsulentit

**C.E.C Group**  
Civil Engineering Consultants

Projektoi	Emer Mbiemer	Firma
Insh. Nderim	Vangjush MBRICJE	
Insh. Nderim	Andren MBRICJE	

Dwg.Nr. B1.01

Emertimi fletes:  
Pamje 3D

hkalla:

A3 - 1:250

# Plani i kolonave

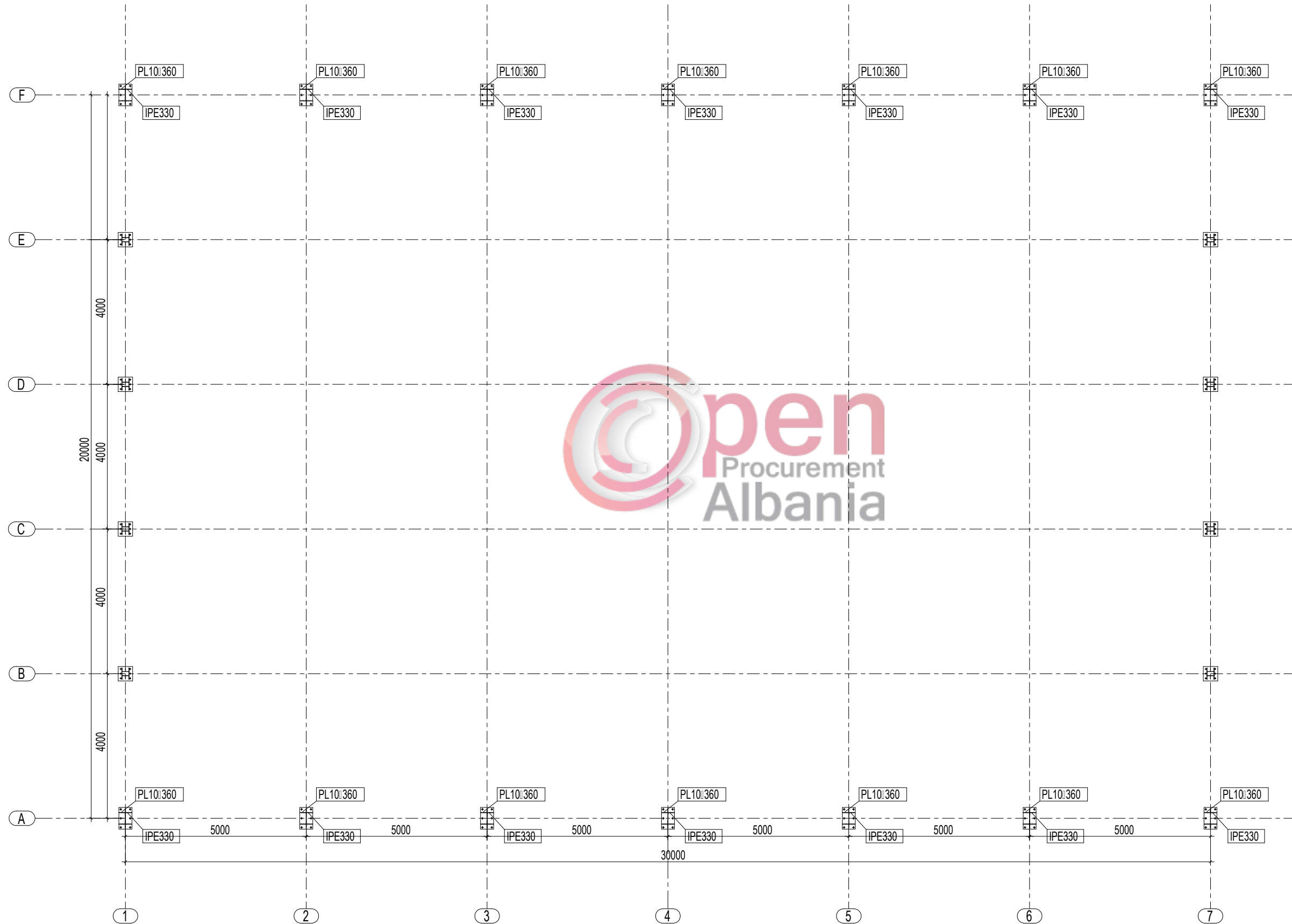

## Shenime

Investitor  
Bashkia Memaliaj



Emertimi i projektit

NDERTIMI I KENDEVE SPORTIVE PER SHKOLLAT:  
9-VJECARE - "NIMETE PRAGONATI" DHE  
E MESME - "SALI NIVICA"  
FAZA II

Faza e Projektit

PROJEKT ZBATIM

Projekti i  
infrastruktures

Konsulent

C.E.C Group  
Civil Engineering Consultants

Projektoi	Emer Mbiemer	Firma
Insh. Nderim	Vangjush MBRICJE	
Insh. Nderim	Andren MBRICJE	

Dwg.Nr. B1.02

Emertimi fletes:  
Plani i kolonave

Shkalla:

A3 - 1:250

# Plani ne kuoten □ 7.20

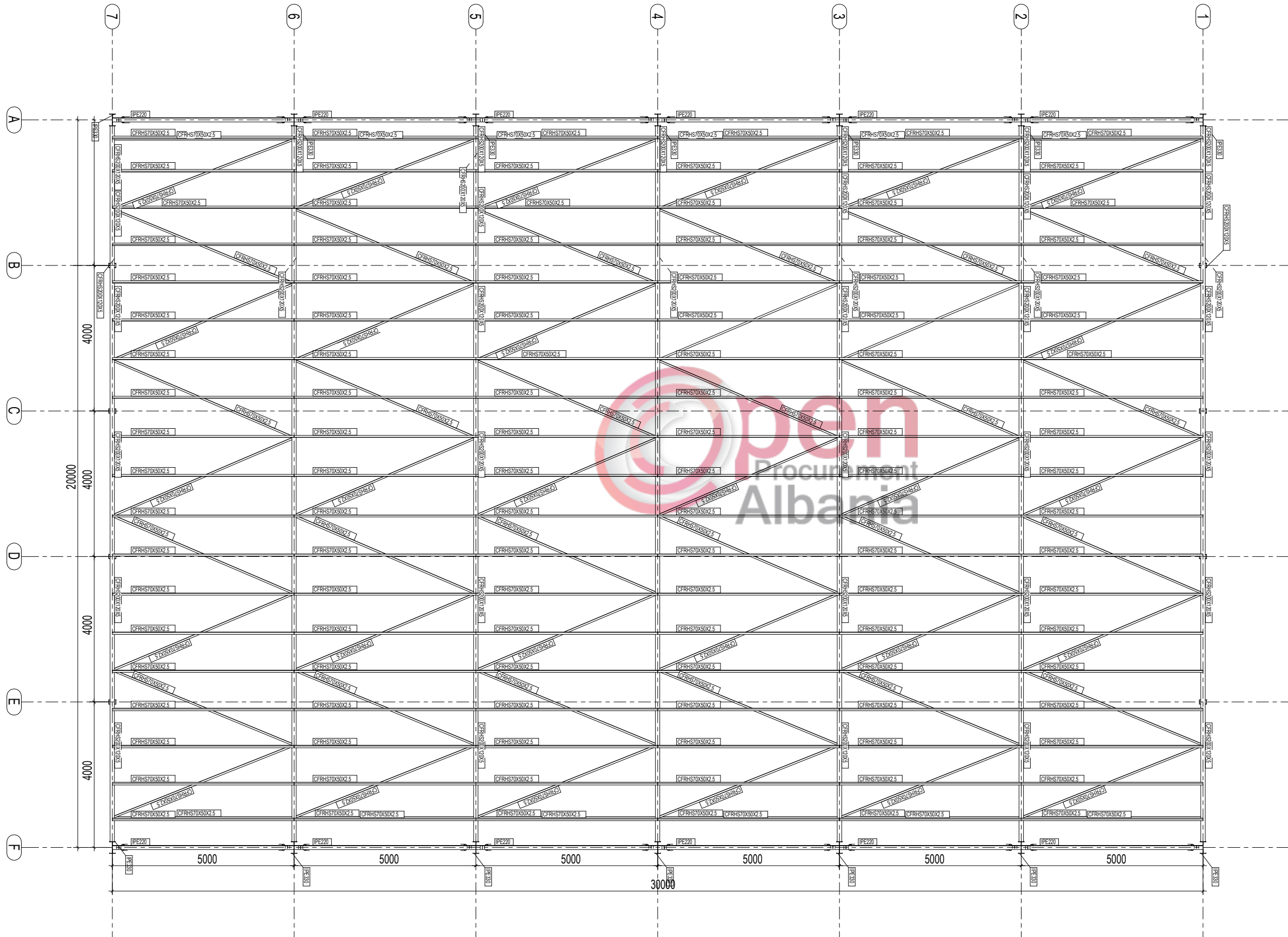

## Shenime

Investitor  
Bashkia Memaliaj



Emertimi i projektit

NDERTIMI I KENDEVE SPORTIVE PER SHKOLLAT:  
9-VJECARE - "NIMETE PRAGONATI" DHE  
E MESME - "SALI NIVICA"  
FAZA II

Faza e Projektit

PROJEKT ZBATIM

Projekti i  
infrastruktures

Konsulentit

C.E.C Group  
Civil Engineering Consultants

Projektoi	Emer Mbiemer	Firma
Insh. Nderim	Vangjush MBRICE	
Insh. Nderim	Andren MBRICE	

Dwg.Nr. B1.03

Emertimi fletes:  
Plani ne kuoten □ 7.20

Shkalla:

A3 - 1:250



# Prerja A-A

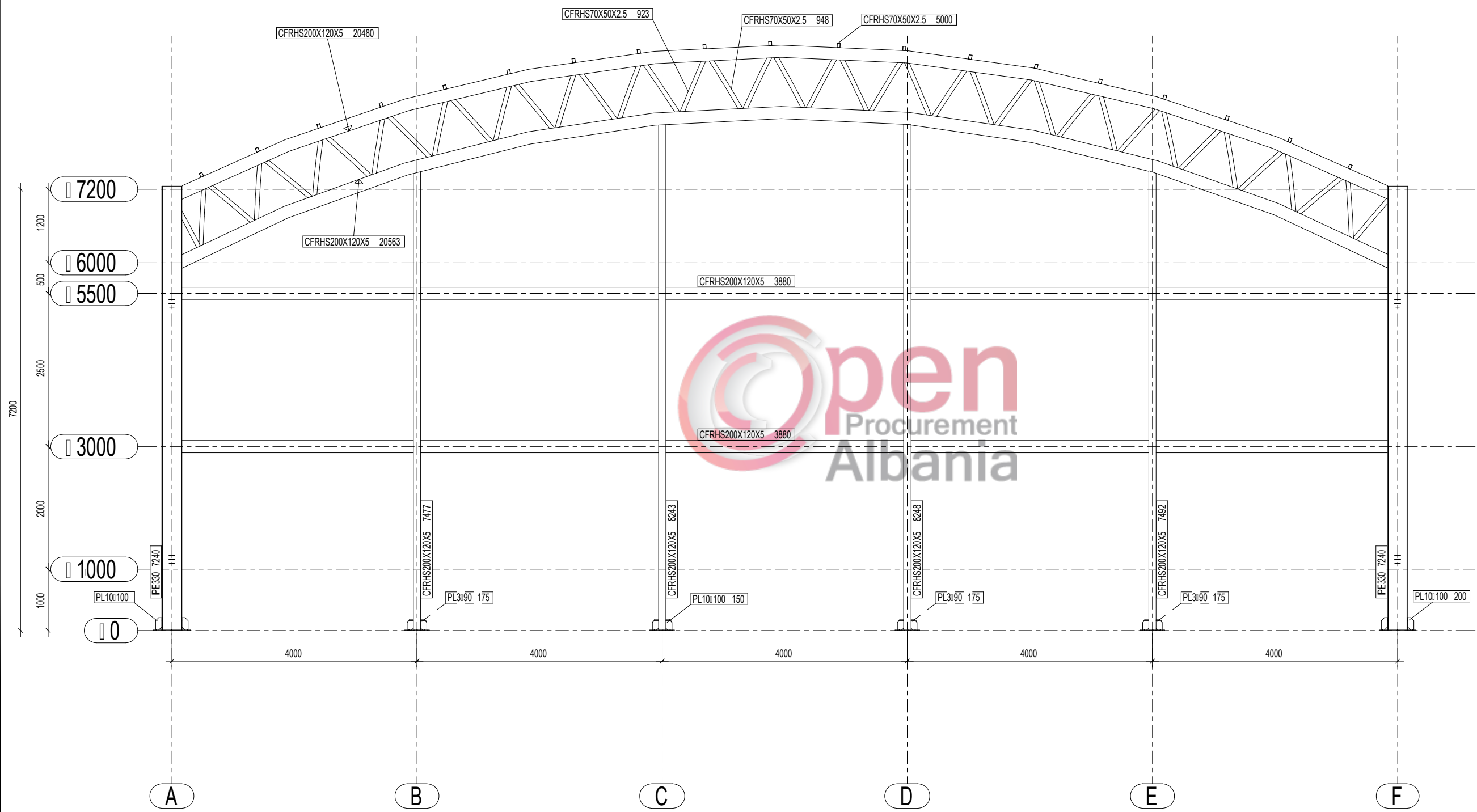

Investitor  
Bashkia Memaliaj



Emertimi i projektit  
NDERTIMI I KENDEVE SPORTIVE PER SHKOLLAT:  
9-VJECARE - "NIMETE PROGONATI" DHE  
E MESME - "SALI NIVICA"  
FAZA II

Faza e Projektit  
PROJEKT ZBATIM

Projekti i  
infrastruktures

Konsulentit  
C.E.C Group  
Civil Engineering Consultants

Projektoi	Emer Mbiemer	Firma
Insh. Ndertim	Vangjush MBRICJE	
Insh. Ndertim	Andan MBRICJE	

Dwg.Nr. C1-01

Emertimi fletes:  
Prerja A-A

Shkalla:  
A3 - 1:200

# Prerja B-B

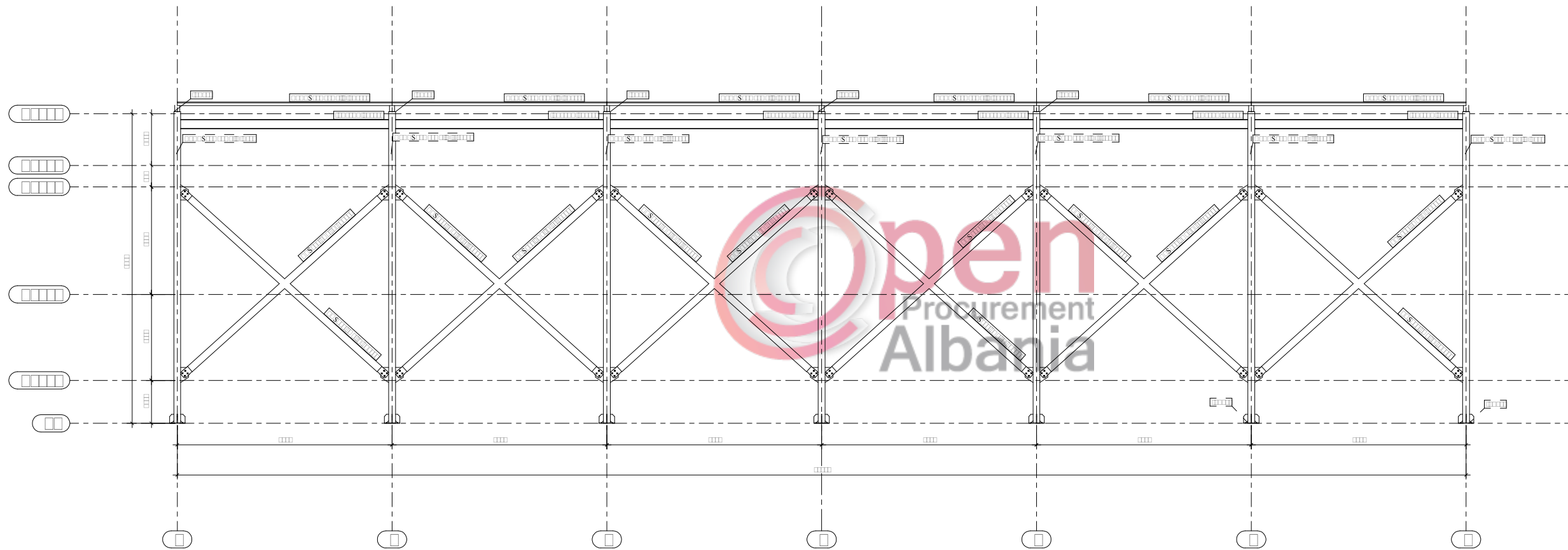

Shenime

Investitor  
Bashkia Memaliaj



Emertimi i projektit

NDERTIMI I KENDEVE SPORTIVE PER SHKOLLAT:  
9-VJECARE - "NIMETE PRAGONATI" DHE  
E MESME - "SALI NIVICA"  
FAZA II

Faza e Projektit

PROJEKT ZBATIM

Projekti i  
infrastruktures

Konsulentit

C.E.C Group  
Civil Engineering Consultants

Projektoi	Emer Mbiemer	Firma
Insh. Nderim	Vangjush MBRICJE	
Insh. Nderim	Andreas MBRICJE	

Dwg.Nr. C1-02

Emertimi fletes:  
Prerja B-B

Shkalla:

A3 - 1:200

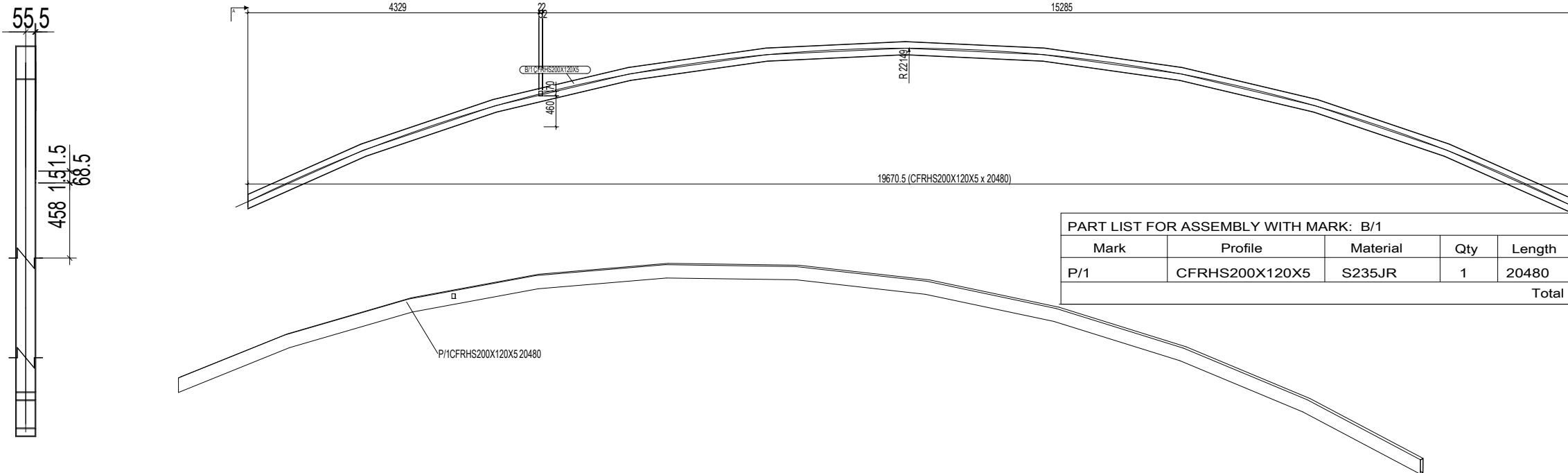

PART LIST FOR ASSEMBLY WITH MARK: B/1						Qty	6
Mark	Profile	Material	Qty	Length	Sip (m <sup>2</sup> )	Weight(kg)	
P/1	CFRHS200X120X5	S235JR	1	20480	12.8	488.1	
Total					12.8	488.1	

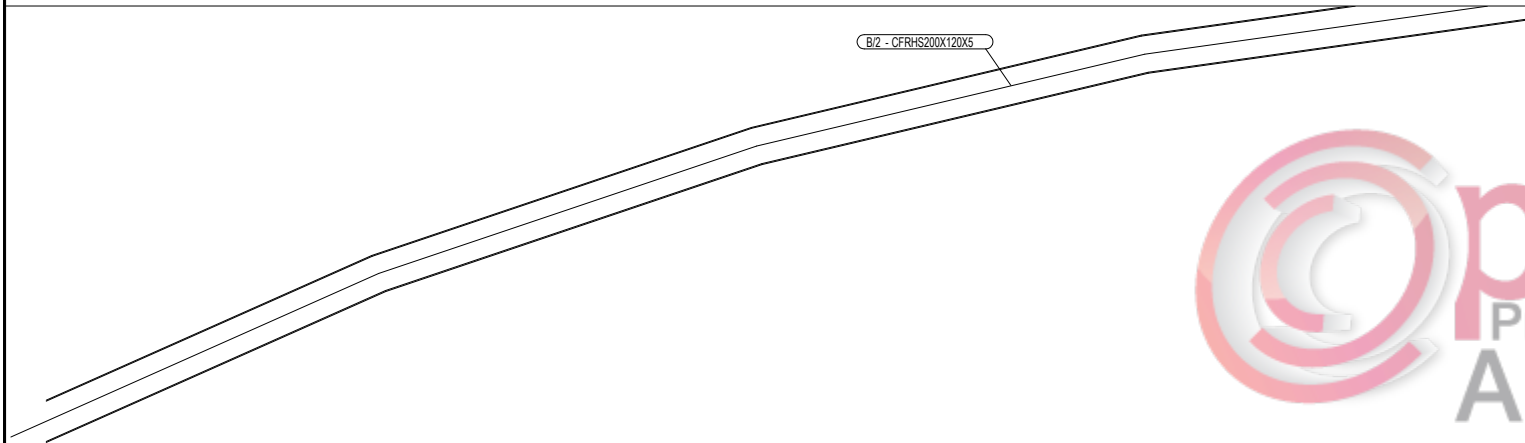

LISTA E MATERIALEVE: B/2						Sasia	1
Nr.	Profili	Materiale	Sasia	Gjatesia	Sip (m <sup>2</sup> )	Pesha(kg)	
P/2	CFRHS200X120X5	S235JR	1	20480	12.8	488.1	
Totale					12.8	488.1	

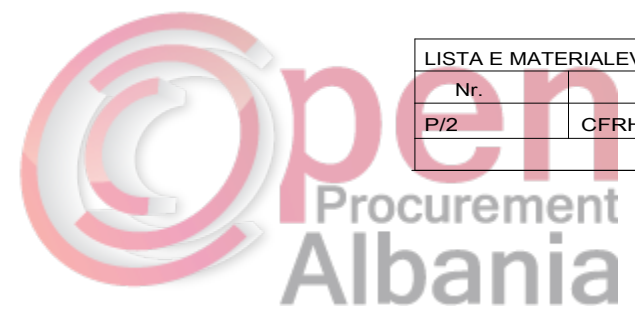

LISTA E MATERIALEVE: B/3						Sasia	7
Nr.	Profili	Materiale	Sasia	Gjatesia	Sip (m <sup>2</sup> )	Pesha(kg)	
P/3	CFRHS200X120X5	S235JR	1	20563	12.8	490.1	
Totale					12.8	490.1	

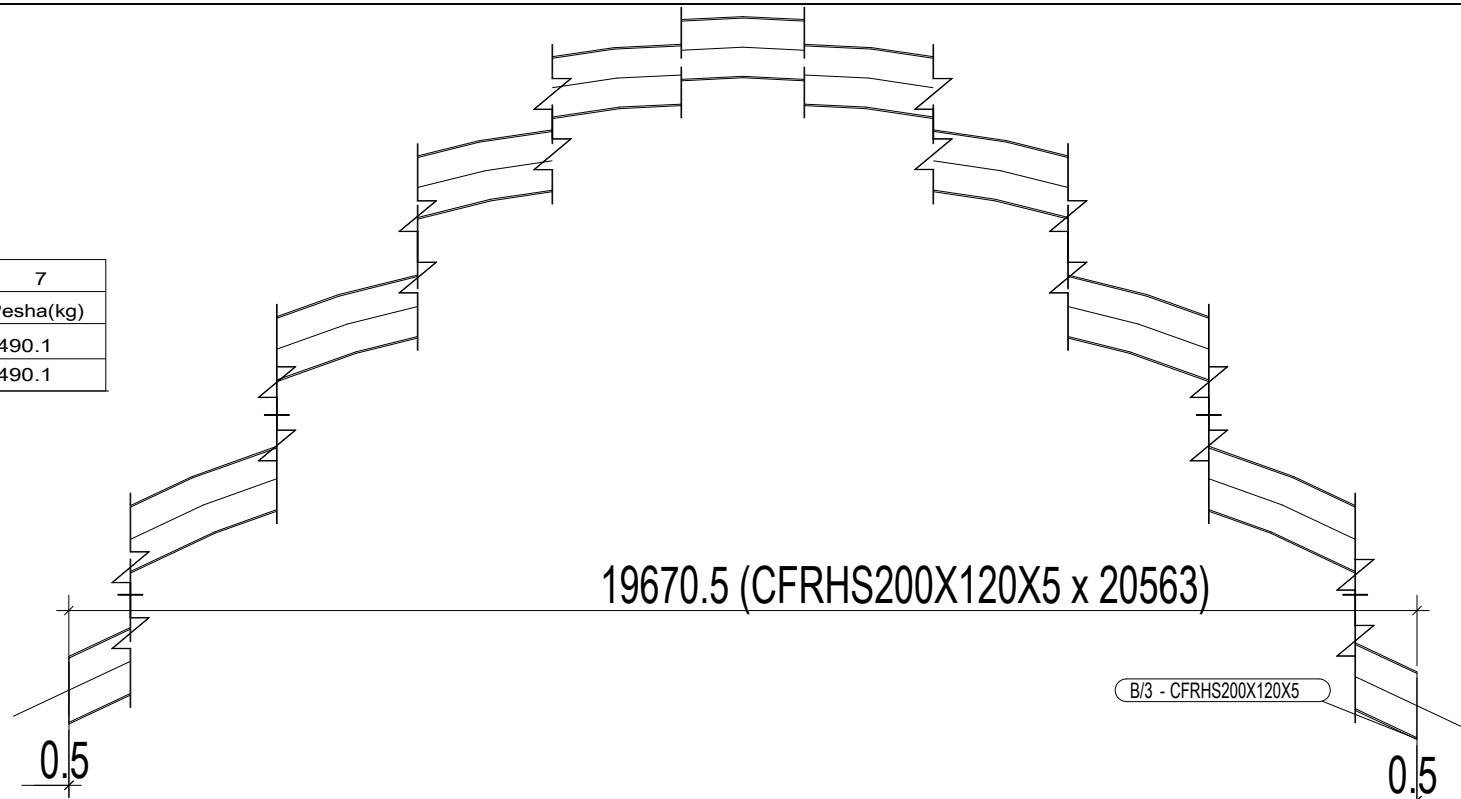

Shenime

Investitor  
Bashkia Memaliaj



Emertimi i projektit  
NDERTIMI I KENDEVE SPORTIVE PER SHKOLLAT:  
9-VJECARE - "NIMETE PRAGONATI" DHE  
E MESME - "SALI NIVICA"  
FAZA II

Faza e Projektit  
PROJEKT ZBATIM

Projekti i infrastruktures

Konsulentit  
C.E.C Group  
Civil Engineering Consultants

Projektoi	Emer Mbiemer	Firma
Inch. Nderim	Vangjsh MBRICË	
Inch. Nderim	Andan MBRICË	

Dwg.Nr. E1-01

Emertimi fletes:  
Detaje metalike

LISTA E MATERIALEVE: B/4						Sasia	7
Nr.	Profili	Materiale	Sasia	Gjatesia	Sip (m <sup>2</sup> )	Pesha(kg)	
P/5	CFRHS70X50X2.5	S235JR	1	645	0.1	2.8	
Totale					0.1	2.8	

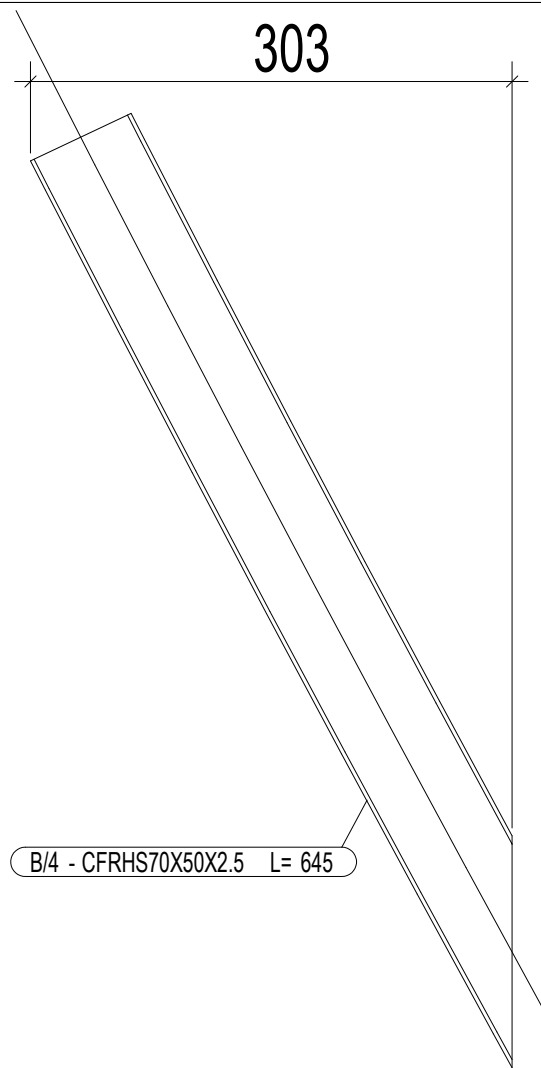

B/4 - CFRHS70X50X2.5 L= 645

B/5 - CFRHS70X50X2.5

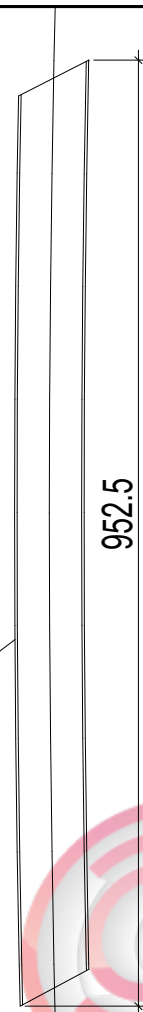

952.5

LISTA E MATERIALEVE: B/5						Sasia	7
Nr.	Profili	Materiale	Sasia	Gjatesia	Sip (m <sup>2</sup> )	Pesha(kg)	
P/6	CFRHS70X50X2.5	S235JR	1	952	0.2	4.2	
Totale					0.2	4.2	

LISTA E MATERIALEVE: B/6						Sasia	7
Nr.	Profili	Materiale	Sasia	Gjatesia	Sip (m <sup>2</sup> )	Pesha(kg)	
P/7	CFRHS70X50X2.5	S235JR	1	952	0.2	4.2	
Totale					0.2	4.2	

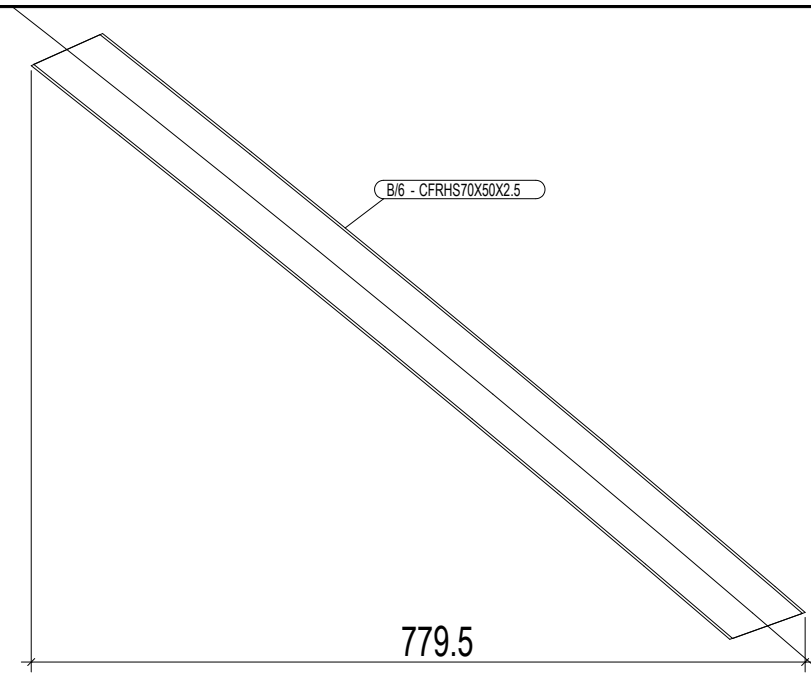

779.5

B/7 - CFRHS70X50X2.5

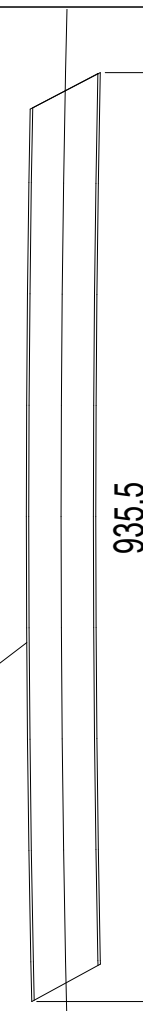

935.5

LISTA E MATERIALEVE: B/7						Sasia	7
Nr.	Profili	Materiale	Sasia	Gjatesia	Sip (m <sup>2</sup> )	Pesha(kg)	
P/8	CFRHS70X50X2.5	S235JR	1	935	0.2	4.1	
Totale					0.2	4.1	

### Shenime

Investitor  
Bashkia Memaliaj



Emertimi i projektit

NDERTIMI I KENDEVE SPORTIVE PER SHKOLLAT:  
9-VJECARE - "NIMETE PROGONATI" DHE  
E MESME - "SALI NIVICA"  
FAZA II

Faza e Projektit

PROJEKT ZBATIM

Projekti i  
infrastruktures

Konsulentit



Projektoi	Emer Mbiemer	Firma
Insh. Nderim	Vangjosh MBRICJE	
Insh. Nderim	Andren MBRICJE	

Dwg.Nr. E1-02

Emertimi fletes:  
Detaje metalike

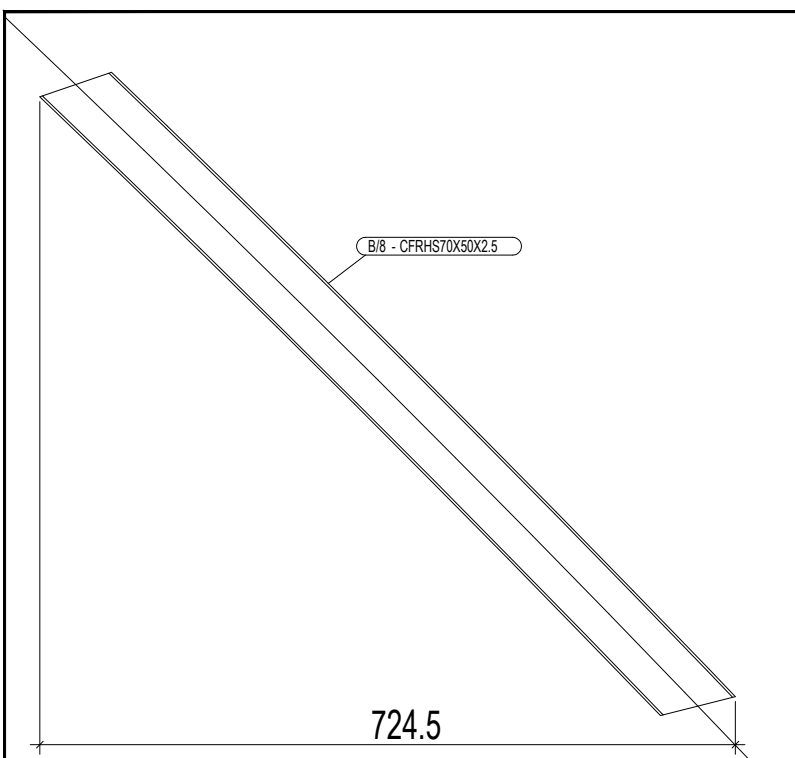

LISTA E MATERIALEVE: B/10						Sasia	7
Nr.	Profili	Materiale	Sasia	Gjatesia	Sip (m <sup>2</sup> )	Pesha(kg)	
P/11	CFRHS70X50X2.5	S235JR	1	965	0.2	4.2	
Totale					0.2	4.2	

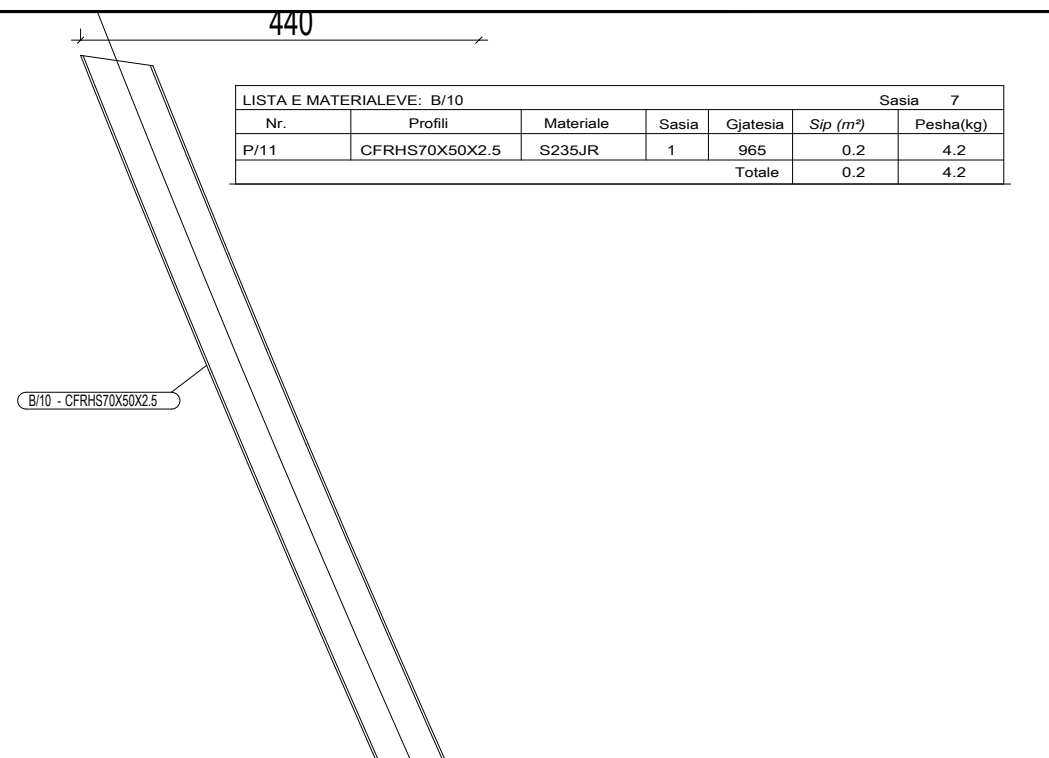

LISTA E MATERIALEVE: B/11						Sasia	7
Nr.	Profili	Materiale	Sasia	Gjatesia	Sip (m <sup>2</sup> )	Pesha(kg)	
P/12	CFRHS70X50X2.5	S235JR	1	954	0.2	4.2	
Totale					0.2	4.2	

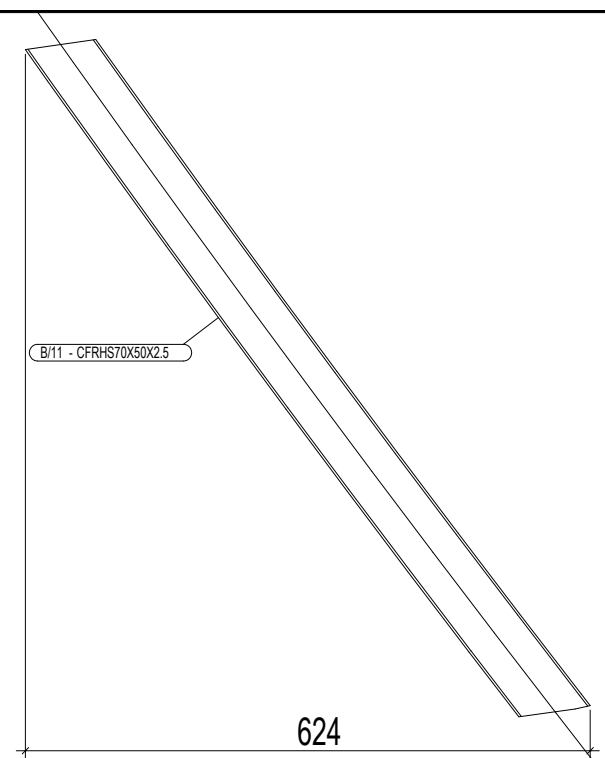

LISTA E MATERIALEVE: B/8						Sasia	7
Nr.	Profili	Materiale	Sasia	Gjatesia	Sip (m <sup>2</sup> )	Pesha(kg)	
P/9	CFRHS70X50X2.5	S235JR	1	954	0.2	4.2	
Totale					0.2	4.2	

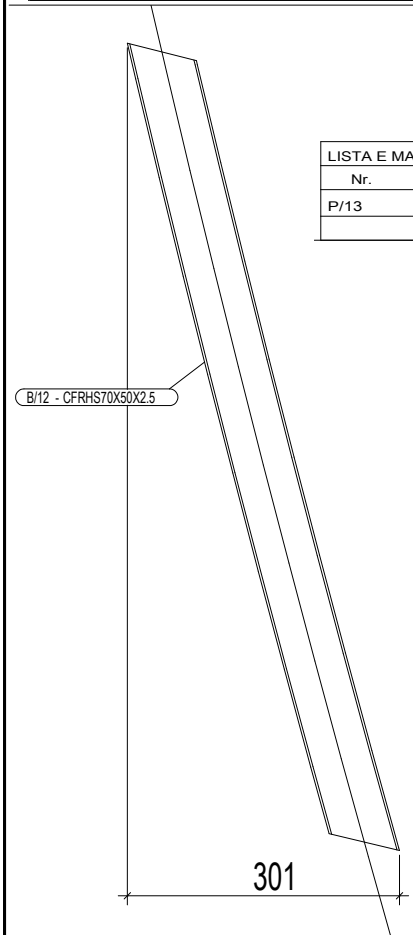

LISTA E MATERIALEVE: B/12						Sasia	7
Nr.	Profili	Materiale	Sasia	Gjatesia	Sip (m <sup>2</sup> )	Pesha(kg)	
P/13	CFRHS70X50X2.5	S235JR	1	939	0.2	4.1	
Totale					0.2	4.1	

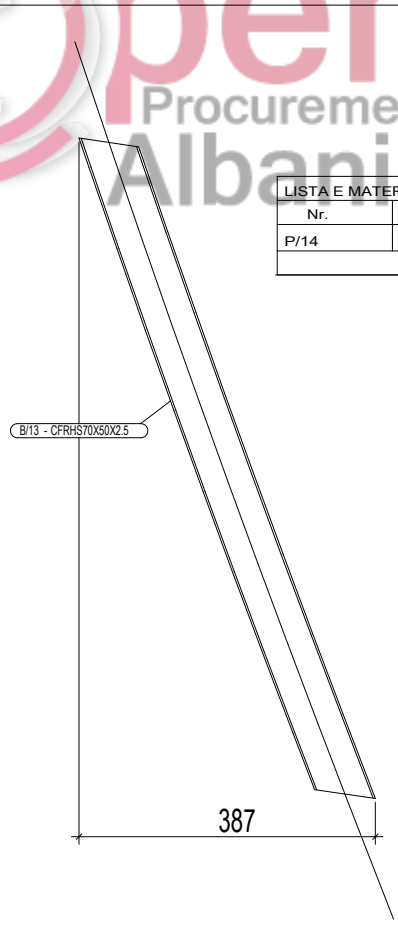

LISTA E MATERIALEVE: B/13						Sasia	7
Nr.	Profili	Materiale	Sasia	Gjatesia	Sip (m <sup>2</sup> )	Pesha(kg)	
P/14	CFRHS70X50X2.5	S235JR	1	943	0.2	4.1	
Totale					0.2	4.1	

**Shenime**

Investitor  
Bashkia Memaliaj



Emertimi i projektit

NDERTIMI I KENDEVE SPORTIVE PER SHKOLLAT:  
9-VJECARE - "NIMETE PROGONATI" DHE  
E MESME - "SALI NIVICA"  
FAZA II

Faza e Projektit

PROJEKT ZBATIM

**Projekti i infrastruktures**

Konsulentit



Projektoi	Emer Mbiemer	Firma
Insh. Nderim	Vangjosh MBRRIÇI	
Insh. Nderim	Andrian MBRRIÇI	

Dwg.Nr. E1-03

Emertimi fletes:  
Detaje metalike



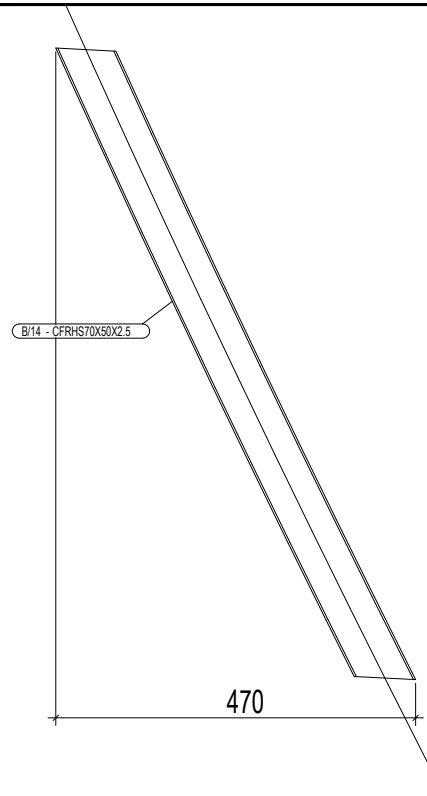

LISTA E MATERIALEVE: B/14						
Nr.	Profili	Materiale	Sasia	Gjatesia	Sip (m <sup>2</sup> )	Pesha(kg)
P/15	CFRHS70X50X2.5	S235JR	1	947	0.2	4.2
Totale					0.2	4.2

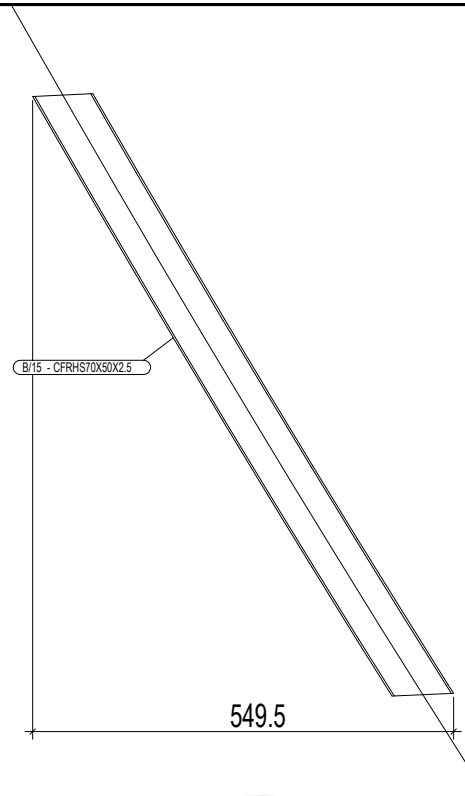

LISTA E MATERIALEVE: B/15						
Nr.	Profili	Materiale	Sasia	Gjatesia	Sip (m <sup>2</sup> )	Pesha(kg)
P/16	CFRHS70X50X2.5	S235JR	1	951	0.2	4.2
Totale					0.2	4.2

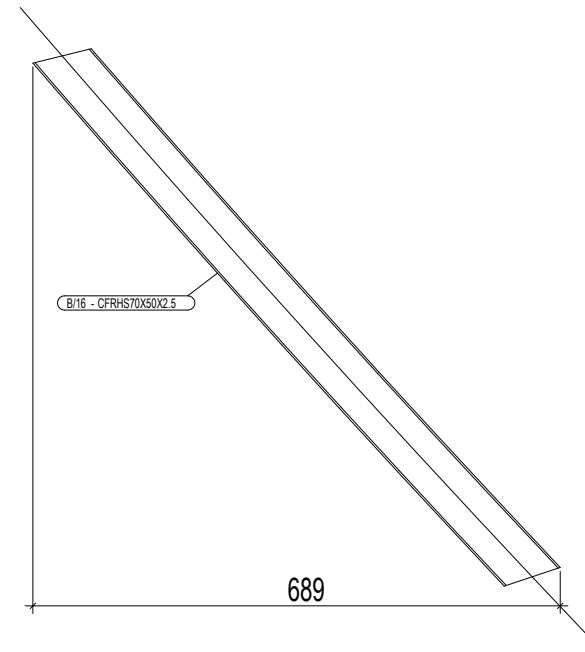

LISTA E MATERIALEVE: B/16						
Nr.	Profili	Materiale	Sasia	Gjatesia	Sip (m <sup>2</sup> )	Pesha(kg)
P/17	CFRHS70X50X2.5	S235JR	1	950	0.2	4.2
Totale					0.2	4.2

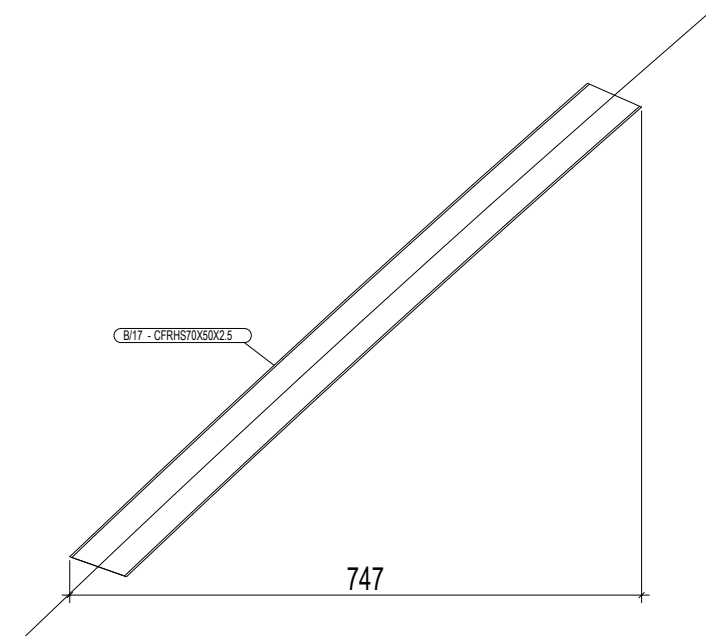

LISTA E MATERIALEVE: B/17						
Nr.	Profili	Materiale	Sasia	Gjatesia	Sip (m <sup>2</sup> )	Pesha(kg)
P/18	CFRHS70X50X2.5	S235JR	1	947	0.2	4.2
Totale					0.2	4.2

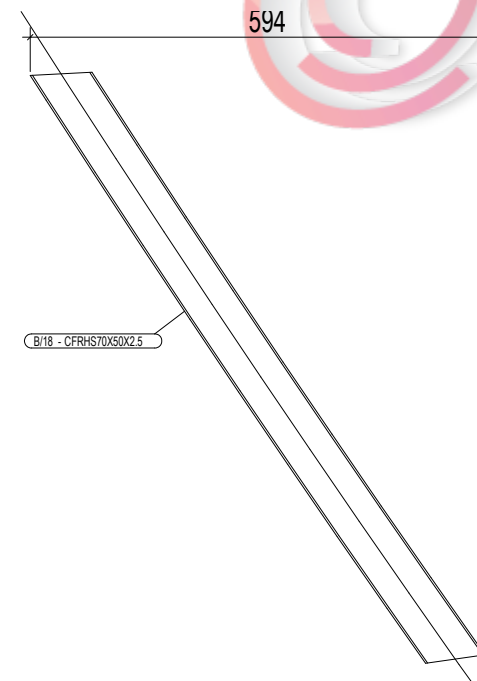

LISTA E MATERIALEVE: B/18						
Nr.	Profili	Materiale	Sasia	Gjatesia	Sip (m <sup>2</sup> )	Pesha(kg)
P/19	CFRHS70X50X2.5	S235JR	1	959	0.2	4.2
Totale					0.2	4.2

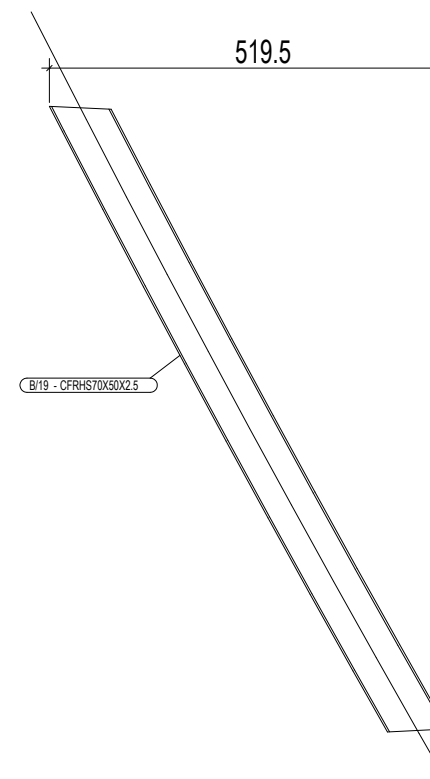

LISTA E MATERIALEVE: B/19						
Nr.	Profili	Materiale	Sasia	Gjatesia	Sip (m <sup>2</sup> )	Pesha(kg)
P/20	CFRHS70X50X2.5	S235JR	1	962	0.2	4.2
Totale					0.2	4.2

## Shenime

Investitor  
Bashkia Memaliaj



Emertimi i projektit

NDERTIMI I KENDEVE SPORTIVE PER SHKOLLAT:  
9-VJECARE - "NIMETE PROGONATI" DHE  
E MESME - "SALI NIVICA"  
FAZA II

Faza e Projektit

PROJEKT ZBATIM

Projekti i  
infrastruktures

Konsulentit

C.E.C Group  
Civil Engineering Consultants

Projektoi	Emer Mbiemer	Firma
Insh. Nderim	Vangjosh MBRICË	
Insh. Nderim	Andrius MBRICË	

Dwg.Nr. E1-04

Emertimi fletes:  
Detaje metalike

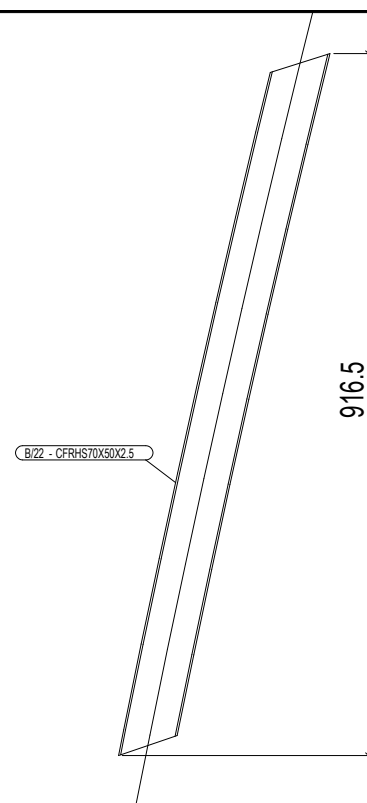
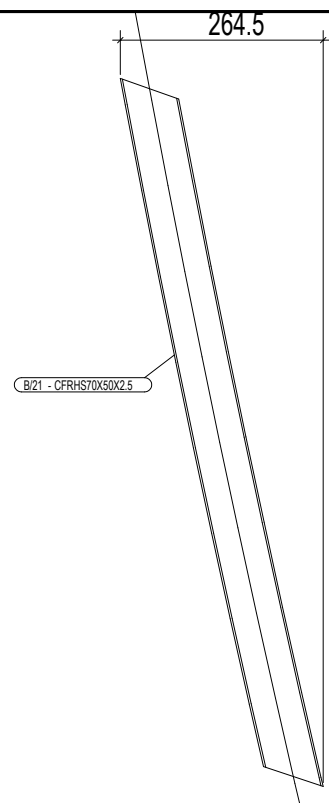
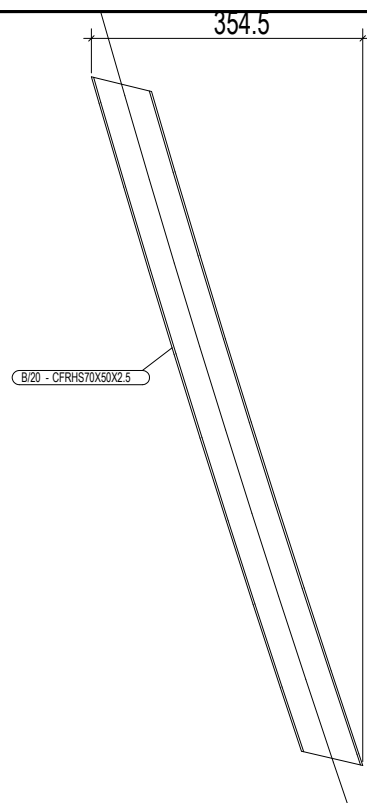

LISTA E MATERIALEVE: B/20						Sasia	7
Nr.	Profil	Materiale	Sasia	Gjatesia	Sip (m <sup>2</sup> )	Pesha(kg)	
P/21	CFRHS70X50X2.5	S235JR	1	964	0.2	4.2	
Totale					0.2	4.2	

LISTA E MATERIALEVE: B/21						Sasia	7
Nr.	Profil	Materiale	Sasia	Gjatesia	Sip (m <sup>2</sup> )	Pesha(kg)	
P/22	CFRHS70X50X2.5	S235JR	1	959	0.2	4.2	
Totale					0.2	4.2	

LISTA E MATERIALEVE: B/22						Sasia	7
Nr.	Profil	Materiale	Sasia	Gjatesia	Sip (m <sup>2</sup> )	Pesha(kg)	
P/23	CFRHS70X50X2.5	S235JR	1	955	0.2	4.2	
Totale					0.2	4.2	

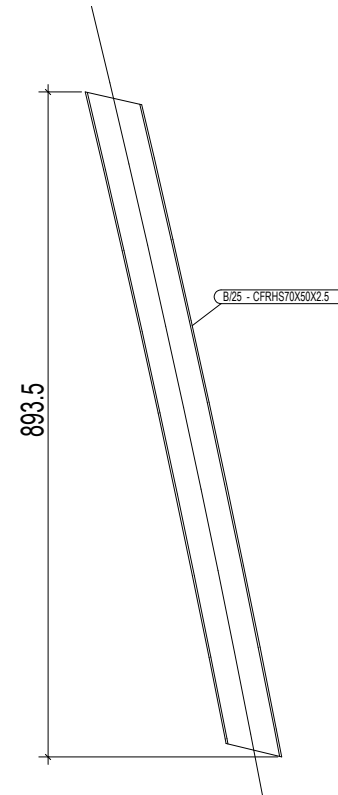
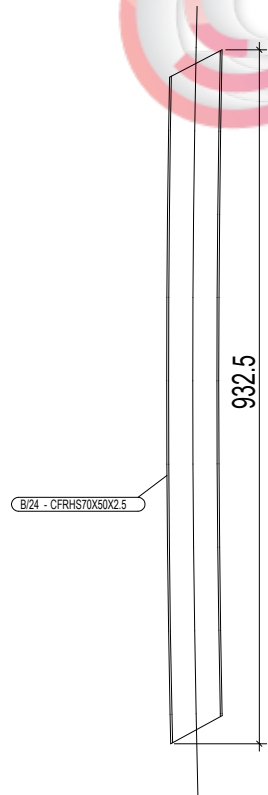
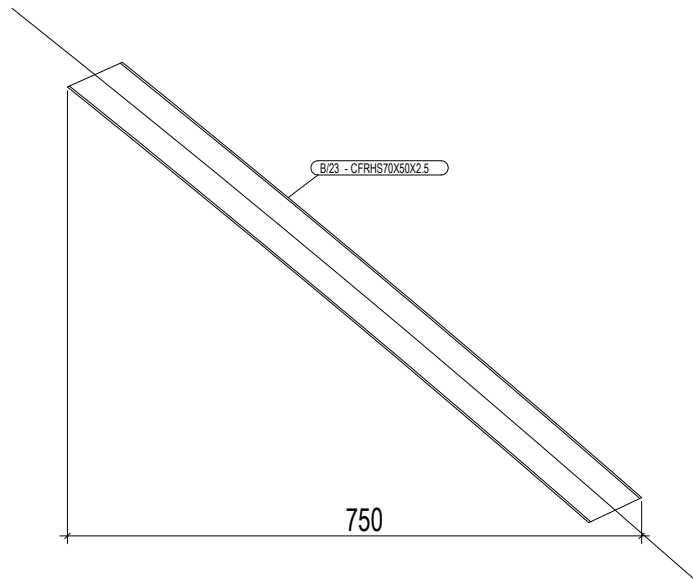

LISTA E MATERIALEVE: B/23						Sasia	7
Nr.	Profil	Materiale	Sasia	Gjatesia	Sip (m <sup>2</sup> )	Pesha(kg)	
P/24	CFRHS70X50X2.5	S235JR	1	919	0.2	4.0	
Totale					0.2	4.0	

LISTA E MATERIALEVE: B/24						Sasia	7
Nr.	Profil	Materiale	Sasia	Gjatesia	Sip (m <sup>2</sup> )	Pesha(kg)	
P/25	CFRHS70X50X2.5	S235JR	1	932	0.2	4.1	
Totale					0.2	4.1	

LISTA E MATERIALEVE: B/25						Sasia	7
Nr.	Profil	Materiale	Sasia	Gjatesia	Sip (m <sup>2</sup> )	Pesha(kg)	
P/26	CFRHS70X50X2.5	S235JR	1	929	0.2	4.1	
Totale					0.2	4.1	

### Shenime

Investitor  
Bashkia Memaliaj



Emertimi i projektit

NDERTIMI I KENDEVE SPORTIVE PER SHKOLLAT:  
9-VJECARE - "NIMETE PROGONATI" DHE  
E MESME - "SALI NIVICA"  
FAZA II

Faza e Projektit

PROJEKT ZBATIM

Projekti i  
infrastruktures

Konsulentit



Projektoi	Emer Mbiemer	Firma
Insh. Nderim	Vangjosh MBRICË	
Insh. Nderim	Andrian MBRICË	

Dwg.Nr. E1-05

Emertimi fletes:  
Detaje metalike

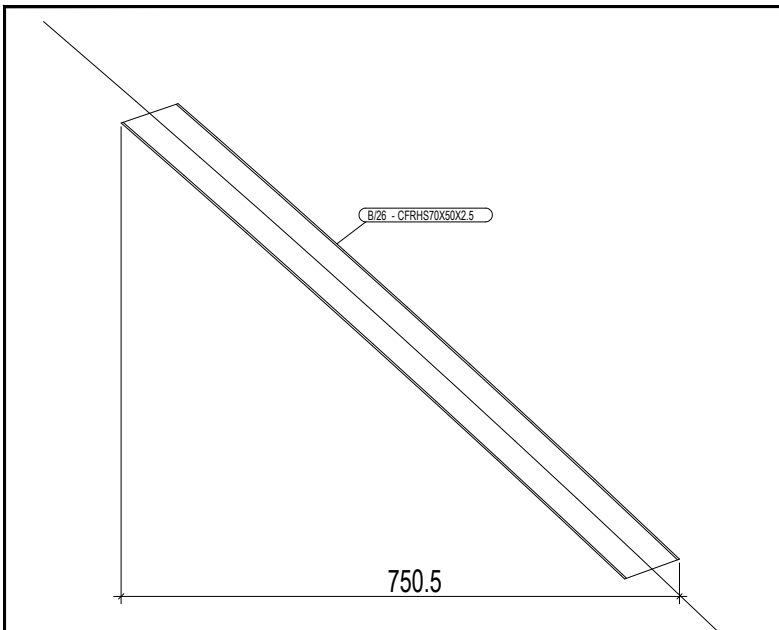

LISTA E MATERIALEVE: B/26						Sasia	7
Nr.	Profili	Materiale	Sasia	Gjatesia	Sip (m <sup>2</sup> )	Pesha(kg)	
P/27	CFRHS70X50X2.5	S235JR	1	950	0.2	4.2	
Totale					0.2	4.2	

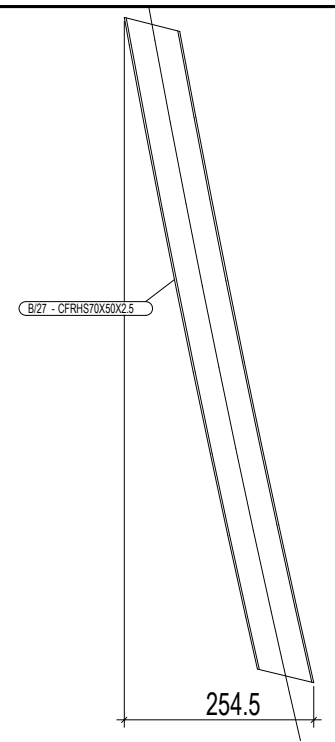

LISTA E MATERIALEVE: B/27						Sasia	7
Nr.	Profili	Materiale	Sasia	Gjatesia	Sip (m <sup>2</sup> )	Pesha(kg)	
P/28	CFRHS70X50X2.5	S235JR	1	927	0.2	4.1	
Totale					0.2	4.1	

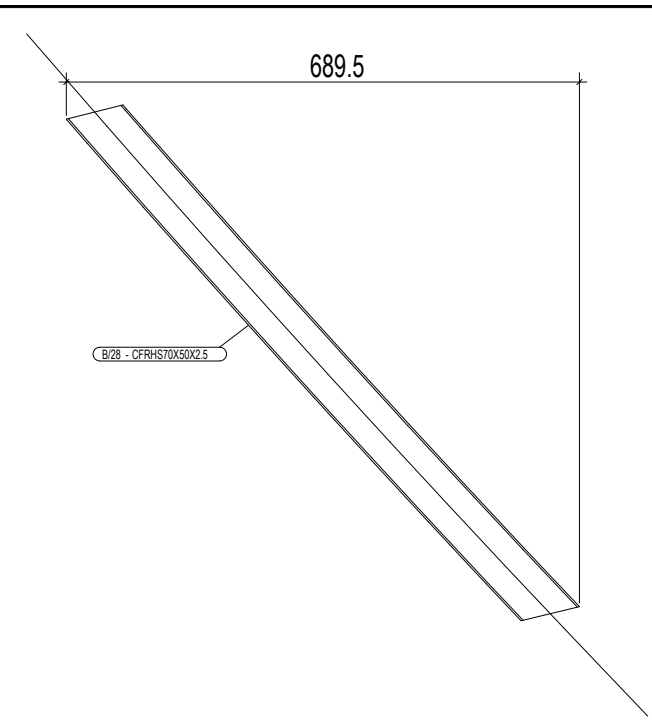

LISTA E MATERIALEVE: B/28						Sasia	7
Nr.	Profili	Materiale	Sasia	Gjatesia	Sip (m <sup>2</sup> )	Pesha(kg)	
P/29	CFRHS70X50X2.5	S235JR	1	949	0.2	4.2	
Totale					0.2	4.2	

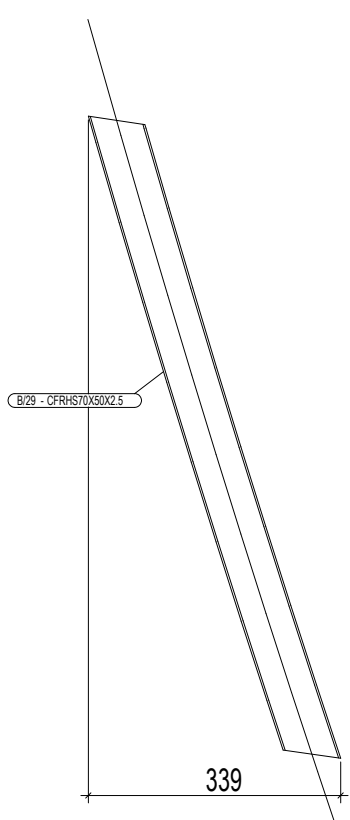

LISTA E MATERIALEVE: B/29						Sasia	7
Nr.	Profili	Materiale	Sasia	Gjatesia	Sip (m <sup>2</sup> )	Pesha(kg)	
P/30	CFRHS70X50X2.5	S235JR	1	925	0.2	4.1	
Totale					0.2	4.1	

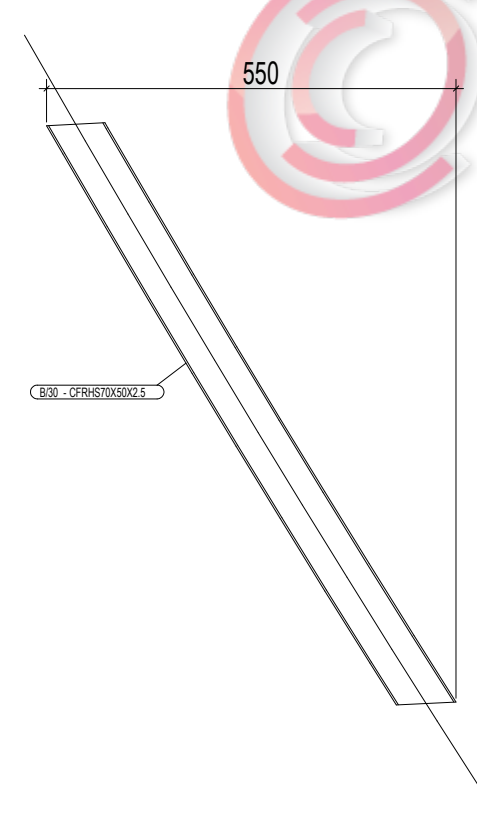

LISTA E MATERIALEVE: B/30						Sasia	14
Nr.	Profili	Materiale	Sasia	Gjatesia	Sip (m <sup>2</sup> )	Pesha(kg)	
P/31	CFRHS70X50X2.5	S235JR	1	948	0.2	4.2	
Totale					0.2	4.2	

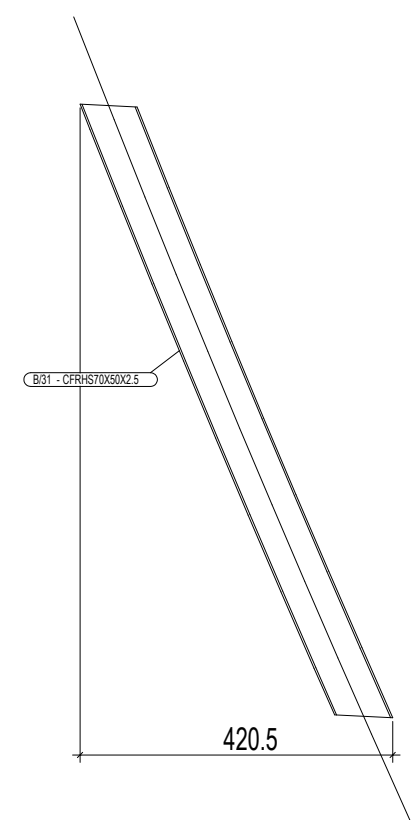

LISTA E MATERIALEVE: B/31						Sasia	7
Nr.	Profili	Materiale	Sasia	Gjatesia	Sip (m <sup>2</sup> )	Pesha(kg)	
P/32	CFRHS70X50X2.5	S235JR	1	923	0.2	4.1	
Totale					0.2	4.1	

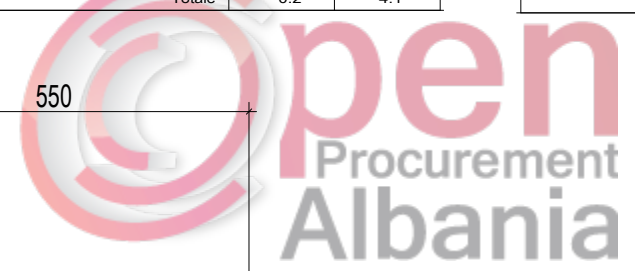

**Shenime**

Investitor  
Bashkia Memaliaj



Emertimi i projektit  
NDERTIMI I KENDEVE SPORTIVE PER SHKOLLAT:  
9-VJECARE - "NIMETE PROGONATI" DHE  
E MESME - "SALI NIVICA"  
FAZA II

Faza e Projektit  
PROJEKT ZBATIM

Projekti i infrastruktures

Konsulentit  
C.E.C Group  
Civil Engineering Consultants

Projektit	Emer Mbiemer	Firma
Insh. Nderim	Vangjosh MBRIÇI	
Insh. Nderim	Andrian MBRIÇI	

Dwg.Nr. E1-06

Emertimi fletes:  
Detaje metalike



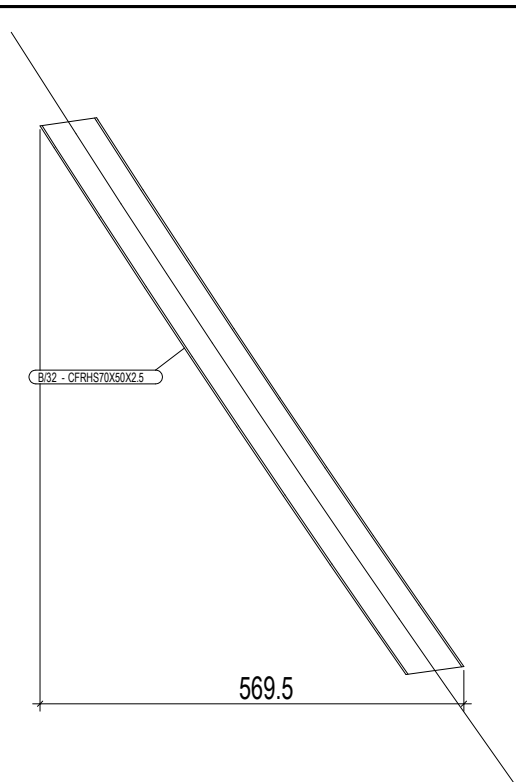

LISTA E MATERIALEVE: B/32							Sasia	14	
Nr.	Profil	Materiale	Sasia	Gjatesia	Sip (m <sup>2</sup> )	Pesha(kg)			
P/33	CFRHS70X50X2.5	S235JR	1	921	0.2	4.0			
					Totale	0.2	4.0		

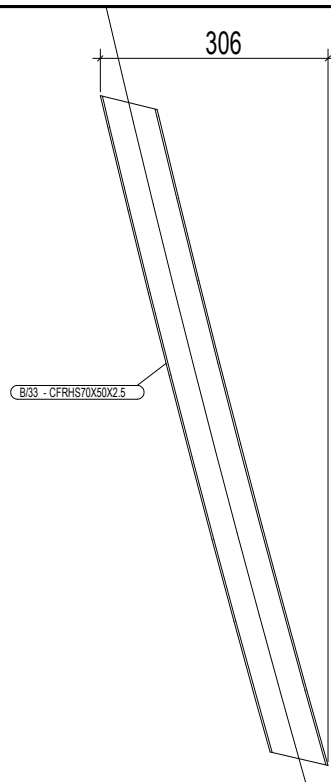

LISTA E MATERIALEVE: B/33							Sasia	21	
Nr.	Profil	Materiale	Sasia	Gjatesia	Sip (m <sup>2</sup> )	Pesha(kg)			
P/34	CFRHS70X50X2.5	S235JR	1	948	0.2	4.2			
					Totale	0.2	4.2		

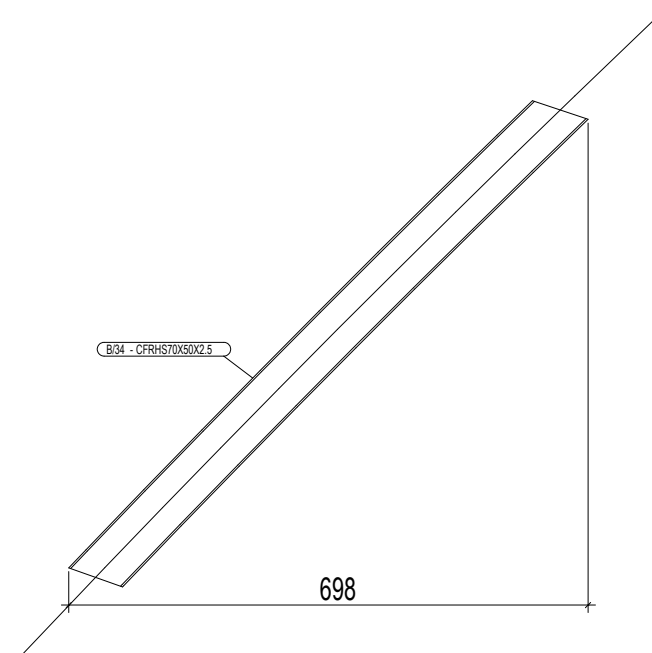

LISTA E MATERIALEVE: B/34							Sasia	14	
Nr.	Profil	Materiale	Sasia	Gjatesia	Sip (m <sup>2</sup> )	Pesha(kg)			
P/35	CFRHS70X50X2.5	S235JR	1	920	0.2	4.0			
					Totale	0.2	4.0		

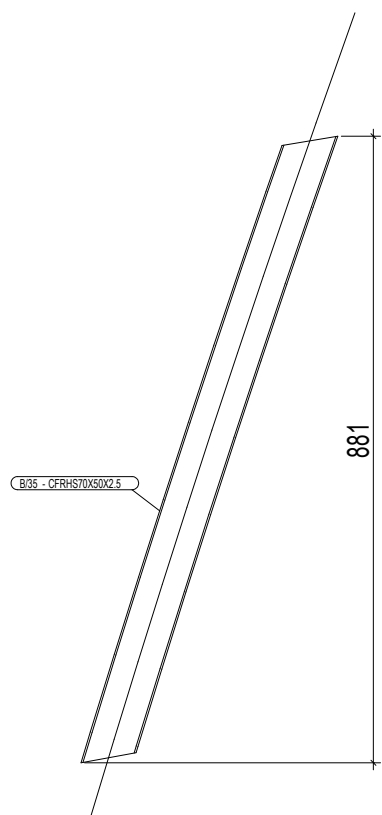

LISTA E MATERIALEVE: B/35							Sasia	7	
Nr.	Profil	Materiale	Sasia	Gjatesia	Sip (m <sup>2</sup> )	Pesha(kg)			
P/36	CFRHS70X50X2.5	S235JR	1	949	0.2	4.2			
					Totale	0.2	4.2		

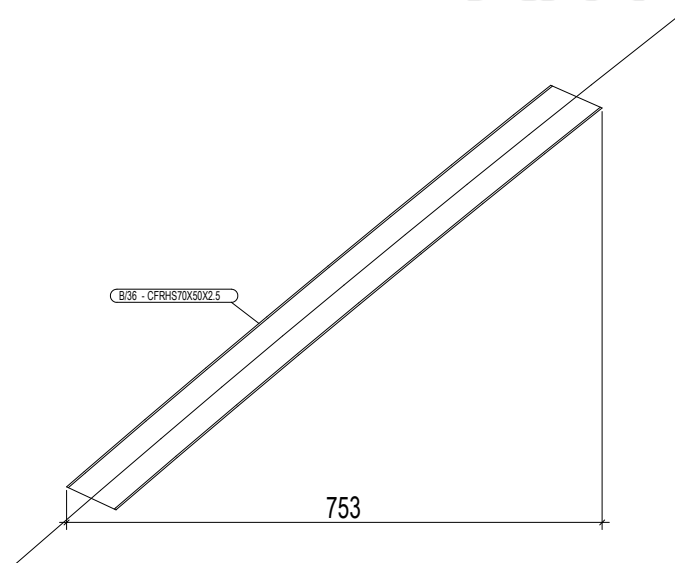

LISTA E MATERIALEVE: B/36							Sasia	7	
Nr.	Profil	Materiale	Sasia	Gjatesia	Sip (m <sup>2</sup> )	Pesha(kg)			
P/37	CFRHS70X50X2.5	S235JR	1	920	0.2	4.0			
					Totale	0.2	4.0		

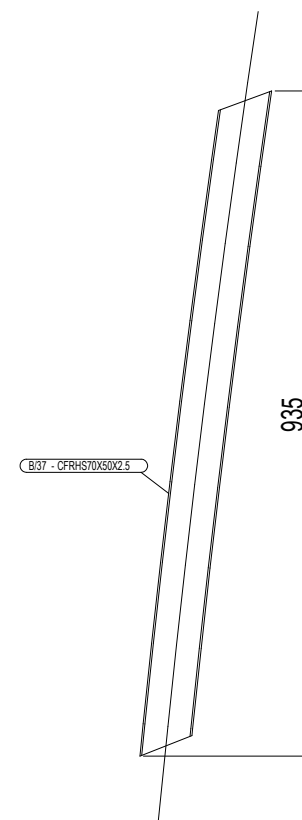

LISTA E MATERIALEVE: B/37							Sasia	7	
Nr.	Profil	Materiale	Sasia	Gjatesia	Sip (m <sup>2</sup> )	Pesha(kg)			
P/38	CFRHS70X50X2.5	S235JR	1	951	0.2	4.2			
					Totale	0.2	4.2		

### Shenime

Investitor  
Bashkia Memaliaj



Emertimi i projektit

NDERTIMI I KENDEVE SPORTIVE PER SHKOLLAT:  
9-VJECARE - "NIMETE PROGONATI" DHE  
E MESME - "SALI NIVICA"  
FAZA II

Faza e Projektit

PROJEKT ZBATIM

Projekti i  
infrastruktures

Konsulentit



Projektoi	Emer Mbiemer	Firma
Insh. Nderim	Vangjosh MBRICË	
Insh. Nderim	Andrian MBRICË	

Dwg.Nr. E1-07

Emertimi fletes:  
Detaje metalike

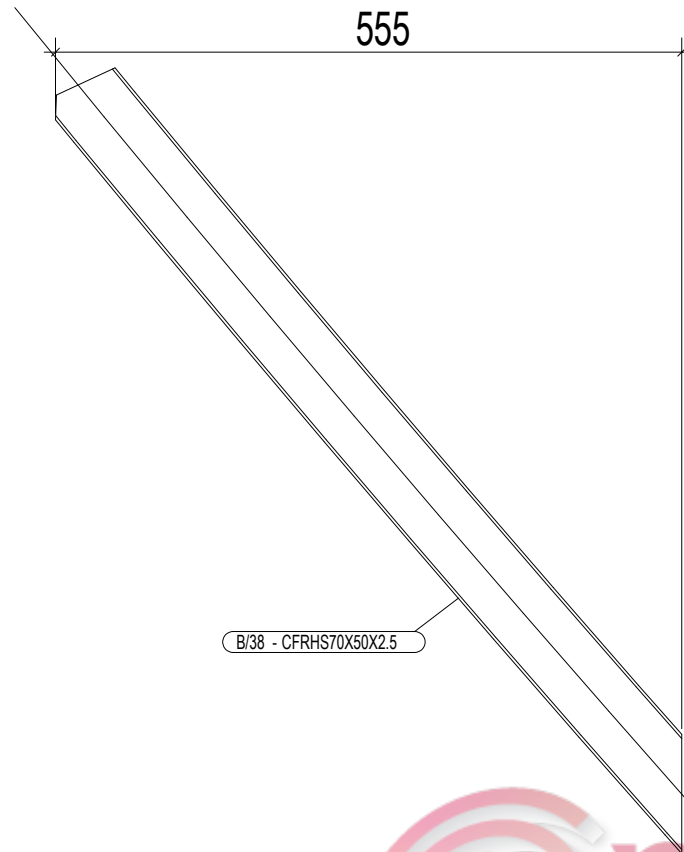

LISTA E MATERIALEVE: B/38						Sasia	7
Nr.	Profili	Materiale	Sasia	Gjatesia	Sip (m <sup>2</sup> )	Pesha(kg)	
P/39	CFRHS70X50X2.5	S235JR	1	870	0.2	3.8	
Totale					0.2	3.8	

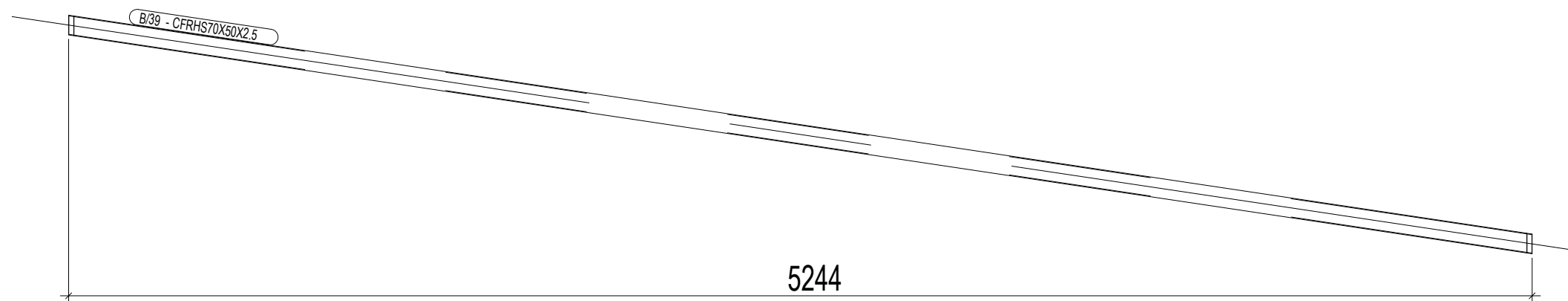

LISTA E MATERIALEVE: B/39						Sasia	6
Nr.	Profili	Materiale	Sasia	Gjatesia	Sip (m <sup>2</sup> )	Pesha(kg)	
P/40	CFRHS70X50X2.5	S235JR	1	5313	1.2	23.3	
Totale					1.2	23.3	

**Shenime**

Investitor  
Bashkia Memaliaj



Emertimi i projektit

NDERTIMI I KENDEVE SPORTIVE PER SHKOLLAT:  
9-VJECARE - "NIMETE PROGONATI" DHE  
E MESME - "SALI NIVICA"  
FAZA II

Faza e Projektit

PROJEKT ZBATIM

**Projekti i infrastruktures**

Konsulentit



Projektoi	Emer Mbiemer	Firma
Insh. Nderim	Vangjosh MBRICJE	
Insh. Nderim	Andrius MBRICJE	

Dwg.Nr. E1-08

Emertimi fletes:  
Detaje metalike

FR S

FAZA	SASIA
1	12

Lista e aterialeve		Sasia 12				
Profili	Materia	Sasia	jatesia	Sip.(m <sup>2</sup> )	Pesha(kg)	
P	FR S	SJR				
Totale						

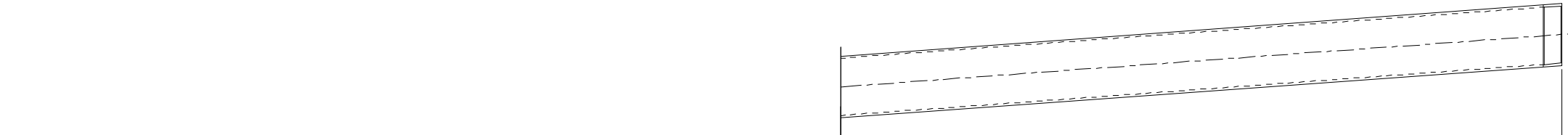

FAZA	SASIA

Lista e aterialeve		Sasia				
Profili	Materia	Sasia	jatesia	Sip.(m <sup>2</sup> )	Pesha(kg)	
P	FR S	SJR				
Totale						

FR S

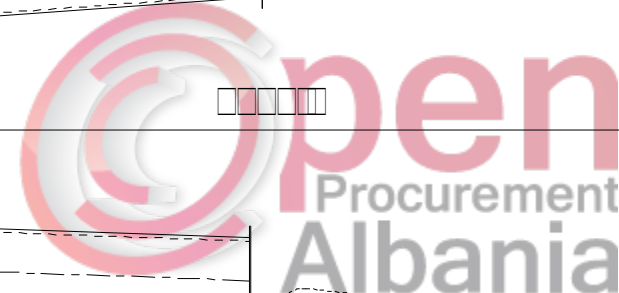
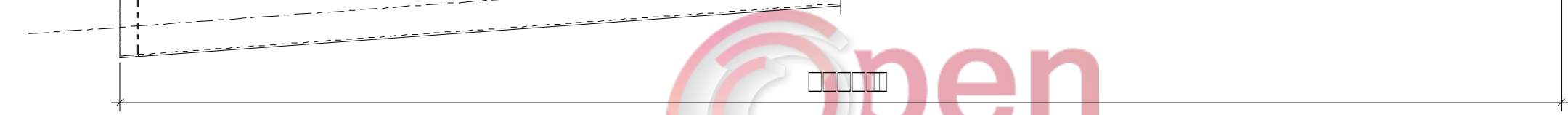

FAZA	SASIA

Lista e aterialeve		Sasia				
Profili	Materia	Sasia	jatesia	Sip.(m <sup>2</sup> )	Pesha(kg)	
P	FR S	SJR				
Totale						

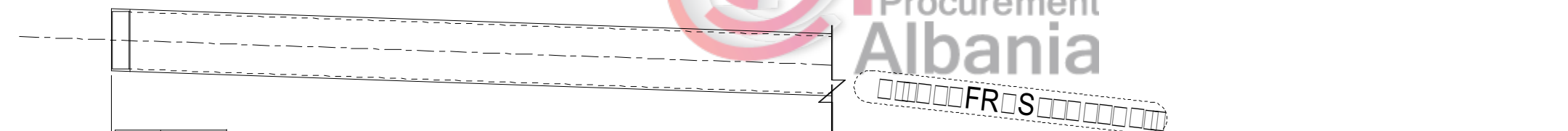

FR S

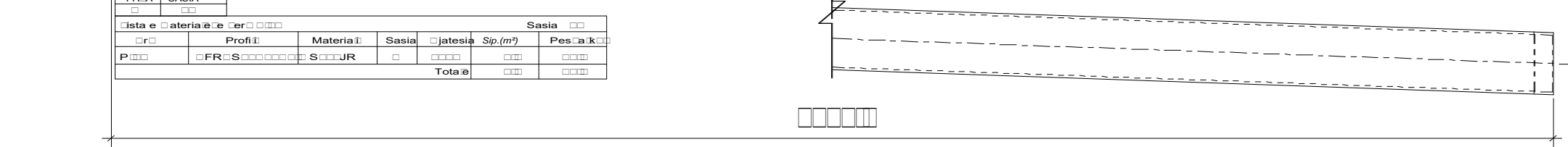

FR S

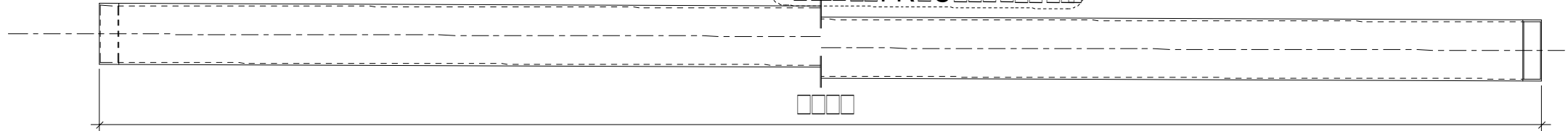

FAZA	SASIA

Lista e aterialeve		Sasia				
Profili	Materia	Sasia	jatesia	Sip.(m <sup>2</sup> )	Pesha(kg)	
P	FR S	SJR				
Totale						

Shenime

Investitor  
Bashkia Memaliaj



Emertimi i projektit  
NDERTIMI I KENDEVE SPORTIVE PER SHKOLLAT 9-VJECARE - "NIMETE PRAGONATI" DHE E MESME "SALI NIVICA" FAZA II

Faza e Projektit  
PROJEKT ZBATIM

Projekti i infrastruktures

Konsulentit  
C.E.C Group  
Civil Engineering Consultants

Projektoi	Emer Mbiemer	Firma
Insh. Nderim	Vangush MBRIÇE	
Insh. Nderim	Andon MBRIÇE	

Dwg.Nr. E1.0

Emertimi fletes:  
Detaje metalike

B/44 - CFRHS70X50X2.5

5274

FAZA	SASIA					
1	6					
Nr.	Profil	Materiali	Sasia	Gjatesia	Sip. (m <sup>2</sup> )	Pesha(kg)
P/45	CFRHS70X50X2.5	S235JR	1	5341	1.2	23.4
Totale					1.2	23.4

B/45 - CFRHS70X50X2.5

4880

FAZA	SASIA					
1	12					
Nr.	Profil	Materiali	Sasia	Gjatesia	Sip. (m <sup>2</sup> )	Pesha(kg)
P/46	CFRHS70X50X2.5	S235JR	1	4880	1.1	21.4
Totale					1.1	21.4

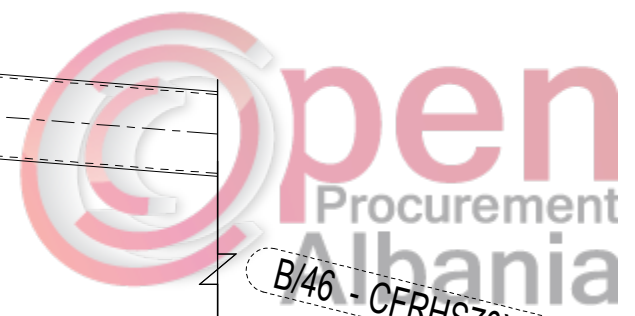

B/46 - CFRHS70X50X2.5

5372

FAZA	SASIA					
1	3					
Nr.	Profil	Materiali	Sasia	Gjatesia	Sip. (m <sup>2</sup> )	Pesha(kg)
P/47	CFRHS70X50X2.5	S235JR	1	5389	1.2	23.6
Totale					1.2	23.6

B/47 - IPE220

5000

FAZA	SASIA					
1	12					
Nr.	Profil	Materiali	Sasia	Gjatesia	Sip. (m <sup>2</sup> )	Pesha(kg)
P/48	IPE220	S235JR	1	5000	4.2	131.1
Totale					4.2	131.1

Shenime

Investitor  
Bashkia Memaliaj



Emertimi i projektit

NDERTIMI I KENDEVE SPORTIVE PER SHKOLLAT 9-VJECARE - "NIMETE PRAGONATI" DHE E MESME "SALI NIVICA" FAZA II

Faza e Projektit

PROJEKT ZBATIM

Projekti i infrastruktures

Konsulentit



Projektoi	Emer Mbiemer	Firma
Insh. Nderim	Vangush MBRICË	
Insh. Nderim	Andreu MBRICË	

Dwg.Nr. E1.10

Emertimi fletes:  
Detaje metalike

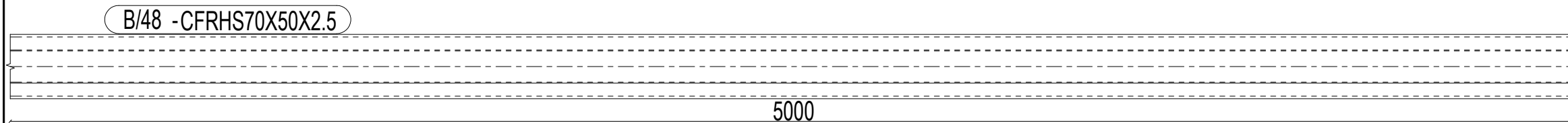
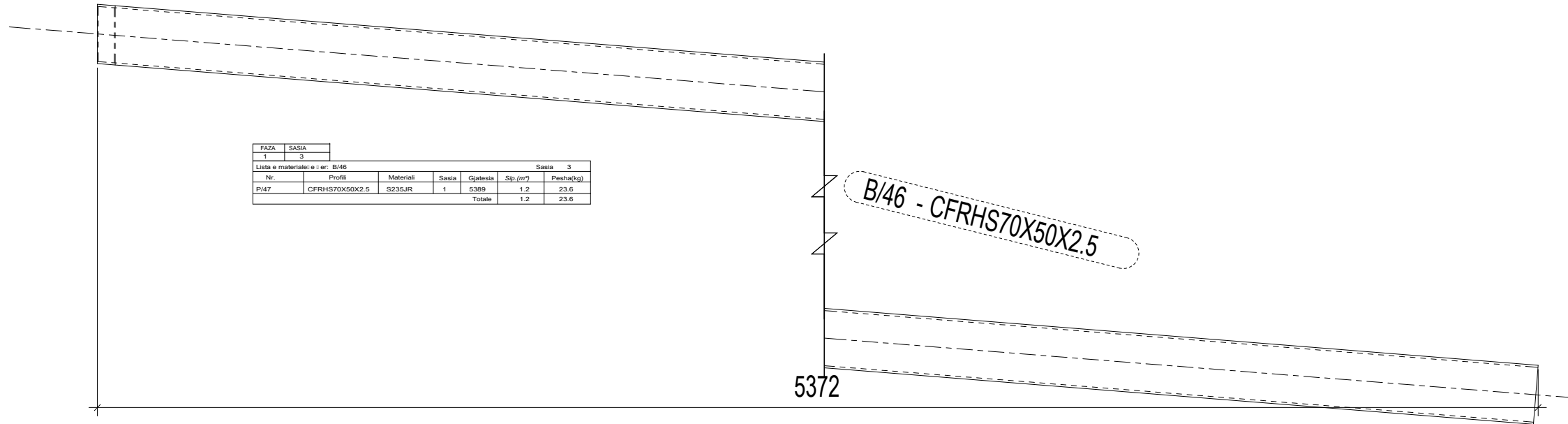

FAZA	SASIA
1	114

Lista e materialeve e i er: B/49						
Nr.	Profil	Materiali	Sasia	Gjatesia	Sip. (m <sup>2</sup> )	Pesha(kg)
P/56	CFRHS70X50X2.5	S235JR	1	5000	1.2	21.9
Totale					1.2	21.9

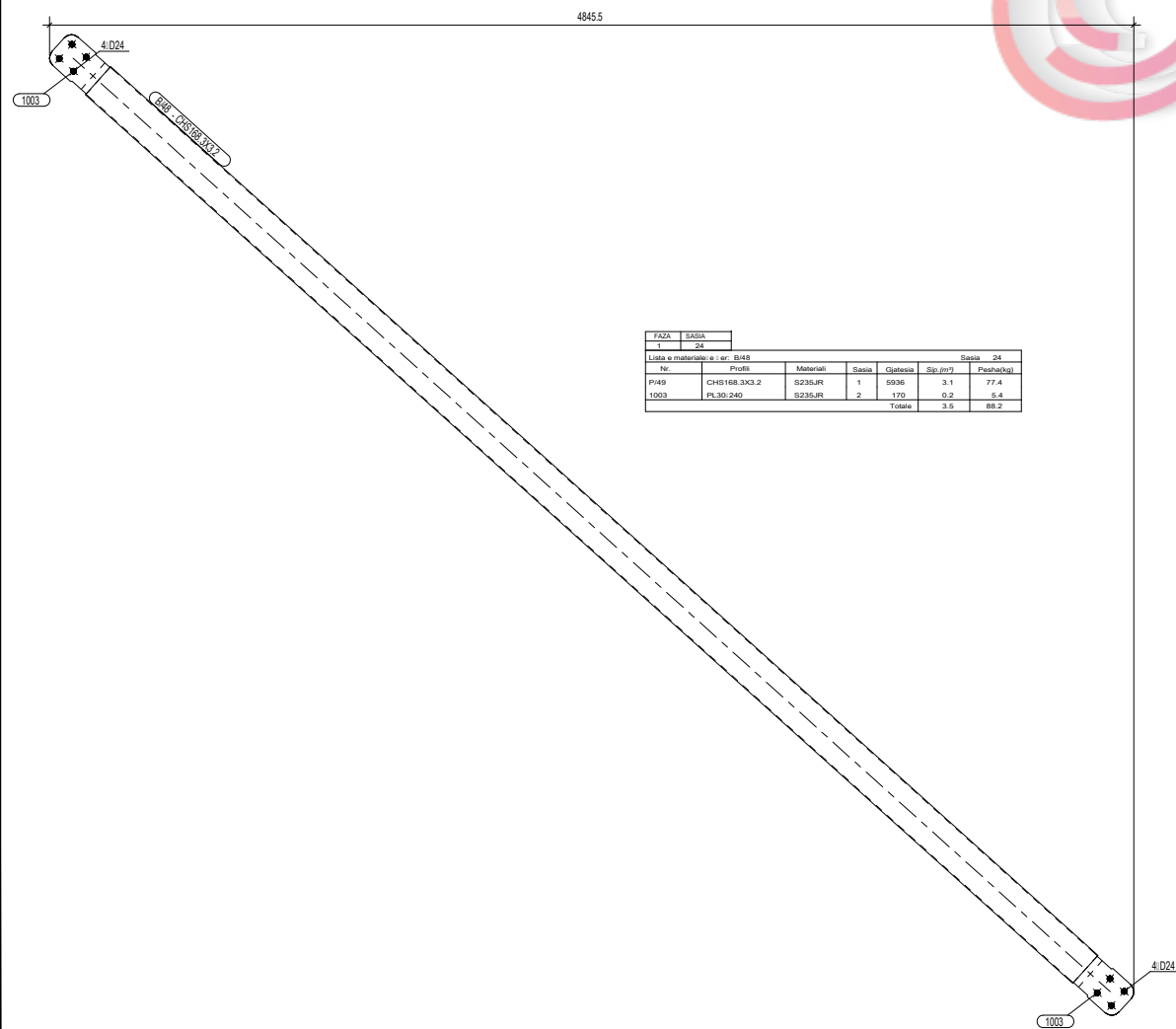

FAZA	SASIA
1	24

Lista e materialeve e i er: B/48						
Nr.	Profil	Materiali	Sasia	Gjatesia	Sip. (m <sup>2</sup> )	Pesha(kg)
P/48	CW118x3x3.2	S235JR	1	5600	3.1	77.4
1003	PL30x240	S235JR	2	170	0.2	8.4
Totale					3.3	85.8

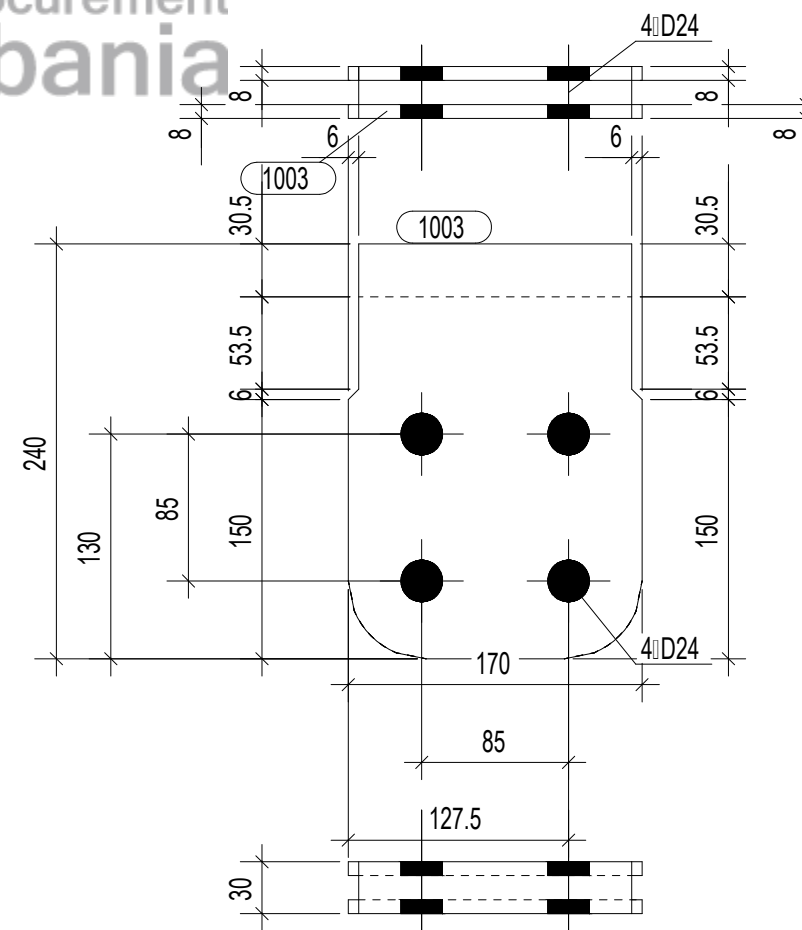

Shenime

Investitor  
Bashkia Memaliaj



Emertimi i projektit

NDERTIMI I KENDEVE SPORTIVE PER SHKOLLAT 9-VJECARE - NIMETE PRAGONATI DHE E MESME "SALI NIVICA" FAZA II

Faza e Projektit

PROJEKT ZBATIM

Projekti i infrastruktures

Konsulentit



Projektoi	Emer Mbiemer	Firma
Insh. Nderim	Vangjush MBRICË	
Insh. Nderim	Andren MBRICË	

Dwg.Nr. E1.11

Emertimi fletes:  
Detaje metalike

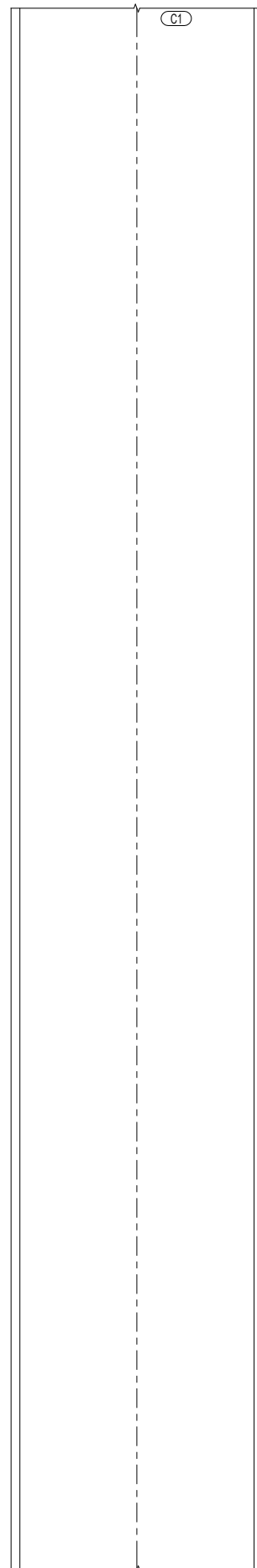

7250

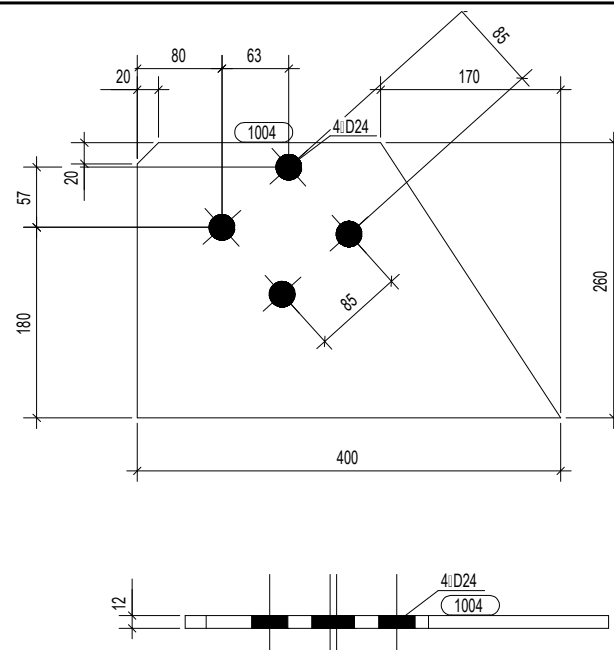

FAZA	SASIA
1	10

Lista e materialeve i nr: C/1						
Nr.	Profil	Materiali	Sasia	Gjatesia	Sip.(m <sup>2</sup> )	Pesha(kg)
P/4	IPE330	S235JR	1	7240	9.1	355.8
1001	PL10:360	S235JR	1	600	0.5	17.0
1004	PL12:260	S235JR	4	400	0.2	7.7
1002	PL10:100	S235JR	6	200	0.0	1.4
Totale					10.5	411.8



7240

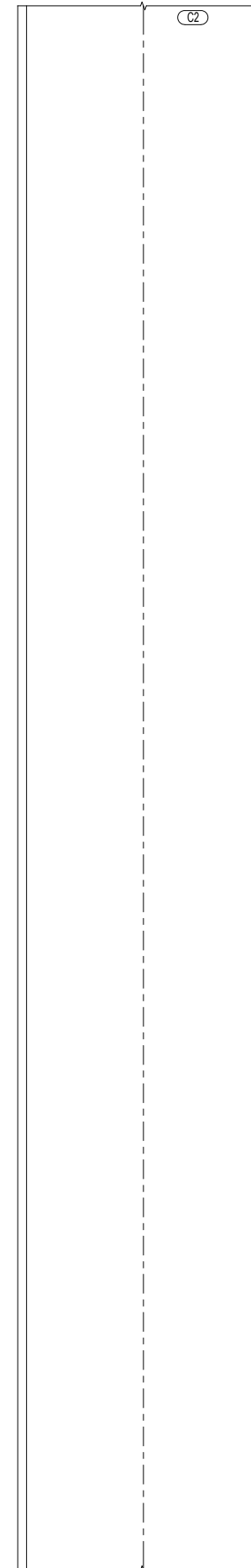

FAZA	SASIA
1	4

Lista e materialeve i nr: C/2						
Nr.	Profil	Materiali	Sasia	Gjatesia	Sip.(m <sup>2</sup> )	Pesha(kg)
P/4	IPE330	S235JR	1	7240	9.1	355.8
1001	PL10:360	S235JR	1	600	0.5	17.0
1004	PL12:260	S235JR	2	400	0.2	7.7
1002	PL10:100	S235JR	6	200	0.0	1.4
Totale					10.1	396.4

Shenime

Investitor  
Bashkia Memaliaj



Emertimi i projektit

NDERTIMI I KENDEVE SPORTIVE PER SHKOLLAT 9-VJECARE - "NIMETE PRAGONATI" DHE E MESME "SALI NIVICA" FAZA II

Faza e Projektit

PROJEKT ZBATIM

Projekti i infrastruktures

Konsulent



Projektoi	Emer Mbiemer	Firma
Insh. Nderim	Vangush MBRICË	
Insh. Nderim	Andren MBRICË	

Dwg.Nr. E1.12

Emertimi fletes:  
Detaje metalike

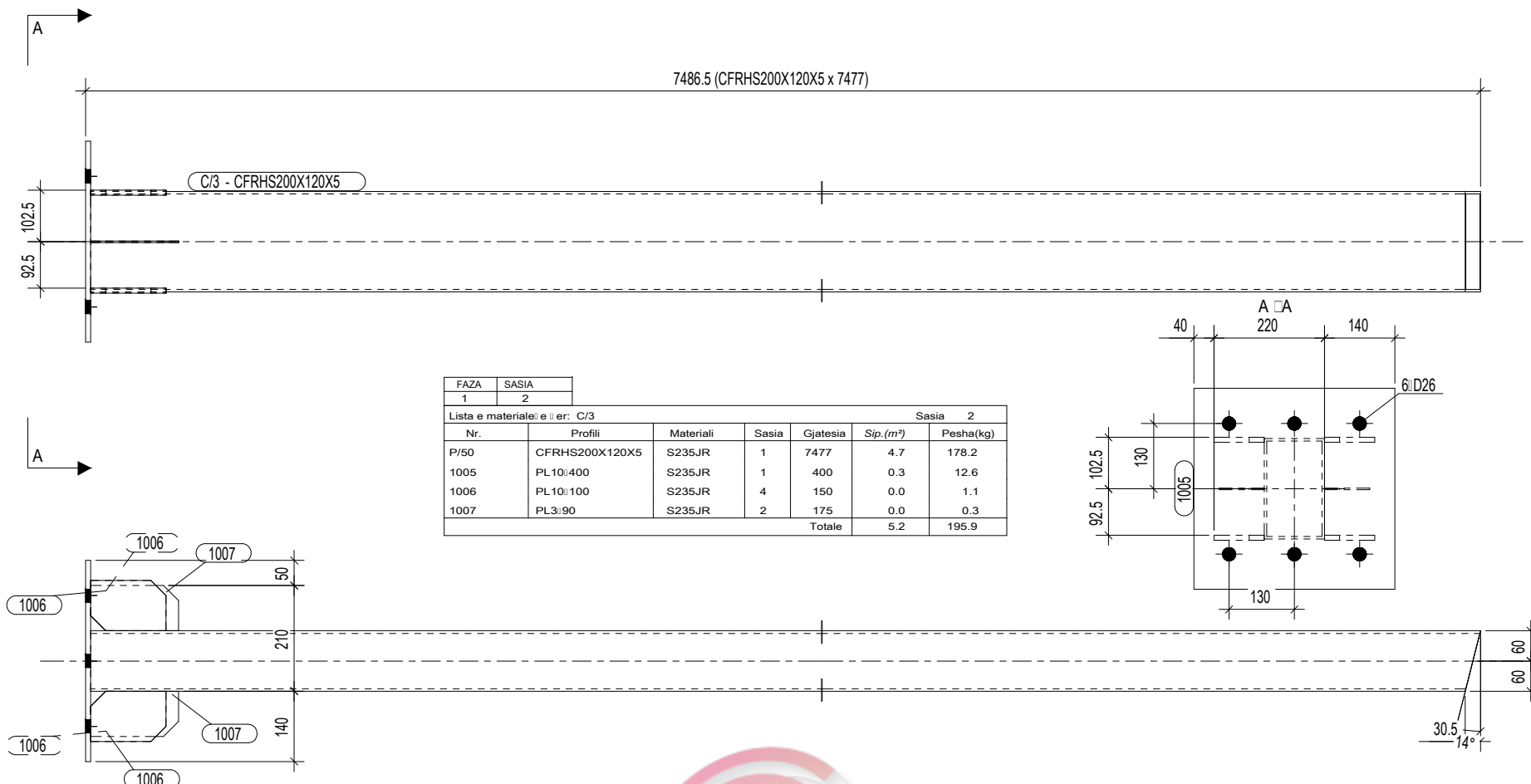

FAZA		SASIA					
1	2	1	2				
Lista e materialeve i referencës: C/3							
Nr.	Profil	Materiale	Sasia	Gjatesia	Sip. (m <sup>2</sup> )	Pesha (kg)	
P/50	CFRHS200X120X5	S235JR	1	7477	4.7	178.2	
1005	PL10/400	S235JR	1	400	0.3	12.6	
1006	PL10/100	S235JR	4	150	0.0	1.1	
1007	PL3/90	S235JR	2	175	0.0	0.3	
Totale				5.2		195.9	



FAZA		SASIA					
1	2	1	2				
Lista e materialeve i referencës: ...							
Nr.	Profil	Materiale	Sasia	Gjatesia	Sip. (m <sup>2</sup> )	Pesha (kg)	
P/50	FRS...	S...					
	P/...	S...					
	P/...	S...					
	P/...	S...					
Totale							

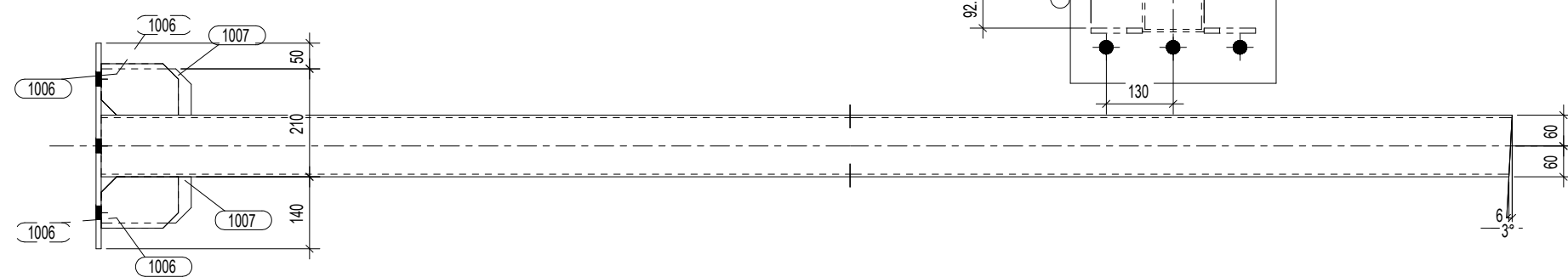

Shenime

Investitor	Bashkia Memaliaj	
Emertimi i projektit	NDERTIMI I KENDEVE SPORTIVE PER SHKOLLAT 9-VJECARE - "NIMETE PRAGONATI" DHE E MESME "SALI NIVICA" FAZA II	
Faza e Projektit	PROJEKT ZBATIM	
Projekti i infrastruktures		
Konsulent		
Projektoi	Emer Mbiemer	Firma
Insh. Nderim	Vangjush MBRICË	
Insh. Nderim	Andren MBRICË	

Dwg.Nr. E1.13

Emertimi fletes:  
Detaje metalike

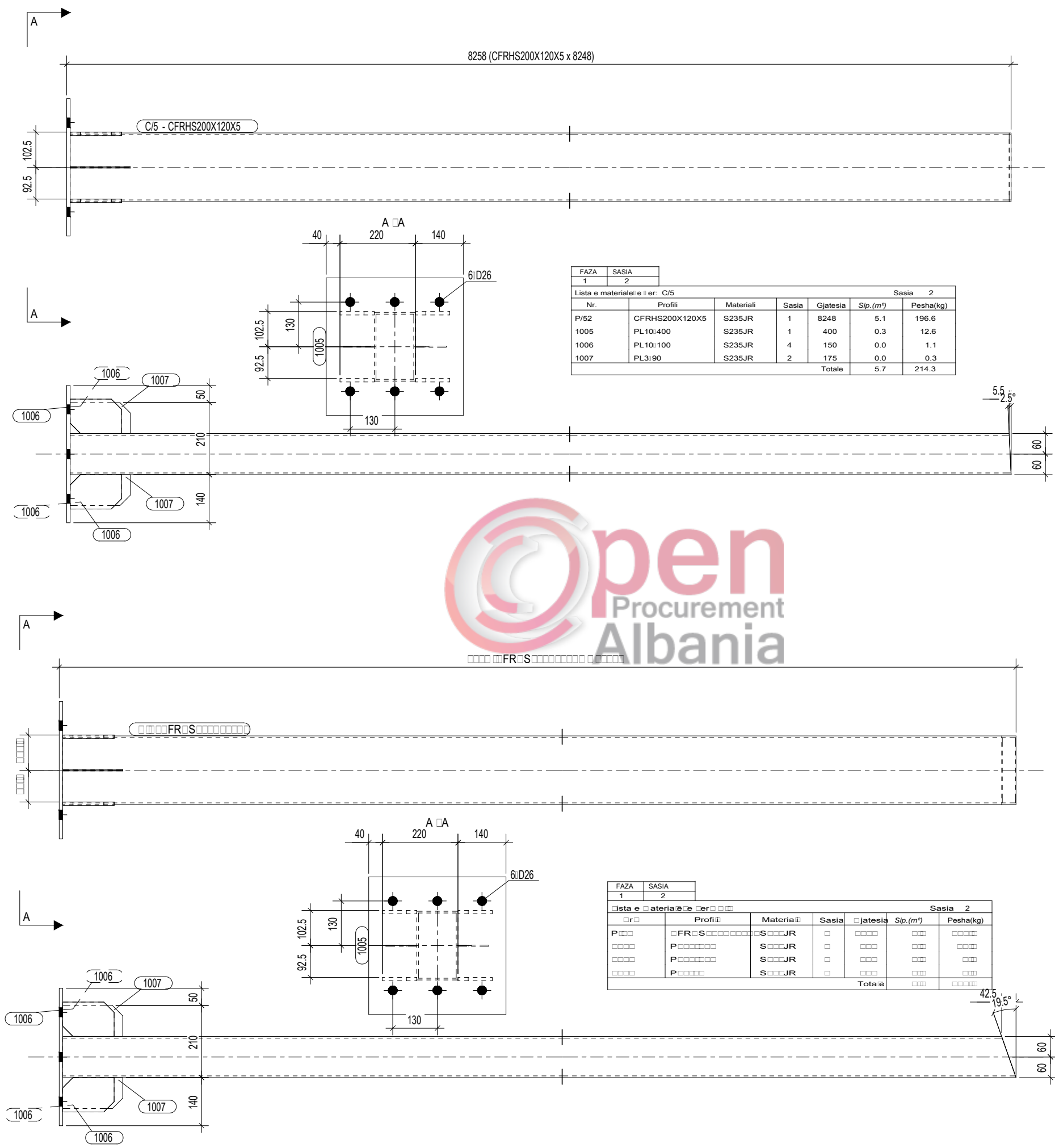

FAZA		SASIA				Sasia 2	
1	2						
Lista e materialeve për: C/5							
Nr.	Profili	Materiali	Sasia	Gjatesia	Sip.(m <sup>2</sup> )	Pesha(kg)	
P/52	CFRHS200X120X5	S235JR	1	8248	5.1	196.6	
1005	PL10:400	S235JR	1	400	0.3	12.6	
1006	PL10:100	S235JR	4	150	0.0	1.1	
1007	PL3:90	S235JR	2	175	0.0	0.3	
Totale					5.7	214.3	

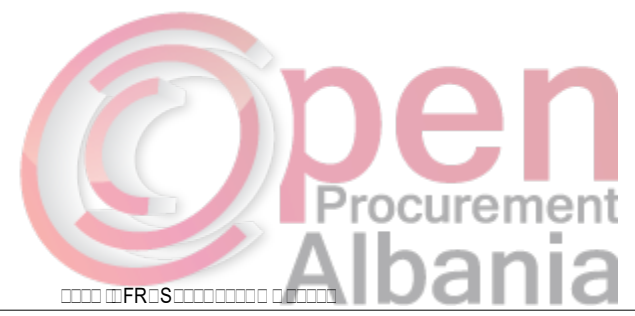

FAZA		SASIA				Sasia 2	
1	2						
Lista e materialeve për: [ ]							
[ ]	Profili	Materiali	Sasia	Gjatesia	Sip.(m <sup>2</sup> )	Pesha(kg)	
P[ ]	[ ]FR[S[ ]	[ ]S[ ]JR	[ ]	[ ]	[ ]	[ ]	[ ]
P[ ]	[ ]	[ ]S[ ]JR	[ ]	[ ]	[ ]	[ ]	[ ]
[ ]	P[ ]	[ ]S[ ]JR	[ ]	[ ]	[ ]	[ ]	[ ]
[ ]	P[ ]	[ ]S[ ]JR	[ ]	[ ]	[ ]	[ ]	[ ]
Totale					[ ]	[ ]	[ ]

**Shenime**

---

Investitor  
Bashkia Memaliaj

Emertimi i projektit  
NDERTIMI I KENDEVE SPORTIVE PER SHKOLLAT 9-VJECARE - "NIMETE PRAGONATI" DHE E MESME "SALI NIVICA" FAZA II

Faza e Projektit  
PROJEKT ZBATIM

**Projekti i infrastruktures**

Konsulentit  
  
C.E.C Group  
Civil Engineering Consultants

Projekttoi	Emer Mbiemer	Firma
Imsh. Nderim	Vangush MBRICË	
Imsh. Nderim	Andren MBRICË	

---

Dwg.Nr. E1.14

Emertimi fletes:  
Detaje metalike



Shenime

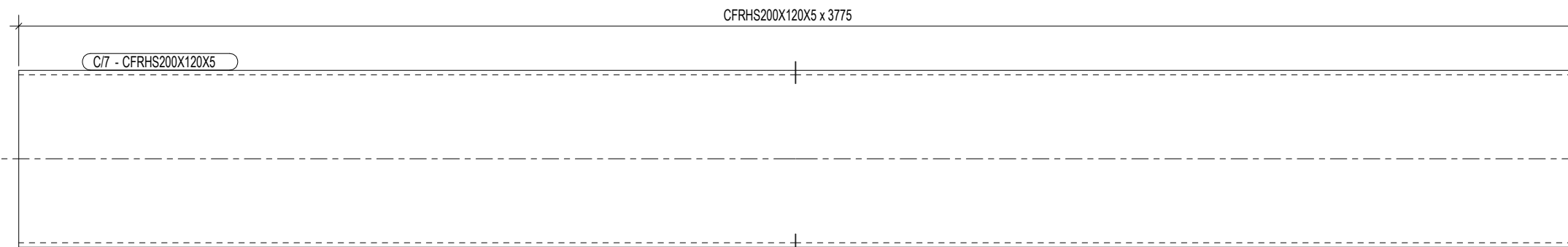

FAZA	SASIA					
1	20					
Lista e materialeve i er: C/7						Sasia 20
Nr.	Profil	Materiali	Sasia	Gjatesia	Sip.(m <sup>2</sup> )	Pesha(kg)
P/54	CFRHS200X120X5	S235JR	1	3775	2.4	90.0
			<b>Totale</b>	<b>2.4</b>	<b>90.0</b>	

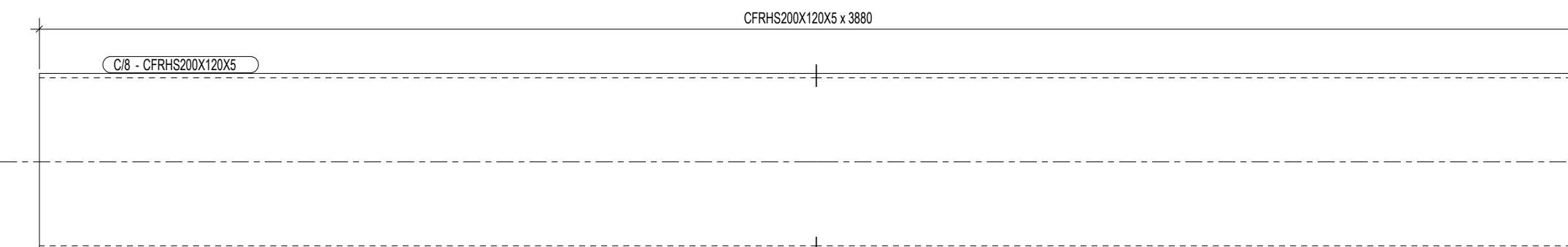
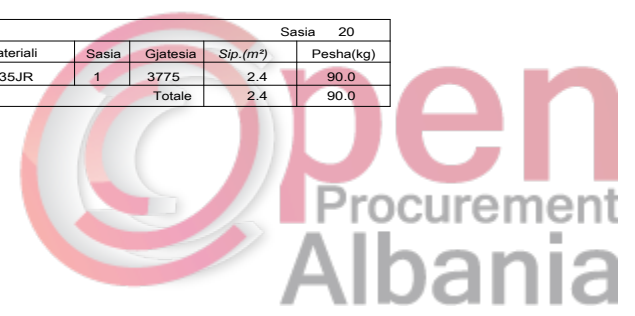

FAZA	SASIA					
1	30					
Lista e materialeve i er: C/8						Sasia 30
Nr.	Profil	Materiali	Sasia	Gjatesia	Sip.(m <sup>2</sup> )	Pesha(kg)
P/55	CFRHS200X120X5	S235JR	1	3880	2.4	92.5
			<b>Totale</b>	<b>2.4</b>	<b>92.5</b>	

Investitor  
Bashkia Memaliaj



Emertimi i projektit  
NDERTIMI I KENDEVE SPORTIVE PER SHKOLLAT 9-VJECARE - "NIMETE PROGONATI" DHE E MESME "SALI NIVICA" FAZA II

Faza e Projektit  
PROJEKT ZBATIM

Projekti i infrastruktures

Konsulentit  
C.E.C Group  
Civil Engineering Consultants

Projektoi	Emer	Mbiemer	Firma
Insh. Nderim	Vangush MBRICË		
Insh. Nderim	Andren MBRICË		

Dwg.Nr. E1.15

Emertimi fletes:  
Detaje metalike