

INVESTITOR : BASHKIA PEQIN

PROJEKT ZBATIMI



**OBJEKTI: RIKONSTRUKSION DHE NDERTIM PALESTRE I SHKOLLES SE MESME PAJOVE
"MUSTAFA KEMAL ATATURK"**

	"Ersi" - shpk Adresa / Rruga Margarita Tutulani - Tirane Mobil 0.672073098 : e-mail ersi-shpk@hotmail.com / fagoxhaj@hotmail.com	INVESTITORI :BASHKIA PEQIN	PROJEKT - ZBATIMI	INXHINIER KONSTRUKTOR	FATBARDHA GOXHAJ	N R .0265 /9	SHKALLA 1 : 1000
	PROJEKTUES SHOQERIA "ERSI" N R . 3418 / 9 LICENSE	OBJEKTI: SHKOLLA E MESME PAJOVE "MUSTAFA KEMAL ATATURK" BASHKIA -PEQIN	SHKOLLA "MUSTAFA KEMAL ATATURK"	INXHINIER KONSTRUKTOR	ENXHI ÇELAJ		DATA E REALIZIMIT SHTATOR 2018
				INXHINIER HIDROTEKNIK	ANJEZA NEBIAJ		
				ARKITEKT	SOKOL AGAJ	A.1363/1	FLETA I
				ARKITEKT	IRINI GJONE		

INVESTITOR : BASHKIA PEQIN
PROJEKT ZBATIMI

PLANVENDOSJE E OBJEKTIT



**OBJEKTI: RIKONSTRUKSION DHE NDERTIM PALESTRE I SHKOLLES SE MESME PAJOVE
 "MUSTAFA KEMAL ATATURK"**



	" Ersi " - shpk Adresa / Rruga Margarita Tutulani - Tirane Mobil 0.672073098 : e - mail ersi-shpk@ hotmail .com / fagoxhaj@hotmail.com	INVESTITORI :BASHKIA PEQIN	PROJEKT - ZBATIMI	INXHINIER KONSTRUKTOR	FATBARDHA GOXHAJ	N R .0265 /9	SHKALLA 1 : 1000
	PROJEKTUES SHOQERIA " ERSI " N R . 3418 / 9 LICENSE	OBJEKTI: SHKOLLA E MESME PAJOVE "MUSTAFA KEMAL ATATURK" BASHKIA -PEQIN	SHKOLLA "MUSTAFA KEMAL ATATURK"	INXHINIER KONSTRUKTOR	ENXHI ÇELAJ		DATA E REALIZIMIT
				INXHINIER HIDROTEKNIK	ANJEZA NEBIJ		SHTATOR 2018
				ARKITEKT	SOKOL AGAJ	A.1363/1	FLETA I
			ARKITEKT	IRINI GJONE			

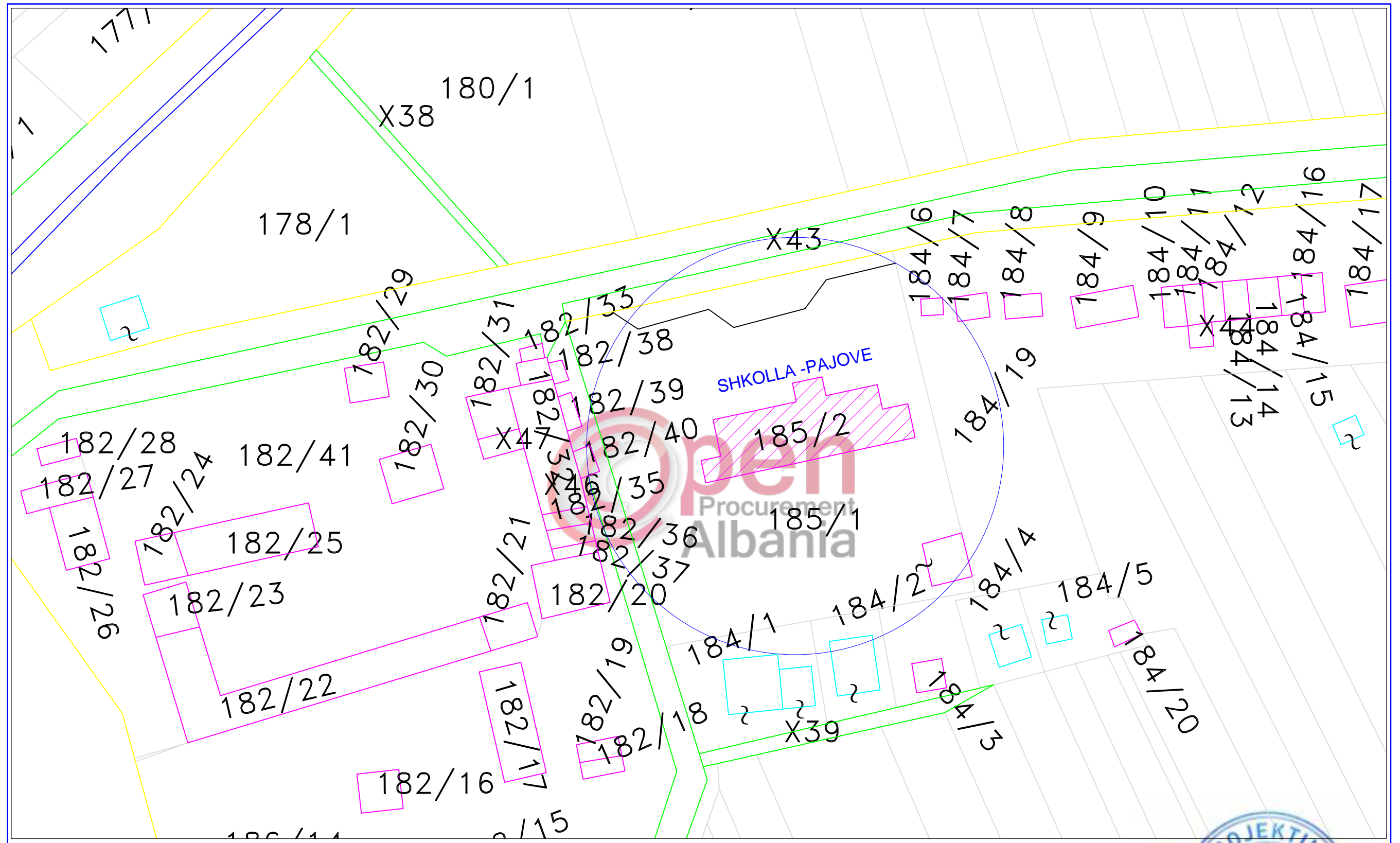

SHKOLLA "MUSTAFA KEMAL ATATURK" HARTA KADASTRALE



"Ersi" - shpk
 Adresa / Rruga Margarita Tutulani - Tirane
 Mobil 0.672073098 : e-mail ersi-shpk@hotmail.com / fagoxhaj@hotmail.com

PROJEKTUES
 SHOQERIA "ERSI"

N R . 3418 / 9 LICENSE

INVESTITORI : BASHKIA PEQIN

**OBJEKTI: SHKOLLA E MESME PAJOVE
 "MUSTAFA KEMAL ATATURK"
 BASHKIA - PEQIN**

PROJEKT - ZBATIMI

**SKEME ZONIMI
 BASHKIA PEQIN**

INXHINIER KONSTRUKTOR	FATBARDHA GOXHAJ	N.R. 0265/9	SHKALLA 1:1000
INXHINIER KONSTRUKTOR	ENXHI ÇELAJ		DATA E REALIZIMIT
INXHINIER HIDROTEKNIK	ANJEZA NEBIJAJ		SHTATOR 2018
ARKITEKT	SOKOL AGAJ	A.1363/1	
ARKITEKT	IRINI GJONE		FLETA I

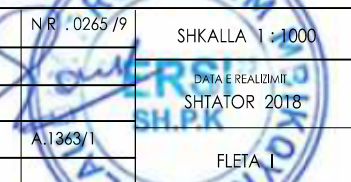

SHKOLLA "MUSTAFA KEMAL ATATURK"

	"Ersi" - shpk Adresa / Rruga Margarita Tutulani - Tirane Mobil 0.672073098 : e-mail ersi-shpk@hotmail.com / fagoxhaj@hotmail.com	INVESTITORI : BASHKIA PEQIN OBJEKTI: SHKOLLA E MESME PAJOVE "MUSTAFA KEMAL ATATURK" BASHKIA -PEQIN	PROJEKT - ZBATIMI SKEME ZONIMI BASHKIA PEQIN	INXHINIER KONSTRUKTOR FATBARDHA GOXHAJ NR .0265/9 SHKALLA 1 : 1000			
	PROJEKTUES SHOQERIA "ERSI" NR . 3418 / 9 LICENSE			INXHINIER KONSTRUKTOR ENXHI ÇELAJ		INXHINIER HIDROTEKNIK ANJEZA NEBIJ	DATA E REALIZIMIT SHTATOR 2018
				ARKITEKT SOKOL AGAJ A.1363/1		ARKITEKT IRINI GJONE	FLETA I



'Mustafa Kemal Atatürk', E Mesme E Pergjithshme (Pajove, Peqin)

SHKOLLA "MUSTAFA KEMAL ATATURK"

	"Ersi" - shpk Adresa / Rruga Margarita Tutulani - Tirane Mobil 0.672073098 : e-mail ersi-shpk@hotmail.com / fagoxhaj@hotmail.com	INVESTITORI : BASHKIA PEQIN OBJEKTI: SHKOLLA E MESME PAJOVE "MUSTAFA KEMAL ATATURK" BASHKIA -PEQIN	PROJEKT - ZBATIMI SKEME ZONIMI BASHKIA PEQIN	INXHINIER KONSTRUKTOR FATBARDHA GOXHAJ NR. 0265/9	SHKALLA 1 : 1000
	PROJEKTUES SHOQERIA "ERSI" N R . 3418 / 9 LICENSE			INXHINIER KONSTRUKTOR ENXHI ÇELAJ INXHINIER HIDROTEKNIK ANJEZA NEBIJ ARKITEKT SOKOL AGAJ ARKITEKT IRINI GJONE	A.1363/1 FLETA 1

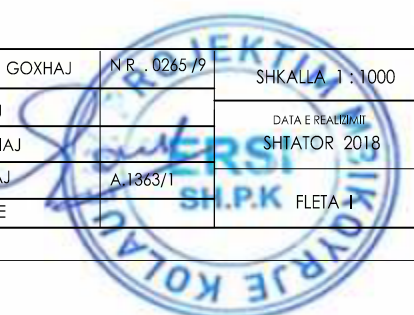

INVESTITOR : BASHKIA PEQIN
PROJEKT ZBATIMI

PLANIMETRI E OBJEKTIT



**OBJEKTI: RIKONSTRUKSION DHE NDERTIM PALESTRE I SHKOLLES SE MESME PAJOVE
 "MUSTAFA KEMAL ATATURK"**

	"Ersi" - shpk Adresa / Rruga Margarita Tutulani - Tirane Mobil 0.672073098 : e-mail ersi-shpk@hotmail.com / fagoxhaj@hotmail.com	INVESTITORI :BASHKIA PEQIN	PROJEKT - ZBATIMI	INXHINIER KONSTRUKTOR	FATBARDHA GOXHAJ	N R .0265 /9	SHKALLA 1 : 1000
	PROJEKTUES SHOQERIA " ERSI " N R . 3418 / 9 LICENSE	OBJEKTI: SHKOLLA E MESME PAJOVE "MUSTAFA KEMAL ATATURK" BASHKIA -PEQIN	SHKOLLA "MUSTAFA KEMAL ATATURK"	INXHINIER KONSTRUKTOR	ENXHI ÇELAJ		DATA E REALIZIMIT
				INXHINIER HIDROTEKNIK	ANJEZA NEBIJ		SHTATOR 2018
				ARKITEKT	SOKOL AGAJ	A.1363/1	FLETA I
			ARKITEKT	IRINI GJONE			

PLANIMETRIA E KATIT PERDHE SHKOLLA E MESME PAJOVE

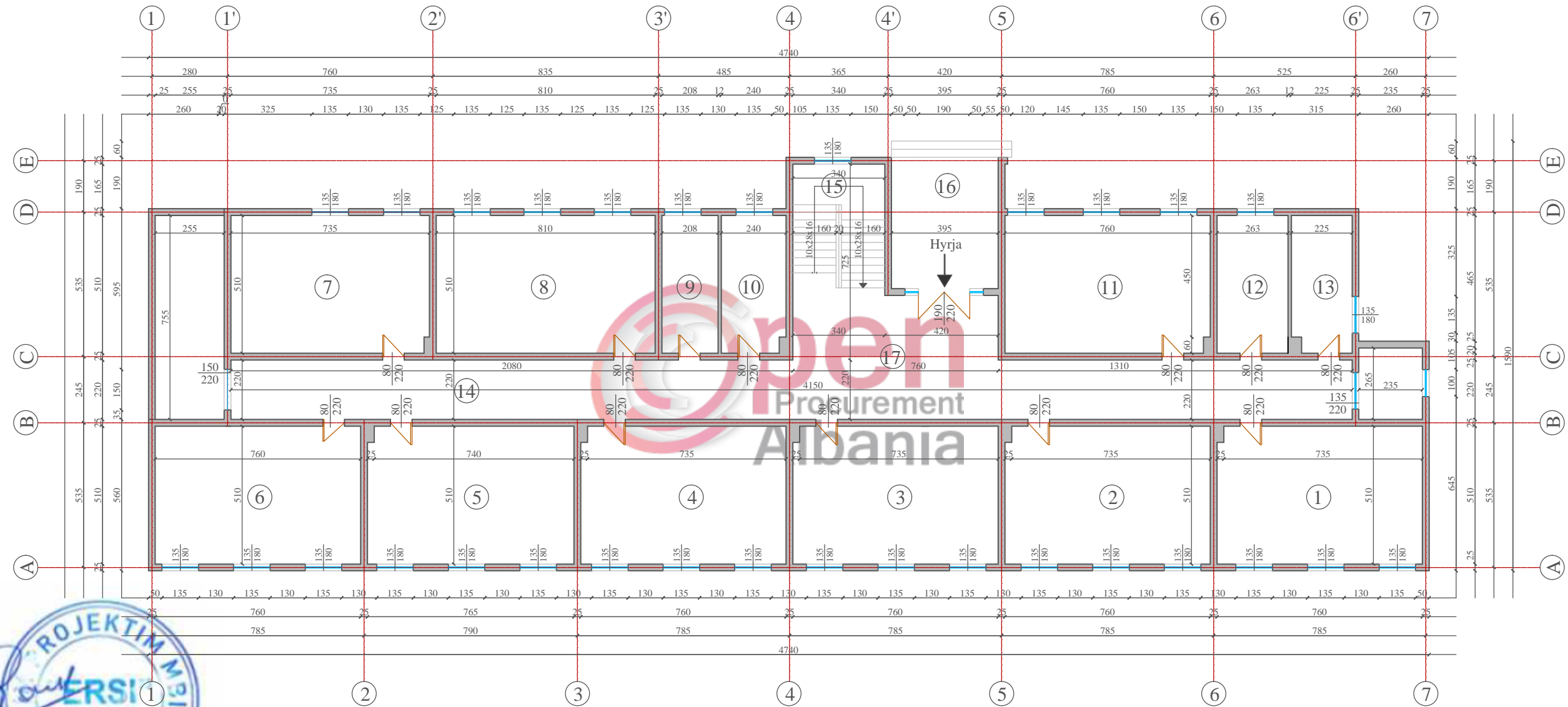

SHKOLLA "MUSTAFA KEMAL ATATURK"

	"Ersi" - shpk Adresa / Rruga Margarita Tutulani - Tirane Mobil 0.672073098 : e - mail ersi-shpk@ hotmail .com / fagoxhaj@hotmail.com	INVESTITORI :BASHKIA PEQIN	PROJEKT - ZBATIMI	INXHINIER KONSTRUKTOR FATBARDHA GOXHAJ N R .0265 /9	SHKALLA 1 : 1000
	PROJEKTUES SHOQERIA "ERSI"	OBJEKTI: SHKOLLA E MESME PAJOVE "MUSTAFA KEMAL ATATURK"	PLANIMETRIA E KATIT PERDHE	INXHINIER KONSTRUKTOR ENXHI ÇELAJ	DATA E REALIZIMIT SHTATOR 2018
	N R . 3418 / 9 LICENSE	BASHKIA -PEQIN		INXHINIER HIDROTEKNIK ANJEZA NEBJAJ	ARKITEKT SOKOL AGAJ A.1363/1
				ARKITEKT IRINI GJONE	FLETA I

**PLANIMETRIA E KATIT PERDHE
SHKOLLA E MESME PAJOVE
GJENDJA PAS RIKONSTRUKSIONIT**

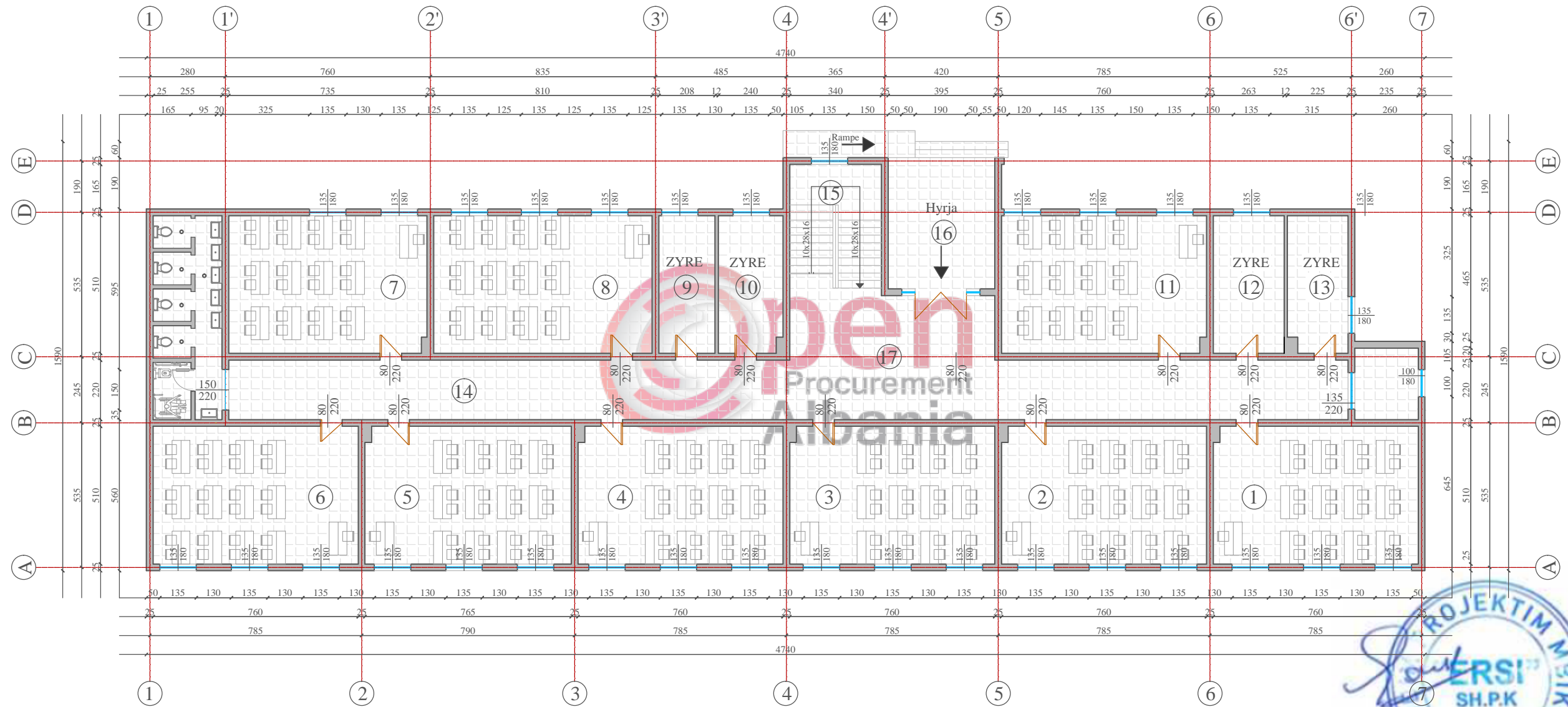

SHKOLLA "MUSTAFA KEMAL ATATURK"

	"Ersi" - shpk Adresa / Rruga Margarita Tutulani - Tirane Mobil 0.672073098 : e - mail ersi-shpk@ hotmail .com / fagohaj@hotmail.com	INVESTITORI :BASHKIA PEQIN	PROJEKT - ZBATIMI	INXHINIER KONSTRUKTOR	FATBARDHA GOXHAI	N R .0265 /9	SHKALLA 1 : 1000
	PROJEKTUES SHOQERIA "ERSI" N R . 3418 / 9 LICENSE	OBJEKTI: SHKOLLA E MESME PAJOVE "MUSTAFA KEMAL ATATURK" BASHKIA -PEQIN	PLANIMETRIA E KATIT PERDHE E RIKONSTRUKTUAR	INXHINIER KONSTRUKTOR INXHINIER HIDROTEKNIK ARKITEKT ARKITEKT	ENXHI ÇELAJ ANJEZA NEBAJ SOKOL AGAJ IRINI GJONE	A.1363/1	DATA E REALIZIMIT SHTATOR 2018 FLETA I

PLANIMETRIA E KATIT I SHKOLLA E MESME PAJOVE

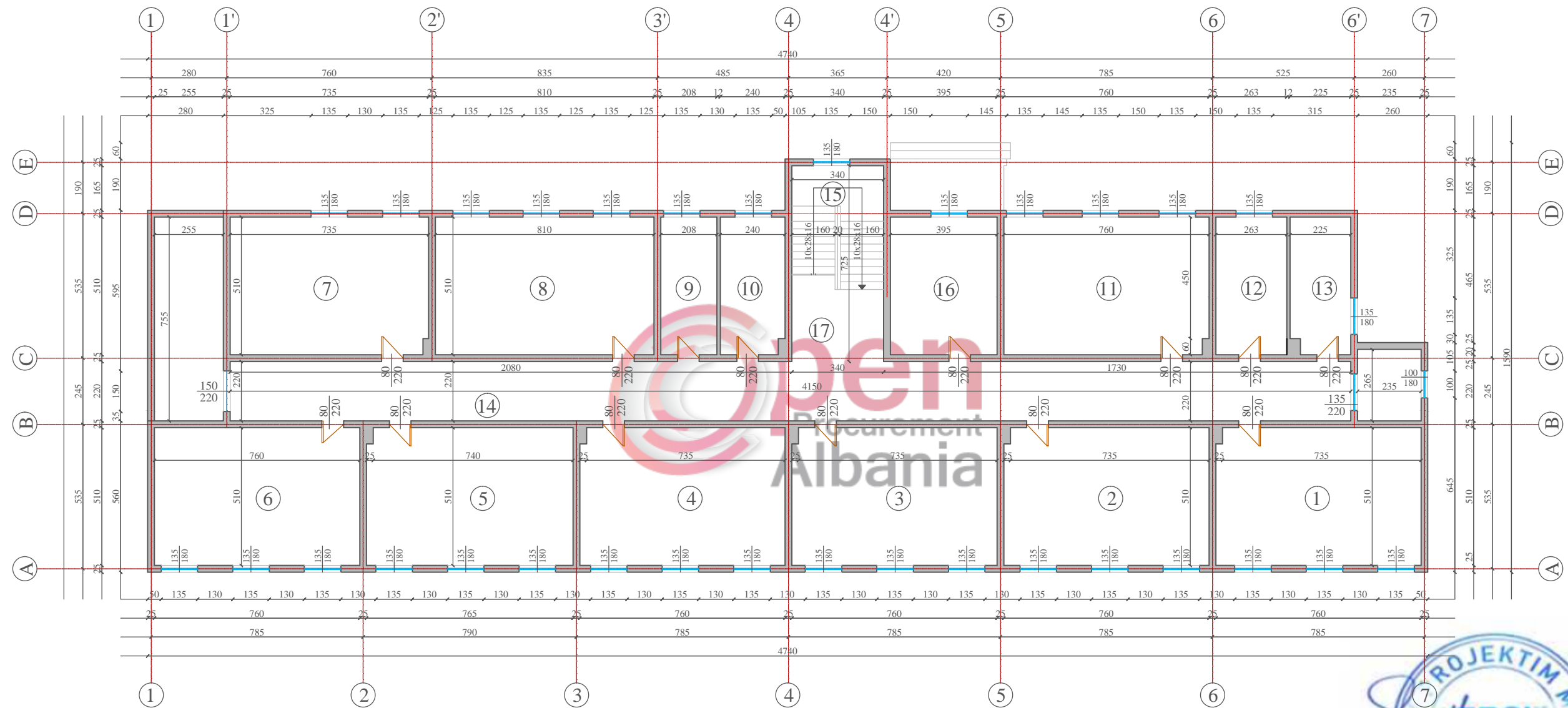

SHKOLLA "MUSTAFA KEMAL ATATURK"

 ERSI	"Ersi" - shpk Adresa / Rruga Margarita Tutulani - Tirane Mobil 0.672073098 : e - mail ersi-shpk@ hotmail .com / fagoxhaj@hotmail.com	INVESTITORI : BASHKIA PEQIN	PROJEKT - ZBATIMI	INXHINIER KONSTRUKTOR FATBARDHA GOXHAJ N R . 0265 /9 INXHINIER KONSTRUKTOR ENXHI ÇELAJ INXHINIER HIDROTEKNIK ANJEZA NEBIJAJ ARKITEKT SOKOL AGAJ A.1363/1 ARKITEKT IRINI GJONE	SHKALLA 1 : 1000 DATA E REALIZIMIT SHTATOR 2018 FLETA I
	PROJEKTUES SHOQERIA "ERSI" N R . 3418 / 9 LICENSE	OBJEKTI: SHKOLLA E MESME PAJOVE "MUSTAFA KEMAL ATATURK" BASHKIA -PEQIN	PLANIMETRIA E KATIT I		

**PLANIMETRIA E KATIT I
SHKOLLA E MESME PAJOVE
GJENDJA PAS RIKONSTRUKSIONIT**

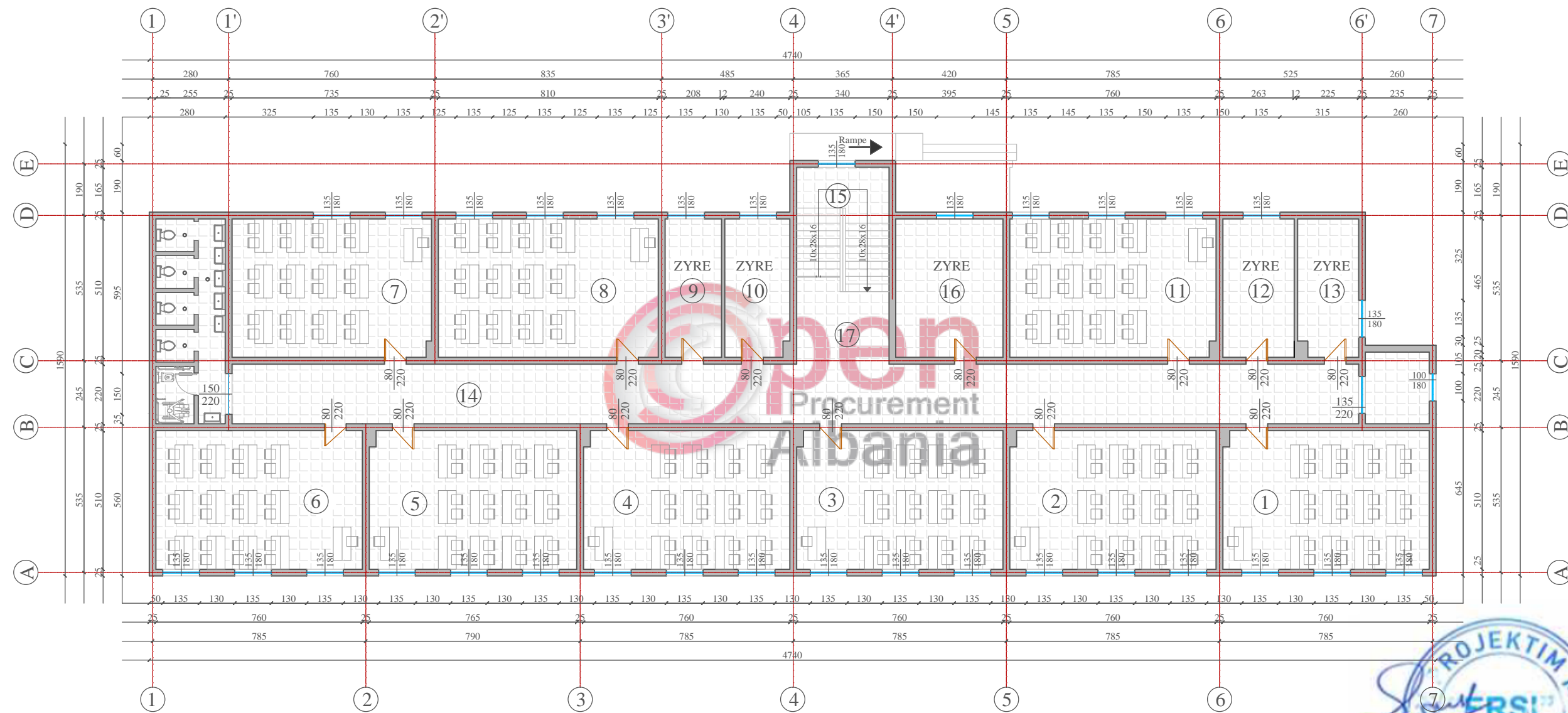

SHKOLLA "MUSTAFA KEMAL ATATURK"

"Ersi" - shpk
Adresa / Rruga Margarita Tutulani - Tirane
Mobil 0.672073098 : e-mail ersi-shpk@hotmail.com / fagohaj@hotmail.com

INVESTITORI : BASHKIA PEQIN

PROJEKT - ZBATIMI

INXHINIER KONSTRUKTOR	FATBARDHA GOXHAJ	N.R .0265 /9	SHKALLA 1 : 1000
INXHINIER KONSTRUKTOR	ENXHIL ÇELAJ		DATA E REALIZIMIT SHTATOR 2018
INXHINIER HIDROTEKNIK	ANJEZA NE SOKOL AGAJ		FLETA I
ARKITEKT		A.1363/1	
ARKITEKT	IRINI GJONE		

**OBJEKTI: SHKOLLA E MESME PAJOVE
"MUSTAFA KEMAL ATATURK"
BASHKIA PEQIN**

**PLANIMETRIA E KATIT I
E RIKONSTRUKTUAR**

**PROJEKTUES
SHOQERIA "ERSI"
N R . 3418 / 9 LICENSE**



INVESTITOR : BASHKIA PEQIN
PROJEKT ZBATIMI

PLANI ELEKTRIK



**OBJEKTI: RIKONSTRUKSION DHE NDERTIM PALESTRE I SHKOLLES SE MESME PAJOVE
 "MUSTAFA KEMAL ATATURK"**



	" Ersi " - shpk Adresa / Rruga Margarita Tutulani - Tirane Mobil 0.672073098 : e - mail ersi-shpk@ hotmail .com / fagoxhaj@hotmail.com	INVESTITORI :BASHKIA PEQIN	PROJEKT - ZBATIMI	INXHINIER KONSTRUKTOR	FATBARDHA GOXHAJ	N R . 0265 /9	SHKALLA 1 : 1000
	PROJEKTUES SHOQERIA " ERSI " N R . 3418 / 9 LICENSE	OBJEKTI: SHKOLLA E MESME PAJOVE "MUSTAFA KEMAL ATATURK" BASHKIA -PEQIN	SHKOLLA "MUSTAFA KEMAL ATATURK"	INXHINIER KONSTRUKTOR	ENXHI ÇELAJ		DATA E REALIZIMIT
				INXHINIER HIDROTEKNIK	ANJEZA NEBIJ		SHTATOR 2018
				ARKITEKT	SOKOL AGAJ	A.1363/1	FLETA I
			ARKITEKT	IRINI GJONE			

PLANI ELEKTRIK I KATIT PERDHE SHKOLLA E MESME PAJOVE

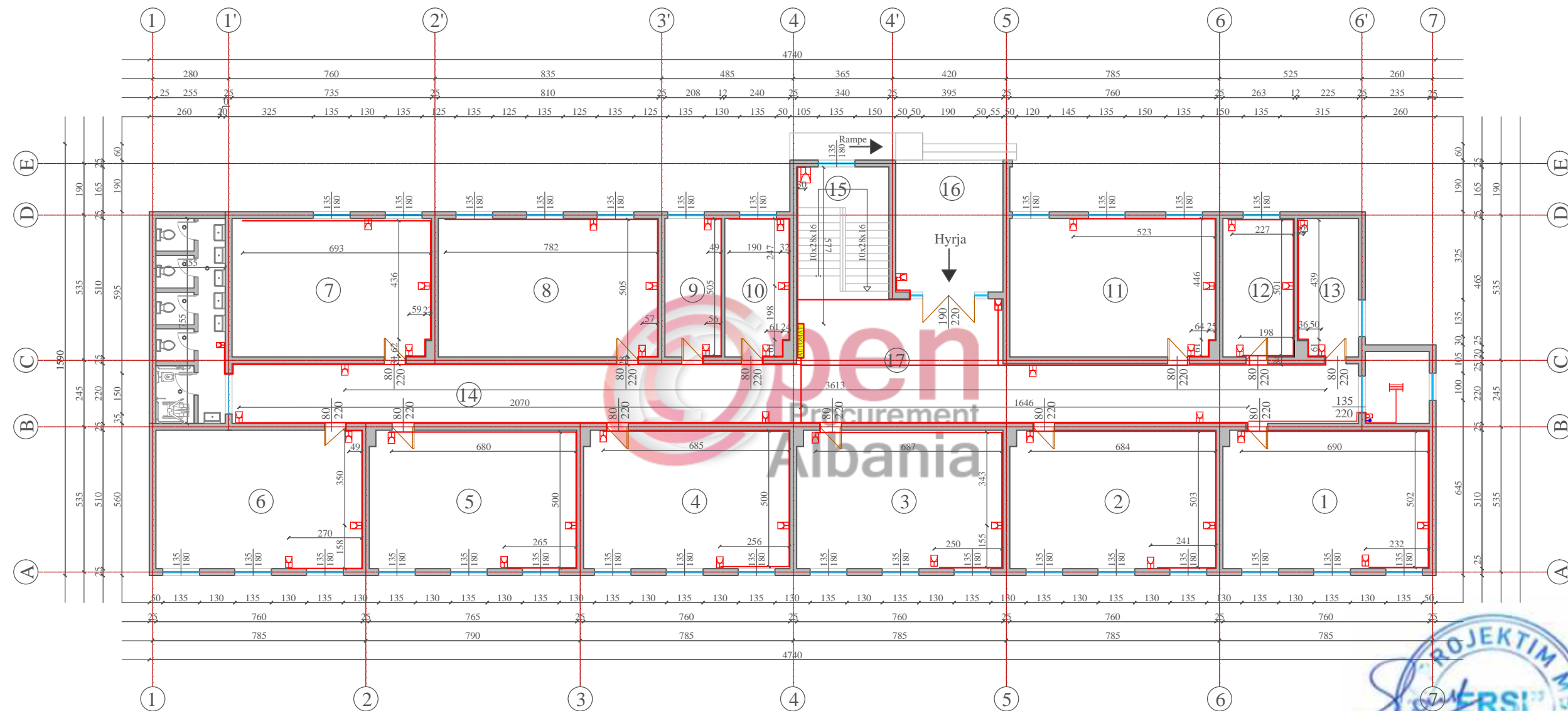

SHKOLLA "MUSTAFA KEMAL ATATURK"

	"Ersi" - shpk Adresa / Rruga Margarita Tutulani - Tirane Mobil 0.672073098 : e - mail ersi-shpk@ hotmail .com / fagoxhaj@hotmail.com	INVESTITORI :BASHKIA PEQIN	PROJEKT - ZBATIMI	INXHINIER KONSTRUKTOR FATBARDHA GOXHAJ N R .0265 /9 INXHINIER KONSTRUKTOR ENXHI ÇELAJ INXHINIER HIDROTEKNIK ANJEZA NEBIJ ARKITEKT SOKOL AGAJ ARKITEKT IRINI GJONE	SHKALLA 1 : 1000 DATA E REALIZIMIT SHTATOR 2018 FLETA I
	PROJEKTUES SHOQERIA "ERSI"	OBJEKTI: SHKOLLA E MESME PAJOVE "MUSTAFA KEMAL ATATURK"	PLANI ELEKTRIK		
	N R . 3418 / 9 LICENSE	BASHKIA -PEQIN	KATIT PERDHE		

PLANI ELEKTRIK I KATIT I SHKOLLA E MESME PAJOVE

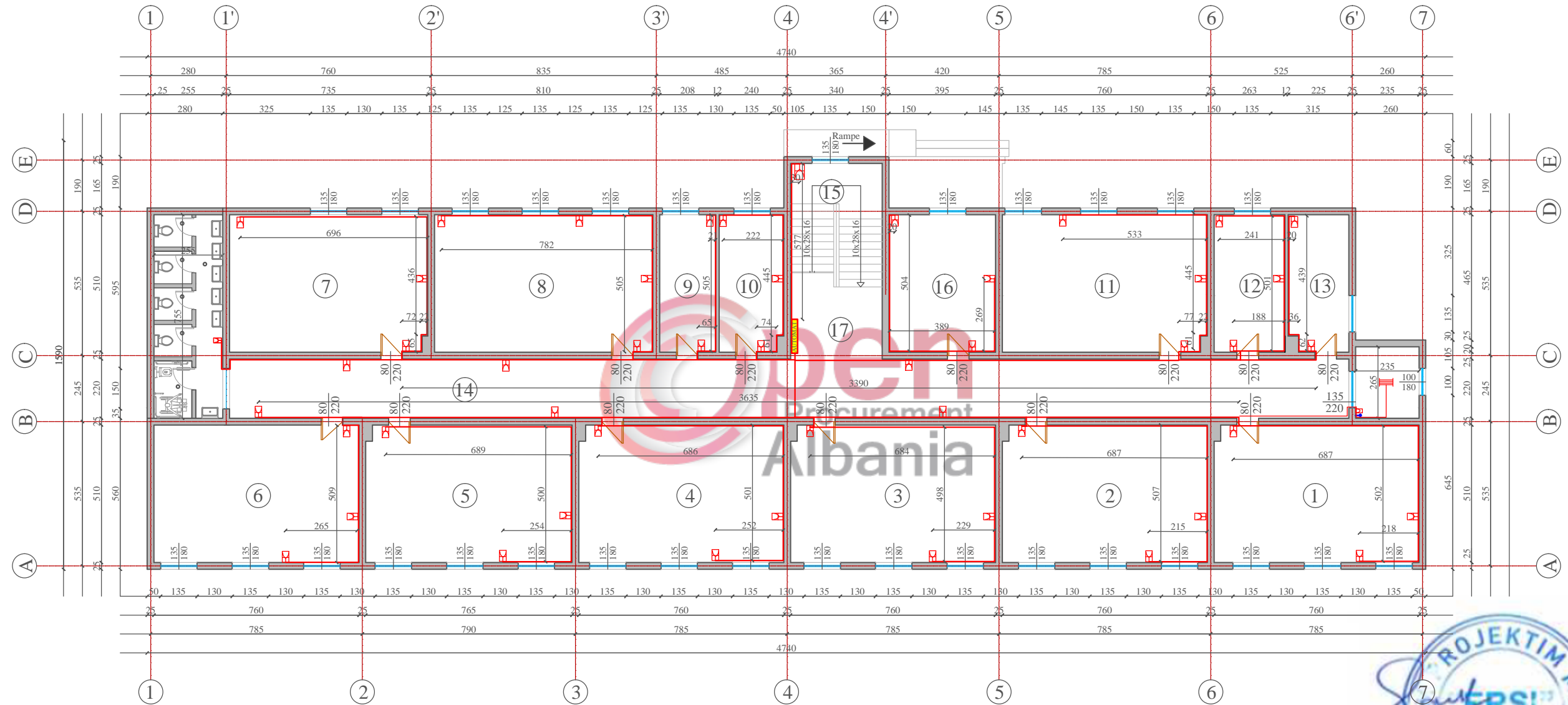

SHKOLLA "MUSTAFA KEMAL ATATURK"

	"Ersi" - shpk Adresa / Rruga Margarita Tutulani - Tirane Mobil 0.672073098 : e - mail ersi-shpk@ hotmail .com / fagoxhaj@hotmail.com	INVESTITORI :BASHKIA PEQIN	PROJEKT - ZBATIMI	INXHINIER KONSTRUKTOR FATBARDHA GOXHAJ N R .0265 /9 INXHINIER KONSTRUKTOR ENXHI ÇELAJ INXHINIER HIDROTEKNIK ANJEZA NEBIAJ ARKITEKT SOKOL AGAJ ARKITEKT IRINI GJONE	SHKALLA 1 : 1000 DATA E REALIZIMIT SHTATOR 2018 FLETA I
	PROJEKTUES SHOQERIA "ERSI" N R . 3418 / 9 LICENSE	OBJEKTI: SHKOLLA E MESME PAJOVE "MUSTAFA KEMAL ATATURK" BASHKIA -PEQIN	BASHKIA -PEQIN		

PLANI NDRICIMIT I KATIT PERDHE SHKOLLA E MESME PAJOVE

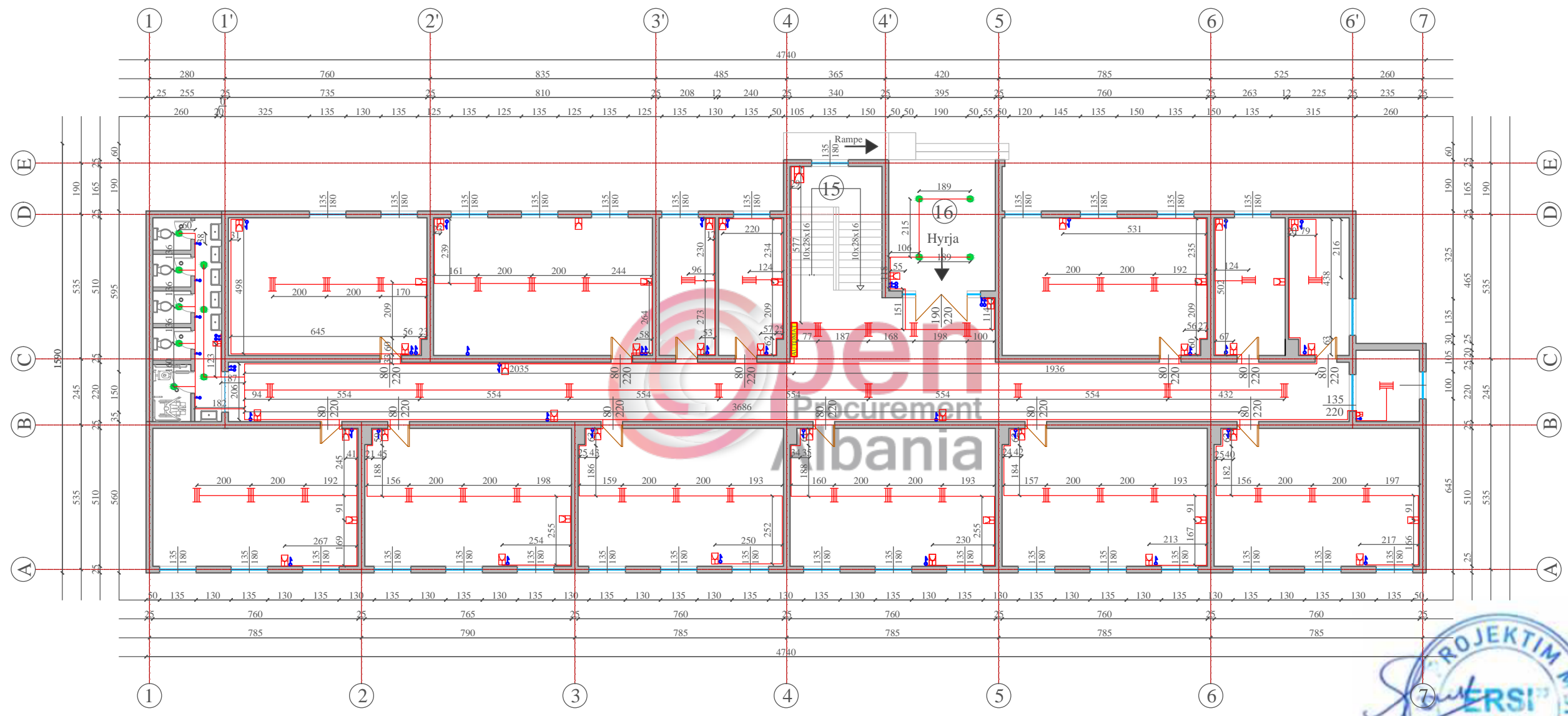

SHKOLLA "MUSTAFA KEMAL ATATURK"

	"Ersi" - shpk Adresa / Rruga Margarita Tutulani - Tirane Mobil 0.672073098 : e-mail ersi-shpk@hotmail.com / fagoxhaj@hotmail.com	INVESTITORI :BASHKIA PEQIN	PROJEKT - ZBATIMI	INXHINIER KONSTRUKTOR FATBARDHA GOXHAJ N R .0265 /9	SHKALLA 1 : 1000
	PROJEKTUES SHOQERIA "ERSI"	OBJEKTI: SHKOLLA E MESME PAJOVE "MUSTAFA KEMAL ATATURK"	PLANI NDRICIMIT KATIT PERDHE	INXHINIER KONSTRUKTOR ENXHI ÇELAJ INXHINIER HIDROTEKNIK ANJEZA NEBAJ	DATA E REALIZIMIT SHTATOR 2018
	N R . 3418 / 9 LICENSE	BASHKIA -PEQIN		ARKITEKT SOKOL AGAJ ARKITEKT IRINI GJONE	A.1363/1
					FLETA I

PLANI NDRICIMIT I KATIT I SHKOLLA E MESME PAJOVE

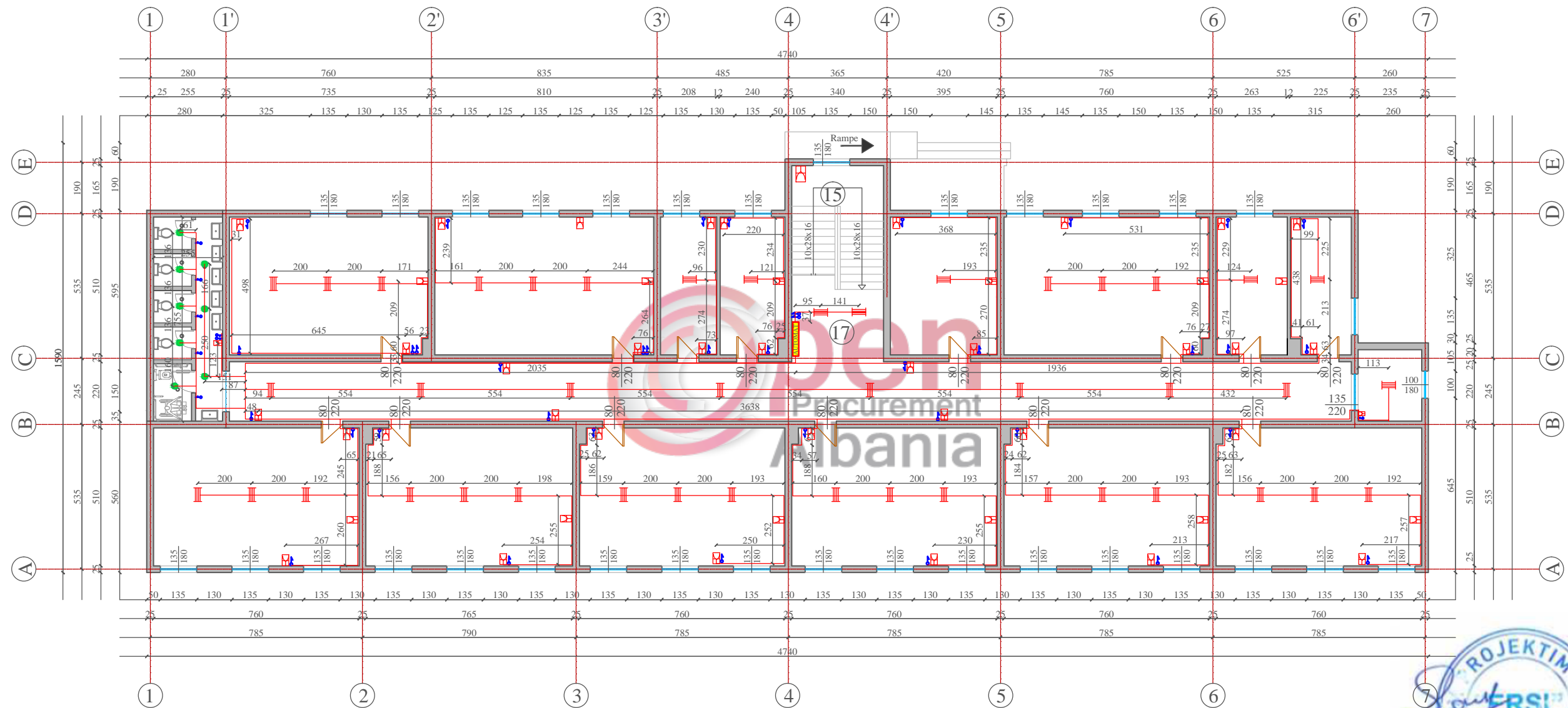

SHKOLLA "MUSTAFA KEMAL ATATURK"

	"Ersi" - shpk Adresa / Rruga Margarita Tutulani - Tirane Mobil 0.672073098 : e - mail ersi-shpk@ hotmail .com / fagoxhaj@hotmail.com	INVESTITORI :BASHKIA PEQIN	PROJEKT - ZBATIMI	INXHINIER KONSTRUKTOR FATBARDHA GOXHAJ N R .0265 /9	SHKALLA 1 : 1000
	PROJEKTUES SHOQERIA "ERSI"	OBJEKTI: SHKOLLA E MESME PAJOVE "MUSTAFA KEMAL ATATURK"	PLANI NDRICIMIT KATI I	INXHINIER KONSTRUKTOR ENXHI ÇELAJ INXHINIER HIDROTEKNIK ANJEZA NEBIJ	DATA E REALIZIMIT SHTATOR 2018
	N R . 3418 / 9 LICENSE	BASHKIA -PEQIN		ARKITEKT SOKOL AGAJ A.1363/1 ARKITEKT IRINI GJONE	FLETA I

INVESTITOR : BASHKIA PEQIN
PROJEKT ZBATIMI

PROJEKT HIDROSANITAR DHE KUZ



**OBJEKTI: RIKONSTRUKSION DHE NDERTIM PALESTRE I SHKOLLES SE MESME PAJOVE
 "MUSTAFA KEMAL ATATURK"**



	" Ersi " - shpk Adresa / Rruga Margarita Tutulani - Tirane Mobil 0.672073098 : e - mail ersi-shpk@ hotmail .com / fagoxhaj@hotmail.com	INVESTITORI :BASHKIA PEQIN	PROJEKT - ZBATIMI	INXHINIER KONSTRUKTOR	FATBARDHA GOXHAJ	N R . 0265 /9	SHKALLA 1 : 1000
	PROJEKTUES SHOQERIA " ERSI "	OBJEKTI: SHKOLLA E MESME PAJOVE "MUSTAFA KEMAL ATATURK" BASHKIA -PEQIN	SHKOLLA "MUSTAFA KEMAL ATATURK"	INXHINIER KONSTRUKTOR INXHINIER HIDROTEKNIK ARKITEKT ARKITEKT	ENXHI ÇELAJ ANJEZA NEBIJ SOKOL AGAJ IRINI GJONE	A.1363/1	DATA E REALIZIMIT SHTATOR 2018 FLETA I
N R . 3418 / 9 LICENSE							

PLANIMETRIA E KATIT PERDHE KUZ SHKOLLA E MESME PAJOVE

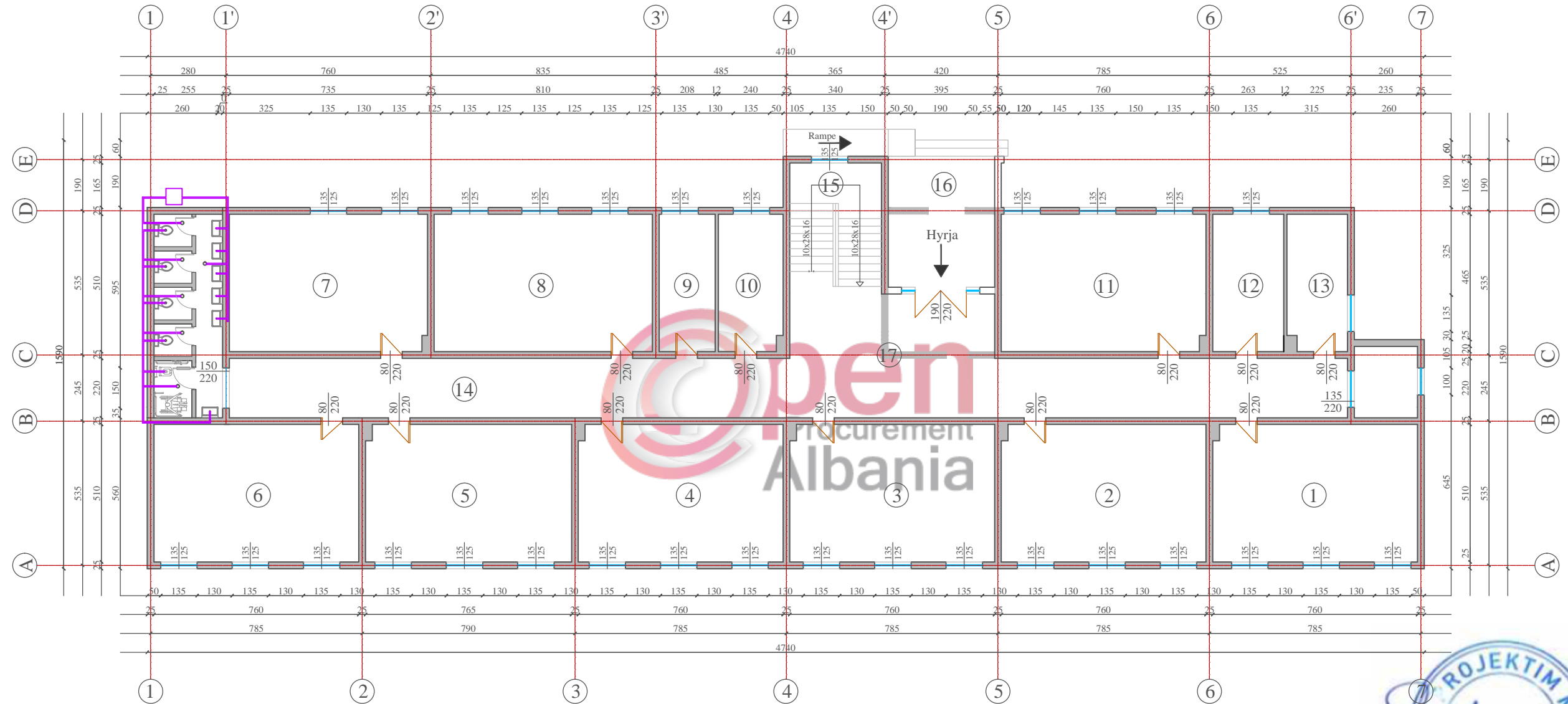

SHKOLLA "MUSTAFA KEMAL ATATURK"

	"Ersi" - shpk Adresa / Rruga Margarita Tutulani - Tirane Mobil 0.672073098 : e - mail ersi-shpk@ hotmail .com / fagoxhaj@hotmail.com	INVESTITORI : BASHKIA PEQIN	PROJEKT - ZBATIMI	INXHINIER KONSTRUKTOR FATBARDHA GOXHAJ N R . 0265 /9 INXHINIER KONSTRUKTOR ENXHI ÇELAJ INXHINIER HIDROTEKNIK ANJEZA NEBIJ ARKITEKT SOKOL AGAJ A.1363/1 ARKITEKT IRINI GJONE	SHKALLA 1 : 1000 DATA E REALIZIMIT SHTATOR 2018 FLETA I
	PROJEKTUES SHOQERIA "ERSI"	OBJEKTI: SHKOLLA E MESME PAJOVE "MUSTAFA KEMAL ATATURK" BASHKIA -PEQIN	PLANI KUZ KATIT PERDHE		
	N R . 3418 / 9 LICENSE				

PLANIMETRIA E KATIT I KUZ SHKOLLA E MESME PAJOVE

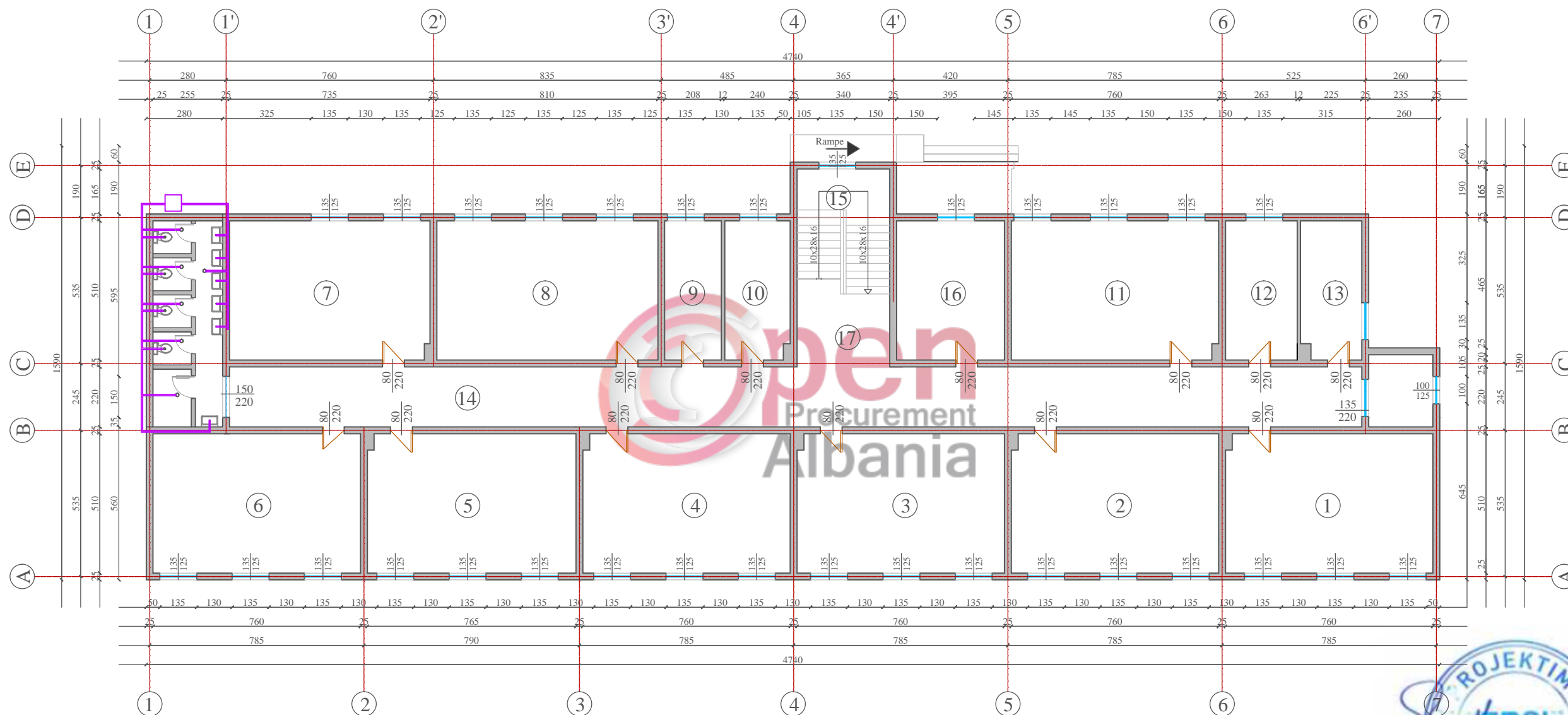

SHKOLLA "MUSTAFA KEMAL ATATURK"

 ERSI	"Ersi" - shpk Adresa / Rruga Margarita Tutulani - Tirane Mobil 0.672073098 : e-mail ersi-shpk@hotmail.com / fagoxhaj@hotmail.com	INVESTITORI :BASHKIA PEQIN	PROJEKT - ZBATIMI	INXHINIER KONSTRUKTOR FATBARDHA GOXHAJ N.R .0265 /9 INXHINIER KONSTRUKTOR ENXHI ÇELAJ INXHINIER HIDROTEKNIK ANJEZA NEBIJ ARKITEKT SOKOL AGAJ A.1363/1 ARKITEKT IRINI GJONE	SHKALLA 1 : 1000 DATA E REALIZIMIT SHTATOR 2018 FLETA I
	PROJEKTUES SHOQERIA "ERSI" N R . 3418 / 9 LICENSE	OBJEKTI: SHKOLLA E MESME PAJOVE "MUSTAFA KEMAL ATATURK" BASHKIA -PEQIN	PLANI KUZ KATI I		

INVESTITOR : BASHKIA PEQIN
PROJEKT ZBATIMI

PLANI I UJESJELLESIT



**OBJEKTI: RIKONSTRUKSION DHE NDERTIM PALESTRE I SHKOLLES SE MESME PAJOVE
 "MUSTAFA KEMAL ATATURK"**



	" Ersi " - shpk Adresa / Rruga Margarita Tutulani - Tirane Mobil 0.672073098 : e - mail ersi-shpk@ hotmail .com / fagoxhaj@hotmail.com	INVESTITORI :BASHKIA PEQIN	PROJEKT - ZBATIMI	INXHINIER KONSTRUKTOR	FATBARDHA GOXHAJ	N R . 0265 /9	SHKALLA 1 : 1000
	PROJEKTUES SHOQERIA " ERSI "	OBJEKTI: SHKOLLA E MESME PAJOVE "MUSTAFA KEMAL ATATURK" BASHKIA -PEQIN	SHKOLLA "MUSTAFA KEMAL ATATURK"	INXHINIER KONSTRUKTOR INXHINIER HIDROTEKNIK ARKITEKT ARKITEKT	ENXHI ÇELAJ ANJEZA NEBIJ SOKOL AGAJ IRINI GJONE	A.1363/1	DATA E REALIZIMIT SHTATOR 2018 FLETA I
	N R . 3418 / 9 LICENSE						

PLANIMETRIA E KATIT PERDHE E UJESJELLESIT
SHKOLLA E MESME PAJOVE

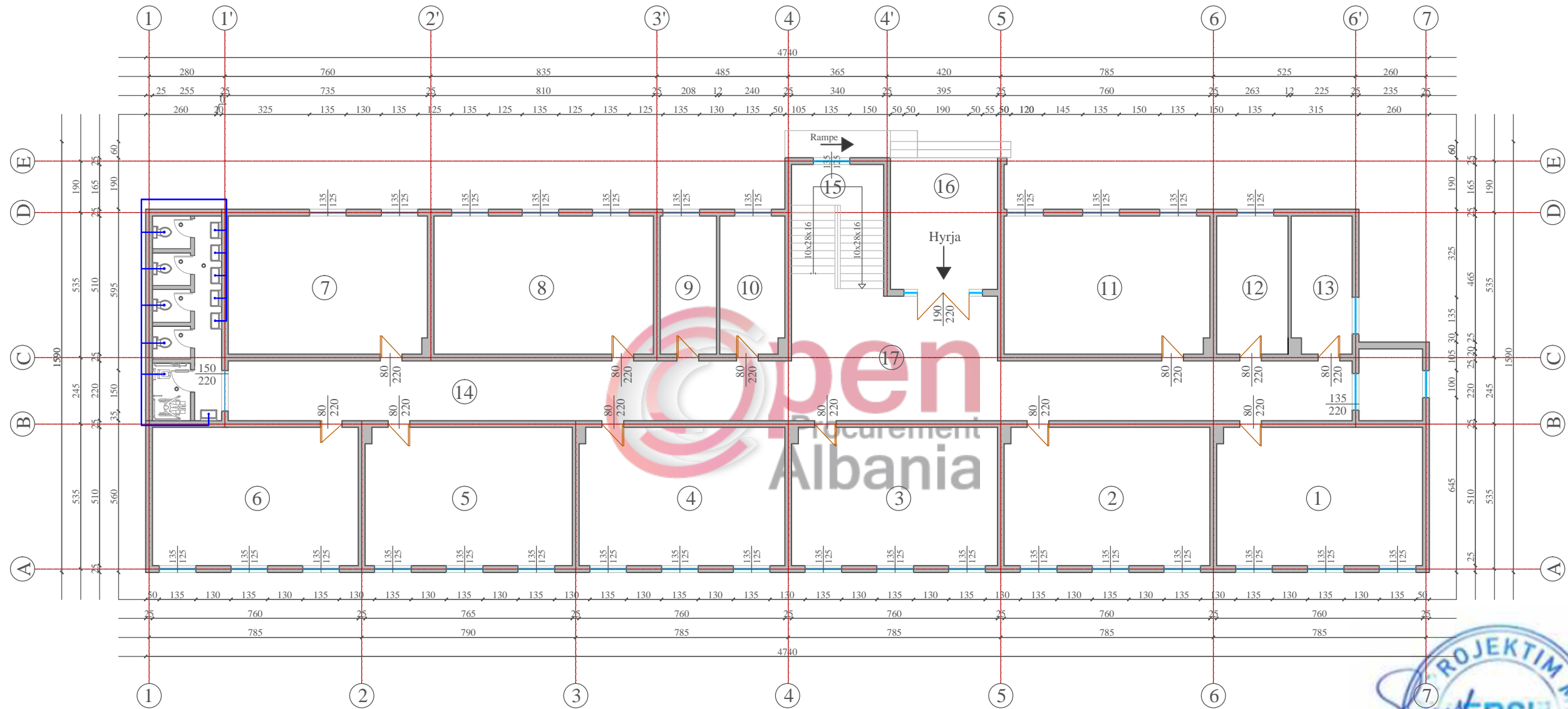

SHKOLLA "MUSTAFA KEMAL ATATURK"

	"Ersi" - shpk Adresa / Rruga Margarita Tutulani - Tirane Mobil 0.672073098 : e - mail ersi-shpk@ hotmail .com / fagoxhaj@hotmail.com	INVESTITORI :BASHKIA PEQIN OBJEKTI: SHKOLLA E MESME PAJOVE "MUSTAFA KEMAL ATATURK" BASHKIA -PEQIN	PROJEKT - ZBATIMI PLANI I UJESJELLESIT KATI PERDHE	INXHINIER KONSTRUKTOR FATBARDHA GOXHAJ N R .0265 /9	SHKALLA 1 : 1000 DATA E REALIZIMIT SHTATOR 2018 FLETA I
	PROJEKTUES SHOQERIA "ERSI" N R . 3418 / 9 LICENSE			INXHINIER KONSTRUKTOR ENXHI ÇELAJ	
				INXHINIER HIDROTEKNIK ANJEZA NEBAJ	
				ARKITEKT SOKOL AGAJ A.1363/1 ARKITEKT IRINI GJONE	

PLANIMETRIA E KATIT I E UJESJELLESIT
SHKOLLA E MESME PAJOVE

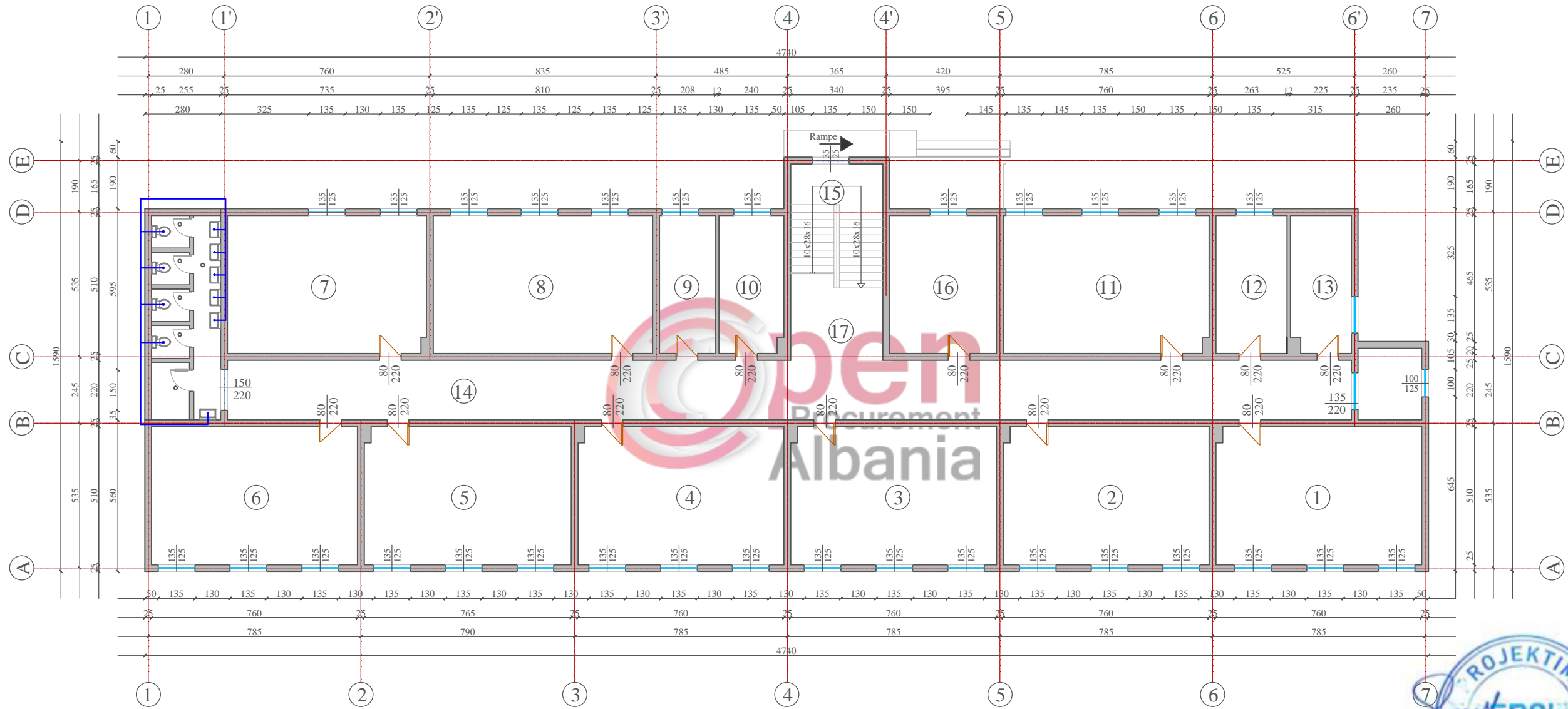

SHKOLLA "MUSTAFA KEMAL ATATURK"

	"Ersi" - shpk Adresa / Rruga Margarita Tutulani - Tirane Mobil 0.672073098 : e - mail ersi-shpk@ hotmail .com / fagoxhaj@hotmail.com	INVESTITORI :BASHKIA PEQIN OBJEKTI: SHKOLLA E MESME PAJOVE "MUSTAFA KEMAL ATATURK" BASHKIA -PEQIN	PROJEKT - ZBATIMI PLANI I UJESJELLESIT KATI I		INXHINIER KONSTRUKTOR FATBARDHA GOXHAJ N R .0265 /9	SHKALLA 1 : 1000 DATA E REALIZIMIT SHTATOR 2018 FLETA I
	PROJEKTUES SHOQERIA "ERSI" N R . 3418 / 9 LICENSE				INXHINIER KONSTRUKTOR ENXHI ÇELAJ	
					INXHINIER HIDROTEKNIK ANJEZA NEBIAJ	
					ARKITEKT SOKOL AGAJ A.1363/1 ARKITEKT IRINI GJONE	

INVESTITOR : BASHKIA PEQIN
PROJEKT ZBATIMI

PLANI I LINJES TELEFONI+ INTERNET



**OBJEKTI: RIKONSTRUKSION DHE NDERTIM PALESTRE I SHKOLLES SE MESME PAJOVE
 "MUSTAFA KEMAL ATATURK"**



	" Ersi " - shpk Adresa / Rruga Margarita Tutulani - Tirane Mobil 0.672073098 : e - mail ersi-shpk@ hotmail .com / fagoxhaj@hotmail.com	INVESTITORI :BASHKIA PEQIN	PROJEKT - ZBATIMI	INXHINIER KONSTRUKTOR	FATBARDHA GOXHAJ	N R . 0265 /9	SHKALLA 1 : 1000
	PROJEKTUES SHOQERIA " ERSI "	OBJEKTI: SHKOLLA E MESME PAJOVE "MUSTAFA KEMAL ATATURK" BASHKIA -PEQIN	SHKOLLA "MUSTAFA KEMAL ATATURK"	INXHINIER KONSTRUKTOR	ENXHI ÇELAJ		
N R . 3418 / 9 LICENSE				INXHINIER HIDROTEKNIK	ANJEZA NEBIJ		
				ARKITEKT	SOKOL AGAJ	A.1363/1	FLETA I
				ARKITEKT	IRINI GJONE		

PLANIMETRIA E KATIT PERDHE E LINJES SE TELEFONIT+ INTERNET SHKOLLA E MESME PAJOVE

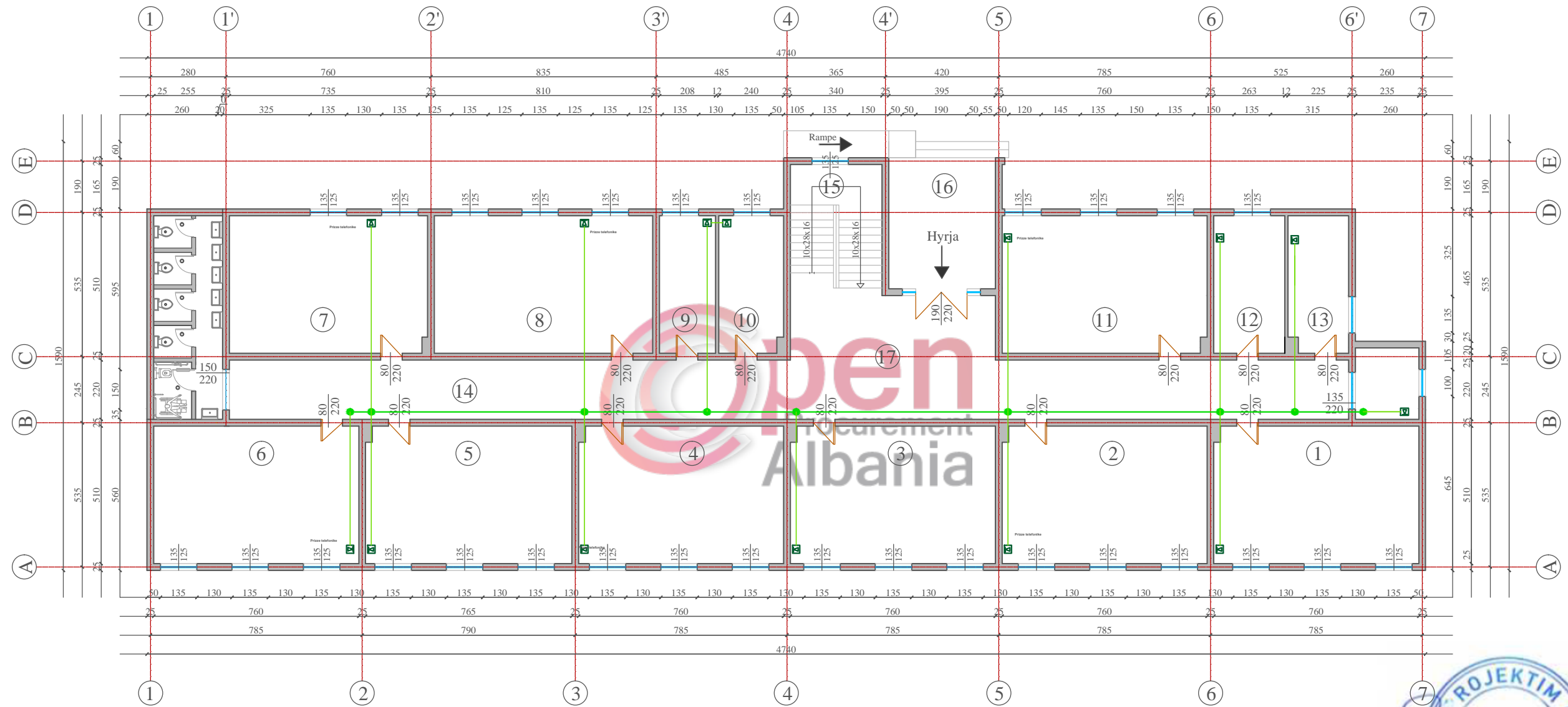

SHKOLLA "MUSTAFA KEMAL ATATURK"

	"Ersi" - shpk Adresa / Rruga Margarita Tutulani - Tirane Mobil 0.672073098 : e - mail ersi-shpk@ hotmail .com / fagoxhaj@hotmail.com	INVESTITORI :BASHKIA PEQIN	PROJEKT - ZBATIMI	INXHINIER KONSTRUKTOR FATBARDHA GOXHAJ N R .0265 /9 INXHINIER KONSTRUKTOR ENXHI ÇELAJ INXHINIER HIDROTEKNIK ANJEZA NEBIAJ ARKITEKT SOKOL AGAJ ARKITEKT IRINI GJONE	SHKALLA 1 : 1000 DATA E REALIZIMIT SHTATOR 2018 FLETA I
	PROJEKTUES SHOQERIA "ERSI"	OBJEKTI: SHKOLLA E MESME PAJOVE "MUSTAFA KEMAL ATATURK"	PLANI I LINJES TELEFONI-INTERNET		
	N R . 3418 / 9 LICENSE	BASHKIA -PEQIN	KATI PERDHE		

PLANIMETRIA E KATIT TE PARE LINJES SE TELEFONIT+ INTERNET SHKOLLA E MESME PAJOVE

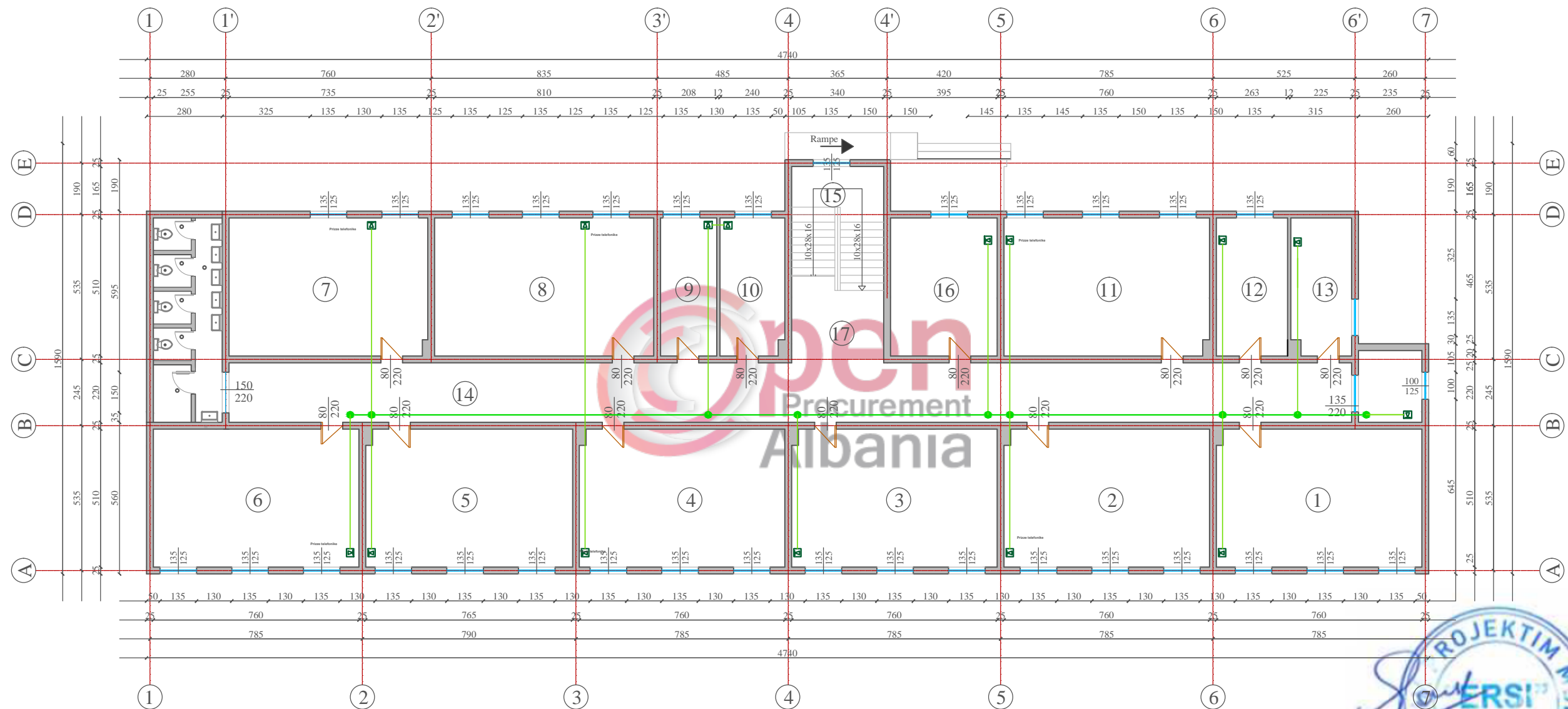

SHKOLLA "MUSTAFA KEMAL ATATURK"

	"Ersi" - shpk Adresa / Rruga Margarita Tutulani - Tirane Mobil 0.672073098 : e - mail ersi-shpk@ hotmail .com / fagohaj@hotmail.com	INVESTITORI :BASHKIA PEQIN	PROJEKT - ZBATIMI	INXHINIER KONSTRUKTOR FATBARDHA GOXHAJ N R .0265 /9 INXHINIER KONSTRUKTOR ENXHI ÇELAJ INXHINIER HIDROTEKNIK ANJEZA NEBIJAJ ARKITEKT SOKOL AGAJ ARKITEKT IRINI GJONE	SHKALLA 1 : 1000 DATA E REALIZIMIT SHTATOR 2018 FLETA I
	PROJEKTUES SHOQERIA "ERSI" N R . 3418 / 9 LICENSE	OBJEKTI: SHKOLLA E MESME PAJOVE "MUSTAFA KEMAL ATATURK" BASHKIA -PEQIN	PLANI I LINJES TELEFONI-INTERNET KATI I		

INVESTITOR : BASHKIA PEQIN
PROJEKT ZBATIMI



**OBJEKTI: RIKONSTRUKSION DHE NDERTIM PALESTRE I SHKOLLES SE MESME PAJOVE
 "MUSTAFA KEMAL ATATURK"**



	" Ersi " - shpk Adresa / Rruga Margarita Tutulani - Tirane Mobil 0.672073098 : e - mail ersi-shpk@ hotmail .com / fagoxhaj@hotmail.com	INVESTITORI :BASHKIA PEQIN	PROJEKT - ZBATIMI	INXHINIER KONSTRUKTOR	FATBARDHA GOXHAJ	N R .0265 /9	SHKALLA 1 : 1000
	PROJEKTUES SHOQERIA " ERSI "	OBJEKTI: SHKOLLA E MESME PAJOVE "MUSTAFA KEMAL ATATURK" BASHKIA -PEQIN	SHKOLLA "MUSTAFA KEMAL ATATURK"	INXHINIER KONSTRUKTOR INXHINIER HIDROTEKNIK ARKITEKT ARKITEKT	ENXHI ÇELAJ ANJEZA NEBIJ SOKOL AGAJ IRINI GJONE	A.1363/1	DATA E REALIZIMIT SHTATOR 2018 FLETA I
N R . 3418 / 9 LICENSE							



SHKOLLA "MUSTAFA KEMAL ATATURK"



	" Ersi " - shpk Adresa / Rruga Margarita Tutulani - Tirane Mobil 0.672073098 : e - mail ersi-shpk@ hotmail .com / fagoxhaj@hotmail.com	INVESTITORI :BASHKIA PEQIN OBJEKTI: SHKOLLA E MESME PAJOVE "MUSTAFA KEMAL ATATURK" BASHKIA -PEQIN	PROJEKT - ZBATIMI PAMJE 3D	INXHINIER KONSTRUKTOR FATBARDHA GOXHAJ N.R. 0265 /9	SHKALLA 1 : 1000 DATA E REALIZIMIT SHTATOR 2018
	PROJEKTUES SHOQERIA "ERSI" N R . 3418 / 9 LICENSE			INXHINIER KONSTRUKTOR ENXHI ÇELAJ INXHINIER HIDROTEKNIK ANJEZA NEBIJ ARKITEKT SOKOL AGAJ A.1363/1 ARKITEKT IRINI GJONE	



SHKOLLA "MUSTAFA KEMAL ATATURK"



	"Ersi" - shpk Adresa / Rruga Margarita Tutulani - Tirane Mobil 0.672073098 : e - mail ersi-shpk@ hotmail .com / fagoxhaj@hotmail.com	INVESTITORI :BASHKIA PEQIN OBJEKTI: SHKOLLA E MESME PAJOVE "MUSTAFA KEMAL ATATURK" BASHKIA -PEQIN	PROJEKT - ZBATIMI PAMJE 3D	INXHINIER KONSTRUKTOR FATBARDHA GOXHAJ N.R. .0265 /9	SHKALLA 1 : 1000 DATA E PRAKTIKUMI SHTATOR 2018
	PROJEKTUES SHOQERIA "ERSI" N R . 3418 / 9 LICENSE			INXHINIER KONSTRUKTOR ENXHI ÇELAJ INXHINIER HIDROTEKNIK ANJEZA NEBIJ ARKITEKT SOKOL AGAJ A.1363/1 ARKITEKT IRINI GJONE	



SHKOLLA "MUSTAFA KEMAL ATATURK"



	"Ersi" - shpk Adresa / Rruga Margarita Tutulani - Tirane Mobil 0.672073098 : e-mail ersi-shpk@hotmail.com / fagoxhaj@hotmail.com	INVESTITORI :BASHKIA PEQIN OBJEKTI: SHKOLLA E MESME PAJOVE "MUSTAFA KEMAL ATATURK" BASHKIA -PEQIN	PROJEKT - ZBATIMI PAMJE 3D	INXHINIER KONSTRUKTOR FATBARDHA GOXHAJ NR . 0265 /9	SHKALLA 1 : 1000 DATA E REALIZIMIT SHTATOR -2018
	PROJEKTUES SHOQERIA "ERSI" N R . 3418 / 9 LICENSE			INXHINIER KONSTRUKTOR ENXHI ÇELAJ INXHINIER HIDROTEKNIK ANJEZA NEBIJ ARKITEKT SOKOL AGAJ A.1363/1 ARKITEKT IRINI GJONE	



SHKOLLA "MUSTAFA KEMAL ATATURK"



"Ersi" - shpk
 Adresa / Rruga Margarita Tutulani - Tirane
 Mobil 0.672073098 : e-mail ersi-shpk@hotmail.com / fagoxhaj@hotmail.com

PROJEKTUES
 SHOQERIA "ERSI"

N R . 3418 / 9 LICENSE

INVESTITORI :BASHKIA PEQIN

**OBJEKTI: SHKOLLA E MESME PAJOVE
 "MUSTAFA KEMAL ATATURK"
 BASHKIA -PEQIN**

PROJEKT - ZBATIMI

PAMJE 3D

INXHINIER KONSTRUKTOR	FATBARDHA GOXHAJ	N R . 0285 / 9	SHKALLA 1 : 1000
INXHINIER KONSTRUKTOR	ENXHI ÇELAJ		DATA E REALIZIMIT
INXHINIER HIDROTEKNIK	ANJEZA NEBIJ		SHTATOR - 2018
ARKITEKT	SOKOL AGAJ	A.1363/1	
ARKITEKT	IRINI GJONE		FLETA I



SHKOLLA "MUSTAFA KEMAL ATATURK"



	"Ersi" - shpk Adresa / Rruga Margarita Tutulani - Tirane Mobil 0.672073098 : e - mail ersi-shpk@ hotmail .com / fagoxhaj@hotmail.com	INVESTITORI :BASHKIA PEQIN OBJEKTI: SHKOLLA E MESME PAJOVE "MUSTAFA KEMAL ATATURK" BASHKIA -PEQIN	PROJEKT - ZBATIMI PAMJE 3D	INXHINIER KONSTRUKTOR FATBARDHA GOXHAJ N.R. .0265 /9	SHKALLA 1 : 1000 DATA E REALIZIMIT SHTATOR - 2018
	PROJEKTUES SHOQERIA "ERSI" N R . 3418 / 9 LICENSE			INXHINIER KONSTRUKTOR ENXHI ÇELAJ INXHINIER HIDROTEKNIK ANJEZA NEBIJ ARKITEKT SOKOL AGAJ A.1368/1 ARKITEKT IRINI GJONE	



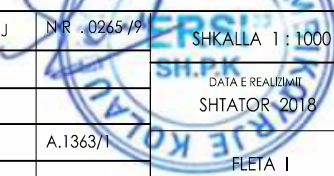

SHKOLLA "MUSTAFA KEMAL ATATURK"

	"Ersi" - shpk Adresa / Rruga Margarita Tutulani - Tirane Mobil 0.672073098 : e-mail ersi-shpk@hotmail.com / fagoxhaj@hotmail.com	INVESTITORI :BASHKIA PEQIN OBJEKTI: SHKOLLA E MESME PAJOVE "MUSTAFA KEMAL ATATURK" BASHKIA -PEQIN	PROJEKT - ZBATIMI PAMJE 3D	INXHINIER KONSTRUKTOR FATBARDHA GOXHAJ NR .0265/9/	
	PROJEKTUES SHOQERIA "ERSI" N R . 3418 / 9 LICENSE			SHKALLA 1 : 1000 DATA E REALIZIMIT SHTATOR 2018 FLETA I	
				INXHINIER KONSTRUKTOR ENXHI ÇELAJ INXHINIER HIDROTEKNIK ANJEZA NEBIJ ARKITEKT SOKOL AGAJ A.1363/1 ARKITEKT IRINI GJONE	

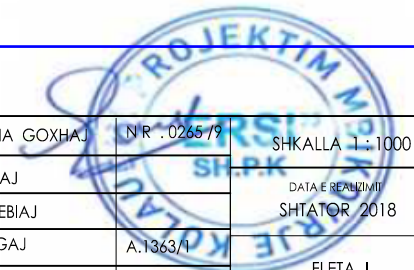

SHKOLLA "MUSTAFA KEMAL ATATURK"



	" Ersi " - shpk Adresa / Rruga Margarita Tutulani - Tirane Mobil 0.672073098 : e - mail ersi-shpk@ hotmail .com / fagoxhaj@hotmail.com	INVESTITORI :BASHKIA PEQIN OBJEKTI: SHKOLLA E MESME PAJOVE "MUSTAFA KEMAL ATATURK" BASHKIA -PEQIN	PROJEKT - ZBATIMI PAMJE 3D	INXHINIER KONSTRUKTOR FATBARDHA GOXHAJ N R . 0265 / 9	SHKALLA 1 : 1000	
	PROJEKTUES SHOQERIA " ERSI "			INXHINIER KONSTRUKTOR ENXHI ÇELAJ	INXHINIER HIDROTEKNIK ANJEZA NEBIAJ	DATA E REANIMI SHTATOR 2018
	N R . 3418 / 9 LICENSE			ARKITEKT SOKOL AGAJ A.1363/1	ARKITEKT IRINI GJONE	FLETA I

INVESTITOR : BASHKIA PEQIN
PROJEKT ZBATIMI



**OBJEKTI: RIKONSTRUKSION DHE NDERTIM PALESTRE I SHKOLLES SE MESME PAJOVE
 "MUSTAFA KEMAL ATATURK"**



	" Ersi " - shpk Adresa / Rruga Margarita Tutulani - Tirane Mobil 0.672073098 : e - mail ersi-shpk@ hotmail .com / fagoxhaj@hotmail.com	INVESTITORI :BASHKIA PEQIN	PROJEKT - ZBATIMI	INXHINIER KONSTRUKTOR	FATBARDHA GOXHAJ	N R . 0265 /9	SHKALLA 1 : 1000
	PROJEKTUES SHOQERIA " ERSI "	OBJEKTI: SHKOLLA E MESME PAJOVE "MUSTAFA KEMAL ATATURK" BASHKIA -PEQIN	SHKOLLA "MUSTAFA KEMAL ATATURK"	INXHINIER KONSTRUKTOR INXHINIER HIDROTEKNIK ARKITEKT ARKITEKT	ENXHI ÇELAJ ANJEZA NEBIJ SOKOL AGAJ IRINI GJONE	A.1363/1	DATA E REALIZIMIT SHTATOR 2018 FLETA I
	N R . 3418 / 9 LICENSE						

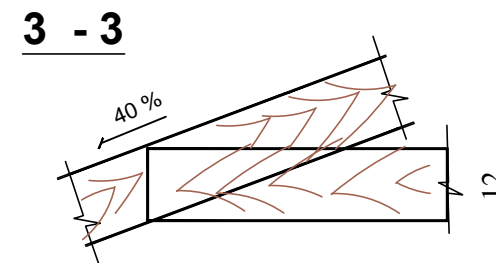
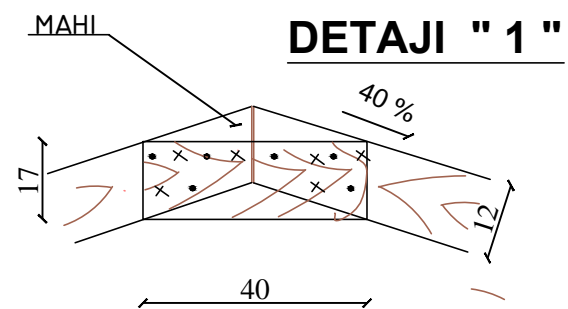

DETAILI " 3 "

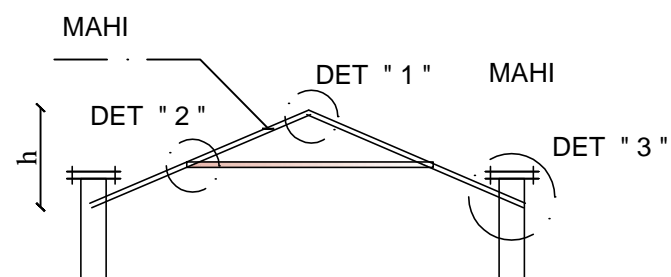
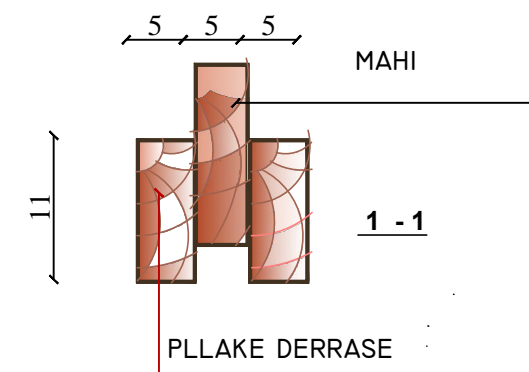
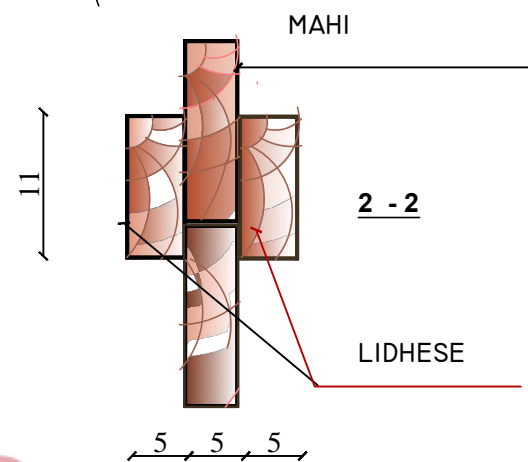
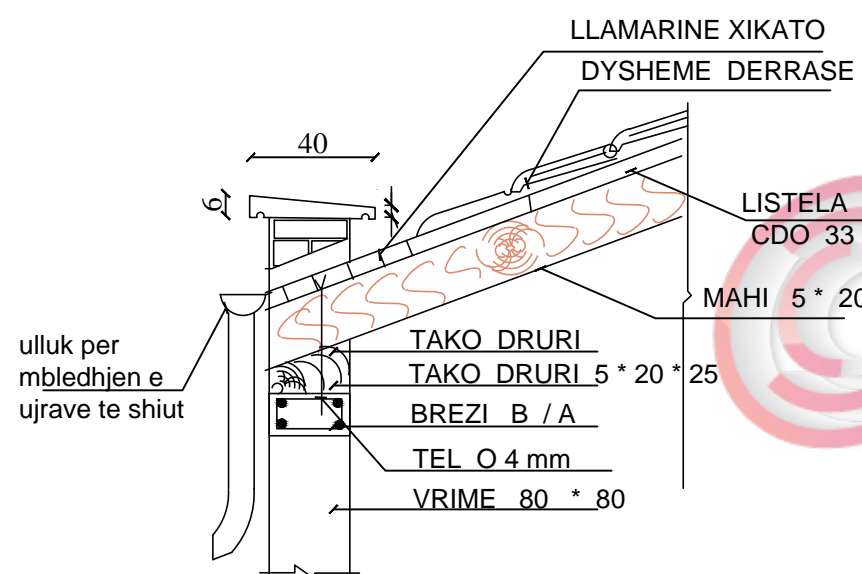

SHKOLLA "MUSTAFA KEMAL ATATURK"



"Ersi" - shpk
Adresa / Rruga Margarita Tutulani - Tirane
Mobil 0.672073098 : e-mail ersi-shpk@hotmail.com / fagoxhaj@hotmail.com

PROJEKTUES
SHOQERIA "ERSI"
NR . 3418 / 9 LICENSE

INVESTITORI :BASHKIA PEQIN
OBJEKTI: SHKOLLA E MESME PAJOVE
"MUSTAFA KEMAL ATATURK"
BASHKIA -PEQIN

PROJEKT - ZBATIMI
DETAJE TE CATISE

INXHINIER KONSTRUKTOR	FATBARDHA GOXHAJ	NR . 0265 / 9
INXHINIER KONSTRUKTOR	ENXHI ÇELAJ	
INXHINIER HIDROTEKNIK	ANJEZA NEBIJ	
ARKITEKT	SOKOL AGAJ	A.1363/1
ARKITEKT	IRINI GJONE	

SHKALLA 1 : 1000
DATA E PRAKTIKIMIT
SHTATOR 2018
FLETA I

PRERJE E DRITARES

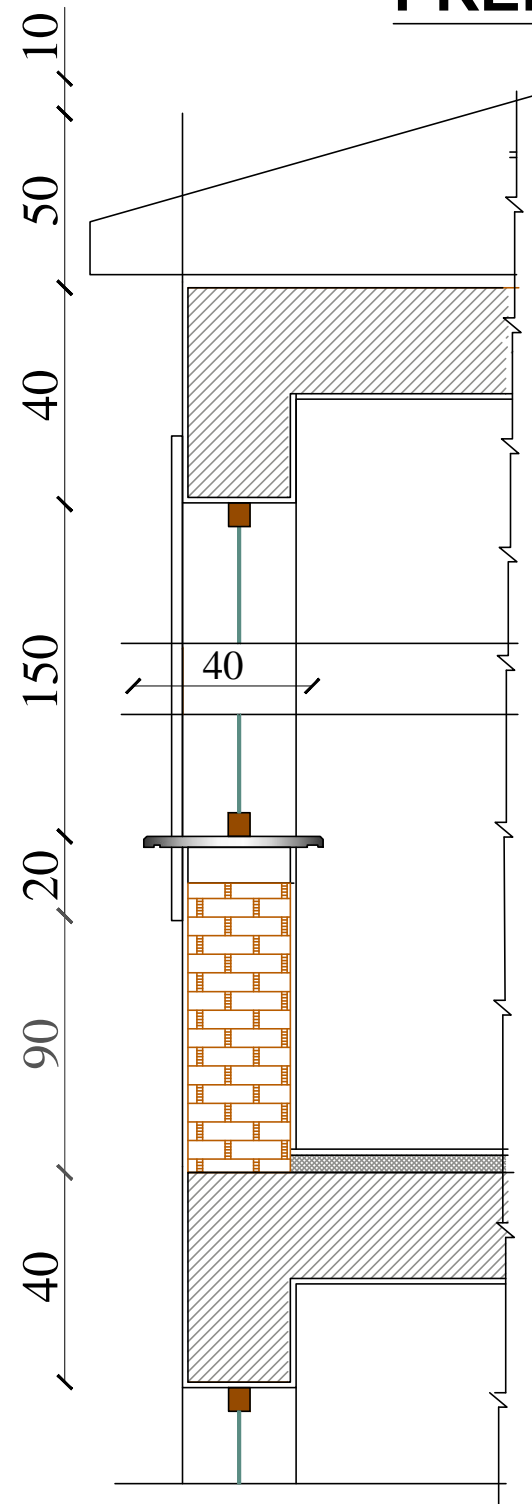

PAMJE DRITARE D - 1

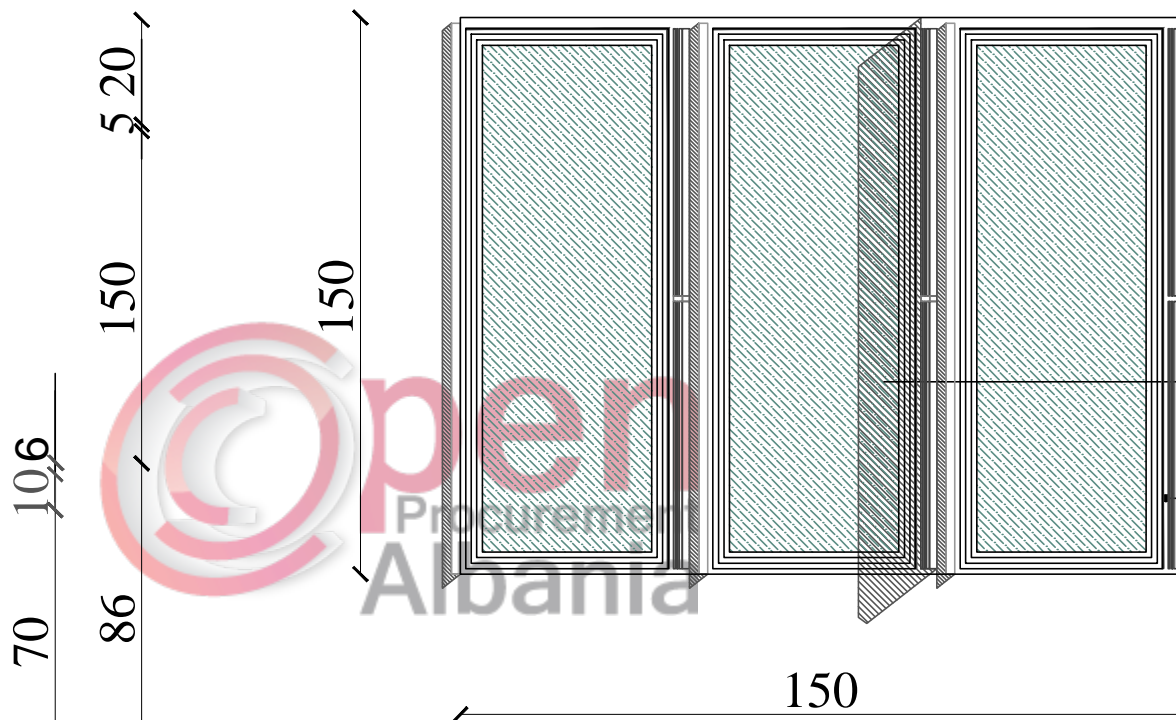

GOMINE
PROFIL METALIK
XHAM ME OPACITET 100%

Dritaret do te jene me profile duralumini me spesor 4 *8 cm Xhamat do te jene me trashesi 2.5 mm dhe distance 5 mm nga njeri tjetri. Xhamat do te jene gomina ne te dy anet ku bashkohen me profilin, Xhamat do te jene me opacitet 100 %.

SHKOLLA "MUSTAFA KEMAL ATATURK"



"Ersi" - shpk
Adresa / Rruga Margarita Tutulani - Tirane
Mobil 0.672073098 : e-mail ersi-shpk@hotmail.com / fagoxhaj@hotmail.com

PROJEKTUES
SHOQERIA "ERSI"

N R . 3418 / 9 LICENSE

INVESTITORI :BASHKIA PEQIN

OBJEKTI: SHKOLLA E MESME PAJOVE
"MUSTAFA KEMAL ATATURK"
BASHKIA -PEQIN

PROJEKT - ZBATIMI

DETAJE TE DRITARES

INXHINIER KONSTRUKTOR	FATBARDHA GOXHAJ	N R . 0265 / 9
INXHINIER KONSTRUKTOR	ENXHI ÇELAJ	
INXHINIER HIDROTEKNIK	ANJEZA NEBIJAJ	
ARKITEKT	SOKOL AGAJ	A.1363/1
ARKITEKT	IRINI GJONE	

SHKALLA 1 : 1000

DATA E REALIZIMIT
SHTATOR 2018

FLETA I