

INVESTITOR : BASHKIA PEQIN

# PROJEKT ZBATIMI



**OBJEKTI: RIKONSTRUKSION DHE NDERTIM PALESTRE I SHKOLLES SE MESME PAJOVE  
"MUSTAFA KEMAL ATATURK"**

	"Ersi" - shpk Adresa / Rruga Margarita Tutulani - Tirane Mobil 0.672073098 : e-mail ersi-shpk@hotmail.com / fagoxhaj@hotmail.com	<b>INVESTITORI :BASHKIA PEQIN</b>	<b>PROJEKT - ZBATIMI</b>	INXHINIER KONSTRUKTOR	FATBARDHA GOXHAJ	N R .0265 /9	SHKALLA 1 : 1000
	<b>PROJEKTUES</b> SHOQERIA "ERSI"  <b>N R . 3418 / 9 LICENSE</b>	<b>OBJEKTI: SHKOLLA E MESME PAJOVE</b> <b>"MUSTAFA KEMAL ATATURK"</b> <b>BASHKIA -PEQIN</b>	<b>SHKOLLA "MUSTAFA KEMAL ATATURK"</b>	INXHINIER KONSTRUKTOR	ENXHI ÇELAJ		DATA E REALIZIMIT SHTATOR 2018
				INXHINIER HIDROTEKNIK	ANJEZA NEBIJ		
				ARKITEKT	SOKOL AGAJ	A.1363/1	FLETA I
				ARKITEKT	IRINI GJONE		

INVESTITOR : BASHKIA PEQIN  
**PROJEKT ZBATIMI**

**PLANVENDOSJE E OBJEKTIT**



**OBJEKTI: RIKONSTRUKSION DHE NDERTIM PALESTRE I SHKOLLES SE MESME PAJOVE  
 "MUSTAFA KEMAL ATATURK"**



	" Ersi " - shpk Adresa / Rruga Margarita Tutulani - Tirane Mobil 0.672073098 : e - mail ersi-shpk@ hotmail .com / fagoxhaj@hotmail.com	<b>INVESTITORI :BASHKIA PEQIN</b>	<b>PROJEKT - ZBATIMI</b>	INXHINIER KONSTRUKTOR	FATBARDHA GOXHAJ	N R . 0265 /9	SHKALLA 1 : 1000
	<b>PROJEKTUES</b> SHOQERIA " ERSI " N R . 3418 / 9 LICENSE	<b>OBJEKTI: SHKOLLA E MESME PAJOVE                  "MUSTAFA KEMAL ATATURK"                  BASHKIA -PEQIN</b>	<b>SHKOLLA "MUSTAFA KEMAL ATATURK"</b>	INXHINIER KONSTRUKTOR	ENXHI ÇELAJ		DATA E REALIZIMIT SHTATOR 2018
				INXHINIER HIDROTEKNIK	ANJEZA NEBIJ		
				ARKITEKT	SOKOL AGAJ	A.1363/1	FLETA I
			ARKITEKT	IRINI GJONE			

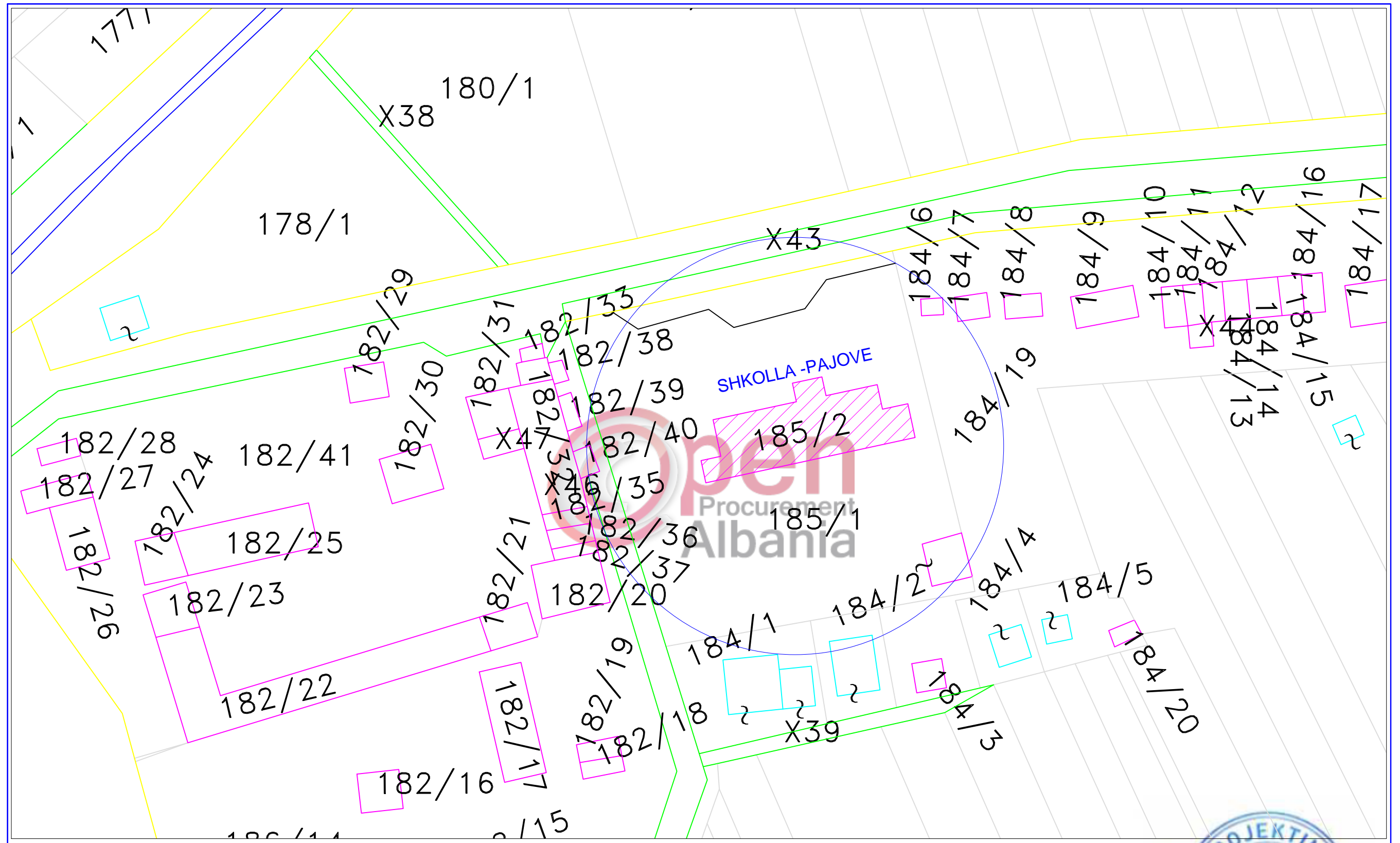

**SHKOLLA "MUSTAFA KEMAL ATATURK" HARTA KADASTRALE**



"Ersi" - shpk  
 Adresa / Rruga Margarita Tutulani - Tirane  
 Mobil 0.672073098 : e-mail ersi-shpk@hotmail.com / fagoxhaj@hotmail.com

**PROJEKTUES**  
 SHOQERIA "ERSI"

**N R . 3418 / 9 LICENSE**

**INVESTITORI : BASHKIA PEQIN**

**OBJEKTI: SHKOLLA E MESME PAJOVE  
 "MUSTAFA KEMAL ATATURK"  
 BASHKIA - PEQIN**

**PROJEKT - ZBATIMI**

**SKEME ZONIMI  
 BASHKIA PEQIN**

INXHINIER KONSTRUKTOR	FATBARDHA GOXHAJ	N.R. 0265 / 9	SHKALLA 1 : 1000
INXHINIER KONSTRUKTOR	ENXHI ÇELA		
INXHINIER HIDROTEKNIK	ANJEZA NEBIJ		DATA E REALIZIMIT SHTATOR 2018
ARKITEKT	SOKOL AGAJ	A.1363/1	FLETA I
ARKITEKT	IRINI GJONE		

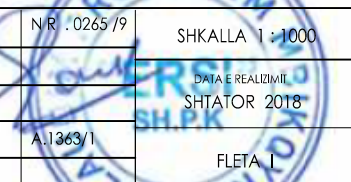

**SHKOLLA "MUSTAFA KEMAL ATATURK"**

	" Ersi " - shpk Adresa / Rruga Margarita Tutulani - Tirane Mobil 0.672073098 : e - mail ersi-shpk@ hotmail .com / fagoxhaj@hotmail.com	<b>INVESTITORI :BASHKIA PEQIN</b>  <b>OBJEKTI: SHKOLLA E MESME PAJOVE</b> <b>"MUSTAFA KEMAL ATATURK"</b> <b>BASHKIA -PEQIN</b>	<b>PROJEKT - ZBATIMI</b>  <b>SKEME ZONIMI</b> <b>BASHKIA PEQIN</b>	INXHINIER KONSTRUKTOR    FATBARDHA GOXHAJ    NR .0265 /9    SHKALLA 1 : 1000		
	<b>PROJEKTUES</b> SHOQERIA " ERSI "			INXHINIER KONSTRUKTOR    ENXHI ÇELAJ		INXHINIER HIDROTEKNIK    ANJEZA NEBIAJ
	<b>NR . 3418 / 9 LICENSE</b>			ARKITEKT    SOKOL AGAJ    A.1363 /1		ARKITEKT    IRINI GJONE



**SHKOLLA "MUSTAFA KEMAL ATATURK"**

	"Ersi" - shpk Adresa / Rruga Margarita Tutulani - Tirane Mobil 0.672073098 : e-mail ersi-shpk@hotmail.com / fagoxhaj@hotmail.com	<b>INVESTITORI : BASHKIA PEQIN</b>  <b>OBJEKTI: SHKOLLA E MESME PAJOVE          "MUSTAFA KEMAL ATATURK"          BASHKIA -PEQIN</b>	<b>PROJEKT - ZBATIMI</b>  <b>SKEME ZONIMI          BASHKIA PEQIN</b>	INXHINIER KONSTRUKTOR    FATBARDHA GOXHAJ    NR. 0265/9	SHKALLA 1 : 1000
	<b>PROJEKTUES          SHOQERIA "ERSI"</b>  <b>N R . 3418 / 9 LICENSE</b>			INXHINIER KONSTRUKTOR    ENXHI ÇELAJ INXHINIER HIDROTEKNIK    ANJEZA NEBIJ ARKITEKT    SOKOL AGAJ ARKITEKT    IRINI GJONE	A.1363/1 FLETA I

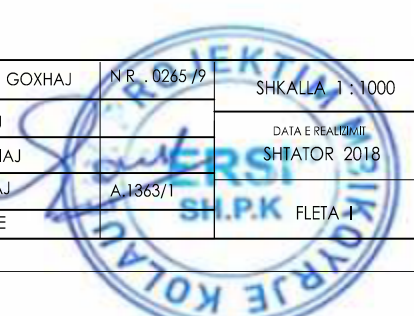

INVESTITOR : BASHKIA PEQIN  
**PROJEKT ZBATIMI**

**PLANIMETRI E OBJEKTIT**



**OBJEKTI: RIKONSTRUKSION DHE NDERTIM PALESTRE I SHKOLLES SE MESME PAJOVE  
 "MUSTAFA KEMAL ATATURK"**

	"Ersi" - shpk Adresa / Rruga Margarita Tutulani - Tirane Mobil 0.672073098 : e-mail ersi-shpk@hotmail.com / fagoxhaj@hotmail.com	<b>INVESTITORI :BASHKIA PEQIN</b>	<b>PROJEKT - ZBATIMI</b>	INXHINIER KONSTRUKTOR	FATBARDHA GOXHAJ	N R .0265 /9	SHKALLA 1 : 1000
	<b>PROJEKTUES</b> SHOQERIA "ERSI" N R . 3418 / 9 LICENSE	<b>OBJEKTI: SHKOLLA E MESME PAJOVE                  "MUSTAFA KEMAL ATATURK"                  BASHKIA -PEQIN</b>	<b>SHKOLLA "MUSTAFA KEMAL ATATURK"</b>	INXHINIER KONSTRUKTOR	ENXHI ÇELAJ		DATA E REALIZIMIT
				INXHINIER HIDROTEKNIK	ANJEZA NEBIJ		SHTATOR 2018
				ARKITEKT	SOKOL AGAJ	A.1363/1	FLETA I
			ARKITEKT	IRINI GJONE			

## PLANIMETRIA E KATIT PERDHE SHKOLLA E MESME PAJOVE

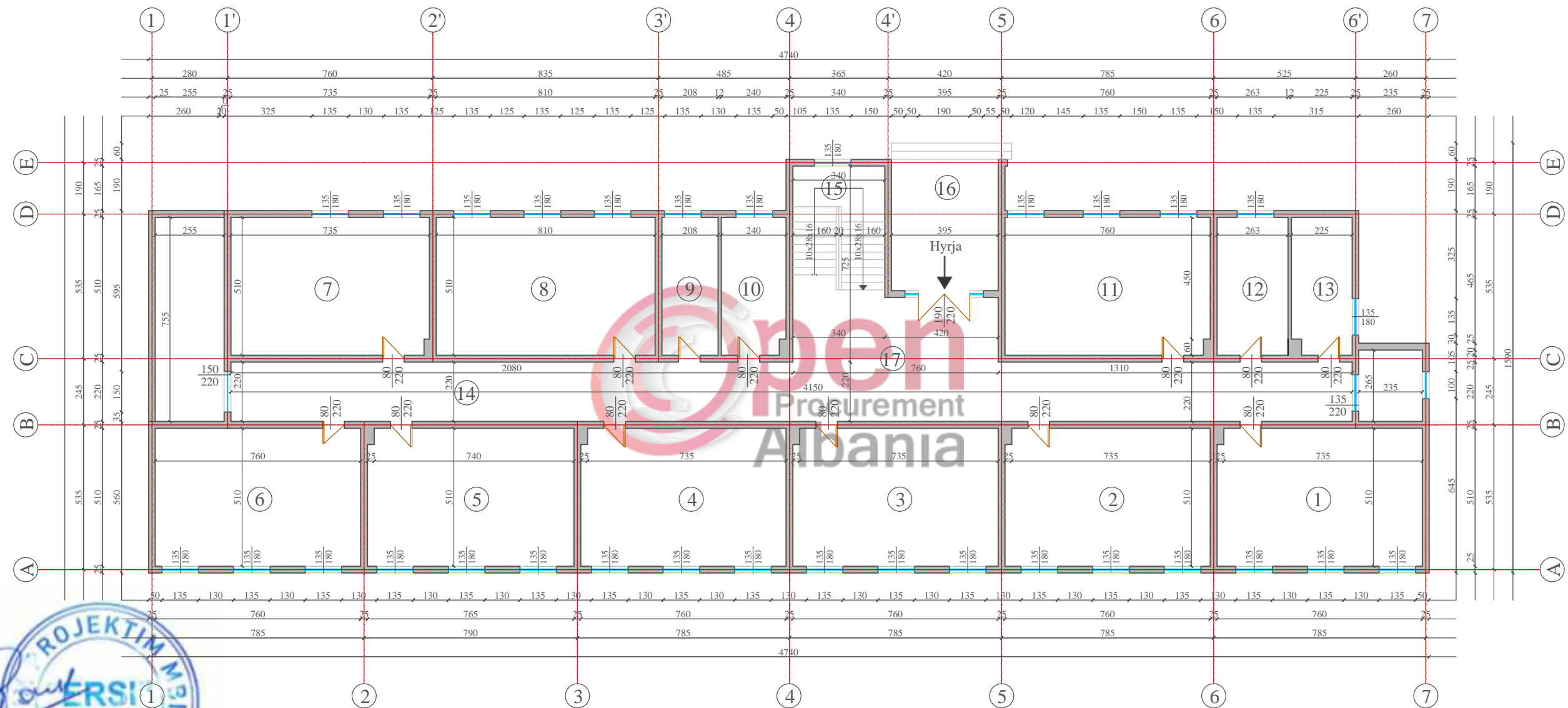

### SHKOLLA "MUSTAFA KEMAL ATATURK"

	"Ersi" - shpk Adresa / Rruga Margarita Tutulani - Tirane Mobil 0.672073098 : e - mail ersi-shpk@ hotmail .com / fagoxhaj@hotmail.com	<b>INVESTITORI :BASHKIA PEQIN</b>	<b>PROJEKT - ZBATIMI</b>	INXHINIER KONSTRUKTOR	FATBARDHA GOXHAJ	N R .0265 /9	SHKALLA 1 : 1000
	<b>PROJEKTUES SHOQERIA "ERSI"</b>	<b>OBJEKTI: SHKOLLA E MESME PAJOVE "MUSTAFA KEMAL ATATURK"</b>	<b>PLANIMETRIA E KATIT PERDHE</b>	INXHINIER KONSTRUKTOR	ENXHI ÇELAJ		DATA E REALIZIMIT SHTATOR 2018
	<b>N R . 3418 / 9 LICENSE</b>	<b>BASHKIA -PEQIN</b>		INXHINIER HIDROTEKNIK	ANJEZA NEBJAJ	A.1363/1	FLETA I
				ARKITEKT	SOKOL AGAJ		
			ARKITEKT	IRINI GJONE			

**PLANIMETRIA E KATIT PERDHE  
SHKOLLA E MESME PAJOVE  
GJENDJA PAS RIKONSTRUKSIONIT**

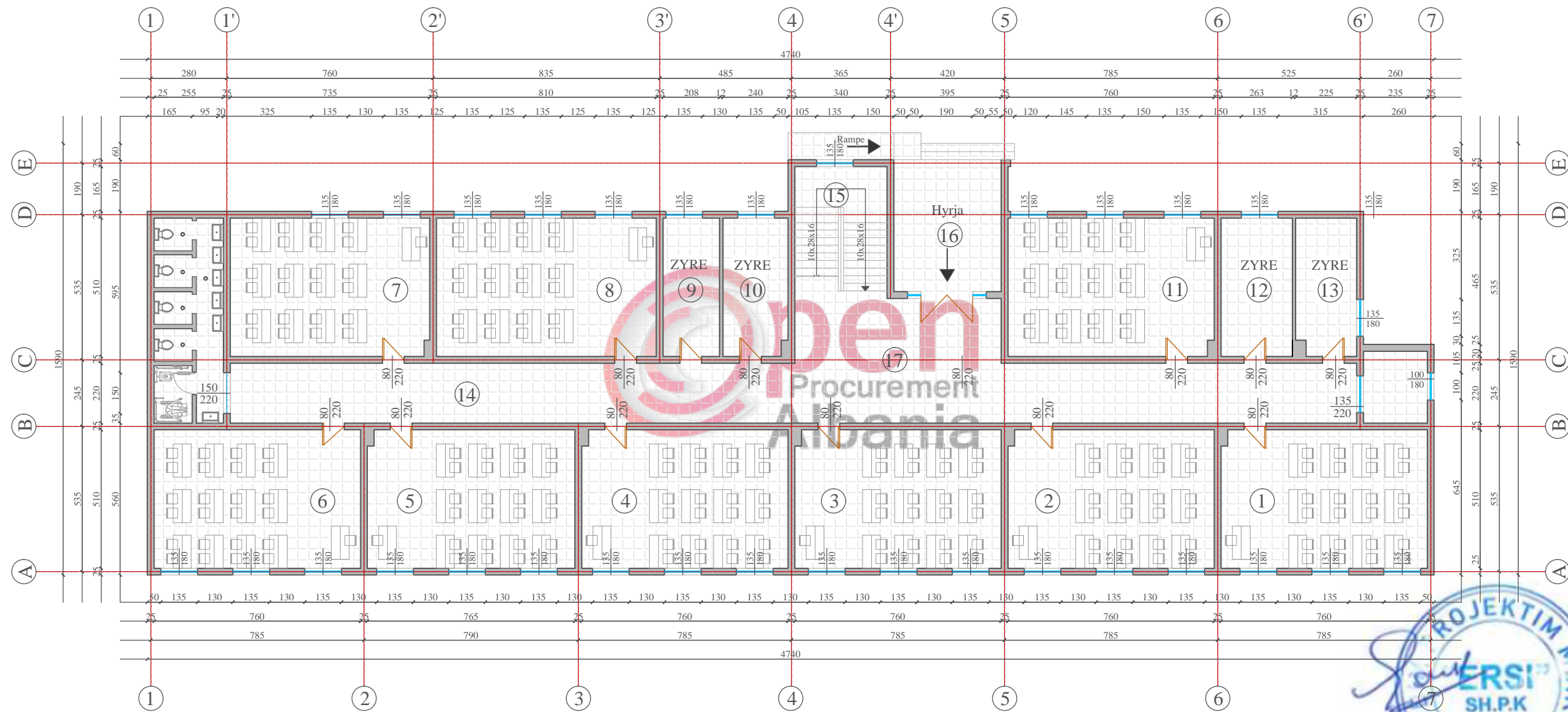

**SHKOLLA "MUSTAFA KEMAL ATATURK"**

	"Ersi" - shpk Adresa / Rruga Margarita Tutulani - Tirane Mobil 0.672073098 : e - mail ersi-shpk@ hotmail .com / fagohaj@hotmail.com	<b>INVESTITORI :BASHKIA PEQIN</b>	<b>PROJEKT - ZBATIMI</b>	INXHINIER KONSTRUKTOR	FATBARDHA GOXHAJ	N R .0265 /9	SHKALLA 1 : 1000
	<b>PROJEKTUES</b> SHOQERIA "ERSI" N R . 3418 / 9 LICENSE	<b>OBJEKTI: SHKOLLA E MESME PAJOVE</b> <b>"MUSTAFA KEMAL ATATURK"</b> BASHKIA -PEQIN	<b>PLANIMETRIA E KATIT PERDHE</b> <b>E RIKONSTRUKTUAR</b>	INXHINIER KONSTRUKTOR INXHINIER HIDROTEKNIK ARKITEKT ARKITEKT	ENXHI ÇELAJ ANJEZA NEBAJ SOKOL AGAJ IRINI GJONE	A.1363/1	DATA E REALIZIMIT SHTATOR 2018 FLETA I



## PLANIMETRIA E KATIT I SHKOLLA E MESME PAJOVE

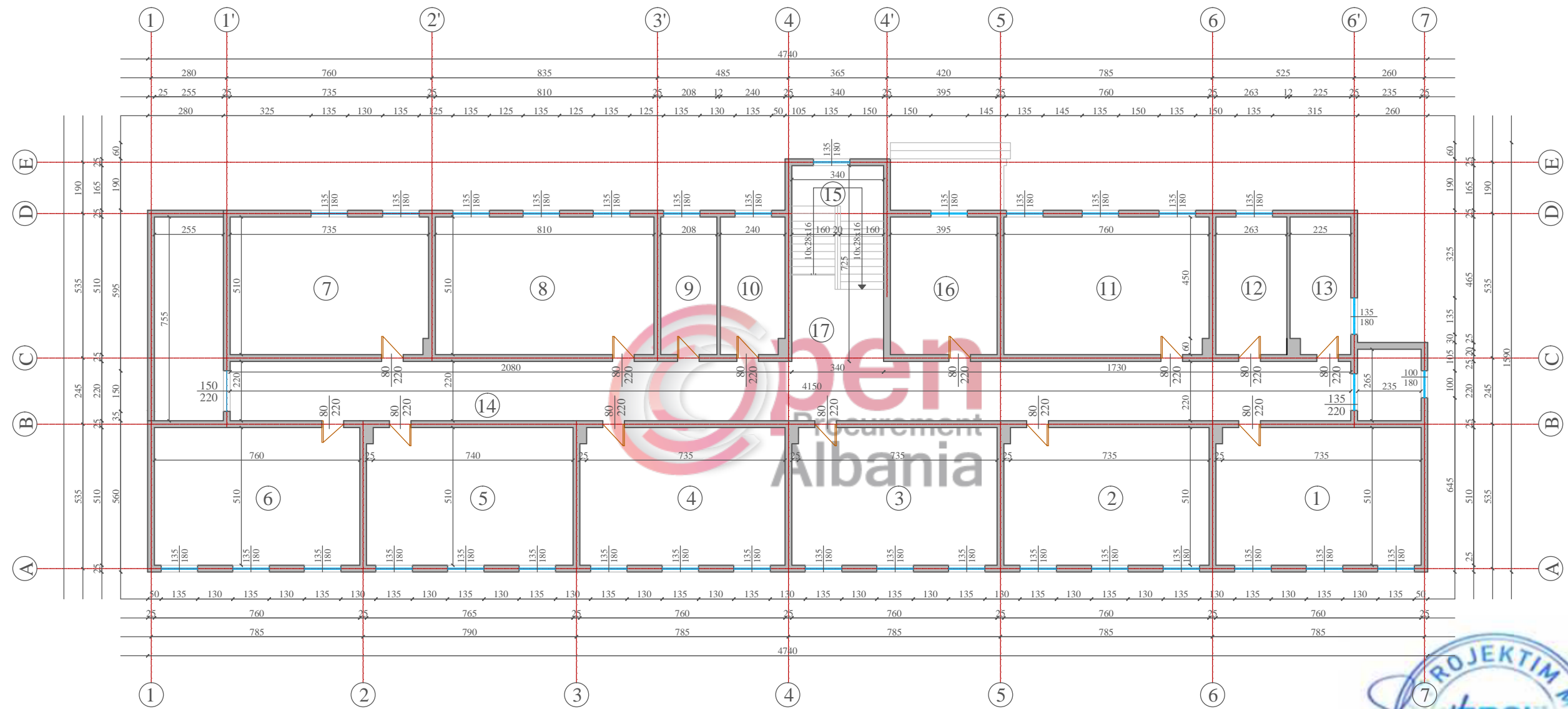

### SHKOLLA "MUSTAFA KEMAL ATATURK"

	"Ersi" - shpk Adresa / Rruga Margarita Tutulani - Tirane Mobil 0.672073098 : e - mail ersi-shpk@ hotmail .com / fagoxhaj@hotmail.com	<b>INVESTITORI : BASHKIA PEQIN</b>	<b>PROJEKT - ZBATIMI</b>	INXHINIER KONSTRUKTOR    FATBARDHA GOXHAJ    N R . 0265 / 9 INXHINIER KONSTRUKTOR    ENXHI ÇELAJ INXHINIER HIDROTEKNIK    ANJEZA NEBIAJ ARKITEKT    SOKOL AGAJ    A.1363/1 ARKITEKT    IRINI GJONE	SHKALLA 1 : 1000 DATA E REALIZIMIT SHTATOR 2018 FLETA I
	<b>PROJEKTUES</b> SHOQERIA "ERSI" N R . 3418 / 9 LICENSE	<b>OBJEKTI: SHKOLLA E MESME PAJOVE</b> <b>"MUSTAFA KEMAL ATATURK"</b> BASHKIA -PEQIN	<b>PLANIMETRIA E KATIT I</b>		

**PLANIMETRIA E KATIT I  
SHKOLLA E MESME PAJOVE  
GJENDJA PAS RIKONSTRUKSIONIT**

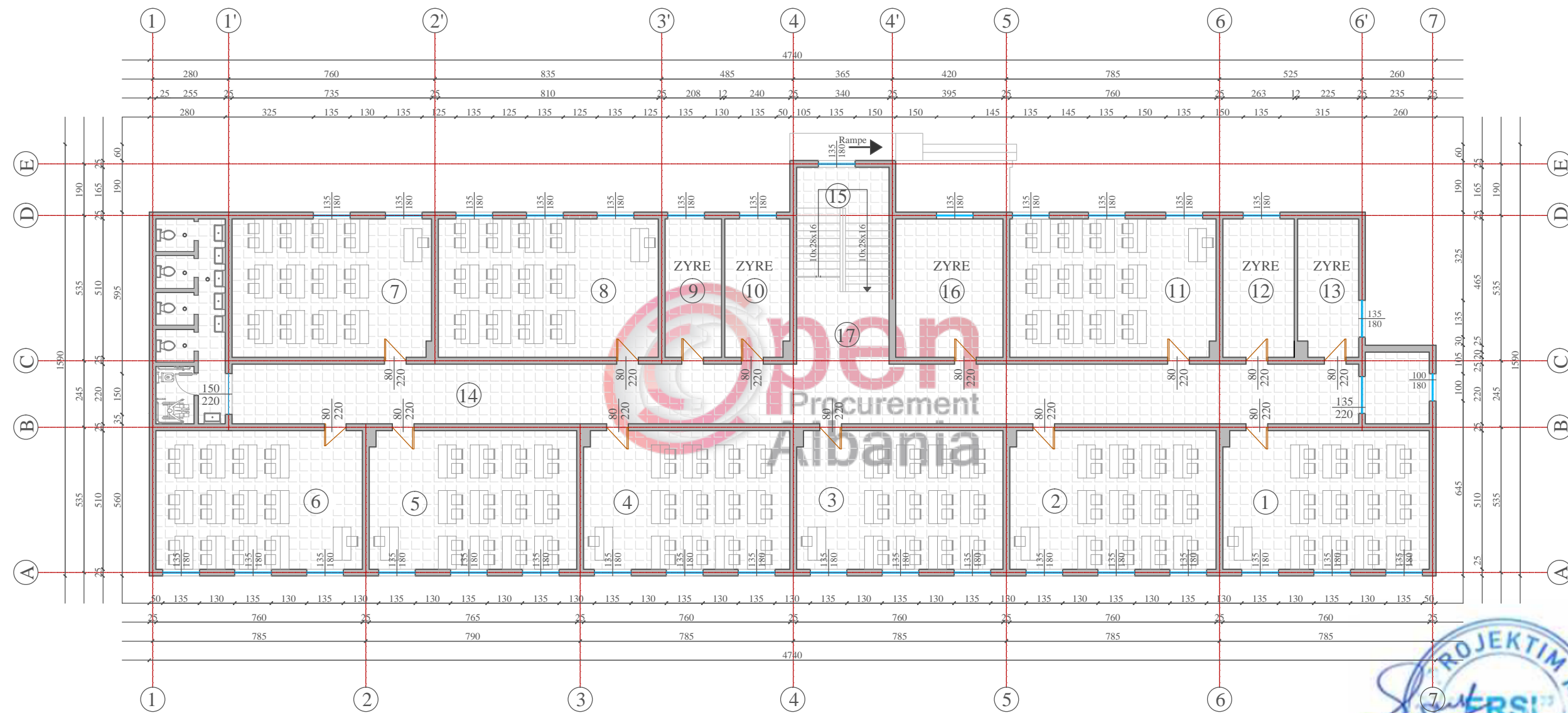

**SHKOLLA "MUSTAFA KEMAL ATATURK"**

"Ersi" - shpk  
Adresa / Rruga Margarita Tutulani - Tirane  
Mobil 0.672073098 : e-mail ersi-shpk@hotmail.com / fagohaj@hotmail.com

**INVESTITORI : BASHKIA PEQIN**

**PROJEKT - ZBATIMI**

INXHINIER KONSTRUKTOR	FATBARDHA GOXHAJ	N.R. 0265 /9	SHKALLA 1 : 1000
INXHINIER KONSTRUKTOR	ENXHI ÇELAJ		DATA E REALIZIMIT SHTATOR 2018
INXHINIER HIDROTEKNIK	ANJEZA NE SOKOL AGAJ		FLETA I
ARKITEKT		A.1363/1	
ARKITEKT	IRINI GJONE		

**OBJEKTI: SHKOLLA E MESME PAJOVE  
"MUSTAFA KEMAL ATATURK"  
BASHKIA PEQIN**

**PLANIMETRIA E KATIT I  
E RIKONSTRUKTUAR**



**PROJEKTUES  
SHOQERIA "ERSI"  
N R . 3418 / 9 LICENSE**

INVESTITOR : BASHKIA PEQIN  
**PROJEKT ZBATIMI**

**PLANI ELEKTRIK**



**OBJEKTI: RIKONSTRUKSION DHE NDERTIM PALESTRE I SHKOLLES SE MESME PAJOVE  
 "MUSTAFA KEMAL ATATURK"**



	" Ersi " - shpk Adresa / Rruga Margarita Tutulani - Tirane Mobil 0.672073098 : e - mail ersi-shpk@ hotmail .com / fagoxhaj@hotmail.com	<b>INVESTITORI :BASHKIA PEQIN</b>	<b>PROJEKT - ZBATIMI</b>	INXHINIER KONSTRUKTOR	FATBARDHA GOXHAJ	N R . 0265 /9	SHKALLA 1 : 1000
	<b>PROJEKTUES</b> SHOQERIA " ERSI " N R . 3418 / 9 LICENSE	<b>OBJEKTI: SHKOLLA E MESME PAJOVE                  "MUSTAFA KEMAL ATATURK"                  BASHKIA -PEQIN</b>	<b>SHKOLLA "MUSTAFA KEMAL ATATURK"</b>	INXHINIER KONSTRUKTOR	ENXHI ÇELAJ		DATA E REALIZIMIT
				INXHINIER HIDROTEKNIK	ANJEZA NEBIJ		SHTATOR 2018
				ARKITEKT	SOKOL AGAJ	A.1363/1	FLETA I
			ARKITEKT	IRINI GJONE			

## PLANI ELEKTRIK I KATIT PERDHE SHKOLLA E MESME PAJOVE

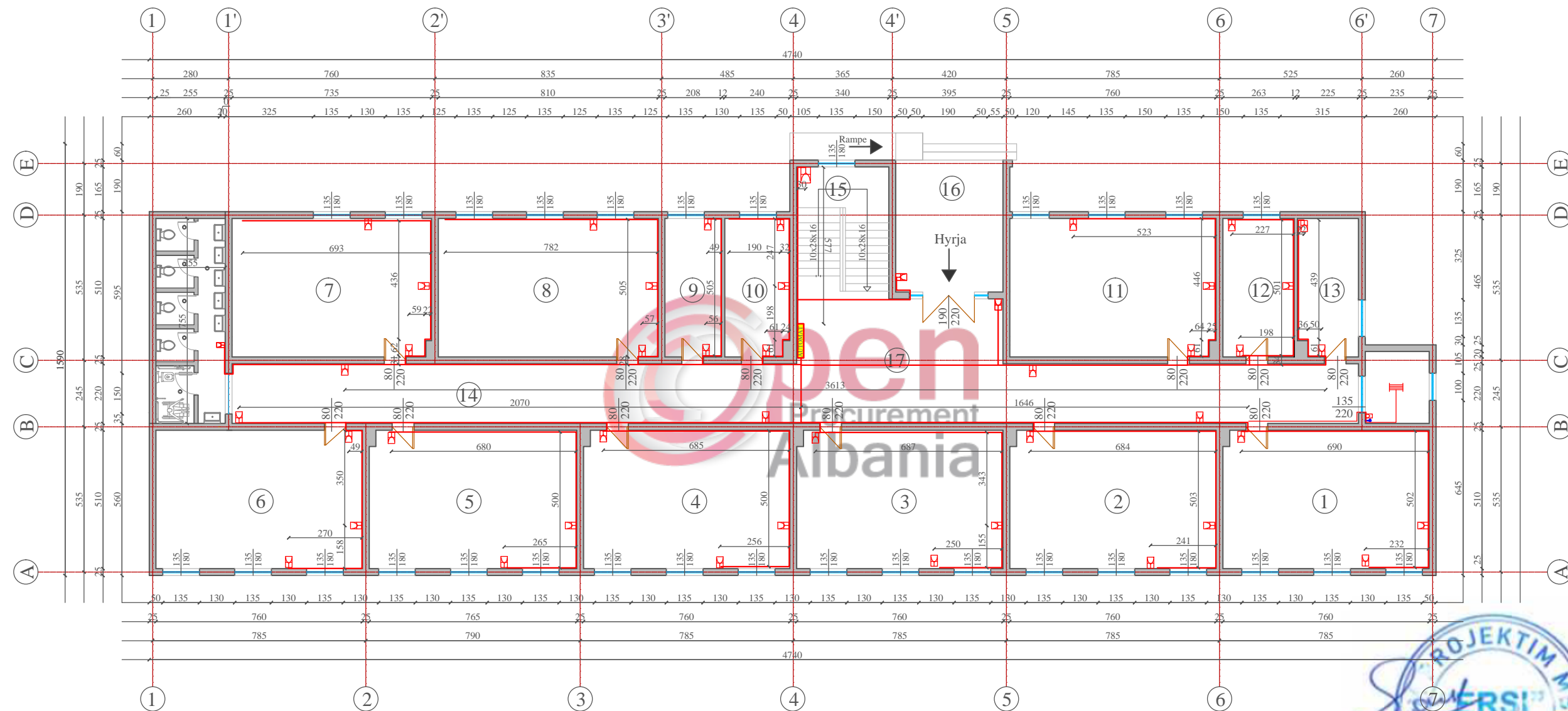

### SHKOLLA "MUSTAFA KEMAL ATATURK"

	"Ersi" - shpk Adresa / Rruga Margarita Tutulani - Tirane Mobil 0.672073098 : e - mail ersi-shpk@ hotmail .com / fagoxhaj@hotmail.com	<b>INVESTITORI :BASHKIA PEQIN</b>	<b>PROJEKT - ZBATIMI</b>	INXHINIER KONSTRUKTOR    FATBARDHA GOXHAJ    N R .0265 /9 INXHINIER KONSTRUKTOR    ENXHI ÇELAJ INXHINIER HIDROTEKNIK    ANJEZA NEBIJ ARKITEKT    SOKOL AGAJ ARKITEKT    IRINI GJONE	SHKALLA 1 : 1000 DATA E REALIZIMIT SHTATOR 2018 FLETA I
	<b>PROJEKTUES SHOQERIA "ERSI"</b>	<b>OBJEKTI: SHKOLLA E MESME PAJOVE "MUSTAFA KEMAL ATATURK"</b>	<b>PLANI ELEKTRIK KATIT PERDHE</b>	A.1363/1	
	<b>N R . 3418 / 9 LICENSE</b>	<b>BASHKIA -PEQIN</b>			

## PLANI ELEKTRIK I KATIT I SHKOLLA E MESME PAJOVE

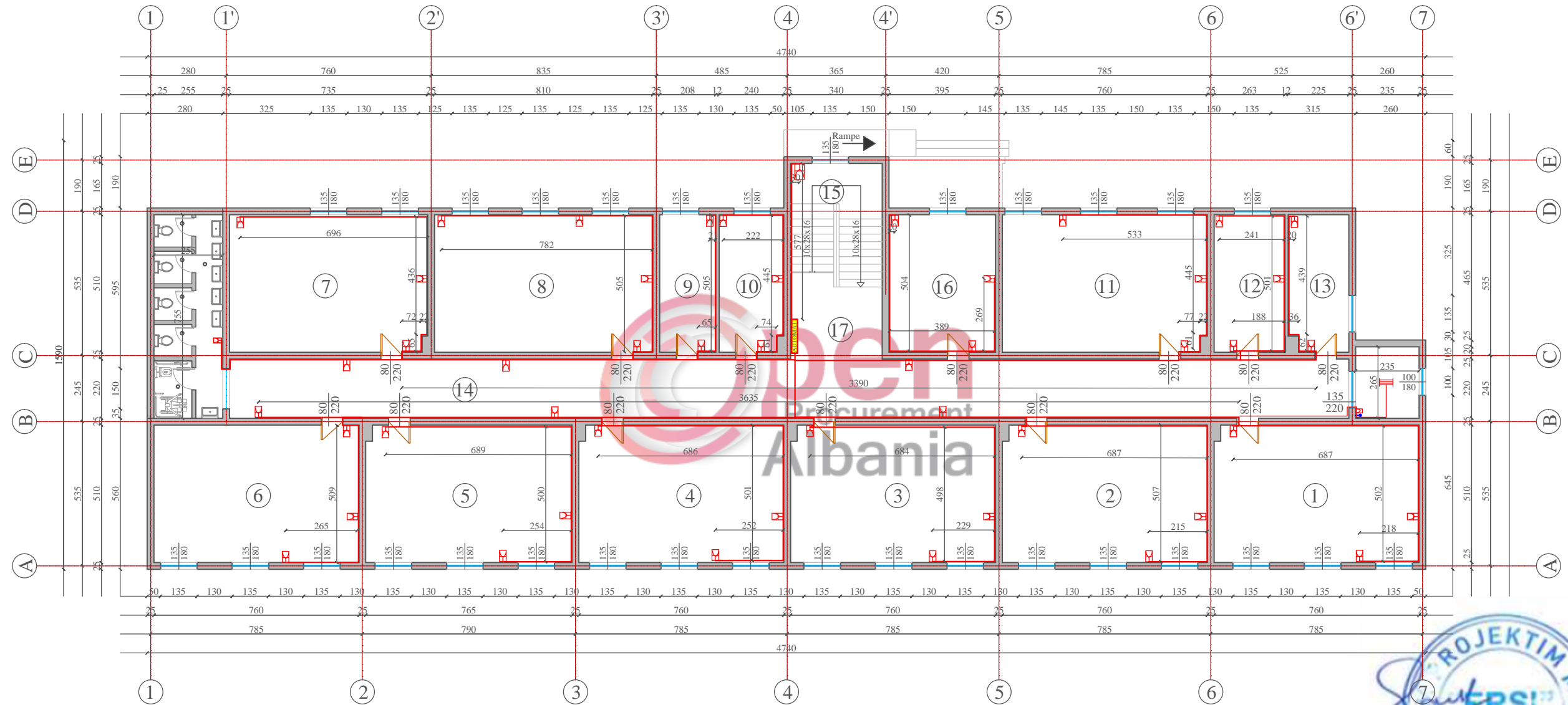

### SHKOLLA "MUSTAFA KEMAL ATATURK"

	"Ersi" - shpk Adresa / Rruga Margarita Tutulani - Tirane Mobil 0.672073098 : e - mail ersi-shpk@ hotmail .com / fagoxhaj@hotmail.com	<b>INVESTITORI :BASHKIA PEQIN</b>	<b>PROJEKT - ZBATIMI</b>	INXHINIER KONSTRUKTOR    FATBARDHA GOXHAJ    N R .0265 /9	SHKALLA 1 : 1000
	<b>PROJEKTUES SHOQERIA "ERSI"</b>	<b>OBJEKTI: SHKOLLA E MESME PAJOVE "MUSTAFA KEMAL ATATURK"</b>	<b>BASHKIA -PEQIN</b>	INXHINIER KONSTRUKTOR    ENXHI ÇELAJ	DATA E REALIZIMIT SHTATOR 2018
	<b>N R . 3418 / 9 LICENSE</b>	<b>BASHKIA -PEQIN</b>		INXHINIER HIDROTEKNIK    ANJEZA NEBJAJ	A.1363/1
				ARKITEKT    SOKOL AGAJ	FLETA I
			ARKITEKT    IRINI GJONE		

## PLANI NDRICIMIT I KATIT PERDHE SHKOLLA E MESME PAJOVE

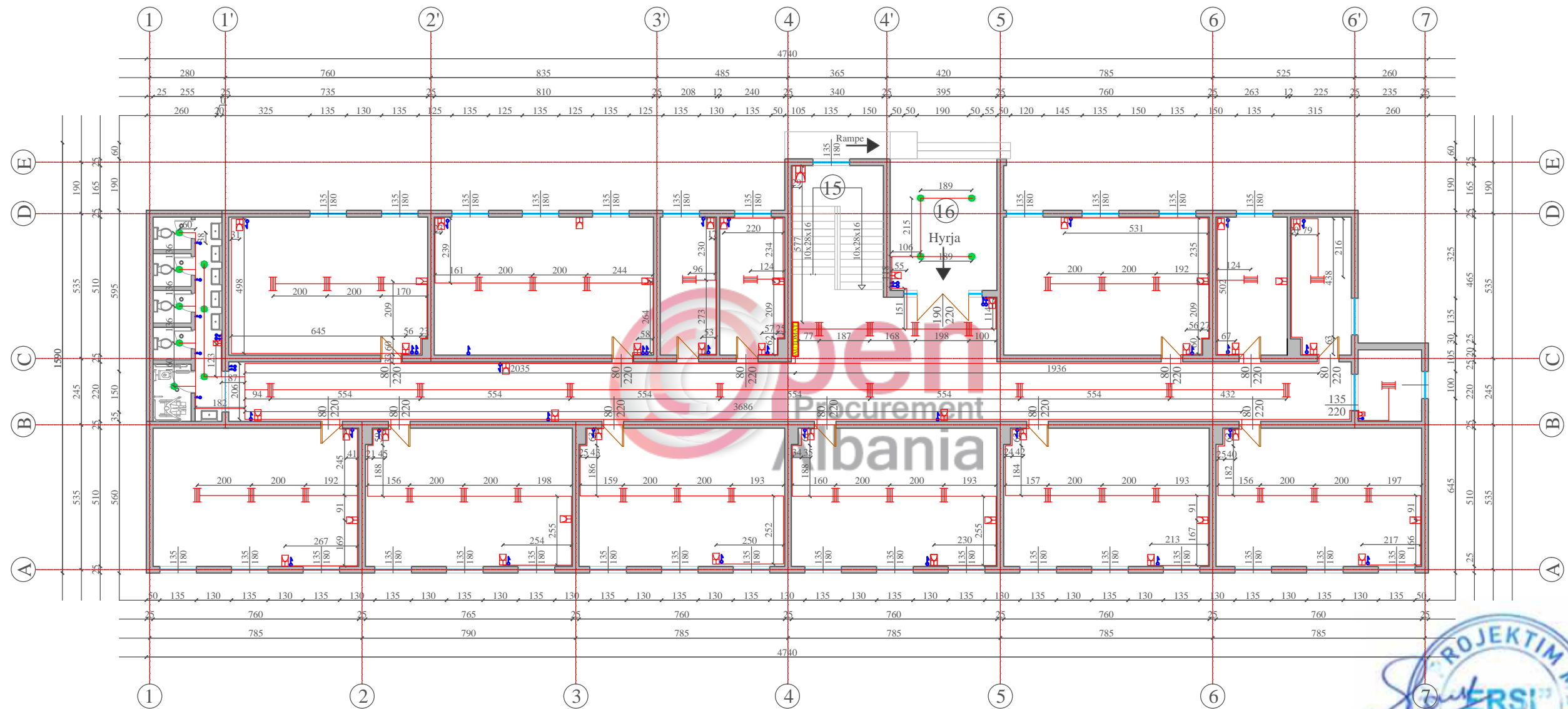

### SHKOLLA "MUSTAFA KEMAL ATATURK"

	"Ersi" - shpk Adresa / Rruga Margarita Tutulani - Tirane Mobil 0.672073098 : e-mail ersi-shpk@hotmail.com / fagoxhaj@hotmail.com	<b>INVESTITORI :BASHKIA PEQIN</b>	<b>PROJEKT - ZBATIMI</b>	INXHINIER KONSTRUKTOR    FATBARDHA GOXHAJ    N R .0265 /9	SHKALLA 1 : 1000
	<b>PROJEKTUES SHOQERIA "ERSI"</b>	<b>OBJEKTI: SHKOLLA E MESME PAJOVE "MUSTAFA KEMAL ATATURK"</b>	<b>PLANI NDRICIMIT KATIT PERDHE</b>	INXHINIER KONSTRUKTOR    ENXHI ÇELAJ INXHINIER HIDROTEKNIK    ANJEZA NEBAJ	DATA E REALIZIMIT SHTATOR 2018
	<b>N R . 3418 / 9 LICENSE</b>	<b>BASHKIA -PEQIN</b>		ARKITEKT    SOKOL AGAJ ARKITEKT    IRINI GJONE	A.1363/1
					FLETA I

## PLANI NDRICIMIT I KATIT I SHKOLLA E MESME PAJOVE

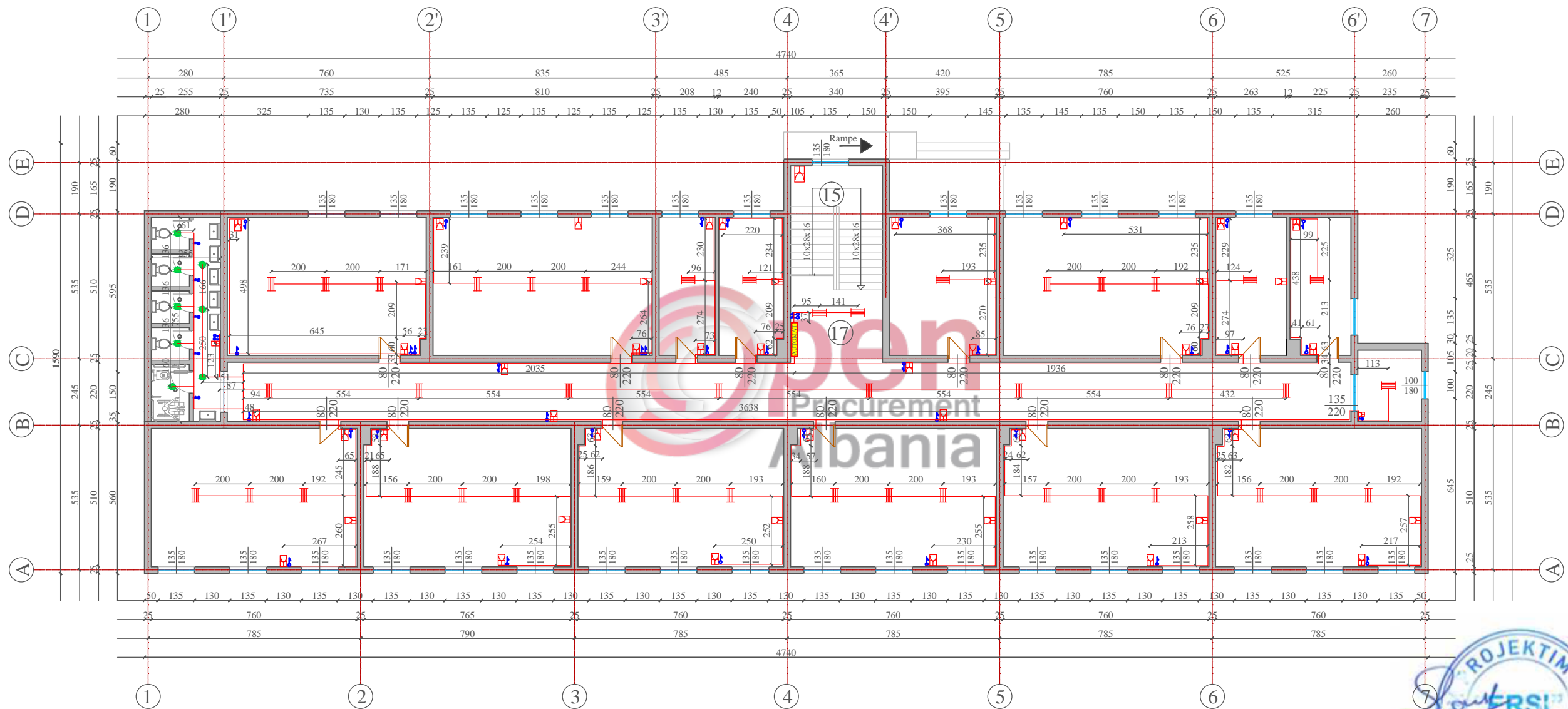

### SHKOLLA "MUSTAFA KEMAL ATATURK"

	"Ersi" - shpk Adresa / Rruga Margarita Tutulani - Tirane Mobil 0.672073098 : e - mail ersi-shpk@ hotmail .com / fagoxhaj@hotmail.com	<b>INVESTITORI :BASHKIA PEQIN</b>	<b>PROJEKT - ZBATIMI</b>	INXHINIER KONSTRUKTOR    FATBARDHA GOXHAJ    N R .0265 /9	SHKALLA 1 : 1000
	<b>PROJEKTUES SHOQERIA "ERSI"</b>	<b>OBJEKTI: SHKOLLA E MESME PAJOVE "MUSTAFA KEMAL ATATURK"</b>	<b>PLANI NDRICIMIT KATI I</b>	INXHINIER KONSTRUKTOR    ENXHI ÇELAJ INXHINIER HIDROTEKNIK    ANJEZA NEBAJ	DATA E REALIZIMIT SHTATOR 2018
	<b>N R . 3418 / 9    LICENSE</b>	<b>BASHKIA -PEQIN</b>		ARKITEKT    SOKOL AGAJ    A.1363/1 ARKITEKT    IRINI GJONE	FLETA I

INVESTITOR : BASHKIA PEQIN  
**PROJEKT ZBATIMI**

**PROJEKT HIDROSANITAR DHE KUZ**



**OBJEKTI: RIKONSTRUKSION DHE NDERTIM PALESTRE I SHKOLLES SE MESME PAJOVE  
 "MUSTAFA KEMAL ATATURK"**



	" Ersi " - shpk Adresa / Rruga Margarita Tutulani - Tirane Mobil 0.672073098 : e - mail ersi-shpk@ hotmail .com / fagoxhaj@hotmail.com	<b>INVESTITORI :BASHKIA PEQIN</b>	<b>PROJEKT - ZBATIMI</b>	INXHINIER KONSTRUKTOR	FATBARDHA GOXHAJ	N R . 0265 /9	SHKALLA 1 : 1000
	<b>PROJEKTUES</b> SHOQERIA " ERSI "	<b>OBJEKTI: SHKOLLA E MESME PAJOVE                  "MUSTAFA KEMAL ATATURK"</b> BASHKIA -PEQIN	SHKOLLA "MUSTAFA KEMAL ATATURK"	INXHINIER KONSTRUKTOR INXHINIER HIDROTEKNIK ARKITEKT ARKITEKT	ENXHI ÇELAJ ANJEZA NEBIJ SOKOL AGAJ IRINI GJONE	A.1363/1	DATA E REALIZIMIT SHTATOR 2018 FLETA I
<b>N R . 3418 / 9 LICENSE</b>							



## PLANIMETRIA E KATIT PERDHE KUZ SHKOLLA E MESME PAJOVE

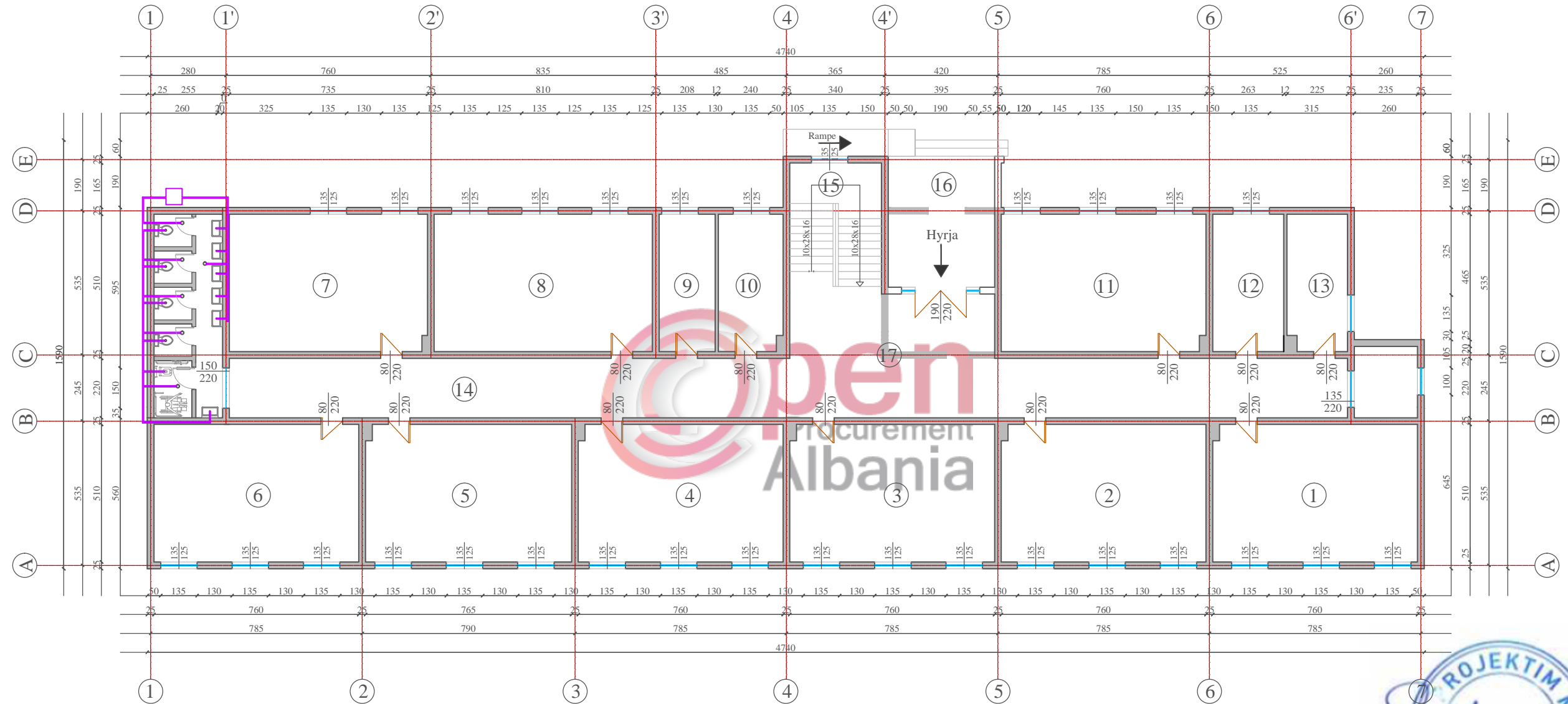

### SHKOLLA "MUSTAFA KEMAL ATATURK"

	"Ersi" - shpk Adresa / Rruga Margarita Tutulani - Tirane Mobil 0.672073098 : e - mail ersi-shpk@ hotmail .com / fagoxhaj@hotmail.com	<b>INVESTITORI : BASHKIA PEQIN</b>	<b>PROJEKT - ZBATIMI</b>	INXHINIER KONSTRUKTOR    FATBARDHA GOXHAJ    N R . 0265 /9 INXHINIER KONSTRUKTOR    ENXHI ÇELAJ INXHINIER HIDROTEKNIK    ANJEZA NEBIJAJ ARKITEKT    SOKOL AGAJ    A.1363/1 ARKITEKT    IRINI GJONE	SHKALLA 1 : 1000 DATA E REALIZIMIT SHTATOR 2018 FLETA I
	<b>PROJEKTUES</b> SHOQERIA "ERSI" N R . 3418 / 9 LICENSE	<b>OBJEKTI: SHKOLLA E MESME PAJOVE</b> <b>"MUSTAFA KEMAL ATATURK"</b> BASHKIA -PEQIN	<b>PLANI KUZ</b> <b>KATIT PERDHE</b>		

## PLANIMETRIA E KATIT I KUZ SHKOLLA E MESME PAJOVE

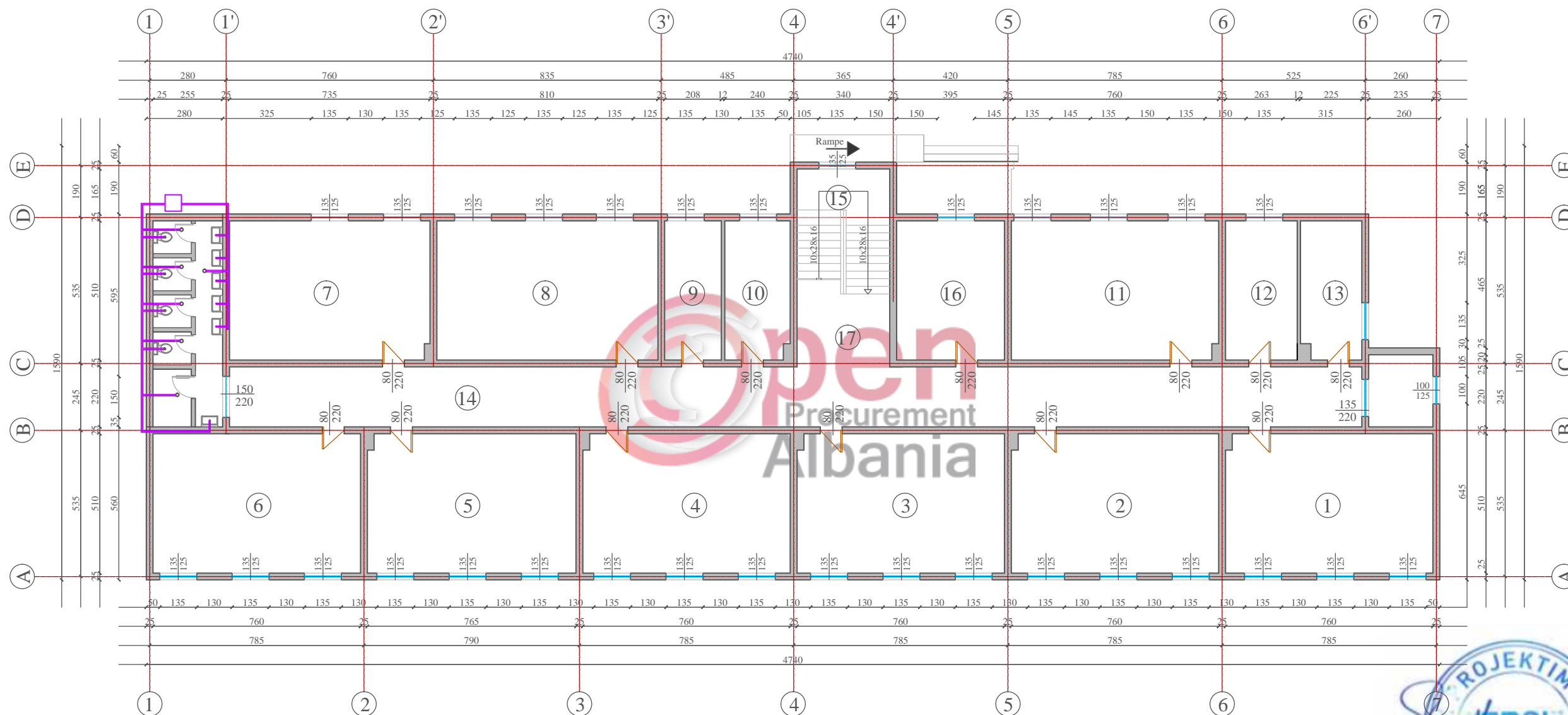

### SHKOLLA "MUSTAFA KEMAL ATATURK"

	"Ersi" - shpk Adresa / Rruga Margarita Tutulani - Tirane Mobil 0.672073098 : e - mail ersi-shpk@ hotmail .com / fagoxhaj@hotmail.com	<b>INVESTITORI :BASHKIA PEQIN</b>	<b>PROJEKT - ZBATIMI</b>	INXHINIER KONSTRUKTOR    FATBARDHA GOXHAJ    N.R .0265 /9 INXHINIER KONSTRUKTOR    ENXHI ÇELAJ INXHINIER HIDROTEKNIK    ANJEZA NEBIJAJ ARKITEKT    SOKOL AGAJ    A.1363/1 ARKITEKT    IRINI GJONE	SHKALLA 1 : 1000 DATA E REALIZIMIT SHTATOR 2018 FLETA I
	<b>PROJEKTUES SHOQERIA "ERSI"</b>	<b>OBJEKTI: SHKOLLA E MESME PAJOVE "MUSTAFA KEMAL ATATURK"</b>	<b>PLANI KUZ KATI I</b>		
	<b>N R . 3418 / 9 LICENSE</b>	<b>BASHKIA -PEQIN</b>			

INVESTITOR : BASHKIA PEQIN  
**PROJEKT ZBATIMI**

**PLANI I UJESJELLESIT**



**OBJEKTI: RIKONSTRUKSION DHE NDERTIM PALESTRE I SHKOLLES SE MESME PAJOVE  
"MUSTAFA KEMAL ATATURK"**



	<small>"Ersi" - shpk Adresa / Rruga Margarita Tutulani - Tirane Mobil 0.672073098 : e-mail ersi-shpk@hotmail.com / fagoxhaj@hotmail.com</small>	<b>INVESTITORI :BASHKIA PEQIN</b>	<b>PROJEKT - ZBATIMI</b>	INXHINIER KONSTRUKTOR	FATBARDHA GOXHAJ	N R .0265 /9	SHKALLA 1 : 1000
	<b>PROJEKTUES SHOQERIA "ERSI"</b>	<b>OBJEKTI: SHKOLLA E MESME PAJOVE "MUSTAFA KEMAL ATATURK" BASHKIA -PEQIN</b>	<b>SHKOLLA "MUSTAFA KEMAL ATATURK"</b>	INXHINIER KONSTRUKTOR	ENXHI ÇELAJ		DATA E REALIZIMIT SHTATOR 2018
<b>N R . 3418 / 9 LICENSE</b>			INXHINIER HIDROTEKNIK	ANJEZA NEBIJ			FLETA I
			ARKITEKT	SOKOL AGAJ	A.1363/1		
			ARKITEKT	IRINI GJONE			

PLANIMETRIA E KATIT PERDHE E UJESJELLESIT  
SHKOLLA E MESME PAJOVE

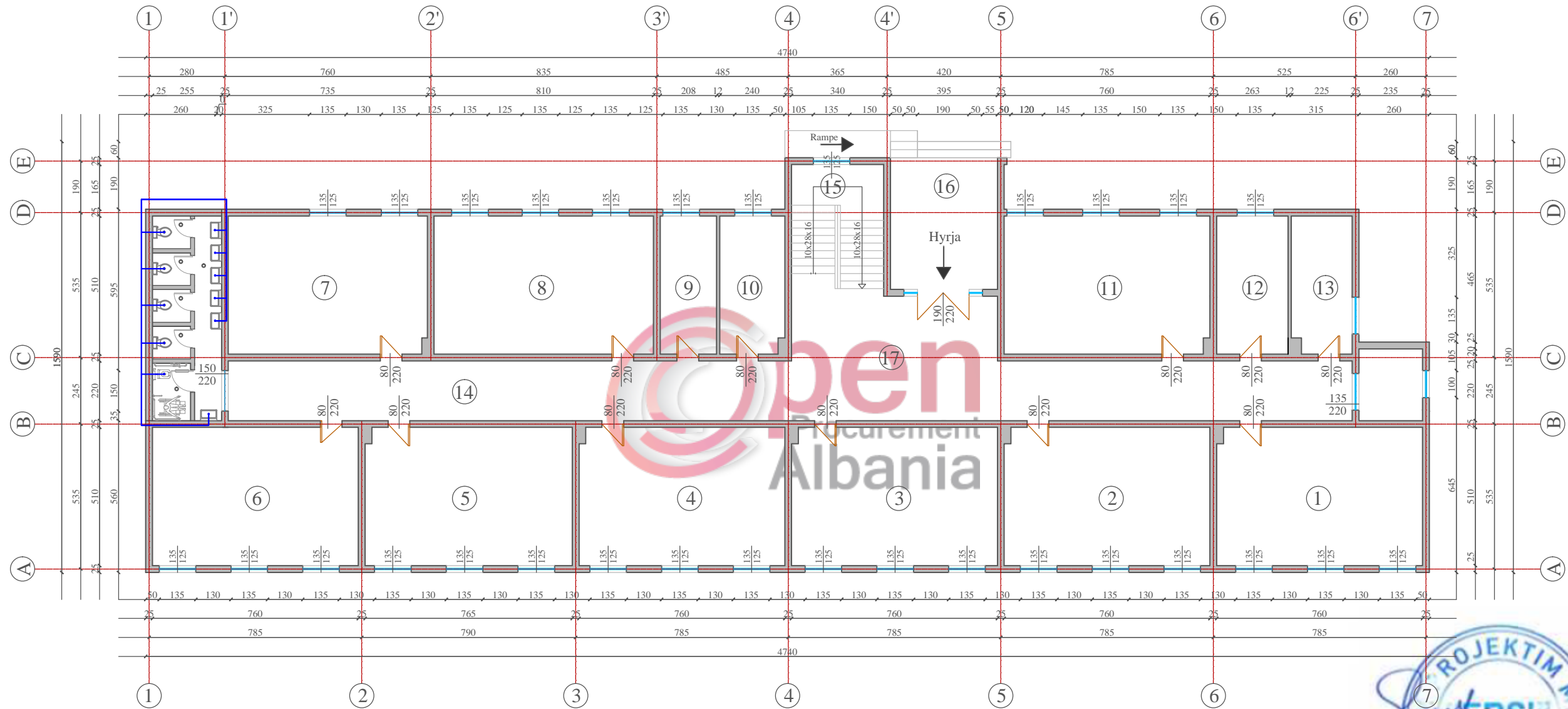

SHKOLLA "MUSTAFA KEMAL ATATURK"

	"Ersi" - shpk Adresa / Rruga Margarita Tutulani - Tirane Mobil 0.672073098 : e - mail ersi-shpk@ hotmail .com / fagoxhaj@hotmail.com	<b>INVESTITORI :BASHKIA PEQIN</b>  <b>OBJEKTI: SHKOLLA E MESME PAJOVE</b> <b>"MUSTAFA KEMAL ATATURK"</b> <b>BASHKIA -PEQIN</b>	<b>PROJEKT - ZBATIMI</b>  <b>PLANI I UJESJELLESIT</b> <b>KATI PERDHE</b>	INXHINIER KONSTRUKTOR      FATBARDHA GOXHAJ      N R .0265 /9	SHKALLA 1 : 1000  DATA E REALIZIMIT SHTATOR 2018  FLETA I
	<b>PROJEKTUES</b> SHOQERIA "ERSI"  <b>N R . 3418 / 9 LICENSE</b>			INXHINIER KONSTRUKTOR      ENXHI ÇELAJ	
				INXHINIER HIDROTEKNIK      ANJEZA NEBAJ	
				ARKITEKT      SOKOL AGAJ      A.1363/1 ARKITEKT      IRINI GJONE	

PLANIMETRIA E KATIT I E UJESJELLESIT  
SHKOLLA E MESME PAJOVE

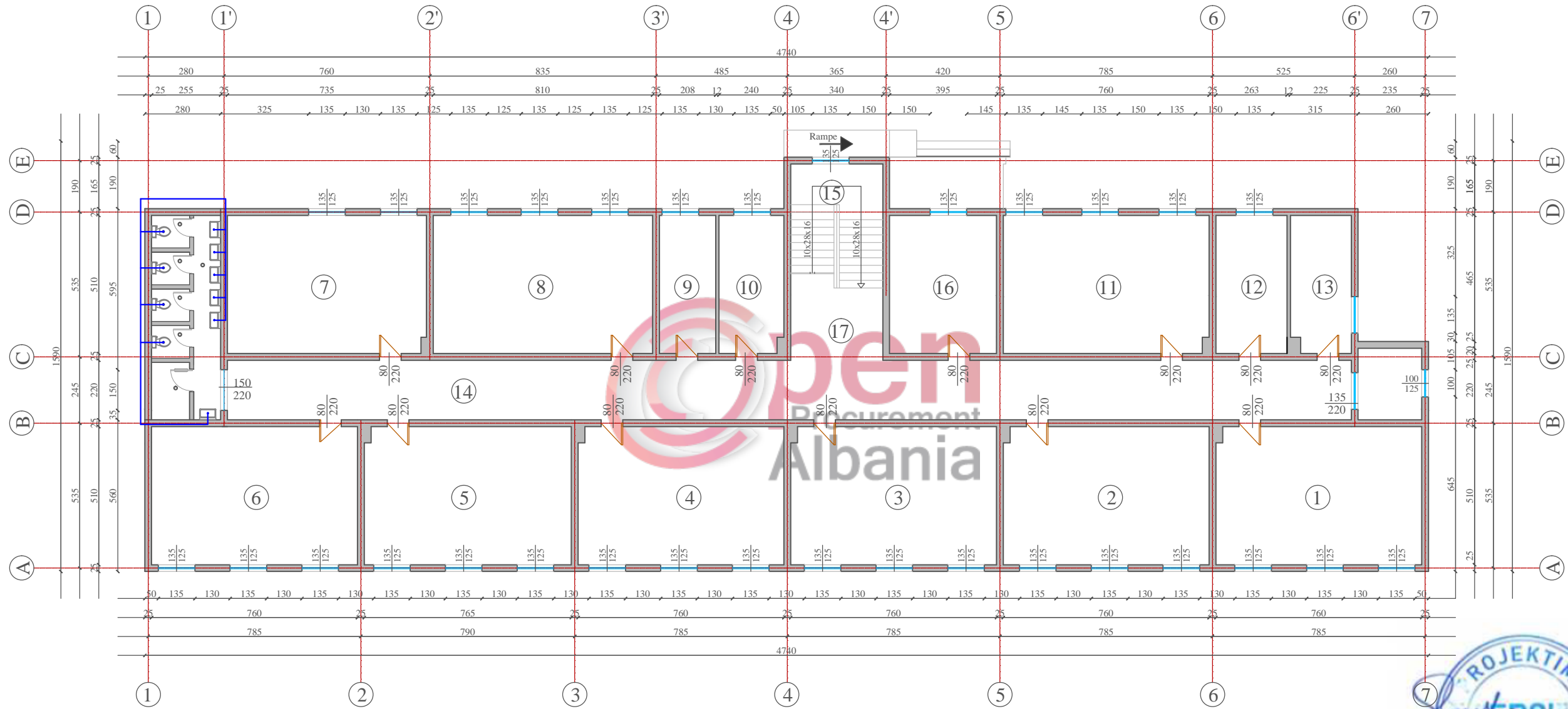

SHKOLLA "MUSTAFA KEMAL ATATURK"

	"Ersi" - shpk Adresa / Rruga Margarita Tutulani - Tirane Mobil 0.672073098 : e - mail ersi-shpk@ hotmail .com / fagoxhaj@hotmail.com	<b>INVESTITORI :BASHKIA PEQIN</b>  <b>OBJEKTI: SHKOLLA E MESME PAJOVE "MUSTAFA KEMAL ATATURK" BASHKIA -PEQIN</b>	<b>PROJEKT - ZBATIMI</b>  <b>PLANI I UJESJELLESIT KATI I</b>		INXHINIER KONSTRUKTOR    FATBARDHA GOXHAJ    N R .0265 /9	SHKALLA 1 : 1000  DATA E REALIZIMIT SHTATOR 2018  FLETA I
	<b>PROJEKTUES</b> SHOQERIA "ERSI"  N R . 3418 / 9 LICENSE				INXHINIER KONSTRUKTOR    ENXHI ÇELAJ	
					INXHINIER HIDROTEKNIK    ANJEZA NEBJAJ	
					ARKITEKT    SOKOL AGAJ    A.1363/1 ARKITEKT    IRINI GJONE	

INVESTITOR : BASHKIA PEQIN  
**PROJEKT ZBATIMI**

**PLANI I LINJES TELEFONI+ INTERNET**



**OBJEKTI: RIKONSTRUKSION DHE NDERTIM PALESTRE I SHKOLLES SE MESME PAJOVE  
 "MUSTAFA KEMAL ATATURK"**



	" Ersi " - shpk Adresa / Rruga Margarita Tutulani - Tirane Mobil 0.672073098 : e - mail ersi-shpk@ hotmail .com / fagoxhaj@hotmail.com	<b>INVESTITORI :BASHKIA PEQIN</b>	<b>PROJEKT - ZBATIMI</b>	INXHINIER KONSTRUKTOR	FATBARDHA GOXHAJ	NR .0265 /9	SHKALLA 1 : 1000
	<b>PROJEKTUES</b> SHOQERIA " ERSI "	<b>OBJEKTI: SHKOLLA E MESME PAJOVE                  "MUSTAFA KEMAL ATATURK"                  BASHKIA -PEQIN</b>	<b>SHKOLLA "MUSTAFA KEMAL ATATURK"</b>	INXHINIER KONSTRUKTOR	ENXHI ÇELAJ		
<b>NR . 3418 / 9 LICENSE</b>			INXHINIER HIDROTEKNIK	ANJEZA NEBIJ			
			ARKITEKT	SOKOL AGAJ	A.1363/1		FLETA I
			ARKITEKT	IRINI GJONE			

**PLANIMETRIA E KATIT PERDHE E LINJES SE TELEFONIT+ INTERNET  
SHKOLLA E MESME PAJOVE**

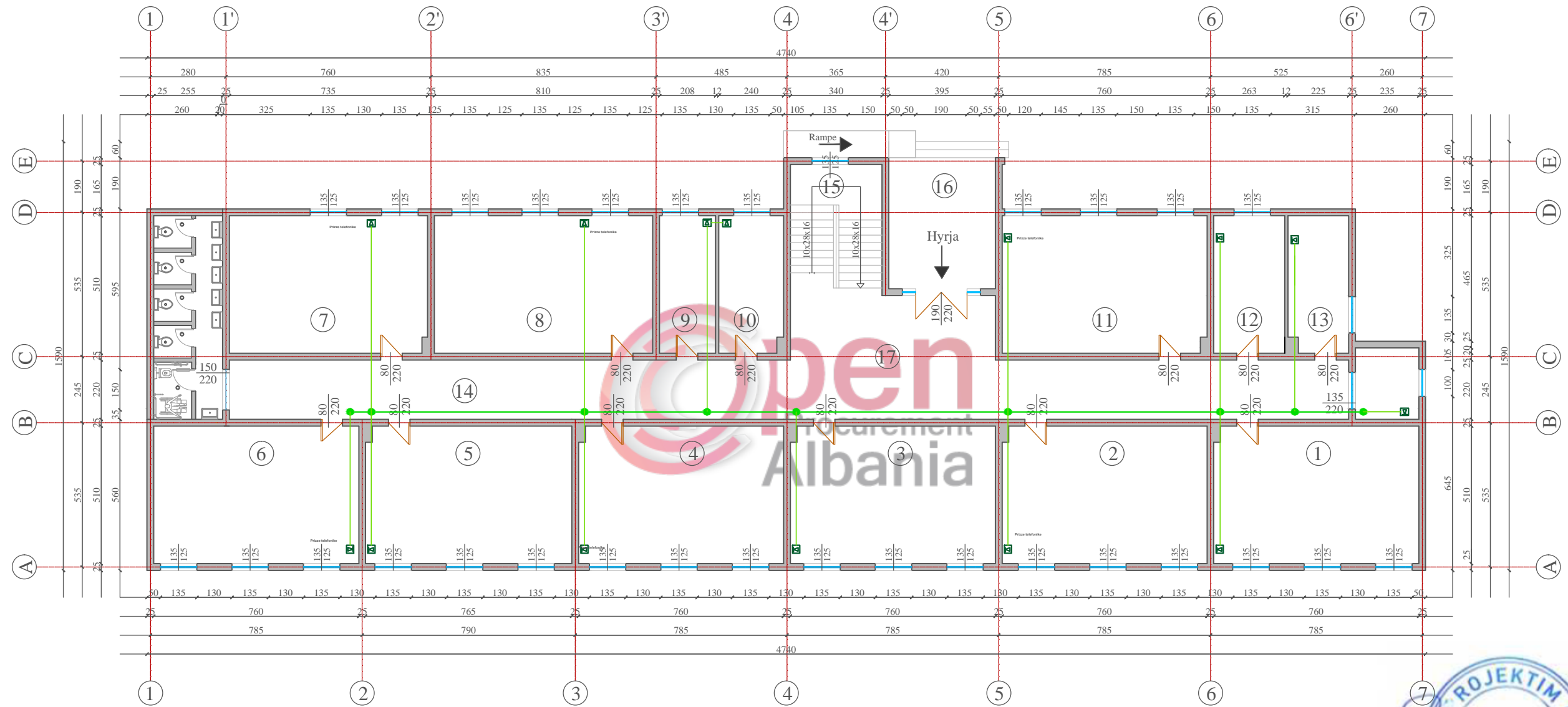

**SHKOLLA "MUSTAFA KEMAL ATATURK"**

	"Ersi" - shpk Adresa / Rruga Margarita Tutulani - Tirane Mobil 0.672073098 : e - mail ersi-shpk@ hotmail .com / fagoxhaj@hotmail.com	<b>INVESTITORI :BASHKIA PEQIN</b>  <b>OBJEKTI: SHKOLLA E MESME PAJOVE "MUSTAFA KEMAL ATATURK" BASHKIA -PEQIN</b>	<b>PROJEKT - ZBATIMI</b>  <b>PLANI I LINJES TELEFONI-INTERNET KATI PERDHE</b>	INXHINIER KONSTRUKTOR      FATBARDHA GOXHAJ      N R .0265 /9	SHKALLA 1 : 1000  DATA E REALIZIMIT SHTATOR 2018  FLETA I
	<b>PROJEKTUES SHOQERIA "ERSI"</b>  <b>N R . 3418 / 9 LICENSE</b>			INXHINIER KONSTRUKTOR      ENXHI ÇELAJ	
				INXHINIER HIDROTEKNIK      ANJEZA NEBIAJ	
				ARKITEKT      SOKOL AGAJ      A.1363/1 ARKITEKT      IRINI GJONE	

**PLANIMETRIA E KATIT TE PARE LINJES SE TELEFONIT+ INTERNET  
SHKOLLA E MESME PAJOVE**

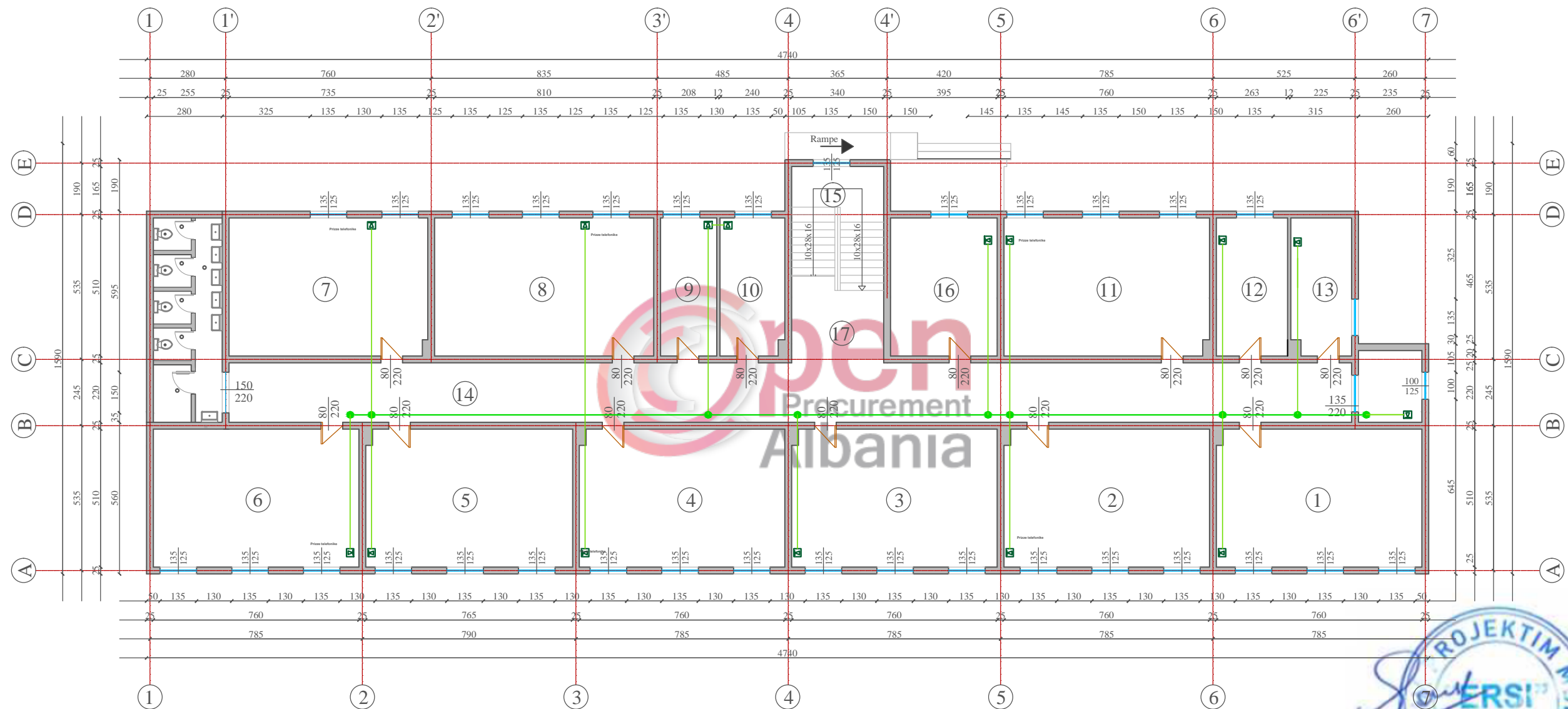

**SHKOLLA "MUSTAFA KEMAL ATATURK"**

	"Ersi" - shpk Adresa / Rruga Margarita Tutulani - Tirane Mobil 0.672073098 : e-mail ersi-shpk@hotmail.com / fagohaj@hotmail.com	<b>INVESTITORI :BASHKIA PEQIN</b>  <b>OBJEKTI: SHKOLLA E MESME PAJOVE "MUSTAFA KEMAL ATATURK" BASHKIA -PEQIN</b>	<b>PROJEKT - ZBATIMI</b>  <b>PLANI I LINJES TELEFONI-INTERNET KATI I</b>	INXHINIER KONSTRUKTOR	FATBARDHA GOXHAJ	N R .0265 /9	SHKALLA 1 : 1000
	<b>PROJEKTUES SHOQERIA "ERSI"</b>  <b>N R . 3418 / 9 LICENSE</b>			INXHINIER KONSTRUKTOR ENXHI ÇELAJ INXHINIER HIDROTEKNIK ANJEZA NEBIAJ ARKITEKT SOKOL AGAJ ARKITEKT IRINI GJONE	A.1363/1		



INVESTITOR : BASHKIA PEQIN  
**PROJEKT ZBATIMI**



**OBJEKTI: RIKONSTRUKSION DHE NDERTIM PALESTRE I SHKOLLES SE MESME PAJOVE  
 "MUSTAFA KEMAL ATATURK"**



	" Ersi " - shpk Adresa / Rruga Margarita Tutulani - Tirane Mobil 0.672073098 : e - mail ersi-shpk@ hotmail .com / fagoxhaj@hotmail.com	<b>INVESTITORI :BASHKIA PEQIN</b>	<b>PROJEKT - ZBATIMI</b>	INXHINIER KONSTRUKTOR	FATBARDHA GOXHAJ	N R .0265 /9	SHKALLA 1 : 1000
	<b>PROJEKTUES</b> SHOQERIA " ERSI "	<b>OBJEKTI: SHKOLLA E MESME PAJOVE                  "MUSTAFA KEMAL ATATURK"                  BASHKIA -PEQIN</b>	SHKOLLA "MUSTAFA KEMAL ATATURK"	INXHINIER KONSTRUKTOR INXHINIER HIDROTEKNIK ARKITEKT ARKITEKT	ENXHI ÇELAJ ANJEZA NEBIJ SOKOL AGAJ IRINI GJONE	A.1363/1	DATA E REALIZIMIT SHTATOR 2018 FLETA I
<b>N R . 3418 / 9 LICENSE</b>							



**SHKOLLA "MUSTAFA KEMAL ATATURK"**



	" Ersi " - shpk Adresa / Rruga Margarita Tutulani - Tirane Mobil 0.672073098 : e - mail ersi-shpk@ hotmail .com / fagoxhaj@hotmail.com	<b>INVESTITORI :BASHKIA PEQIN</b>  <b>OBJEKTI: SHKOLLA E MESME PAJOVE</b> <b>"MUSTAFA KEMAL ATATURK"</b> <b>BASHKIA -PEQIN</b>	<b>PROJEKT - ZBATIMI</b>  <b>PAMJE 3D</b>	INXHINIER KONSTRUKTOR	FATBARDHA GOXHAJ	N.R. 0265/9	SHKALLA 1 : 1000  DATA E REALIZIMIT SHTATOR 2018  FLETA I
	<b>PROJEKTUES</b> SHOQERIA " ERSI "			<b>INXHINIER KONSTRUKTOR</b>	ENXHI ÇELAJ	ARKITEKT	
<b>N R . 3418 / 9 LICENSE</b>				INXHINIER HIDROTEKNIK	ANJEZA NEBIAJ		
				ARKITEKT	IRINI GJONE		



**SHKOLLA "MUSTAFA KEMAL ATATURK"**



	"Ersi" - shpk Adresa / Rruga Margarita Tutulani - Tirane Mobil 0.672073098 : e-mail ersi-shpk@hotmail.com / fagoxhaj@hotmail.com	<b>INVESTITORI :BASHKIA PEQIN</b>  <b>OBJEKTI: SHKOLLA E MESME PAJOVE</b> <b>"MUSTAFA KEMAL ATATURK"</b> <b>BASHKIA -PEQIN</b>	<b>PROJEKT - ZBATIMI</b>  <b>PAMJE 3D</b>	INXHINIER KONSTRUKTOR    FATBARDHA GOXHAJ    N.R. .0265 /9	SHKALLA 1 : 1000  DATA E PRAKTIKIMIT SHTATOR 2018
	<b>PROJEKTUES</b> SHOQERIA "ERSI"  <b>N R . 3418 / 9 LICENSE</b>			INXHINIER KONSTRUKTOR    ENXHI ÇELAJ INXHINIER HIDROTEKNIK    ANJEZA NEBIJ ARKITEKT    SOKOL AGAJ    A.1363/1 ARKITEKT    IRINI GJONE	



**SHKOLLA "MUSTAFA KEMAL ATATURK"**



	"Ersi" - shpk Adresa / Rruga Margarita Tutulani - Tirane Mobil 0.672073098 : e-mail ersi-shpk@hotmail.com / fagoxhaj@hotmail.com	<b>INVESTITORI :BASHKIA PEQIN</b>  <b>OBJEKTI: SHKOLLA E MESME PAJOVE "MUSTAFA KEMAL ATATURK" BASHKIA -PEQIN</b>	<b>PROJEKT - ZBATIMI</b>  <b>PAMJE 3D</b>	INXHINIER KONSTRUKTOR	FATBARDHA GOXHAJ	NR . 0265 /9 SHKALLA 1 : 1000
	<b>PROJEKTUES</b> <b>SHOQERIA "ERSI"</b>  <b>N R . 3418 / 9 LICENSE</b>			INXHINIER KONSTRUKTOR INXHINIER HIDROTEKNIK ARKITEKT ARKITEKT	ENXHI ÇELAJ ANJEZA NEBIJ SOKOL AGAJ IRINI GJONE	



SHKOLLA "MUSTAFA KEMAL ATATURK"



"Ersi" - shpk  
 Adresa / Rruga Margarita Tutulani - Tirane  
 Mobil 0.672073098 : e-mail ersi-shpk@hotmail.com / fagoxhaj@hotmail.com

**PROJEKTUES**  
 SHOQERIA "ERSI"

**N R . 3418 / 9 LICENSE**

**INVESTITORI :BASHKIA PEQIN**

**OBJEKTI: SHKOLLA E MESME PAJOVE  
 "MUSTAFA KEMAL ATATURK"  
 BASHKIA -PEQIN**

**PROJEKT - ZBATIMI**

**PAMJE 3D**

INXHINIER KONSTRUKTOR	FATBARDHA GOXHAJ	N R . 0285 / 9	SHKALLA 1 : 1000
INXHINIER KONSTRUKTOR	ENXHI ÇELAJ		DATA E REALIZIMIT SHTATOR - 2018
INXHINIER HIDROTEKNIK	ANJEZA NEBIJ		
ARKITEKT	SOKOL AGAJ	A.1363/1	
ARKITEKT	IRINI GJONE		FLETA I



**SHKOLLA "MUSTAFA KEMAL ATATURK"**



	"Ersi" - shpk Adresa / Rruga Margarita Tutulani - Tirane Mobil 0.672073098 : e - mail ersi-shpk@ hotmail .com / fagoxhaj@hotmail.com	<b>INVESTITORI :BASHKIA PEQIN</b>  <b>OBJEKTI: SHKOLLA E MESME PAJOVE</b> <b>"MUSTAFA KEMAL ATATURK"</b> <b>BASHKIA -PEQIN</b>	<b>PROJEKT - ZBATIMI</b>  <b>PAMJE 3D</b>	INXHINIER KONSTRUKTOR    FATBARDHA GOXHAJ    N.R. .0265 /9	SHKALLA 1 : 1000  DATA E REALIZIMIT SHTATOR - 2018
	<b>PROJEKTUES</b> SHOQERIA "ERSI"  <b>N R . 3418 / 9 LICENSE</b>			INXHINIER KONSTRUKTOR    ENXHI ÇELAJ INXHINIER HIDROTEKNIK    ANJEZA NEBIJ ARKITEKT    SOKOL AGAJ    A.1368/1 ARKITEKT    IRINI GJONE	



**SHKOLLA "MUSTAFA KEMAL ATATURK"**

	"Ersi" - shpk Adresa / Rruga Margarita Tutulani - Tirane Mobil 0.672073098 : e-mail ersi-shpk@hotmail.com / fagoxhaj@hotmail.com	<b>INVESTITORI :BASHKIA PEQIN</b>  <b>OBJEKTI: SHKOLLA E MESME PAJOVE</b> <b>"MUSTAFA KEMAL ATATURK"</b> <b>BASHKIA -PEQIN</b>	<b>PROJEKT - ZBATIMI</b>  <b>PAMJE 3D</b>	INXHINIER KONSTRUKTOR    FATBARDHA GOXHAJ    NR .0265/9/	SHKALLA 1 : 1000  DATA E REALIZIMIT SHTATOR 2018
	<b>PROJEKTUES</b> SHOQERIA "ERSI"  <b>N R . 3418 / 9 LICENSE</b>			INXHINIER KONSTRUKTOR    ENXHI ÇELAJ INXHINIER HIDROTEKNIK    ANJEZA NEBIAJ ARKITEKT    SOKOL AGAJ    A.1363/1 ARKITEKT    IRINI GJONE	





SHKOLLA "MUSTAFA KEMAL ATATURK"

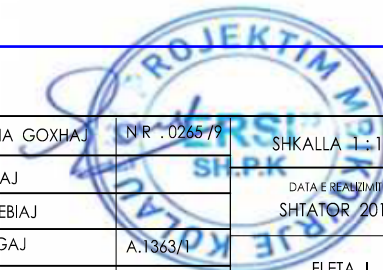

	" Ersi " - shpk Adresa / Rruga Margarita Tutulani - Tirane Mobil 0.672073098 : e - mail ersi-shpk@ hotmail .com / fagoxhaj@hotmail.com	<b>INVESTITORI :BASHKIA PEQIN</b>	<b>PROJEKT - ZBATIMI</b>	INXHINIER KONSTRUKTOR    FATBARDHA GOXHAJ    N.R . 0265 /9	SHKALLA 1 : 1000
	<b>PROJEKTUES</b> SHOQERIA " ERSI "	<b>OBJEKTI: SHKOLLA E MESME PAJOVE</b> <b>"MUSTAFA KEMAL ATATURK"</b> <b>BASHKIA -PEQIN</b>	<b>PAMJE 3D</b>	INXHINIER KONSTRUKTOR    ENXHI ÇELAJ INXHINIER HIDROTEKNIK    ANJEZA NEBIAJ ARKITEKT    SOKOL AGAJ ARKITEKT    IRINI GJONE	DATA E REANIMI SHTATOR 2018
<b>N R . 3418 / 9 LICENSE</b>				A.1363/1	FLETA I



INVESTITOR : BASHKIA PEQIN  
**PROJEKT ZBATIMI**



**OBJEKTI: RIKONSTRUKSION DHE NDERTIM PALESTRE I SHKOLLES SE MESME PAJOVE  
 "MUSTAFA KEMAL ATATURK"**



	" Ersi " - shpk Adresa / Rruga Margarita Tutulani - Tirane Mobil 0.672073098 : e - mail ersi-shpk@ hotmail .com / fagoxhaj@hotmail.com	<b>INVESTITORI :BASHKIA PEQIN</b>	<b>PROJEKT - ZBATIMI</b>	INXHINIER KONSTRUKTOR	FATBARDHA GOXHAJ	N R . 0265 /9	SHKALLA 1 : 1000
	<b>PROJEKTUES</b> SHOQERIA " ERSI "	<b>OBJEKTI: SHKOLLA E MESME PAJOVE                  "MUSTAFA KEMAL ATATURK"                  BASHKIA -PEQIN</b>	<b>SHKOLLA "MUSTAFA KEMAL ATATURK"</b>	INXHINIER KONSTRUKTOR INXHINIER HIDROTEKNIK ARKITEKT ARKITEKT	ENXHI ÇELAJ ANJEZA NEBIJ SOKOL AGAJ IRINI GJONE	A.1363/1	DATA E REALIZIMIT SHTATOR 2018 FLETA I
<b>N R . 3418 / 9 LICENSE</b>							

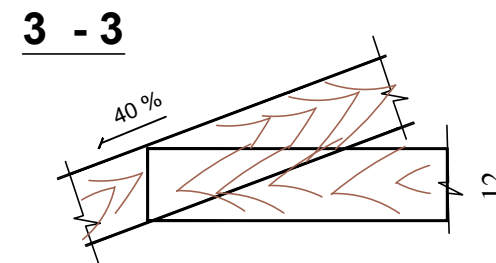
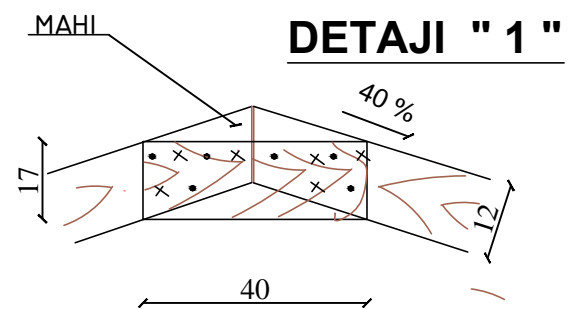

**DETAILI " 3 "**

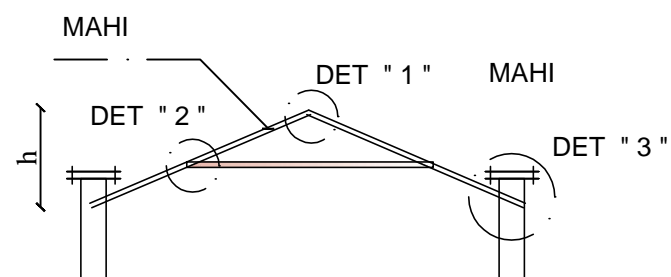
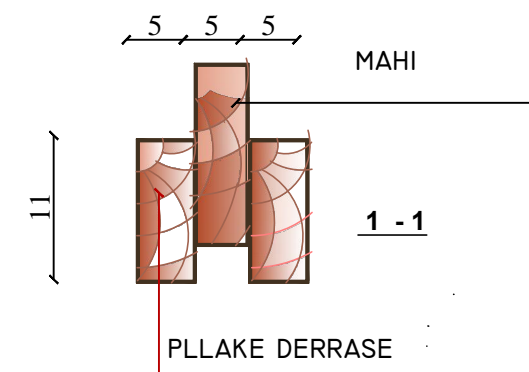
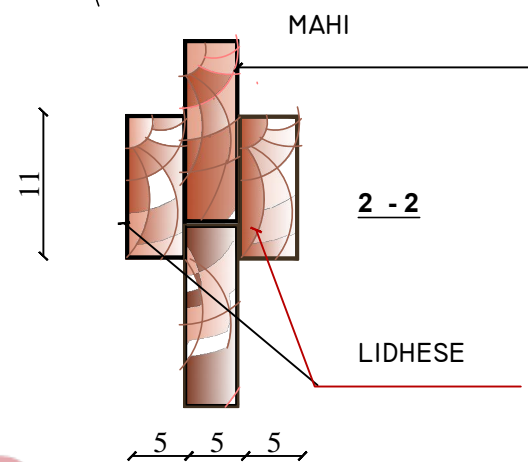
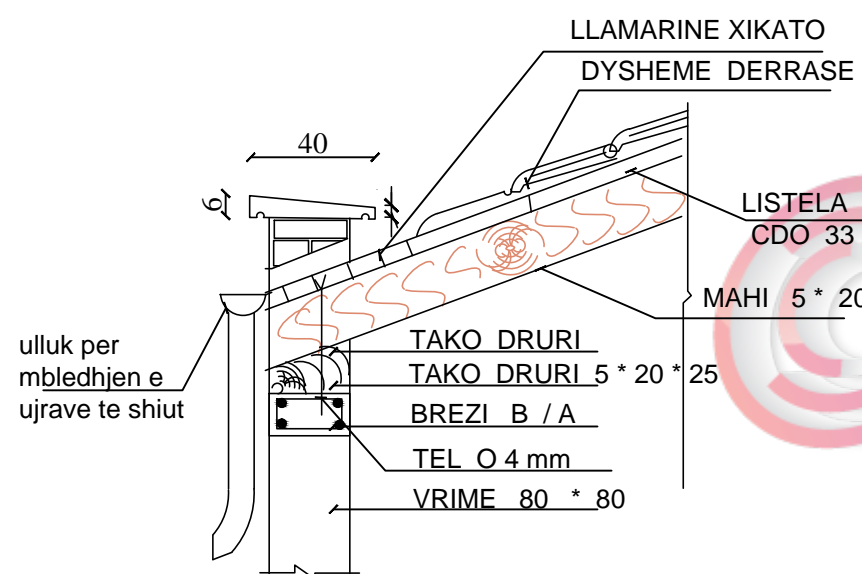

**SHKOLLA "MUSTAFA KEMAL ATATURK"**



	"Ersi" - shpk Adresa / Rruga Margarita Tutulani - Tirane Mobil 0.672073098 : e-mail ersi-shpk@hotmail.com / fagoxhaj@hotmail.com	<b>INVESTITORI :BASHKIA PEQIN</b>	<b>PROJEKT - ZBATIMI</b>	INXHINIER KONSTRUKTOR	FATBARDHA GOXHAJ	NR. 0265/9	SHKALLA 1:1000
	<b>PROJEKTUES</b> SHOQERIA "ERSI" <b>N R . 3418 / 9 LICENSE</b>	<b>OBJEKTI: SHKOLLA E MESME PAJOVE</b> <b>"MUSTAFA KEMAL ATATURK"</b> <b>BASHKIA -PEQIN</b>	<b>DETAJE TE CATISE</b>	INXHINIER KONSTRUKTOR INXHINIER HIDROTEKNIK ARKITEKT ARKITEKT	ENXHI ÇELAJ ANJEZA NEBIJ SOKOL AGAJ IRINI GJONE	A.1363/1	DATA E PRAKTIKIMIT SHTATOR 2018 FLETA I

# PRERJE E DRITARES

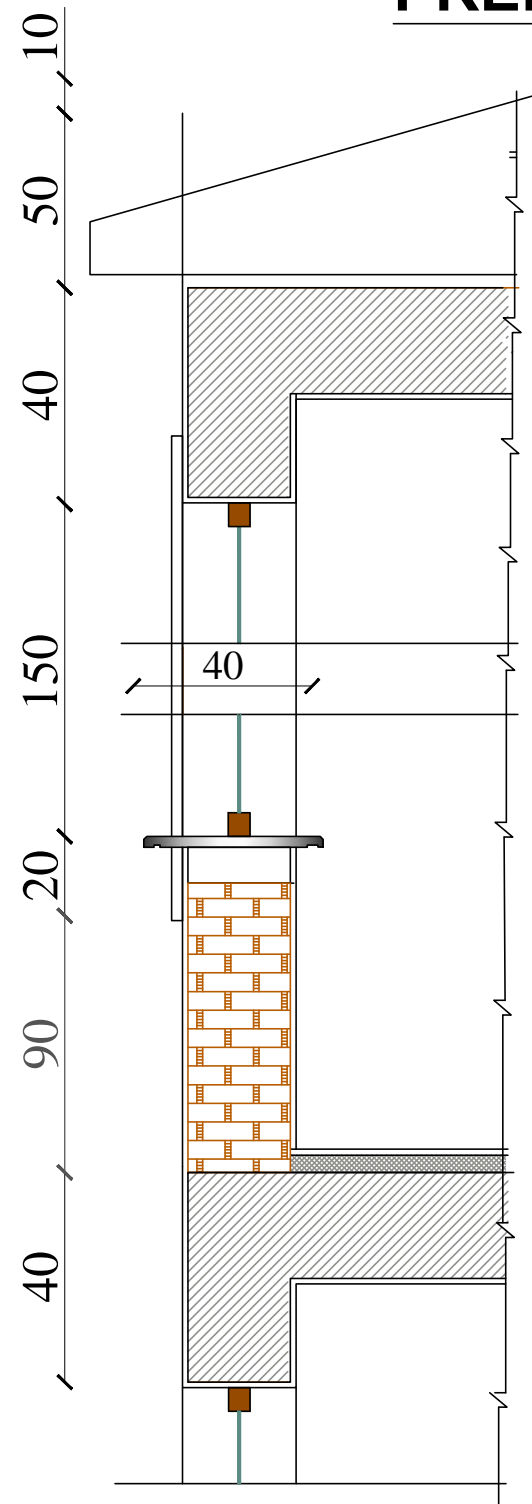

## PAMJE DRITARE D - 1

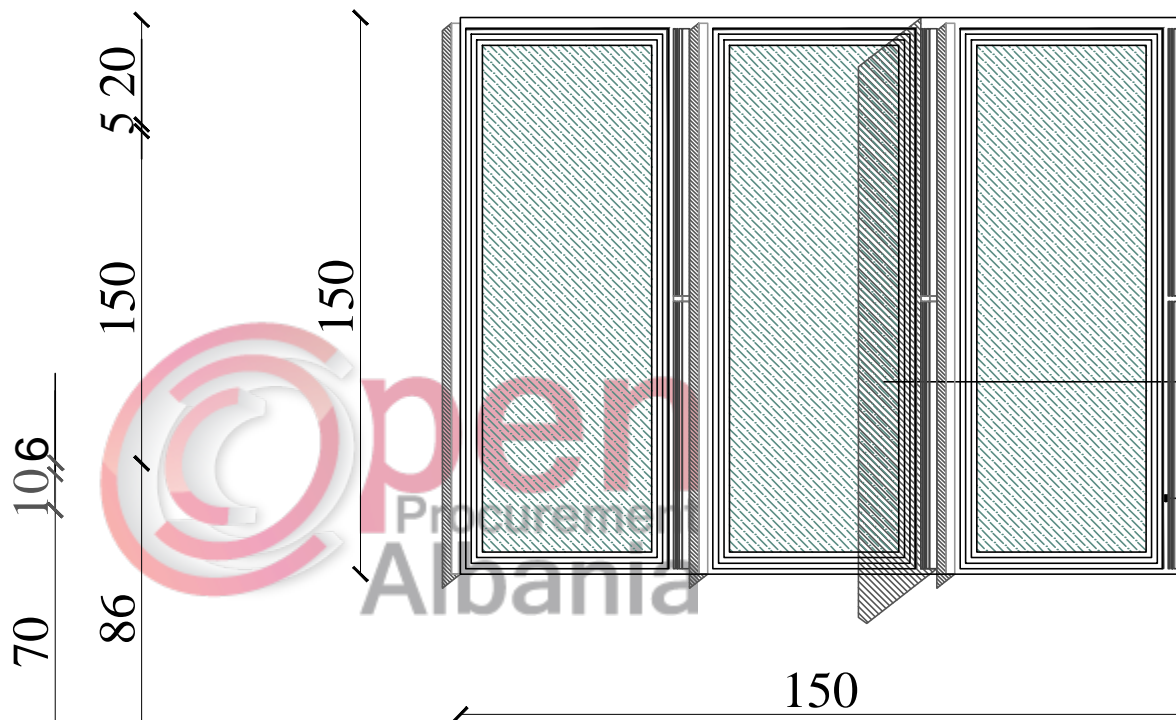

GOMINE  
PROFIL METALIK  
XHAM ME OPACITET 100%

Dritaret do te jene me profile duralumini me spesor 4 \*8 cm Xhamat do te jene me trashesi 2.5 mm dhe distance 5 mm nga njeri tjetri. Xhamat do te jene gomina ne te dy anet ku bashkohen me profilin, Xhamat do te jene me opacitet 100 %.

### SHKOLLA "MUSTAFA KEMAL ATATURK"



"Ersi" - shpk  
Adresa / Rruga Margarita Tutulani - Tirane  
Mobil 0.672073098 : e-mail ersi-shpk@hotmail.com / fagoxhaj@hotmail.com

**PROJEKTUES**  
SHOQERIA "ERSI"

**N R . 3418 / 9 LICENSE**

**INVESTITORI : BASHKIA PEQIN**

**OBJEKTI: SHKOLLA E MESME PAJOVE**  
**"MUSTAFA KEMAL ATATURK"**  
**BASHKIA -PEQIN**

**PROJEKT - ZBATIMI**

**DETAJE TE DRITARES**

INXHINIER KONSTRUKTOR	FATBARDHA GOXHAI	N R . 0265 / 9
INXHINIER KONSTRUKTOR	ENXHI ÇELAJ	
INXHINIER HIDROTEKNIK	ANJEZA NEBIAJ	
ARKITEKT	SOKOL AGAJ	A.1363/1
ARKITEKT	IRINI GJONE	

SHKALLA 1 : 1000

DATA E REALIZIMIT  
SHTATOR 2018

FLETA I