

# RIKUALIFIKIM URBAN DHE KRIJIMI I AMBJENTEVE TE REKREACIONIT NE FSHATRRAT :

DRENOVICE, SAMATICE, **DONOFROSE**, REREZ, POLIZHAN, GAJDE, ARREZ, SKREVAN, BISTROVICE, KUC.





# GJENDJA EGZISTUESE/ SHESI I FSHATIT 'DONOFROSE'

REPUBLIKA E SHQIPËRISË  
AGJENCIA E ZHVILLIMIT TE TERRITORIT



Klienti: BASHKIA URA VAJGURE  
Financues: BASHKIA URA VAJGURE

Projekt:  
Projekt/Preventiva zbatimi **DONOFROSE**

**RIKUALIFIKIM URBAN DHE KRIJIMI I AMBJENTEVE TE REKREACIONIT NE FSHATRA :**

DRENOVICE, SAMATICE, DONOFROSE, REREZ, POLIZHAN, GAJDE, ARREZ, SKREVAN, BISTROVICE, KUC.

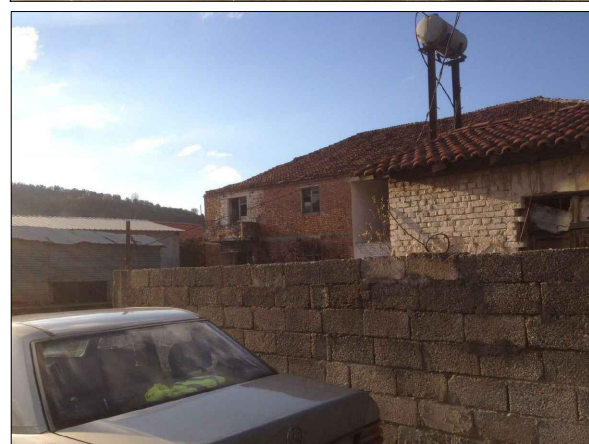

sip,shfrytezueshme aktuale .....m2.

Emertimi fletes:

FOTO TE GJENDJES EGZISTUESE

Aprovimi Klientit Fleta Nr.: ARCH 02

Date: JANAR 2018

Projektuar dhjetor.2017 H&S.BOLLANO

1:500 ne format A3 Size

Vendodhja e objektit

**URA VAJGURE**

DREJTORIA E PLANIFIKIMIT TE TERRITORIT BASHKIA URA VAJGURE

Projektoi: **H&S PROJECT OS**  
ARCHITECTURE & DESIGN  
Nr.Lic. N.6811/1

Grupi Projektimit:

Ark. HERAKLE BOLLANO **H&S** Ark. SABINA BOLLANO  
Perpunoi: Ark.LEONARD BUSHI & Ark.ENE MANOKU  
Konstruktores: Ing. VANGJEL LOLI Ing.  
Ing.Hid/sanit: Ing. ALBERT SHIRA & Ing.ARTAN DERSHA  
Nrohje/Ventil: Ing. ALBERT SHIRA  
Ing. Elektrik: Ing. ANASTAS KOKA  
Ing. MKZ: Ing. ALBERT SHIRA & Ing.ARTAN DERSHA

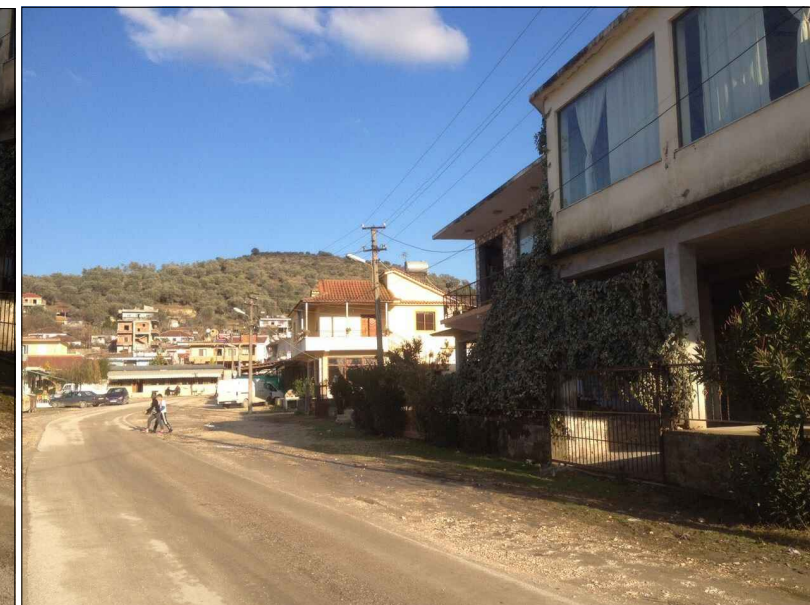
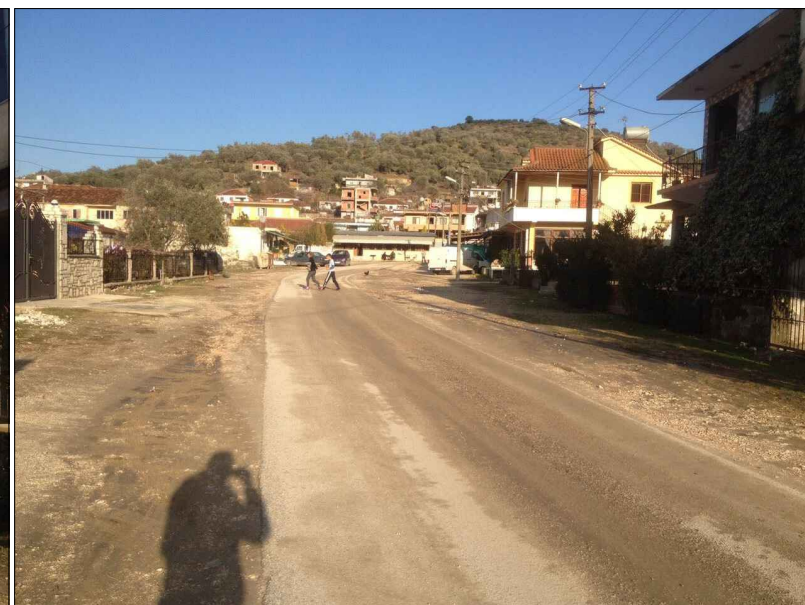
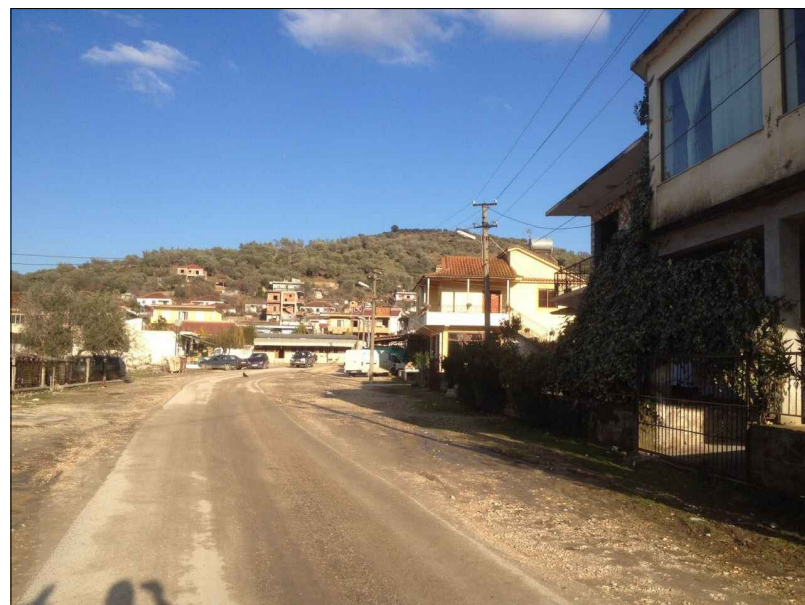

# PLANSISTEMIMI / SHESHI I FSHATIT 'DONOFROSE'

SHKALLA 1:200

REPUBLIKA E SHQIPËRISË  
AGJENCIA E ZHVILLIMIT TE TERRITORIT



Klienti: BASHKIA URA VAJGURE  
Financues: BASHKIA URA VAJGURE

Projekt:  
Projekt/Preventiva zbatimi **DONOFROSE**

**RIKUALIFIKIM URBAN DHE KRIJIMI I AMBJENTEVE TE REKREACIONIT NE FSHATRA T :**

DRENOVICE, SAMATICE, DONOFROSE, REREZ, POLIZHAN, GAJDE, ARREZ, SKREVAN, BISTROVICE, KUC.



sip.shfrytëzueshme aktuale .....m2.

Emertimi fletes:

PLANSISTEMIMI I SHESHIT

Aprovimi Klientit Fleta Nr.: ARCH 03

Date: JANAR 2018

Projektuar dhjetor.2017 H&S.BOLLANO

1:200 ne format A3 Size

Vendodhja e objektit

**URA VAJGURE**

DREJTORIA E PLANIFIKIMIT TE TERRITORIT BASHKIA URA VAJGURE

Projektoi:



Nr.Lic. N.6811/1

Grupi Projektimit:

Ark. HERAKLE BOLLANO  Ark. SABINA BOLLANO  
Perpunoi: Ark.LEONARD BUSHI & Ark.ENEJA MANOKU  
Konstruktores: Ing. VANGJEL LOLI Ing.  
Ing.Hid/sanit: Ing. ALBERT SHIRA & Ing.ARTAN DERSHA  
Nrohje/Ventil: Ing. ALBERT SHIRA  
Ing. Elektrik: Ing. ANASTAS KOKA  
Ing. MKZ: Ing. ALBERT SHIRA & Ing.ARTAN DERSHA



# PLANIMETRIT E NDERHYRJEVE/ SHESHI I FSHATIT 'DONOFROSE'

SHKALLA 1:200

REPUBLIKA E SHQIPËRIË  
AGJENCIA E ZHVILLIMIT TE TERRITORIT



Klienti: BASHKIA URA VAJGURORE  
Financues: BASHKIA URA VAJGURORE

Projekt:  
Projekt/Preventiva zbatimi **DONOFROSE**

**RIKUALIFIKIM URBAN DHE KRIJIMI I AMBJENTEVE TE REKREACIONIT NE FSHATRAT :**

DRENOVICE, SAMATICE, DONOFROSE, REREZ, POLIZHAN, GAJDE, ARREZ, SKREVAN, BISTROVICE, KUC.



sip,shfrytezueshme aktuale .....m2.

Emertimi fletes:  
**PLANIMETRIT E NDERHYRJEVE TE SHESHIT**  
Aprovimi Klientit      Fleta Nr.: ARCH 04  
Date: JANAR 2018

Projektuar      dhjetor.2017      H&S.BOLLANO  
1:200      ne format A3 Size

Vendodhja e objektit  
**URA VAJGURORE**  
DREJTORIA E PLANIFIKIMIT TE TERRITORIT      BASHKIA URA VAJGURORE

Projektoi: **H&S PROJECT 05**  
ARCHITECTURE + DESIGN  
Nr.Lic. N.6811/1

Grupi Projektimit:  
Ark. HERAKLE BOLLANO      **H&S**      Ark. SABINA BOLLANO  
Perpunoi: Ark.LEONARD BUSHI & Ark.ENEA MANOKU  
Konstruktore: Ing. VANGJEL LOLI      Ing.  
Ing.Hid/sanit: Ing. ALBERT SHIRA      & Ing.ARTAN DERSHA  
Nrohje/Ventil: Ing. ALBERT SHIRA  
Ing. Elektrik: Ing. ANASTAS KOKA  
Ing. MKZ: Ing. ALBERT SHIRA      & Ing.ARTAN DERSHA

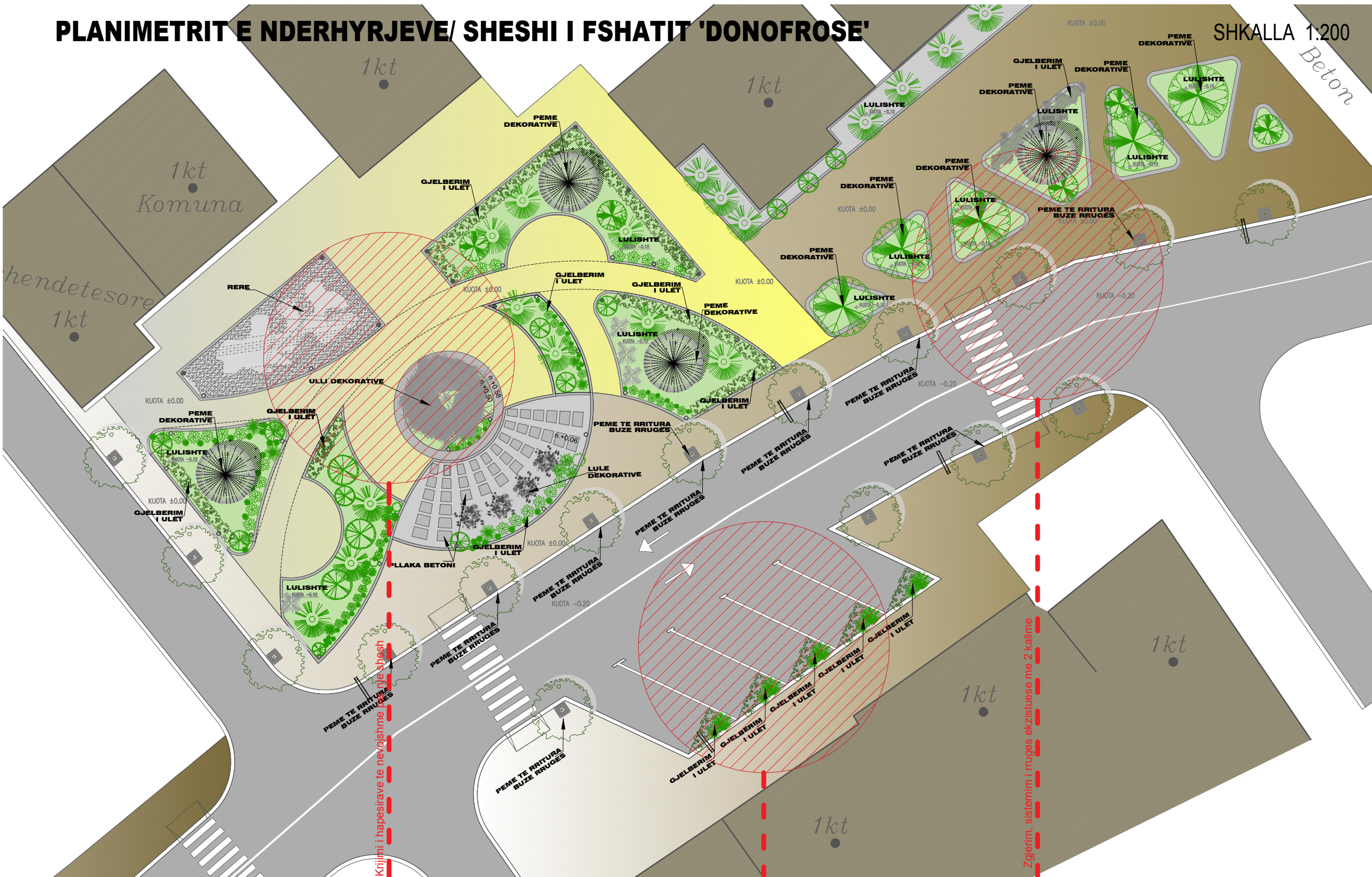

Krijimi i hapësirave të nevojshme për grumbullime dhe evenimente të ndryshme.

Krijimi i hapësirave të prstatshme për fëmijet si dhe vende lojrash  
Hapësira rekreative të prstatshme për të gjitha grupmoshat



Krijimi i vendparkimeve të reja të cilat do jone në funksion të sheshit dhe hapësirave të tjera të shërbimit duke i dhënë me shumë funksionalitet zones.



Kemi zgjeruar dhe sistemuar rrugën, krijimin e trotuareve të përshtatshme si dhe kemi nderhyrë në gjelberimin dhe ndricimin e rrugës në të dy krahet e saj.

# PLANIMETRIT E PROPOZUARA TEKNIKE / SHESHI I FSHATIT 'DONOFROSE'

SHKALLA 1:100

REPUBLIKA E SHQIPËRISË  
AGJENCIA E ZHVILLIMIT TE TERRITORIT



Klienti: BASHKIA URA VAJGURORE  
Financues: BASHKIA URA VAJGURORE

Projekt:  
Projekt/Preventiva zbatimi **DONOFROSE**

**RIKUALIFIKIM URBAN DHE KRIJIMI I AMBJENTEVE TE REKREACIONIT NE FSHATRAT :**  
DRENOVICE, SAMATICE, DONOFROSE, REREZ, POLIZHAN, GAJDE, ARREZ, SKREVAN, BISTROVICE, KUC.

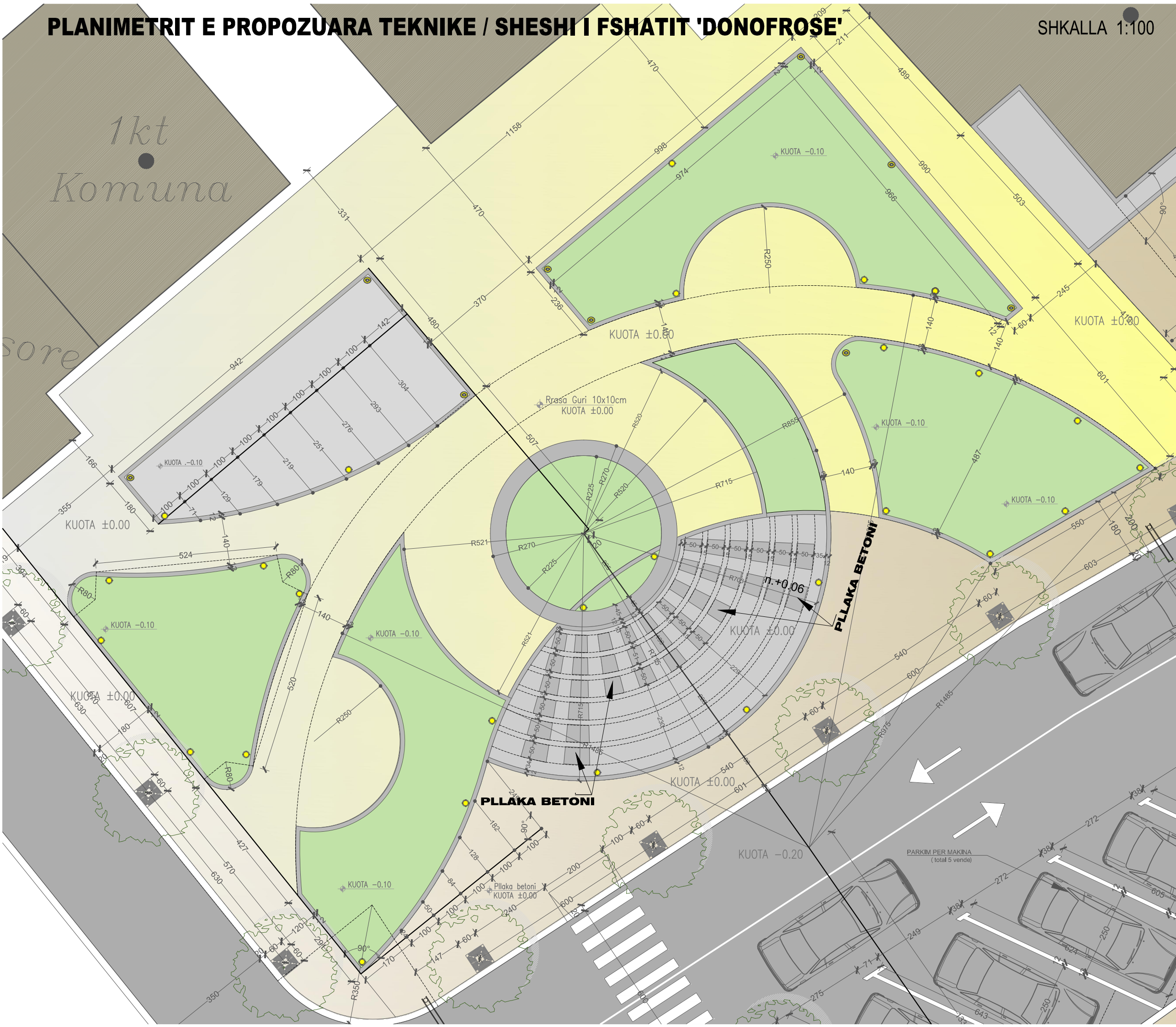

sip,shfrytezueshme aktuale .....m2.

Emertimi fletes:  
**PLANIMETRIT E PROPOZUARA TEKNIKE**  
Aprovimi Klientit      Fleta Nr.: ARCH 05/1  
Date: JANAR 2018

Projektuar      dhjetor.2017      H&S.BOLLANO  
1:100      ne format A3 Size

Vendodhja e objektit  
**URA VAJGURORE**  
DREJTORIA E PLANIFIKIMIT TE TERRITORIT      BASHKIA URA VAJGURORE

Projektoi: **H&S PROJECT 05**  
ARCHITECTURE & DESIGN  
Nr.Lic. N.6811/1

Grupi Projektimit:  
Ark. HERAKLE BOLLANO      **H&S**      Ark. SABINA BOLLANO  
Perpunoi: Ark.LEONARD BUSHI & Ark.ENEJA MANOKU  
Konstruktores: Ing. VANGJEL LOLI      Ing.  
Ing.Hid/sanitet: Ing. ALBERT SHIRA      & Ing.ARTAN DERSHA  
Nrohje/Ventil: Ing. ALBERT SHIRA  
Ing. Elektrik: Ing. ANASTAS KOKA  
Ing. MKZ: Ing. ALBERT SHIRA      & Ing.ARTAN DERSHA

# PLANIMETRIT E PROPOZUARA TEKNIKE / SHESI I FSHATIT 'DONOFROSE'

SHKALLA 1:100

REPUBLIKA E SHQIPËRISË  
AGJENCIA E ZHVILLIMIT TE TERRITORIT



Klienti: BASHKIA URA VAJGURE  
Financues: BASHKIA URA VAJGURE

Projekt:  
Projekt/Preventiva zbatimi **DONOFROSE**

**RIKUALIFIKIM URBAN DHE KRIJIMI I AMBJENTEVE TE REKREACIONIT NE FSHATËRAT :**

DRENOVICE, SAMATICE, DONOFROSE, REREZ, POLIZHAN, GAJDE, ARREZ, SKREVAN, BISTROVICE, KUC.

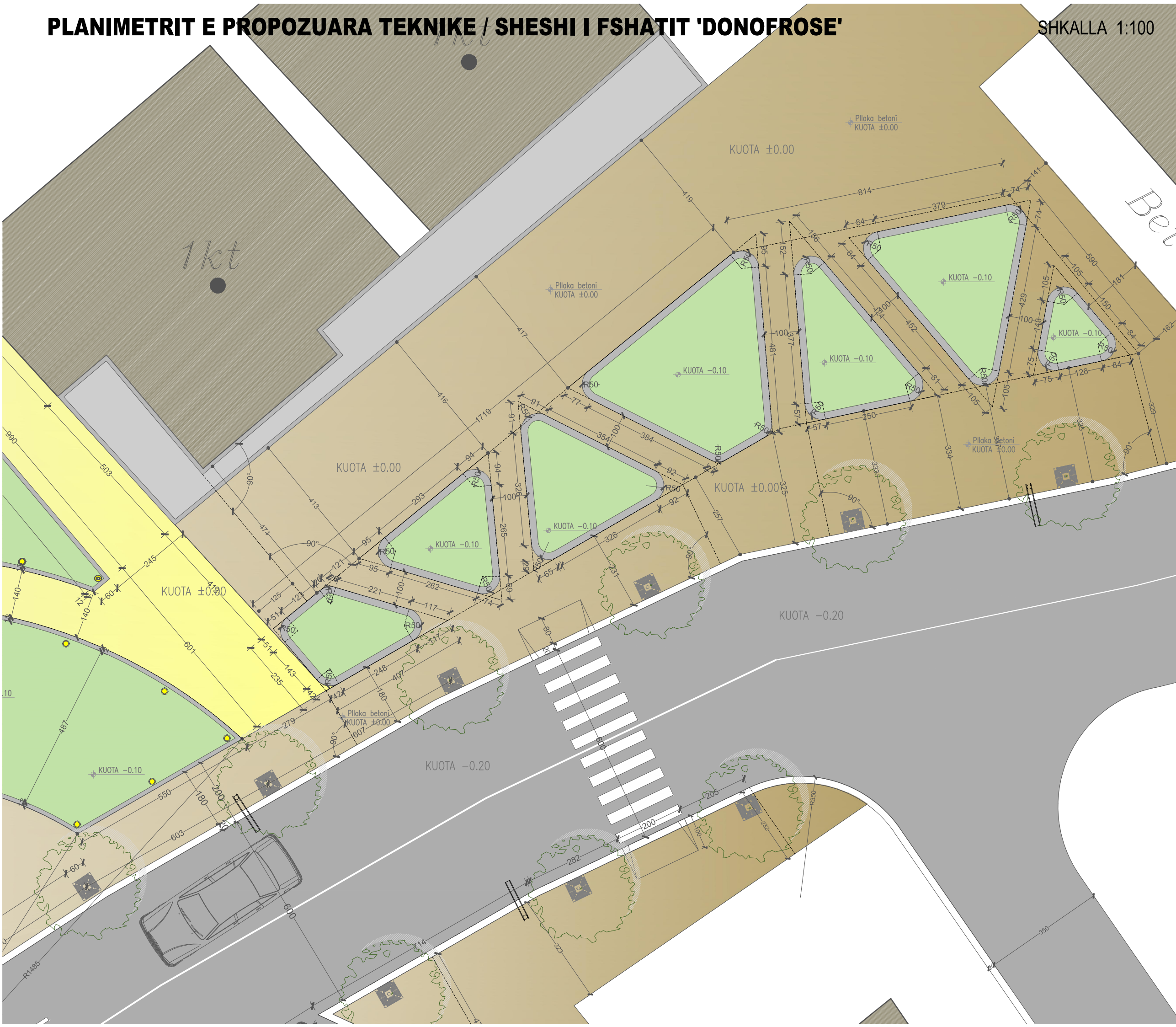

sip,shfrytezueshme aktuale .....m2.

Emertimi fletes:  
**PLANIMETRIT E PROPOZUARA TEKNIKE**  
Aprovimi Klientit Fleta Nr.: ARCH 05/2  
Date: JANAR 2018

Projektuar dhjetor.2017 H&S.BOLLANO  
1:100 ne format A3 Size

Vendodhja e objektit  
**URA VAJGURE**  
DREJTORIA E PLANIFIKIMIT TE TERRITORIT BASHKIA URA VAJGURE

Projektoi: **H&S PROJECT 05**  
Nr.Lic. N.6811/1

Grupi Projektimit:  
Ark. HERAKLE BOLLANO **H&S** Ark. SABINA BOLLANO  
Perpunoi: Ark.LEONARD BUSHI & Ark.ENE MANOKU  
Konstruktores: Ing. VANGJEL LOLI Ing.  
Ing.Hid/sanit: Ing. ALBERT SHIRA & Ing.ARTAN DERSHA  
Nrohje/Ventil: Ing. ALBERT SHIRA  
Ing. Elektrik: Ing. ANASTAS KOKA  
Ing. MKZ: Ing. ALBERT SHIRA & Ing.ARTAN DERSHA

# PLANIMETRIT E PROPOZUARA TEKNIKE / SHESI I FSHATIT 'DONOFROSE'

SHKALLA 1:75

REPUBLIKA E SHQIPËRISË  
AGJENCIA E ZHVILLIMIT TE TERRITORIT



Klienti: BASHKIA URA VAJGURE  
Financues: BASHKIA URA VAJGURE

Projekt:  
Projekt/Preventiva zbatimi **DONOFROSE**

**RIKUALIFIKIM URBAN DHE KRIJIMI I AMBJENTEVE TE REKREACIONIT NE FSHATRAZAT :**

DRENOVICE, SAMATICE, DONOFROSE, REREZ, POLIZHAN, GAJDE, ARREZ, SKREVAN, BISTROVICE, KUC.



sip,shfrytezueshme aktuale .....m2.

Emertimi fletes:

PLANIMETRIT E PROPOZUARA TEKNIKE

Aprovimi Klientit Fleta Nr.: ARCH 05/3

Date: JANAR 2018

Projektuar dhjetor.2017 H&S.BOLLANO

1:75 ne format A3 Size

Vendodhja e objektit

**URA VAJGURE**

DREJTORIA E PLANIFIKIMIT TE TERRITORIT BASHKIA URA VAJGURE

Projektoi:



Nr.Lic. N.6811/1

Grupi Projektimit:

Ark. HERAKLE BOLLANO  Ark. SABINA BOLLANO

Perpunoi: Ark.LEONARD BUSHI & Ark.ENEA MANOKU

Konstruktore: Ing. VANGJEL LOLI Ing.

Ing.Hid/sanit: Ing. ALBERT SHIRA & Ing.ARTAN DERSHA

Nrohje/Ventil: Ing. ALBERT SHIRA

Ing. Elektrik: Ing. ANASTAS KOKA

Ing. MKZ: Ing. ALBERT SHIRA & Ing.ARTAN DERSHA

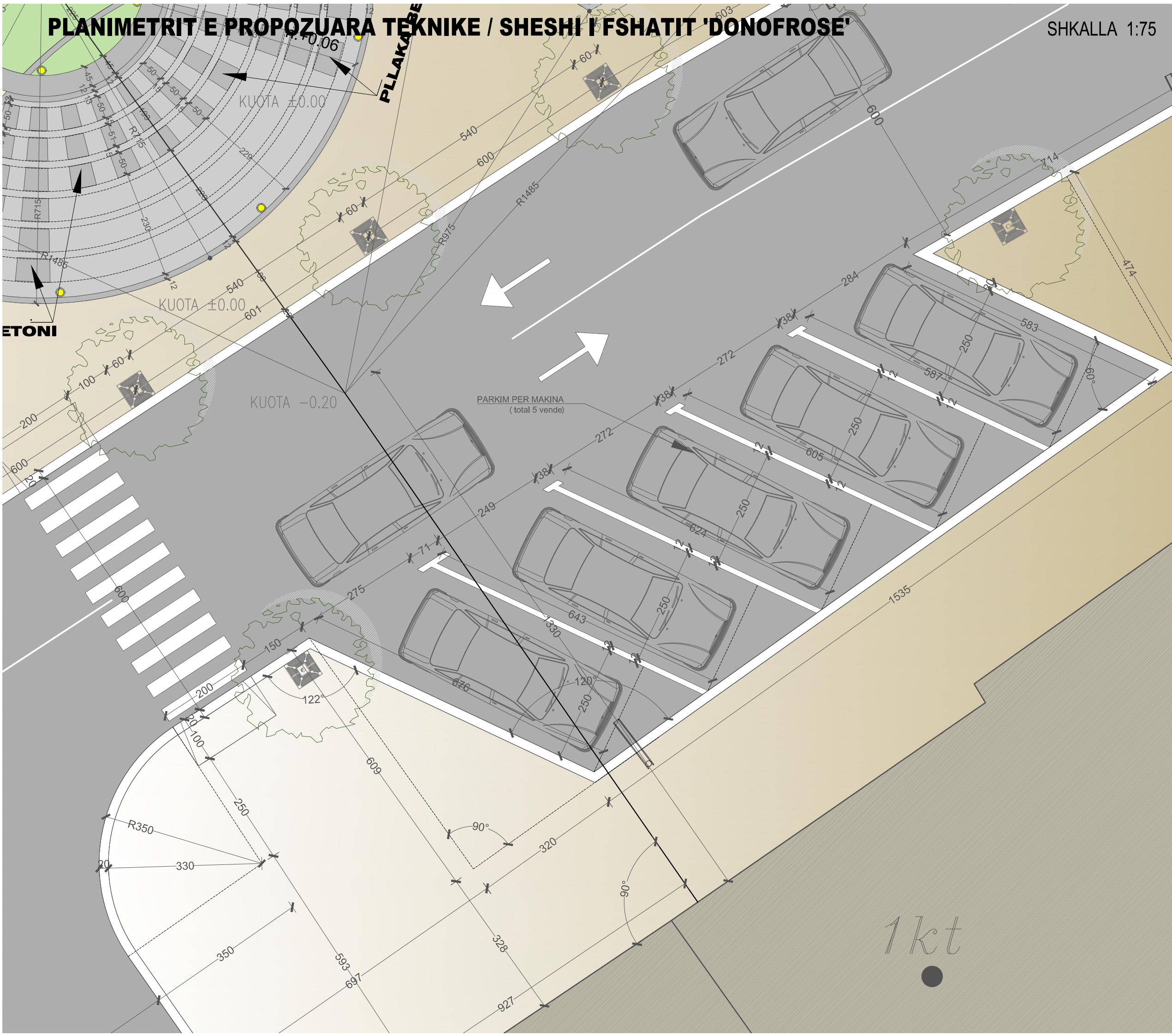





# PLANI I GJELBERIMIT / SHESHI I FSHATIT 'DONOFROSE'

SHKALLA 1:200

REPUBLIKA E SHQIPËRISË  
AGJENCIA E ZHVILLIMIT TE TERRITORIT



Klienti: BASHKIA URA VAJGURORE  
Financues: BASHKIA URA VAJGURORE

Projekt:  
Projekt/Preventiva zbatimi **DONOFROSE**

**RIKUALIFIKIM URBAN DHE KRIJIMI I AMBJENTEVE TE REKREACIONIT NE FSHATRAT :**  
DRENOVICE, SAMATICE, DONOFROSE, REREZ, POLIZHAN, GAJDE, ARREZ, SKREVAN, BISTROVICE, KUC.

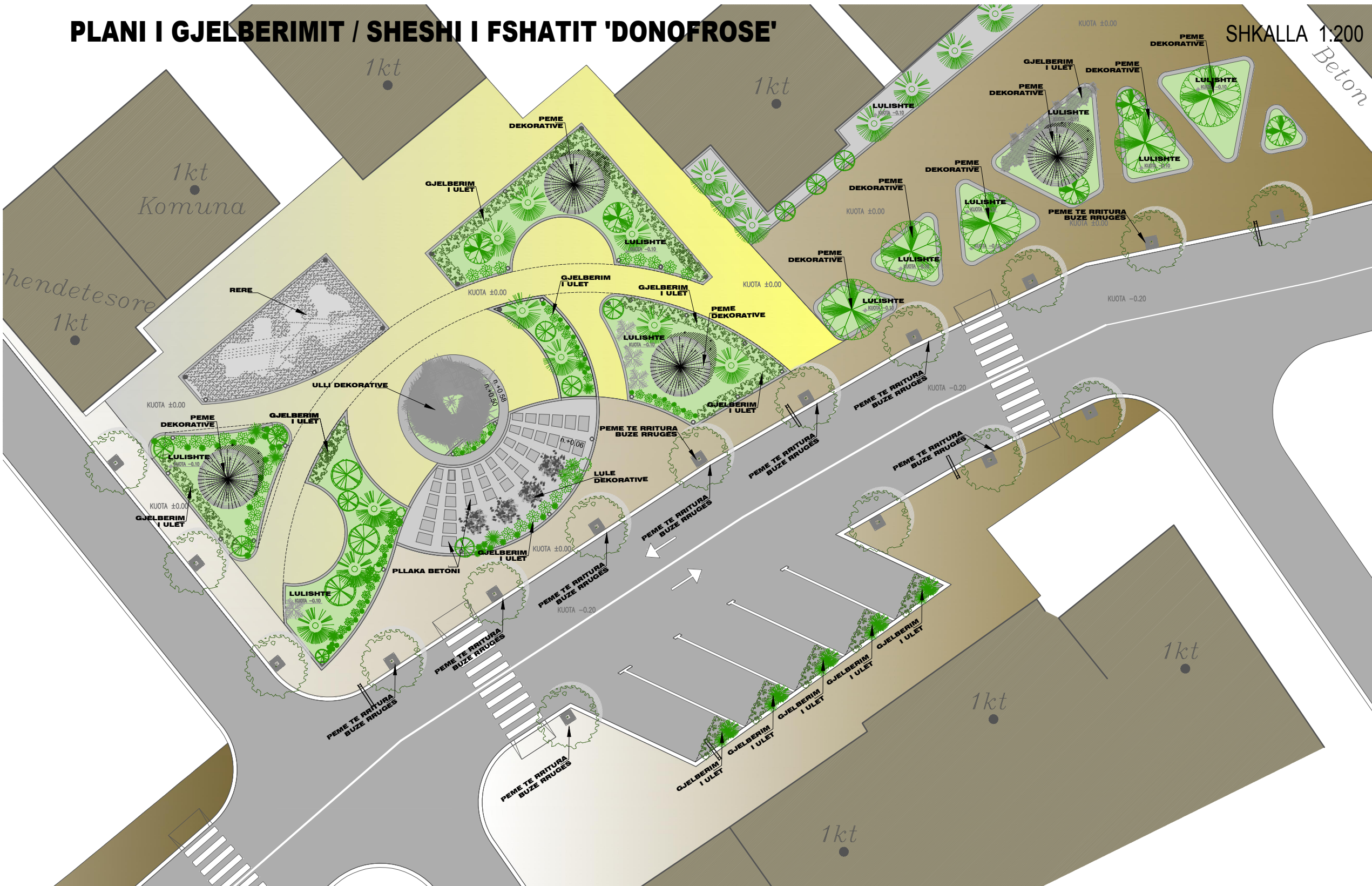

sip,shfrytezueshme aktuale .....m2.

Emertimi fetes:

PLANI I GJELBERIMIT TE SHESHIT

Aprovimi Klientit Fleta Nr.: ARCH 06

Date: JANAR 2018

Projektuar dhjetor.2017 H&S.BOLLANO

1:200 ne format A3 Size

Vendodhja e objektit

**URA VAJGURORE**

DREJTORIA E PLANIFIKIMIT TE TERRITORIT BASHKIA URA VAJGURORE

Projektoi: **H&S PROJECT O5**  
Nr.Lic. N.6811/1

Grupi Projektimit:

Ark. HERAKLE BOLLANO **H&S** Ark. SABINA BOLLANO  
Perpunoi: Ark.LEONARD BUSHI & Ark.ENE MANOKU  
Konstruktores: Ing. VANGJEL LOLI Ing.  
Ing.Hid/sanit: Ing. ALBERT SHIRA & Ing.ARTAN DERSHA  
Nrohje/Ventil: Ing. ALBERT SHIRA  
Ing. Elektrik: Ing. ANASTAS KOKA  
Ing. MKZ: Ing. ALBERT SHIRA & Ing.ARTAN DERSHA

## DETAJI I GJELBERIMIT RRUGOR

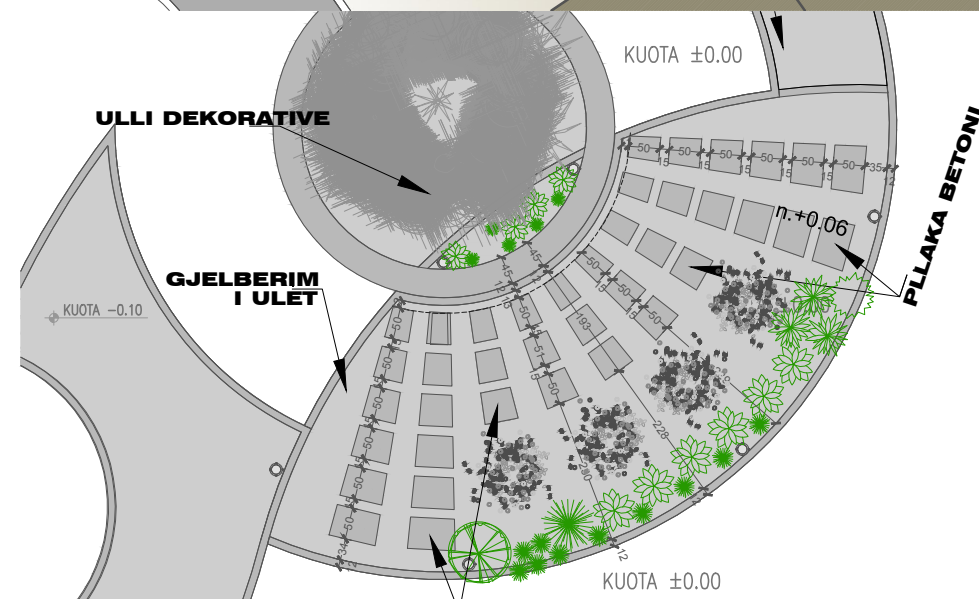
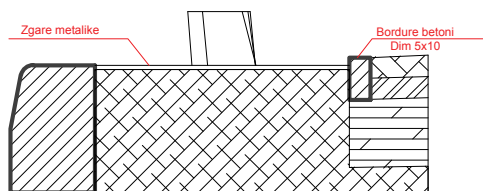
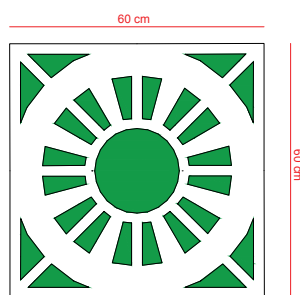

# PLANIMETRIT E PROPOZUARA ME MOBILIM URBAN / SHESHI I FSHATIT 'DONOFROSE'

SHKALLA 1:500

REPUBLIKA E SHQIPËRISË  
AGJENCIA E ZHVILLIMIT TE TERRITORIT



Klienti: BASHKIA URA VAJGURE  
Financues: BASHKIA URA VAJGURE

Projekt:  
Projekt/Preventiva zbatimi **DONOFROSE**

**RIKUALIFIKIM URBAN DHE KRIJIMI I AMBJENTEVE TE REKREACIONIT NE FSHATRAT :**

DRENOVICE, SAMATICE, DONOFROSE, REREZ, POLIZHAN, GAJDE, ARREZ, SKREVAN, BISTROVICE, KUC.

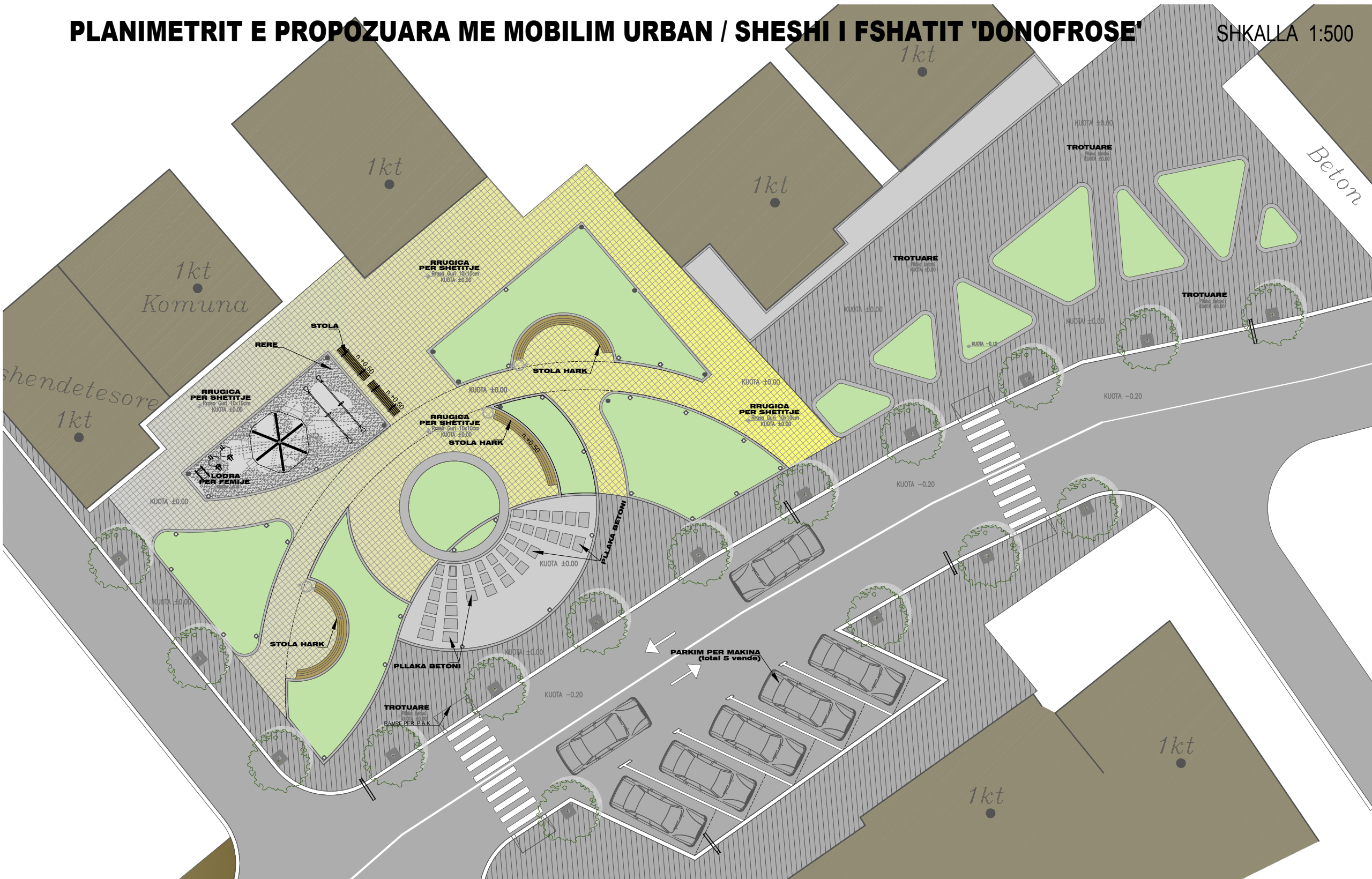

sip,shfrytezueshme aktuale .....m2.

Emertimi fletes:

PLANIMETRIT ME MOBILIM URBAN

Aprovimi Klientit Fleta Nr.: ARCH 07

Date: JANAR 2018

Projektuar dhjetor.2017 H&S.BOLLANO

1:200 ne format A3 Size

Vendodhja e objektit

**URA VAJGURE**

DREJTORIA E PLANIFIKIMIT TE TERRITORIT BASHKIA URA VAJGURE

Projektoi:



Nr.Lic. N.6811/1

Grupi Projektimit:

Ark. HERAKLE BOLLANO  Ark. SABINA BOLLANO

Perpunoi: Ark.LEONARD BUSHI & Ark.ENE MANOKU

Konstruktore: Ing. VANGJEL LOLI Ing.

Ing.Hid/sanit: Ing. ALBERT SHIRA & Ing.ARTAN DERSHA

Nrohje/Ventil: Ing. ALBERT SHIRA

Ing. Elektrik: Ing. ANASTAS KOKA

Ing. MKZ: Ing. ALBERT SHIRA & Ing.ARTAN DERSHA

## DETAJ STOLI

PAMJA BALLEORE

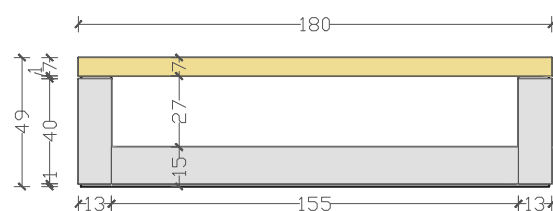

PAMJA NGA SIPER

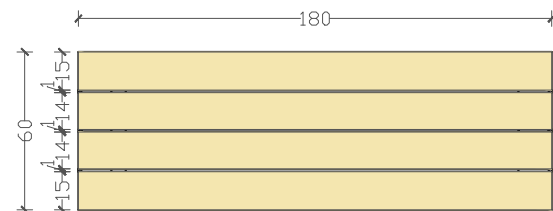

PAMJA ANESORE

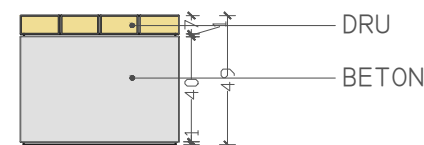

## DETAJ I SHTRESAVE TE KENDIT TE LOJRAVE

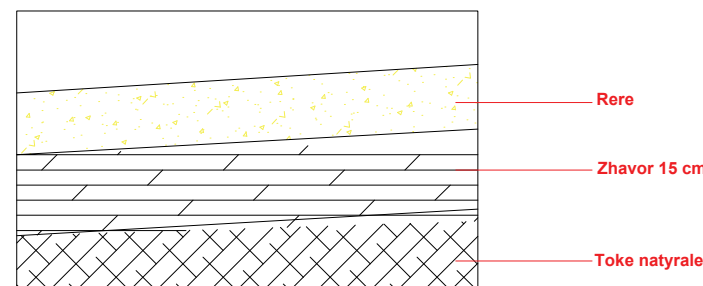

# PRERJE TERTHORE

SHKALLA 1:100

REPUBLIKA E SHQIPËRISË  
AGJENCIA E ZHVILLIMIT TE TERRITORIT



Klienti: BASHKIA URA VAJGURORE  
Financues: BASHKIA URA VAJGURORE

Projekt:  
Projekt/Preventiva zbatimi **DONOFROSE**

**RIKUALIFIKIM URBAN DHE KRIJIMI I AMBJENTEVE TE REKREACIONIT NE FSHATRAT :**

DRENOVICE, SAMATICE, DONOFROSE, REREZ, POLIZHAN, GAJDE, ARREZ, SKREVAN, BISTROVICE, KUC.

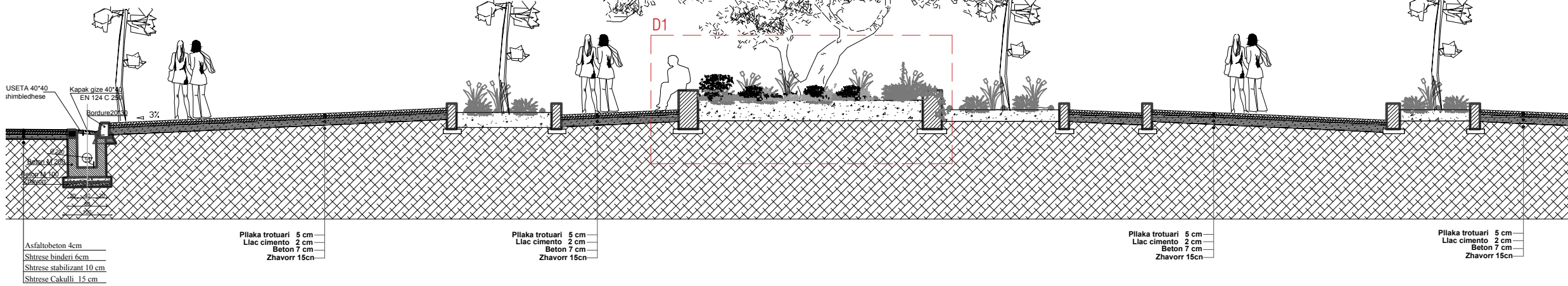

# PRERJE GJATESORE

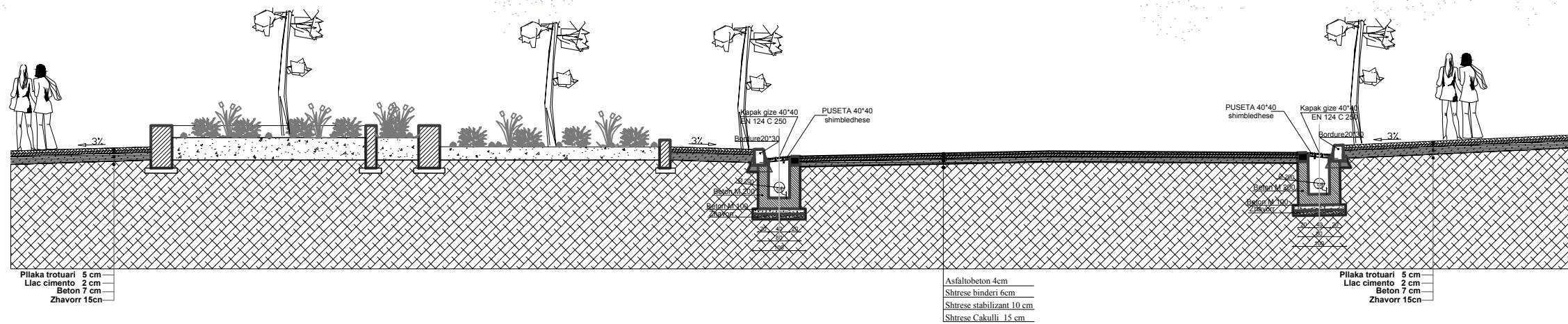

sip.shfrytezueshme aktuale .....m2.

Emertimi fetes:

PRERJE GJATESORE DHE TERTHORE

Aprovimi Klientit Fleta Nr.: ARCH 08

Date: JANAR 2018

Projektuar dhjetor.2017 H&S.BOLLANO

1:100 ne format A3 Size

Vendodhja e objektit

**URA VAJGURORE**

DREJTORIA E PLANIFIKIMIT TE TERRITORIT BASHKIA URA VAJGURORE

Projektoi:



Nr.Lic. N.6811/1

Grupi Projektimit:

Ark. HERAKLE BOLLANO *H&S* Ark. SABINA BOLLANO

Perpunoi: Ark.LEONARD BUSHI & Ark.ENEJA MANOKU

Konstruktores: Ing. VANGJEL LOLI & Ing. ARTAN DERSHA

Ing.Hid/sanit: Ing. ALBERT SHIRA & Ing. ALBERT SHIRA

Nrohje/Ventil: Ing. ALBERT SHIRA & Ing. ANASTAS KOKA

Ing. Elektrik: Ing. ANASTAS KOKA & Ing. ALBERT SHIRA

Ing. MKZ: Ing. ALBERT SHIRA & Ing. ARTAN DERSHA

# PRERJE E KENDIT TE LOJRAVE PER FEMIJE

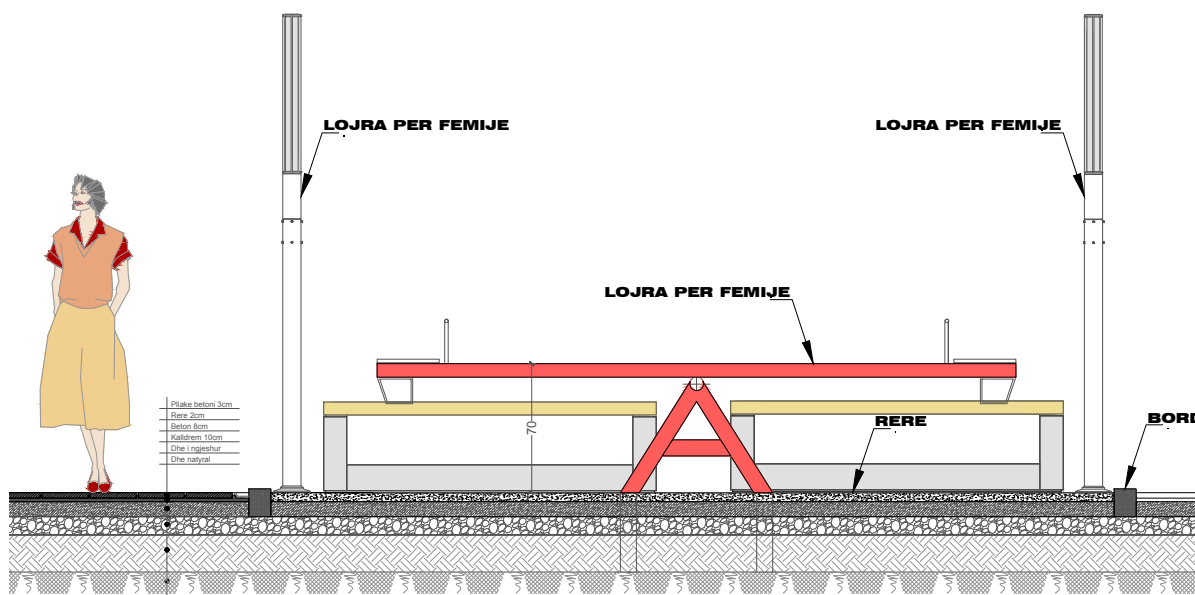

# PAMJE PERSPEKTIVE / SHESHI I FSHATIT 'DONOFROSE'

REPUBLIKA E SHQIPËRIË  
AGJENCIA E ZHVILLIMIT TE TERRITORIT



Klienti: BASHKIA URA VAJGURORE  
Financues: BASHKIA URA VAJGURORE

Projekt:  
Projekt/Preventiva zbatimi **DONOFROSE**

**RIKUALIFIKIM URBAN DHE KRIJIMI I AMBJENTEVE TE REKREACIONIT NE FSHATRAT :**

DRENOVICE, SAMATICE, DONOFROSE, REREZ, POLIZHAN, GAJDE, ARREZ, SKREVAN, BISTROVICE, KUC.



sip,shfrytzyeshme aktuale .....m2.

Emertimi fletes:

PAMJE PERSPEKTIVE TE SHESHIT

Aprovimi Klientit Fleta Nr.: ARCH 11

Date: JANAR 2018

Projektuar dhjetor.2017 H&S.BOLLANO

1:500 ne format A3 Size

Vendodhja e objektit

**URA VAJGURORE**

DREJTORIA E PLANIFIKIMIT TE TERRITORIT BASHKIA URA VAJGURORE

Projektoi:



Nr.Lic. N.6811/1

Grupi Projektimit:

Ark. HERAKLE BOLLANO  Ark. SABINA BOLLANO

Perpunoi: Ark.LEONARD BUSHI & Ark.ENEJA MANOKU

Konstruktores: Ing. VANGJEL LOLI Ing.

Ing.Hid/saniti: Ing. ALBERT SHIRA & Ing.ARTAN DERSHA

Nrohje/Ventili: Ing. ALBERT SHIRA

Ing. Elektrik: Ing. ANASTAS KOKA

Ing. MKZ: Ing. ALBERT SHIRA & Ing.ARTAN DERSHA



# PAMJE PERSPEKTIVE / SHESHI I FSHATIT 'DONOFROSE'



REPUBLIKA E SHQIPËRISË  
AGJENCIA E ZHVILLIMIT TE TERRITORIT



Klienti: BASHKIA URA VAJGURORE  
Financues: BASHKIA URA VAJGURORE

Projekt:  
Projekt/Preventiva zbatimi **DONOFROSE**

**RIKUALIFIKIM URBAN DHE KRIJIMI I AMBJENTEVE TE REKREACIONIT NE FSHATRAT :**  
DRENOVICE, SAMATICE, DONOFROSE, REREZ, POLIZHAN, GAJDE, ARREZ, SKREVAN, BISTROVICE, KUC.



sip,shfrytezueshme aktuale .....m2.



Emertimi fletes:

PAMJE PERSPEKTIVE TE SHESHIT

Aprovimi Klientit Fleta Nr.: ARCH 12

Date: JANAR 2018

Projektuar dhjetor.2017 H&S.BOLLANO

1:500 ne format A3 Size

Vendodhja e objektit

**URA VAJGURORE**

DREJTORIA E PLANIFIKIMIT TE TERRITORIT BASHKIA URA VAJGURORE

Projektoi:



Nr.Lic. N.6811/1

Grupi Projektimit:

Ark. HERAKLE BOLLANO  Ark. SABINA BOLLANO  
Perpunoi: Ark.LEONARD BUSHI & Ark.ENEJA MANOKU  
Konstruktore: Ing. VANGJEL LOLI Ing.  
Ing.Hid/sanit: Ing. ALBERT SHIRA & Ing.ARTAN DERSHA  
Nrohje/Ventil: Ing. ALBERT SHIRA  
Ing. Elektrik: Ing. ANASTAS KOKA  
Ing. MKZ: Ing. ALBERT SHIRA & Ing.ARTAN DERSHA

# SISTEMI I NDRICIMIT / SHESHI I FSHATIT 'DONOFROSE'

REPUBLIKA E SHQIPËRISË  
AGJENCIA E ZHVILLIMIT TE TERRITORIT



Klienti: BASHKIA URA VAJGURE  
Financues: BASHKIA URA VAJGURE

Projekt:  
Projekt/Preventiva zbatimi **DONOFROSE**

**RIKUALIFIKIM URBAN DHE KRIJIMI I AMBJENTEVE TE REKREACIONIT NE FSHATRAZ :**  
DRENOVICE, SAMATICE, DONOFROSE, REREZ, POLIZHAN, GAJDE, ARREZ, SKREVAN, BISTROVICE, KUC.

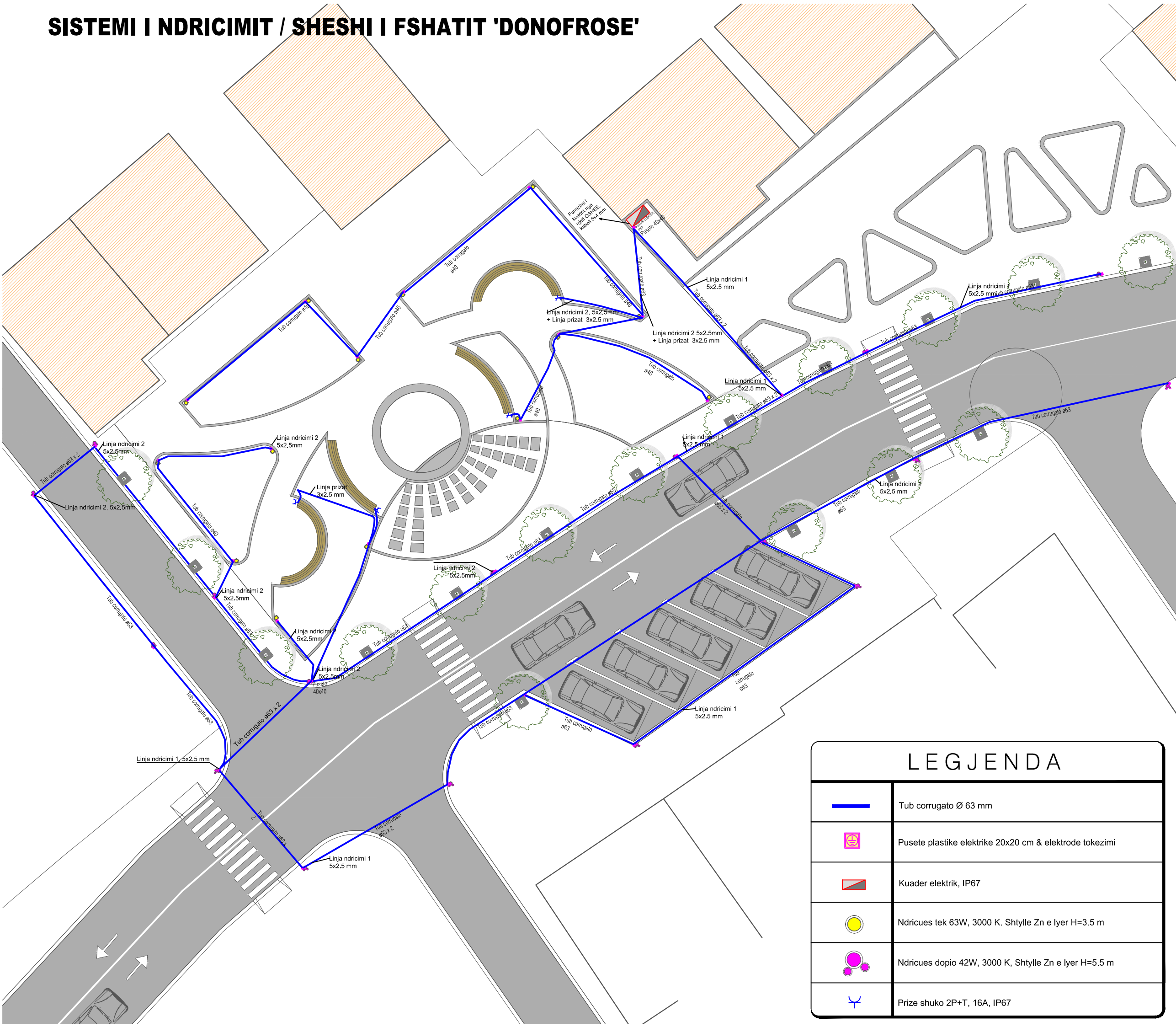

sip,shfrytezueshme aktuale .....m2.

Emertimi fletes:  
**SISTEMI I NDRICIMIT TE SHESHIT**  
Aprovimi Klientit Fleta Nr.: EL-01  
Date: JANAR 2018

Projektuar dhjetor.2017 H&S.BOLLANO  
1:500 ne format A3 Size

Vendodhja e objektit  
**URA VAJGURE**  
DREJTORIA E PLANIFIKIMIT TE TERRITORIT BASHKIA URA VAJGURE

Projektoi: **H&S PROJECT OS**  
ARHITEKTURA + DESIGN  
Nr.Lic. N.6811/1

Grupi Projektimit:  
Ark. HERAKLE BOLLANO **H&S** Ark. SABINA BOLLANO  
Perpunoi: Ark.LEONARD BUSHI & Ark.ENEJA MANOKU  
Konstruktoresh: Ing. VANGJEL LOLI Ing.  
Ing.Hid/sanit: Ing. ALBERT SHIRA & Ing.ARTAN DERSHA  
Nrohje/Ventil: Ing. ALBERT SHIRA  
Ing. Elektrik: Ing. ANASTAS KOKA  
Ing. MKZ: Ing. ALBERT SHIRA & Ing.ARTAN DERSHA

LEGGJENDA	
	Tub corrugato Ø 63 mm
	Pusete plastike elektrike 20x20 cm & elektrode tokezimi
	Kuader elektrik, IP67
	Ndricues tek 63W, 3000 K. Shtylle Zn e lyer H=3.5 m
	Ndricues dopio 42W, 3000 K, Shtylle Zn e lyer H=5.5 m
	Prize shuko 2P+T, 16A, IP67

# DETAJE TEKNIKE / SHESI I FSHATIT 'DONOFROSE'



Klienti: BASHKIA URA VAJGURORE  
Financues: BASHKIA URA VAJGURORE

Projekt:  
Projekt/Preventiva zbatimi

**RIKUALIFIKIM URBAN DHE KRIJIMI I AMBJENTEVE TE REKREACIONIT NE FSHATRA T :**

DRENOVICE, SAMATICE, DONOFROSE, REREZ, POLIZHAN, GAJDE, ARREZ, SKREVAN, BISTROVICE, KUC.



sip,shfrytezueshme aktuale .....m2.

Emertimi fletes:

DETAJE TEKNIKE TE SHESHIT

Aprovimi Klientit Fleta Nr.: EL-02

Date: JANAR 2018

Projektuar dhjetor.2017 H&S.BOLLANO

1:500 ne format A3 Size

Vendodhja e objektit

**URA VAJGURORE**

DREJTORIA E PLANIFIKIMIT TE TERRITORIT BASHKIA URA VAJGURORE

Projektoi: **H&S PROJECT** OS  
Nr.Lic. N.6811/1

Grupi Projektimit:

Ark. HERAKLE BOLLANO **H&S** Ark. SABINA BOLLANO  
Perpunoi: Ark.LEONARD BUSHI & Ark.ENEJA MANOKU  
Konstruktores: Ing. VANGJEL LOLI Ing.  
Ing.Hid/sanit: Ing. ALBERT SHIRA & Ing.ARTAN DERSHA  
Nrohje/Ventil: Ing. ALBERT SHIRA  
Ing. Elektrik: Ing. ANASTAS KOKA  
Ing. MKZ: Ing. ALBERT SHIRA & Ing.ARTAN DERSHA

## PAMJE TE NDRICUESIT TEK DHE DOPIO

## SHTYLLË ELEKTRIKE H=7.8 ME PUSËTË NË TOKË ME LIDHJE EKUIPOTENCIALE DHE MORSETERIA E LINJËS SË NDRIÇIMIT RRUGOR

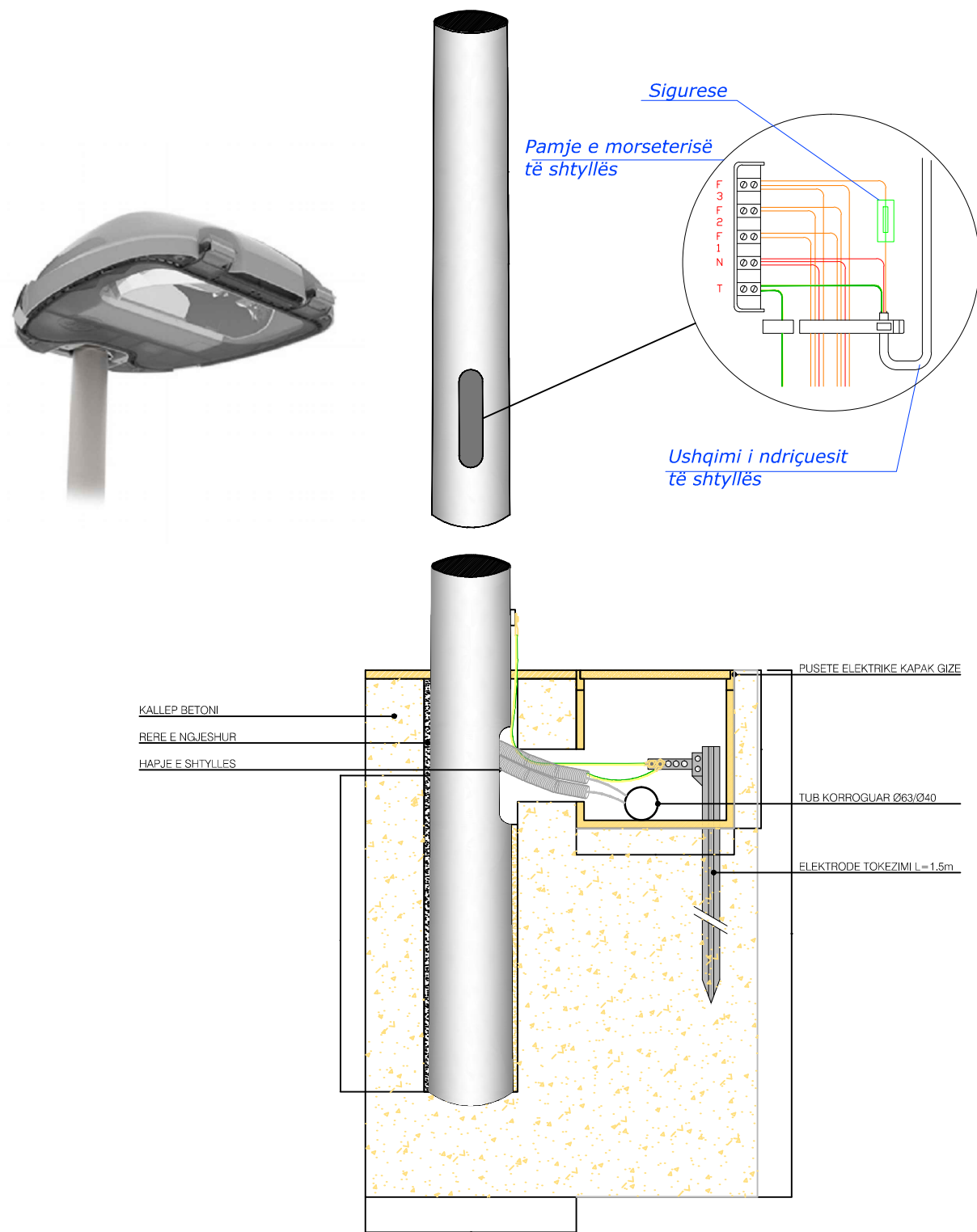

## DETAJ INSTALATIV TE TUBAVE KORROGUAR

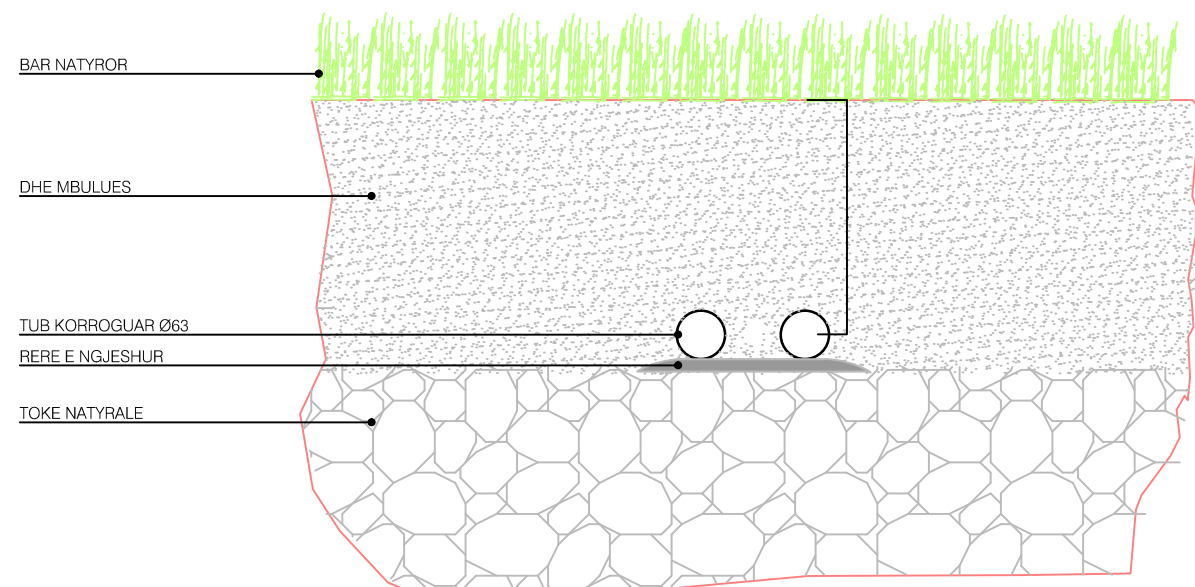





Klienti: BASHKIA URA VAJGURE  
Financues: BASHKIA URA VAJGURE

Projekt:  
Projekt/Preventiva zbatimi **DONOFROSE**

**RIKUALIFIKIM URBAN DHE KRIJIMI I AMBIENTEVE TE REKREACIONIT NE FSHATRA T :**  
DREZNOVIC, SAMATICE, DONOFROSE, REREZ, POLIZHAN, GAJDE, ARREZ, SKREVAN, BISTROVICE, KUC.

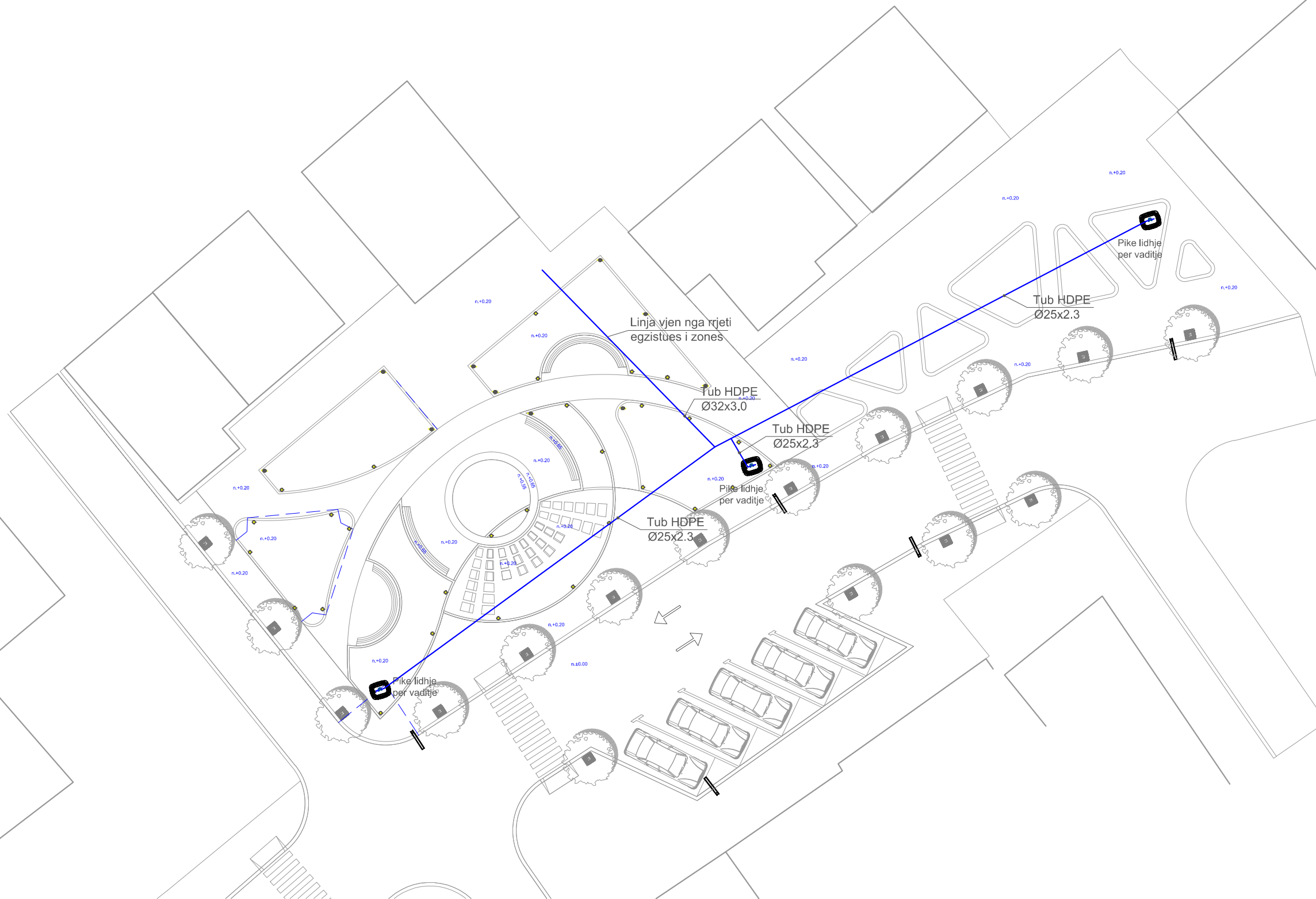

sip.shfrytezueshme aktuale .....m2.

Emertimi fletes:  
**FURNIZIM ME UJE PER VADITJE**  
Aprovimi Klientit Fleta Nr.: HS-01  
Date: JANAR 2018

Projektuar dhjetor.2017 H&S.BOLLANO  
1:250 ne format A3 Size

Vendodhja e objektit  
**URA VAJGURE**  
DREJTORIA E PLANIFIKIMIT TE TERRITORIT BASHKIA URA VAJGURE

Projektoi: **H&S PROJECT 05**  
architectura + design  
Nr.Lic. N.6811/1

Grupi Projektimit:  
Ark. HERAKLE BOLLANO & Ark.SABINA BOLLANO  
Perpunoi: Ark.LEONARD BUSHI & Ark.ENEA MANOKU  
Konstruktores: Ing. VANGJEL LOLI & Ing. ALBERT SHIRA  
Ing.Hid/sanit: Ing. ALBERT SHIRA & Ing.ARTAN DERSHA  
Nrohje/Ventil: Ing. ALBERT SHIRA  
Ing. Elektrik: Ing. ANASTAS KOKA  
Ing. MKZ: Ing. ALBERT SHIRA & Ing.ARTAN DERSHA

Puset plastike per te bere te mundur montimin e saracineskave per vaditje  
Dimensionet : 40x30x50 cm

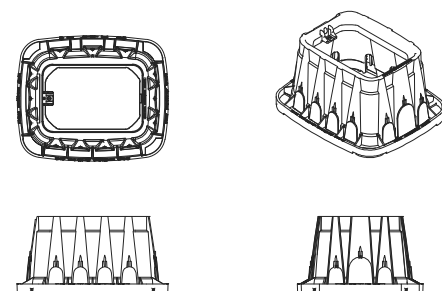

DETAJI I PUSITES SE SARACINESKES SE UJIT TE VADITJES

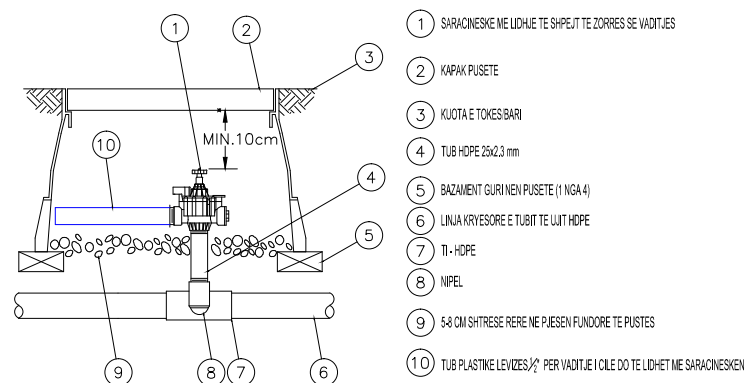

- 1 SARACINESKE ME LIDHJE TE SHPEJIT TE ZORRES SE VADITJES
- 2 KAPAK PUSETE
- 3 KLQUTA E TOKES BARI
- 4 TUB HDPE 25x2.3 mm
- 5 BAZAMENT GURINEN PUSETE (1 INGA 4)
- 6 LINJA KYRESORE E TUBIT TE UJIT HDPE
- 7 TI -HDPE
- 8 NIPEL
- 9 54 CM SHITRESE RERE NE PUESIN FUNDORE TE PUSITES
- 10 TUB PLASTINE LEVIZESJË PER VADITJE I CILE DO TE LIDHET ME SARACINESKEN

LEGJENDE	
	LINJA E FURNIZIMIT ME UJE TE FTOHTE
	SARACINESKE ON/OFF

# IMPJANTI I SHKARKIMEVE TE UJRAVE TE SHIUT / SHESI I FSHATIT 'DONOFROSE'

SHKALLA 1:250

REPUBLIKA E SHQIPËRISË  
AGJENCIA E ZHVILLIMIT TE TERRITORIT



Klienti: BASHKIA URA VAJGURE  
Financues: BASHKIA URA VAJGURE

Projekt:  
Projekt/Preventiva zbatimi **DONOFROSE**

**RIKUALIFIKIM URBAN DHE KRIJIMI I AMBIENTEVE TE REKREACIONIT NE FSHATIN :**  
DRENOVIC, SAMATICE, DONOFROSE, RREZ, POLIZHAN, GAJDE, ARREZ, SKREVAN, BISTROVICE, KUC.



sip.shfrytezueshme aktuale .....m2.

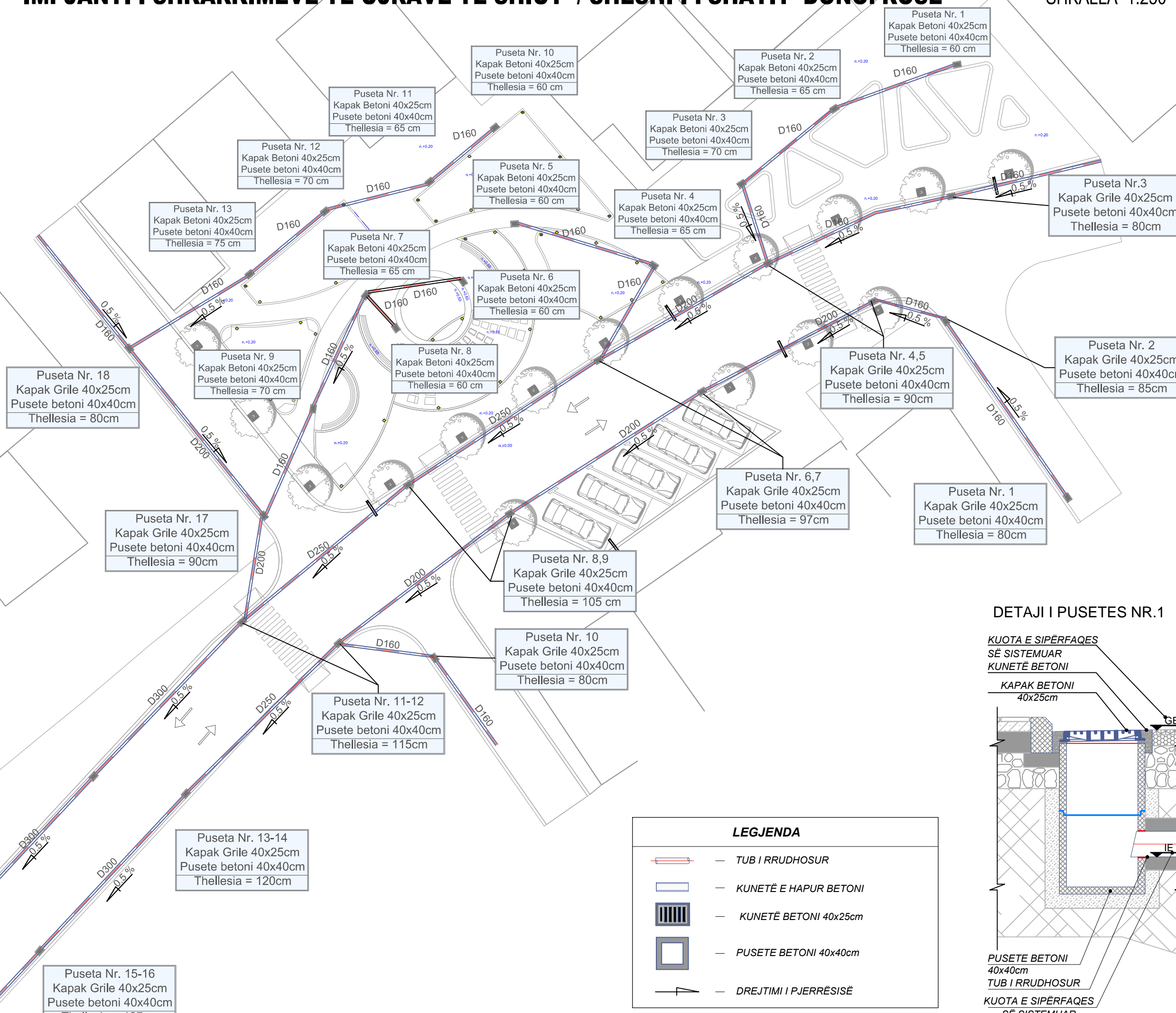

## DETAJI I PUSETES NR.1

KUOTA E SIPËRFAQES  
SË SISTEMUAR  
KUNETË BETONI

KAPAK BETONI  
40x25cm

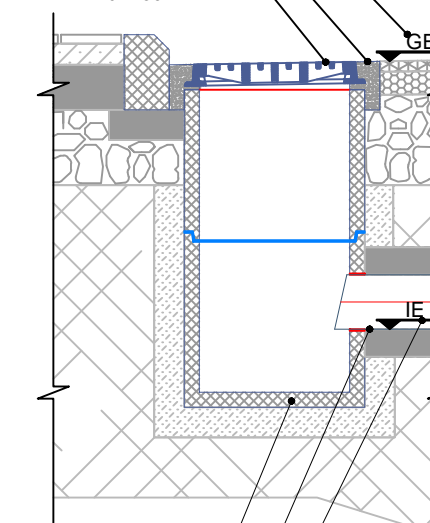

PUSETE BETONI  
40x40cm

TUB I RRUDHOSUR

KUOTA E SIPËRFAQES  
SË SISTEMUAR

## LEGJENDA

- TUB I RRUDHOSUR
- KUNETË E HAPUR BETONI
- KUNETË BETONI 40x25cm
- PUSETE BETONI 40x40cm
- DREJTIMI I PJERRËSISË

Emertimi fletes:

IMPJANTI I SHKARKIMEVE TE UJRAVE TE SHIUT

Aprovimi Klientit Fleta Nr.: SH-01

Date: JANAR 2018

Projektuar dhjetor.2017 H&S.BOLLANO

1:250 ne format A3 Size

Vendodhja e objektit

**URA VAJGURE**

DREJTORIA E PLANIFIKIMIT TE TERRITORIT BASHKIA URA VAJGURE

Projektoi:



Nr.Lic. N.6811/1

Grupi Projektimit:

Ark. HERAKLE BOLLANO Ark. SABINA BOLLANO  
Perpunoi: Ark.LEONARD BUSHI & Ark.ENEA MANOKU  
Konstruktor: Ing. VANGJEL LOLI Ing.  
Ing.Hid/sanit: Ing. ALBERT SHIRA & Ing.ARTAN DERSHA  
Nrohje/Ventil: Ing. ALBERT SHIRA  
Ing. Elektrik: Ing. ANASTAS KOKA  
Ing. MKZ: Ing. ALBERT SHIRA & Ing.ARTAN DERSHA