



PROJEKTI I ZBATIMIT (Konstruksioni)

"Riforcim Godine Banimi 10-11 kate mbi toke dhe
nje kat nentoke, rruga Neki Libohova" Nr.15, Rruga
"Abaz Celkupa" Nr.26, Kodi GIS 24907, 24923"
"Punime Shtese"

Porosites : Bashkia DURRES

Autoriteti Kontraktor		BASHKIA DURRES	
Faza		PROJEKT-ZBATIMI	
Thulli i Projektit		HARTIMIN I PROJEKTEVE TE NDERHYRJEVE REHABILITUESE - PERSHTATSESE TE NEVOJSHME	
PROJEKTUES:		 "ARKONSTUDIO SH.P.K." Licensë N.6996/6 Administrator: Ark. MASJEL ÇIÇO	
Drejtes Projekt/ Inxh. Konstrktor	Inxh. DHIMITER PAPA No. Lic. K.1510/2	Inxh. Hidroteknik	Inxh. KRISTAQ KALI No. Lic. H/T. 0103/3
Inxh. Gjeoder	Inxh. Gjeoder	Inxh. Gjeoder	Inxh. Gjeoder
Inxh. Nderimi	Inxh. Nderimi	Inxh. Gjeoder	Inxh. ORIENT MUÇA
Inxh. Nderimi	Inxh. Nderimi	Inxh. Gjeoder	Inxh. Gjeoder
Inxh. Nderimi	Inxh. Nderimi	Inxh. Gjeoder	Inxh. Gjeoder
Inxh. Nderimi	Inxh. Nderimi	Inxh. Gjeoder	Inxh. Gjeoder
Objekti		PALATI DRANOVA, RRUGA "NEKI LIBOHOVA", T. 12, RAJONI 3, (24907-24923)	
Kapitulli		PROJEKTI I PERFORCIMIT	
Thulli i Vizatimit			
Shkalla:		Nr. i Fletes	
			

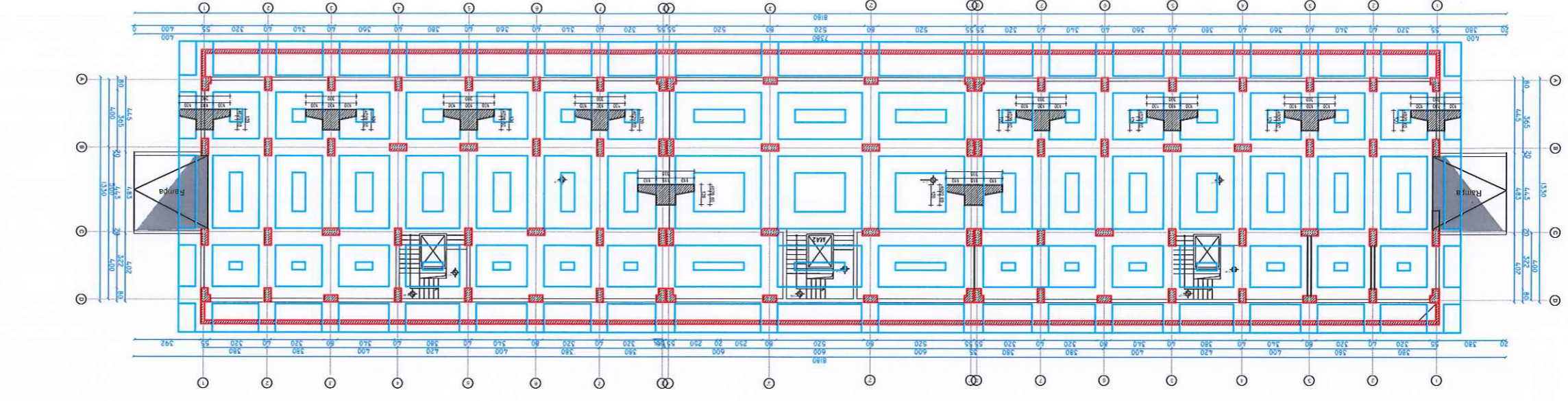

PLANI I THEMELIVE NE KUOTEN -2.59 m, GJENDJA EKZISTUESE

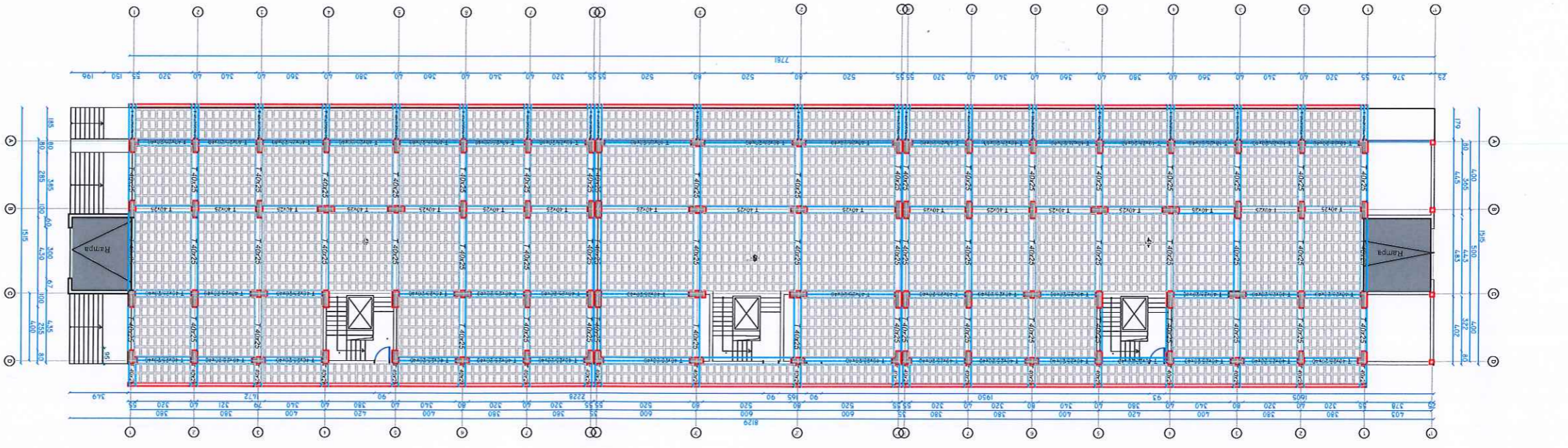

PLANIMETRIA NE KUOTEN ± 0.00 m, GJENDJA EKZISTUESE

<p style="text-align: center;">Autorteti Kontraktor</p> <p style="text-align: center;">BASHKIA DURES</p> <p style="text-align: center;">PROJEKT-ZBATIMI</p>		<p style="text-align: center;">Titulli i Projektit</p> <p style="text-align: center;">HARTIMI I PROJEKTEVE TE NDERHYRJEVE</p> <p style="text-align: center;">TE REHABILITUESE - PERSHTASE</p>		<p style="text-align: center;">PROJEKTUES:</p> <p style="text-align: center;">"ARKONSTUDIO SH.P.R."</p> <p style="text-align: center;">Licensë N.6996/6</p> <p style="text-align: center;">Administrator:</p> <p style="text-align: center;">Ark. NASJEL ÇIÇO</p>		<p style="text-align: center;">Drejues Projekti/ Inxh. Konstruktor</p> <p style="text-align: center;">Inxh. DHIMITER PAPA</p> <p style="text-align: center;">nr. lic. K.1310/2</p>		<p style="text-align: center;">Inxh. Hidroteknik</p> <p style="text-align: center;">Inxh. KRISTAQ KALI</p> <p style="text-align: center;">nr. lic. H.T. 0101/3</p>		<p style="text-align: center;">Inxh. Gjeodet</p> <p style="text-align: center;">Inxh. GJERGJI LOCI</p> <p style="text-align: center;">nr. lic. T.1236</p>		<p style="text-align: center;">Inxh. Gjeodet</p> <p style="text-align: center;">Inxh. ORIENT MUGA</p>		<p style="text-align: center;">Inxh. Nderimi</p> <p style="text-align: center;">PROJEKTIM/NDERIMI</p>		<p style="text-align: center;">Arktekte</p>		<p style="text-align: center;">Arktekte</p>		<p style="text-align: center;">Objekti</p> <p style="text-align: center;">PALATI DRANOVA, RRUGA "NEKI LIBOHOVA",</p> <p style="text-align: center;">L. 12, RAJONI 3, (24907-24923)</p>		<p style="text-align: center;">Kapitulli</p> <p style="text-align: center;">PROJEKTI I PERFORCIMIT</p>		<p style="text-align: center;">Titulli i Vizatimit</p> <p style="text-align: center;">PLANIMETRIA NE KUOTEN -2.59 m DHE ± 0.00 m,</p> <p style="text-align: center;">GJENDJA EKZISTUESE</p>		<p style="text-align: center;">Shkalla:</p> <p style="text-align: center;">Nr. i Fletës</p> <p style="text-align: center;">K-01</p>		<p style="text-align: center;">KONS. DR. KAPA</p> <p style="text-align: center;">PROJEKTIM-ZBATIM</p> <p style="text-align: center;">NR. LIC. NR.880/1</p>	
--	--	---	--	--	--	--	--	--	--	---	--	---	--	---	--	---	--	---	--	--	--	---	--	---	--	---	--	---	--

- KOLONAT EKZISTUESE
- MURET QE SHTOHEN
- KOLONAT QE PERFORCOHEN

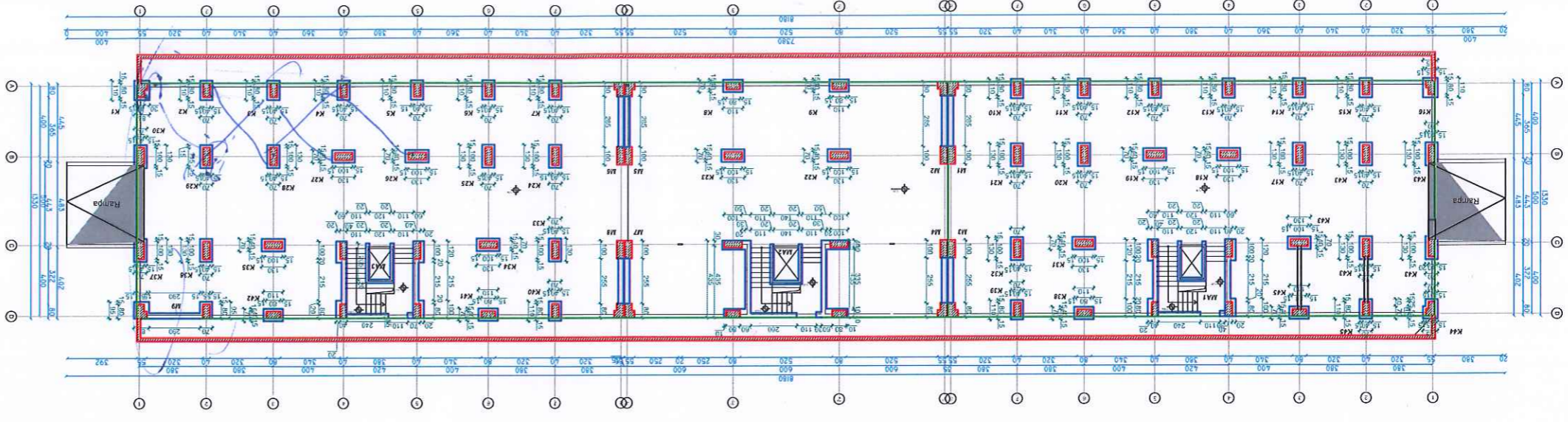

PLANMETRIA NE KUOTEN -2.59 m, GJENDJA PAS NDERHYRJEVE

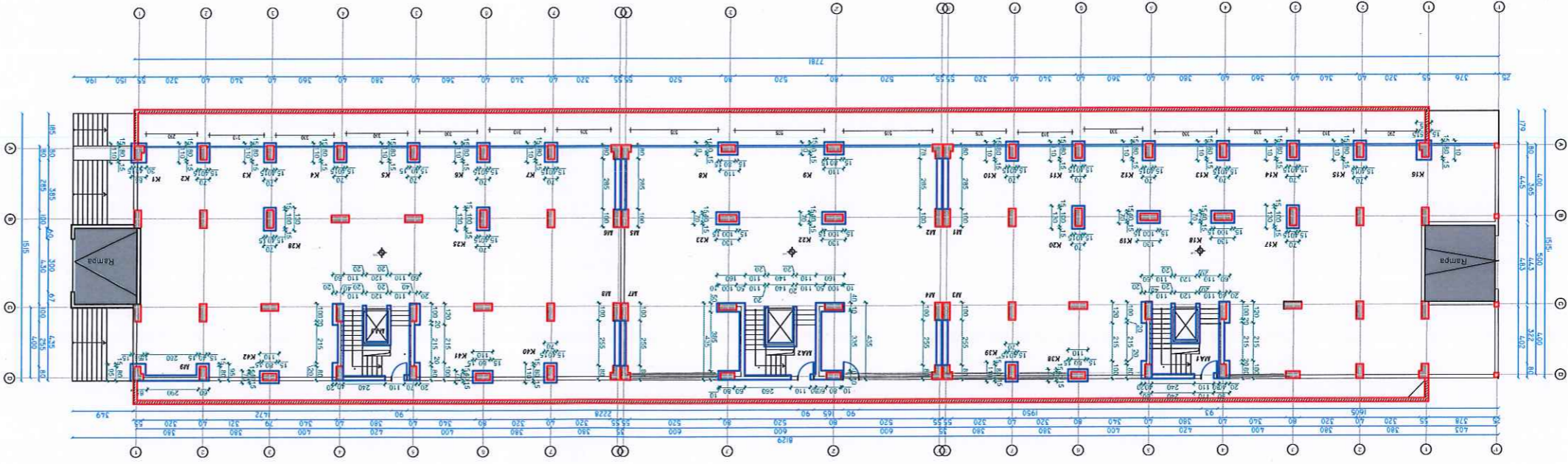

PLANMETRIA NE KUOTEN ± 0.00 m, GJENDJA PAS NDERHYRJEVE

 <p>PROJEKTUES: "ARKONSTUDIO SH.P.K." Licensë N.6996/6 Administrator: Art. NASJEL GJCO</p>		Inxh. Projekt/Inxh. Konstruktore Inxh. DHIMITER PAPA Nr. Lq. K.1510/2	Inxh. Hidroteknik Inxh. KRISTAQ KALI Nr. Lq. H/T. 0103/5	Inxh. Gjeodet Inxh. GJERGJI LOCI Nr. Lq. T.1236	Inxh. Gjeodet Inxh. ORIENT MUÇA	Inxh. Ndertimi Inxh. NDERTIMI	Inxh. Ndertimi Inxh. NDERTIMI	Arktekte Arktekte	Objekti PALLATI DRANOVA, RUGA "NEKI LIBOHOVA", I. 12, RAJONI 3, (24907-24923)	Kapitulli PROJEKTI I PERFORCIMIT	Titrulli i Vizatimit PLANMETRIA NE KUOTEN -2.59 m DHE ± 0.00 m, GJENDJA PAS NDERHYRJEVE	Shkalla: Nr. i Pates K-02							
BASHKIA DURES Autoriteti Kontraktor		PROJEKT-ZBATIMI Titrulli i Projektit		HARTIMIN I PROJEKTEVE TE NDERHYRJEVE REHABILITUESHE - PERSHATASE TE NEVOJSHME		PROJEKTUES: "ARKONSTUDIO SH.P.K." Licensë N.6996/6 Administrator: Art. NASJEL GJCO		Inxh. Projekt/Inxh. Konstruktore Inxh. DHIMITER PAPA Nr. Lq. K.1510/2	Inxh. Hidroteknik Inxh. KRISTAQ KALI Nr. Lq. H/T. 0103/5	Inxh. Gjeodet Inxh. GJERGJI LOCI Nr. Lq. T.1236	Inxh. Gjeodet Inxh. ORIENT MUÇA	Inxh. Ndertimi Inxh. NDERTIMI	Inxh. Ndertimi Inxh. NDERTIMI	Arktekte Arktekte	Objekti PALLATI DRANOVA, RUGA "NEKI LIBOHOVA", I. 12, RAJONI 3, (24907-24923)	Kapitulli PROJEKTI I PERFORCIMIT	Titrulli i Vizatimit PLANMETRIA NE KUOTEN -2.59 m DHE ± 0.00 m, GJENDJA PAS NDERHYRJEVE	Shkalla: Nr. i Pates K-02	

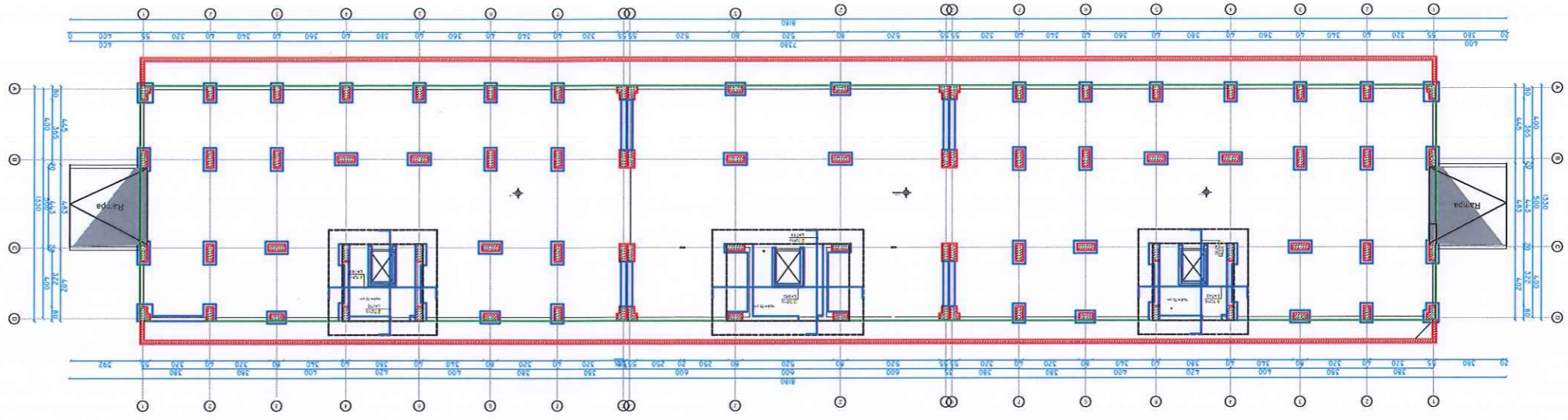

ARMIMI I PLLAKES, ZGARA E SIPERME

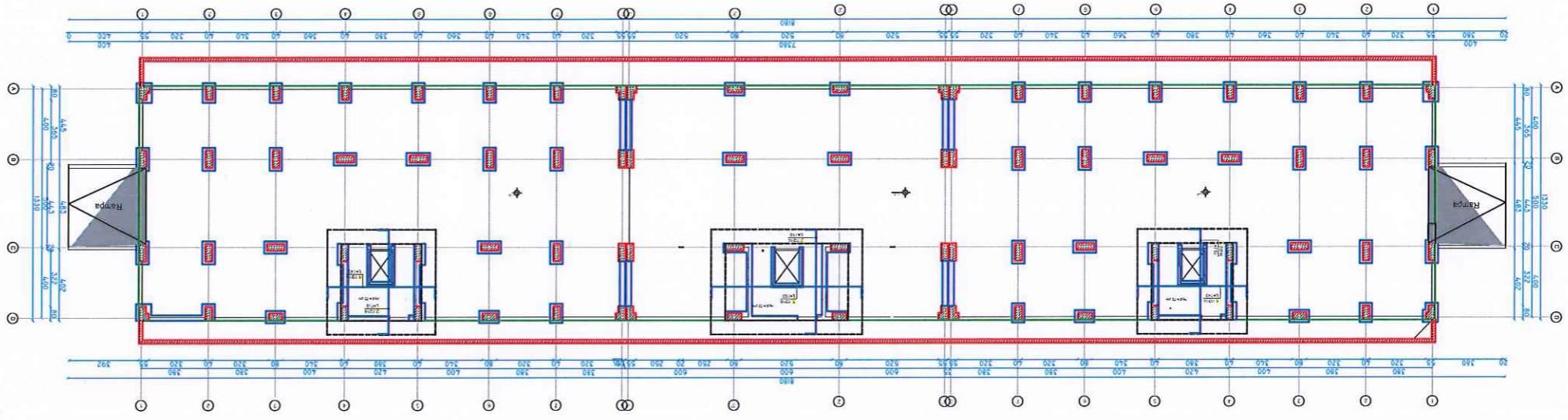

ARMIMI I PLLAKES, ZGARA E POSHTME

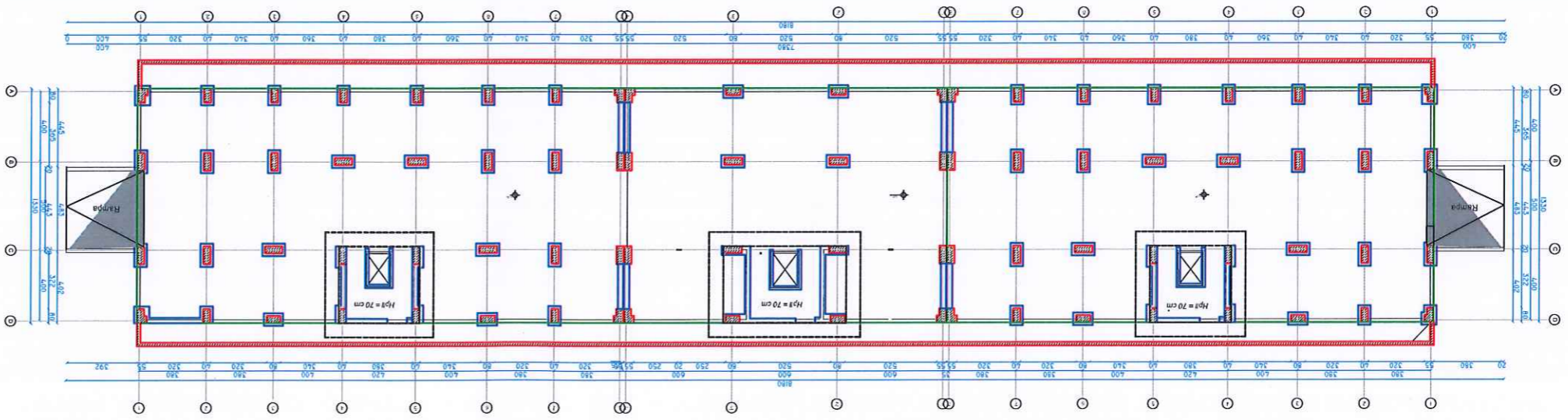

PLANIMETRIA NE KUOTEN -2.59 m, GUENDJA PAS NDERHYRJEVE

PROJEKTUES: "ARKONSTUDIO SH.P.K." License N.6996/6 Administrator: Ark. NASJEL GJCO	
Dregjtues Projekt/ Inxh. Konstruktor Nr. Lq. K.1510/2 Inxh. DHIMITER PAPA	Inxh. Hidroelektrik/ Inxh. KRISTAQ KALI Nr. Lq. H/T. 0103/3
Inxh. Gjeodet/ Inxh. GJERGJIL LOCI Nr. Lq. T.1336	Inxh. Gjeodet/ Inxh. ORIENT MUGA
Inxh. Nderimi/ Inxh. Nderimi	Inxh. Nderimi/ Inxh. Nderimi
Arktekte/ Arktekte	Arktekte/ Arktekte
Objekti "PALATI DRANOVA, RRUGA "NEKI LIBOHOVA", T. 12, RAJONI 3, (24907-24923)	
Kapitulli PROJEKTI I PERFORCIMIT	
Titulli i Vizatimit PLANIMETRIA NE KUOTEN -2.59 m, PLLAKATE ASHENSORREVE	
Shkalla: Nr. i Fletës K-03	
Autorteti Kontraktor BASHKIA DURRESE PROJEKT-ZBATIMI Titulli i Projektit HARTIMIN I PROJEKTEVE TE NDERHYRJEVE REHABILITUESHE - PERSHTATESE TE NEVOJSHME	

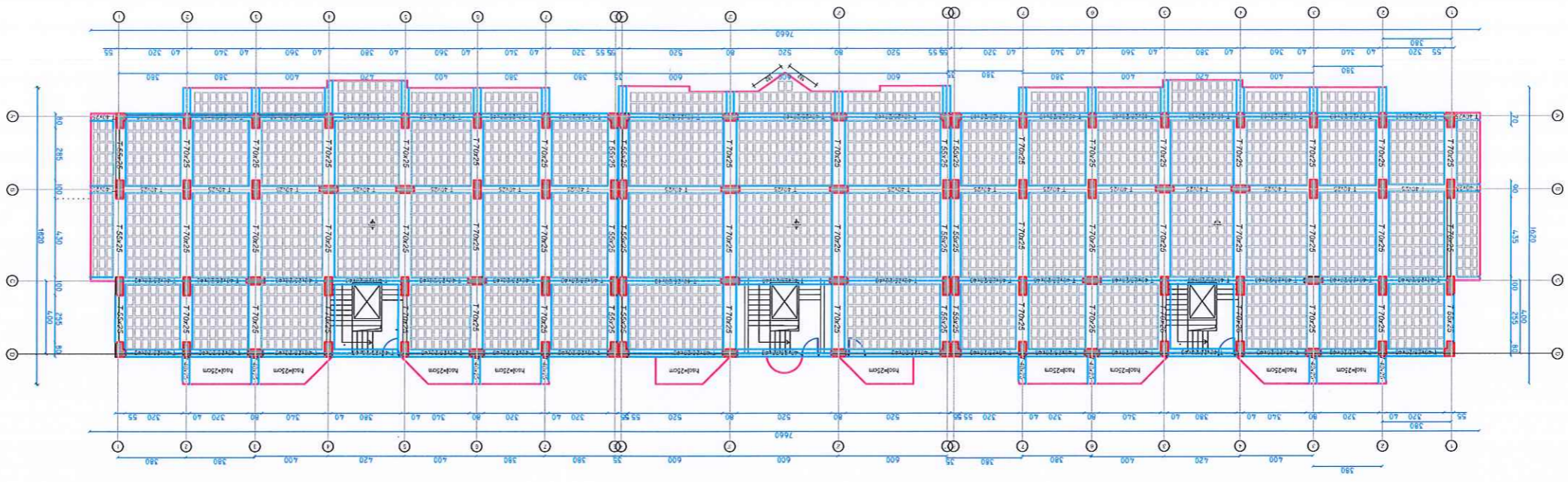

PLANIMETRIA NE KUOTEN +3.90 m, GJENDJA EKZISTUESE

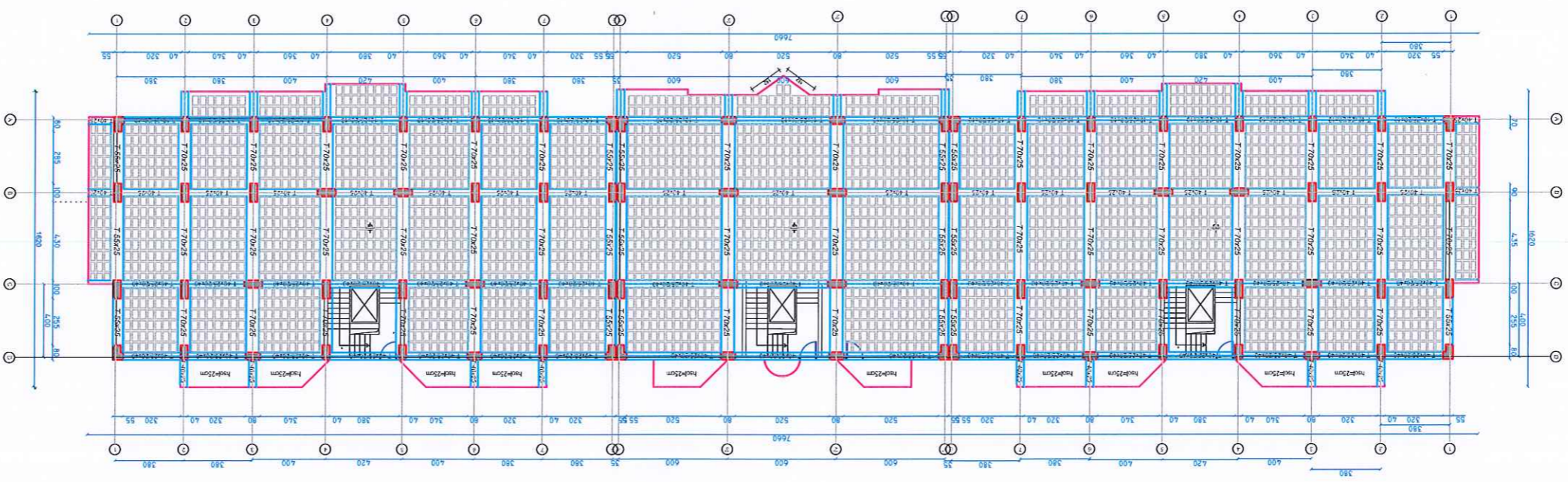

PLANIMETRIA E KATIT TIP, GJENDJA EKZISTUESE

Autorteti Kontraktor		BASHKRIA DURRES	
Faza		PROJEKT-ZBATIMI	
Thulli i Projektit		HARTIMIN I PROJEKTEVE TE NDRRHYRJEVE REHABILITUESE - PERSHATESE TE NEVOJSHME	
PROJEKTUES:		 "ARKONSTUDIO SH.P.K." Licensë N.6996/6 Administrator: Ark. NASJEL ÇIÇO	
Drejtes Projekti/ Inxh. Konstruktor	Inxh. DHIMITER PAPA Nr. Lic. K.1510/3	Inxh. Hidroteknik/ Inxh. KRISTAQ KALLI Nr. Lic. H.T. 0103/5	Inxh. Gjeodet/ Inxh. GJERGJI LOÇI Nr. Lic. T.1236
Inxh. Nderimi	Inxh. Nderimi	Inxh. Gjeodet	Inxh. ORIENT MUÇA ARKONSTUDIO PROJEKTIM/NDERTIM L.4201350/1
Artiklete	Artiklete	Artiklete	Artiklete
Objekti			
PALLATI DRANOVA, RRUGA "NEKI LIBHOVA", L. 12, RAJONI 3, (24907-24923)			
Kapitulli			
PROJEKTI I PERFORCIMIT			
Thulli i Vizatimit			
PLANIMETRIA E KATIT TIP, GJENDJA EKZISTUESE			
Shkalla:		Nr. i Fletës	
		K-04	

KONS. DR. PAPA
 PROJEKTIM/NDERTIM
 Nr. Lic. T.2250/1

- KOLONAT EKZISTUESE
- MURET QE SHTOHEN
- KOLONAT QE PERFORCOHEN

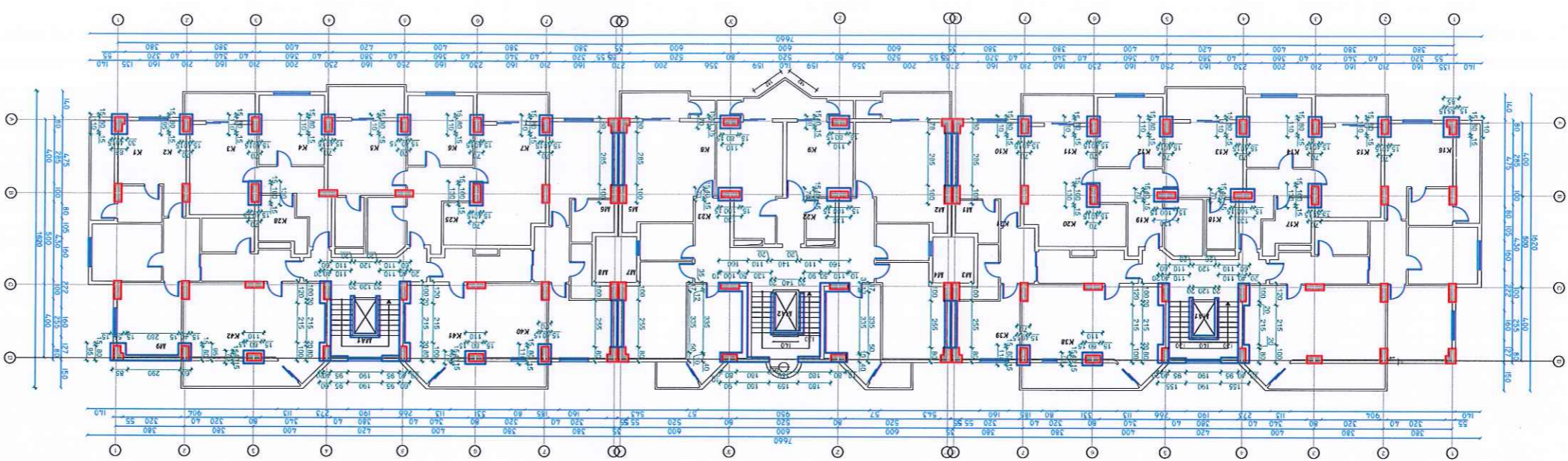

PLANIMETRIA NE KUOTEN +3.90 m, GJENDJA PAS NDERHYRJEVE

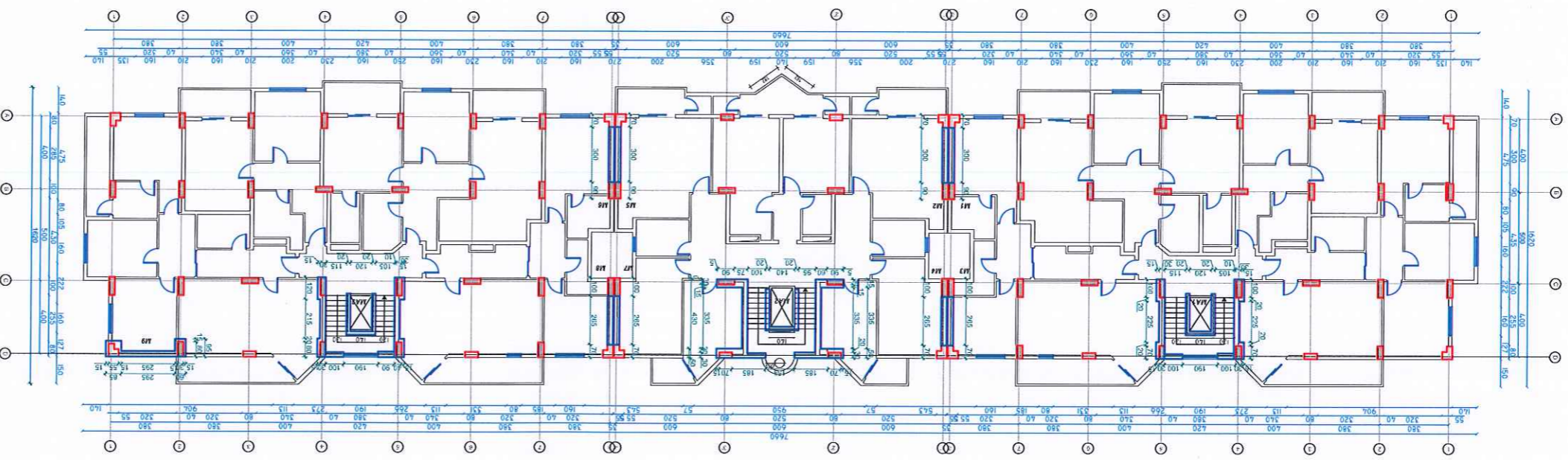

PLANIMETRIA NE KUOTEN +7.02 m, GJENDJA PAS NDERHYRJEVE

Autorteti kontraktor BASHKRIA DURRES	
Faza PROJEKT-ZBATIMI	
Titulli i Projektit HARTIMIN I PROJEKTEVE TE NDERHYRJEVE REHABILITUESE - PERSHTATESE TE NEVOJSHME	
PROJEKTUES: "ARKONSTUDIO SH.P.K." License N.6996/6 Administrator: Ark. NASJEL ÇIÇO	
	Drejtes Projekti/ Insh. Konstruktor Nr. Lic. K.1510/2 Insh. DHIMITER PAPA
Insh. Hidroteknik Nr. Lic. H/T. 0103/3 Insh. KRISTAQ KALI	Insh. Gjeodet Nr. Lic. T.1236 Insh. GJERGJI LOCI
Insh. Nderimi ARKONSTUDIO PROJEKTIV/NDERIMI L420135041	Insh. Nderimi ARKONSTUDIO PROJEKTIV/NDERIMI L420135041
Arkitekt	Arkitekt

Objekti
 PALATI DRANOVA, RRUGA "NEKI LIBOHOVA",
 L. 12, RAJONI 3, (24907-24923)

Kapitulli
 PROJEKTI I PERFORCIMIT

Titulli i Vizimit
 PLANIMETRIA NE KUOTEN +3.90 m DHE +7.02 m,
 GJENDJA PAS NDERHYRJEVE

Shkalla:
 Nr. i Pletes K-05

KONS. DR. PAPA
 PROJEKTIV-NDERIMI
 Nr. Lic. T.1236/1

- ▭ KOLONAT EKZISTUESE
- ▭ MURET QE SHTOHEN
- ▭ KOLONAT QE PERFORCOHEN

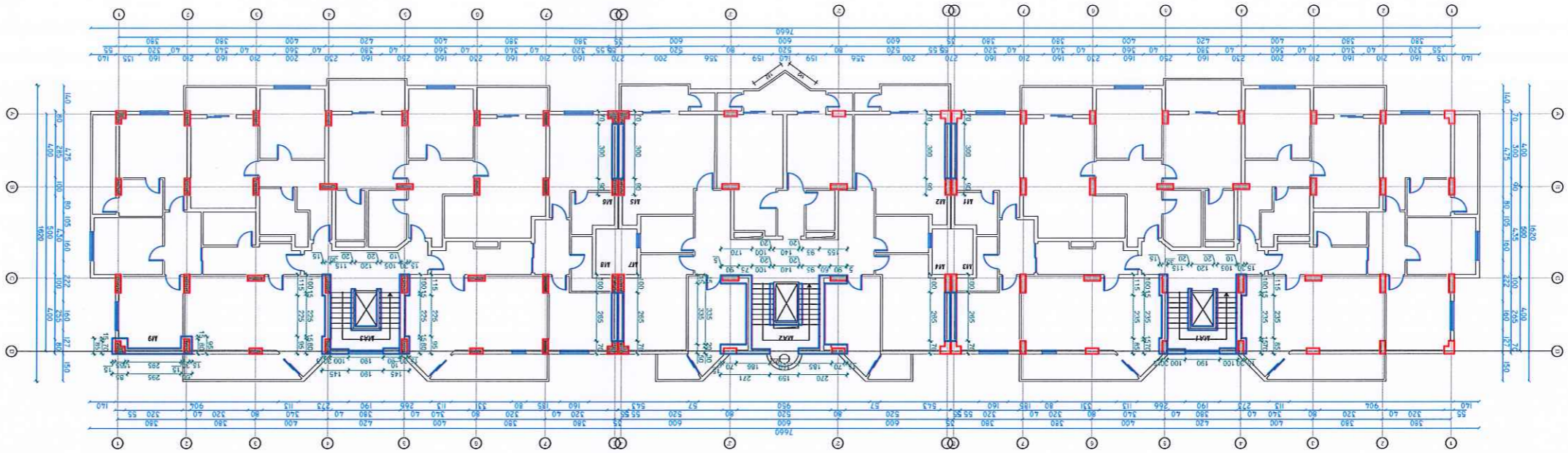

PLANIMETRIA NE KUOTEN +10.08 m, GJENDJA PAS NDERHYRJEVE

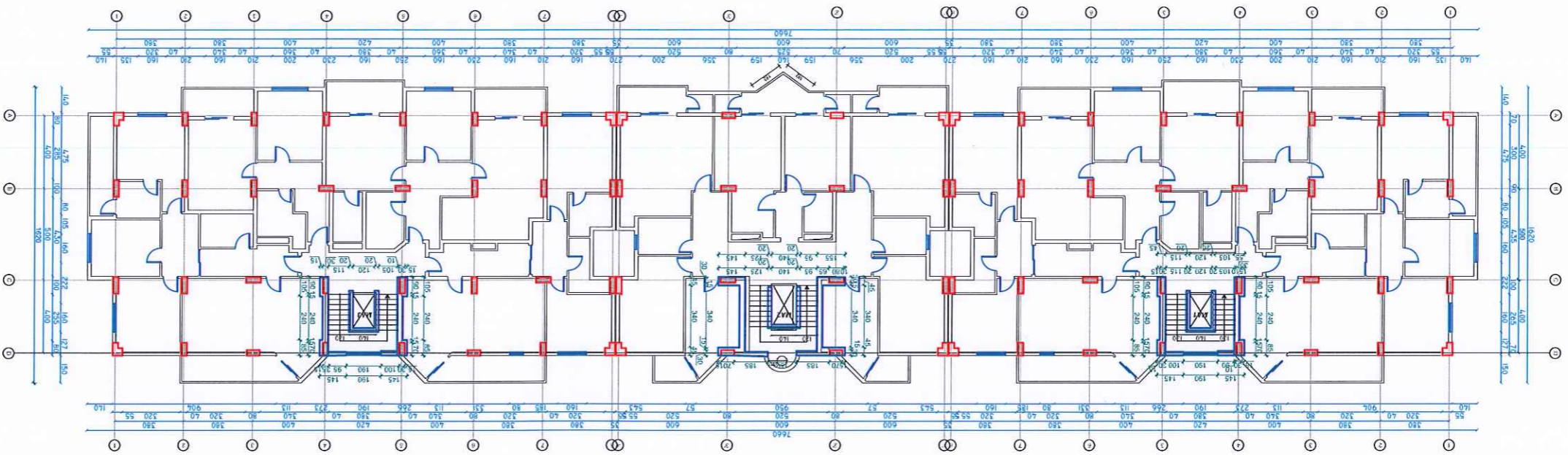

PLANIMETRIA NE KUOTEN +13.14 m, GJENDJA PAS NDERHYRJEVE

Objekti	PALATI DRANOVA, RRUGA "NEKI LIBHOVA", T. 12, RAJONI 3, (24907-24923)	
Kapitulli	PROJEKTI I PERFORCIMIT	
Tihulli i Vizatimit	PLANIMETRIA NE KUOTEN +10.08 m DHE +13.14 m, GJENDJA PAS NDERHYRJEVE	
Shkalla:	Nr. i Fletës	K-06

Arkitecte	
Arkitecte	
Inxh. Ndertimi	
Inxh. Ndertimi	
Inxh. Gjeodet	Inxh. ORJENT MUÇA
Inxh. Gjeodet	Inxh. GJERGJI LQÇI nr. lq. r.1236
Inxh. Hidroteknik	Inxh. KRISTAQ KALI nr. lq. h/r. 030/3
Drejtes Projekt/ Inxh. Konstrktor	Inxh. DHIMITER PAPA nr. lq. k.1310/2

PROJEKTUES:

"ARKONSTUDIO SH.P.K."

Licensë N.6996/6

Administrator:

Ark. NASJEL ÇIÇO

Autoriteti Kontraktor	BASHKIA DURRES
Faza	PROJEKT-ZBATIMI
Tihulli i Projektit	HARTIMIN I PROJEKTEVE TE NDERHYRJEVE TE NEVOJSHME REHABILITUESE - PERSHATESE

HONSA DRANOVA
 PROJEKTI - ZBATIMI
 NR. 12 RAJONI 3

- KOLONAT EKZISTUESE
- MURET QE SHTOHEN
- KOLONAT QE PERFOROHEN

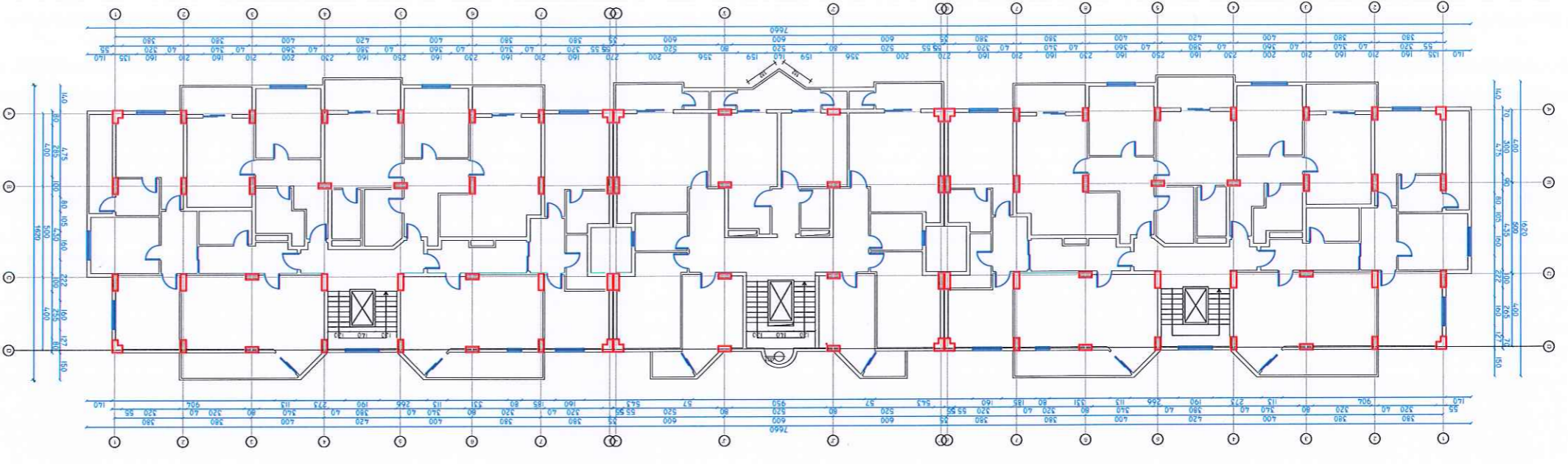

PLANIMETRIA NE KUOTEN +16.20 m, GJENDJA PAS NDERHYRJEVE

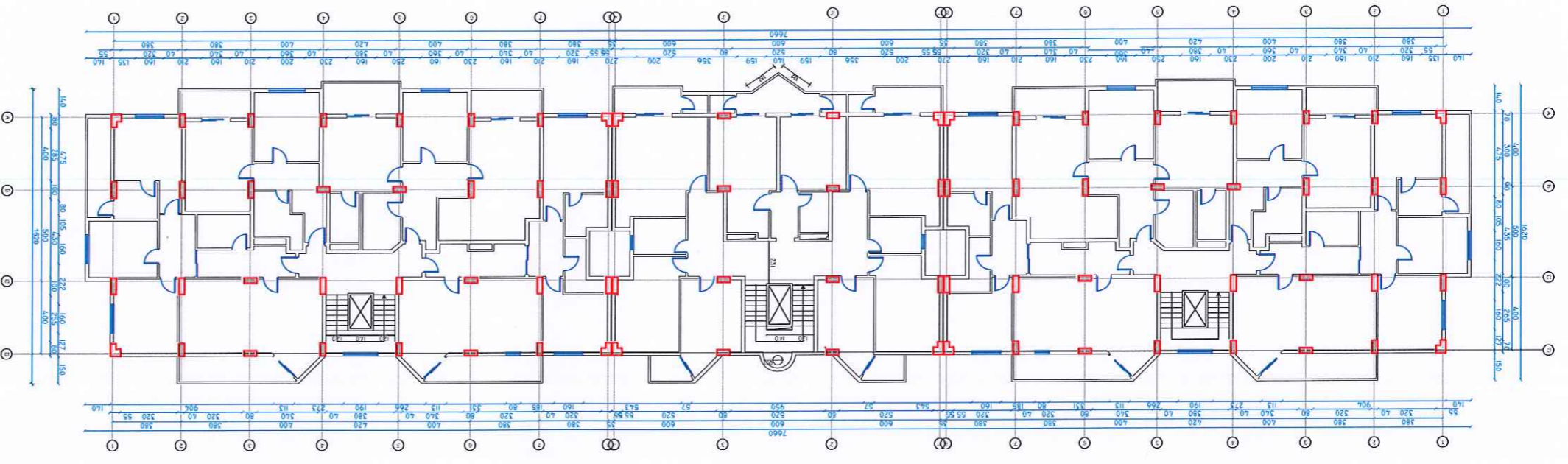

PLANIMETRIA NE KUOTEN +19.26 m, GJENDJA PAS NDERHYRJEVE

PROJEKTES: "ARKONSTUDIO SH.P.K." Licensë N.6996/6 Administrator: Arh. NASJEL CICO	DEJTES PROJEKT/ Inxh. DHIMITER PAPA Nr. Lic. K.1510/2
PROJEKT-ZBATIMI Tërbimi i Projektit	HARTIMI I PROJEKTEVE TE NDERHYRJEVE REHABILITUESHE - PERSHATIESE TE NEVOJSHME
BASHKRIA DURRESE Autoriteti Kontraktor	Faza PROJEKT-ZBATIMI
Objekti PALATI DRANOVA, RRUGA "NEKI LIBHOVA", L. 12, RAJONI 3, (24907-24923)	
Kapitulli PROJEKTI I PERFORCIMIT	
Tërbimi i Vizatimit PLANIMETRIA NE KUOTEN +16.20 m DHE +19.26 m, GJENDJA PAS NDERHYRJEVE	
Shkalla: Nr. i Fletes K-07	
Arkitekte	Arkitekte
Inxh. Ndertimi	Inxh. Ndertimi
Inxh. Ndertimi/PROJEKTI/NDERTIMI	Inxh. Ndertimi
Inxh. Gjedeti	Inxh. Gjedeti
Inxh. GJERGJI LOCI Nr. Lic. 1.1236	Inxh. Gjedeti
Inxh. Hidroteknik	Inxh. KRISTAQ KALI Nr. Lic. H/T. 0103/18
Inxh. Projekt/Inxh. Konstruktore	Inxh. DHIMITER PAPA Nr. Lic. K.1510/2

█ KOLONAT EKZISTUESE
█ MURET QE SHTOHEN
█ KOLONAT QE PERFORCOHEN

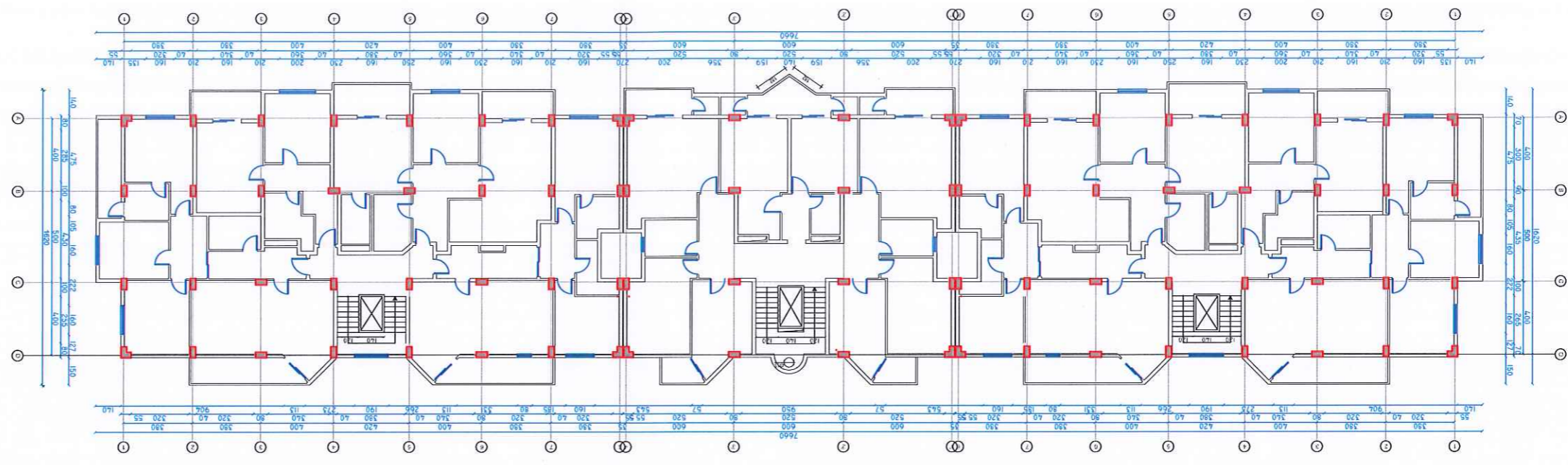

PLANIMETRIA NE KUOTEN +22.32 m, GJENDJA PAS NDERHYRJEVE

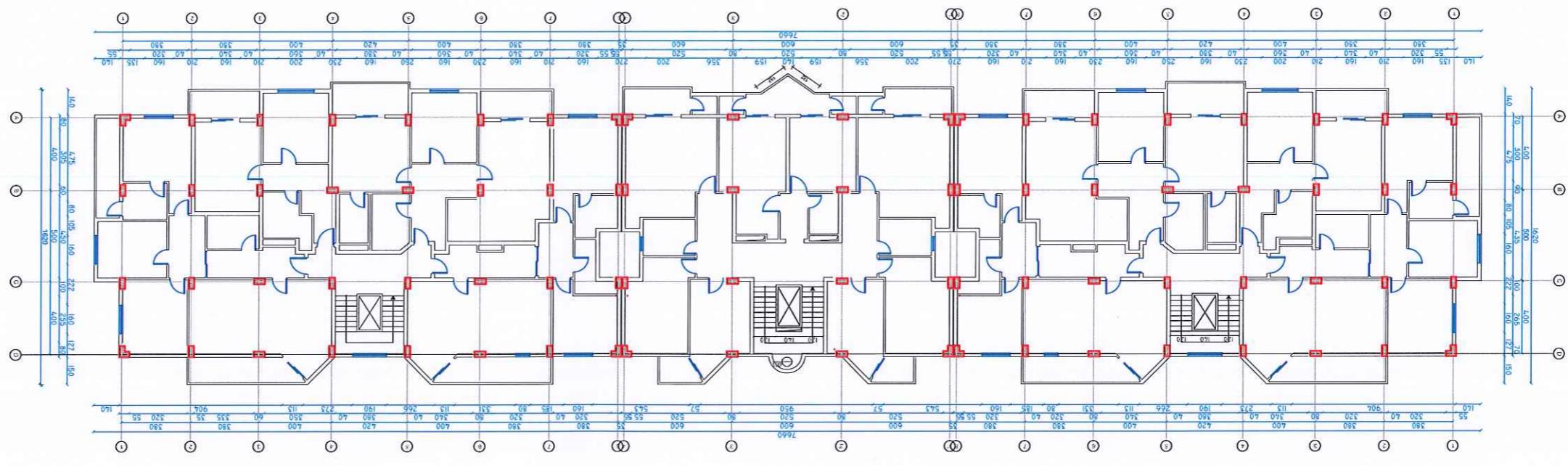

PLANIMETRIA NE KUOTEN +25.38 m, GJENDJA PAS NDERHYRJEVE

Autoriteti Kontraktor BASHKIA DURRESE	
Faqa PROJEKT-ZBATIMI	
Titledi i Projektit REHABILITIM I PROJEKTEVE TE NDERHYRJEVE TE NEVOJSHME	
PROJEKTUES: "ARKONSTUDIO SH.P.K." License N.6996/6 Administrator: Ark. MASJEL CICO	
Drejtues Projektit/ Inxh. Konstruktor Nr. Lq. K.1310/2 INXH. DHIMTER PAPA	Inxh. Hidroteknik Nr. Lq. Nr. 0103/3 INXH. KRISTAQ KALLI
Inxh. Gjeodeet Nr. Lq. r.1236 INXH. GJERGJI LOÇI	Inxh. Gjeodeet INXH. ORIENT MUGA
Inxh. Ndertimi ARKONSTUDIO	Inxh. Ndertimi ARKONSTUDIO
Arkitekte	Arkitekte
Objekti PALLATI DRANOVA, RRUGA "NEKI LIHOVQA", L. 12, RAJONI 3, (24907-24923)	
Kapitulli PROJEKTI I PERFORCIMIT	
Titledi i Vizatimit PLANIMETRIA NE KUOTEN +22.32 m DHE +25.38 m, GJENDJA PAS NDERHYRJEVE	
Shkalla: Nr. i Fletës K-08	

HONS
 2025/11
 2025/11

■ KOLONAT EKZISTUESE
■ MURET QE SHTOHEN
■ KOLONAT QE PERFORCOHEN

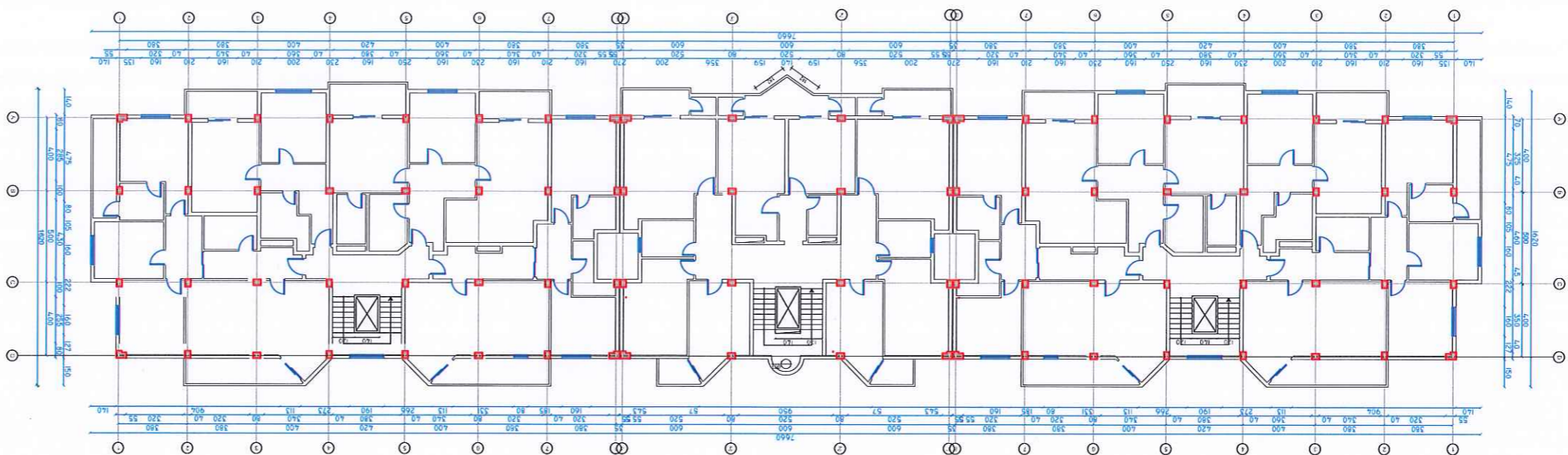

PLANIMETRIA NE KUOTEN +28.44 m, GJENDJA PAS NDERHYRJEVE

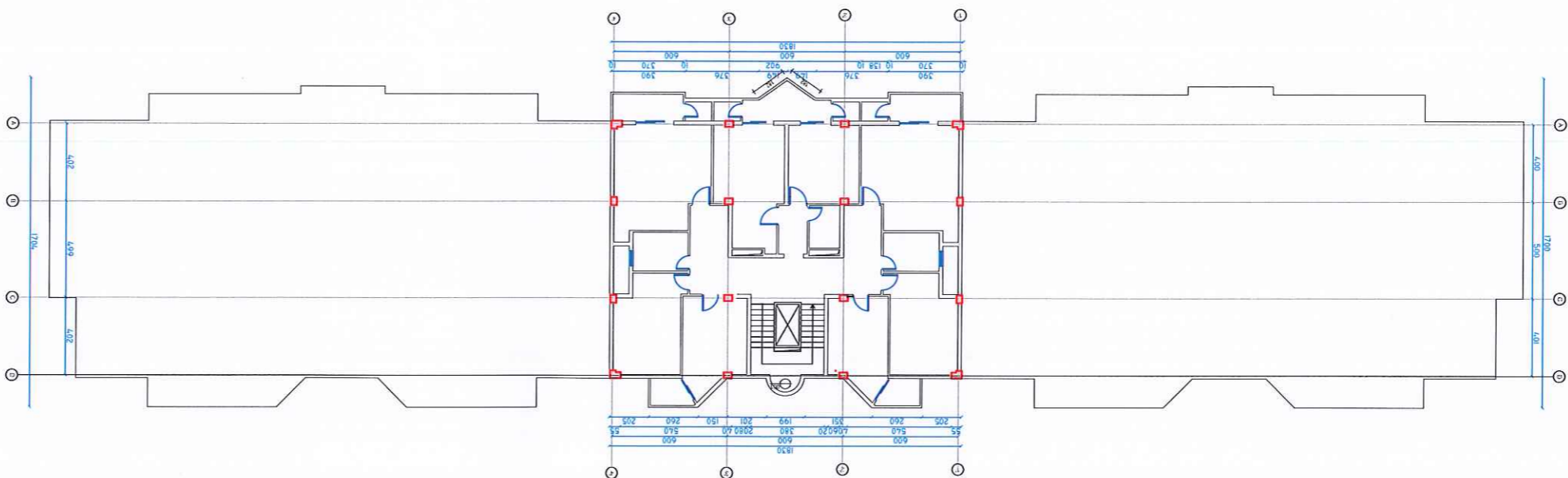

PLANIMETRIA NE KUOTEN +31.50 m, GJENDJA PAS NDERHYRJEVE

<p> PROJEKTUES: "ARKONSTUDIO SH.P.K." Licensë N.6996/6 Administrator: Ark. NASJEL ÇIÇO </p>		Inxh. Projekt/ Inxh. Konstruktor Nr. Lp. K.1310/2 Inxh. DHIMITER PAPA		Inxh. Hidroteknik Inxh. KRISTAQ KALI Nr. Lp. H.T. 0103/5		Inxh. Gjeodet Inxh. GJERGJI LOÇI Nr. Lp. T.1236		Inxh. Gjeodet Inxh. ORIENT MUÇA		Inxh. Mëdërtim Inxh. Mëdërtim Inxh. Mëdërtim		Arkitekte Arkitekte	
Objekt PALATI DRANOVA, RRUGA "NEKI LIBHOVA", T. 12, RAJONI 3, (24907-24923)													
Kapitulli PROJEKTI I PERFORCIMIT													
Titulli i Vizatimit PLANIMETRIA NE KUOTEN +28.44 m DHE +31.50 m, GJENDJA PAS NDERHYRJEVE													
Shkalla: Nr. i Fletës K-09													

Autoriteti Kontraktor BASHKIA DURRES		Faza PROJEKT-ZBATIMI		Titulli i Projektit HARTIMIN I PROJEKTEVE TE NDERHYRJEVE REHABILITUESE - PERSHTATESE TE NEVOJSHME	
--	--	--------------------------------	--	---	--

PERFORCIMI I KOLONAVE
(K1, K16)



TABELA E SPECIFIKIMIT TE ARMATURES

Nr.	FORMA DHE PERMASAT		Ø	[mm]	[m]	l	n	l (totale)
	[cm]	[m]						
1	200	2.00	20	20	2.00	28	56.00	
2	400	4.00	20	20	4.00	28	112.00	
3	400	4.00	20	20	4.00	28	112.00	
4	250	2.50	20	20	2.50	28	70.00	
5		4.66	10	10	4.66	91	424.06	
6		0.50	10	10	0.50	368	184.00	
Perforcimi i Kolonave, K1, K16 (1 Cope)								

PROJEKTUES:
"ARKONSTUDIO SH.P.R.K."
Licensë N.6996/4
Administrator:
Ing. KRENAR DILA

Porositës	Baashkia DURRES
Faza	PROJEKT-ZBATIMI
Titulli i Projektit	PERFORCIMI DHE RESTAURIMI I OBJKTEVE TE PREKURA NGA TERMETI I 26.11.2019
PROJEKTUES:	Ing. KRENAR DILA
Ark. NDUE GJACI	Lic. A-0031/4
Ark. NASJEL GJCO	Lic. A-1249/2
Ark. MARIO MUKA	Lic. K-15102
Urb. XHEZI GONIKU	Lic. K-15102
Inzh. DHIMITER PAPA	Lic. K-15102
Kapitulli	PROJEKTI I PERFORCIMIT
Titulli i Vizatimit	PERFORCIMI I KOLONAVE, K1, K16
Shkalla	Nr. i Fletës K-10

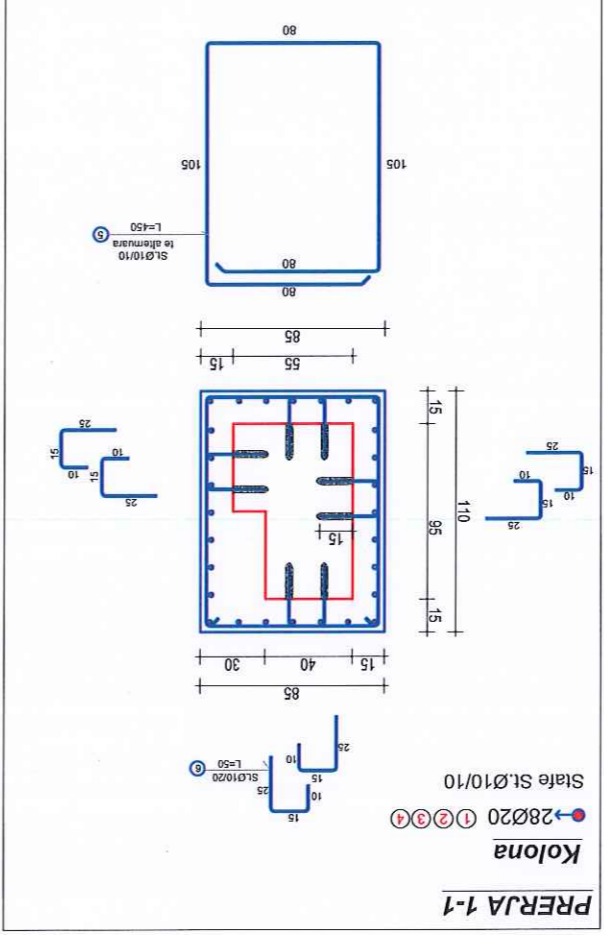
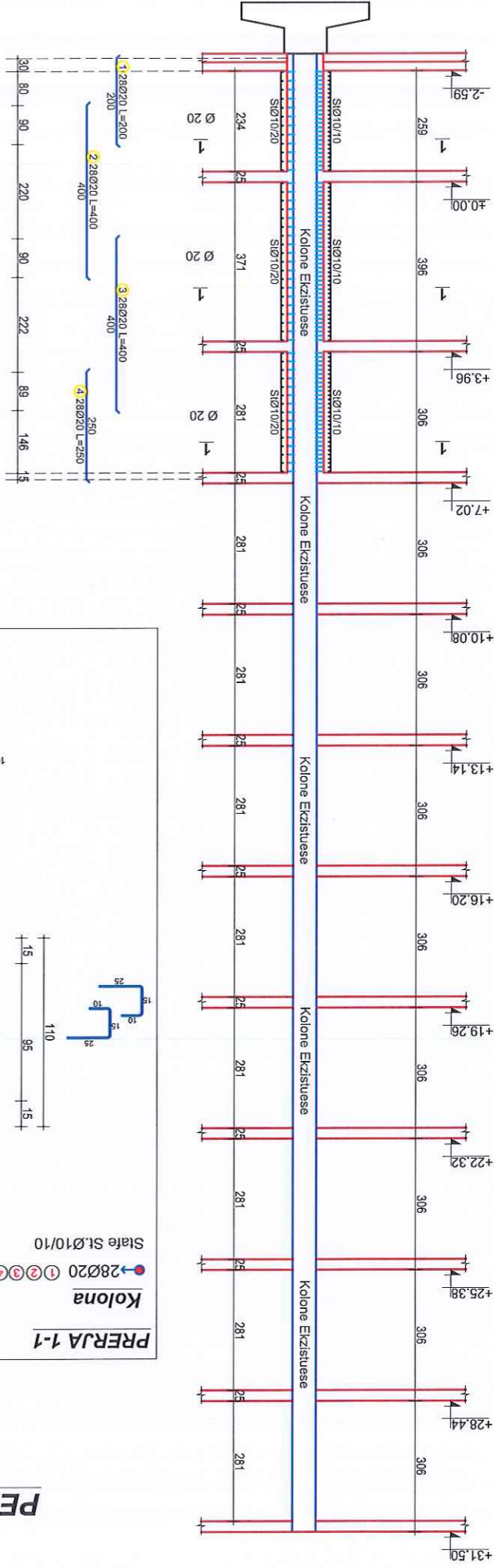
PERFORCIMI I KOLONAVE

(K2, K3, K4, K5, K6, K7, K8, K9, K10, K11, K12, K13, K14, K15, K38, K39, K40, K41, K42)



TABELA E SPECIFIKIMIT TE ARMATURES

Nr.	FORMA DHE PERMASAT			Ø	l	n	(totale)
	[cm]	[mm]	[m]				
1	200	20	4.00	20	24	24	48.00
2	400	20	4.00	20	24	24	96.00
3	400	20	4.00	20	24	24	96.00
4	250	20	2.50	20	24	24	60.00
5		10	4.21	10	91	91	383.11
6		10	0.50	10	368	368	184.00

Perforcimi i Kolonave, K2, K3, K4, K5, K6, K7, K8, K9, K10, K11, K12, K13, K14, K15, K38, K39, K40, K41, K42 (1 Cope)

Porositës Bashkia DURRES	Titledi i Projektit PROJEKT-ZBATIMI
Faza PERFORCIMI DHE RESTAURIMI I OBJEKTEVE TE PREKURA NGA TERMETI I 26.11.2019	Titledi i Vizatimit PERFORCIMI I KOLONAVE, K2, K3, K4, K5, K6, K7, K8, K9, K10, K11, K12, K13, K14, K15, K38, K39, K40, K41, K42
Shkalla Nr. i Fletës K-11	Kapitulli PROJEKTI I PERFORCIMIT
PROJEKTUES: "ARKONSTUDIO SH.P.K." Licensë N.6996/4 Administrator: Ing. KRENAR DILA	Ark. NDUE GJACI Ilic. A-0031/4
Ark. MASJEL CICO Ilic. A-1249/2	Ark. MARIO MUKA
Urb. XHESI ÇONIKU	Inzh. DHIMITER PAPA Ilic. K-15102

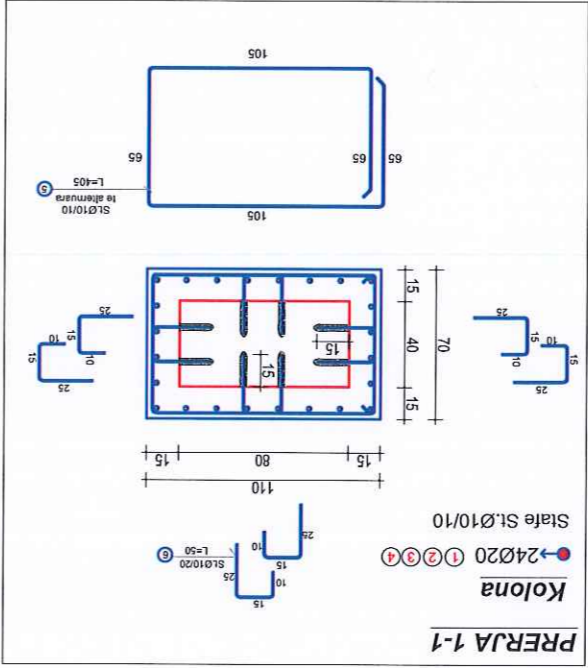
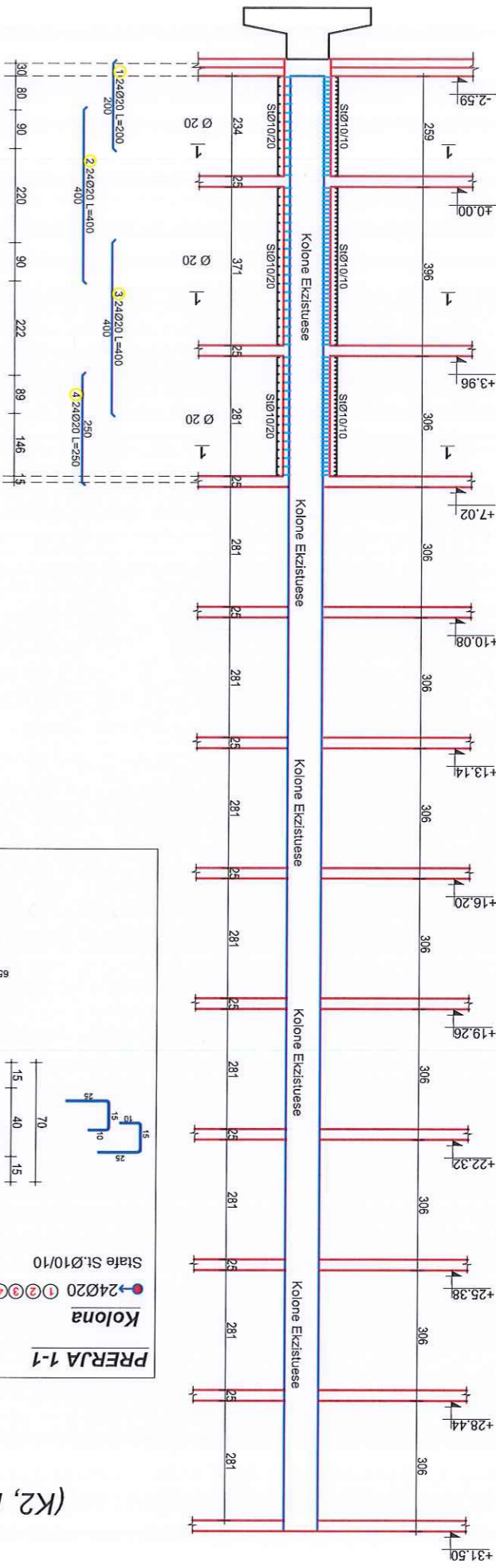
PERFORCIMI I KOLONAVE
(K21, K24, K26, K27, K29, K31, K32, K33, K34, K35, K36, K37, K43)



TABELA E SPECIFIKIMIT TE ARMATURES

Nr.	FORMA DHE PERMASAT		Ø	I [m]	n	n (totale)
	[cm]	[mm]				
1	200	170	14	2.00	28	56.00
2	170	170	14	1.70	28	47.60
3	125	65	8	4.61	24	110.64
4	25	15	8	0.50	144	72.00

Perforcimi i Kolonave ,K21, K24, K26, K27, K29, K31, K32, K33, K34, K35, K36, K37, K43 (1 Cope)

PROJEKTI I PERFORCIMIT

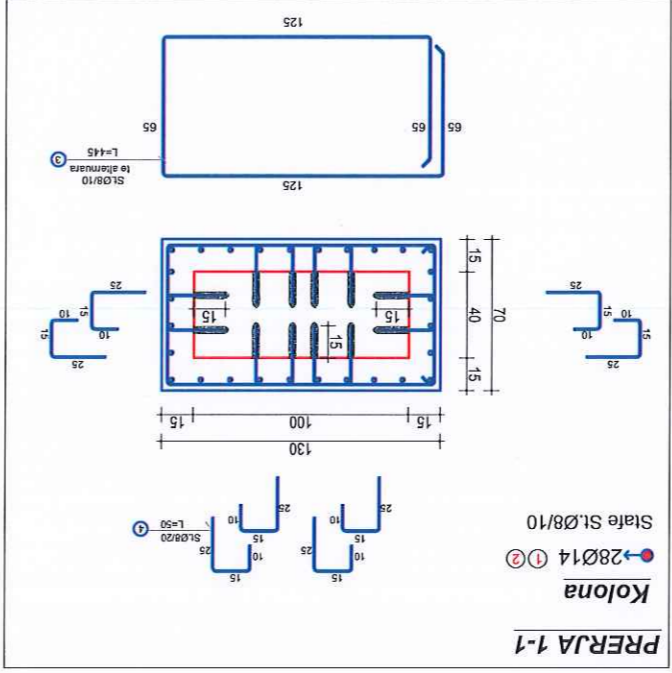
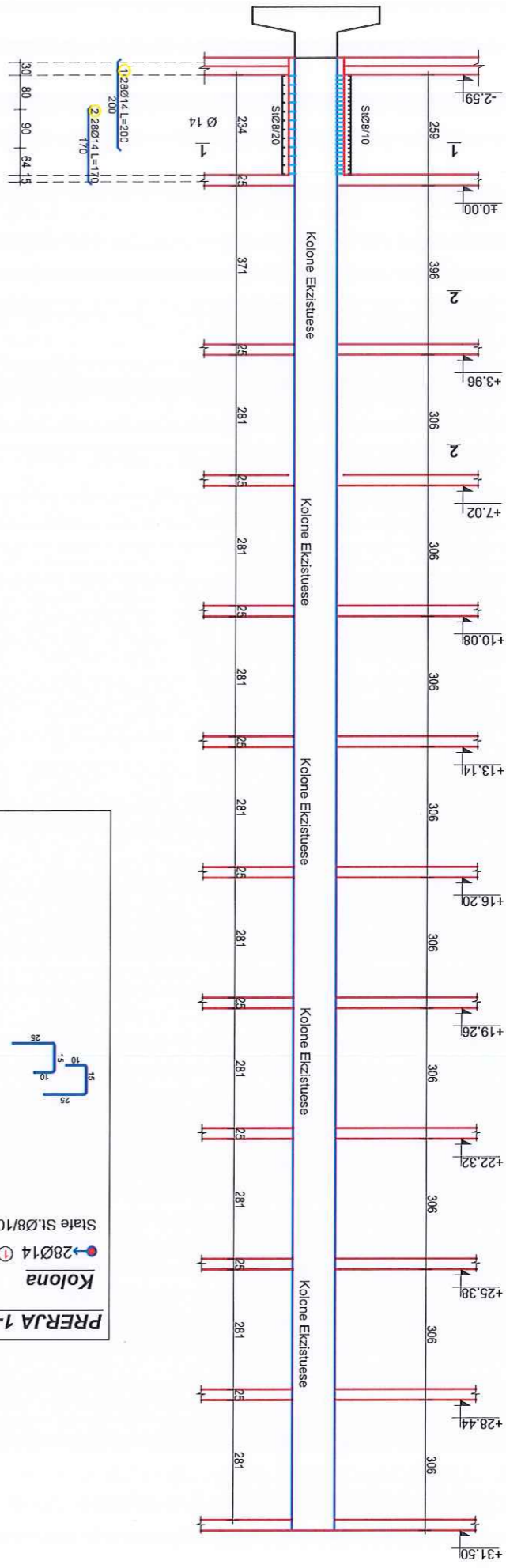
Tirulli i Vizatimit

PERFORCIMI I KOLONAVE, K21, K24, K26, K27, K29, K31, K32, K33, K34, K35, K36, K37, K43

Nr. i Fletës K-13

Shkalla

Kapitulli

PROJEKTI I PERFORCIMIT

PROJEKTUES: "ARKONSTUDIO SH.P.K." License N.6996/4 Administrator: Ing. KRENAR DILA

ART. NDUE GJACI Lic. A-0031/4

ART. MASJEL CICO Lic. A-1249/2

ART. MARIO MUKA

URP. XHESI CONKUR

INXH. DHIMITER PAPA Lic. K-15102

PROJEKTI I PERFORCIMIT

PERFORCIMI DHE RESTAURIMI I OBJEKTEVE TE PREKURA NGA TERMETI I 26.11.2019

Raza

PROJEKT-ZBATIMI

Tirulli i Projektit

Bashkia DURRES

Porositës

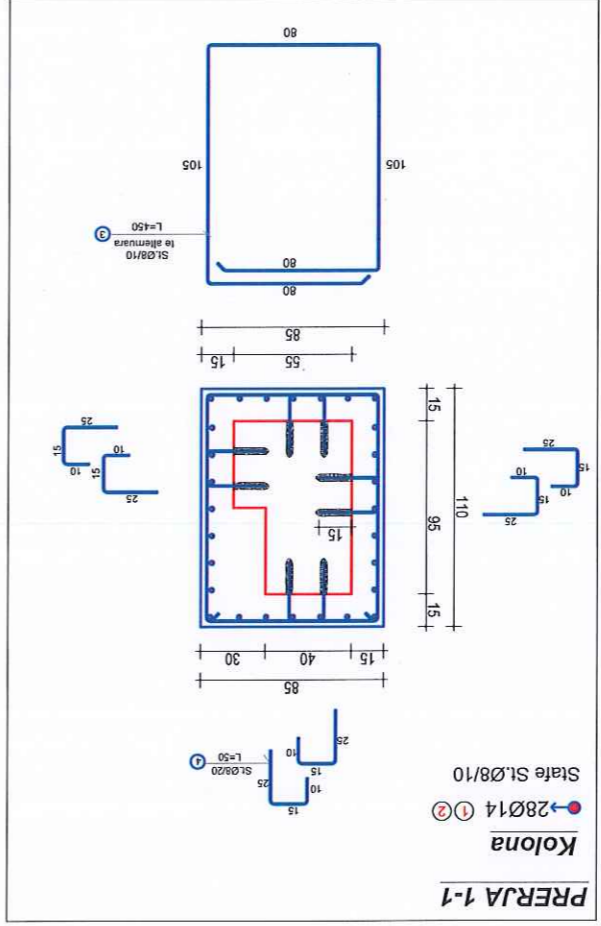
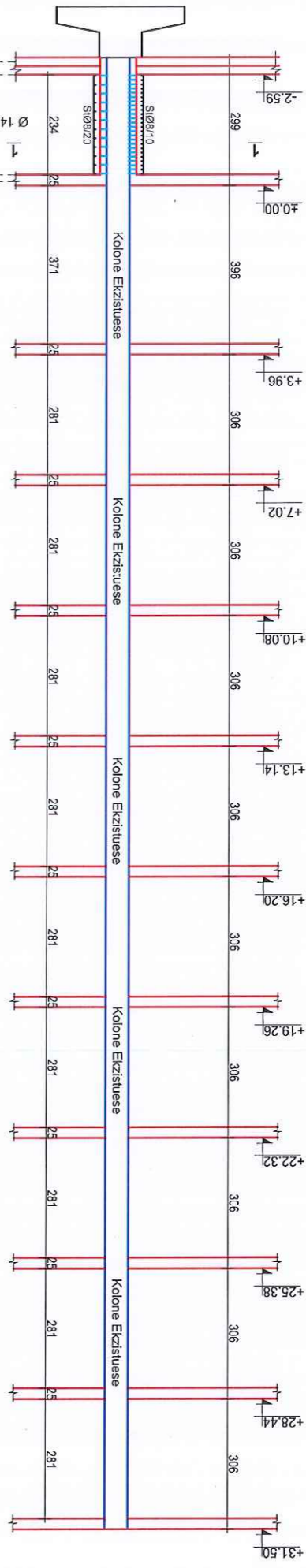

PERFORCIMI I KOLONAVE
(K44)

TABELA E SPECIFIKIMIT TE ARMATURES

Nr.	FORMA DHE PERMASAT			Ø [mm]	l [m]	n [cope]	n (totale) [m]	
	[cm]	[m]	[m]					
1	200	170	14	14	2.00	28	56.00	
2	170	170	14	14	1.70	28	47.60	
3	105	105	8	8	4.66	24	111.84	
4	25	15	8	8	0.50	96	48.00	
Perforcimi i Kolonave, K44 (1 Cope)								

<p>PROJEKTUES: "ARKONSTUDIO SH.P.K." License N.6996/4 Administrator: Ing. KRENAR DILA</p>	<p>Artk. NDUE GJACI Ic. A-0031/4</p> <p>Artk. MASJEL CICO Ic. A-1249/2</p> <p>Artk. MARIO MUKA</p> <p>Urb. XHESI GONIKU</p> <p>Inzh. DHIMITER PAPA Ic. K1510/2</p>
<p>PROJEKTI I PERFORCIMIT</p>	<p>Titulli i Vizatimit</p> <p>PERFORCIMI I KOLONAVE, K44</p>
<p>Shkalla</p> <p>Nr. i Pletës</p> <p>K-14</p>	
<p>Porositës</p> <p>Bashkia DURRES</p>	<p>Faza</p> <p>PROJEKT-ZBATIMI</p>
<p>Titulli i Projektit</p> <p>PERFORCIMI DHE RESTAURIMI I OBJEKTEVE TE PREKURA NGA TERMETI I 26.11.2019</p>	<p>Kapitulli</p> <p>PROJEKTI I PERFORCIMIT</p>

PERFORCIMI I KOLONAVE

(K45)



TABELA E SPECIFIKIMIT TE ARMATURES

Nr.	FORMA DHE PERMASAT		Ø	I	n	l (totale) [m]
	[cm]	[mm]				
1	200	170	14	2.00	24	48.00
2	170	170	14	1.70	24	40.80
3	105	65	8	4.21	24	101.04
4	25	15	8	0.50	96	48.00

Perforcimi i Kolonave, K45 (1 Cope)

Porositës
Bashkia DURRES

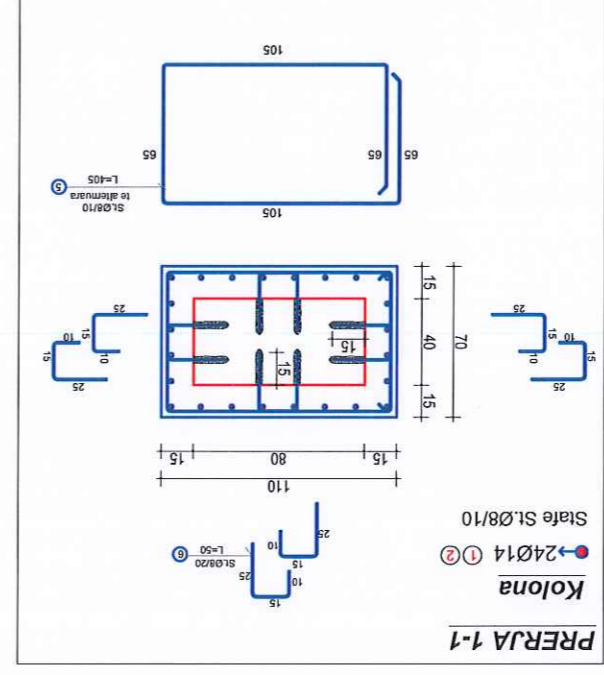
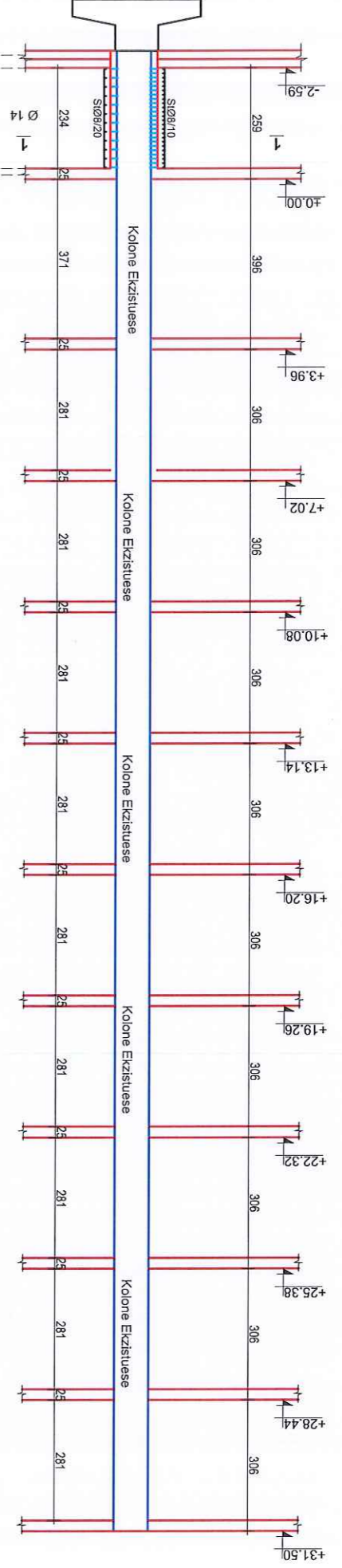
Paza
PROJEKT-ZBATIMI

Titulli i Projektit
PERFORCIMI DHE RESTAVRIMI I OBUKTEVE TE PREKURA NGA TERMETI I 26.112019

PROJEKTUES:
"ARKONSTUDIO SH.P.K."
Licensë N.6996/4
Administrator:
Ing. KRENAR DILA

ARKONSTUDIO

Ark. NDUE GJACI Ing. A-0031/4
Ark. NASJEL ÇIÇO Ing. A-1249/2
Ark. MARIO MUKA
Urb. XHESI ÇONIKU Ing. K-16102
Inzh. DHIMITER PAPA Ing. K-16102

Kapitulli PROJEKTI I PERFORCIMIT	Titulli i Vizatimit PERFORCIMI I KOLONAVE, K45
Shkalla Nr. i Fletës K-15	

PERFORCIMI I KOLONAVE ME MURE B/A
(M1, M2, M5, M6)

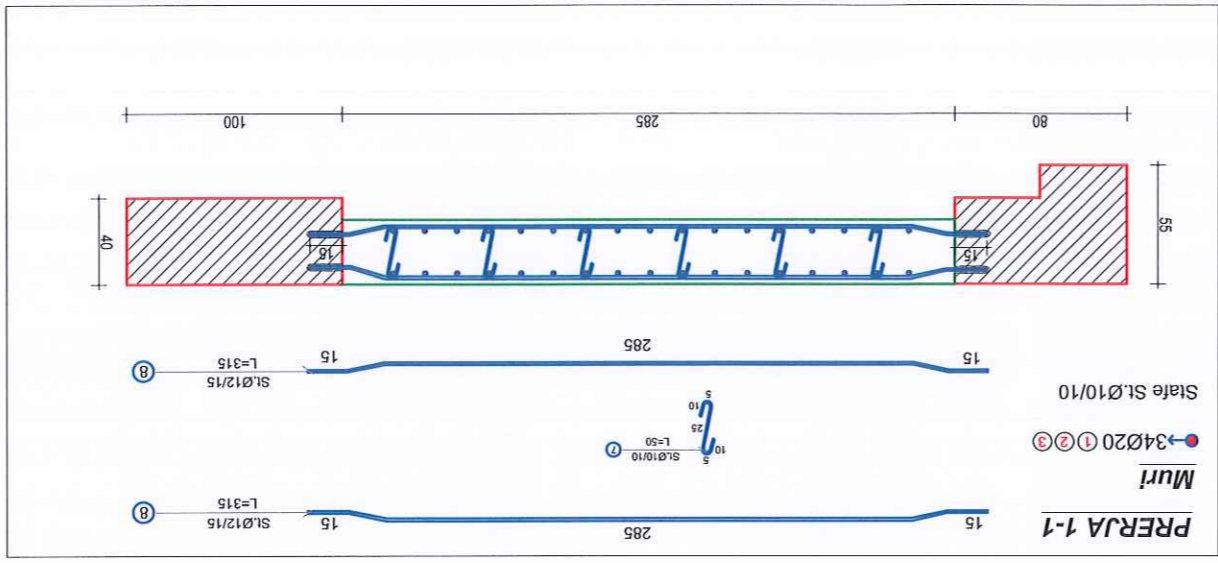
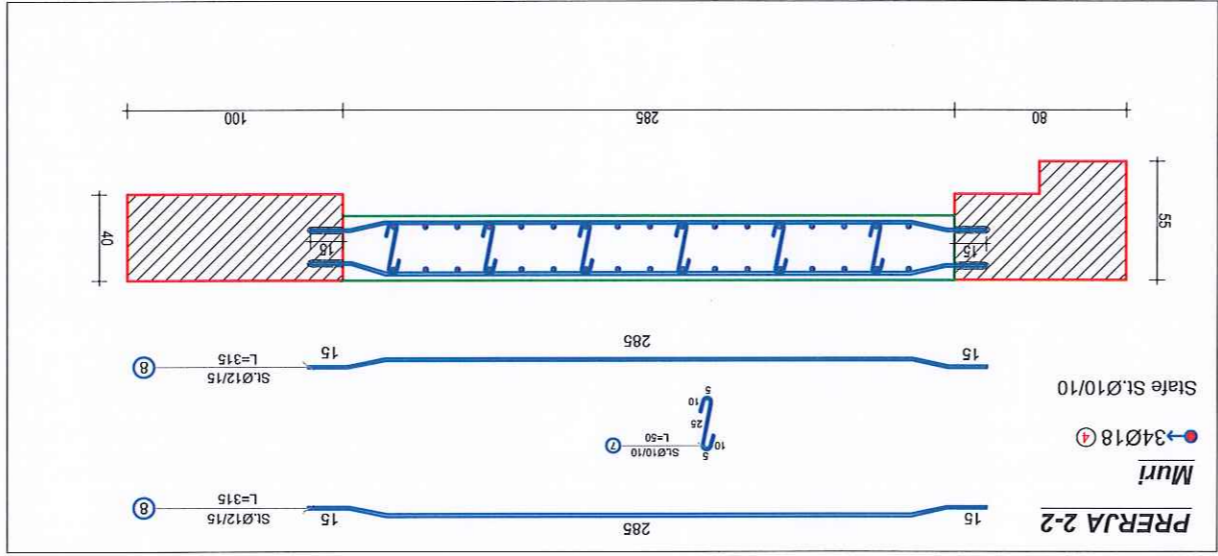
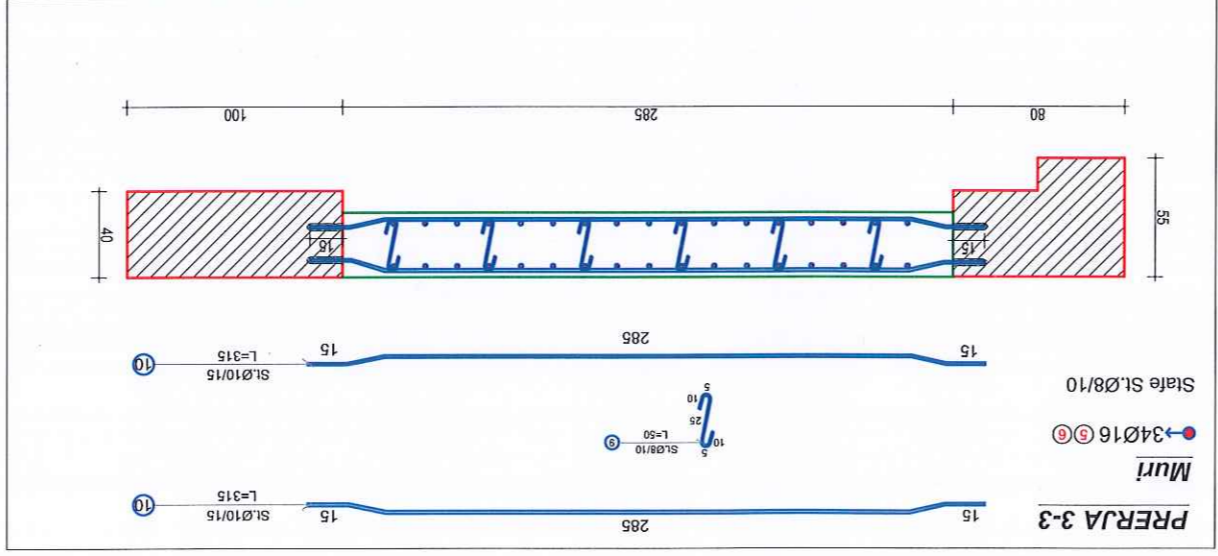
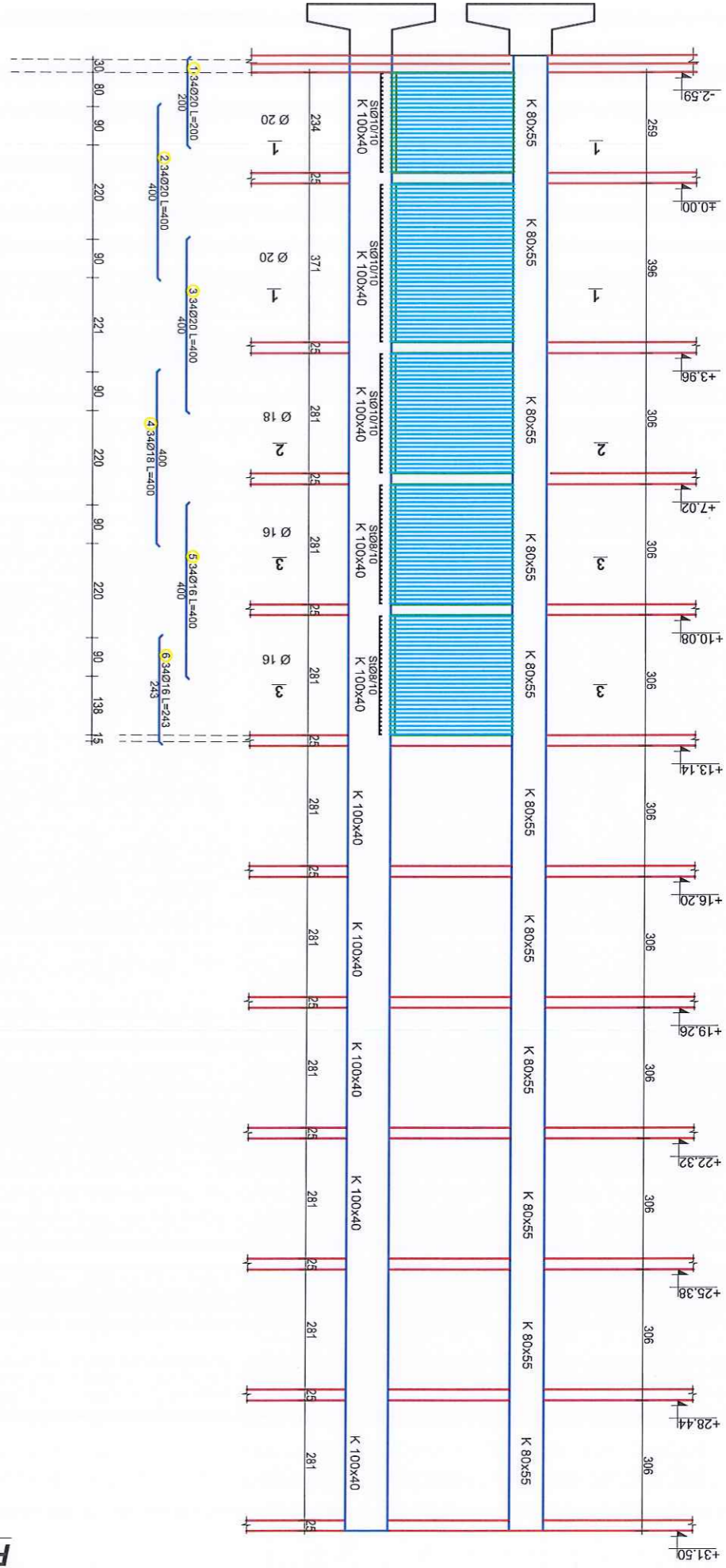

Porositës		Bashkia DURRES		Faza		PROJEKT-ZBATIMI		Titulli i Projektit		PERFORCIMI DHE RESTAURIMI I OBJEKTEVE TE PREKURA NGA TERMETI I 26.11.2019		PROJEKTUES:		"ARKONSTUDIO SH.P.K." Licensë N.6996/4		Administrator:		Ing. KRENAR DILA		ARKONSTUDIO		Ark. NDUE GJACI		Ing. A-0031/4		Ark. NASJEL ÇIÇO		Ing. A-1249/2		Ark. MARIO MUKA		Urb. XHESI CONIKU		ARKONSTUDIO		Urb. XHESI CONIKU		Ing. K.15102		Inzh. DHIMITER PAPA		KAPITULLI		PROJEKTI I PERFORCIMIT		Titulli i Vizatimit		PERFORCIMI I KOLONAVE ME MURE B/A, M1, M2, M5, M6		Shkalla		Nr. i Fletës		K-16	
-----------	--	----------------	--	------	--	-----------------	--	---------------------	--	---	--	-------------	--	--	--	----------------	--	------------------	--	-------------	--	-----------------	--	---------------	--	------------------	--	---------------	--	-----------------	--	-------------------	--	-------------	--	-------------------	--	--------------	--	---------------------	--	-----------	--	------------------------	--	---------------------	--	---	--	---------	--	--------------	--	------	--

Handwritten signature: *KONS. DH. PAPA*

Stamp: **PROJEKTI I PERFORCIMIT**

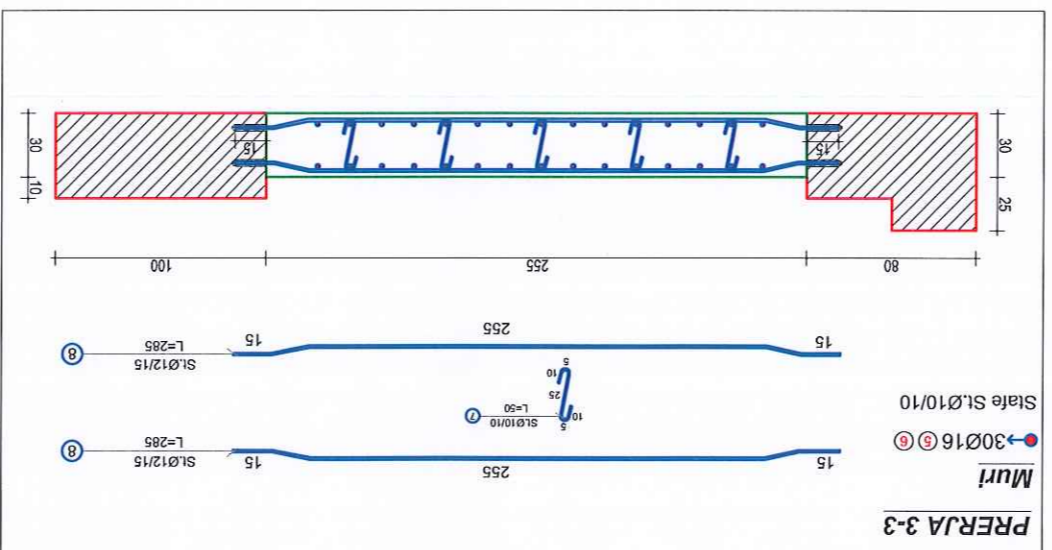
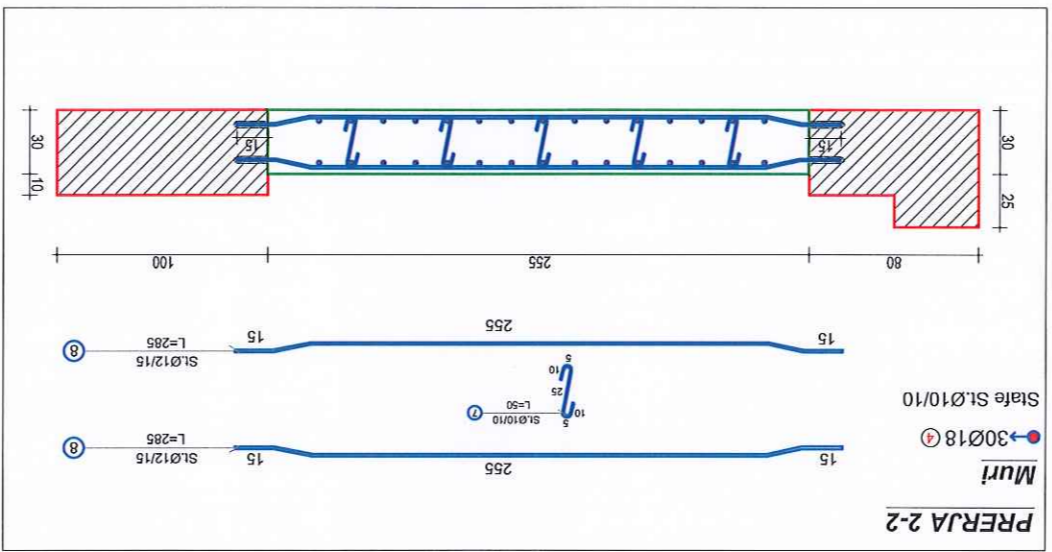
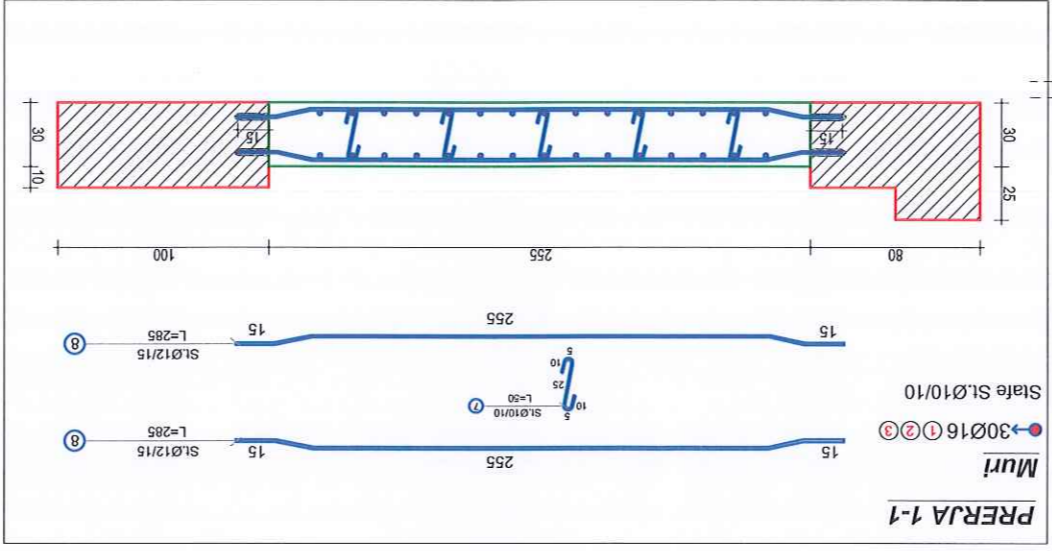
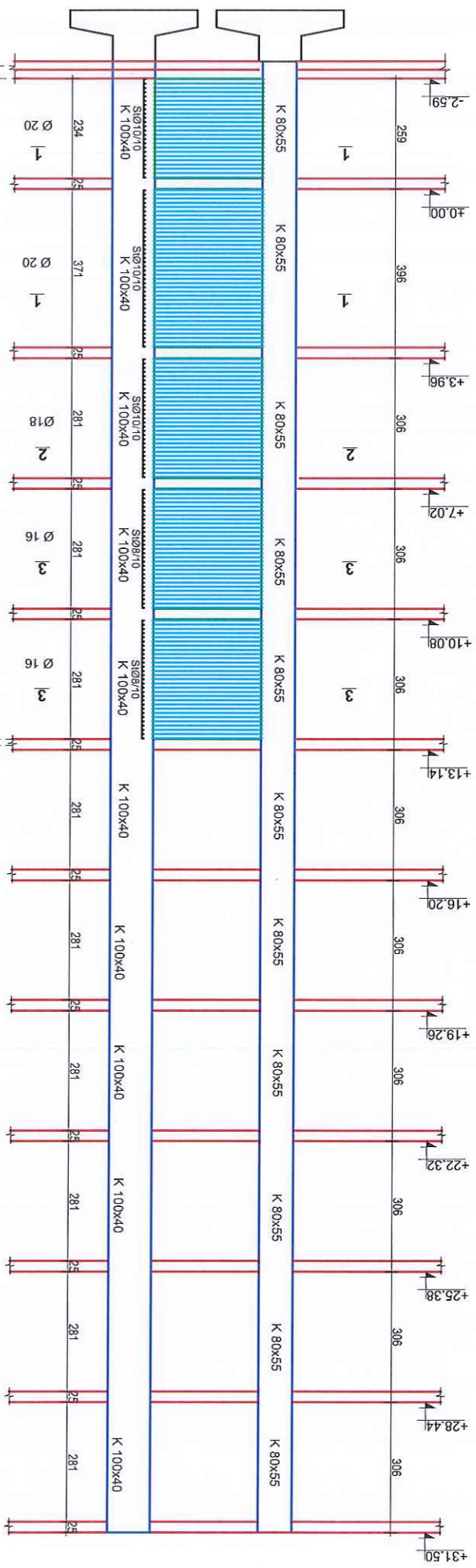

PERFORCIMI I KOLONAVE ME MURE B/A
(M3, M4, M7, M8)







Porositës	Bashkia DURRES
Faza	PROJEKT-ZBATIMI
Titulli i Projektit	PERFORCIMI DHE RESTAURIMI I OBEKTEVE TE PREKURA NGA TERMETI I 26.112019
PROJEKTUES:	"ARKONSTUDIO SH.P.K."
Administrator:	Licensë N.6996/4
Ing. KREMAR DILA	ARKONSTUDIO
Artk. NDUE GJACI	Ip. A-0031/4
Artk. NASJEL CICO	Ip. A-1249/2
Artk. MARIO MUKA	
Urb. XHESI ÇONKU	ARKONSTUDIO
Inzh. DHIMITER PAPA	Ip. K-1810/2
Lic. 42019/004	
Kapitulli	PROJEKTI I PERFORCIMIT
Titulli i Vizatimit	PERFORCIMI I KOLONAVE ME MURE B/A, M3, M4, M7, M8
Shkallia	Nr. i Fletës K-18

PROJEKTUES
KONS. DR. PAPA

PERFORCIMI I KOLONAVE ME MURE B/A

(M3, M4, M7, M8)

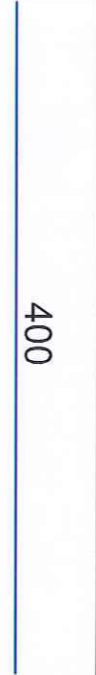
TABELA E SPECIFIKIMIT TE ARMATURES

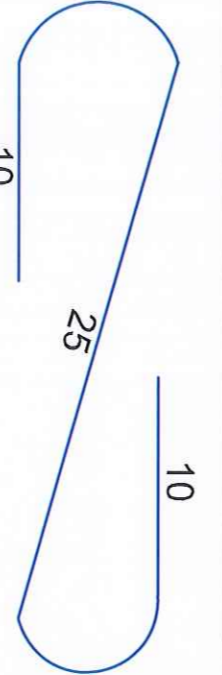
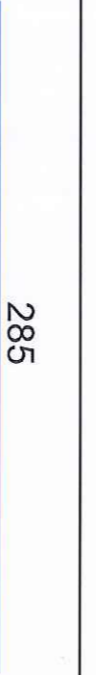
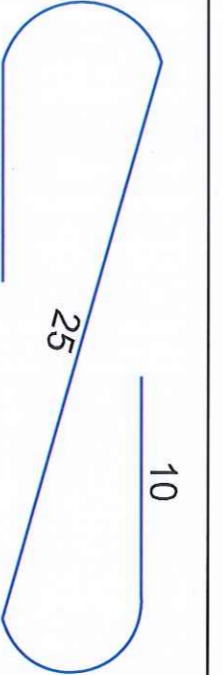
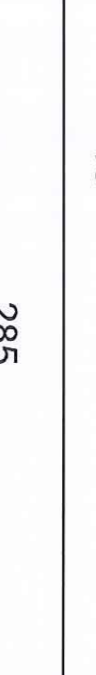
Nr.	FORMA DHE PERMASAT [cm]	Ø [mm]	l [m]	n [cope]	l(totale) [m]
Perforcimi i Kolonave me Mure B/A, M3, M4, M7, M8 (1 Cope)					
1		20	2.00	30	60.00
2		20	4.00	30	120.00
3		20	4.00	30	120.00
4		18	4.00	30	120.00
5		16	4.00	30	120.00
6		16	2.40	30	72.00
7		10	0.55	455	250.25
8		12	2.85	120	342.00
9		8	0.55	290	159.50
10		10	2.85	76	216.60

Shkalla		Nr. i Fletës		K-19	
Titulli i Vizatimit		PERFORCIMI I KOLONAVE ME MURE B/A, M3, M4, M7, M8			
Kapitulli		PROJEKTI I PERFORCIMIT			
Ark. NDUE GJACI	Ng. A-0031/4	Ark. NASJEL GJCO	Ng. A-1249/2	Ark. MARIO MUKA	Urb. XHESTI CONIKU
Ing. KRENDAR DILA		Ing. KRENDAR DILA			
Administrator:		Administrator:			
License N.6996/4		License N.6996/4			
PROJEKTUES:		PROJEKTUES:			
"ARKONSTUDIO SH.P.K."		"ARKONSTUDIO SH.P.K."			
Titulli i Projektit		PERFORCIMI DHE RESTAURIMI I OBUKTEVE TE PREKURA NGA TERMETI I 26.112019			
Faza	PROJEKT-ZBATIMI				
Porositës	Bashkia DURRES				

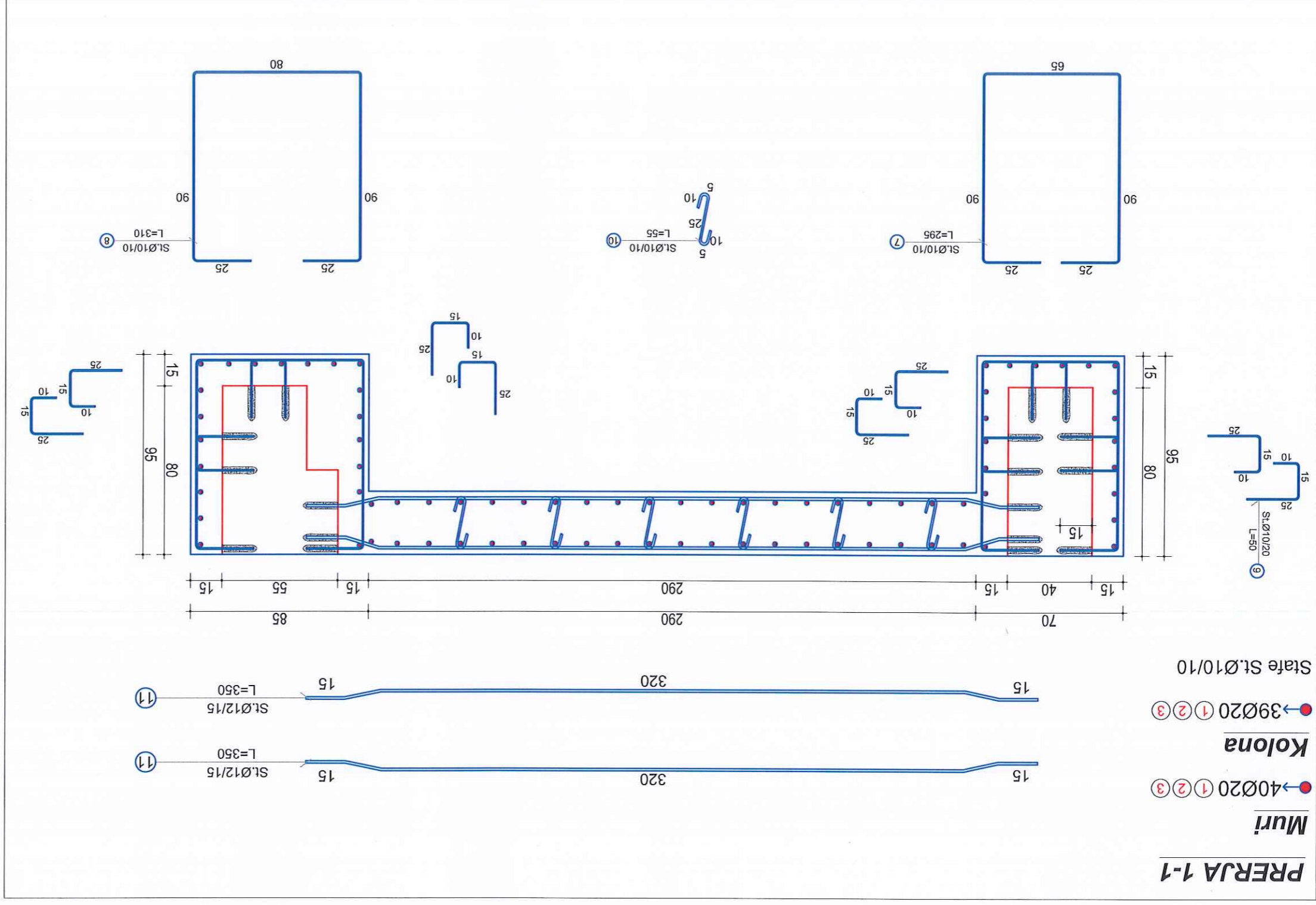

 Nr. i Fletës: K-19
 Titulli i Vizatimit: PERFORCIMI I KOLONAVE ME MURE B/A, M3, M4, M7, M8

PERFORCIMI I KOLONAVE ME MURE B/A
(M9)





KONS. DR. PAPA
PROJEKTI-M-2011

PROJEKTI I PRFORCIMIT Kapitulli	Nr. i Pletës K-21
Titulli i Vizatimit PERFORCIMI I KOLONAVE ME MURE B/A, M9	
Shkalla 1:1	
Porositës Bashkia DURES	
Faza PROJEKT-ZBATIMI	
Thulli i Projektit PERFORCIMI DHE RESTAURIMI I OBJEKTEVE TE PREKURA NGA TERMETI I 26.11.2019	
PROJEKTUES: "ARKONSTUDIO SH.P.K." License N.6996/4 Administrator: Ing. KRENAR DILA	
	Ark. NDUE GJACI Ilic. A-0031/4 Ark. NASJEL CICO Ilic. A-1249/2 Ark. MARIO MURKA Ark. XHESI ÇONKU Urb. XHESI ÇONKU Inzh. DHIMITER PAPA Ilic. K.1510/2 ARKONSTUDIO PROJEKTI-M-2011 L-2000/1

PERFORCIMI I KOLONAVE ME MURE B/A

(M9)

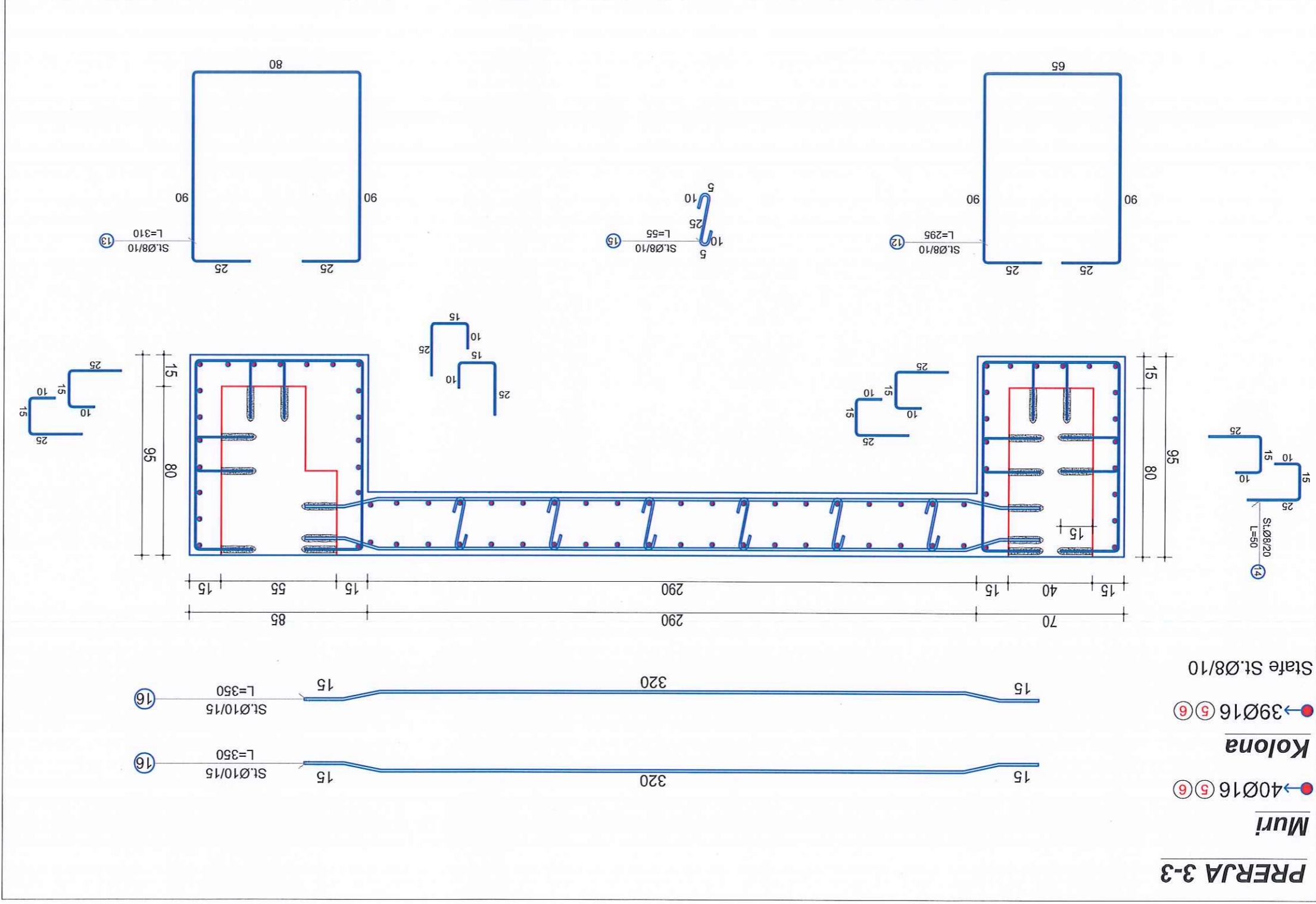

PRERJA 3-3

Muri

→40Ø16 (5) (6)

Kolona

→39Ø16 (5) (6)

Stafë St.Ø8/10

Porositës		Bashkia DURRES	
Faza		PROJEKT-ZBATIMI	
Titulli i Projektit		PERFORCIMI DHE RESTAURIMI I OBIKTEVE TE PREKURA NGA TERMETI I 26.11.2019	
PROJEKTUES:		"ARKONSTUDIO SH.P.K."	
Administrator:		Ing. KRENAR DILA	
License N.6996/4			
Ark. NDUE GJACI		Ilg. A-0031/4	
Ark. NASJEL GJGO		Ilg. A-1249/2	
Ark. MARIO MURKA			
Urb. XHEBI CONIKU			
Inzh. DHIMITER PAPA		Ilg. K15102	
Kapitulli		PROJEKTI I PERFORCIMIT	
Titulli i Vizimit		PERFORCIMI I KOLONAVE ME MURE B/A , M9	
Shkalla		Nr. i Pletës K-23	

ARMIMI I KAFAZIT TE ASHENSORIT

(MA1 DHE MA3)



TABELA E SPECIFIKIMIT TE ARMATURES

Nr	FORMA DHE PERMASAT	Ø [mm]	l [m]	n	n (totale)	Armimi i Kafazit te Ashensorit MA1 dhe MA3 (1 Cope)		
						[m]	[m]	[m]
1	200	20	2.00	224	448.00			
2	400	20	4.00	224	896.00			
3	400	20	4.00	224	896.00			
4	400	18	4.00	216	864.00			
5	400	16	4.00	216	864.00			
6	400	16	4.00	216	864.00			
7	240	16	2.40	216	518.40			
8	20 20 30	10	1.16	356	412.96			
9	15 15 40 40	10	1.26	712	897.12			
10	15 15 30 30	10	1.06	712	754.72			
11	30 30 55 95	10	2.10	356	747.60			
12	30 30 55 125	10	2.40	356	854.40			
13	15 15 10 25	10	0.50	1456	728.00			
14	5 5 10 20 10	10	0.50	712	356.00			
15	5 5 10 15 10	10	0.45	2136	961.20			
16	5 5 10 25 10	10	0.55	1780	979.00			
17	240	12	2.40	468	123.20			
18	20 15 250	12	2.85	234	666.90			
19	25 15 40	12	0.80	234	187.20			
20	185 10	12	2.05	234	479.70			
21	250 10	12	2.70	468	263.60			

Porositës
Bashkia DURRES

Faza
PROJEKT-ZBATIMI

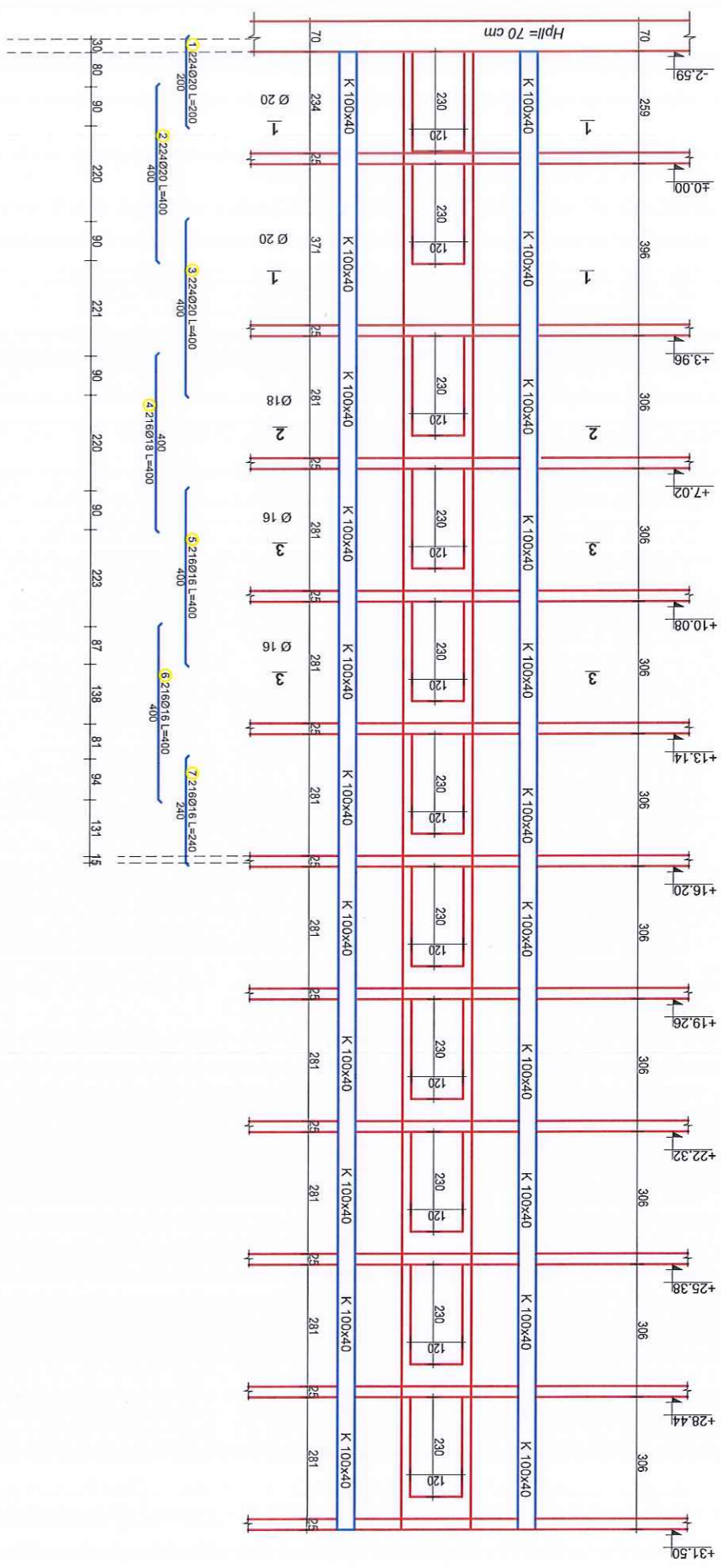
Titulli i Projektit
PERFORCIMI DHE RESTAURIMI I OBJEKTEVE TE PREKURA NGA TERMETI I 26.112019

PROJEKTUES:
"ARKONSTUDIO SH.P.K."
License N.6996/4
Administrator:
Ing. KRENAR DILA

Ark. NDVE GJACI
Ilg. A-0031/4

Ark. NASJEL ÇIÇO
Ilg. A-1249/2

Ark. MARIO MUKA

Urb. XHESI ÇONIKU

Inzh. DHIMITER PAPA
Ilg. K-15102

Kapitulli
PROJEKTI I PERFORCIMIT

Titulli i Vizatimit
ARMIMI I KAFAZIT TE ASHENSORIT MA1 DHE MA3



Shkalla
Nr. i Fletës
K-24

ARKONSTUDIO
PROJEKTI
KONS. DH. PAPA

ARMIMI I KAFAZIT TE ASHENSORIT

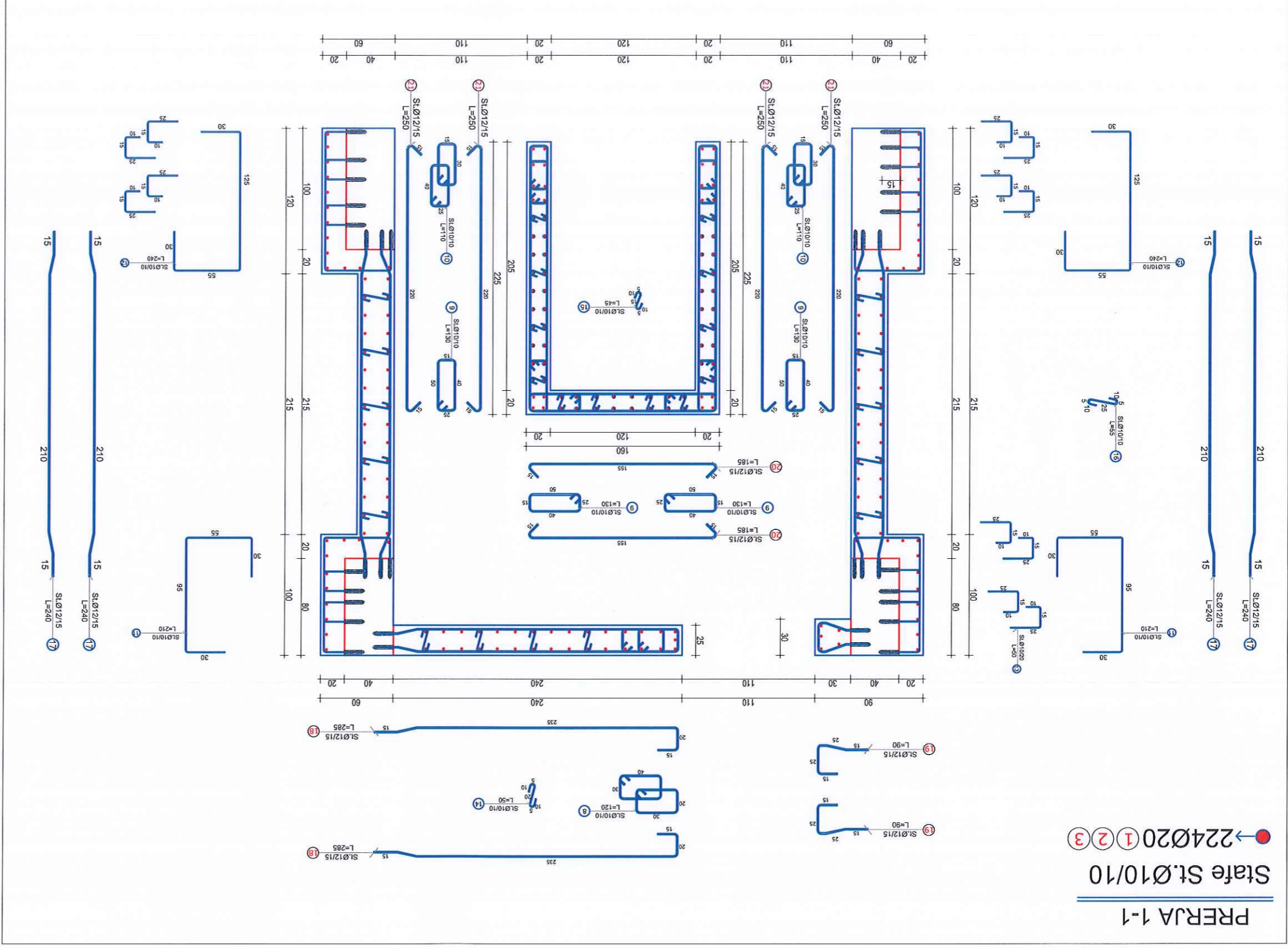
(MA1 DHE MA3)



Porositës		Bashkia DURRES		Faza		PROJEKT-ZBATIMI		Titulli i Projektit		PERFORMIMI DHE RESTAURIMI I OBUKTEVE TE PREKURA NGA TERMETI I 26.11.2019		PROJEKTUES:		"ARKONSTUDIO SH.P.K." Licensë N.6996/4 Administrator: Ing. KRENAR DILA		 ARKONSTUDIO Ark. NDUE GJACI Lic. A-0031/4 Ark. NASREL ÇIÇO Lic. A-1249/2 Ark. MARIO MUKA Urb. XHEBI ÇONKU Inzh. DHIMITER PAPA Lic. K.1510/2 PROJEKTIM/INZHINIERIM LKSO 050/11		Kapitulli		PROJEKTI I PERFORCIMIT		Titulli i Vizatimit		ARMIMI I KAFAZIT TE ASHENSORIT MA1 DHE MA3		Shkallja		Nr. i Fletës		K-25		 KONS. DH. PAPA PROJEKTIM/INZHINIERIM	
-----------	--	----------------	--	------	--	-----------------	--	---------------------	--	--	--	-------------	--	--	--	--	--	-----------	--	------------------------	--	---------------------	--	--	--	----------	--	--------------	--	------	--	---	--

ARMIMI I KAFAZIT TE ASHENSORIT

(MA1 DHE MA3)

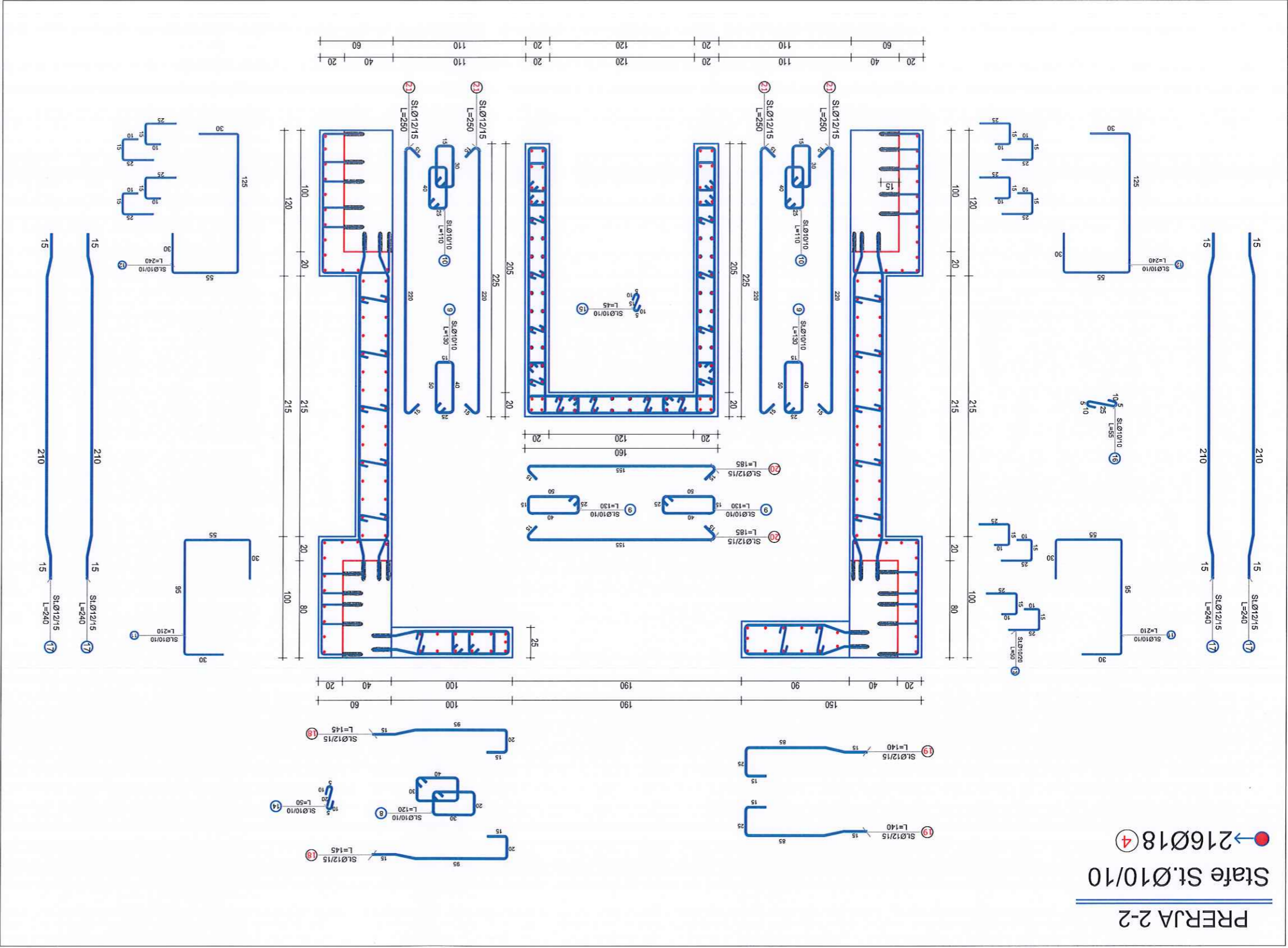

Porositë		Bashkia DURRES		Faza		PROJEKT-ZBATIMI		Titulli i Projektit		PERFORCIMI DHE RESTAURIMI I OBJEKTEVE TE PREKURA NGA TERMETI I 26.11.2019		PROJEKTUES:		"ARKONSTUDIO SH.P.K." Licensë N.6996/4 Administrator: Ing. KRENAR DILA		Ark. NDUE GJACI Ish. A-0031/4		Ark. NASJEL ÇICO Ish. A-1249/2		Ark. MARIO MUKA		Urb. XHESI ÇONIKU		Inxh. DHIMITER PAPA Ish. K.1310/2		Kapitulli		PROJEKTI I PERFORCIMIT		Titulli i Vizatimit		ARMIMI I KAFAZIT TE ASHENSORIT MA1 DHE MA3		Shkalla		Nr. i Fletës K-26	
----------	--	----------------	--	------	--	-----------------	--	---------------------	--	---	--	-------------	--	---	--	----------------------------------	--	-----------------------------------	--	-----------------	--	-------------------	--	--------------------------------------	--	-----------	--	------------------------	--	---------------------	--	--	--	---------	--	----------------------	--

ARKONSTUDIO
PROJEKTIM I
KONS. DH. PAPA

ARMIMI I KAFAZIT TE ASHENSORIT

(MA1 DHE MA3)

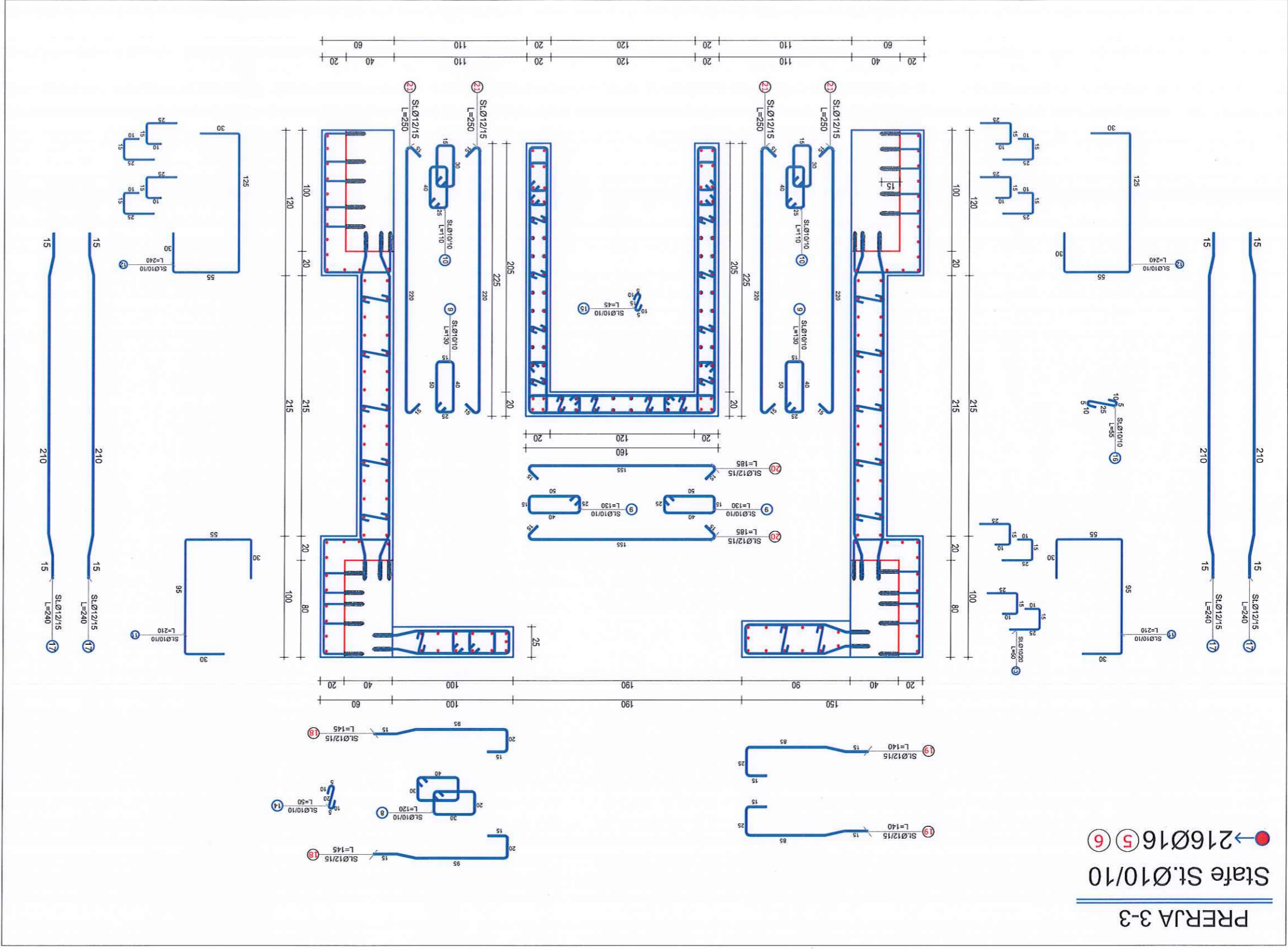

Porositës		Bashkia DURRES		Faza		PROJEKT-ZBATIMI		Titulli i Projektit		PERFORCIMI DHE RESTAURIMI I OBUKTEVE TE PREKURA NGA TERMETI I 26.11.2019		PROJEKTUES:		"ARKONSTUDIO SH.P.K." License N.6996/4 Administrator: Ing. KRENAR DILA		Ark. NDUE GJACI Iig. A-0031/4 Ark. MASJEL CICO Iig. A-1249/2 Ark. MARIO MUKA Urb. XHESI ÇONIKU Iinxh. DHIMITER PAPA Iig. K.15102		Kapitulli		PROJEKTI I PERFORCIMIT		Titulli i Vizatimit		ARMIMI I KAFAZIT TE ASHENSORIT MA1 DHE MA3		Shkallia		Nr. i Fletës		K-27	
-----------	--	----------------	--	------	--	-----------------	--	---------------------	--	--	--	-------------	--	--	--	--	--	-----------	--	------------------------	--	---------------------	--	--	--	----------	--	--------------	--	------	--

ARKONSTUDIO SH.P.K.
PAPA

ARMIMI I KAFAZIT TE ASHENSORIT

(MA2)



TABELA E SPECIFIKIMIT TE ARMATURES		Nr. FORMA DHE PERMASAT		Armimi i Kafazit te Ashensorit MA2 (1 Cope)	
Ø [mm]	l [m]	Ø [mm]	l [m]	Ø [mm]	l [m]
n	(totale) [m]	n	(totale) [m]		
20	300	20	300	20	600.00
400	300	400	300	400	200.00
400	300	400	300	400	200.00
400	294	400	294	400	176.00
400	294	400	294	400	176.00
400	294	400	294	400	176.00
400	294	400	294	400	176.00
400	294	400	294	400	176.00
240	294	240	294	240	705.60
20	356	20	356	20	412.96
30	40	30	40	30	12.96
15	40	15	40	15	897.12
15	40	15	40	15	897.12
15	30	15	30	15	754.72
25	70	25	70	25	466.72
45	70	45	70	45	466.72
20	145	20	145	20	157.00
45	60	45	60	45	157.00
15	25	15	25	15	157.00
10	100	10	100	10	400.50
5	10	5	10	5	762.20
5	10	5	10	5	762.20
5	10	5	10	5	961.20
5	10	5	10	5	961.20
5	10	5	10	5	356.00
5	10	5	10	5	356.00
20	330	20	330	20	854.10
15	20	15	20	15	854.10
460	468	460	468	460	152.80
205	234	205	234	205	479.70
250	468	250	468	250	170.00

PROJEKT-ZBATIMI

Bashkia DURES

Porositës

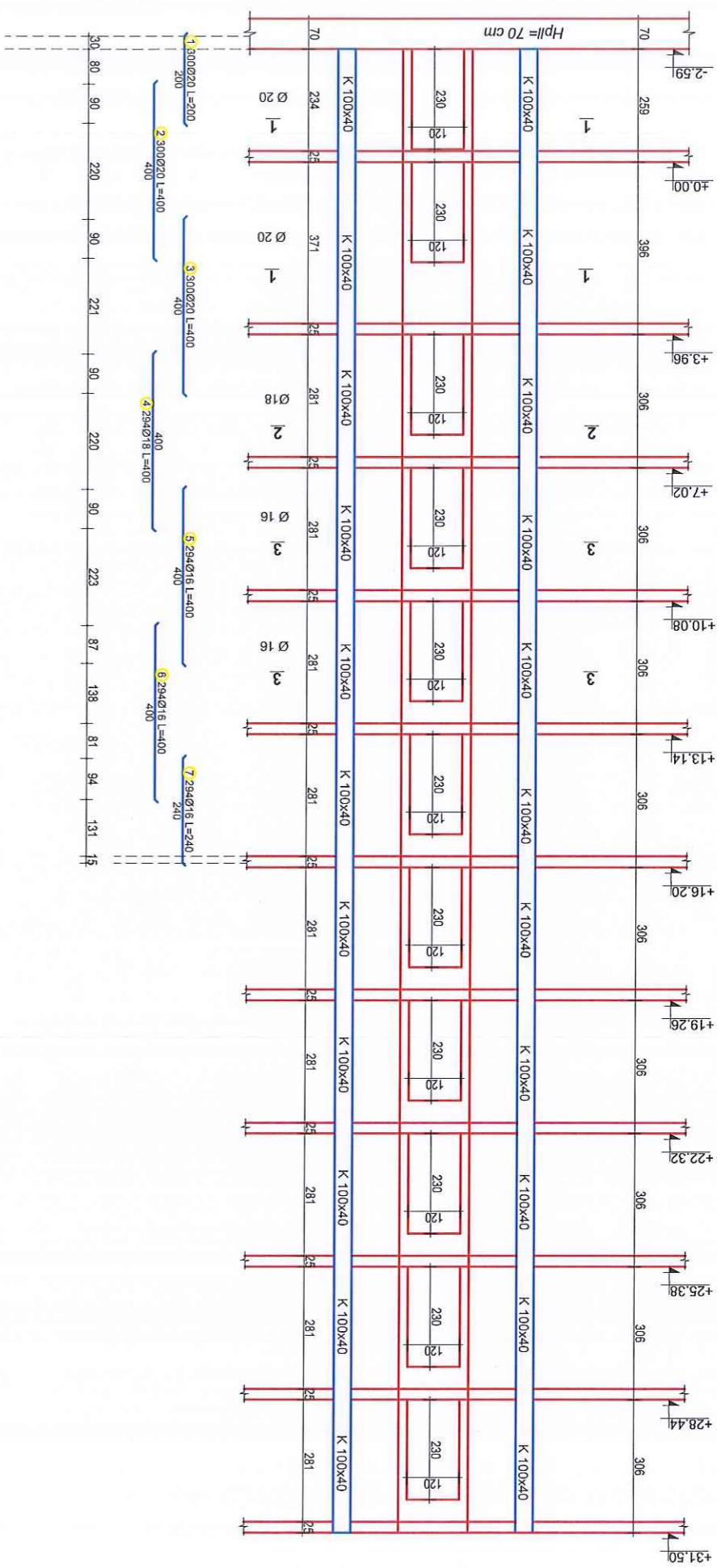
Faza

Titulli i Projektit

PERFORCIMI DHE RESTAURIMI I OBJEKTEVE TE PREKURA NGA TERMETI I 26.11.2019

PROJEKTUES:

"ARKONSTUDIO SH.P.K."

License N.6996/4

Administrator:

Ing. KRENAR DILA

Ark. NDUE GJACI
Iq. A-0031/4

Ark. NASJEL GJCO
Iq. A-1249/2

Ark. MARIO MURKA

Urb. XHEBI ÇONIKU

Inzh. DHIMITER PAPA
Iq. K.1510/2

Kapitulli

PROJEKTI I PERFORCIMIT

Titulli i Vizatimit

ARMIMI I KAFAZIT TE ASHENSORIT MA2

Shkalla

Nr. i Pletës

K-28

KONS. DH. PAPA

ARMIMI I KAFAZIT TE ASHENSORIT
(MA2)

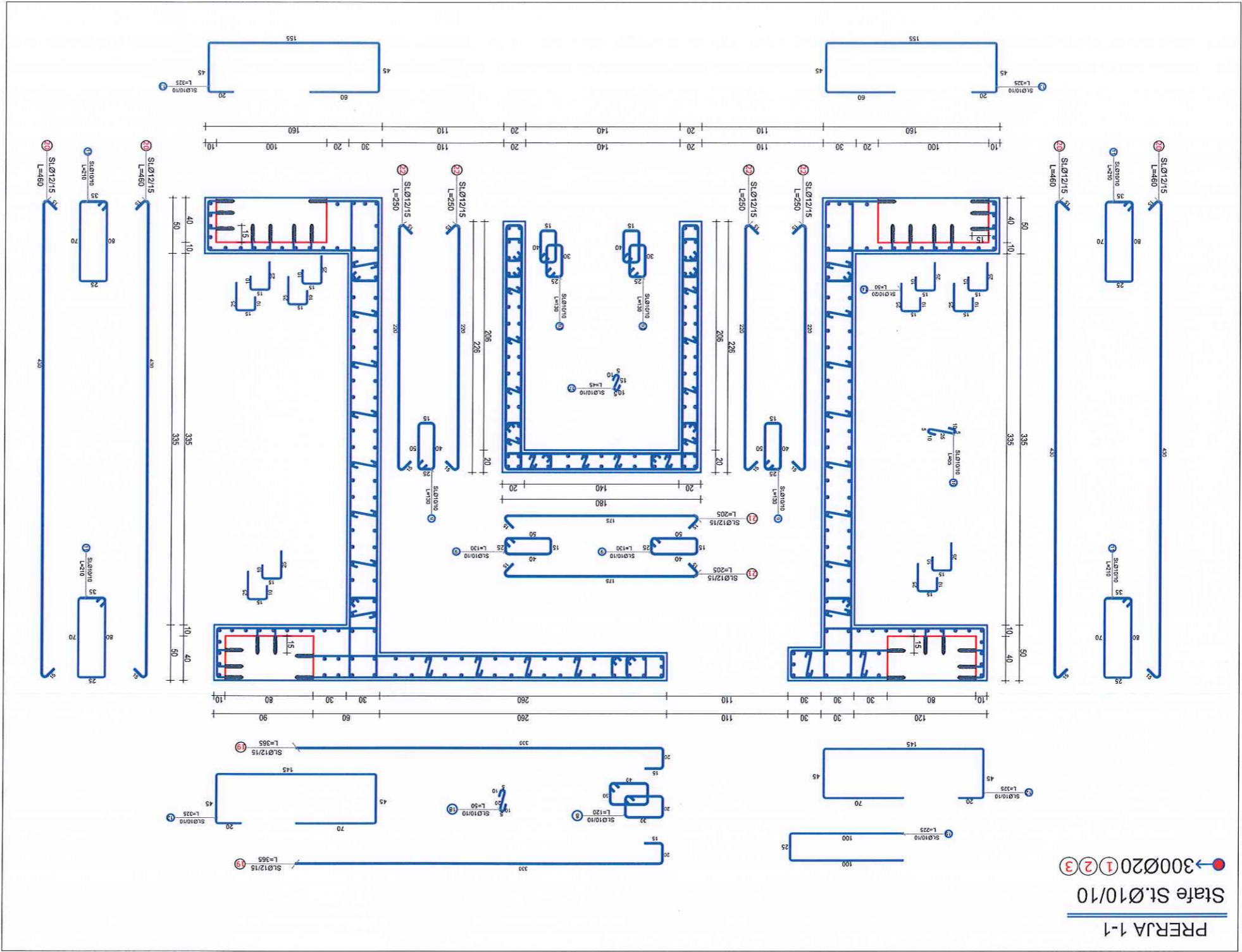

Porositës		Bashkia DURRES	
Faza		PROJEKT-ZBATIMI	
Titulli i Projektit		PERFORCIMI DHE RESTAURIMI I OBJEKTEVE TE PREKURA NGA TERMETI I 26.11.2019	
PROJEKTUES:		"ARKONSTUDIO SH.P.K." Licensë N.6996/4 Administrator: Ing. KRENAR DILA	
Artk. NDUE GJACI		Ng. A-0031/4	
Artk. NASJEL ÇIÇO		Ng. A-1249/2	
Artk. MARIO MUKA		Urb. XHESI CONIKU	
Inxh. DHIMITER PAPA		Ng. K1510/2	
Kapitulli		PROJEKTI I PERFORCIMIT	
Titulli i Vizatimit		ARMIMI I KAFAZIT TE ASHENSORIT MA2	
Shkallia		Nr. i Fletës K-29	

PROJEKTIMI
KONS. DR. BABA

ARMIMI I KAFAZIT TE ASHENSORIT

(MA2)

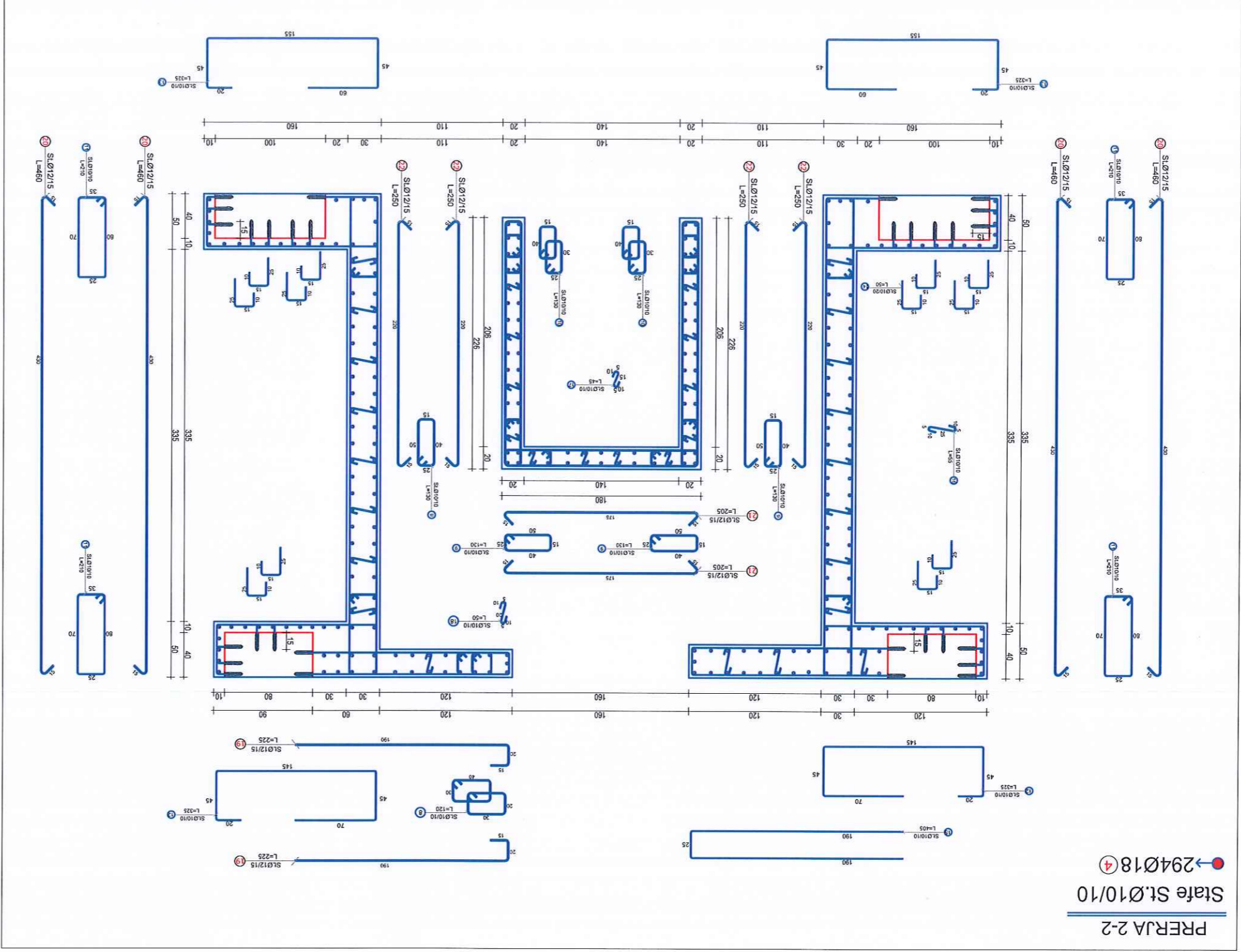

Porositës	Bashkia DURRES
Faza	PROJEKT-ZBATIMI
Titulli i Projektit	PERFORCIMI DHE RESTAURIMI I OBJEKTEVE TE PREKURA NGA TERMETI I 26.11.2019
PROJEKTUES:	"ARKONSTUDIO SH.P.K." Licensë N.6996/4 Administrator: Ing. KRENDAR DILA
Ark. NDUE GUACI	Itë: A-0031/4
Ark. NASJEL ÇIÇO	Itë: A-1249/2
Ark. MARIO MUKA	
Urb. XHESI ÇONIKU	
Itëh. DHIMITER PAPA	Itë: K-1510/2
Kapitulli	PROJEKTI I PERFORCIMIT
Titulli i Vizatimit	ARMIMI I KAFAZIT TE ASHENSORIT MA2
Shkalla	Nr. i Pletës K-30

Handwritten signature and blue stamp in the top right corner of the page.

ARMIMI I KAFAZIT TE ASHENSORIT
(MA2)

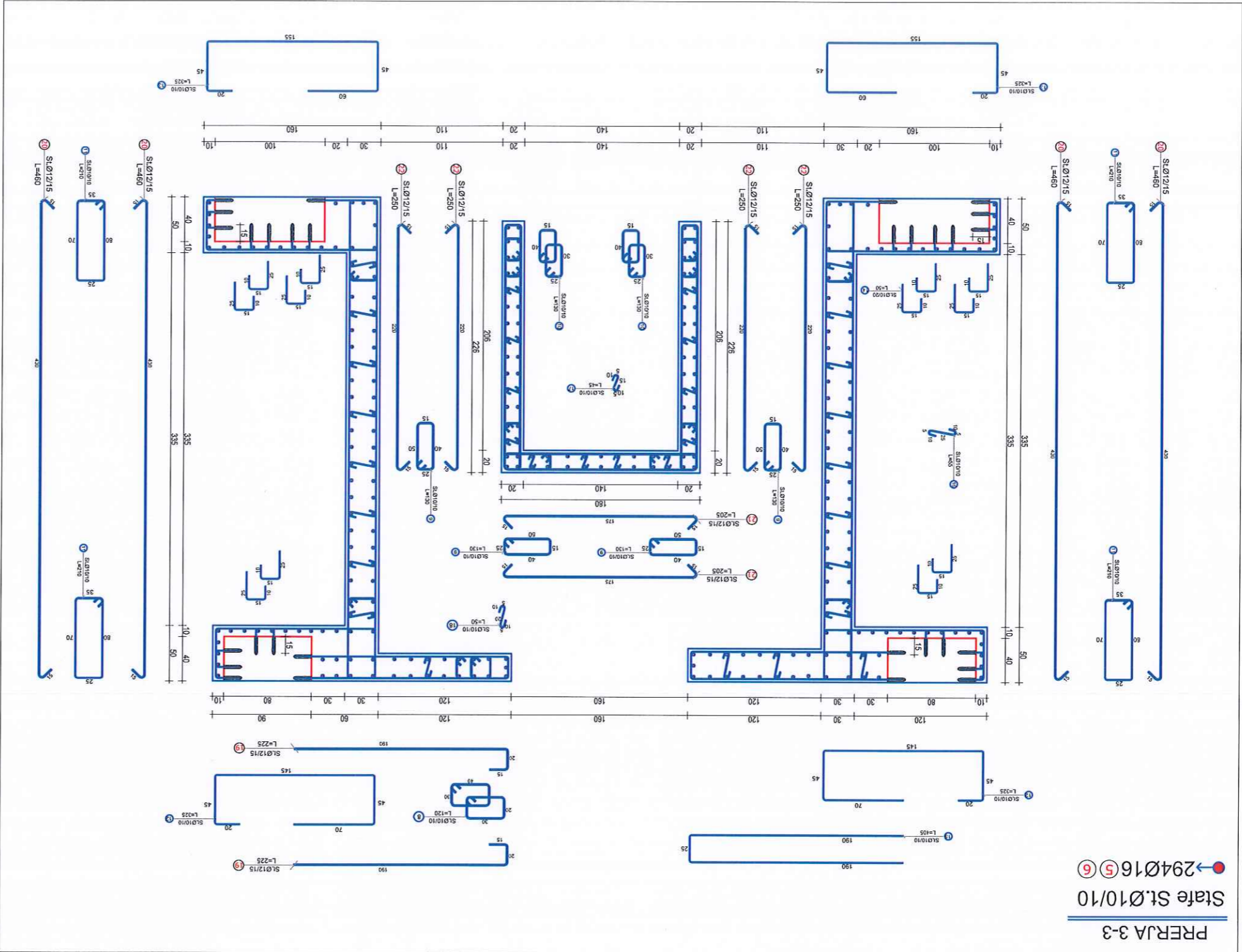

PRRJA 3-3
State St.010/10
29401656

<p>PROJEKTUES: "ARKONSTUDIO SH.P.R.K." Licensë N.6996/4 Administrator: Ing. KRENAR DILA</p>		Ark. NDUE GJACI Iq. A-0031/4	Ark. NASJEL ÇIÇO Iq. A-1249/2	Ark. MARIO MUKA	Urb. XHESI ÇONIKU	Inxh. DHIMITER PAPA Iq. K.15102 	Kapitulii PROJEKTI I PERFORCIMIT Tërbullit i Vizatimit ARMIMI I KAFAZIT TE ASHENSORIT MA2 Nr. i Fletës K-31	Shkalla				
Porositës Bashkia DURRES		Faza Tërbullit i Projektit		Objekteve dhe Restaurimi i Tërbullit i 26.11.2019		PROJEKTUES: "ARKONSTUDIO SH.P.R.K." Licensë N.6996/4 Administrator: Ing. KRENAR DILA		Ark. NDUE GJACI Iq. A-0031/4	Ark. NASJEL ÇIÇO Iq. A-1249/2	Ark. MARIO MUKA	Urb. XHESI ÇONIKU	Inxh. DHIMITER PAPA Iq. K.15102

KORS. BH. PAPA
 Inxh.

PERFORCIMI I PANELIT TE PLOTE PERIMETRAL

$L > 4.0 \text{ m}$

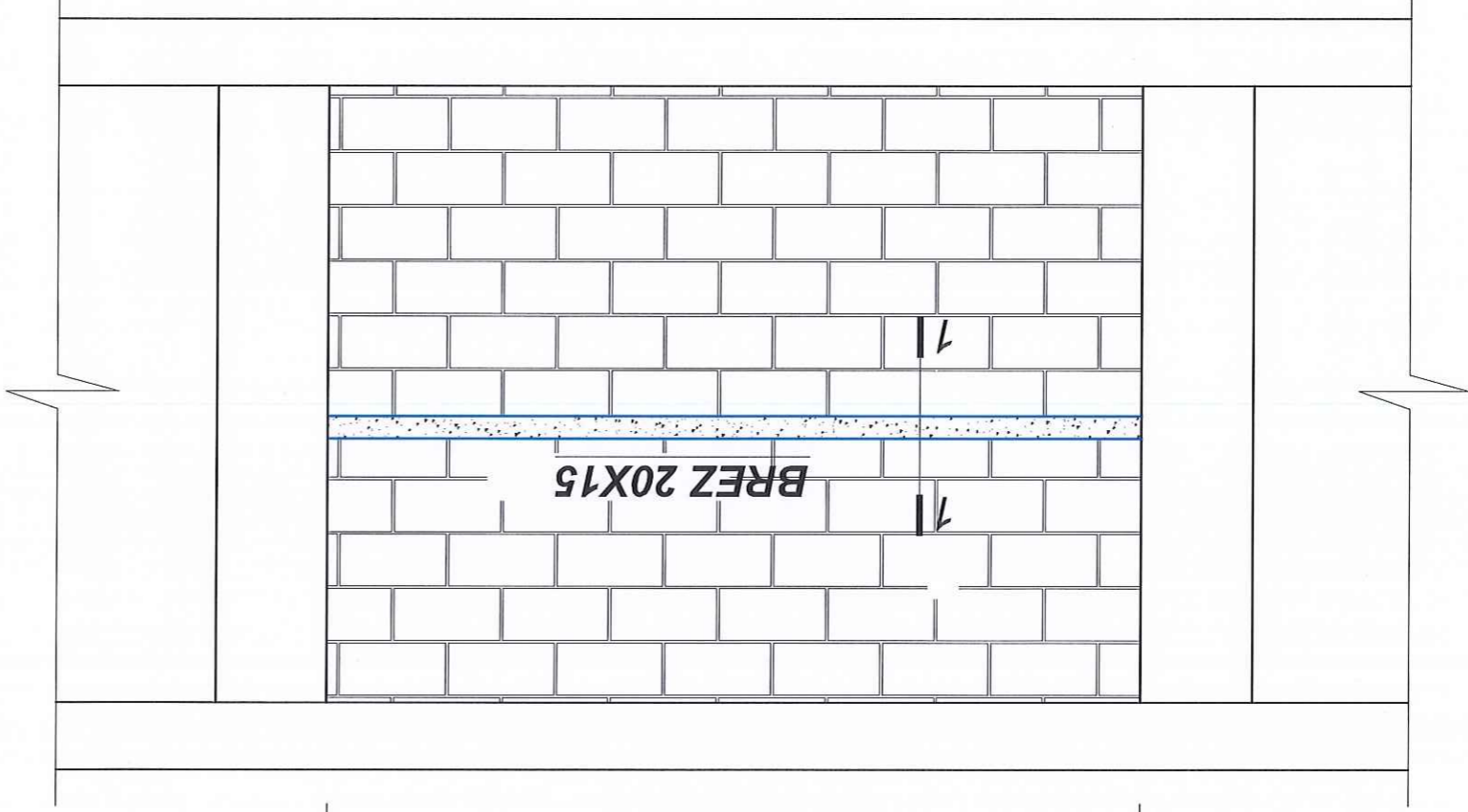

DETAJ I LIDHJES SE MUREVE SE KOLONAT

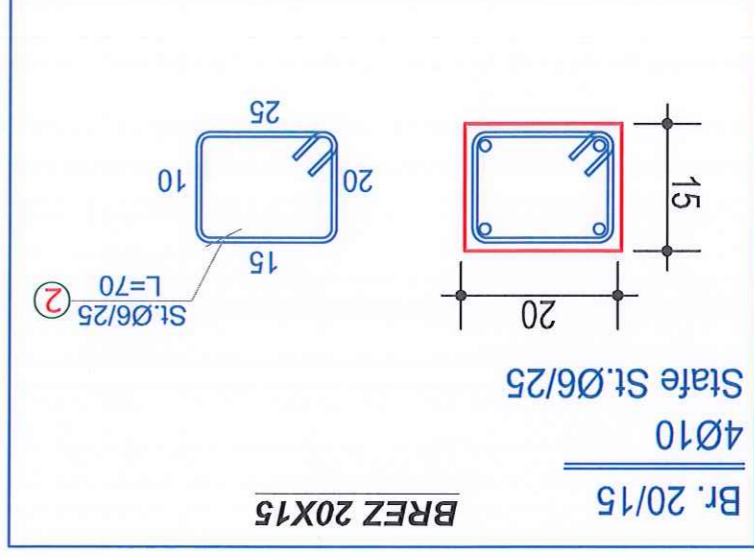
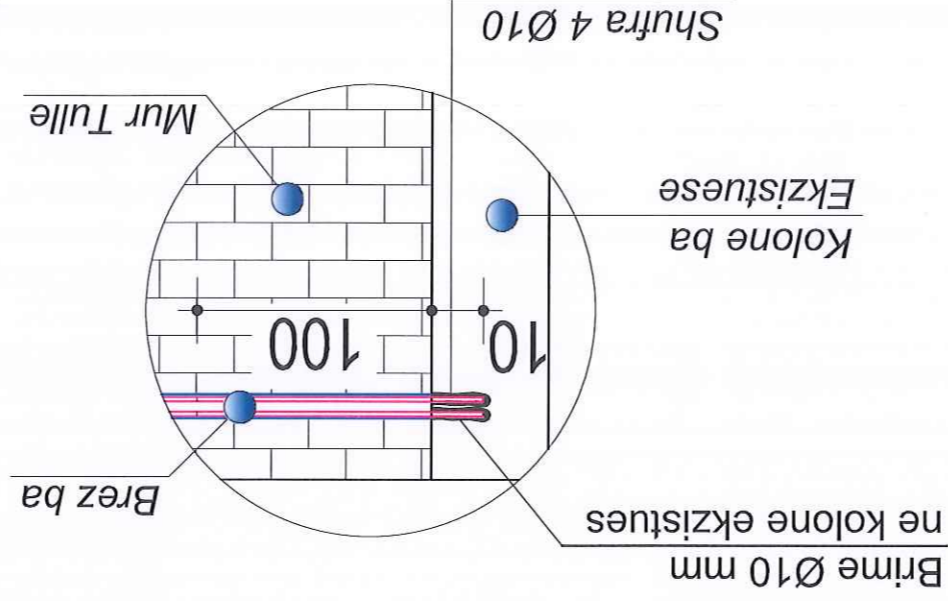

SHEMIME TEKNIKE:
BETONI: B-25 (M-250)
HEKURI: S500 OSE EKVIVALENT

Autoriteti Kontraktor		BASHKIA DURRES	
Faza		PROJEKT-ZBATIMI	
Titulli i Projektit		HARTIMIN I PROJEKTEVE TE NDRERHYRJEVE REHABILITIVUSE - PERSHTATASE TE NEVOJSHME	
PROJEKTUES:		"ARKONSTUDIO SH.P.R.K."	
Administrator:		Ark. NASJEL GJCO	
Dreftues Projekt/Inxh. Konstruktor		Inxh. DHIMITER PAPA	
Inxh. Hidroteknik		Inxh. KRISTAQ KALI	
Inxh. Gjedet		Inxh. GJERGJI LOCI	
Inxh. Gjedet		Inxh. ORJENT MUCA	
Inxh. PROJEKTIM/NDERTIM		ARKONSTUDIO	
Objekti			
Kapitulli		PROJEKTI I PERFORCIMIT	
Titulli i Vizatimit		PERFORCIMI I PANELIT TE PLOTE PERIMETRAL	
Shkalla:		Nr. i Fletes K_32	

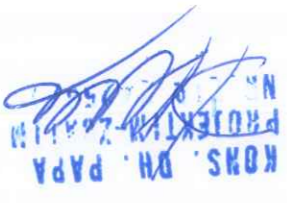
 ARKONSTUDIO
 SH.P.R.K.
 Nr. 11/11/2018

PERFORCIMI I PANELIT TE PLOTE PERIMETRAL

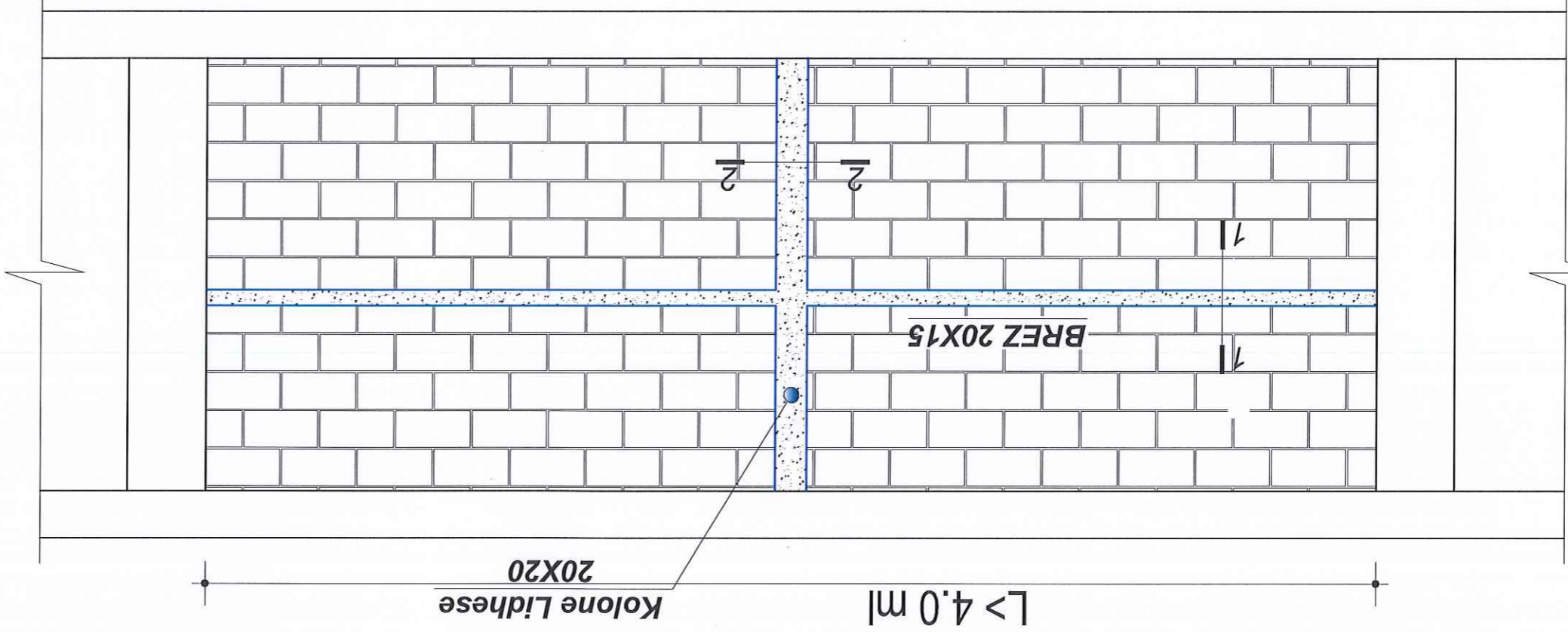

DETALJ I LIDHJES SE MUREVE ME KOLONAT

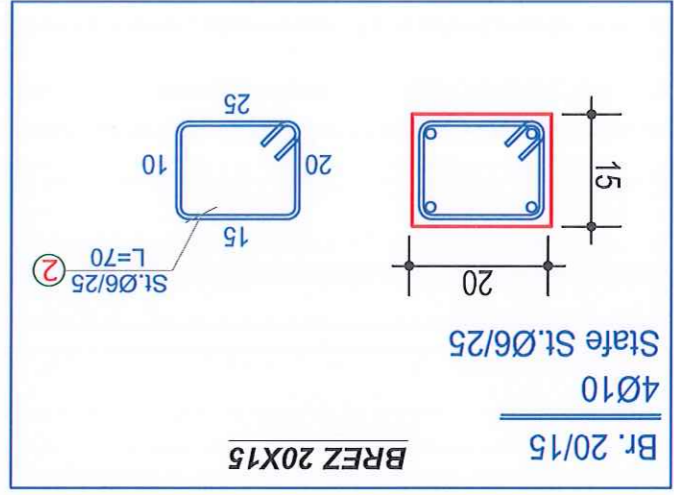
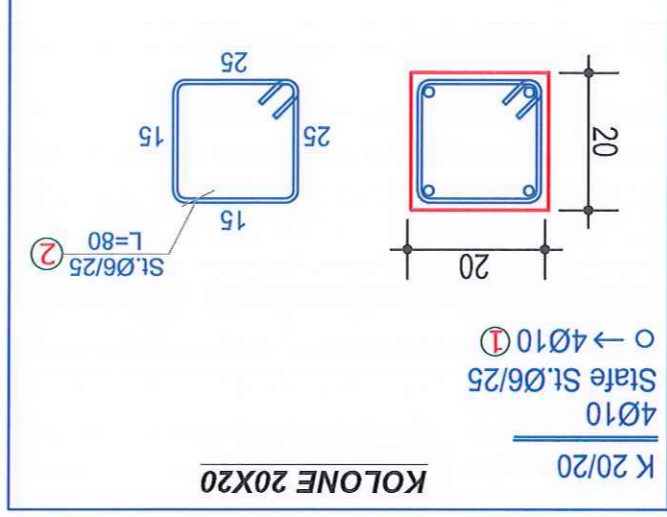
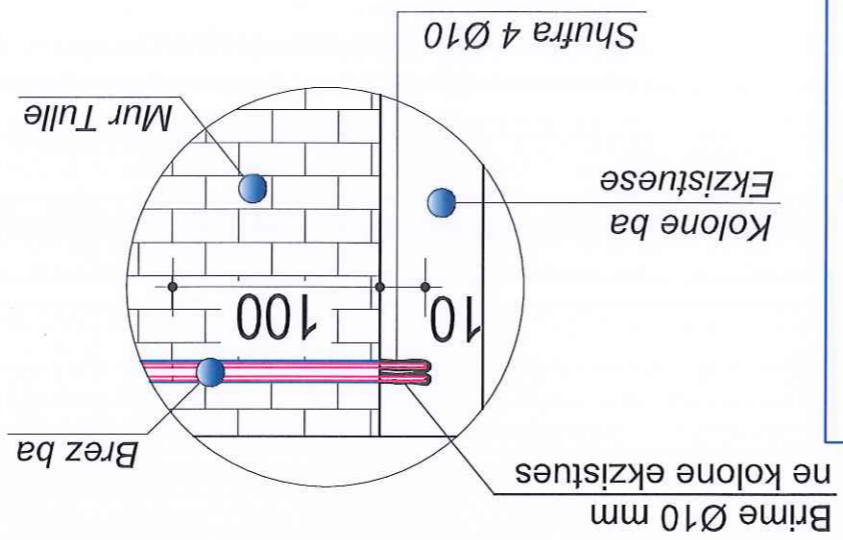

SHENIME TEKNIKE:
BETONI: B-25 (M-250)
HEKURI: S500 OSE EKVIVALENT

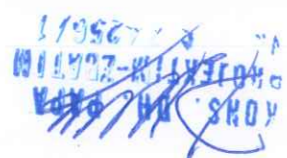

Objekti		Kapitulli		Tribulli i Vizatimit		Shkalla:	
PROJEKTI I PERFORCIMIT		PERFORCIMI I PANELIT TE PLOTE PERIMETRAL		Nr. i Pletës		K_33	
Autorteti Kontraktor		Faza		Tribulli i Projektit		HARTIMIN I PROJEKTEVE TE	
BASHKIA DURRES		PROJEKT-ZBATIMI		REHABILITVENSE - PERSHTAVENSE		TE NEVOJSHME	
Projektues:		"ARKONSTUDIO SH.P.K."		Licensë N.6996/6		Administrator:	
Ark. NASJEL ÇICO		ARKONSTUDIO		Insh. Projektues/Insh. Konstruktor		Insh. DHIMITER PAPA	
Insh. Hidroteknik		Insh. KRISTAQ KALI		Insh. GJERGJI LOCI		Insh. ORIENT MUÇA	
Insh. Gjeodet		Insh. GJERGJI LOCI		Insh. Gjeodet		Insh. Gjeodet	
Insh. Gjeodet		Insh. GJERGJI LOCI		Insh. Gjeodet		Insh. Gjeodet	

PERFORCIMI I PANELIT TE PLOTE PERIMETRAL

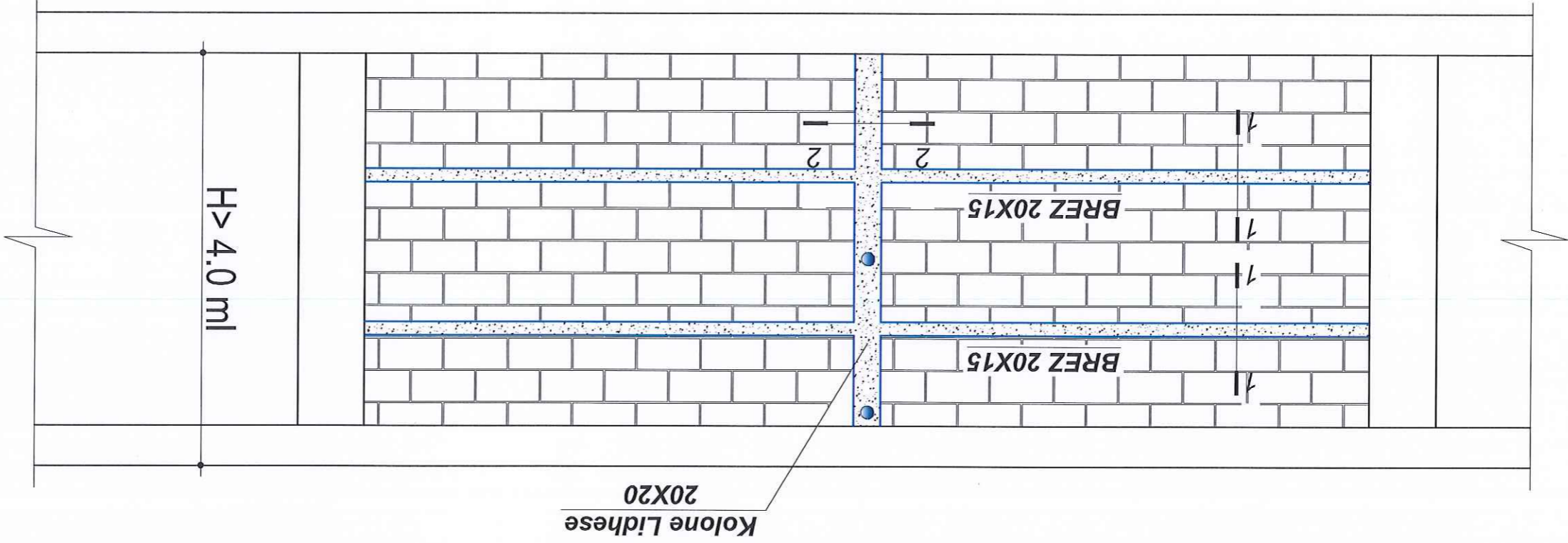

DETALJ I LIDHJES SE MUREVE SE KOLONAT

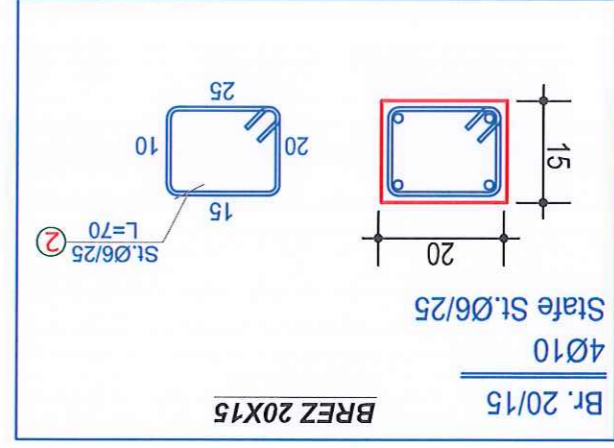
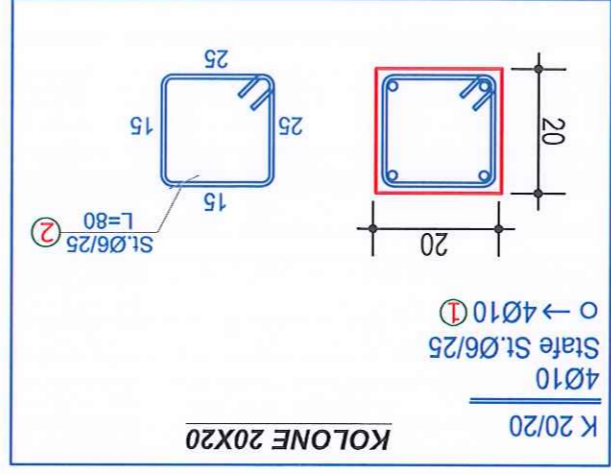
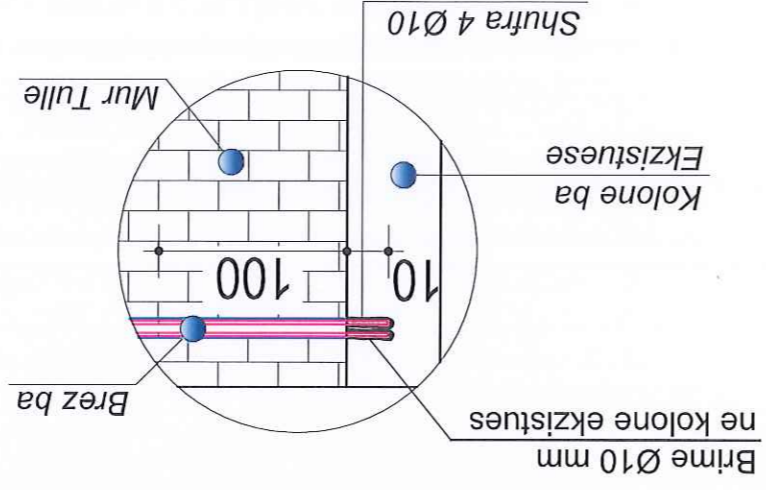

SHENIME TEKNIKE:
BETONI: B-25 (M-250)
HEKURIT: S500 OSE EKJVALENT

Handwritten signature and stamp

Autoriteti Kontraktor		BASHKRIA DURRES		Faza		PROJEKT-ZBATIMI		Titulli i Projektit		HARTIMIN I PROJEKTEVE TE NDERRHYRJEVE REHABILITUESHME - PERSHTATSESE TE NEVOJSHME		PROJEKTUES: "ARKONSTUDIO SH.P.K." Licensë N.6996/6 Administrator: Ark. NASJEL ÇIÇO ARKONSTUDIO		Drejtues Projekti/ Inxh. Konstruktor Inxh. DHIMITER PAPA Nr. Lic. K.1510/2		Inxh. Hidroteknik Inxh. KRISTAQ KALI Nr. Lic. H/T.0103/		Inxh. Gjeodet Inxh. GJERGJI LOÇI Nr. Lic. T.1236		Inxh. Gjeodet Inxh. ORIENT MUÇA PROJEKTIM/NDERTIM LK20190041		Objekti			
Kapitulli		PROJEKTI I PERFORCIMIT		Titulli i Vizatimit		PERFORCIMI I PANELIT TE PLOTE PERIMETRAL		Nr. i Pletës		K_34		Shkalla:													

Shenime:

1. Betoni per traret e rinj te themeleve dhe soletes se re ne kuoten ±0.00 te jete C 25/30

Per kemishimet e kollonave dhe mureve b/arme te perdoret betoni C30/37. 2. Hekuri qe do te perdoret te jete B 500C.

3. Shtresa mbrojtese e trareve te rinj te themeleit te merret 5cm.

4. Te hapen vrimat ne plint per futur shufrat sipas skices se dhene ne projekt. Vrimat do te hapen 2mm me shume se shufra. Vrimat do te

pastrohen me uje me presion.

5. Per te ankoruar fitilat ne plint do te perdoret paste epokside.

6. Me pas do te vazhdohet me vendosjen e armatures se hekurit sipas skemes se vendosur ne figure.

7. Per mbushjen e kollonave qe do te perforcohen me metoden CAM te perdoret llac strukturor me rezistence $\geq 400 \text{ daN/cm}^2$.

8. Ne kallep te vendosen dritare per hedhjen e betonit dhe do te vibrohet. 9. Te perdoret vibrator me diameter te kokes max. 50mm.

10. Perdorimi i materialleve lidhes (pasta epokside dhe llac strukturor), mund te behen vetem pasi te jene miratuar nga projektuesi.

11. Te fillohet nga kollona e demtuar me rende.

12. Nese kemi degradime do riparohen keto degradime me llac special betoni $M > 300$. Nese do te kemi nxjerje te shufrave dhe korrodim , te

pastohen dhe mbushen zgavrat me llac special +aditiv lidhes beton-celik. 13. Te gjitha dimensionet te verifikohen ne vend.

14. Konturi i trareve te themeleit qe do hidhet te verifikohet ne vend. 15. Per cdo paqartesi te kontaktohet projektuesi.

Shenime:

1. Betoni per muret te jete C 30/37.

2. Hekuri qe do te perdoret te jete B 500C.

3. Profillet prokat celik S 275 sipas EN 10025; 10027-1

4. Ne pjesen qe do te thyhen traret apo kollonat

te puntelohet soleta deri ne realizimin e perforcimit te saj.

5. Te gjitha dimensionet te verifikohen ne vend. Per cdo paqartesi apo mosperputhje te kontaktohet konstruktori.

1. Nese kolona eshte e demtuar te perforcohet me anen e puntelave.

2. Te higjet suvaja dhe cdo papasteri e kolones. Pastrimi

mund te behet me uje me presion ose me rere me presion. 3. Siperfaqja e betonit te gervishtet me anen e nje

matrapiku te lehte.

4. Te mbillen ne themelet dhe ne tra fitilat e kollonave sipas projektit.

5. Gjatesia minimale e ankorimit te shufrave te merret 15-20 cm por jo me pak sesa ajo qe jep katalogu i rezinave

epokside qe do te perforcohen.

6. Ne vendet ku do te behet lidhja e armatures se vjeter me ate te re, betoni i kolones ekzistuese te thyhet dhe te behet

saldimi i kavallotave.



7. Vendoset armatura hekurit, klasa B-500 dhe starat sipas projektit te paraqitur.

8. Betonohet kolona me beton te klases C30/37.

9. Ne zonen e takimit te kolones me traun mbushja te behet me llac strukturor M-400 me veti zgjeruese.

10. Perforcimi te fillohet nga kolona me e demtuar.

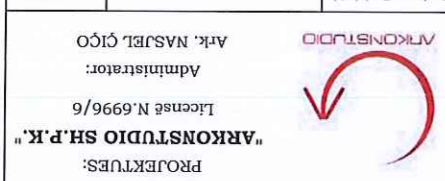
11. Te gjitha dimensionet te verifikohen ne vend. Per cdo paqartesi apo mosperputhje te kontaktohet konstruktori.

		Dregjues Projekt/ Inxh. Konstruktor Nr. Lic. K.1810/2 Inxh. DHIMITER PAPA		Inxh. Hidroteknik/ Inxh. KRISTAQ KALI Nr. Lic. M/T. 0103/8		Inxh. Gjeodet/ Inxh. GJERGJI LOCI Nr. Lic. T.1286		Inxh. Gjeodet/ Inxh. ORJENT MUÇA							
Autoriteti Kontraktor BASHKIA DURRES		Faza PROJEKT-ZBATIMI		Titulli i Projektit HARTIMI I PROJEKTEVE TE NDRRHYRJEVE REHABILITUESE - PERSHTATESE TE NEVOJSHME		PROJEKTUES: "ARKONSTUDIO SH.P.K." Licensë N.6996/6 Administrator: Art. NASURJ GJCO		Objekti 		Kapitulli PROJEKTI I PERFORCIMIT		Thtulli i Vizatimit SHENIME TEKNIKE		Shkalla: Nr. i Fletes K_37	

