





LEGJENDA

-  DREJTIMI I RRJEDHJES SE KUSH
-  TIROLEZE, ZGARE PER KUSH
-  PUSETE E RE KOMPOZIT 40x70
-  PUSETE EKZ. KOMPOZIT 40x70
-  TUBACION KUSH HDPE SN 8

GRUPI I PROJEKTIMIT		
	ATELIER 4 ARCHITECTURE & CONSULTING STUDIO Rr. "Kosovartine", Ndërtesa 35, Hyrja 6, Ap.4/1, Njësia Administrative Nr. 5, 1019, Tiranë, Shqipëri tel: +355 4 24 30 195 / 4 22 22 804 fax: +355 4 24 30 194 mobile: +355 69 20 38 958 e-mail: info@atelier4.al web: www.atelier4.al	
	KEJSI-05 ELECTRICAL ENGINEERING STUDIO Rr. "Zef Juban", Ndërtesa 7, Ap. 3, Tiranë, Shqipëri mobile: +355 68 40 38 122 mobile: +355 68 20 77 941 e-mail: info@kejsi05.com web: www.kejsi05.com	
TITULLI I PROJEKTIT		
RIKUALIFIKIM URBAN I ZONËS "KODRA E DIELLIT"		
AUTORITETI KONTRAKTOR		
BASHKIA TIRANË		
KODI I VIZATIMIT	NR. I VIZATIMIT	
KD C A 0 <small>KODI FAZA DISIPLINA RISHIKIM</small>	PL. KUSH_1	
EMËRTIMI I VIZATIMIT		
PLANIMETRIA E RRJETIT TE KUSH. RR.VANGJEL MEKSI 01		
SHKALLA	1:100	
DATA	MAJ 2019	
PËRSHKRIMI I FAZËS		
PROJEKT - ZBATIMI		
RISHIKIM	DATA	FAZA E PROJEKTIT
0	2019	C



LEGJENDA



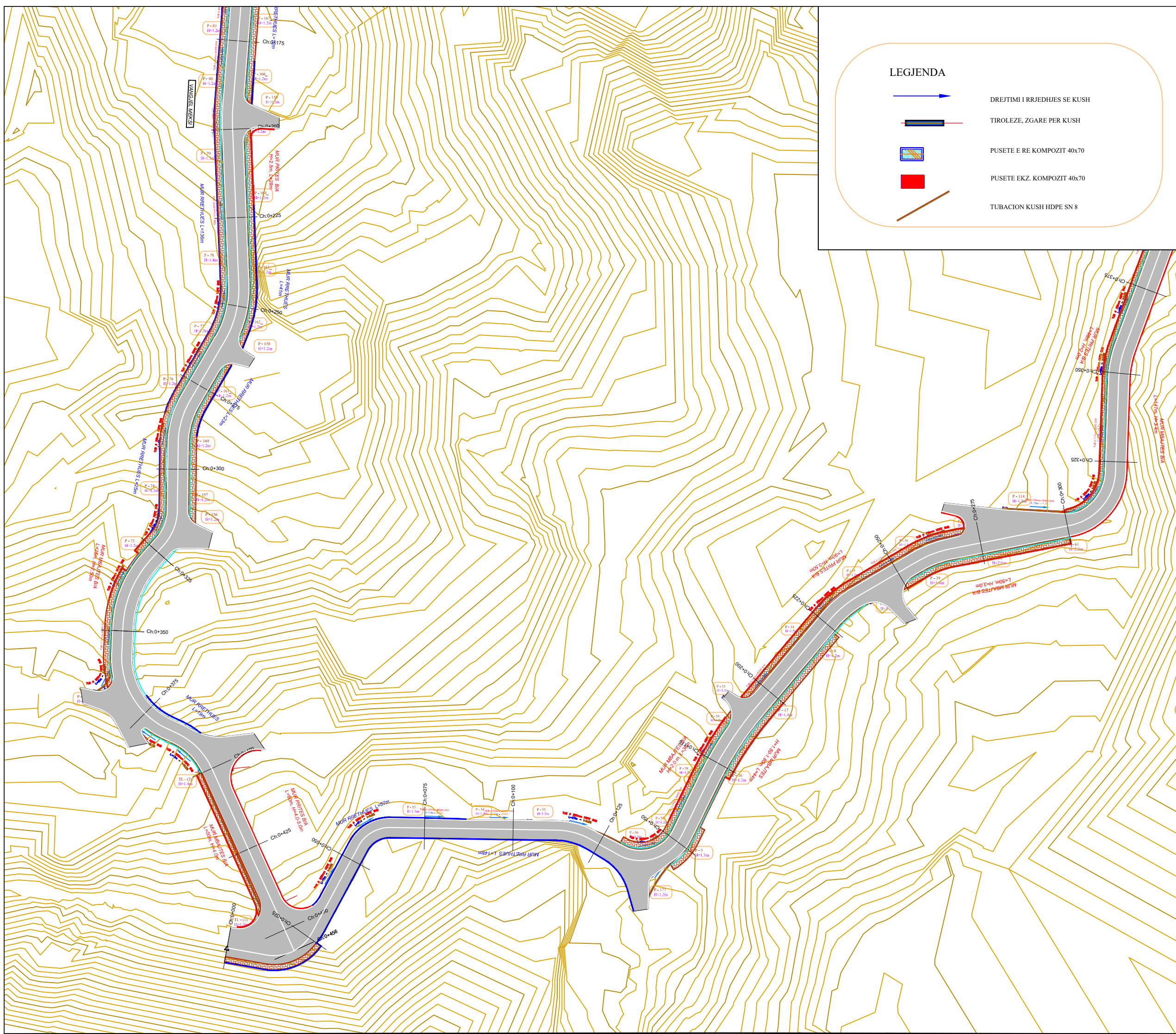

- DREJTIMI I RRJEDHJES SE KUSH
- TIROLEZE, ZGARE PER KUSH
- PUSETE E RE KOMPOZIT 40x70
- PUSETE EKZ. KOMPOZIT 40x70
- TUBACION KUSH HDPE SN 8

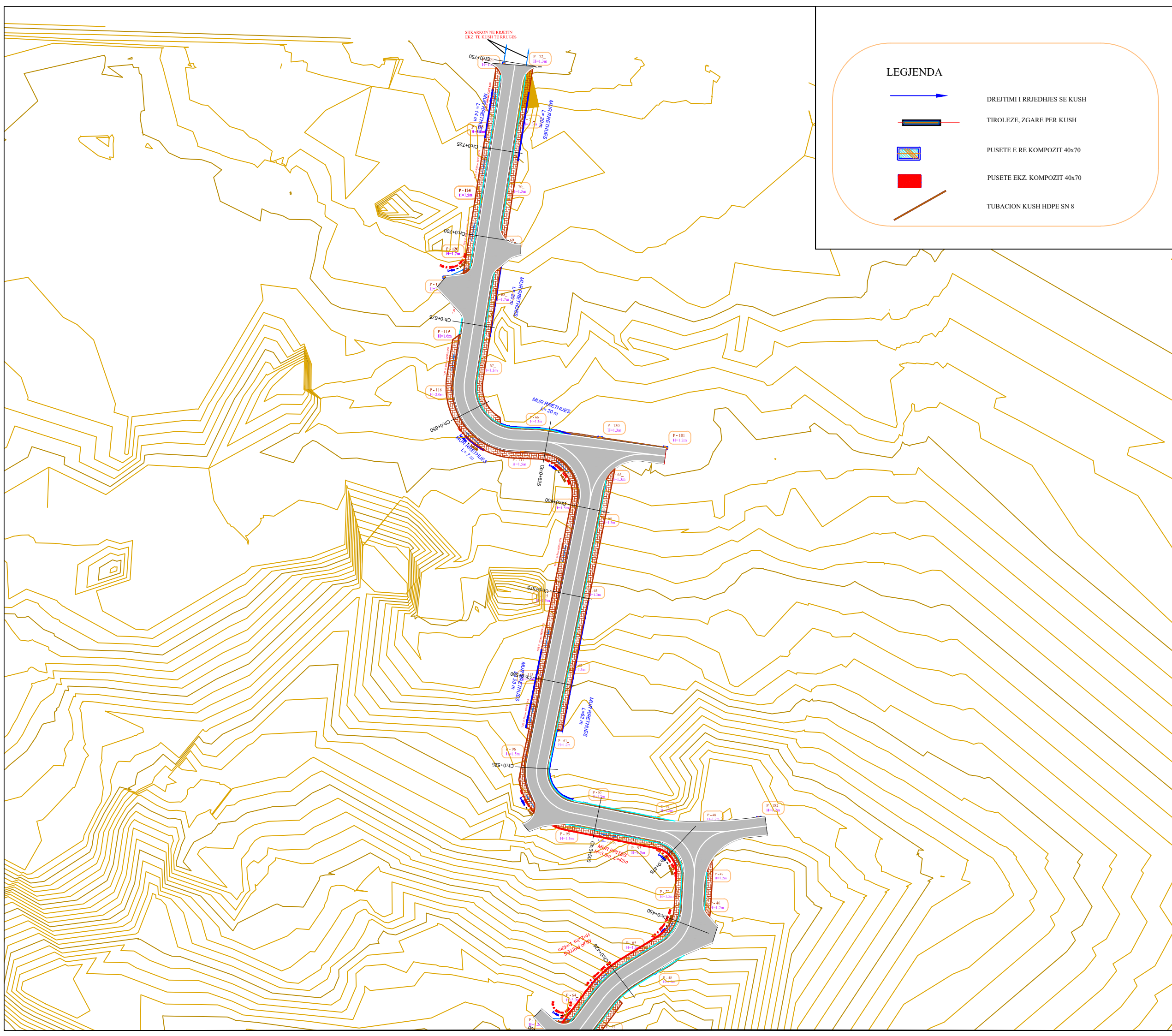

GRUPI I PROJEKTIMIT	
	ATELIER 4 ARCHITECTURE & CONSULTING STUDIO Rr. "Kosovartine", Nr.115, Hyrja 6, Ap.4/1, Njësia Administrative Nr. 5, 1019, Tiranë, Shqipëri tel: +355 4 24 30 195 / 4 22 22 804 fax: +355 4 24 30 194 mobile: +355 69 20 38 958 e-mail: info@atelier4.al web: www.atelier4.al
	KEJSI-05 ELECTRICAL ENGINEERING STUDIO Rr. "Zef Juban", Nr.115, Hyrja 7, Ap. 3, Tiranë, Shqipëri mobile: +355 68 40 38 122 mobile: +355 68 20 77 941 e-mail: info@kejsi05.com web: www.kejsi05.com
TITULLI I PROJEKTIT	
RIKUALIFIKIM URBAN I ZONËS "KODRA E DIELLIT"	
AUTORITETI KONTRAKTOR	
BASHKIA TIRANË	
KODI I VIZATIMIT	NR. I VIZATIMIT
KD C A 0 <small>KODI FAZA DISIPLINA RISHIKIM</small>	PL. KUSH_2
EMËRTIMI I VIZATIMIT	
PLANIMETRIA E RRJETIT TE KUSH.	
RR.VANGJEL MEKSI 02 RR. XHIM BEGEJA 01	
SHKALLA	DATA
1:100	MAJ 2019
PËRSHKRIMI I FAZËS	
PROJEKT - ZBATIMI	
RISHIKIM	FAZA E PROJEKTIT
0	C
2019	



LEGJENDA

-  DREJTIMI I RRJEDHJES SE KUSH
-  TIROLEZE, ZGARE PER KUSH
-  PUSETE E RE KOMPOZIT 40x70
-  PUSETE EKZ. KOMPOZIT 40x70
-  TUBACION KUSH HDPE SN 8



GRUPI I PROJEKTIMIT	
 <p>ATELIER 4 ARCHITECTURE & CONSULTING STUDIO Rr. "Kosovartine", Nr.11, Nr.5, Hyrja 5, Ap.4/1, Njësia Administrative Nr. 5, 1015, Tiranë, Shqipëri tel: +355 4 24 30 195 / 4 22 22 804 fax: +355 4 24 30 194 mobile: +355 69 20 38 958 e-mail: info@atelier4.al web: www.atelier4.al</p>	 <p>KEJSI-05 ELECTRICAL ENGINEERING STUDIO Rr. "Zef Juban", Nr.11, Nr.7, Ap. 3, Tiranë, Shqipëri mobile: +355 68 40 38 122 mobile: +355 68 20 77 941 e-mail: info@kejsi05.com web: www.kejsi05.com</p>
TITULLI I PROJEKTIT	
RIKUALIFIKIM URBAN I ZONËS "KODRA E DIELLIT"	
AUTORITETI KONTRAKTOR	
BASHKIA TIRANË	
KODI I VIZATIMIT	NR. I VIZATIMIT
KD C A 0 KODI FAZA DISIPLINA RISHIKIM	PL. KUSH_4
EMËRTIMI I VIZATIMIT	
PLANIMETRIA E RRJETIT TE KUSH. RR.XHIM BEGEJA 03	
SHKALLA	DATA
1:100	MAJ 2019
PËRSHKRIMI I FAZËS	
PROJEKT - ZBATIMI	
RISHIKIM	FAZA E PROJEKTIT
0	C
DATA	
2019	

PROFILI GJATESOR I KUSH Rruga - VANGJEL MEKSI
DEGA DJATHHTAS

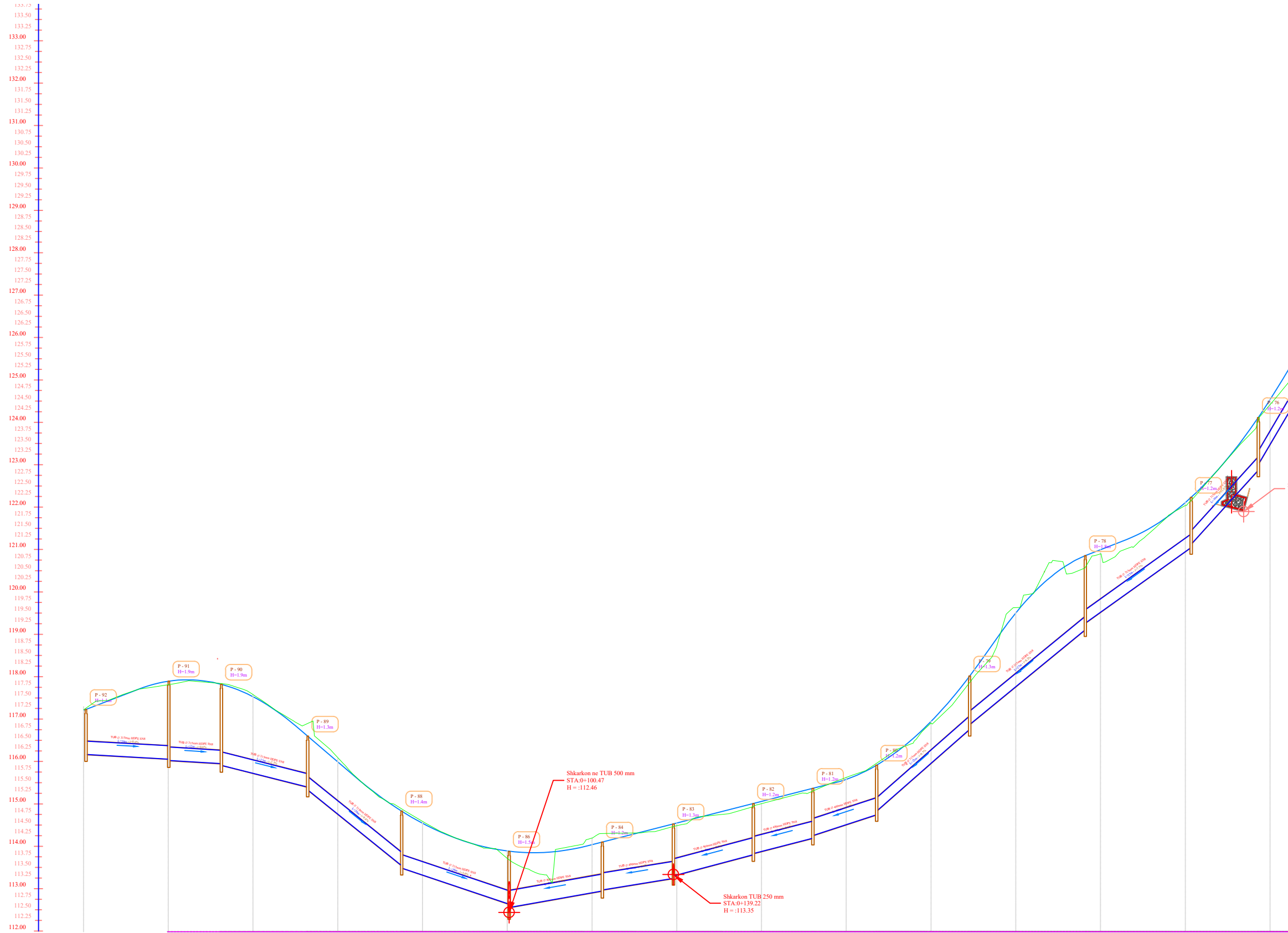

EMERTIMI I PUSETES	P-92	P-91	P-90	P-89	P-88	P-86	P-84	P-83	P-82	P-81	P-80	P-79	P-78	P-77	P-76
DISTANCA PROGRESIVE	0+00	0+05	0+10	0+15	0+20	0+25	0+30	0+35	0+40	0+45	0+50	0+55	0+60	0+65	0+70
KUOTA E RRRUGES	117.22	117.91	117.84	117.60	116.08	114.50	114.05	114.56	115.07	115.59	116.06	116.52	121.10	122.12	124.54
KUOTA PROJEKTTIT	117.24	117.91	117.84	117.60	116.08	114.50	114.05	114.56	115.07	115.59	116.06	116.52	121.10	122.12	124.54
KUOTA PUSETES	117.24	117.91	117.84	117.60	116.08	114.50	114.05	114.56	115.07	115.59	116.06	116.52	121.10	122.12	124.54
THELLESIA E PUSETES	0.08	0.89	0.93	1.28	1.36	1.45	1.17	1.29	1.21	1.18	1.18	1.27	1.75	1.19	1.25
KUOTA E GERMIMIT	116.17	116.02	115.91	115.33	113.09	112.44	112.95	113.25	113.81	14.20	14.75	16.76	19.11	21.05	22.88
LINJA TUBACIONIT	D=315mm i=0.6% - L=19.6m	D=315mm i=0.6% - L=12.5m	D=315mm i=2.3% - L=22.2m	D=315mm i=8.8% - L=20.4m	D=315mm i=3.6% - L=23.5m	D=400mm i=1.6% - L=24.4m	D=400mm i=1.6% - L=16.9m	D=400mm i=2.5% - L=20.0m	D=400mm i=2.6% - L=14.0m	D=400mm i=3.3% - L=15.0m	D=315mm i=8.7% - L=22.3m	D=315mm i=8.2% - L=27.3m	D=315mm i=7.7% - L=23.1m	D=315mm i=11.0% - L=15.9m	

GRUPI I PROJEKTIMIT

ATELIER 4
ARCHITECTURE & CONSULTING STUDIO

ATELIER 4
ARCHITECTURE & CONSULTING STUDIO
Rr. "Kosovartine", Nr.11, Hyrja 6, Ap.4/1,
Njësia Administrative Nr. 5, 1019, Tiranë, Shqipëri
tel: +355 4 24 30 195 / 4 22 22 804
fax: +355 4 24 30 194
mobile: +355 69 20 38 958
e-mail: info@atelier4.al
web: www.atelier4.al

KEJSI 05
ELECTRICAL ENGINEERING STUDIO

KEJSI-05
ELECTRICAL ENGINEERING STUDIO
Rr. "Zef Juban", Nr.11, Hyrja 7, Ap. 3, Tiranë, Shqipëri
mobile: +355 68 40 38 122
mobile: +355 68 20 77 941
e-mail: info@kejsi05.com
web: www.kejsi05.com

TITULLI I PROJEKTTIT

RIKUALIFIKIM URBAN I ZONËS "KODRA E DIELLIT"

AUTORITETI KONTRAKTOR

BASHKIA TIRANË

KODI I VIZATIMIT	NR. I VIZATIMIT
KD C A 0	PL. KUSH_1/1
KODI	FAZA
DISIPLINA	RISHIKIM

EMËRTIMI I VIZATIMIT

PROFILI GJATESOR I KUSH

SHKALLA	1:100	DATA	MAJ 2019
----------------	-------	-------------	----------

PËRSHKRIMI I FAZËS

PROJEKT - ZBATIMI

RISHIKIM	DATA	FAZA E PROJEKTTIT
0	2019	C

PROFILI GJATESOR I KUSH Rruga - VANGJEL MEKSI
DEGA DJATHHTAS

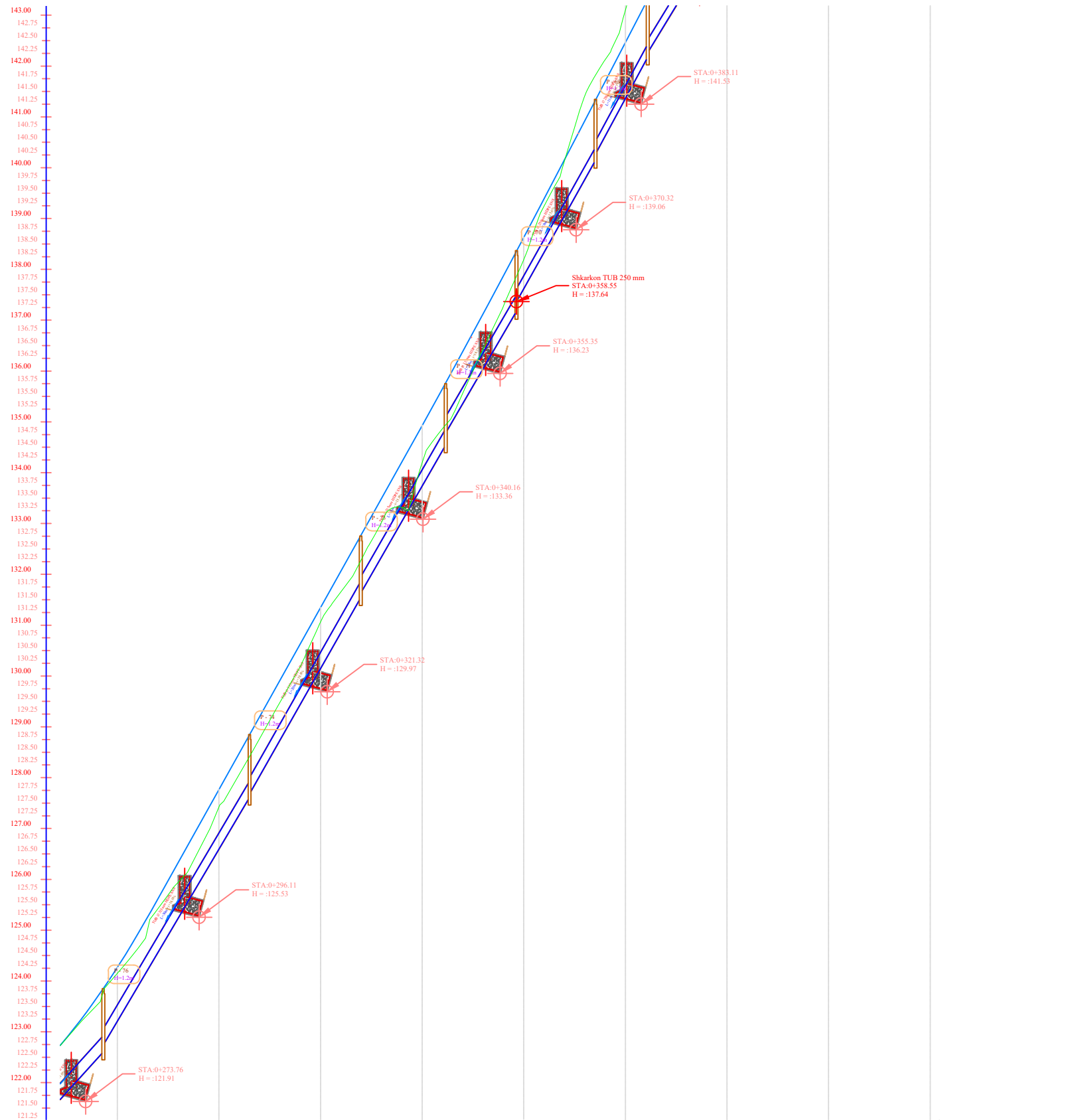

EMERTIMI I PUSETES	P-76		P-74		P-73		P-71		P-70		P-69		P-68		P-67	Signature - C0			
DISTANCA PROGRESIVE		0+280		0+300		0+320		0+340		0+360		0+380		0+400		0+420		0+440	
KUOTA E RRUGES	124.55	124.55	128.05	127.05	131.65	131.35	134.35	134.35	138.89	138.88	142.70	144.20	146.60	151.15	153.60	154.83			
KUOTA PROJEKTTIT	124.55	124.55	128.05	127.05	131.65	131.35	134.35	134.35	138.89	138.88	142.70	144.20	146.60	151.15	153.60	154.83			
KUOTA PUSETES	124.13	124.13	129.13	129.13	133.03	133.03	136.03	136.03	139.66	139.66	143.62	143.62	147.27	151.27	154.83				
THELLESIA E PUSETES	1.25	1.25	1.24	1.24	1.22	1.22	1.21	1.21	1.20	1.20	1.21	1.16	1.16	1.43	1.34				
KUOTA E GERMIMIT	122.88	122.88	127.88	127.88	131.88	131.88	134.88	134.88	137.88	137.88	140.88	142.48	144.84	148.84	153.49				
LINJA TUBACIONIT	15mm L=15.9m		D=315mm i=16.0% - L=30.4m		D=315mm i=19.8% - L=19.5m		D=315mm i=15.8% - L=18.5m		D=315mm i=16.3% - L=14.7m		D=250mm i=15.6% - L=17.8m		D=250mm i=16.7% - L=11.8m		D=250mm i=19.2% - L=12.0m				

GRUPI I PROJEKTIMIT

ATELIER 4
ARCHITECTURE & CONSULTING STUDIO
Rr. e "Kosovartit", Nr.11, Hyrja 6, Ap.4/1,
Njësia Administrative Nr. 5, 1019, Tiranë, Shqipëri
tel: +355 4 24 30 195 / 4 22 22 804
fax: +355 4 24 30 194
mobile: +355 69 20 38 958
e-mail: info@atelier4.al
web: www.atelier4.al

KEJSI-05
ELECTRICAL ENGINEERING STUDIO
Rr. "Zef Juban", Nr.11, Hyrja 7, Ap. 3, Tiranë, Shqipëri
mobile: +355 68 40 38 122
mobile: +355 68 20 77 941
e-mail: info@kejsi05.com
web: www.kejsi05.com

TITULLI I PROJEKTTIT

RIKUALIFIKIM URBAN I ZONËS "KODRA E DIELLIT"

AUTORITETI KONTRAKTOR

BASHKIA TIRANË

KODI I VIZATIMIT	NR. I VIZATIMIT								
<table border="1" style="margin: auto;"> <tr> <td style="padding: 5px;">KD</td> <td style="padding: 5px;">C</td> <td style="padding: 5px;">A</td> <td style="padding: 5px;">0</td> </tr> <tr> <td style="font-size: 8px;">KODI</td> <td style="font-size: 8px;">FAZA</td> <td style="font-size: 8px;">DISIPLINA</td> <td style="font-size: 8px;">RISHIKIM</td> </tr> </table>	KD	C	A	0	KODI	FAZA	DISIPLINA	RISHIKIM	PL. KUSH_1/2
KD	C	A	0						
KODI	FAZA	DISIPLINA	RISHIKIM						

EMËRTIMI I VIZATIMIT

PROFILI GJATESOR I KUSH

SHKALLA	1:100	DATA	MAJ 2019
----------------	-------	-------------	----------

PËRSHKRIMI I FAZËS

PROJEKT - ZBATIMI

RISHIKIM	DATA	FAZA E PROJEKTTIT
0	2019	C

PROFILI GJATESOR I KUSH Rruga - VANGJEL MEKSI
DEGA DJATHHTAS

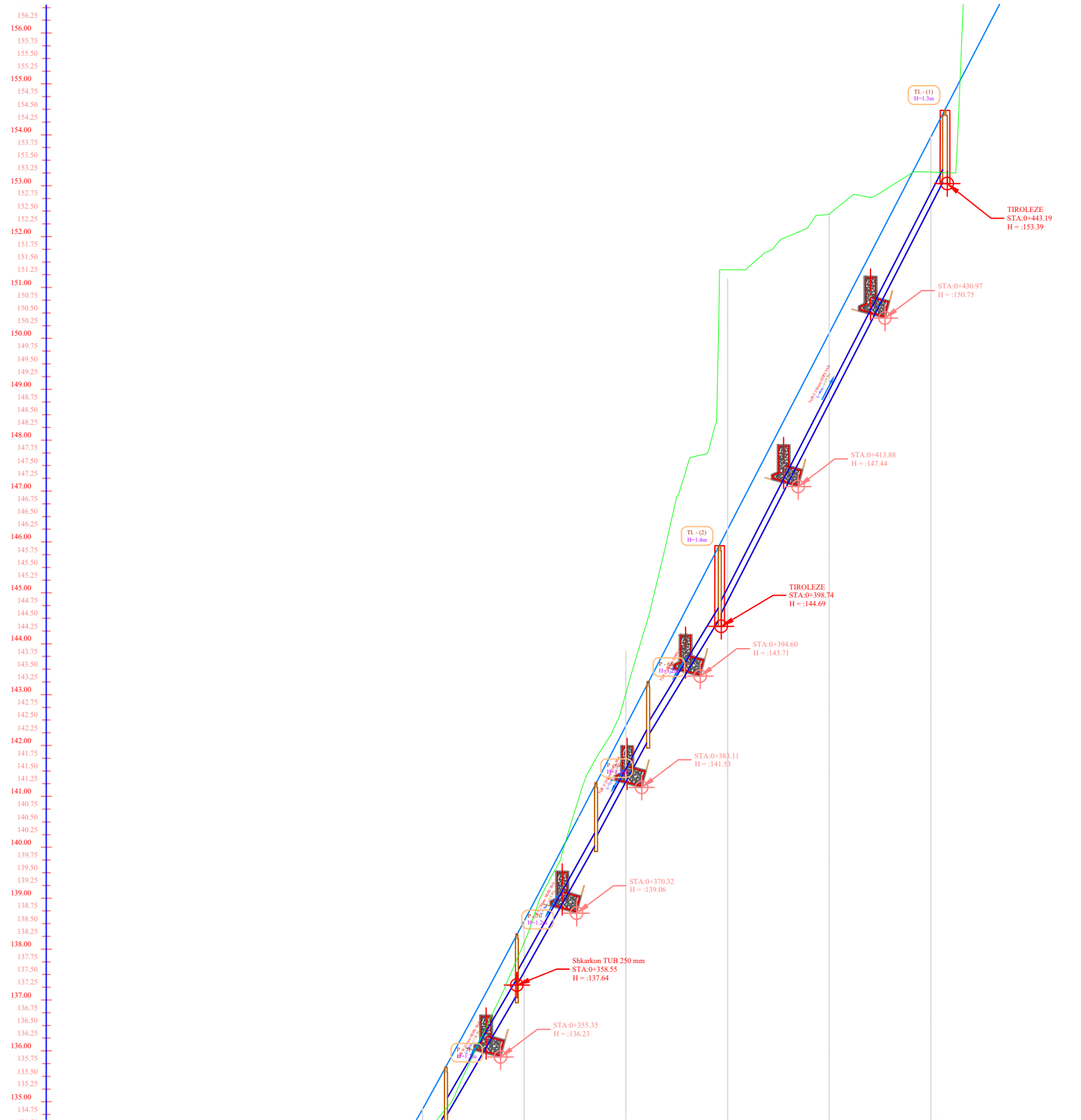

EMERTIMI I PUSETES	P-76	P-74	P-73	P-71	P-70	P-69	P-68	P-67	Signature - C0
DISTANCA PROGRESIVE									
KUOTA E RRUGES	134.55	137.00	138.33	138.33	138.00	142.70	146.60	150.45	154.83
KUOTA PROJEKTTIT	124.55	128.05	131.65	135.20	138.80	142.70	146.60	150.45	154.83
KUOTA PUSETES	124.13	129.13	133.03	136.03	138.66	41.62	43.61	46.27	154.83
THELLESIA E PUSETES	1.25	1.24	1.22	1.21	1.20	1.21	1.16	1.43	1.34
KUOTA E GERMIMIT	22.88	27.88	31.82	34.82	37.45	40.42	42.45	44.84	153.49
LINJA TUBACIONIT	15mm L=15.9m	D=315mm i=16.0% - L=30.4m	D=315mm i=19.8% - L=19.5m	D=315mm i=15.8% - L=18.5m	D=315mm i=16.3% - L=14.7m	D=250mm i=15.6% - L=17.8m	D=250mm i=16.7% - L=11.8m	D=250mm i=19.2% - L=12.0m	D=250mm i=19.5% - L=44.1m

GRUPI I PROJEKTIMIT

ATELIER 4
ARCHITECTURE & CONSULTING STUDIO
Rr. e "Kosovartëve", Nr.11, Prizreni, Shqipëri
tel: +355 4 24 30 195 / 4 22 22 804
fax: +355 4 24 30 194
mobile: +355 69 20 38 958
e-mail: info@atelier4.al
web: www.atelier4.al

KEJSI-05
ELECTRICAL ENGINEERING STUDIO
Rr. "Zef Juban", Nr.11, Prizreni, Shqipëri
mobile: +355 68 40 38 122
mobile: +355 68 20 77 941
e-mail: info@kejsi05.com
web: www.kejsi05.com

TITULLI I PROJEKTTIT

RIKUALIFIKIM URBAN I ZONËS "KODRA E DIELLIT"

AUTORITETI KONTRAKTOR

BASHKIA TIRANË

KODI I VIZATIMIT	NR. I VIZATIMIT								
<table border="1"> <tr> <td>KD</td> <td>C</td> <td>A</td> <td>0</td> </tr> <tr> <td>KODI</td> <td>FAZA</td> <td>DISIPLINA</td> <td>RISHIKIM</td> </tr> </table>	KD	C	A	0	KODI	FAZA	DISIPLINA	RISHIKIM	PL. KUSH_1/3
KD	C	A	0						
KODI	FAZA	DISIPLINA	RISHIKIM						

EMËRTIMI I VIZATIMIT

PROFILI GJATESOR I KUSH

SHKALLA	1:100	DATA	MAJ 2019
PËRSHKRIMI I FAZËS PROJEKT - ZBATIMI			
RISHIKIM	DATA	FAZA E PROJEKTTIT	
0	2019	C	

PROFILI GJATESOR I KUSH Rruga - VANGJEL MEKSI DEGA MAJTAS

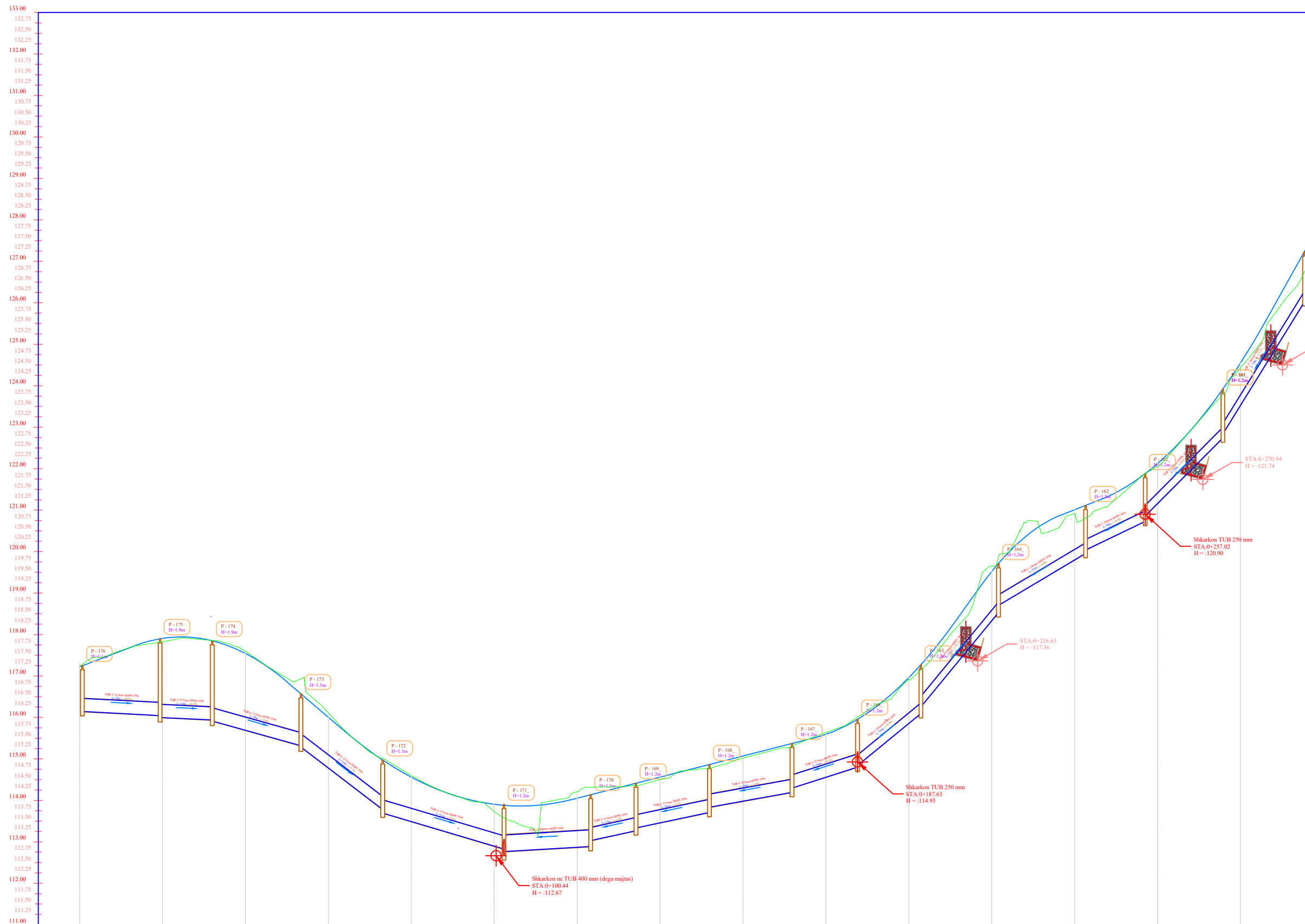

EMERTIMI I PUSETES	P-176	P-175	P-174	P-173	P-172	P-171	P-170	P-169	P-168	P-167	P-166	P-165	P-164	P-163	P-162	P-161																
DISTANCA PROGRESIVE	0+00	0+02	0+04	0+06	0+08	0+10	0+12	0+14	0+16	0+18	0+20	0+22	0+24	0+26	0+28	0+30																
KUOTA E RRUGES	17.22	17.09	17.04	16.08	14.56	13.90	14.05	14.56	15.07	15.59	16.06	16.52	16.97	17.40	17.81	18.20																
KUOTA PROJEKTTIT	17.22	17.09	17.04	16.08	14.56	13.90	14.05	14.56	15.07	15.59	16.06	16.52	16.97	17.40	17.81	18.20																
KUOTA PUSETES	17.22	17.09	17.04	16.08	14.56	13.90	14.05	14.56	15.07	15.59	16.06	16.52	16.97	17.40	17.81	18.20																
THELLESIA E PUSETES	1.12	1.90	1.95	1.29	1.28	1.24	1.28	1.15	1.16	1.19	1.16	1.17	1.18	1.16	1.16	1.18																
KUOTA E GERMIMIT	16.14	15.99	15.90	15.28	13.69	12.66	12.88	13.26	13.70	14.19	14.80	16.00	18.52	19.95	20.72	22.21																
LINJA TUBACIONIT	D=315mm i=0.5% - L=18.7m		D=315mm i=0.5% - L=12.7m		D=315mm i=3.0% - L=19.4m		D=315mm i=7.1% - L=21.3m		D=315mm i=2.8% - L=30.9m		D=400mm i=0.7% - L=18.8m		D=315mm i=2.2% - L=10.9m		D=315mm i=2.3% - L=16.5m		D=315mm i=1.8% - L=19.9m		D=315mm i=3.2% - L=15.8m		D=250mm i=8.4% - L=14.9m		D=250mm i=12.1% - L=18.7m		D=250mm i=6.0% - L=21.0m		D=250mm i=4.4% - L=15.8m		D=250mm i=9.9% - L=19.1m		D=250mm i=17.7% - L=18.0m	

GRUPI I PROJEKTTIMIT

ATELIER 4
ARCHITECTURE & CONSULTING STUDIO

Rr. "Kosovartine", Nr.11, Tiranë, Shqipëri
tel: +355 4 24 30 195 / 4 22 22 804
fax: +355 4 24 30 194
mobile: +355 69 20 38 958
e-mail: info@atelier4.al
web: www.atelier4.al

KEJSI-05
ELECTRICAL ENGINEERING STUDIO

Rr. "Zef Juban", Nr.11, Tiranë, Shqipëri
mobile: +355 68 40 38 122
mobile: +355 68 20 77 941
e-mail: info@kejsi05.com
web: www.kejsi05.com

TITULLI I PROJEKTTIT

RIKUALIFIKIM URBAN I ZONËS "KODRA E DIELLIT"

AUTORITETI KONTRAKTOR

BASHKIA TIRANË

KODI I VIZATIMIT	NR. I VIZATIMIT
KD C A 0	PL. KUSH_2/1
KODI	FAZA
DISIPLINA	RISHIKIM

EMËRTIMI I VIZATIMIT

PROFILI GJATESOR I KUSH

SHKALLA	1:100	DATA	MAJ 2019
----------------	-------	-------------	----------

PËRSHKRIMI I FAZËS

PROJEKT - ZBATIMI

RISHIKIM	DATA	FAZA E PROJEKTTIT
0	2019	C

PROFILI GJATESOR I KUSH Rruga - VANGJEL MEKSI DEGA MAJTAS

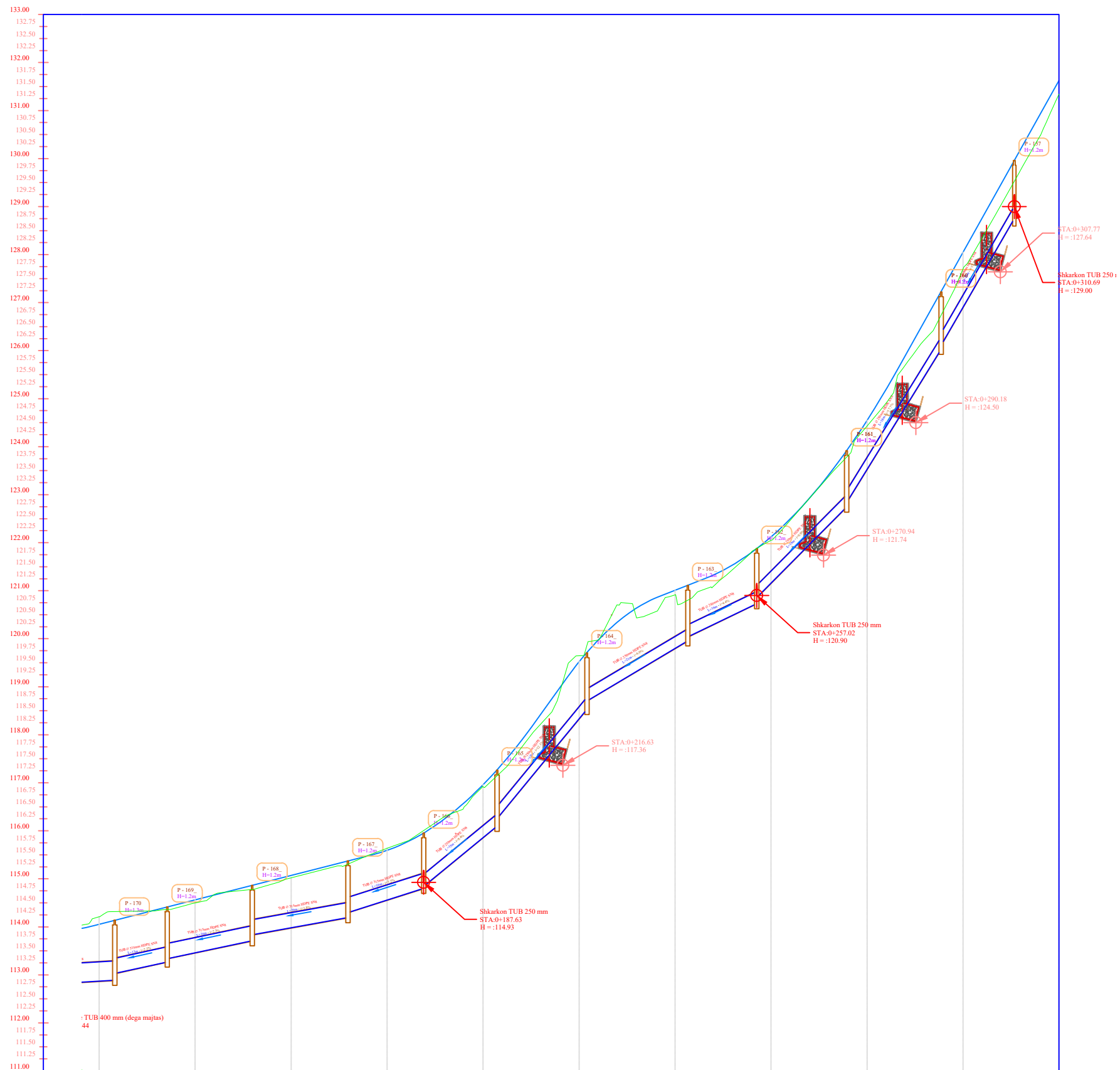

EMERTIMI I PUSETES	P-170	P-169	P-168	P-167	P-166	P-165	P-164	P-163	P-162	P-161	P-160	P-157
DISTANCA PROGRESIVE	14.05	14.50	15.02	15.54	16.06	16.58	17.10	17.62	18.14	18.66	19.18	20.00
KUOTA E RRUGES	114.05	114.50	14.98	15.50	16.02	16.54	17.06	17.58	18.10	18.62	19.14	20.00
KUOTA PROJEKTTIT	114.05	114.50	15.02	15.54	16.06	16.58	17.10	17.62	18.14	18.66	19.18	20.00
KUOTA PUSETES	114.14	114.44	14.86	15.37	15.96	16.54	17.17	17.84	18.51	19.18	19.85	20.96
THELLESIA E PUSETES	1.20	1.15	1.16	1.19	1.16	1.17	1.18	1.16	1.18	1.18	1.20	1.21
KUOTA E GERMIMIT	112.88	113.36	13.70	14.19	14.80	15.41	16.03	16.65	17.27	17.89	18.51	19.13
LINJA TUBACIONIT	im	D=315mm i=2.2% - L=10.9m	D=315mm i=2.3% - L=16.5m	D=315mm i=1.8% - L=19.9m	D=315mm i=3.2% - L=15.8m	D=250mm i=8.4% - L=14.9m	D=250mm i=12.1% - L=18.7m	D=250mm i=6.0% - L=21.0m	D=250mm i=4.4% - L=15.8m	D=250mm i=9.9% - L=19.1m	D=250mm i=17.7% - L=18.0m	D=250mm i=17.3% - L=15.2m

GRUPI I PROJEKTTIT



ATELIER 4
ARCHITECTURE & CONSULTING STUDIO
Rr. "Kosovartine", Nr.11, Hyrja 6, Ap.4/1,
Njësia Administrative Nr. 5, 1019, Tiranë, Shqipëri
tel: +355 4 24 30 195 / 4 22 22 804
fax: +355 4 24 30 194
mobile: +355 69 20 38 958
e-mail: info@atelier4.al
web: www.atelier4.al

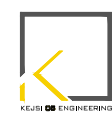

KEJSI-05
ELECTRICAL ENGINEERING STUDIO
Rr. "Zef Juban", Nr.11, Hyrja 7, Ap. 3, Tiranë, Shqipëri
mobile: +355 68 40 38 122
mobile: +355 68 20 77 941
e-mail: info@kejsi05.com
web: www.kejsi05.com

TITULLI I PROJEKTTIT

RIKUALIFIKIM URBAN I ZONËS "KODRA E DIELLIT"

AUTORITETI KONTRAKTOR

BASHKIA TIRANË

KODI I VIZATIMIT

KD C A 0
KODI FAZA DISIPLINA RISHIKIM

NR. I VIZATIMIT

PL. KUSH_2/2

EMËRTIMI I VIZATIMIT

PROFILI GJATESOR I KUSH

SHKALLA 1:100 DATA MAJ 2019

PËRSHKRIMI I FAZËS PROJEKT - ZBATIMI

RISHIKIM	DATA	FAZA E PROJEKTTIT
0	2019	C

PROFILI GJATESOR I KUSH Rruga - XHIM BEGEJA
DEGA MAJTAS

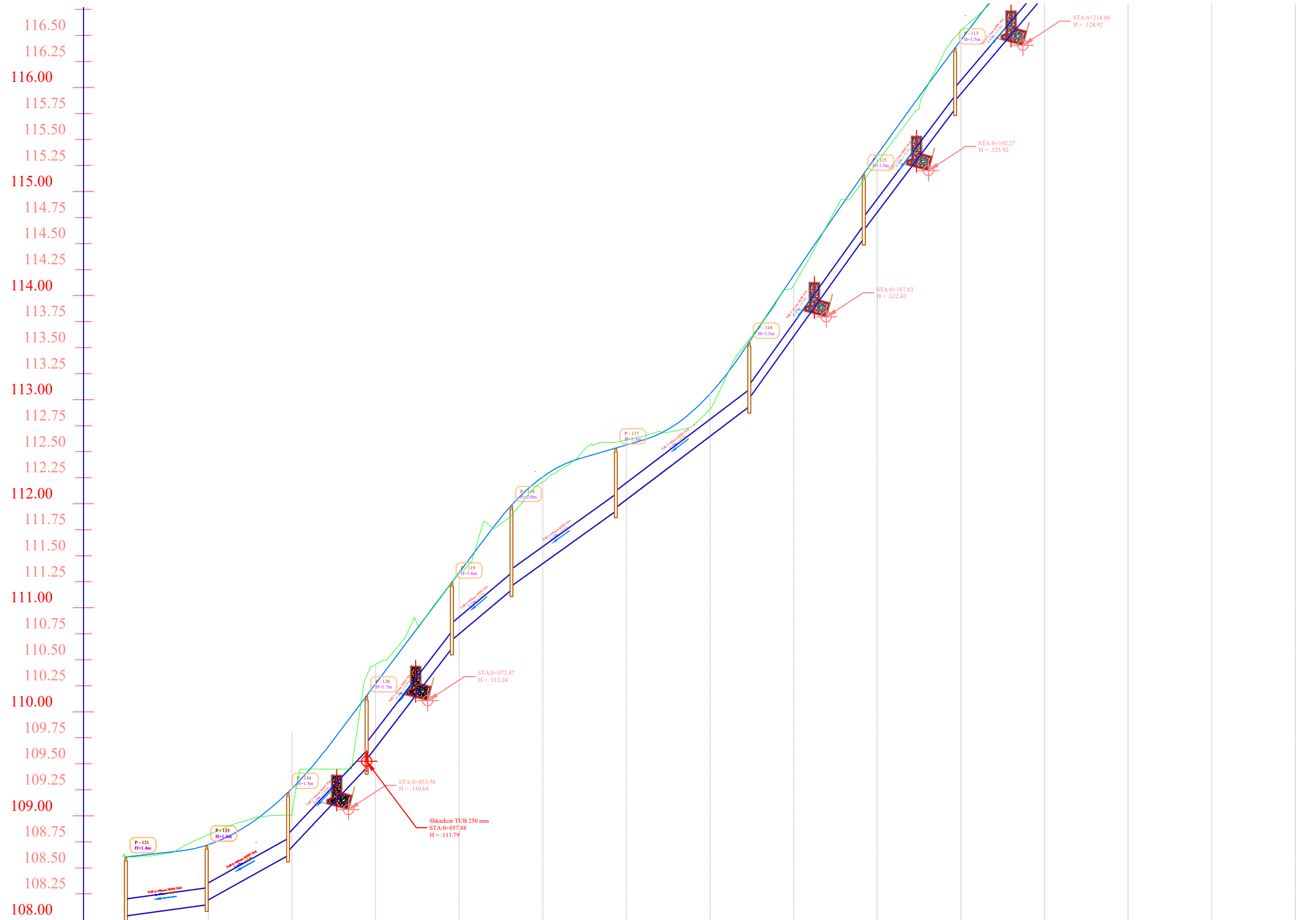

EMERTIMI I PUSETES	P-121	P-115	P-114	P-113	P-112	P-111	P-110	P-109	P-108	P-107	P-106	P-105	P-104	P-103	P-102	P-101	P-96	P-95	P-94													
DISTANCA PROGRESIVE	0+00.00	0+01.00	0+02.00	0+03.00	0+04.00	0+05.00	0+06.00	0+07.00	0+08.00	0+09.00	0+10.00	0+11.00	0+12.00	0+13.00	0+14.00	0+15.00	0+16.00	0+17.00	0+18.00	0+19.00	0+20.00	0+21.00	0+22.00	0+23.00	0+24.00	0+25.00	0+26.00	0+27.00	0+28.00			
KUOTA E RRUGES	108.50	108.50	108.50	108.50	108.50	108.50	108.50	108.50	108.50	108.50	108.50	108.50	108.50	108.50	108.50	108.50	108.50	108.50	108.50	108.50	108.50	108.50	108.50	108.50	108.50	108.50	108.50	108.50	108.50			
KUOTA PROJEKTIT	109.50	109.50	109.50	109.50	109.50	109.50	109.50	109.50	109.50	109.50	109.50	109.50	109.50	109.50	109.50	109.50	109.50	109.50	109.50	109.50	109.50	109.50	109.50	109.50	109.50	109.50	109.50	109.50	109.50	109.50		
KUOTA PUSETES	109.50	109.50	109.50	109.50	109.50	109.50	109.50	109.50	109.50	109.50	109.50	109.50	109.50	109.50	109.50	109.50	109.50	109.50	109.50	109.50	109.50	109.50	109.50	109.50	109.50	109.50	109.50	109.50	109.50	109.50	109.50	
THELLESIA E PUSETES	1.42	1.43	1.51	1.72	1.58	2.02	1.51	1.54	2.18	1.54	2.83	1.46	2.85	3.17	1.52	3.49	1.52	3.67														
KUOTA E GERMIMIT	108.00	108.35	109.54	111.05	113.35	116.07	117.77	120.27	124.29	127.39	130.19	132.99	135.46																			
LINJA TUBACIONIT	D=400mm i=1.4% - L=19.3m	D=400mm i=5.6% - L=19.5m	D=400mm i=10.6% - L=18.8m	D=400mm i=13.0% - L=20.4m	D=400mm i=8.1% - L=14.8m	D=400mm i=6.0% - L=29.8m	D=400mm i=9.3% - L=26.1m	D=315mm i=13.9% - L=27.4m	D=315mm i=13.3% - L=21.8m	D=315mm i=11.8% - L=22.1m	D=315mm i=9.1% - L=27.9m	D=315mm i=11.9% - L=19.5m	D=315mm i=20.6% - L=21.9m																			

GRUPI I PROJEKTIMIT

ATELIER 4
ARCHITECTURE & CONSULTING STUDIO
Rr. "Kosovartine", Nr.11, Prizren, Shqipëri
tel: +355 4 24 30 195 / 4 22 22 804
fax: +355 4 24 30 194
mobile: +355 69 20 38 958
e-mail: info@atelier4.al
web: www.atelier4.al

KEJSI-05
ELECTRICAL ENGINEERING STUDIO
Rr. "Zef Juban", Nr.11, Prizren, Shqipëri
mobile: +355 68 40 38 122
mobile: +355 68 20 77 941
e-mail: info@kejsi05.com
web: www.kejsi05.com

TITULLI I PROJEKTIT

RIKUALIFIKIM URBAN I ZONËS "KODRA E DIELLIT"

AUTORITETI KONTRAKTOR

BASHKIA TIRANË

KODI I VIZATIMIT	NR. I VIZATIMIT
KD C A 0 KODI FAZA DISIPLINA RISHIKIM	PL. KUSH_3/1

EMËRTIMI I VIZATIMIT

PROFILI GJATESOR I KUSH

SHKALLA	1:100	DATA	MAJ 2019
----------------	-------	-------------	----------

PËRSHKRIMI I FAZËS

PROJEKT - ZBATIMI

RISHIKIM	DATA	FAZA E PROJEKTIT
0	2019	C

PROFILI GJATESOR I KUSH Rruga - XHIM BEGEJA DEGA MAJTAS

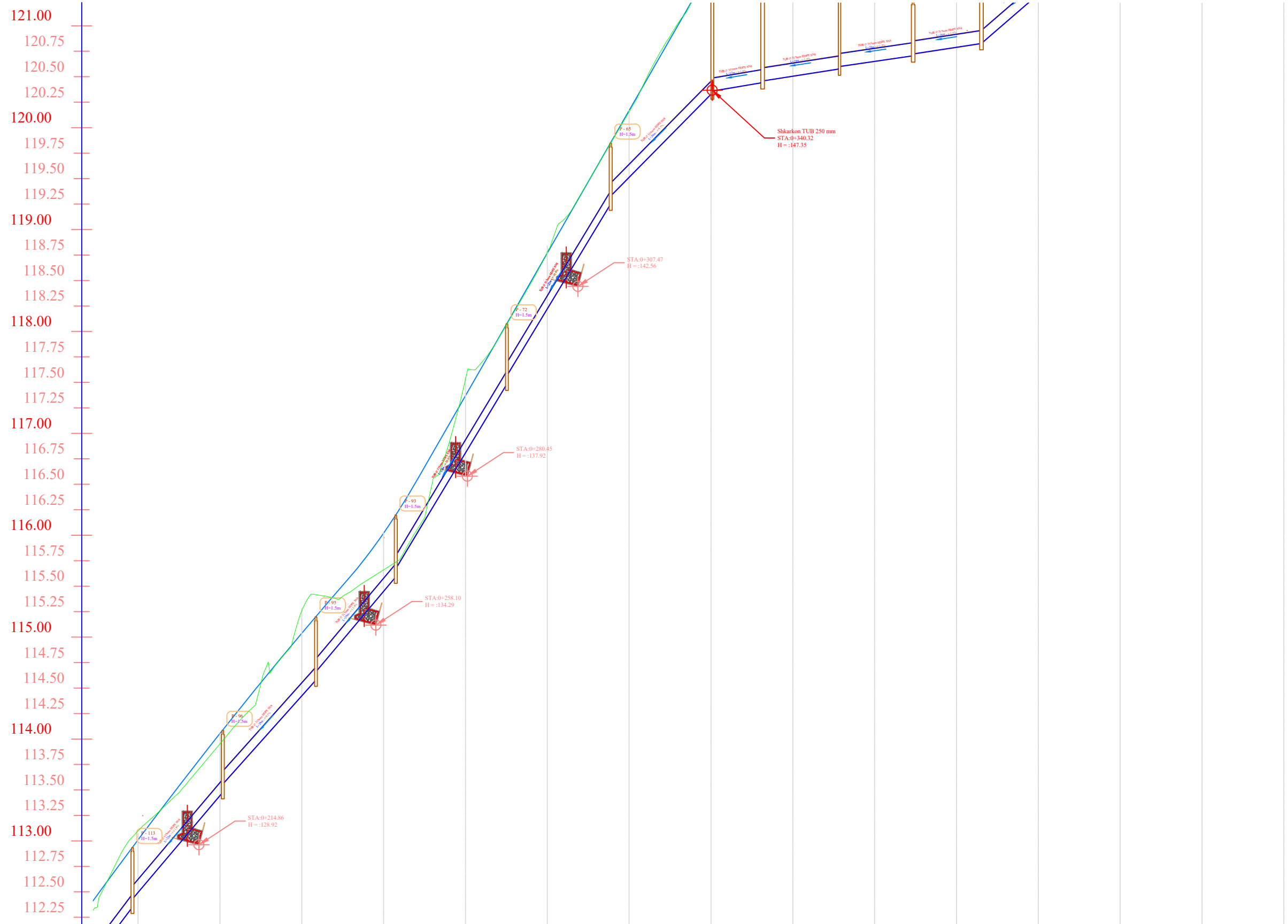

EMERTIMI I PUSETES	P-111	P-96	P-95	P-93	P-72	P-65	P-64	P-43	P-42	P-41	P-40	P-38	P-37
DISTANCA PROGRESIVE	0+000-0+200	0+220-0+220	0+240-0+240	0+260-0+260	0+280-0+280	0+300-0+300	0+340-0+340	0+360-0+360	0+380-0+380	0+400-0+400	0+420-0+420	0+440-0+440	0+480-0+480
KUOTA E RRUGES	129.20	131.40	134.60	135.64	140.33	143.55	150.43	151.00	149.85	149.62	150.84	152.83	153.67
KUOTA PROJEKTTIT	129.04	131.64	134.09	136.53	139.89	143.37	150.21	150.69	149.81	149.60	150.72	152.81	153.61
KUOTA PUSETES	128.85	131.71	134.49	136.97	141.64	146.06	150.23	150.94	149.54	149.79	151.35	153.40	153.61
THELLESIA E PUSETES	1.46	1.52	1.55	1.52	1.47	1.50	1.50	1.34	1.35	1.31	1.10	1.21	1.96
KUOTA E GERMIMIT	127.39	130.19	132.99	135.46	140.17	144.56	147.28	147.51	148.19	148.69	150.25	151.19	151.65
LINJA TUBACIONIT	n/n D=315mm i=11.8% - L=22.1m	D=315mm i=9.1% - L=27.9m	D=315mm i=11.9% - L=19.5m	D=315mm i=20.6% - L=21.9m	D=315mm i=18.9% - L=22.2m	D=315mm i=9.7% - L=26.0m	D=315mm i=1.6% - L=12.9m	D=315mm i=1.5% - L=19.2m	D=315mm i=1.5% - L=18.0m	D=315mm i=1.5% - L=17.7m	D=315mm i=8.7% - L=20.4m	D=315mm i=5.3% - L=16.2m	D=315mm i=1.3% - L=33.2m

GRUPI I PROJEKTIMIT



ATELIER 4
ARCHITECTURE & CONSULTING STUDIO
Rr. e "Kosovartine", Nr.11, Hyrja 6, Ap.4/1,
Njësia Administrative Nr. 5, 1019, Tiranë, Shqipëri
tel: +355 4 24 30 195 / 4 22 22 804
fax: +355 4 24 30 194
mobile: +355 69 20 38 958
e-mail: info@atelier4.al
web: www.atelier4.al



KEJSI-05
ELECTRICAL ENGINEERING STUDIO
Rr. "Zef Juban", Nr.11, Ap. 3, Tiranë, Shqipëri
mobile: +355 68 40 38 122
mobile: +355 68 20 77 941
e-mail: info@kejsi05.com
web: www.kejsi05.com

TITULLI I PROJEKTTIT

RIKUALIFIKIM URBAN I ZONËS "KODRA E DIELLIT"

AUTORITETI KONTRAKTOR

BASHKIA TIRANË

KODI I VIZATIMIT	NR. I VIZATIMIT
KD C A 0 <small>KODI FAZA DISIPLINA RISHIKIM</small>	PL. KUSH_3/2

EMËRTIMI I VIZATIMIT

PROFILI GJATESOR I KUSH

SHKALLA	1:100	DATA	MAJ 2019
----------------	-------	-------------	----------

PËRSHKRIMI I FAZËS

PROJEKT - ZBATIMI

RISHIKIM	DATA	FAZA E PROJEKTTIT
0	2019	C

PROFILI GJATESOR I KUSH Rruga - XHIM BEGEJA DEGA MAJTAS

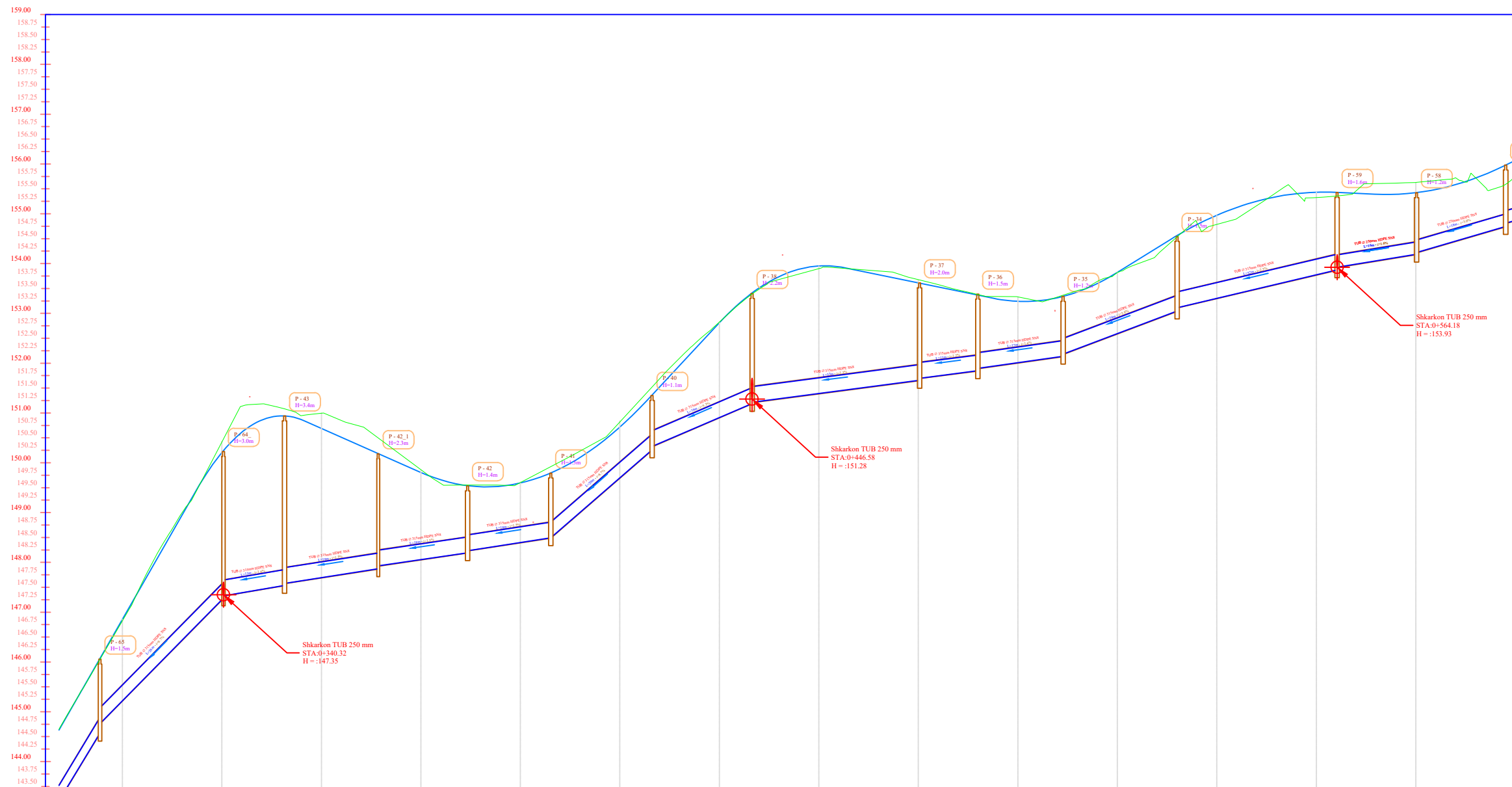

EMERTIMI I PUSETES	P-65	P-64	P-43	P-42.1	P-42	P-41	P-40	P-38	P-37	P-36	P-35	P-34	P-59	P-58	P-57
DISTANCA PROGRESIVE															
KUOTA E RRUGES															
KUOTA PROJEKTTIT	146.00	150.23	150.94	150.18	149.54	149.79	151.35	153.40	153.61	153.39	153.34	154.55	155.42	155.00	156.00
KUOTA PUSETES	144.50	147.28	147.51	147.86	148.19	148.40	150.25	151.19	151.65	151.84	152.13	153.04	153.85	154.18	154.74
THELLESIA E PUSETES	1.50	2.95	3.41	2.32	1.35	1.31	1.10	2.21	1.96	1.54	1.21	1.50	1.56	1.24	1.24
KUOTA E GERMIMIT	144.50	147.28	147.51	147.86	148.19	148.40	150.25	151.19	151.65	151.84	152.13	153.04	153.85	154.18	154.74
LINJA TUBACIONIT	1m	D=315mm i=9.7% - L=26.0m	D=315mm i=1.6% - L=12.9m	D=315mm i=1.5% - L=19.2m	D=315mm i=1.5% - L=18.0m	D=315mm i=1.5% - L=17.7m	D=315mm i=8.7% - L=20.4m	D=315mm i=5.3% - L=16.2m	D=315mm i=1.3% - L=33.2m	D=315mm i=1.2% - L=12.7m	D=315mm i=1.4% - L=17.2m	D=315mm i=2.3% - L=32.4m	D=250mm i=1.6% - L=16.5m	D=250mm i=3.0% - L=17.7m	

GRUPI I PROJEKTIMIT	
 ATELIER 4 ARCHITECTURE & CONSULTING STUDIO Rr. "Kosovartine", Nr.11, Hyrja 6, Ap.4/1, Njësia Administrative Nr. 5, 1019, Tiranë, Shqipëri tel: +355 4 24 30 195 / 4 22 22 804 fax: +355 4 24 30 194 mobile: +355 69 20 38 958 e-mail: info@atelier4.al web: www.atelier4.al	 KEJSI-05 ELECTRICAL ENGINEERING STUDIO Rr. "Zef Juban", Nr.11, Hyrja 7, Ap. 3, Tiranë, Shqipëri mobile: +355 68 40 38 122 mobile: +355 68 20 77 941 e-mail: info@kejsi05.com web: www.kejsi05.com
TITULLI I PROJEKTTIT	
RIKUALIFIKIM URBAN I ZONËS "KODRA E DIELLIT"	
AUTORITETI KONTRAKTOR	
BASHKIA TIRANË	
KODI I VIZATIMIT	NR. I VIZATIMIT
KD C A 0 KODI FAZA DISIPLINA RISHIKIM	PL. KUSH_3/3
EMËRTIMI I VIZATIMIT	
PROFILI GJATESOR I KUSH	
SHKALLA	DATA
1:100	MAJ 2019
PËRSHKRIMI I FAZËS	
PROJEKT - ZBATIMI	
RISHIKIM	FAZA E PROJEKTTIT
0	C

PROFILI GJATESOR I KUSH Rruga - XHIM BEGEJA DEGA DJATHHTAS

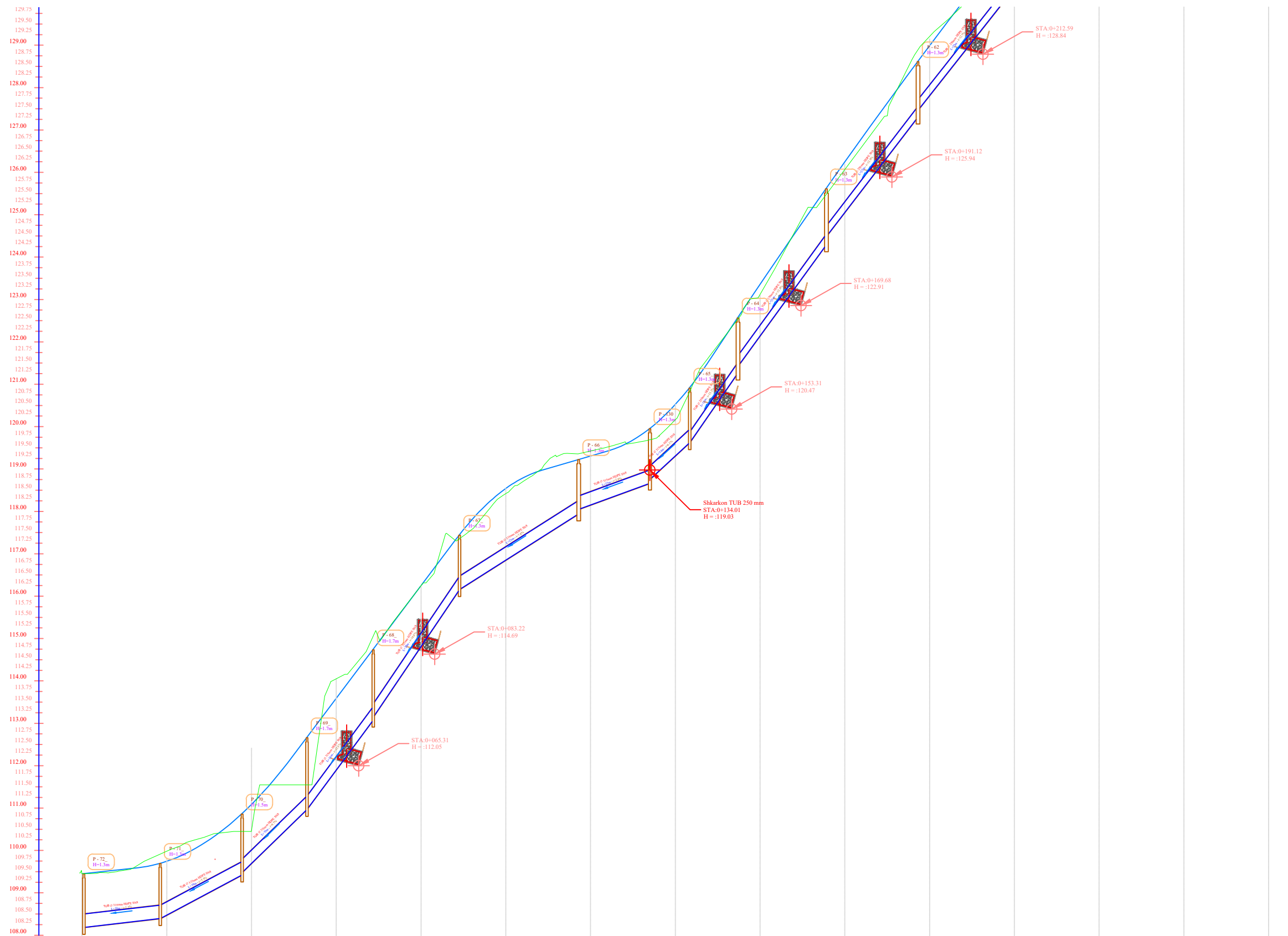

EMERTIMI I PUSETES	P-72	P-71	P-70	P-69	P-68	P-67	P-66	P-65	P-64	P-63	P-62	P-61	P-60	P-59	P-48	P-47
DISTANCA PROGRESIVE	0+00	0+020	0+040	0+060	0+080	0+100	0+120	0+140	0+160	0+180	0+200	0+220	0+240	0+260	0+280	0+300
KUOTA E RRUGES	109.50	109.75	111.14	113.65	116.30	118.00	119.35	120.58	122.62	126.30	129.04	131.64	134.09	136.53	139.89	140.30
KUOTA PROJEKTTIT	109.50	109.75	111.14	113.65	116.30	118.00	119.35	120.58	122.62	126.30	129.04	131.64	134.09	136.53	139.89	140.30
KUOTA PUSETES	109.50	109.75	111.14	113.65	116.30	118.00	119.35	120.58	122.62	126.30	129.04	131.64	134.09	136.53	139.89	140.30
THELLESIA E PUSETES	1.28	1.31	1.45	1.71	1.67	1.30	1.29	1.29	1.29	1.30	1.31	1.31	1.32	1.32	1.21	1.24
KUOTA E GERMIT	08.22	08.43	09.46	11.00	13.12	16.20	17.89	18.71	19.66	21.13	24.13	27.33	30.20	33.48	36.08	39.45
LINJA TUBACIONIT	D=315mm i=1.2% - L=18.0m	D=315mm i=5.3% - L=19.3m	D=315mm i=9.7% - L=15.3m	D=315mm i=13.5% - L=15.6m	D=315mm i=14.8% - L=20.3m	D=315mm i=7.8% - L=22.8m	D=315mm i=2.8% - L=22.1m	D=315mm i=6.1% - L=14.3m	D=250mm i=13.2% - L=12.5m	D=250mm i=13.8% - L=20.8m	D=250mm i=13.0% - L=21.6m	D=250mm i=12.7% - L=21.7m	D=250mm i=14.6% - L=21.0m	D=250mm i=12.6% - L=19.7m	D=250mm i=11.2% - L=13.4m	D=250mm i=11.9% - L=14.3m

GRUPI I PROJEKTIMIT

ATELIER 4
ARCHITECTURE & CONSULTING STUDIO
Rr. "Kosovartine", Nr.155a 35, Hyrja 6, Ap.4/1,
Njësia Administrative Nr. 5, 1019, Tiranë, Shqipëri
tel: +355 4 24 30 195 / 4 22 22 804
fax: +355 4 24 30 194
mobile: +355 69 20 38 958
e-mail: info@atelier4.al
web: www.atelier4.al

KEJSI-05
ELECTRICAL ENGINEERING STUDIO
Rr. "Zef Juban", Nr.155a 7, Ap. 3, Tiranë, Shqipëri
mobile: +355 68 40 38 122
mobile: +355 68 20 77 941
e-mail: info@kejsi05.com
web: www.kejsi05.com

TITULLI I PROJEKTTIT

RIKUALIFIKIM URBAN I ZONËS "KODRA E DIELLIT"

AUTORITETI KONTRAKTOR

BASHKIA TIRANË

KODI I VIZATIMIT	NR. I VIZATIMIT
<div style="display: flex; justify-content: space-around; font-size: 24px; font-weight: bold;"> KD C A 0 </div> <div style="display: flex; justify-content: space-around; font-size: 10px;"> KODI FAZA DISIPLINA RISHIKIM </div>	PL. KUSH_4/1

EMËRTIMI I VIZATIMIT

PROFILI GJATESOR I KUSH

SHKALLA	1:100	DATA	MAJ 2019
----------------	-------	-------------	----------

PËRSHKRIMI I FAZËS

PROJEKT - ZBATIMI

RISHIKIM	DATA	FAZA E PROJEKTTIT
0	2019	C

PROFILI GJATESOR I KUSH Rruga - XHIM BEGEJA DEGA DJATHHTAS

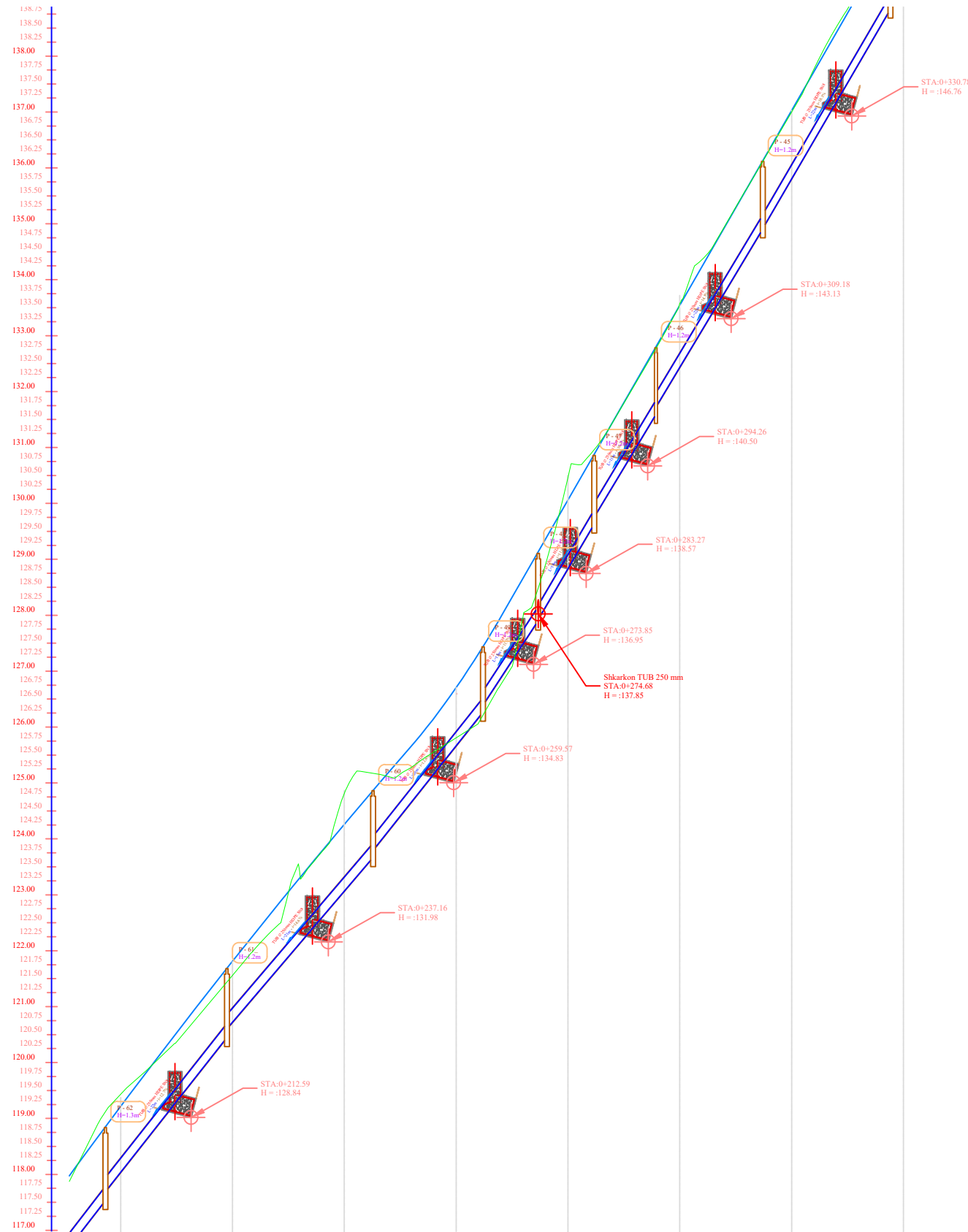

EMERTIMI I PUSETES	P-62	P-61	P-60	P-49	P-48	P-47	P-46	P-45	P-44	P-43	P-38	P-61	P-50
DISTANCA PROGRESIVE	0+000-0+200	0+200-0+220	0+220-0+260	0+260-0+300	0+300-0+320	0+320-0+340	0+340-0+360	0+360-0+380	0+380-0+400	0+400-0+420	0+420-0+440	0+440-0+460	0+460-0+480
KUOTA E RRUGES	119.75	120.25	120.75	121.25	121.75	122.25	122.75	123.25	123.75	124.25	124.75	125.25	125.75
KUOTA PROJEKTIT	119.75	120.25	120.75	121.25	121.75	122.25	122.75	123.25	123.75	124.25	124.75	125.25	125.75
KUOTA PUSETES	119.75	120.25	120.75	121.25	121.75	122.25	122.75	123.25	123.75	124.25	124.75	125.25	125.75
THELLESIA E PUSETES	1.32	1.25	1.21	1.18	1.22	1.24	1.21	1.22	1.19	2.21	2.23	2.03	2.03
KUOTA E GERMIMIT	117.75	118.25	118.75	119.25	119.75	120.25	120.75	121.25	121.75	122.25	122.75	123.25	123.75
LINJA TUBACIONIT	sm	D=250mm i=12.7% - L=21.7m	D=250mm i=14.6% - L=21.0m	D=250mm i=12.6% - L=19.7m	D=250mm i=11.2% - L=13.4m	D=250mm i=11.9% - L=14.3m	D=250mm i=16.2% - L=11.3m	D=250mm i=14.5% - L=22.0m	D=250mm i=18.1% - L=21.6m	D=250mm i=5.5% - L=17.5m	D=250mm i=1.9% - L=17.5m	D=250mm i=1.2% - L=23.1m	D=250mm i=1.0% - L=23.1m

GRUPI I PROJEKTIMIT



ATELIER 4
ARCHITECTURE & CONSULTING STUDIO
Rr. e "Kosovartit", Nr.11, Prizren, Shqipëri
tel: +355 4 24 30 195 / 4 22 22 804
fax: +355 4 24 30 194
mobile: +355 69 20 38 958
e-mail: info@atelier4.al
web: www.atelier4.al



KEJSI-05
ELECTRICAL ENGINEERING STUDIO
Rr. "Zef Juban", Nr.11, Prizren, Shqipëri
mobile: +355 68 40 38 122
mobile: +355 68 20 77 941
e-mail: info@kejsi05.com
web: www.kejsi05.com

TITULLI I PROJEKTIT

RIKUALIFIKIM URBAN I ZONËS "KODRA E DIELLIT"

AUTORITETI KONTRAKTOR

BASHKIA TIRANË

KODI I VIZATIMIT

KD C A 0
KODI FAZA DISIPLINA RISHIKIM

NR. I VIZATIMIT

PL. KUSH_4/2

EMËRTIMI I VIZATIMIT

PROFILI GJATESOR I KUSH

SHKALLA 1:100 DATA MAJ 2019

PËRSHKRIMI I FAZËS

PROJEKT - ZBATIMI

RISHIKIM DATA FAZA E PROJEKTIT

0 2019 C

PROFILI GJATESOR I KUSH Rruga - XHIM BEGEJA
DEGA DJATHHTAS

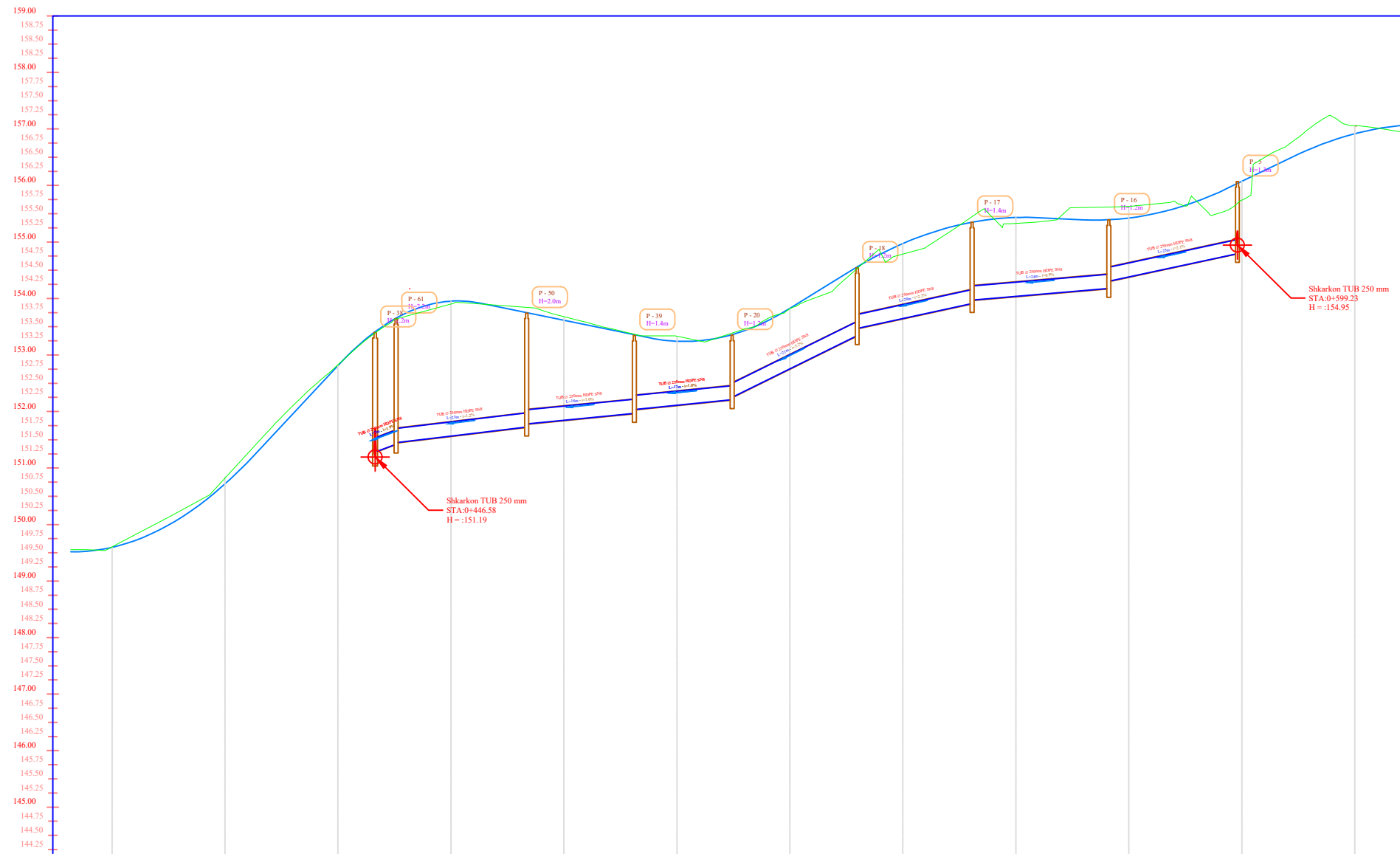

EMERTIMI I PUSETES				P-38	P-61		P-50	P-39	P-20	P-18	P-17	P-16	P-5
DISTANCA PROGRESIVE	0+000	0+040	0+080	0+120	0+160	0+200	0+240	0+280	0+320	0+360	0+400	0+440	0+480
KUOTA E RRUGES	149.00	149.50	150.00	150.50	151.00	151.50	152.00	152.50	153.00	153.50	154.00	154.50	155.00
KUOTA PROJEKTTIT	149.00	149.50	150.00	150.50	151.00	151.50	152.00	152.50	153.00	153.50	154.00	154.50	155.00
KUOTA PUSETES				151.19	151.41		151.72	151.96	152.20	152.44	152.68	152.92	153.16
THELLESIA E PUSETES				2.21	2.23		2.03	1.99	1.15	1.21	1.45	1.22	1.28
KUOTA E GERMIMIT				151.19	151.41		151.72	151.96	152.20	152.44	152.68	152.92	153.16
LINJA TUBACIONIT				D=250mm i=1.9% - L=7.5m	D=250mm i=1.2% - L=23.1m		D=250mm i=1.0% - L=18.0m	D=250mm i=1.0% - L=17.3m	D=250mm i=5.2% - L=21.0m	D=250mm i=2.2% - L=20.3m	D=250mm i=0.9% - L=23.6m	D=250mm i=2.1% - L=23.3m	

GRUPI I PROJEKTIMIT

ATELIER 4
ARCHITECTURE & CONSULTING STUDIO
Rr. "Kosovartine", Nr.11, Hyrja 6, Ap.4/1,
Njësia Administrative Nr. 5, 1019, Tiranë, Shqipëri
tel: +355 4 24 30 195 / 4 22 22 804
fax: +355 4 24 30 194
mobile: +355 69 20 38 958
e-mail: info@atelier4.al
web: www.atelier4.al

KEJSI-05
ELECTRICAL ENGINEERING STUDIO
Rr. "Zef Juban", Nr.11, Hyrja 7, Ap. 3, Tiranë, Shqipëri
mobile: +355 68 40 38 122
mobile: +355 68 20 77 941
e-mail: info@kejsi05.com
web: www.kejsi05.com

TITULLI I PROJEKTTIT

RIKUALIFIKIM URBAN I ZONËS "KODRA E DIELLIT"

AUTORITETI KONTRAKTOR

BASHKIA TIRANË

KODI I VIZATIMIT	NR. I VIZATIMIT
KD C A 0 <small>KODI FAZA DISIPLINA RISHIKIM</small>	PL. KUSH_4/4

EMËRTIMI I VIZATIMIT

PROFILI GJATESOR I KUSH

SHKALLA	1:100	DATA	MAJ 2019
---------	-------	------	----------

PËRSHKRIMI I FAZËS
PROJEKT - ZBATIMI

RISHIKIM	DATA	FAZA E PROJEKTTIT
0	2019	C



PUSETE KUSH
SH 1:25

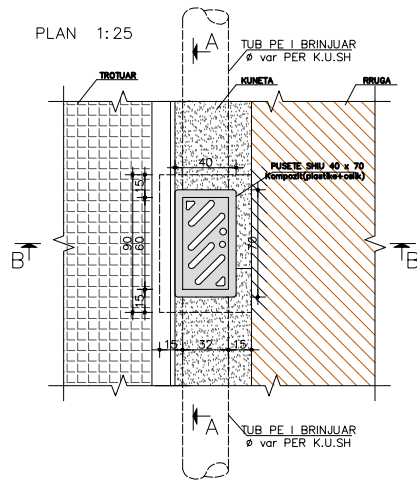

PUSETE KUSH + TIROLEZE
SH 1:25

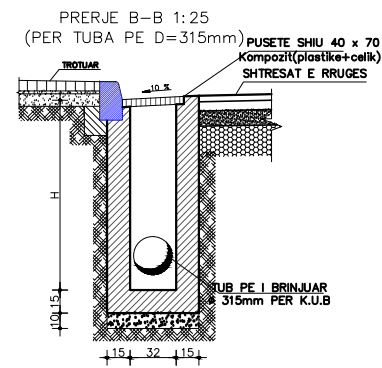

PUSETE KUSH
SH 1:25

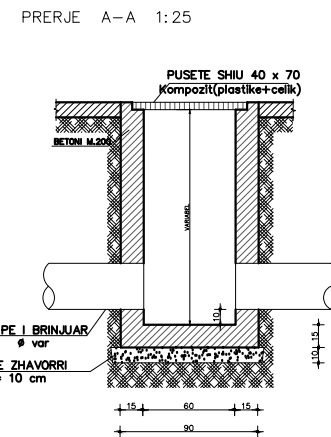

SHËNIME TEKNIKE:

1. Muret e pusetes do te jene beton M-200 dhe me trashesi 15cm.
2. Telajo e kapakut do te jete prej materiali kompozit i inkastruar me brezin e betonit dhe i vendosur ne nivelin e mbaruar te rruges sipas projektit.
3. Fundi i tubit duhet te jete 10cm nga fundi i pusetes.
4. Diametri i tubit do te jete si ne planimetri.
5. Thellesia e pusetes dhe tubacioneve do jete kostante pergjate gjithë gjatesise se rruges, ku distanca e vijes se linjes se tubacioneve me vijen e projektit do te jete e pa ndryshuar.

PUSETE KUSH Ø 400(500)mm
SH 1:25

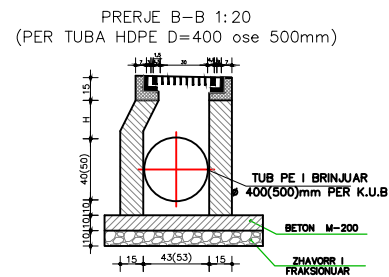

TIROLEZE - ZGARA PER KAPJEN E UJERAVE SIPERFAQESOR TE SHIUT
SH 1:25

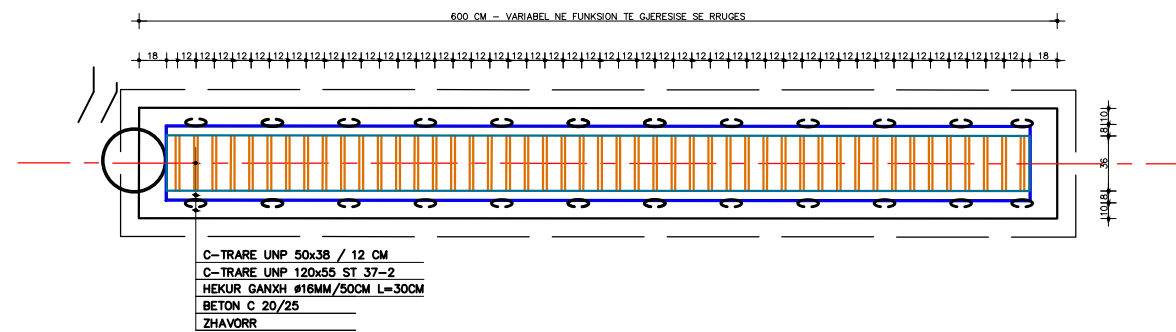

GRUPI I PROJEKTIMIT

	ATELIER 4 ARCHITECTURE & CONSULTING STUDIO Rr. "Kosovartine", Nr.11, Nr.35, Hyrja 6, Ap.4/1, Njësia Administrative Nr. 5, 1015, Tiranë, Shqipëri tel: +355 4 24 30 195 / 4 22 22 804 fax: +355 4 24 30 194 mobile: +355 69 20 38 958 e-mail: info@atelier4.al web: www.atelier4.al

TITULLI I PROJEKTIT

RIKUALIFIKIM URBAN I ZONËS "KODRA E DIELLIT"

AUTORITETI KONTRAKTOR

BASHKIA TIRANË

KODI I VIZATIMIT

KD C A 0
KODI FAZA DISIPLINA RISHIKIM

NR. I VIZATIMIT

Det. KUSH_1

EMËRTIMI I VIZATIMIT

Pusetat + tiroleze KUSH

SHKALLA 1:100 DATA MAJ 2019

PËRSHKRIMI I FAZËS
PROJEKT - ZBATIMI

RISHIKIM	DATA	FAZA E PROJEKTIT
0	2019	C



PRERJE TERTHORE KANALI

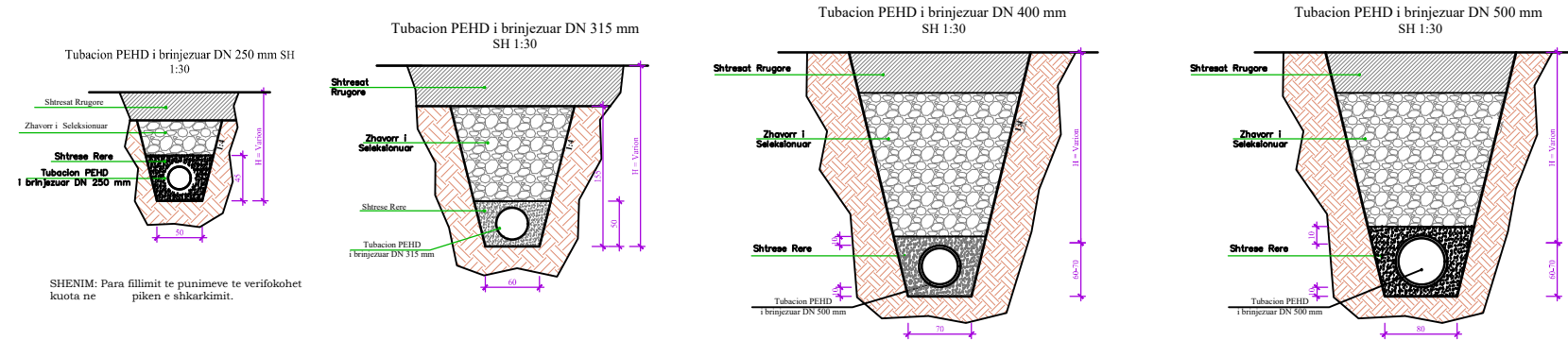

SHENIM: Para fillimit te punimeve te verifikohet knota ne pikën e shkarkimit.

SHKARKIMI I KUSH NE KOLEKTORAT KRYESOR

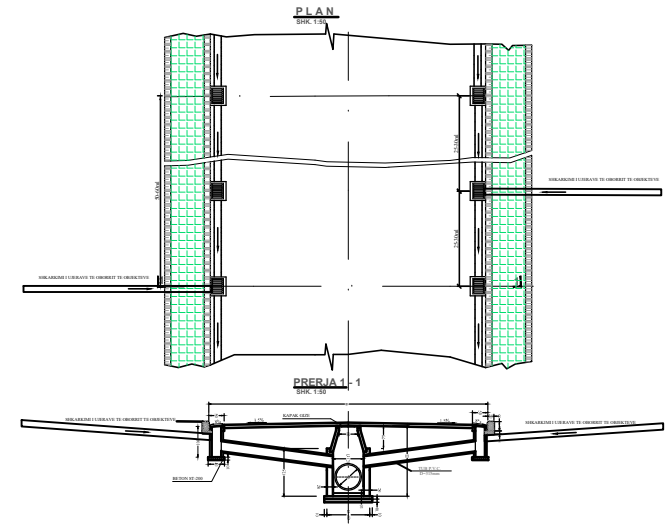

DETAJE ANKERI PER TUBACIONE Ø 250 - 315 - 400 mm

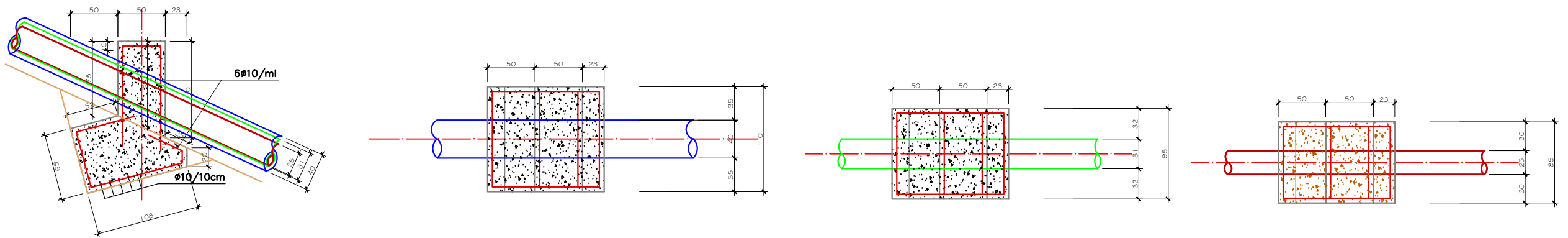

GRUPI I PROJEKTIMIT	
 <p>ATELIER 4 ARCHITECTURE & CONSULTING STUDIO Rr. "Kosovartine", Nr.11, Hyrja 6, Ap.4/1, Njësia Administrative Nr. 5, 1015, Tiranë, Shqipëri tel: +355 4 24 30 195 / 4 22 22 804 fax: +355 4 24 30 194 mobile: +355 69 20 38 958 e-mail: info@atelier4.al web: www.atelier4.al</p>	 <p>KEJSI-05 ELECTRICAL ENGINEERING STUDIO Rr. "Zef Juban", Nr.11, Hyrja 7, Ap. 3, Tiranë, Shqipëri mobile: +355 68 40 38 122 mobile: +355 68 20 77 941 e-mail: info@kejsi05.com web: www.kejsi05.com</p>
TITULLI I PROJEKTIT	
RIKUALIFIKIM URBAN I ZONËS "KODRA E DIELLIT"	
AUTORITETI KONTRAKTOR	
BASHKIA TIRANË	
KODI I VIZATIMIT	NR. I VIZATIMIT
KD C A 0 KODI FAZA DISIPLINA RISHIKIM	Det. KUSH_2
EMËRTIMI I VIZATIMIT	
Prerje terthore + detaje KUSH	
SHKALLA	1:100
DATA	MAJ 2019
PËRSHKRIMI I FAZËS	
PROJEKT - ZBATIMI	
RISHIKIM	DATA
0	2019
FAZA E PROJEKTIT	C