



BASHKIA KRUJË

PROJEKT PREVENTIV ZBATIMI

EMËRTIMI : SISTEMIM - ASFALTIM I RRUGËS SË VARREZAVE NIKËL, KRUJË

NJESIA ADMINISTRATIVE NIKËL, BASHKIA KRUJE

PROJEKTUESI

" HMK CONSULTING " shpk

INVESTITORI

KRYETARI I BASHKISË

ARTUR BUSHI



REPUBLIKA E SHQIPËRISË
BASHKIA KRUIJË

EMERTIMI

PROJEKT PREVENTIV ZBATIMI
SISTEMIM-ASFALTIM I RRUGËS
SË VARREZAVE NIKËL

NJESIA ADMINISTRATIVE NIKËL
BASHKIA KRUIJË

EMERTIMI I FLETËS

PLANIMETRIA CS-1 - CS-8

PROJEKTUESI

" HMK CONSULTING " shpk

FLETA U-02

SH 1 : 850





REPUBLIKA E SHQIPËRISË

BASHKIA KRUJË

EMERTIMI
 PROJEKT PREVENTIV ZBATIMI
 SISTEMIM-ASFALTIM I RRUGËS SË VARREZAVE NIKËL

NJESIA ADMINISTRATIVE NIKËL

BASHKIA KRUJE

EMERTIMI I FLETËS

PROFILI TËRTHORE

PROJEKTUESI

" HMK CONSULTING " shpk

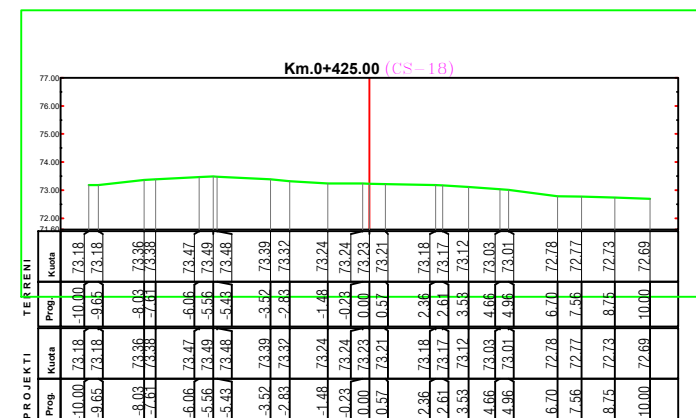
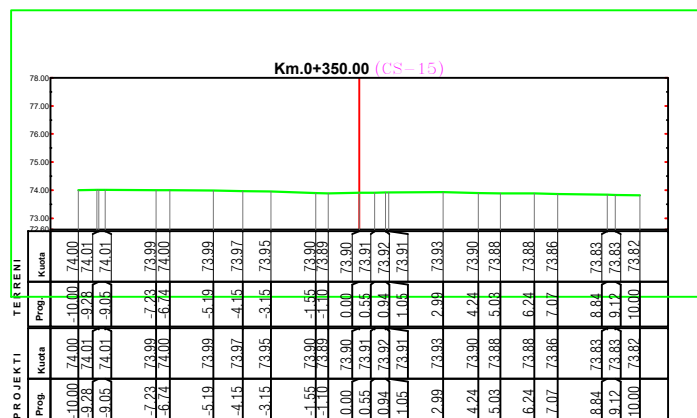
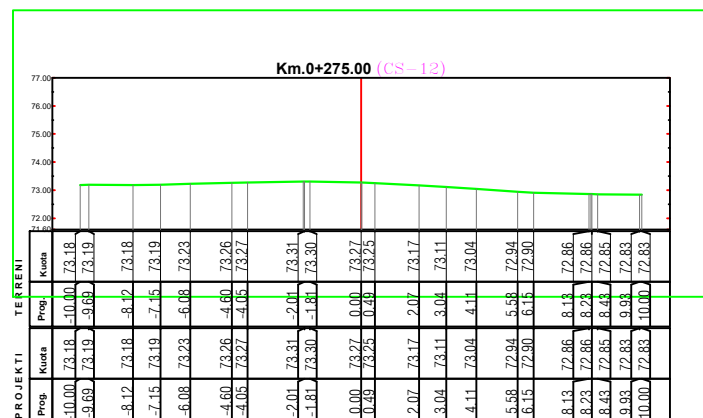
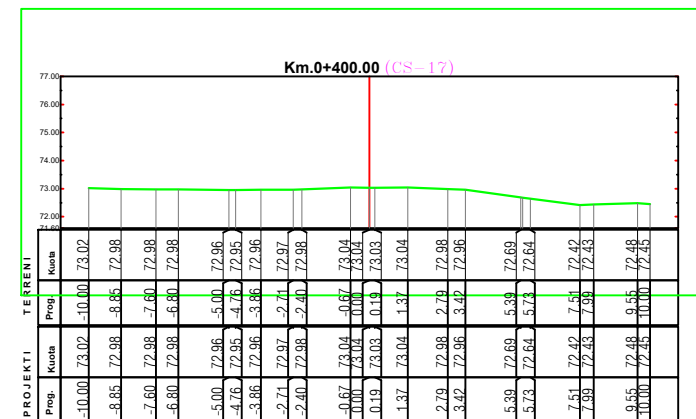
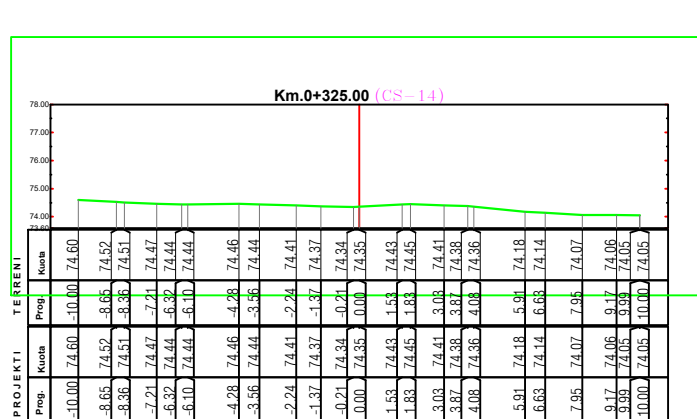
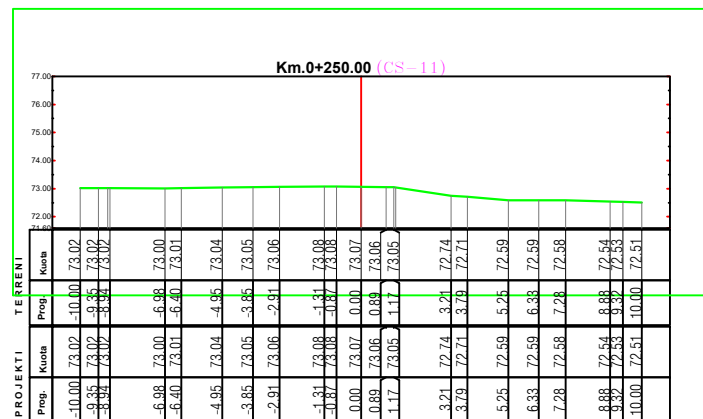
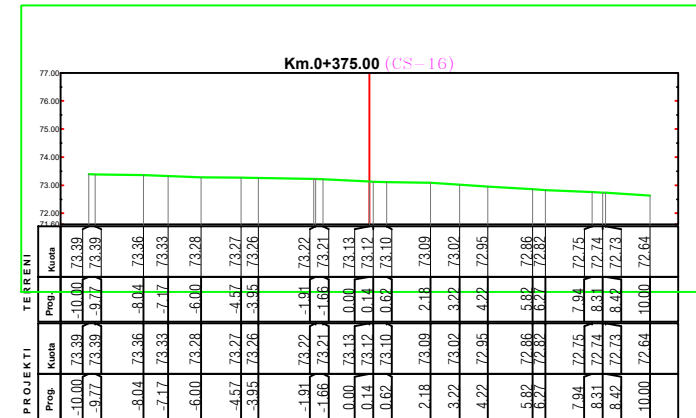
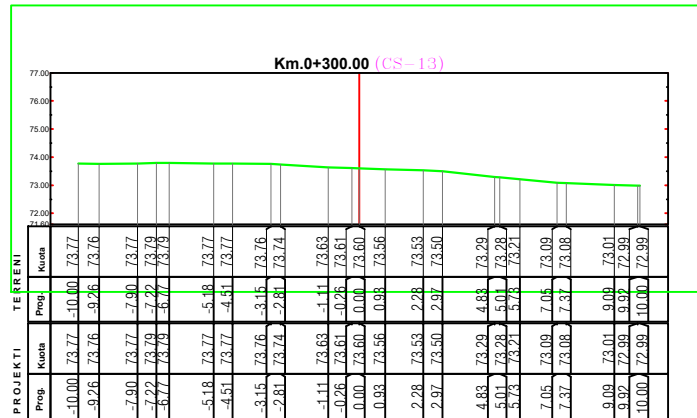
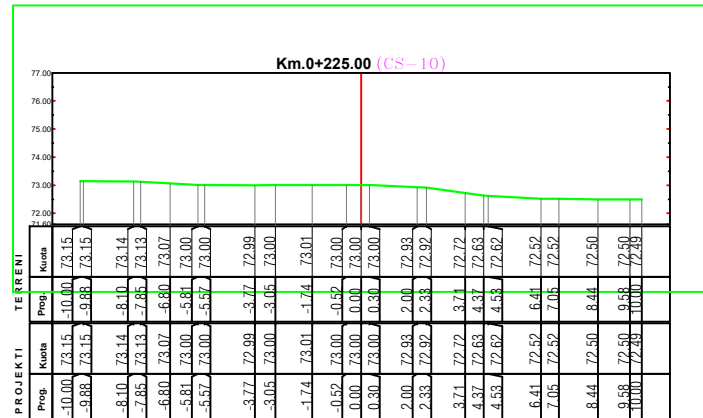



REPUBLIKA E SHQIPËRISË

BASHKIA KRUIJË

EMERTIMI
 PROJEKT PREVENTIV ZBATIMI
 SISTEMIM-ASFALTIM I RRUGËS SË VARREZAVE NIKËL

NJESIA ADMINISTRATIVE NIKËL

BASHKIA KRUIJË

EMERTIMI I FLETËS

PROFILI TËRTHORE

PROJEKTUESI

" HMK CONSULTING " shpk

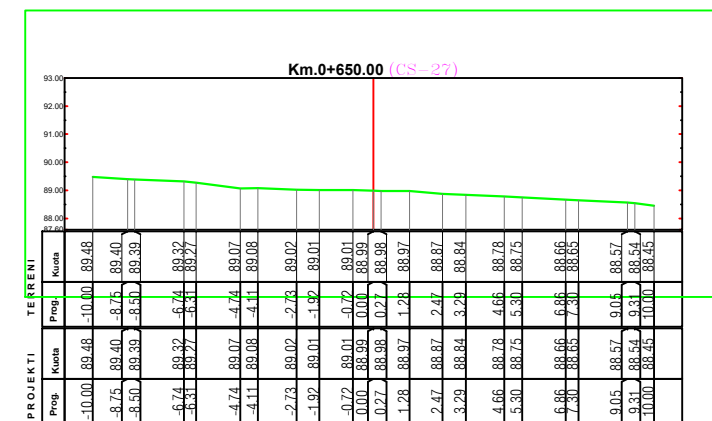
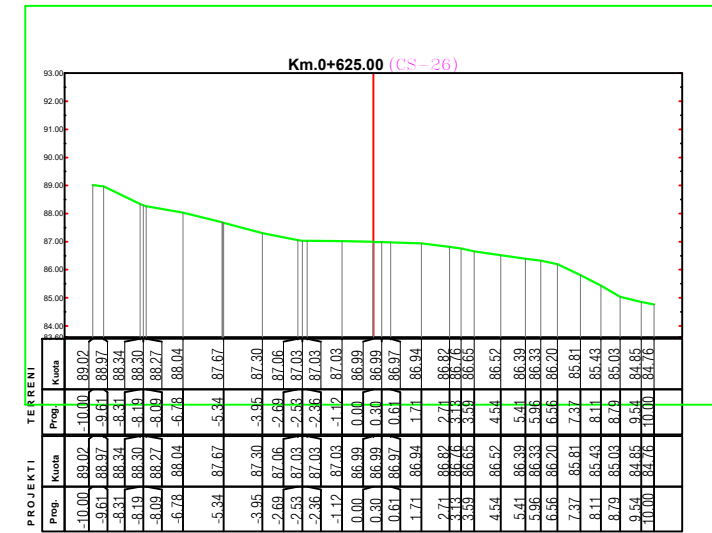
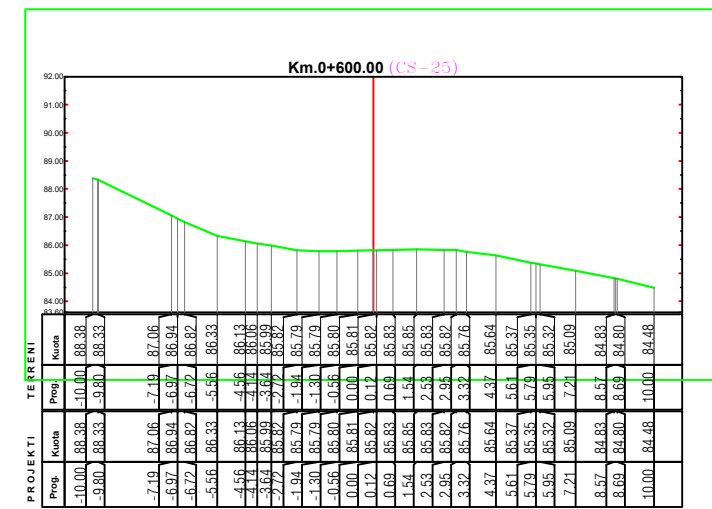
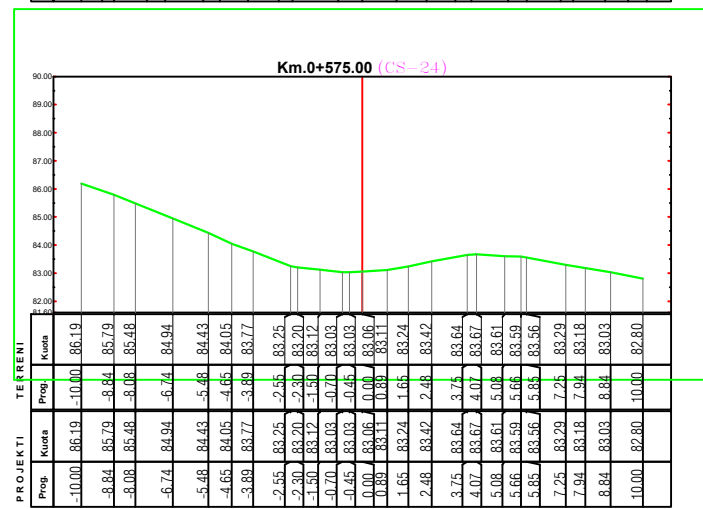
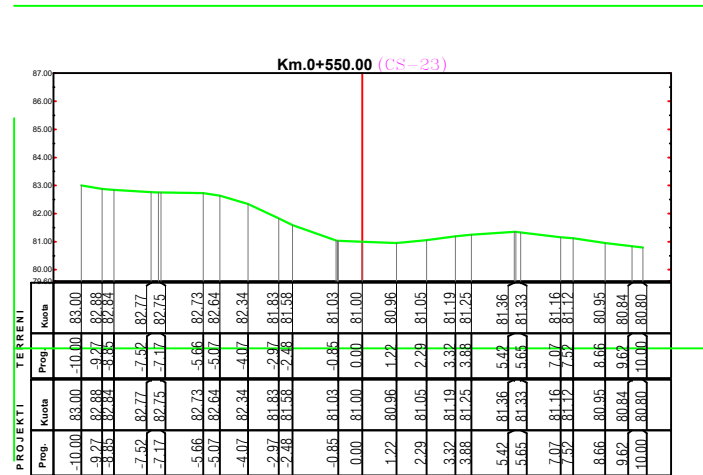
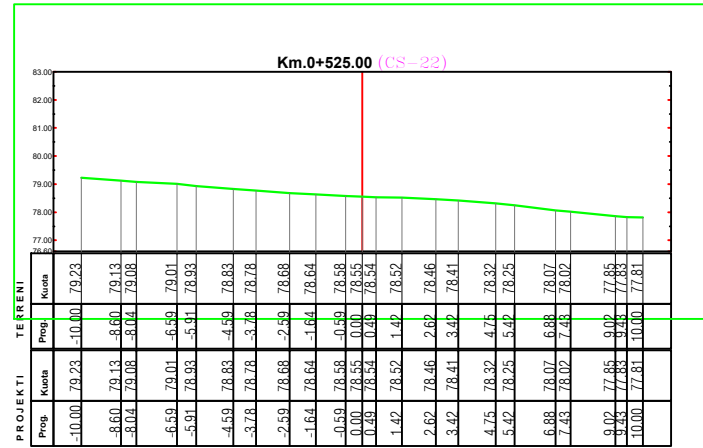
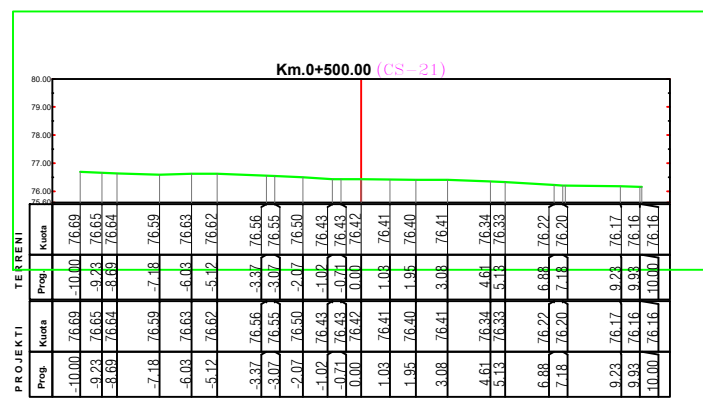
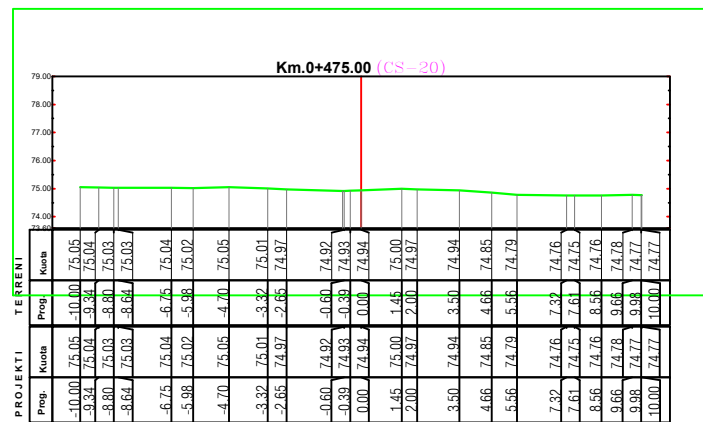
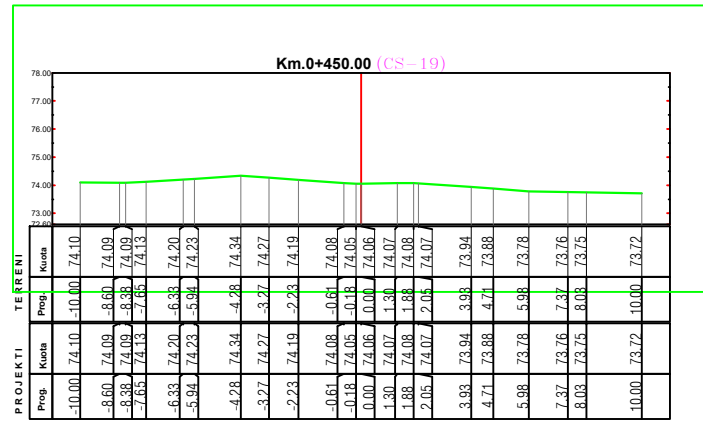



REPUBLIKA E SHQIPËRISË

BASHKIA KRUJË

EMERTIMI
 PROJEKT PREVENTIV ZBATIMI
 SISTEMIM-ASFALTIM I RRUGËS SË VARREZAVE NIKËL
 NJESIA ADMINISTRATIVE NIKËL
 BASHKIA KRUJE

EMERTIMI I FLETËS

PROFILIET TERTHORE

PROJEKTUESI

" HMK CONSULTING " shpk

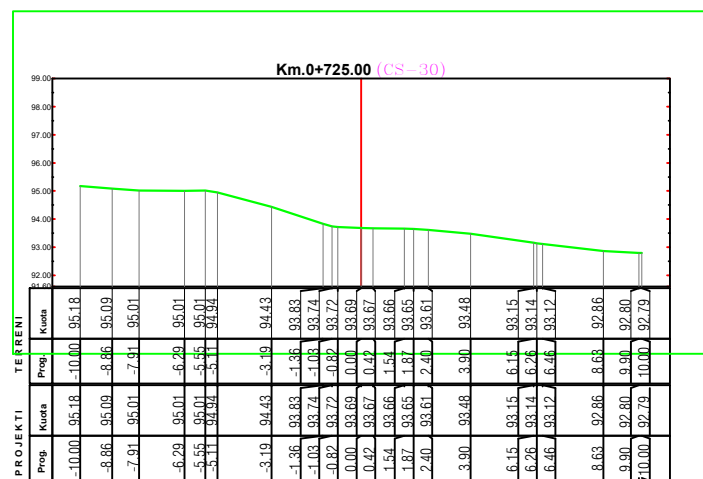
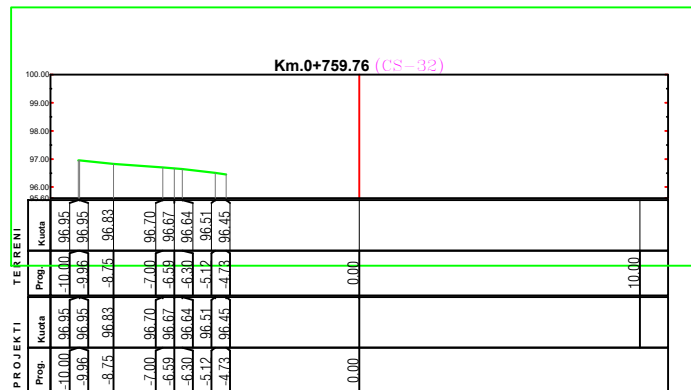
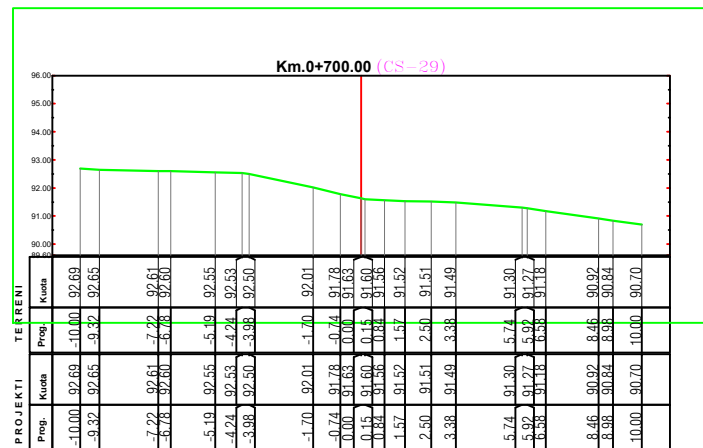
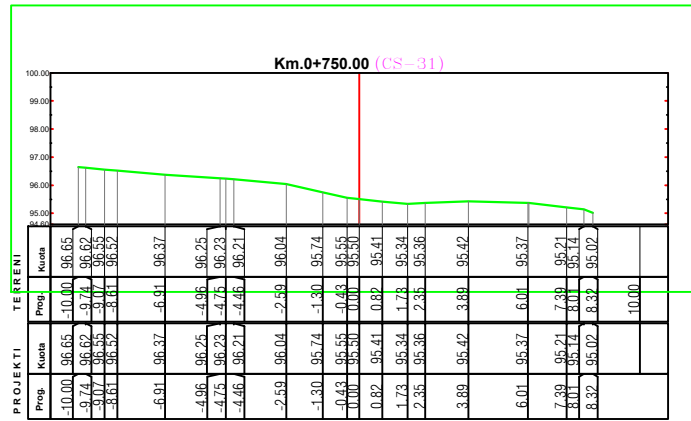
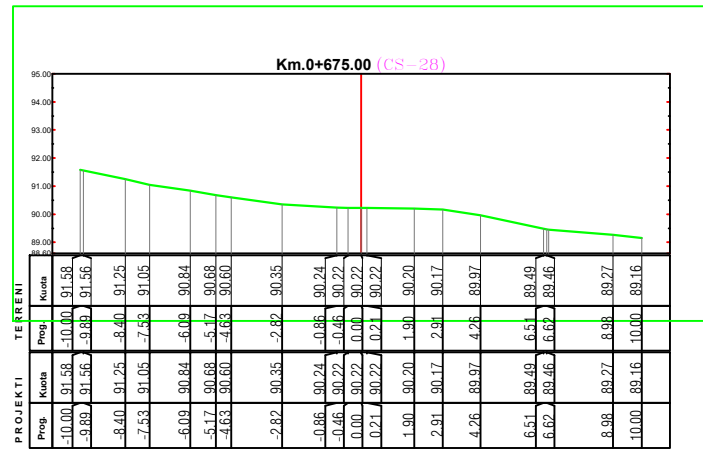

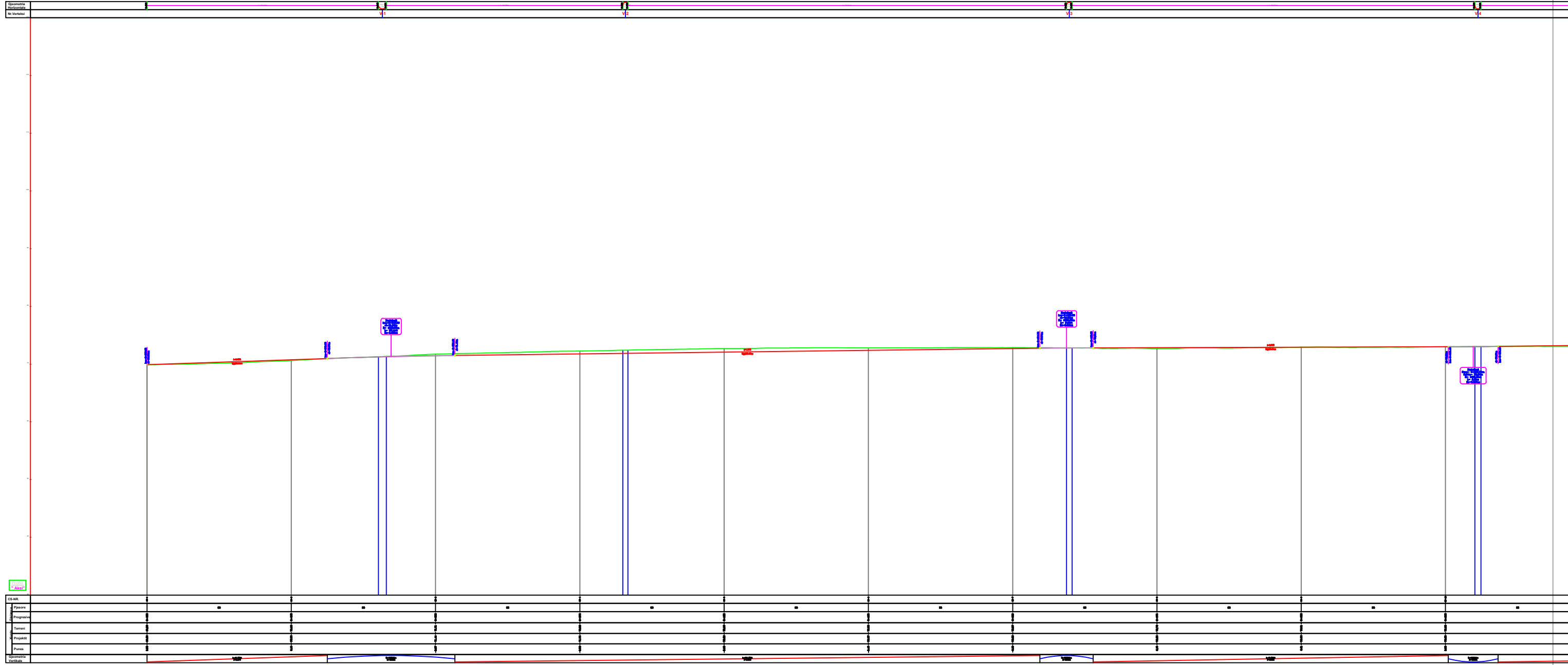

REPUBLIKA E SHQIPËRISË
BASHKIA KRUJË

EMERTIMI
PROJEKT PREVENTIV ZBATIMI
SISTEMIM-ASFALTIM I RRUGËS SË VARREZAVE NIKËL
NJESIA ADMINISTRATIVE NIKËL
BASHKIA KRUJE

EMERTIMI I FLETËS
PROFILI GJATESOR

PROJEKTUESI
" HMK CONSULTING " shpk

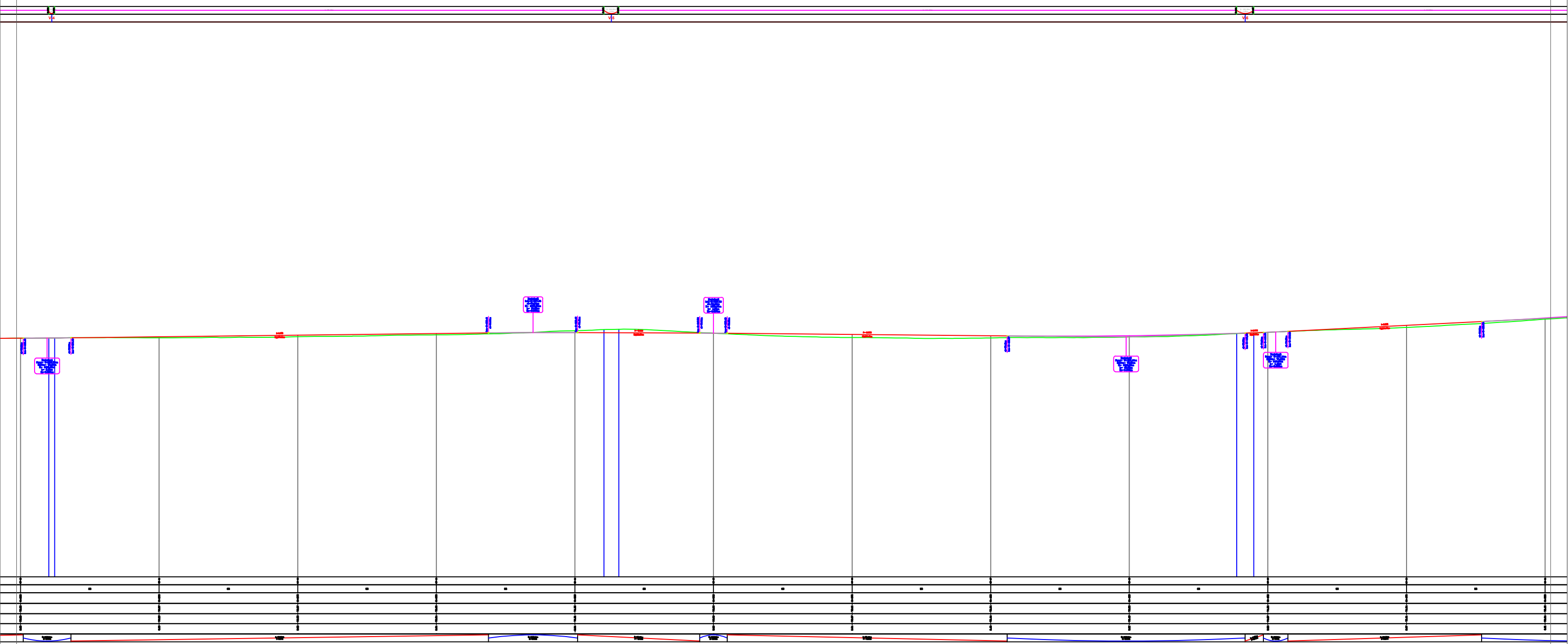

REPUBLIKA E SHQIPËRISË
BASHKIA KRUJË

EMERTIMI
PROJEKT PREVENTIV ZBATIMI
SISTEMIM-ASFALTIM I RRUGËS SË VARREZAVE NIKËL
NJESIA ADMINISTRATIVE NIKËL
BASHKIA KRUJE

EMERTIMI I FLETËS
PROFILI GJATESOR

PROJEKTUESI
" HMK CONSULTING " shpk

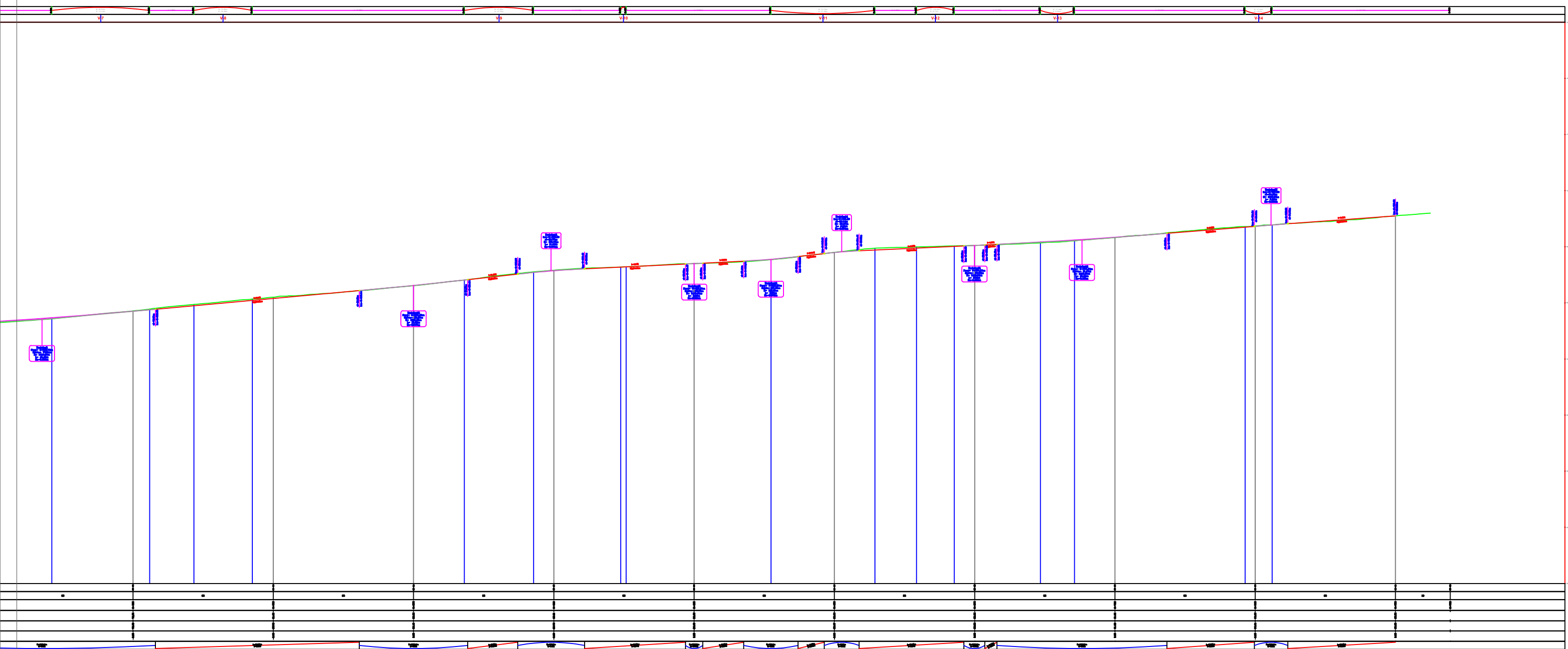

REPUBLIKA E SHQIPËRISË

BASHKIA KRUJË

EMERTIMI
 PROJEKT PREVENTIV ZBATIMI
 SISTEMIM-ASFALTIM I RRUGËS SË VARREZAVE NIKËL
 NJESIA ADMINISTRATIVE NIKËL
 BASHKIA KRUJE

EMERTIMI I FLETËS
 PROFILI GJATESOR

PROJEKTUESI
 " HMK CONSULTING " shpk

PROFILI TERTHORE TIP 1 (PK.0 - PROGRESIVI 535m)

SHENIME SHTRESAT

1. MBUSHJE ME CAKELL Tmes=25cm (SEKTORI TOKE KAT.IV)
2. MBUSHJE ME CAKELL Tmes=20cm (SEKTORI TOKE SHTUF)
3. STABILIZANTI T=10cm
4. BINDERI T=5cm
5. ASFALTOBETONET T=4cm
6. BANKINAT T=10cm

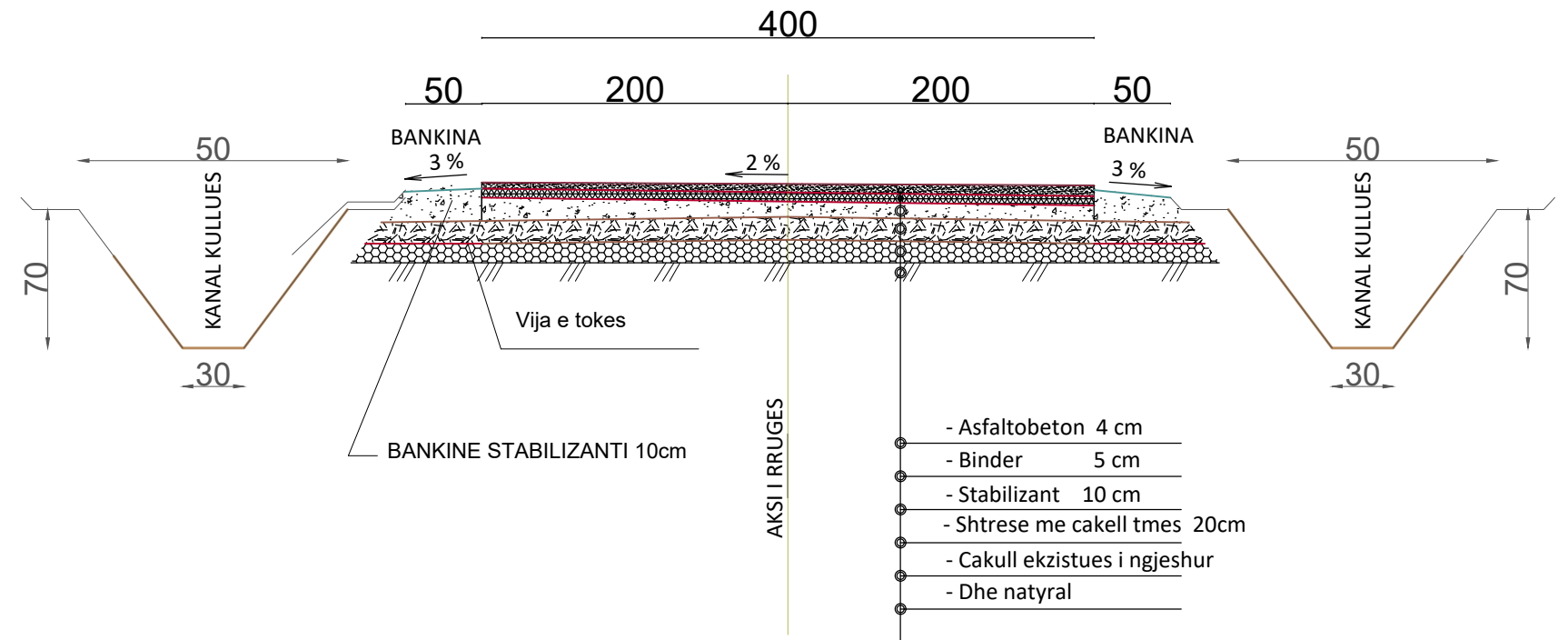

PROFILI TERTHORE TIP 2 (PROGRESIVI 535m - FUND)

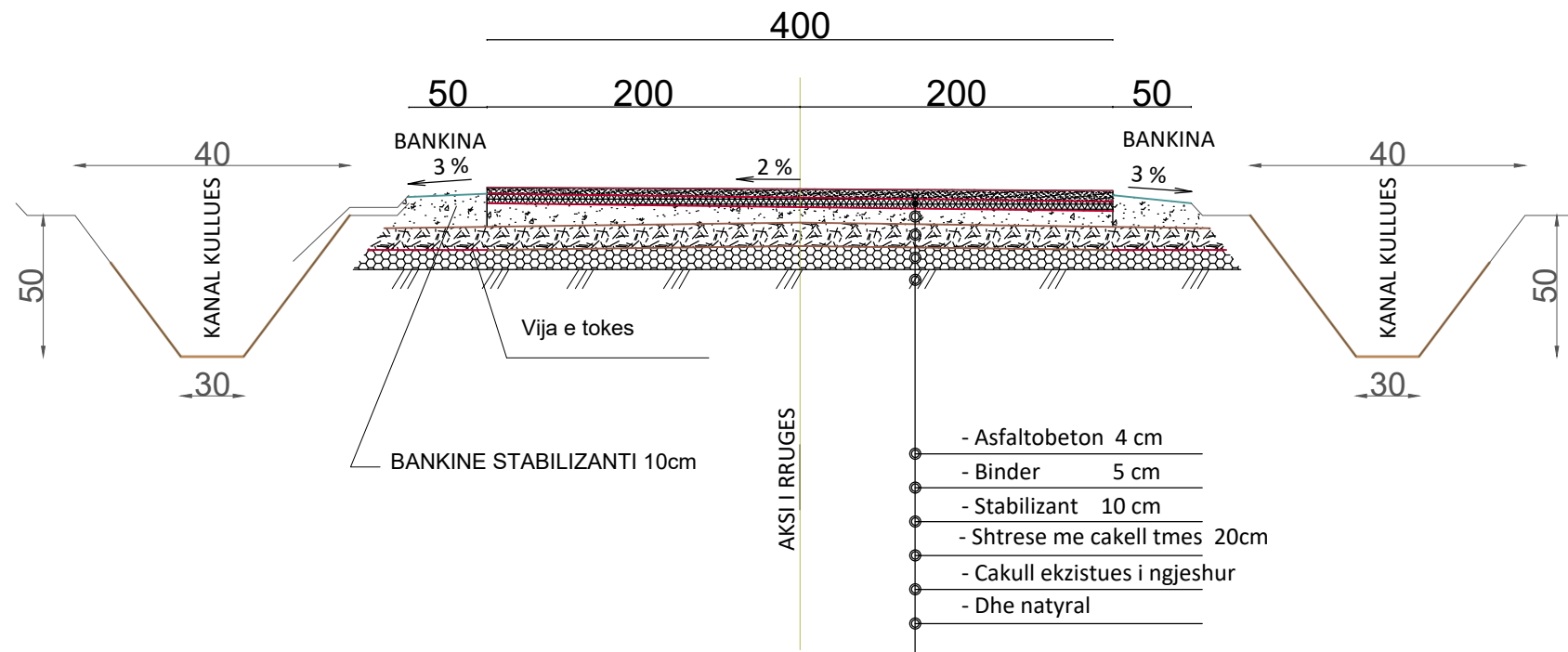

SHENIME SHTRESAT

1. MBUSHJE ME CAKELL Tmes=25cm (SEKTORI TOKE KAT.IV)
2. MBUSHJE ME CAKELL Tmes=20cm (SEKTORI TOKE SHTUF)
3. STABILIZANTI T=10cm
4. BINDERI T=5cm
5. ASFALTOBETONET T=4cm
6. BANKINAT T=10cm



REPUBLIKA E SHQIPËRISË

BASHKIA KRUIJË

EMERTIMI

PROJEKT PREVENTIV ZBATIMI
SISTEMIM-ASFALTIM I RRUGËS SË VARREZAVE NIKËL
NJESIA ADMINISTRATIVE NIKËL
BASHKIA KRUIJË

EMERTIMI I FLETËS

PROFILI TERTHORE
HOLLESI NDERTIMORE

PROJEKTUESI

" HMK CONSULTING " shpk

HOLLESI NDERTIMORE TE TOMBINOS EKZISTUESE Ø1000mm, L=6m

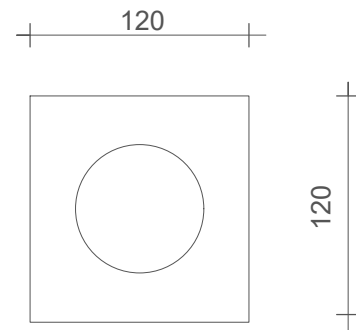
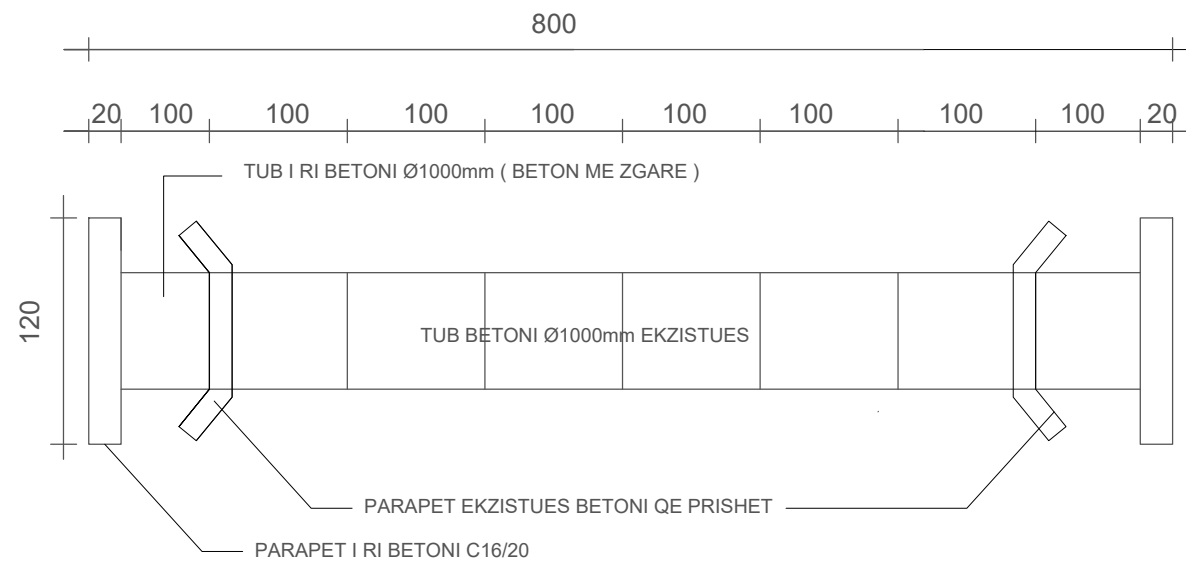

KANALETE BETONI ME ZGARE DHE DHEMB BETONI

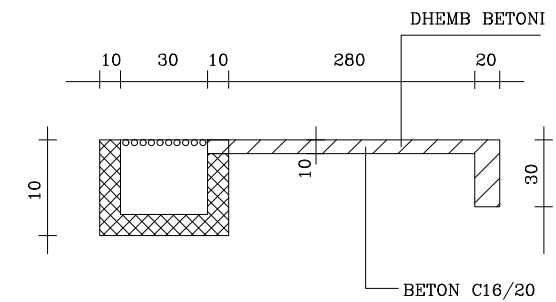

HOLLESI NDERTIMORE TE TOMBINOS Ø500mm, L=8m/L=14m

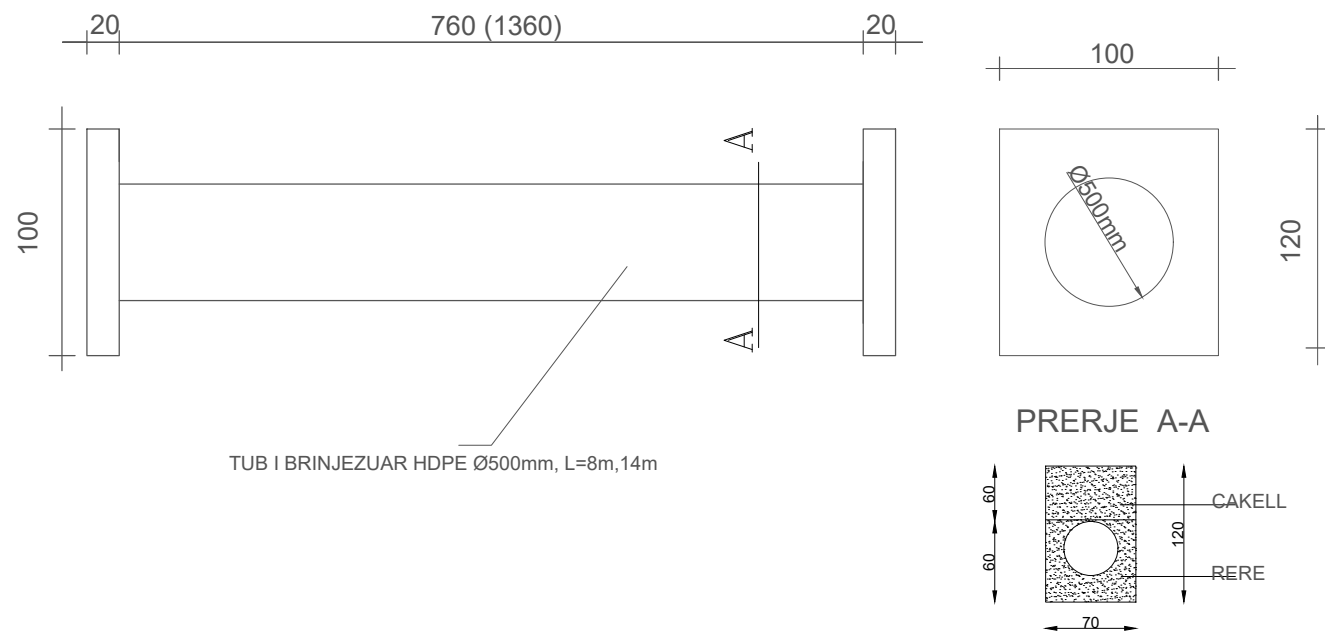

HOLLESI NDERTIMORE TE TOMBINOS Ø315mm/Ø=400mm, L=6m/L=5m

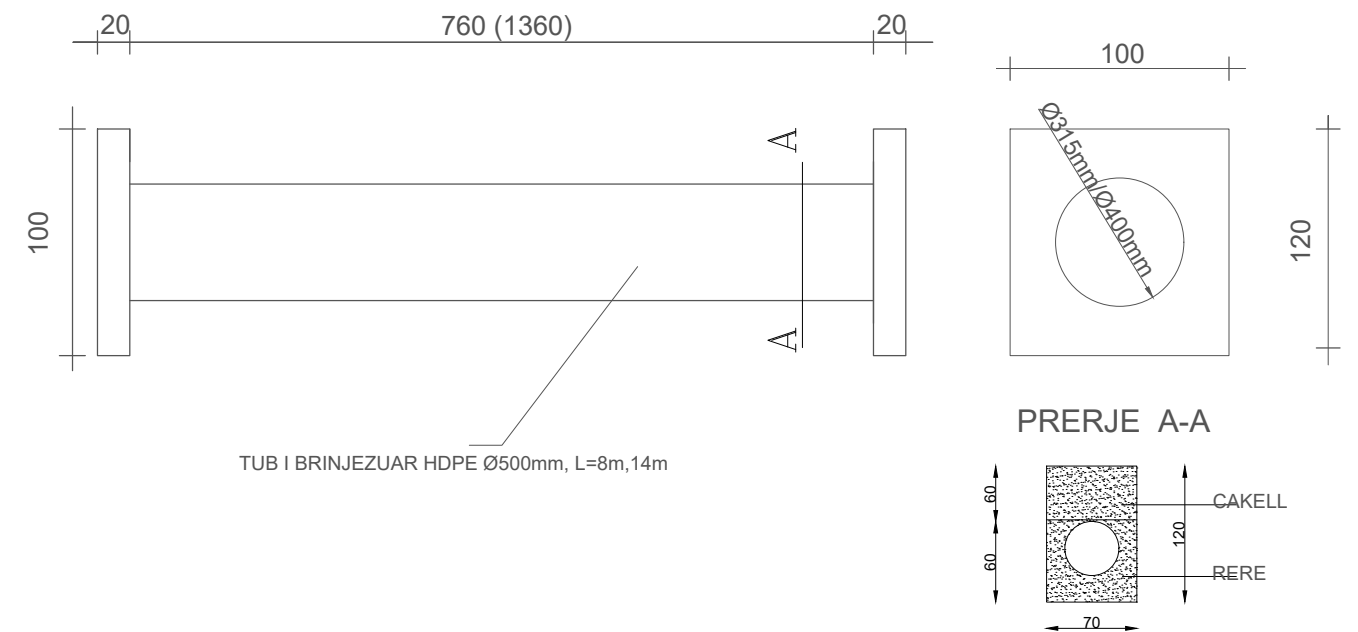

REPUBLIKA E SHQIPËRISË
BASHKIA KRUJË

EMERTIMI
PROJEKT PREVENTIV ZBATIMI
SISTEMIM-ASFALTIM I RRUGËS SË VARREZAVE NIKËL
NJESIA ADMINISTRATIVE NIKËL
BASHKIA KRUJË

EMERTIMI I FLETËS
PROFLET TERTHORE
HOLLESI NDERTIMORE

PROJEKTUESI
" HMK CONSULTING " shpk