

PRERJA A-A
SH: 1:100

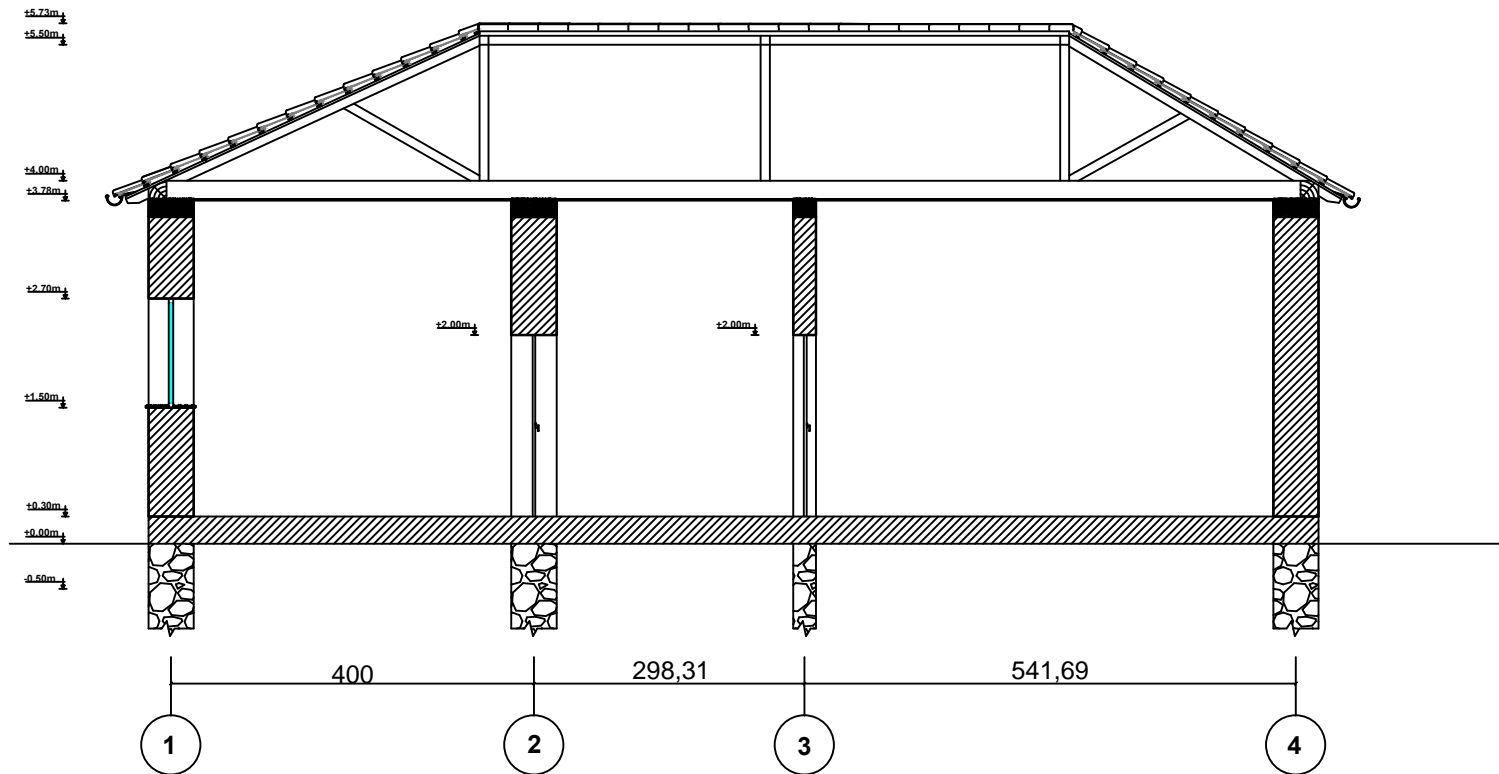

REPUBLIKA E SHQIPERISE
BASHKIA PUSTEC
SEKTORI I URBANISTIKES

MIRATOI
KRYETARI I BASHKISE
PALI KOLEFSKI

AUTORET E PROJEKTIT

ARKITEKT: PAOLO ROPI
TOPOGRAF: VASKA ARGJIRI

Objekti: _____RIKONSTRUKSON_____

Emertimi: _____

Data: ___/___/2023

PLANIMETRI E OBJEKTIT SH: 1:100

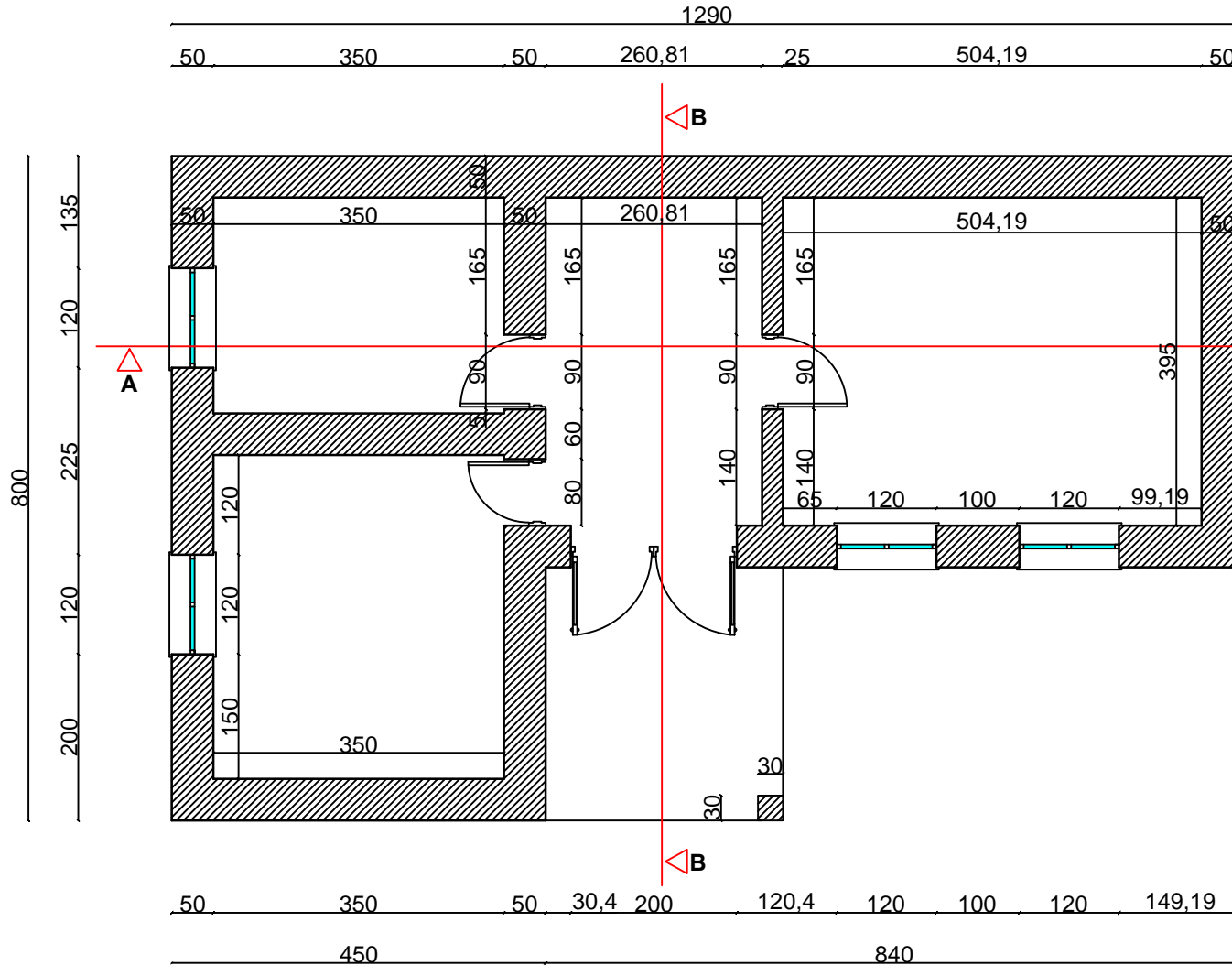

OBJEKTI: RIKONSTRUKSION SHTEPI BANIMI
TE FAMILJEVE NE NEVOJE
FAMILJA: Kërste Genci Vurmo

TE DHENATE E PRONESISE

NR.PASURIE - 89/5
ZONA KADASTRALE - 2045
VOLUMI - 6
FAQE - 38
SIPERFAQE - 80M²



REPUBLIKA E SHQIPERISE
BASHKIA PUSTEC
SEKTORI I URBANISTIKES

MIRATOI
KRYETARI I BASHKISE
PALI KOLEFSKI

AUTORET E PROJEKTIT

ARKITEKT: PAOLO ROPI
TOPOGRAF: VASKA ARGJIRI

Objekti: _____RIKONSTRUKSON_____

Emertimi: _____

Data: ___/___/2023

PLANI I KULLIMIT TE UJARAVE
SH: 1:100

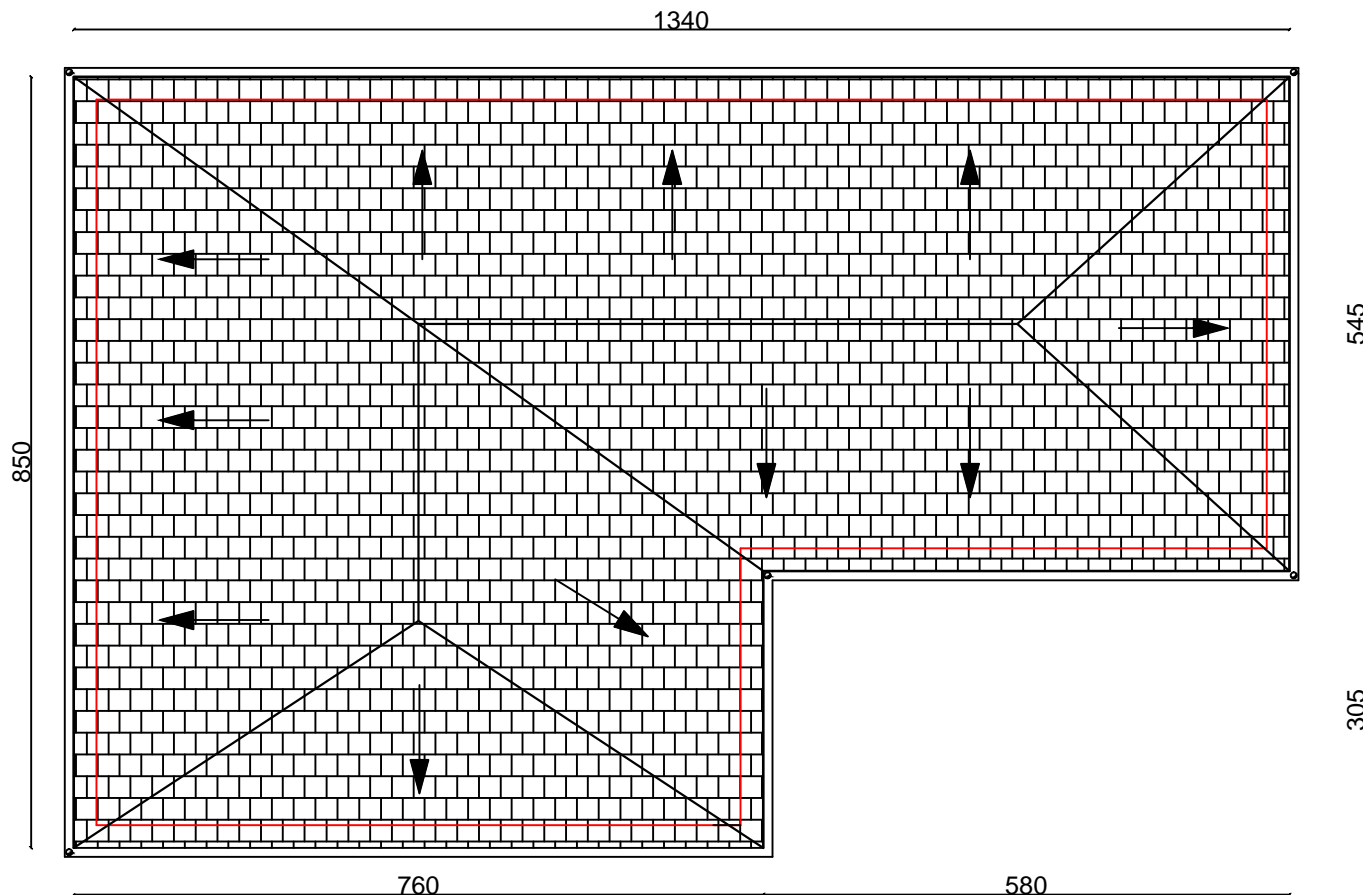

REPUBLIKA E SHQIPERISE
BASHKIA PUSTEC
SEKTORI I URBANISTIKES

MIRATOI
KRYETARI I BASHKISE
PALI KOLEFSKI

AUTORET E PROJEKTIT

ARKITEKT: PAOLO ROPI
TOPOGRAF: VASKA ARGJIRI

Objekti: _____RIKONSTRUKSON_____

Emertimi: _____

Data: ___/___/2023

PRERJA B-B
SH: 1:100

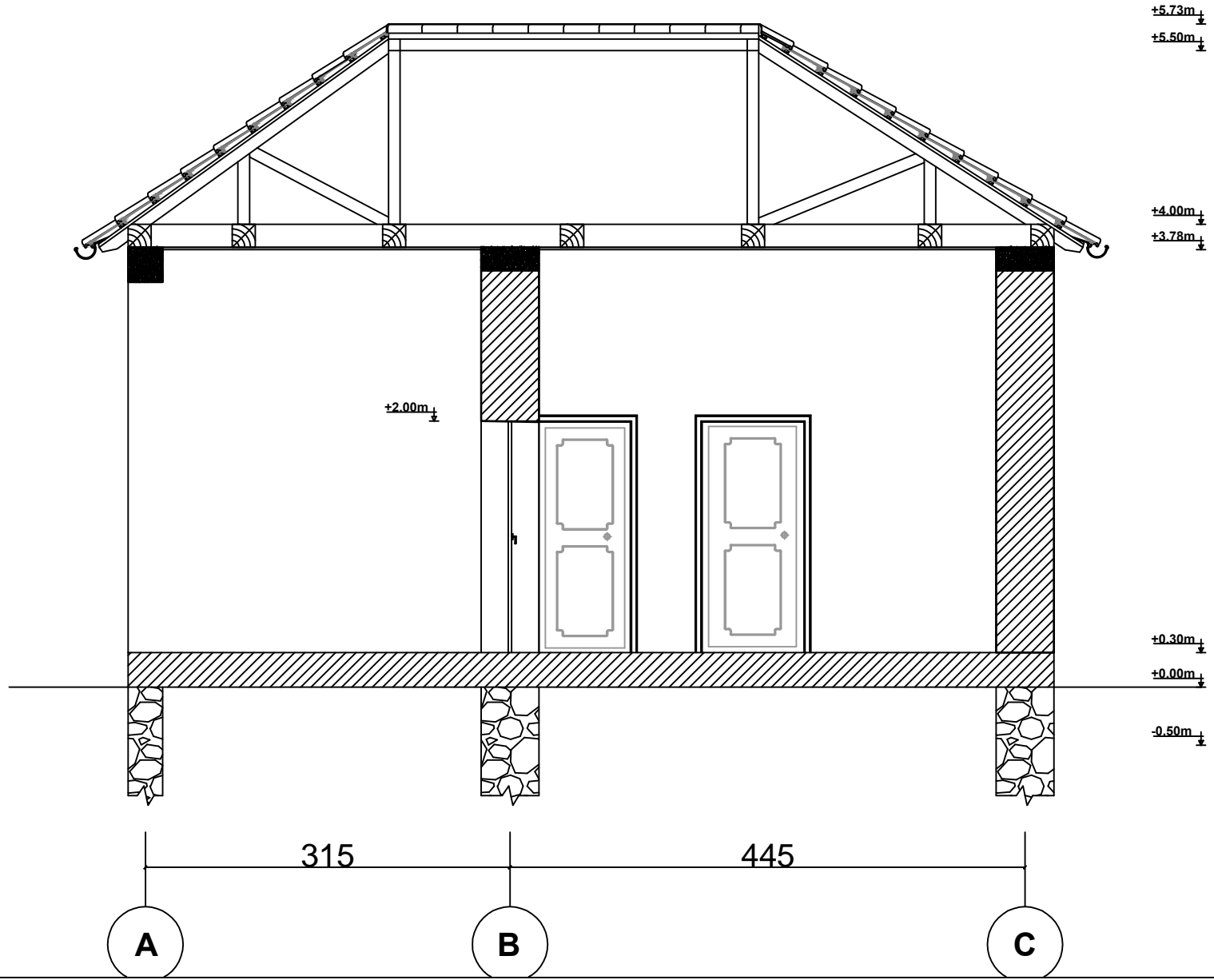

REPUBLIKA E SHQIPERISE
BASHKIA PUSTEC
SEKTTORI I URBANISTIKES

MIRATOI
KRYETARI I BASHKISE
PALI KOLEFSKI

AUTORET E PROJEKTIT

ARKITEKT: PAOLO ROPI
TOPOGRAF: VASKA ARGJIRI

Objekti: _____RIKONSTRUKSON_____

Emertimi: _____

Data: ___/___/2023

DETAJI I CATISE

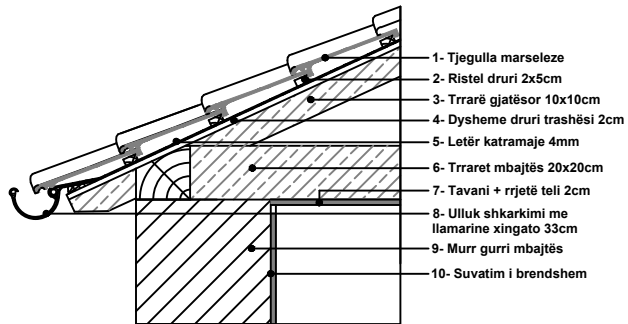

DETAJI I DRITARES

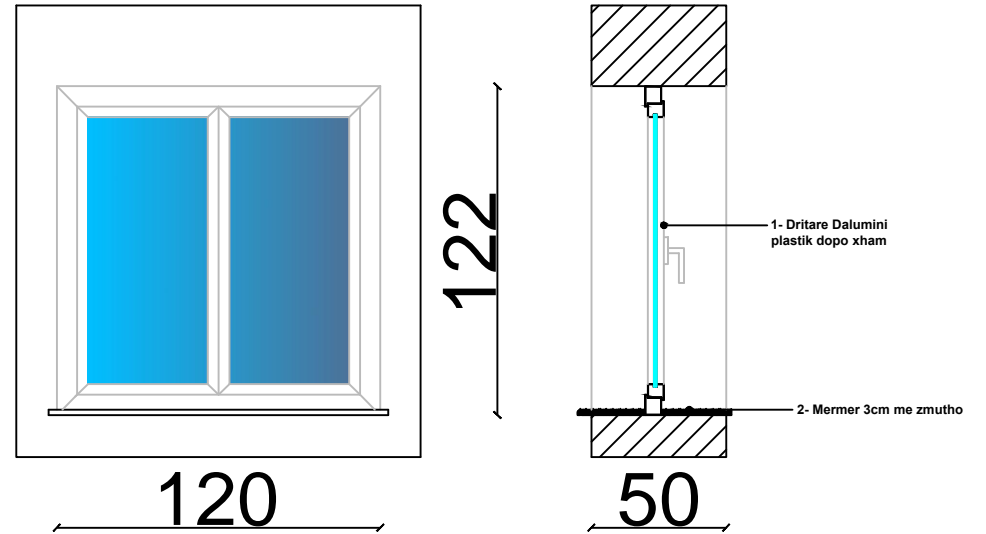

REPUBLIKA E SHQIPERISE
BASHKIA PUSTEC
 SEKTTORI I URBANISTIKES

MIRATOI
 KRYETARI I BASHKISE
 PALI KOLEFSKI

AUTORET E PROJEKTIT

ARKITEKT: PAOLO ROPI
 TOPOGRAF: VASKA ARGJIRI

Objekti: _____RIKONSTRUKSON_____

Emertimi: _____

Data: ___/___/2023

PLANI I KONSTRUKTIV I CATISE

SH: 1:100

1340

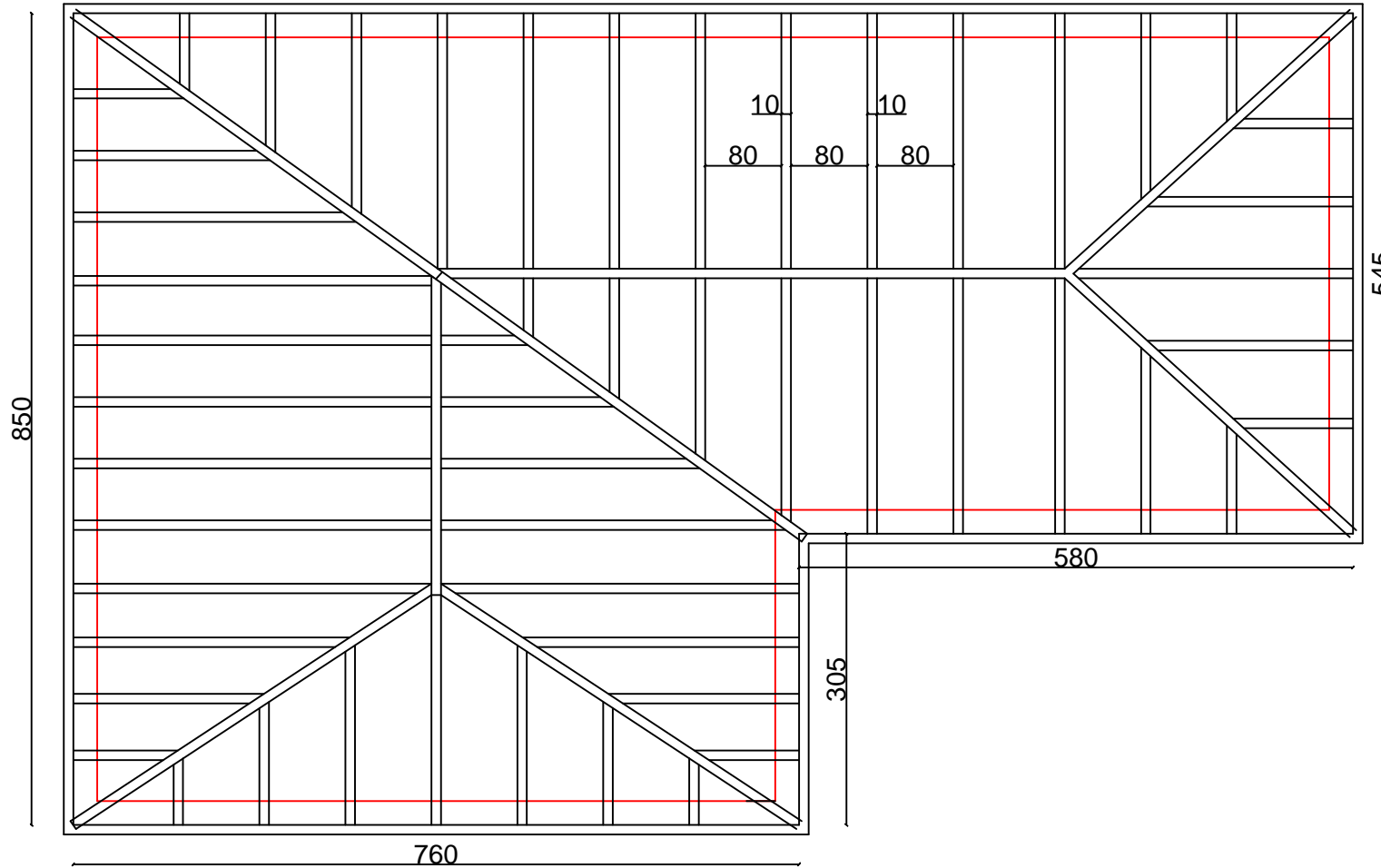

SHPJEGIM TEKNIK

NDERTIMI I CATISE DO REALIZOHET ME
LENDE DRRURI TE SHARRUARTE CILAT
DO TE MBESHTETEN MBI TRARET E
TAVANIT 20X20 CM TE CILAT DO JENE
SHARUAR DHE STAZHONUAR SIMBAS K.T.Z
RISTELAT KU DO MBESHTETEN
TJEGULLAT DO JENE ME PERMASA 5X4CM DHE
DO VENDOSEN CDO 30-35CM SIMBAS
LLOJIT TE TJEGULLES
PERMASAT E MAHIVE DO JENE ME PERMASA
10X8CM DISTANCA E TE CILAVE
DO JENE CDO 80CM
TJEGULLA TE PLANIFIKUARA IMPORTI
TRARET HORIZONTALE DHE KULMORE
JANE TE PERMASAVE 10X10CM
NE DREJTIM GJATESOR DO VENDOSEN
KONDRARENTIME ME PERMASA 10X8
ULLUKET DO JENE LLAMARINE XINGATO



REPUBLIKA E SHQIPERISE
BASHKIA PUSTEC
SEKTTORI I URBANISTIKES

MIRATOI
KRYETARI I BASHKISE
PALI KOLEFSKI

AUTORET E PROJEKTIT

ARKITEKT: PAOLO ROPI
TOPOGRAF: VASKA ARGJIRI

Objekti: _____RIKONSTRUKSON_____

Emertimi: _____

Data: ___/___/2023

PLANIMETRI E OBJEKTIT SH: 1:100

OBJEKTI: RIKONSTRUKSION SHTEPI BAN
FAMILJA: Vangjel Lefter Kitani

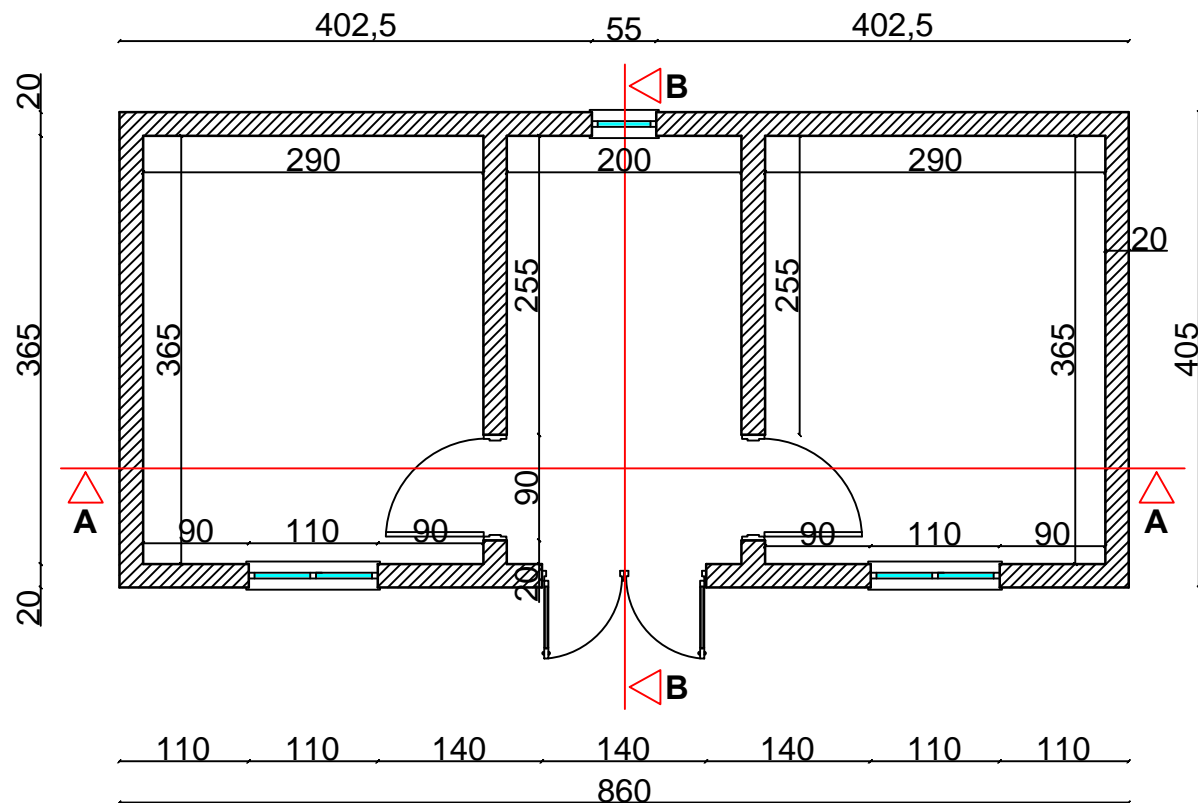

TE DHENATE E PRONESISE

NR.PASURIE - 206/6
ZONA KADASTRALE - 1809
VOLUMI - 6
FAQE - 24
SIPERFAQE - 70M²



REPUBLIKA E SHQIPERISE
BASHKIA PUSTEC
 SEKTTORI I URBANISTIKES

MIRATOI
KRYETARI I BASHKISE
PALI KOLEFSKI

AUTORET E PROJEKTIT

ARKITEKT: PAOLO ROPI
TOPOGRAF: VASKA ARGJIRI

Objekti: _____RIKONSTRUKSON_____

Emertimi: _____

Data: ___/___/2023

PRERJA A-A
SH: 1:100

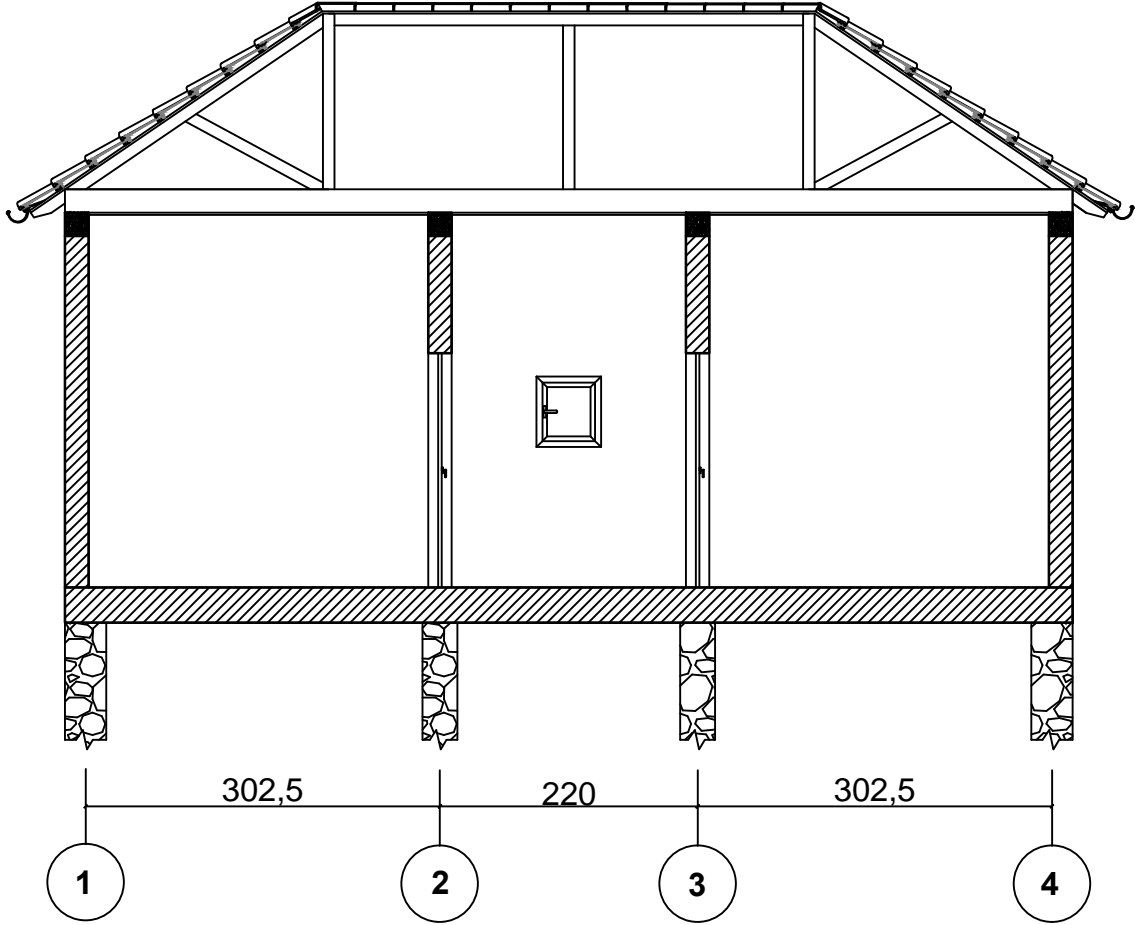

REPUBLIKA E SHQIPERISE
BASHKIA PUSTEC
SEKTORI I URBANISTIKES

MIRATOI
KRYETARI I BASHKISE
PALI KOLEFSKI

AUTORET E PROJEKTIT

ARKITEKT: PAOLO ROPI
TOPOGRAF: VASKA ARGJIRI

Objekti: _____RIKONSTRUKSON_____

Emertimi: _____

Data: __/__/2023

PRERJA B-B
SH: 1:100

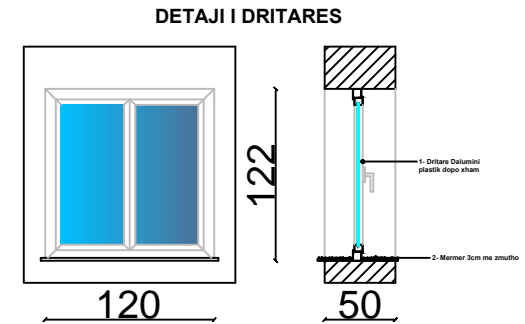
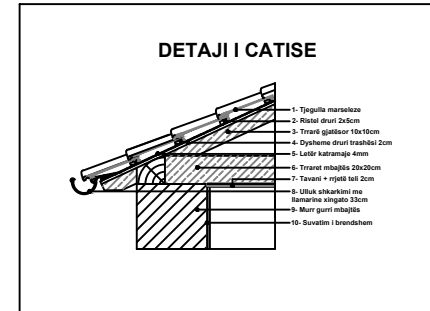
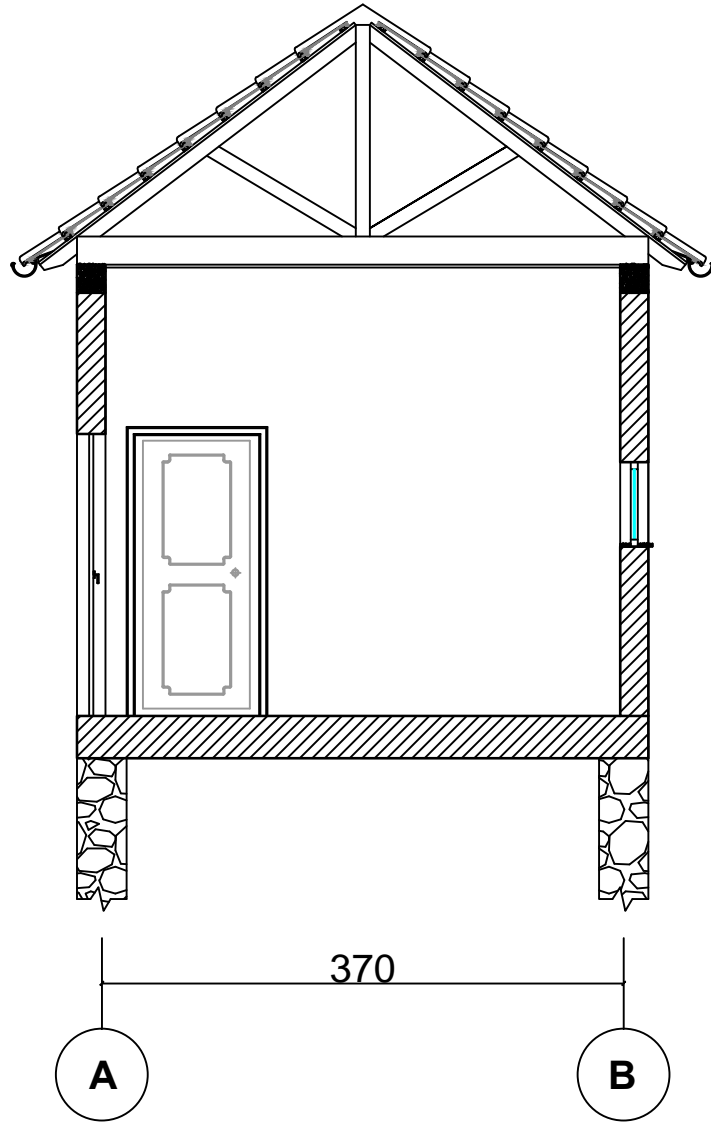

REPUBLIKA E SHQIPERISE
BASHKIA PUSTEC
SEKTTORI I URBANISTIKES

MIRATOI
KRYETARI I BASHKISE
PALI KOLEFSKI

AUTORET E PROJEKTIT

ARKITEKT: PAOLO ROPI
TOPOGRAF: VASKA ARGJIRI

Objekti: _____RIKONSTRUKSON_____

Emertimi: _____

Data: ___/___/2023

PLANI I KULLIMIT TE UJJRAVE

SH: 1:100

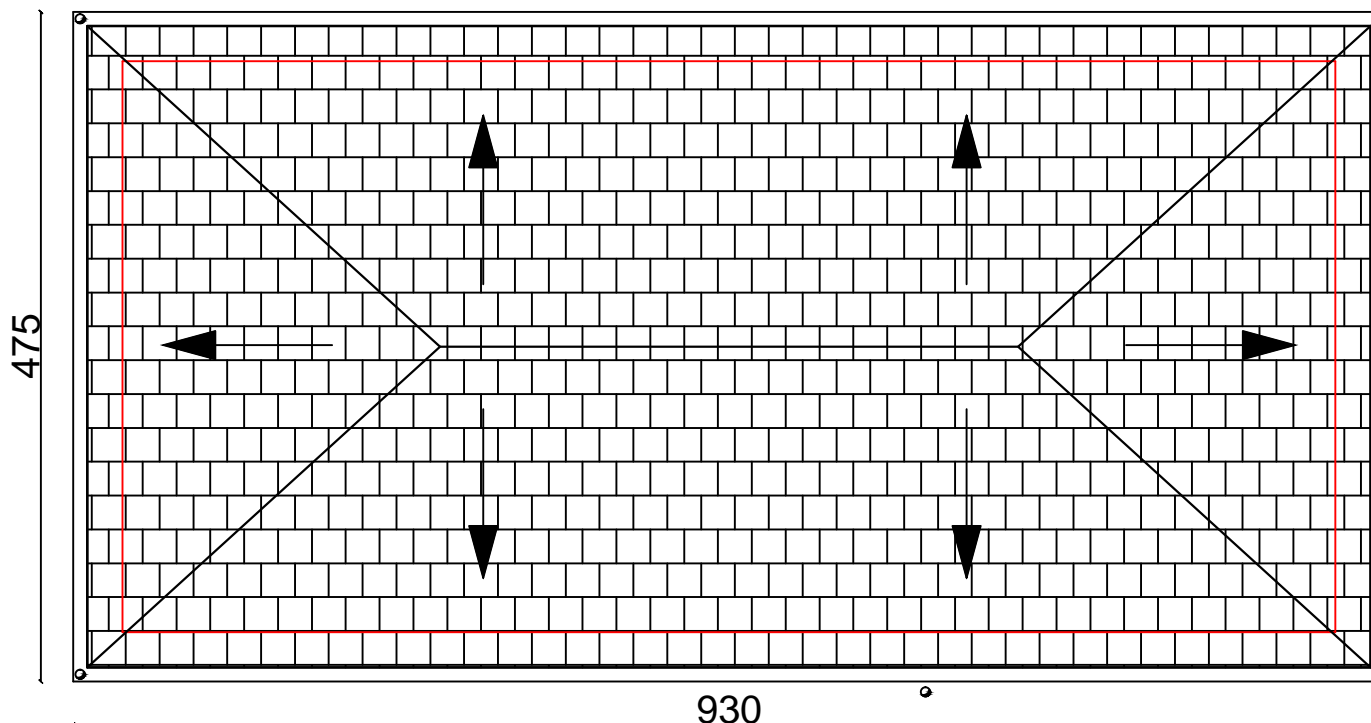

SHPJEGIM TEKNIK

NDERTIMI I CATISE DO REALIZOHET ME
LENDE DRRURI TE SHARRUARTE CILAT
DO TE MBESHTETEN MBI TRARET E
TAVANIT 20X20 CM TE CILAT DO JENE
SHARUAR DHE STAZHONUAR SIMBAS K.T.Z
RISTELAT KU DO MBESHTETEN
TJEGULLAT DO JENE ME PERMASA 5X4CM DHE
DO VENDOSEN CDO 30-35CM SIMBAS
LLOJIT TE TJEGULLES
PERMASAT E MAHIVE DO JENE ME PERMASA
10X8CM DISTANCA E TE CILAVE
DO JENE CDO 80CM
TJEGULLA TE PLANIFIKUARA IMPORTI
TRARET HORIZONTALE DHE KULMORE
JANE TE PERMASAVE 10X10CM
NE DREJTIM GJATESOR DO VENDOSEN
KONDRAVENTIME ME PERMASA 10X8
ULLUKET DO JENE LLAMARINE XINGATO



REPUBLIKA E SHQIPERISE
BASHKIA PUSTEC
SEKTTORI I URBANISTIKES

MIRATOI
KRYETARI I BASHKISE
PALI KOLEFSKI

AUORET E PROJEKTIT

ARKITEKT: PAOLO ROPI
TOPOGRAF: VASKA ARGJIRI

Objekti: _____RIKONSTRUKSON_____

Emertimi: _____

Data: ___/___/2023

PLANI I KONSTRUKTIV I CATISE

SH: 1:100

910

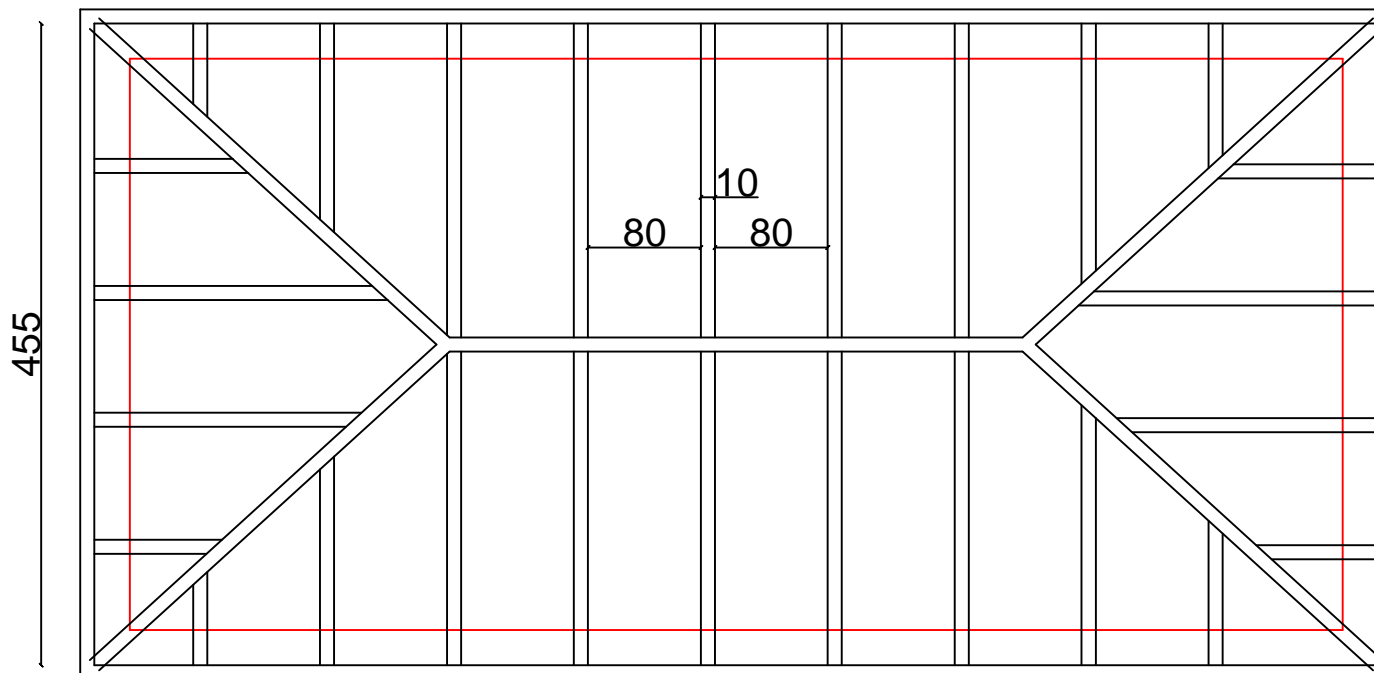

SHPJEGIM TEKNIK

NDERTIMI I CATISE DO REALIZOHET ME
LENDE DRRURI TE SHARRUARTE CILAT
DO TE MBESHTETEN MBI TRARET E
TAVANIT 20X20 CM TE CILAT DO JENE
SHARUAR DHE STAZHONUAR SIMBAS K.T.Z
RISTELAT KU DO MBESHTETEN
TJEGULLAT DO JENE ME PERMASA 5X4CM DHE
DO VENDOSEN CDO 30-35CM SIMBAS
LLOJIT TE TJEGULLES
PERMASAT E MAHIVE DO JENE ME PERMASA
10X8CM DISTANCA E TE CILAVE
DO JENE CDO 80CM
TJEGULLA TE PLANIFIKUARA IMPORTI
TRARET HORIZONTALE DHE KULMORE
JANE TE PERMASAVE 10X10CM
NE DREJTIM GJATESOR DO VENDOSEN
KONDRARENTIME ME PERMASA 10X8
ULLUKET DO JENE LLAMARINE XINGATO



REPUBLIKA E SHQIPERISE

BASHKIA PUSTEC

SEKTTORI I URBANISTIKES

MIRATOI
KRYETARI I BASHKISE
PALI KOLEFSKI

AUORET E PROJEKTIT

ARKITEKT: PAOLO ROPI
TOPOGRAF: VASKA ARGJIRI

Objekti: _____RIKONSTRUKSON_____

Emertimi: _____

Data: ___/___/2023

PLANIMETRI E OBJEKTIT SH: 1:100

OBJEKTI: RIKONSTRUKSION SHTEPI BANIMI
 FAMILJA: Jani Nasto Done

TE DHENATE E PRONESISE

NR.PASURIE - 94/1
 ZONA KADASTRALE - 1488
 VOLUMI - 3
 FAQE - 108
 SIPERFAQE - 75M²

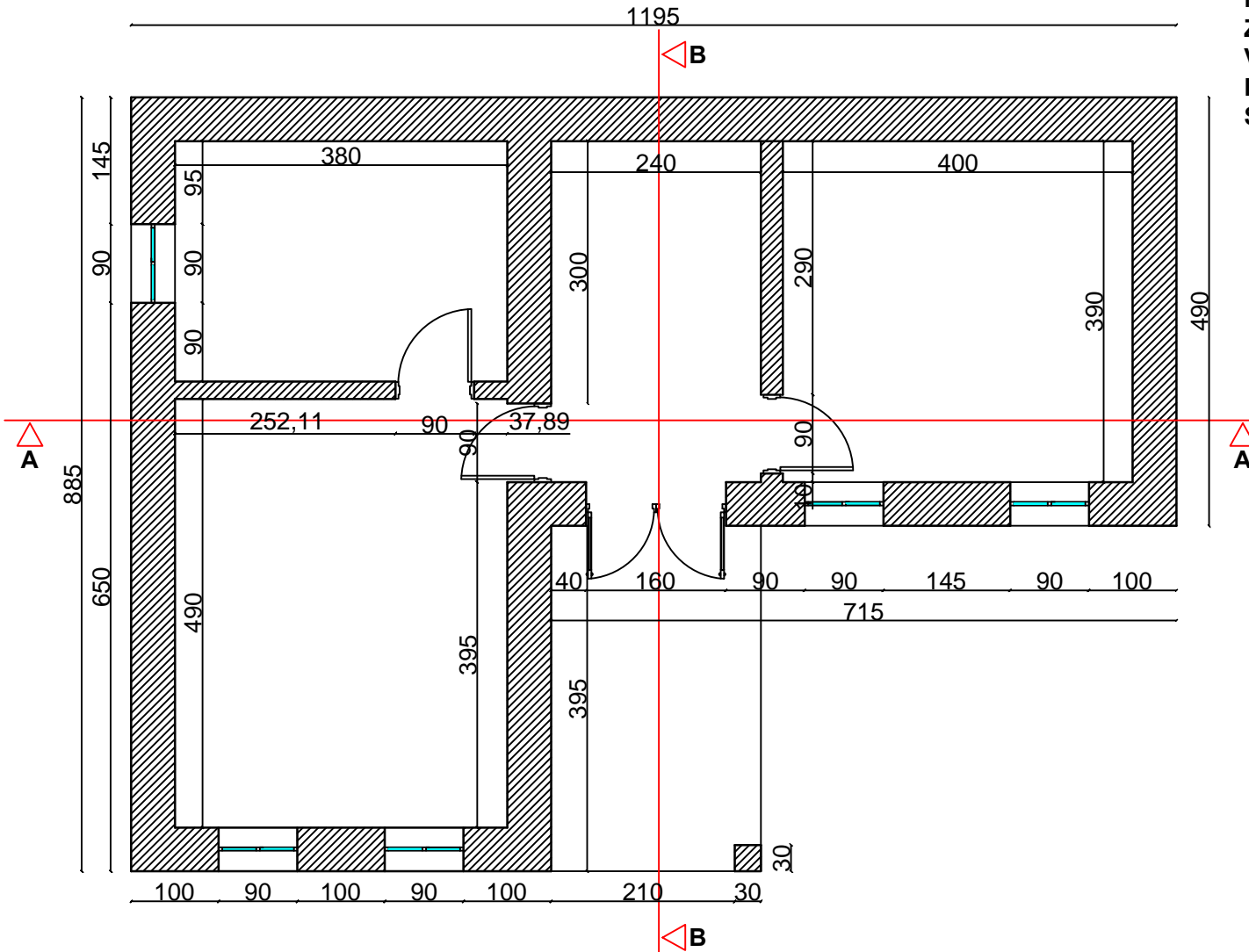

REPUBLIKA E SHQIPERISE
 BASHKIA PUSTEC
 SEKTTORI I URBANISTIKES

MIRATOI
 KRYETARI I BASHKISE
 PALI KOLEFSKI

AUTORET E PROJEKTIT

ARKITEKT: PAOLO ROPI
 TOPOGRAF: VASKA ARGJIRI

Objekti: _____RIKONSTRUKSON_____

Emertimi: _____

Data: ___/___/2023

PRERJA A-A
SH: 1:100

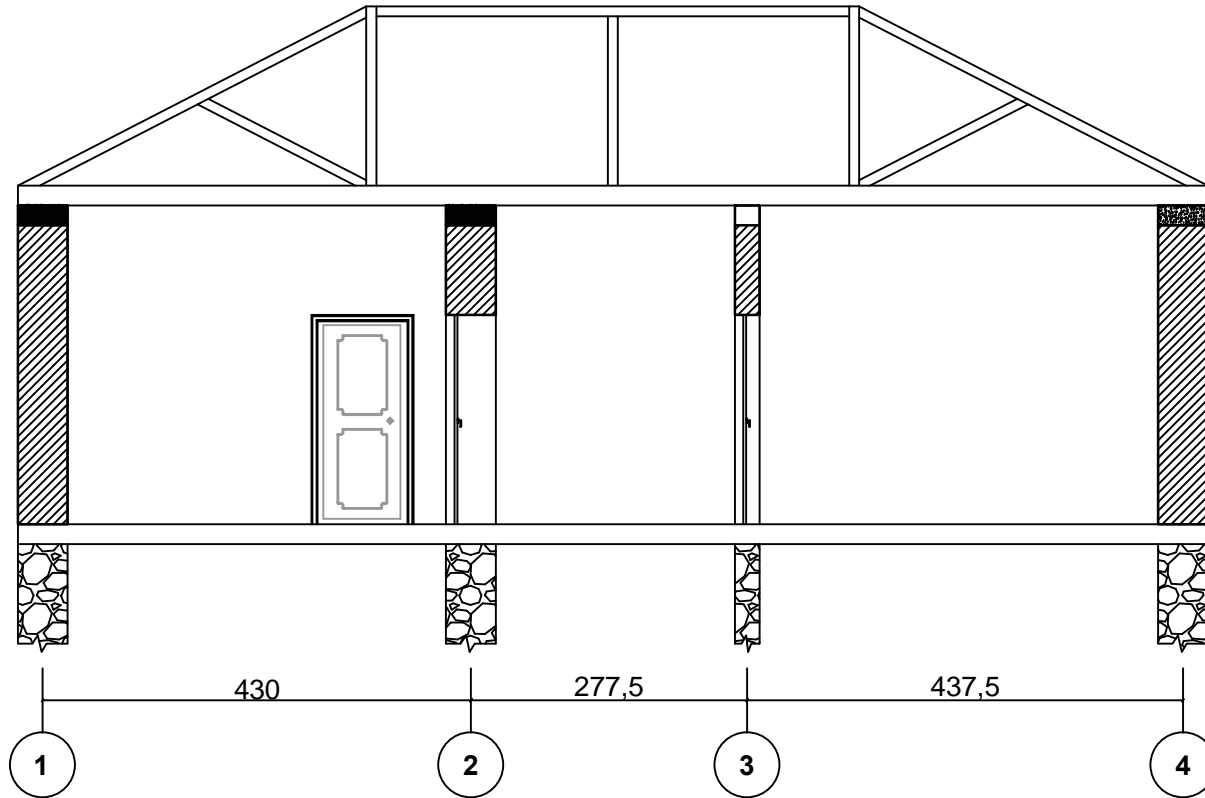

REPUBLIKA E SHQIPERISE
BASHKIA PUSTEC
SEKTORI I URBANISTIKES

MIRATOI
KRYETARI I BASHKISE
PALI KOLEFSKI

AUTORET E PROJEKTIT

ARKITEKT: PAOLO ROPI
TOPOGRAF: VASKA ARGJIRI

Objekti: _____RIKONSTRUKSON_____

Emertimi: _____

Data: ___/___/2023

PLANI I KULLIMIT TE UJJRAVE

SH: 1:100
1265

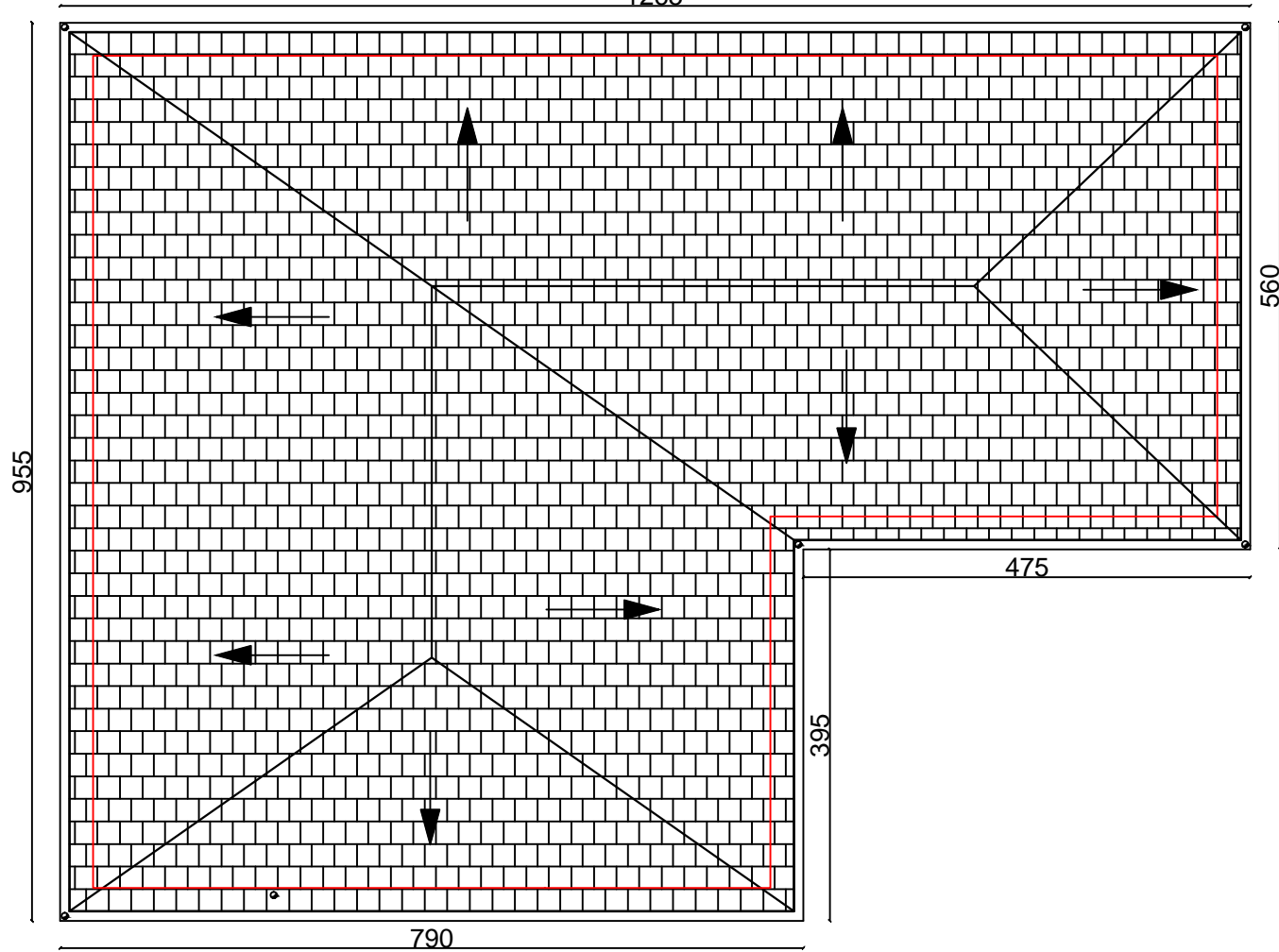

REPUBLIKA E SHQIPERISE
BASHKIA PUSTEC
SEKTORI I URBANISTIKES

MIRATOI
KRYETARI I BASHKISE
PALI KOLEFSKI

AUTORET E PROJEKTIT

ARKITEKT: PAOLO ROPI
TOPOGRAF: VASKA ARGJIRI

Objekti: _____RIKONSTRUKSON_____

Emertimi: _____

Data: ___/___/2023

PLANI I KONSTRUKTIV I CATISE
SH: 1:100

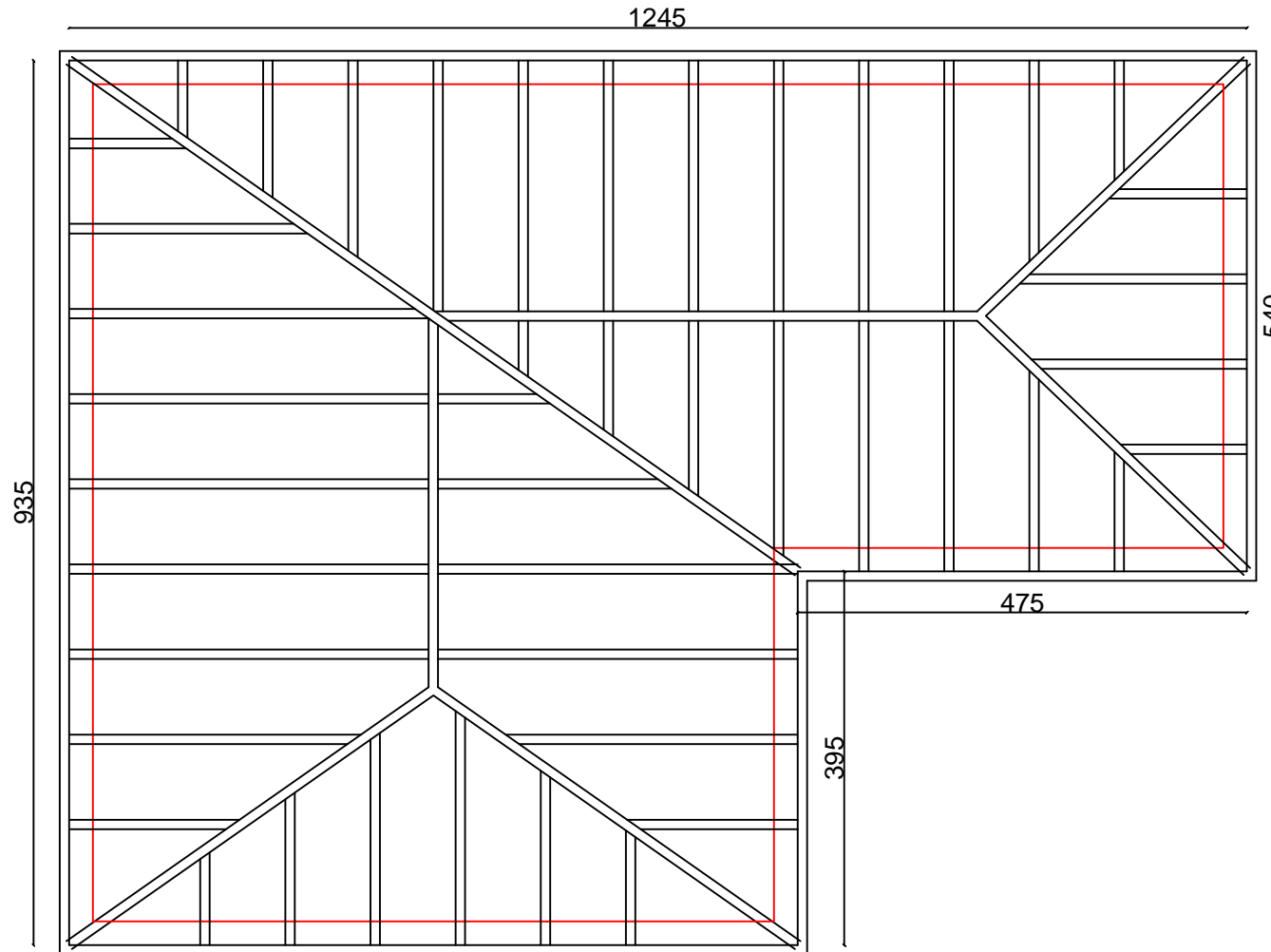

SHPJEGIM TEKNIK

NDERTIMI I CATISE DO REALIZOHET ME
LENDE DRRURI TE SHARRUARTE CILAT
DO TE MBESHTETEN MBI TRARET E
TAVANIT 20X20 CM TE CILAT DO JENE
SHARUAR DHE STAZHONUAR SIMBAS K.T.Z
RISTELAT KU DO MBESHTETEN
TJEGULLAT DO JENE ME PERMASA 5X4CM DHE
DO VENDOSEN CDO 30-35CM SIMBAS
LLOJIT TE TJEGULLES
PERMASAT E MAHIVE DO JENE ME PERMASA
10X8CM DISTANCA E TE CILAVE
DO JENE CDO 80CM
TJEGULLA TE PLANIFIKUARA IMPORTI
TRARET HORIZONTALE DHE KULMORE
JANE TE PERMASAVE 10X10CM
NE DREJTIM GJATESOR DO VENDOSEN
KONDRAVENTIME ME PERMASA 10X8
ULLUKET DO JENE LLAMARINE XINGATO



REPUBLIKA E SHQIPERISE
BASHKIA PUSTEC
SEKTTORI I URBANISTIKES

MIRATOI
KRYETARI I BASHKISE
PALI KOLEFSKI

AUOTRET E PROJEKTIT

ARKITEKT: PAOLO ROPI
TOPOGRAF: VASKA ARGJIRI

Objekti: RIKONSTRUKSON

Emertimi: _____

Data: ___/___/2023

PRERJA B-B
SH: 1:100

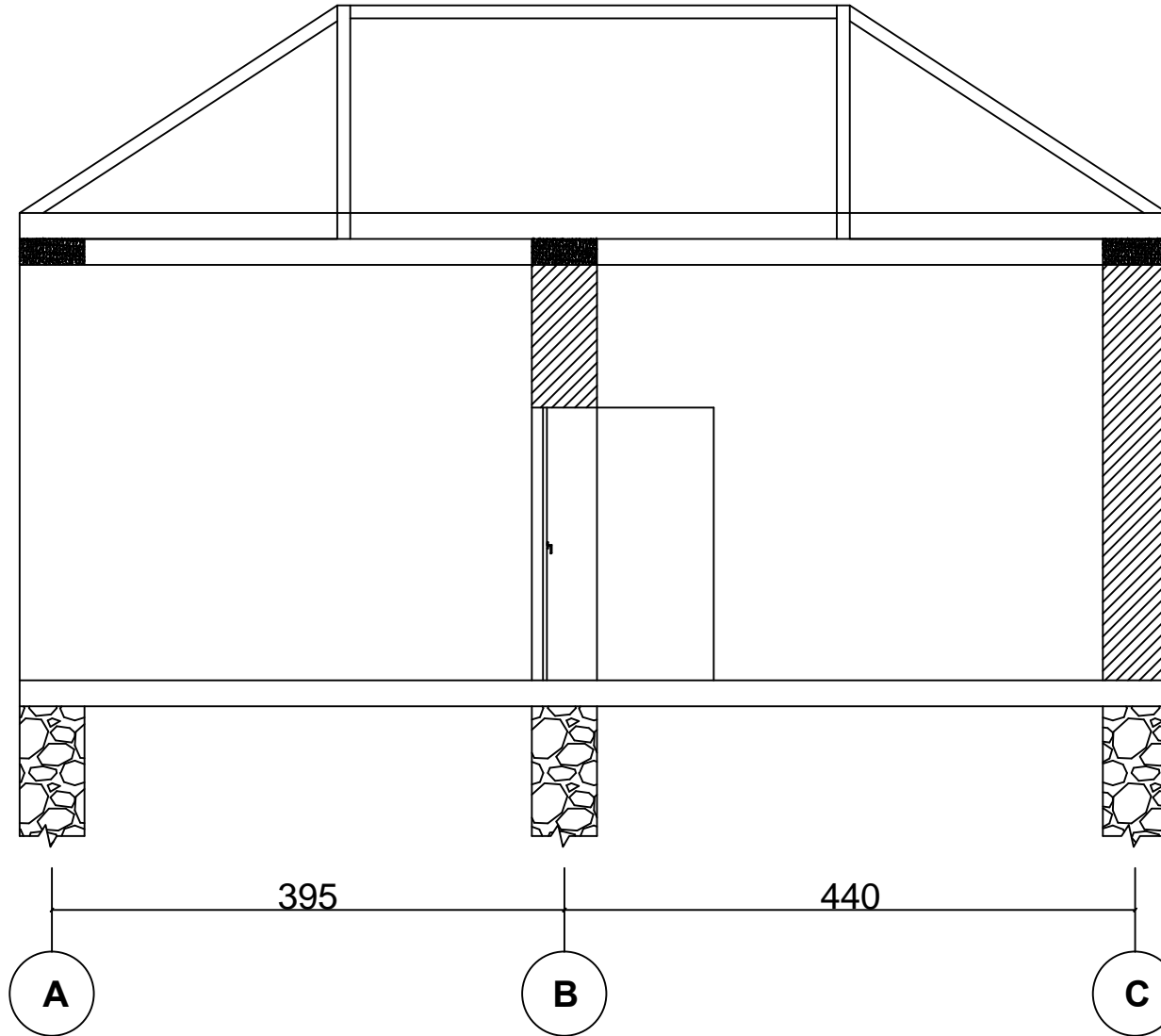

REPUBLIKA E SHQIPERISE
BASHKIA PUSTEC
SEKTTORI I URBANISTIKES

MIRATOI
KRYETARI I BASHKISE
PALI KOLEFSKI

AUTORET E PROJEKTIT

ARKITEKT: PAOLO ROPI
TOPOGRAF: VASKA ARGJIRI

Objekti: _____RIKONSTRUKSON_____

Emertimi: _____

Data: ___/___/2023

OBJEKTI: RIKONSTRUKSION SHTEPI BANIMI
FAMILJA: SPASE QIRO AGO

PLANIMETRI E OBJEKTIT SH: 1:100

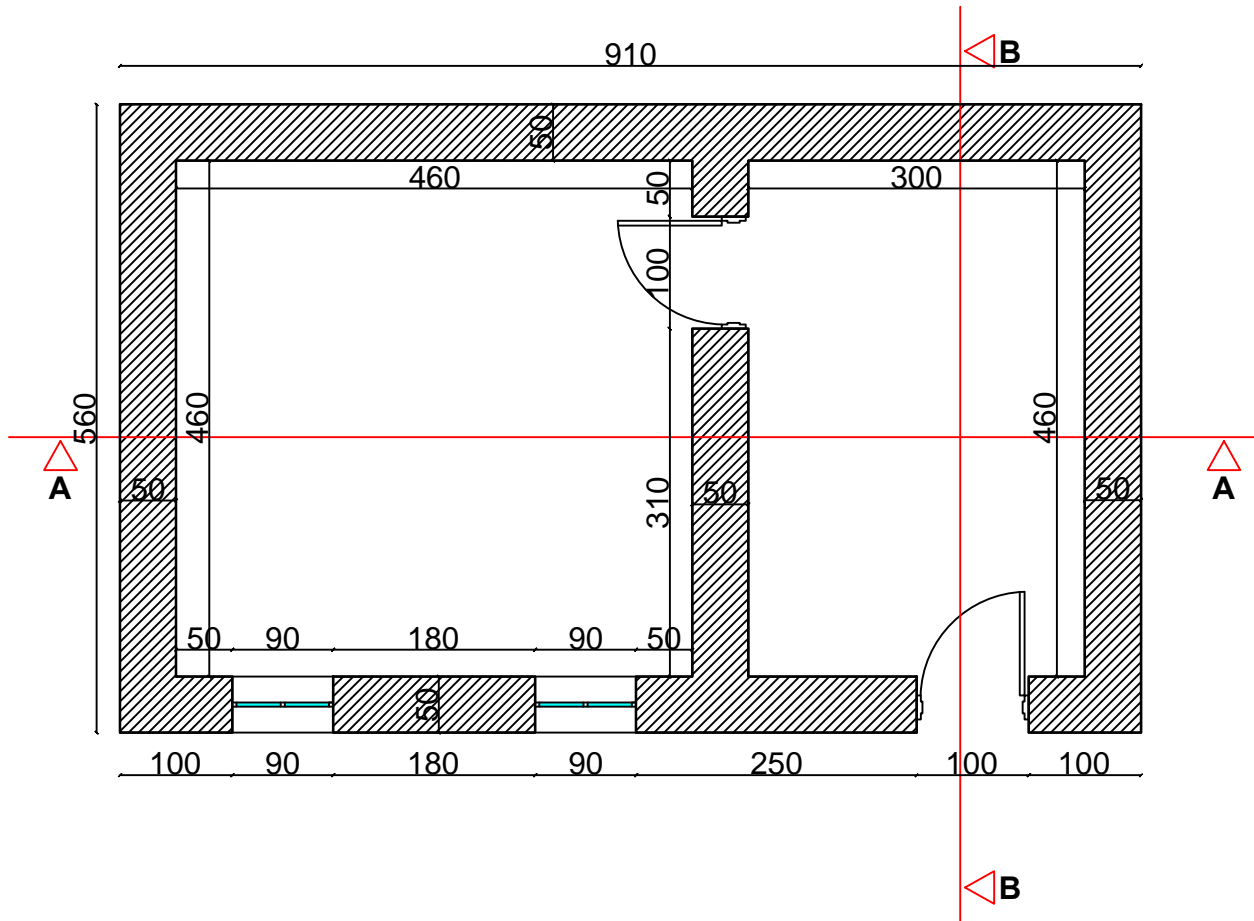

TE DHENATE E PRONESISE

| | | |
|-----------------|---|------------------|
| NR.PASURIE | - | 273/7 |
| ZONA KADASTRALE | - | 2462 |
| VOLUMI | - | 13 |
| FAQE | - | 110 |
| SIPERFAQE | - | 70M ² |



REPUBLIKA E SHQIPERISE
BASHKIA PUSTEC
SEKTTORI I URBANISTIKES

MIRATOI
KRYETARI I BASHKISE
PALI KOLEFSKI

AUTORET E PROJEKTIT

ARKITEKT: PAOLO ROPI
TOPOGRAF: VASKA ARGJIRI

Objekti: _____RIKONSTRUKSON_____

Emertimi: _____

Data: ___/___/2023

PLANI I KULLIMIT TE UJJRAVE

SH: 1:100

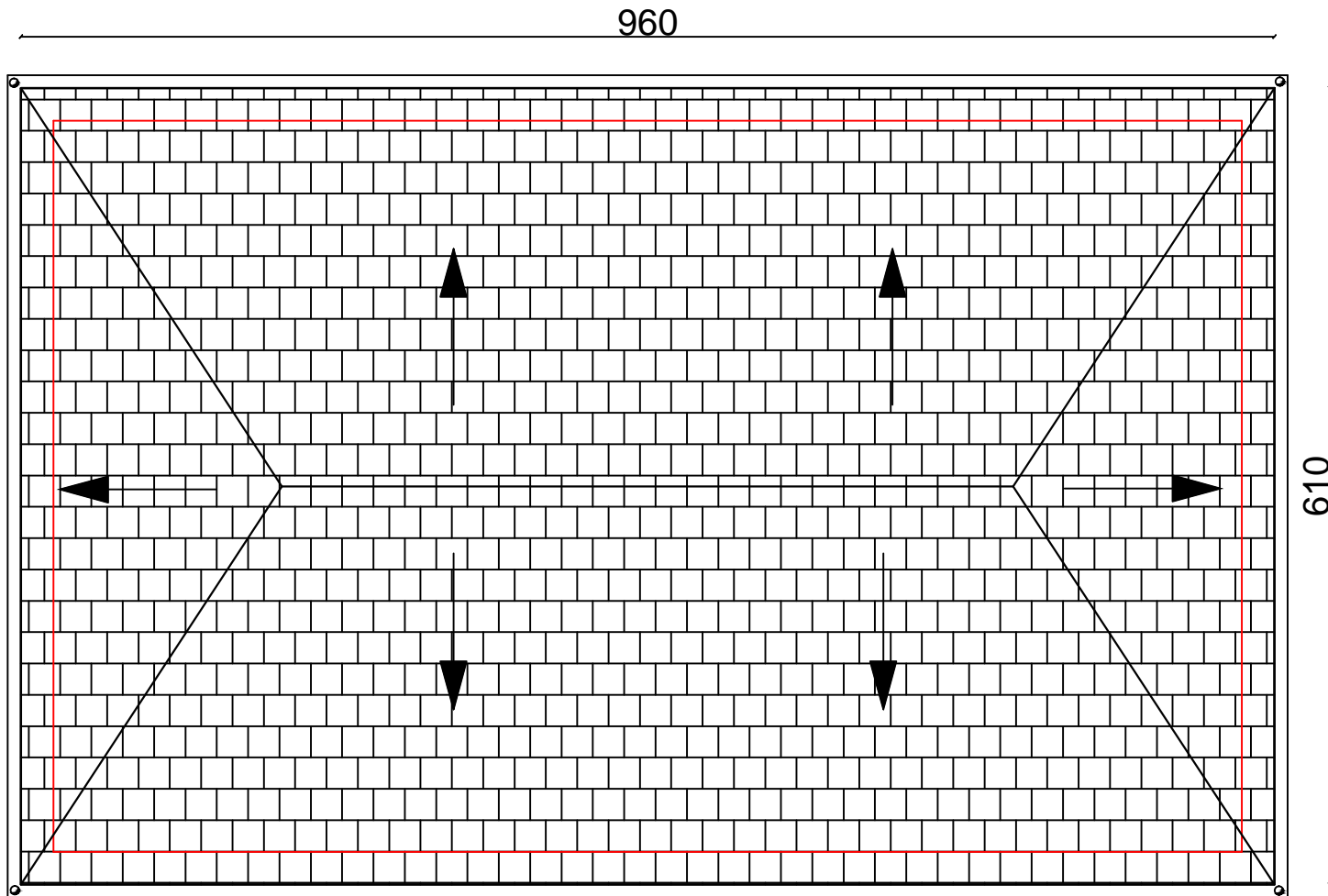

REPUBLIKA E SHQIPERISE
BASHKIA PUSTEC
SEKTORI I URBANISTIKES

MIRATOI
KRYETARI I BASHKISE
PALI KOLEFSKI

AUTORET E PROJEKTIT

ARKITEKT: PAOLO ROPI
TOPOGRAF: VASKA ARGJIRI

Objekti: _____RIKONSTRUKSON_____

Emertimi: _____

Data: ___/___/2023

PRERJA A-A

SH: 1:100

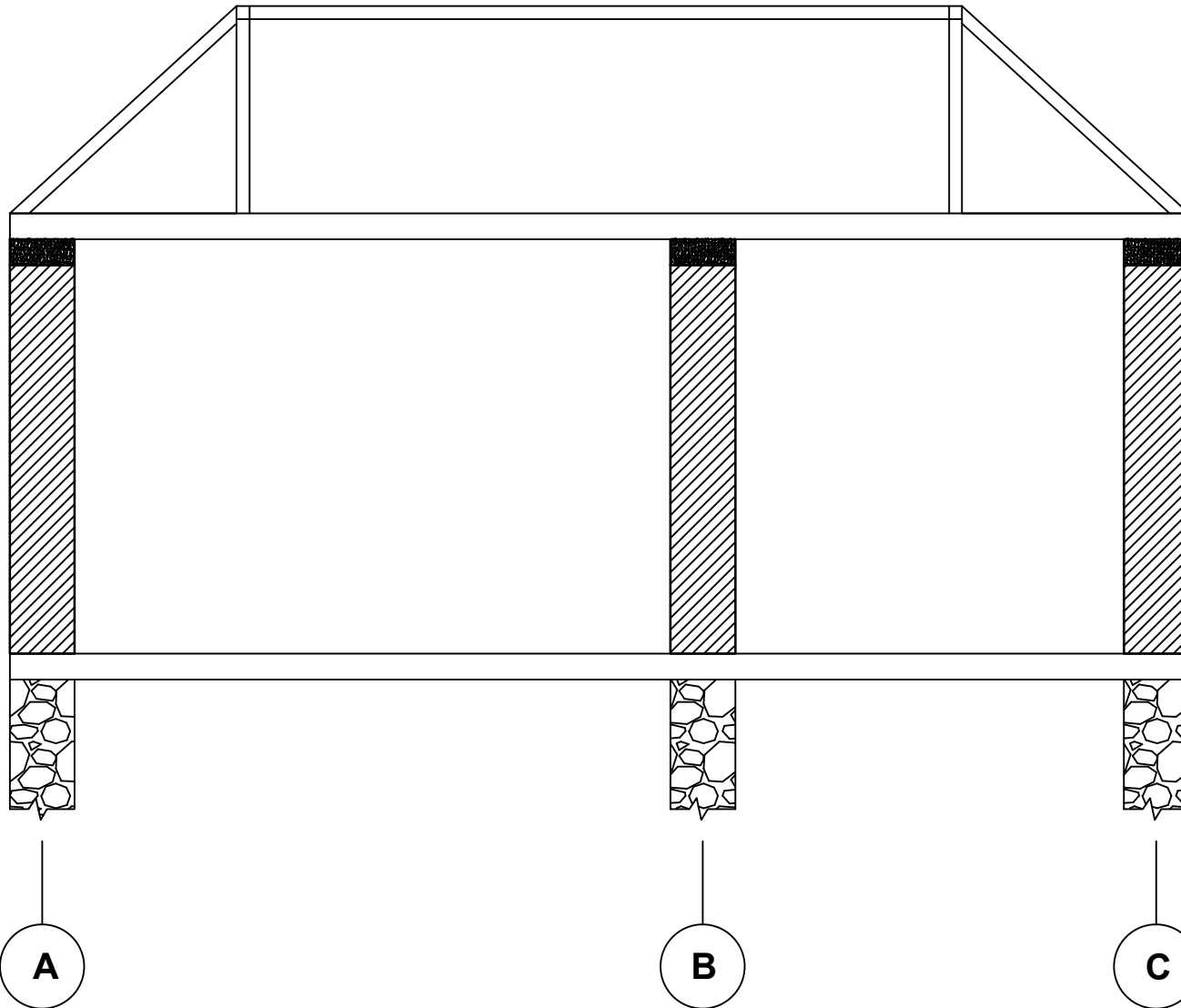

REPUBLIKA E SHQIPERISE
BASHKIA PUSTEC
SEKTORI I URBANISTIKES

MIRATOI
KRYETARI I BASHKISE
PALI KOLEFSKI

AUTORET E PROJEKTIT

ARKITEKT: PAOLO ROPI
TOPOGRAF: VASKA ARGJIRI

Objekti: _____RIKONSTRUKSON_____

Emertimi: _____

Data: __/__/2023

PRERJA B-B
SH: 1:100

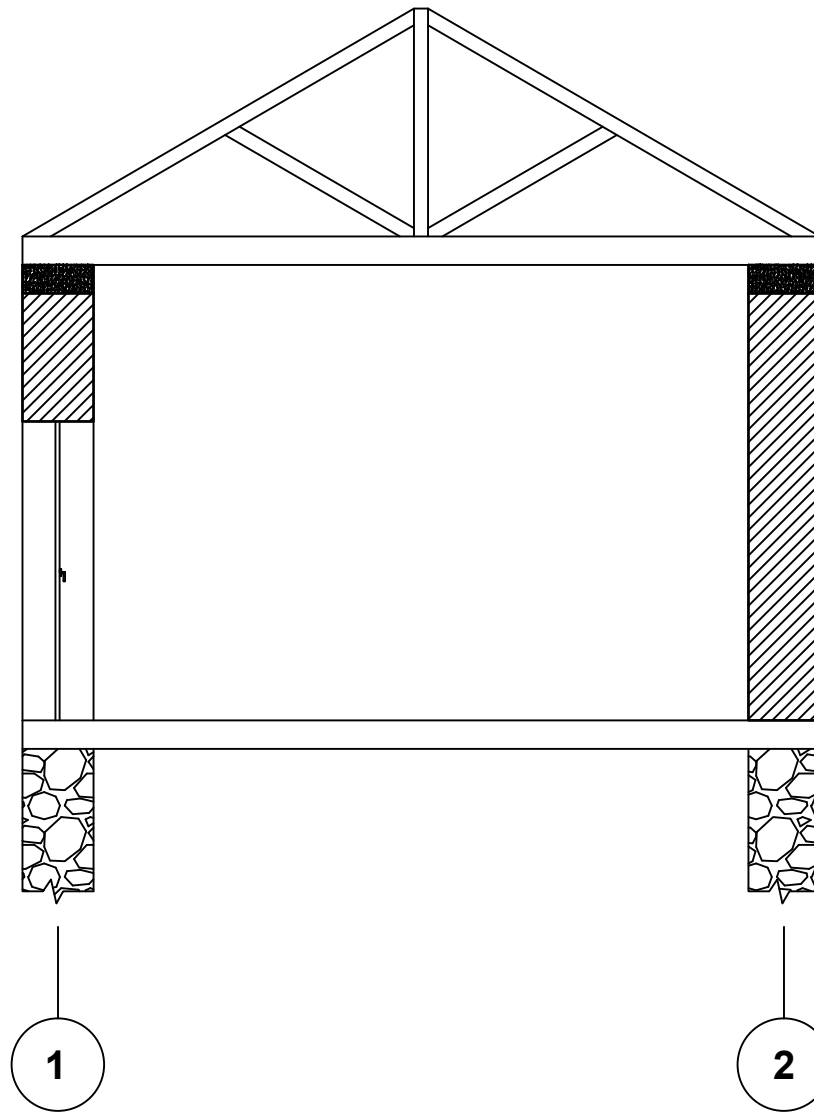

REPUBLIKA E SHQIPERISE
BASHKIA PUSTEC
SEKTORI I URBANISTIKES

MIRATOI
KRYETARI I BASHKISE
PALI KOLEFSKI

AUTORET E PROJEKTIT

ARKITEKT: PAOLO ROPI
TOPOGRAF: VASKA ARGJIRI

Objekti: _____RIKONSTRUKSON_____

Emertimi: _____

Data: ___/___/2023

PLANI I KONSTRUKTIV I CATISE

SH: 1:100

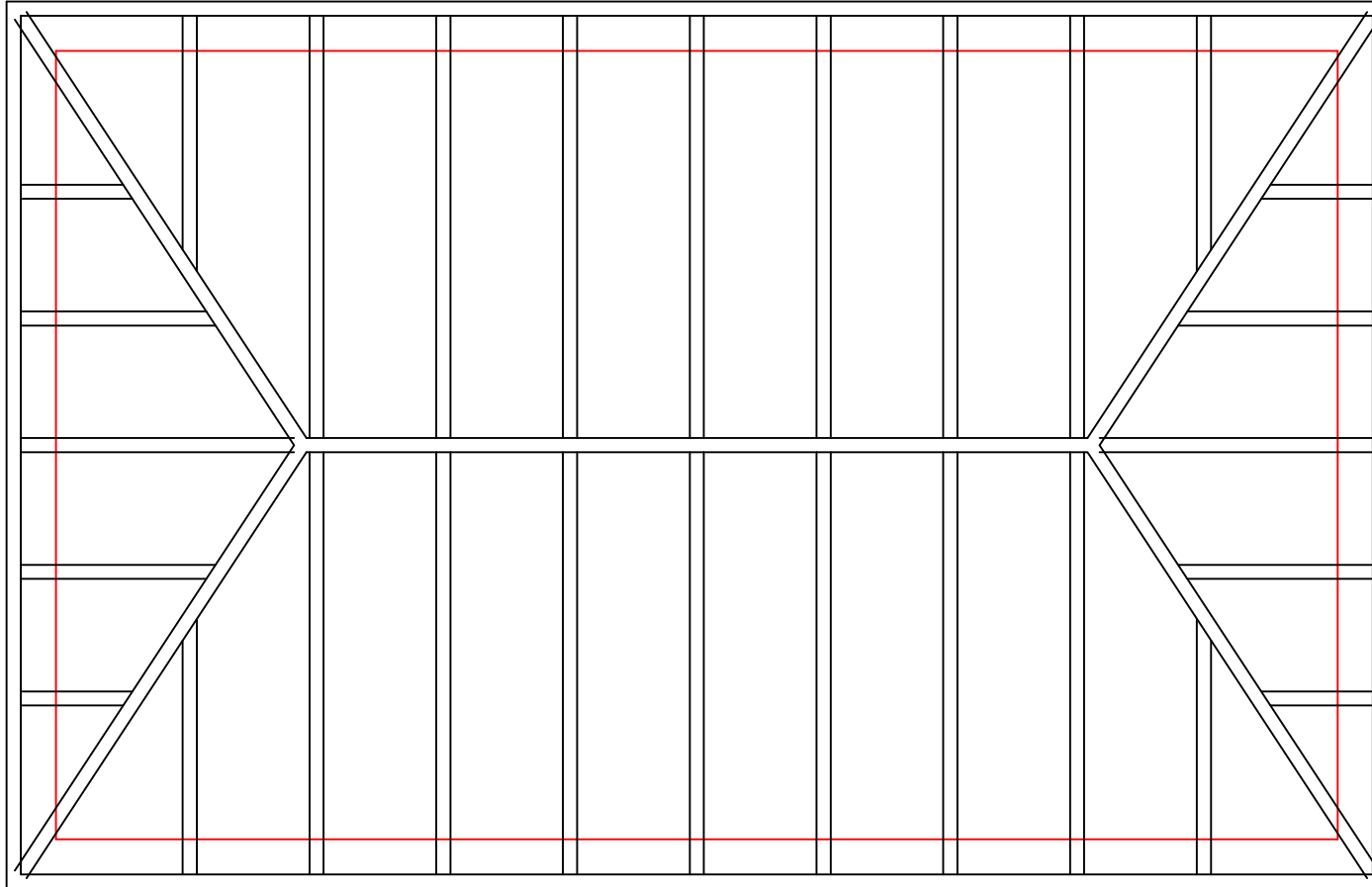

SHPJEGIM TEKNIK

NDERTIMI I CATISE DO REALIZOHET ME
LENDE DRRURI TE SHARRUARTE CILAT
DO TE MBESHTETEN MBI TRARET E
TAVANIT 20X20 CM TE CILAT DO JENE
SHARUAR DHE STAZHONUAR SIMBAS K.T.Z
RISTELAT KU DO MBESHTETEN
TJEGULLAT DO JENE ME PERMASA 5X4CM DHE
DO VENDOSEN CDO 30-35CM SIMBAS
LLOJIT TE TJEGULLES
PERMASAT E MAHIVE DO JENE ME PERMASA
10X8CM DISTANCA E TE CILAVE
DO JENE CDO 80CM
TJEGULLA TE PLANIFIKUARA IMPORTI
TRARET HORIZONTALE DHE KULMORE
JANE TE PERMASAVE 10X10CM
NE DREJTIM GJATESOR DO VENDOSEN
KONDRARENTIME ME PERMASA 10X8
ULLUKET DO JENE LLAMARINE XINGATO



REPUBLIKA E SHQIPERISE
BASHKIA PUSTEC
SEKTTORI I URBANISTIKES

MIRATOI
KRYETARI I BASHKISE
PALI KOLEFSKI

AUOTRET E PROJEKTIT

ARKITEKT: PAOLO ROPI
TOPOGRAF: VASKA ARGJIRI

Objekti: _____RIKONSTRUKSON_____

Emertimi: _____

Data: ___/___/2023

PLANIMETRI E OBJEKTIT SH: 1:100

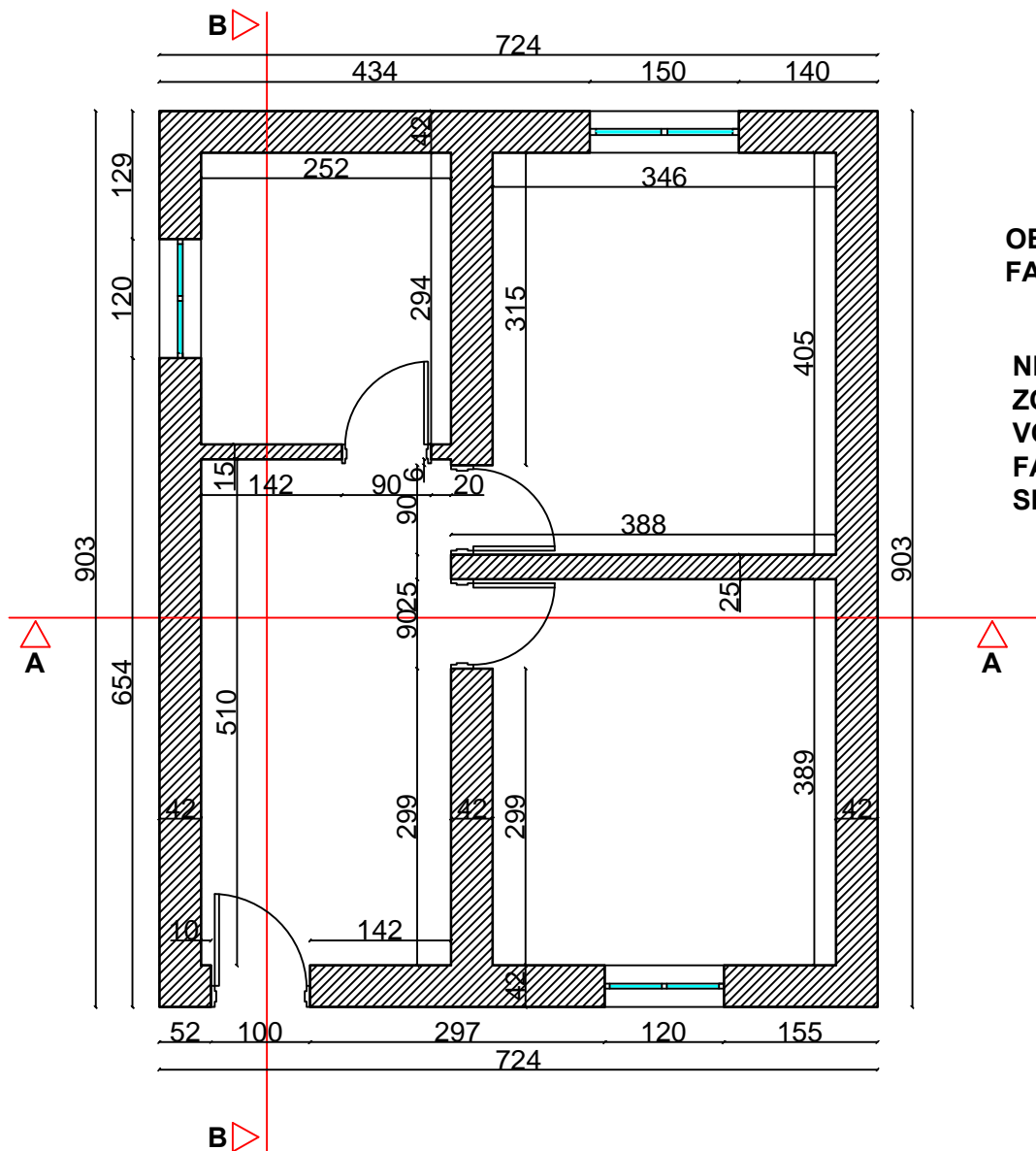

OBJEKTI: RIKONSTRUKSION SHTEPI BANIMI
 FAMILJA: NASTASIA PAPA

TE DHENATE E PRONESISE

NR.PASURIE - 153/21
 ZONA KADASTRALE - 2045
 VOLUMI - 5
 FAQE - 190
 SIPERFAQE - 90M²



REPUBLIKA E SHQIPERISE
 BASHKIA PUSTEC
 SEKTTORI I URBANISTIKES

MIRATOI
 KRYETARI I BASHKISE
 PALI KOLEFSKI

AUTORET E PROJEKTIT

ARKITEKT: PAOLO ROPI
 TOPOGRAF: VASKA ARGJIRI

Objekti: _____RIKONSTRUKSION_____

Emertimi: _____

Data: ___/___/2023

PLANI I KULLIMIT TE UJJRAVE
SH: 1:100

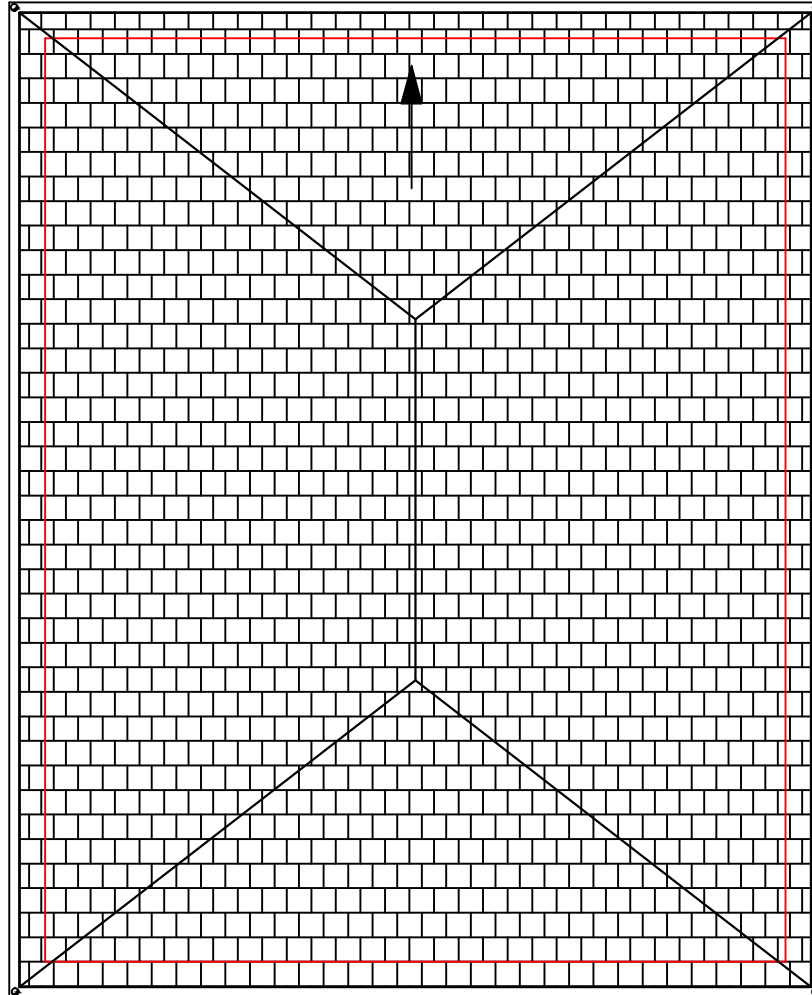

REPUBLIKA E SHQIPERISE
BASHKIA PUSTEC
SEKTORI I URBANISTIKES

MIRATOI
KRYETARI I BASHKISE
PALI KOLEFSKI

AUTORET E PROJEKTIT

ARKITEKT: PAOLO ROPI
TOPOGRAF: VASKA ARGJIRI

Objekti: _____RIKONSTRUKSON_____

Emertimi: _____

Data: ___/___/2023

PRERJA A-A
SH: 1:100

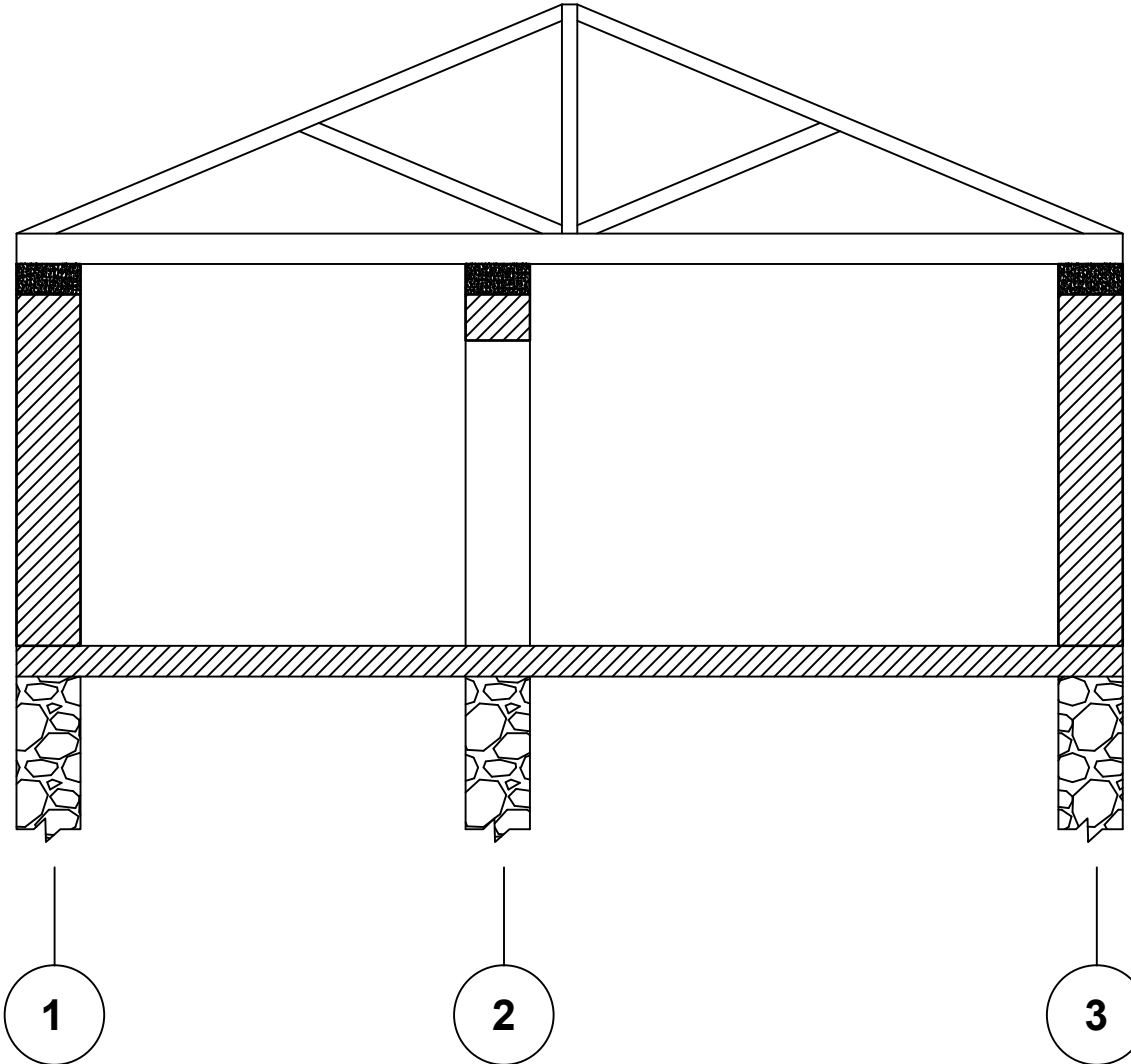

REPUBLIKA E SHQIPERISE
BASHKIA PUSTEC
SEKTTORI I URBANISTIKES

MIRATOI
KRYETARI I BASHKISE
PALI KOLEFSKI

AUTORET E PROJEKTIT

ARKITEKT: PAOLO ROPI
TOPOGRAF: VASKA ARGJIRI

| |
|----------------------------------|
| Objekti: _____RIKONSTRUKSON_____ |
| Emertimi: _____ |
| Data: __/__/2023 |

PRERJA B-B

SH: 1:100

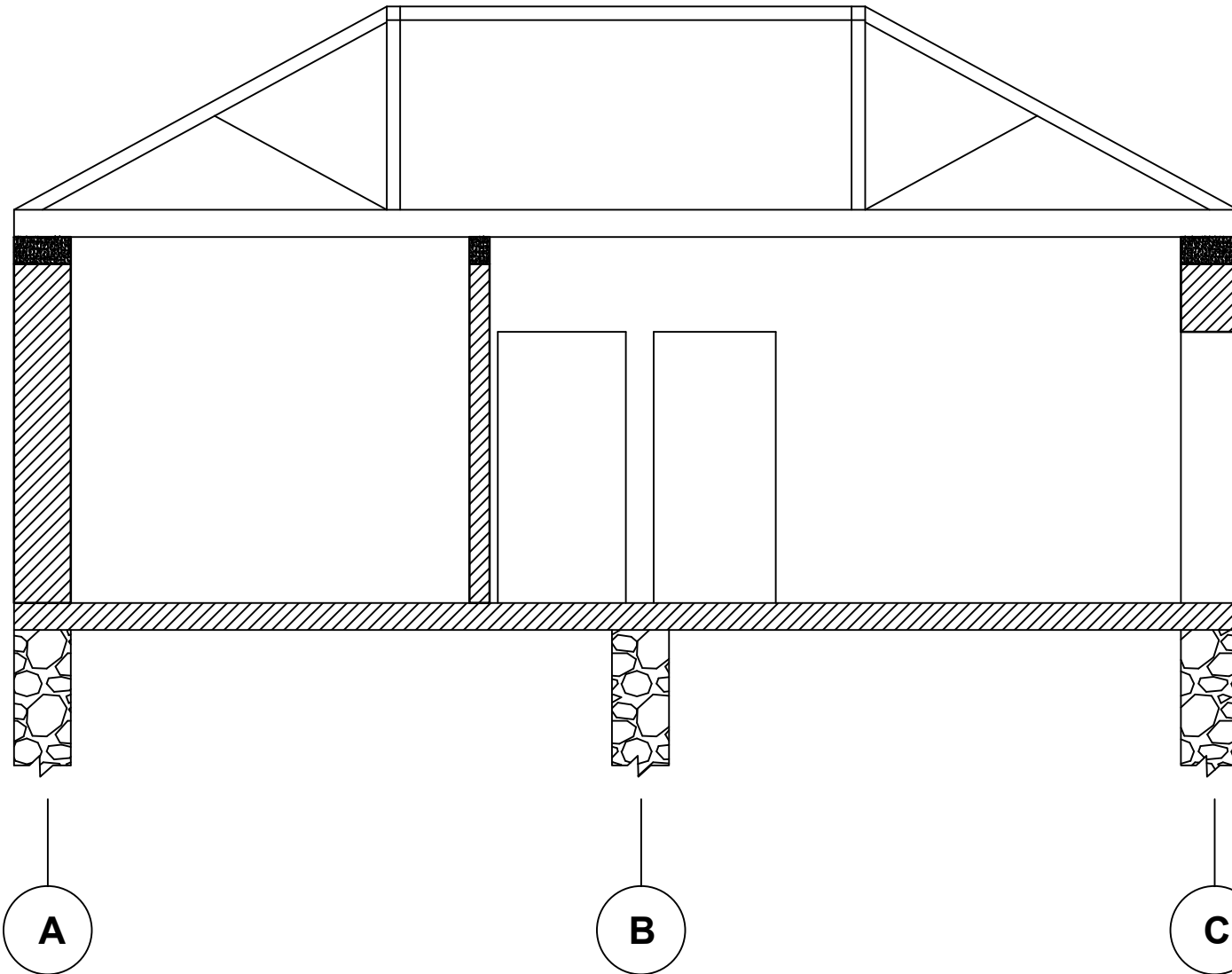

REPUBLIKA E SHQIPERISE
BASHKIA PUSTEC
SEKTORI I URBANISTIKES

MIRATOI
KRYETARI I BASHKISE
PALI KOLEFSKI

AUTORET E PROJEKTIT

ARKITEKT: PAOLO ROPI
TOPOGRAF: VASKA ARGJIRI

Objekti: _____RIKONSTRUKSON_____

Emertimi: _____

Data: ___/___/2023

PLANI I KONSTRUKTIV I CATISE
SH: 1:100

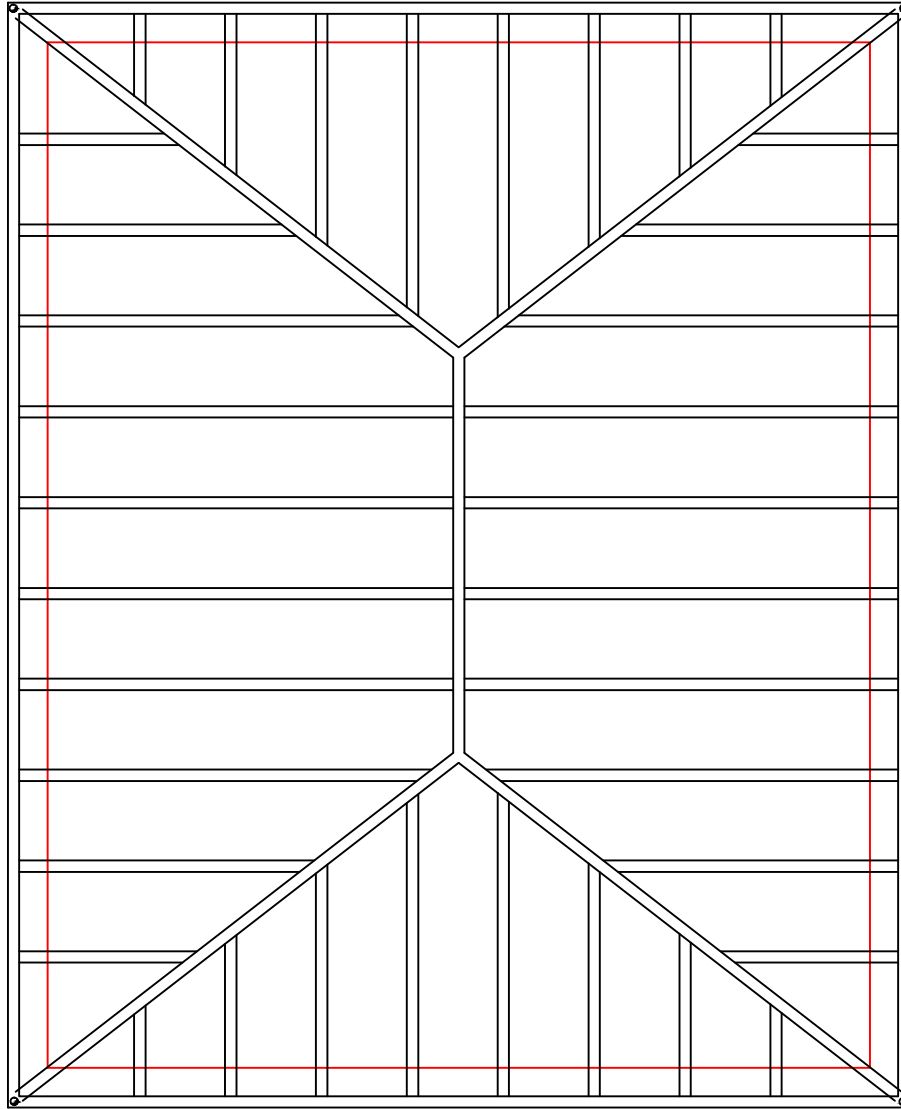

SHPJEGIM TEKNIK

NDERTIMI I CATISE DO REALIZOHET ME
LENDE DRRURI TE SHARRUARTE CILAT
DO TE MBESHTEEN MBI TRARET E
TAVANIT 20X20 CM TE CILAT DO JENE
SHARUAR DHE STAZHONUAR SIMBAS K.T.Z
RISTELAT KU DO MBESHTEEN
TJEGULLAT DO JENE ME PERMASA 5X4CM DHE
DO VENDOSEN CDO 30-35CM SIMBAS
LLOJIT TE TJEGULLES
PERMASAT E MAHIVE DO JENE ME PERMASA
10X8CM DISTANCA E TE CILAVE
DO JENE CDO 80CM
TJEGULLA TE PLANIFIKUARA IMPORTI
TRARET HORIZONTALE DHE KULMORE
JANE TE PERMASAVE 10X10CM
NE DREJTIM GJATESOR DO VENDOSEN
KONDRAVENTIME ME PERMASA 10X8
ULLUKET DO JENE LLAMARINE XINGATO



REPUBLIKA E SHQIPERISE
BASHKIA PUSTEC
SEKTTORI I URBANISTIKES

MIRATOI
KRYETARI I BASHKISE
PALI KOLEFSKI

AUTORET E PROJEKTIT

ARKITEKT: PAOLO ROPI
TOPOGRAF: VASKA ARGJIRI

Objekti: _____RIKONSTRUKSON_____

Emertimi: _____

Data: ___/___/2023

PLANIMETRI E OBJEKTIT SH: 1:100

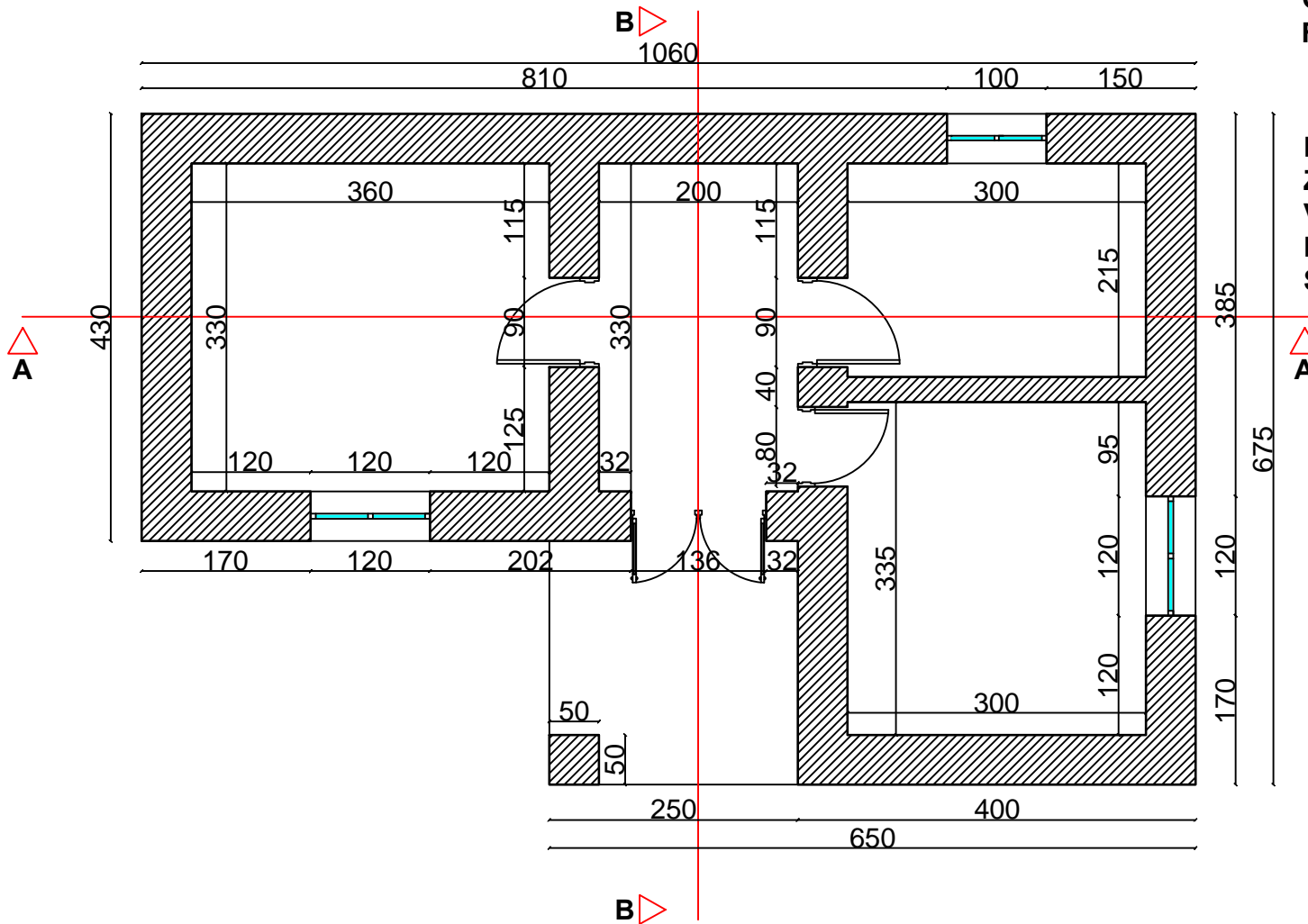

OBJEKTI: RIKONSTRUKSION SHTEPI BAN
FAMILJA: GJERGJI TANCE NIKOLLA

TE DHENATE E PRONESISE

| | | |
|-----------------|---|------------------|
| NR.PASURIE | - | 75/6 |
| ZONA KADASTRALE | - | 1488 |
| VOLUMI | - | 2 |
| FAQE | - | 225 |
| SIPERFAQE | - | 60M ² |



REPUBLIKA E SHQIPERISE
BASHKIA PUSTEC
SEKTTORI I URBANISTIKES

MIRATOI
KRYETARI I BASHKISE
PALI KOLEFSKI

AUTORET E PROJEKTIT

ARKITEKT: PAOLO ROPI
TOPOGRAF: VASKA ARGJIRI

Objekti: _____RIKONSTRUKSON_____

Emertimi: _____

Data: ___/___/2023

PLANI I KULLIMIT TE UJJRAVE

SH: 1:100

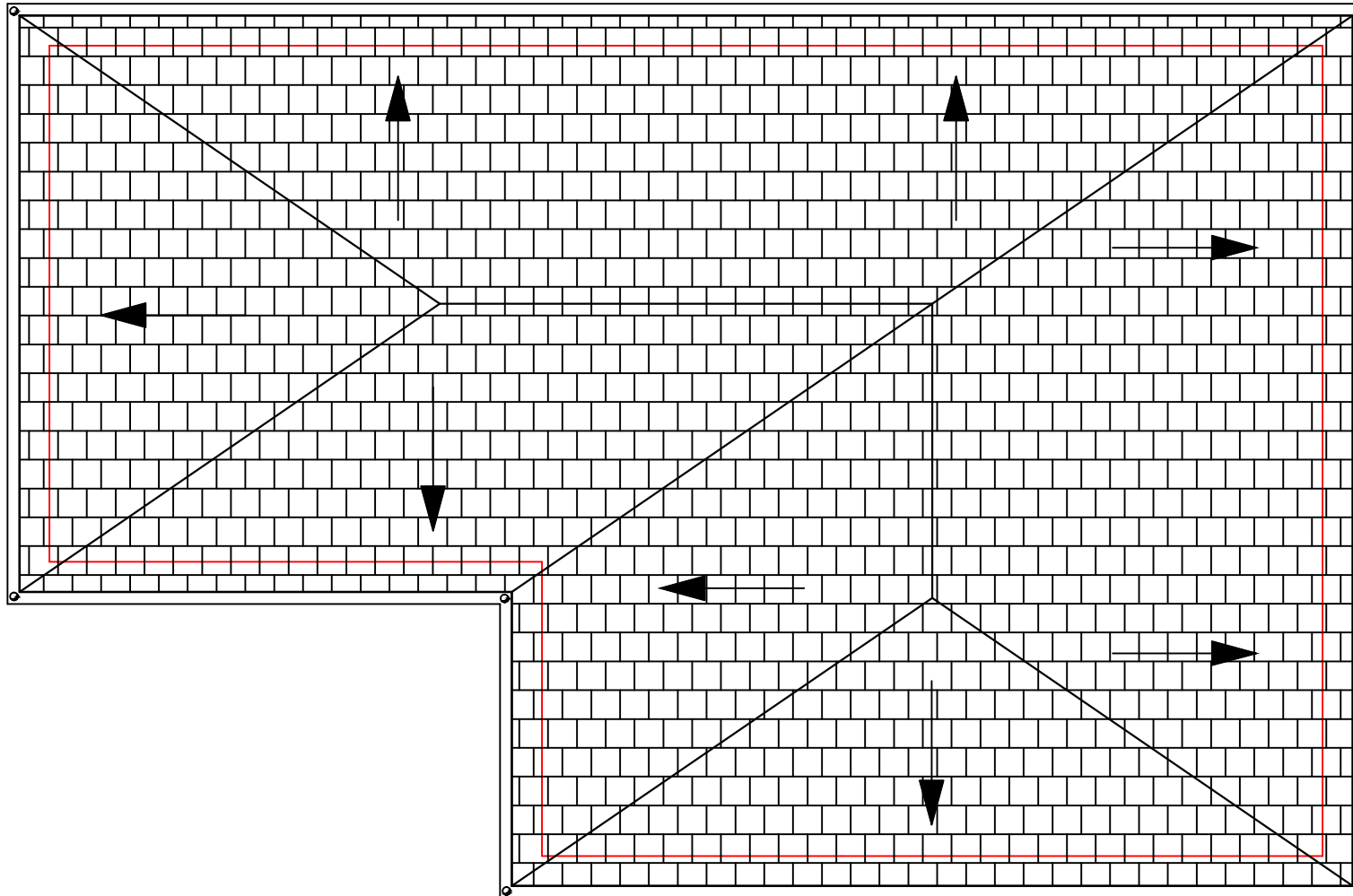

REPUBLIKA E SHQIPERISE
BASHKIA PUSTEC
SEKTORI I URBANISTIKES

MIRATOI
KRYETARI I BASHKISE
PALI KOLEFSKI

AUTORET E PROJEKTIT

ARKITEKT: PAOLO ROPI
TOPOGRAF: VASKA ARGJIRI

Objekti: _____RIKONSTRUKSON_____

Emertimi: _____

Data: ___/___/2023

PRERJA A-A
SH: 1:100

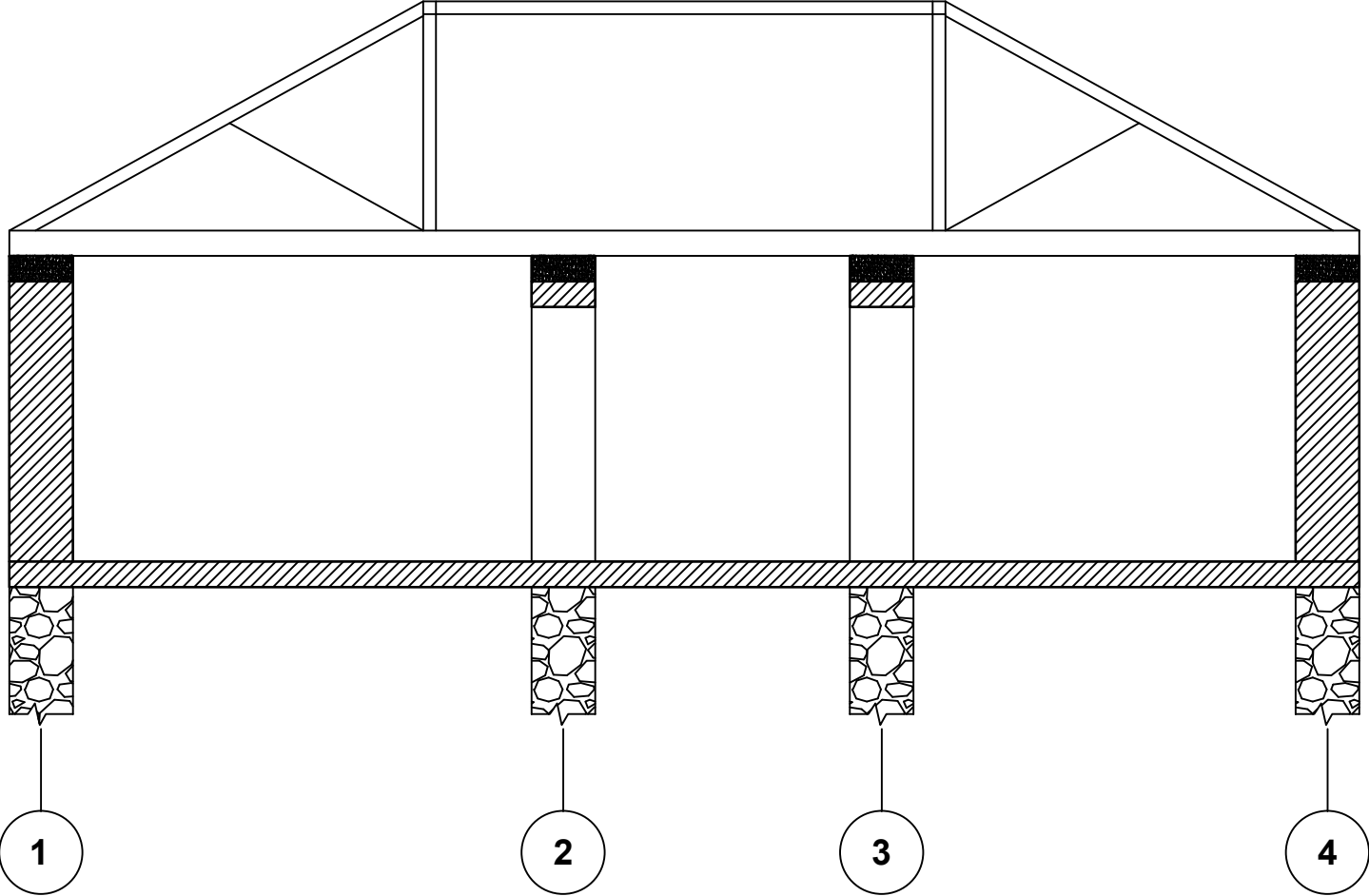

REPUBLIKA E SHQIPERISE
BASHKIA PUSTEC
SEKTTORI I URBANISTIKES

MIRATOI
KRYETARI I BASHKISE
PALI KOLEFSKI

AUTORET E PROJEKTIT

ARKITEKT: PAOLO ROPI
TOPOGRAF: VASKA ARGJIRI

Objekti: _____RIKONSTRUKSON_____

Emertimi: _____

Data: ___/___/2023

PRERJA B-B
SH: 1:100

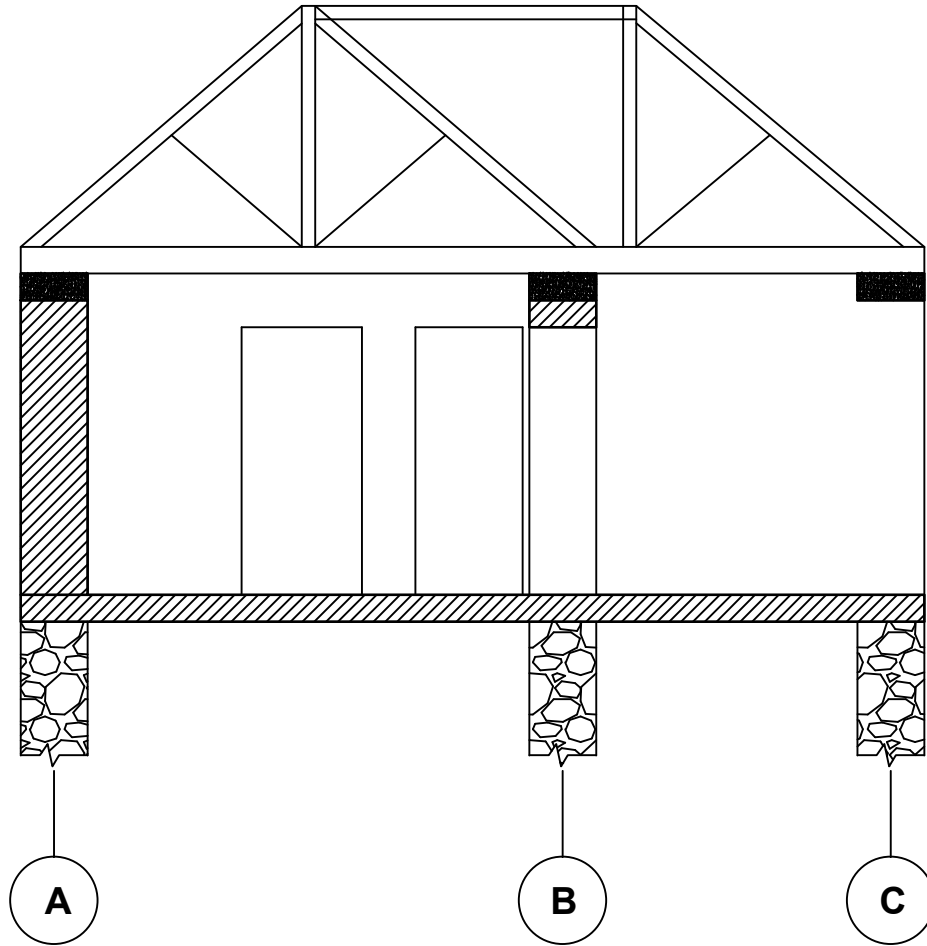

REPUBLIKA E SHQIPERISE
BASHKIA PUSTEC
SEKTORI I URBANISTIKES

MIRATOI
KRYETARI I BASHKISE
PALI KOLEFSKI

AUTORET E PROJEKTIT

ARKITEKT: PAOLO ROPI
TOPOGRAF: VASKA ARGJIRI

Objekti: _____RIKONSTRUKSON_____

Emertimi: _____

Data: ___/___/2023

PLANI I KONSTRUKTIV I CATISE

SH: 1:100

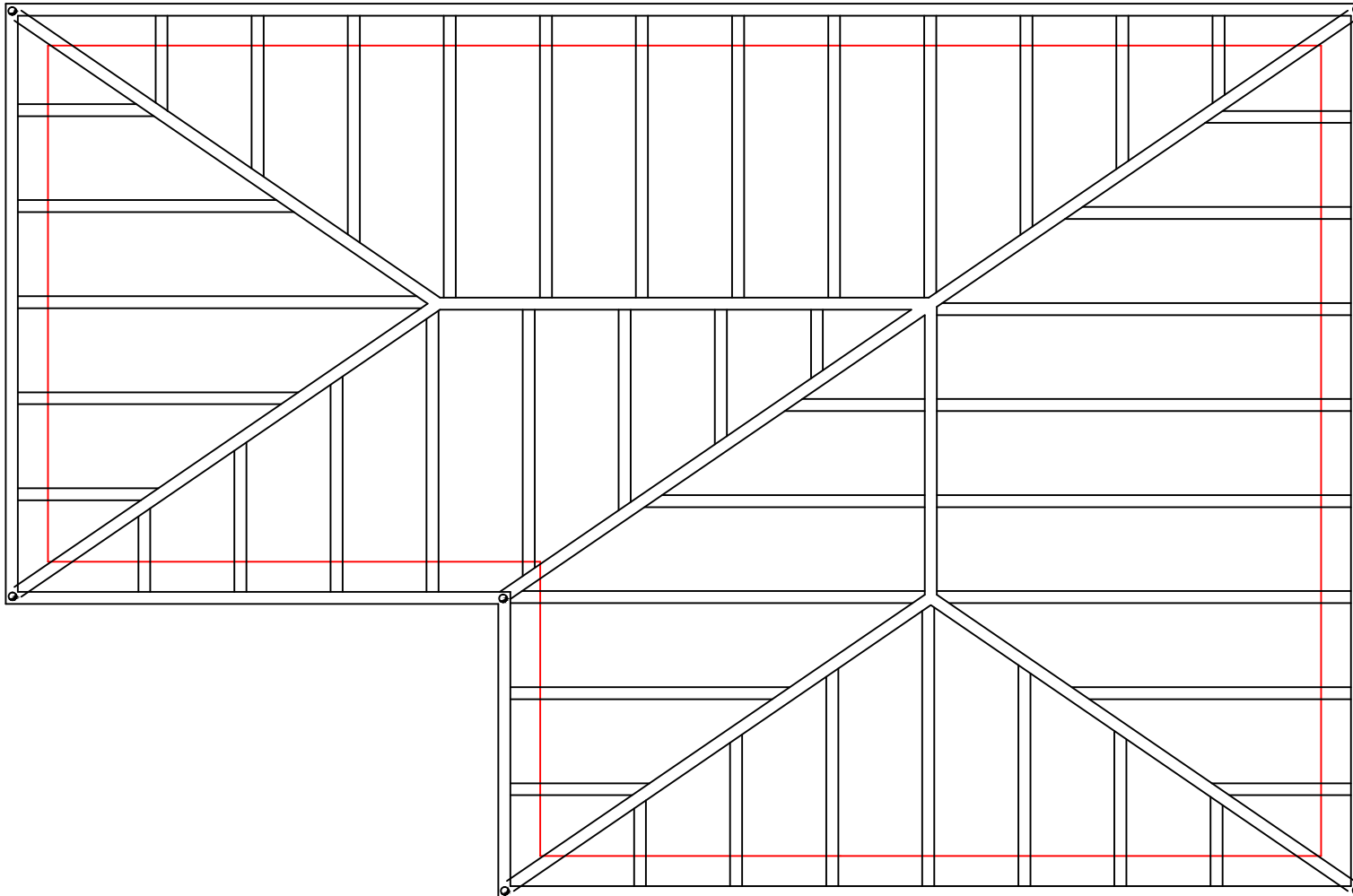

SHPJEGIM TEKNIK

NDERTIMI I CATISE DO REALIZOHET ME
LENDE DRRURI TE SHARRUARTE CILAT
DO TE MBESHTETEN MBI TRARET E
TAVANIT 20X20 CM TE CILAT DO JENE
SHARUAR DHE STAZHONUAR SIMBAS K.T.Z
RISTELAT KU DO MBESHTETEN
TJEGULLAT DO JENE ME PERMASA 5X4CM DHI
DO VENDOSEN CDO 30-35CM SIMBAS
LLOJIT TE TJEGULLES
PERMASAT E MAHIVE DO JENE ME PERMASA
10X8CM DISTANCA E TE CILAVE
DO JENE CDO 80CM
TJEGULLA TE PLANIFIKUARA IMPORTI
TRARET HORIZONTALE DHE KULMORE
JANE TE PERMASAVE 10X10CM
NE DREJTIM GJATESOR DO VENDOSEN
KONDRAVENTIME ME PERMASA 10X8
ULLUKET DO JENE LLAMARINE XINGATO



REPUBLIKA E SHQIPERISE
BASHKIA PUSTEC
SEKTTORI I URBANISTIKES

MIRATOI
KRYETARI I BASHKISE
PALI KOLEFSKI

AUTORET E PROJEKTIT

ARKITEKT: PAOLO ROPI
TOPOGRAF: VASKA ARGJIRI

Objekti: _____RIKONSTRUKSON_____

Emertimi: _____

Data: ___/___/2023

PLANIMETRI E OBJEKTIT SH: 1:100

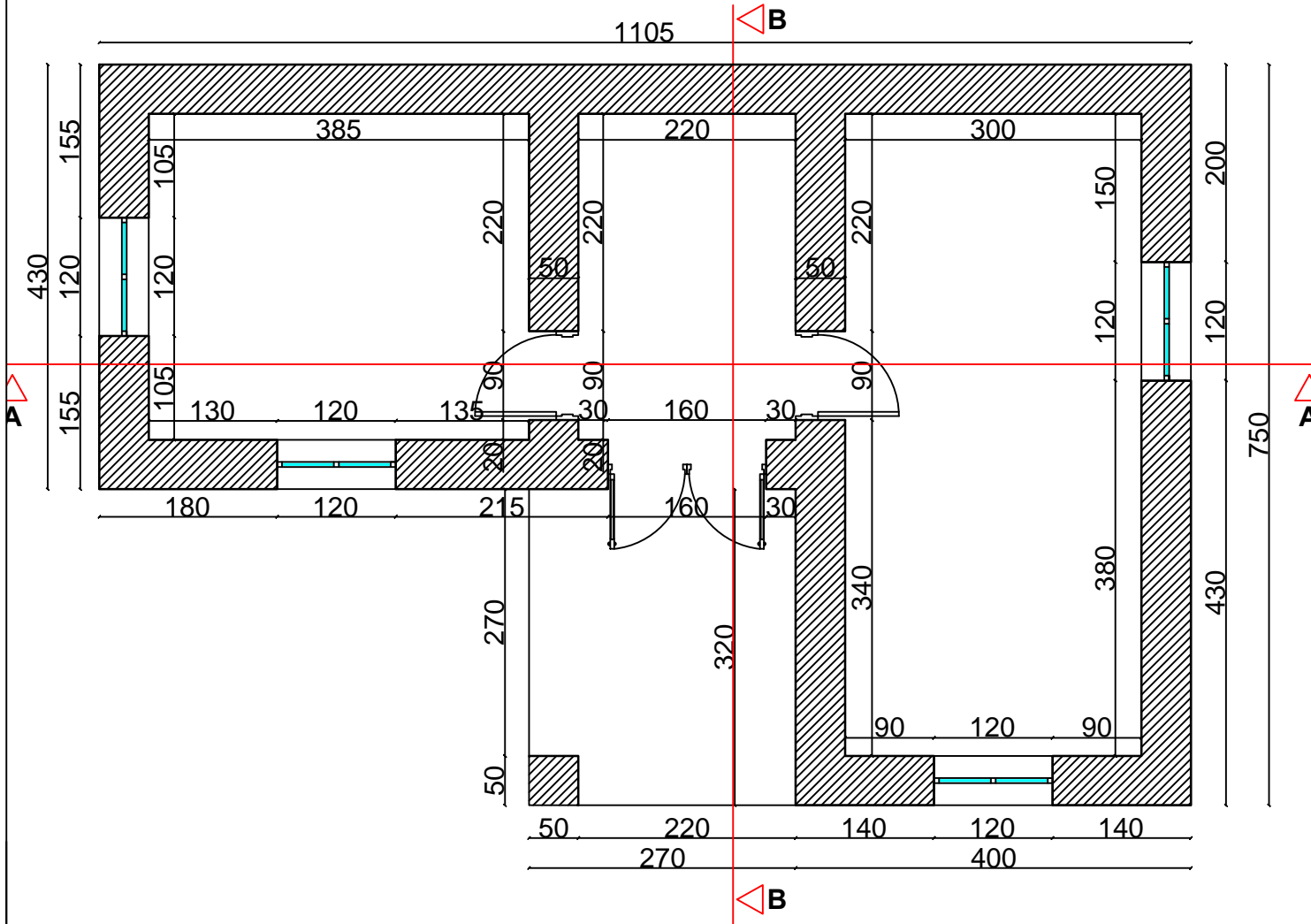

OBJEKTI: RIKONSTRUKSION SHTEPI B.
FAMILJA: NIKO GJERMAN ANDREA

TE DHENATE E PRONESISE

NR.PASURIE - 79/2
ZONA KADASTRALE - 1488
VOLUMI - 2
FAQE - 247
SIPERFAQE - 65M²



REPUBLIKA E SHQIPERISE
BASHKIA PUSTEC
SEKTTORI I URBANISTIKES

MIRATOI
KRYETARI I BASHKISE
PALI KOLEFSKI

AUTORET E PROJEKTIT

ARKITEKT: PAOLO ROPI
TOPOGRAF: VASKA ARGJIRI

Objekti: _____RIKONSTRUKSON_____

Emertimi: _____

Data: ___/___/2023

PLANI I KULLIMIT TE UJJRAVE
SH: 1:100

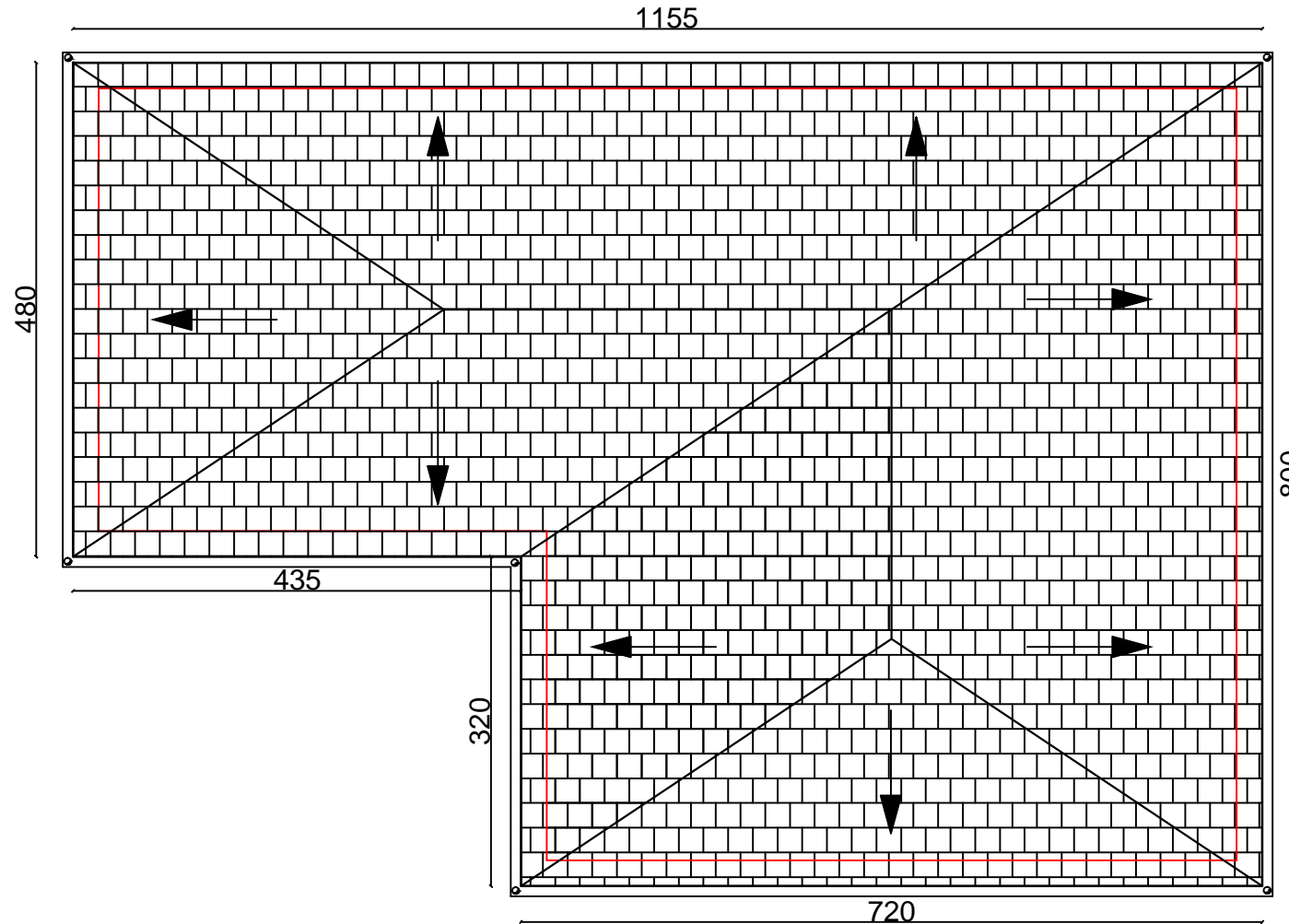

REPUBLIKA E SHQIPERISE
BASHKIA PUSTEC
SEKTTORI I URBANISTIKES

MIRATOI
KRYETARI I BASHKISE
PALI KOLEFSKI

AUTORET E PROJEKTIT

ARKITEKT: PAOLO ROPI
TOPOGRAF: VASKA ARGJIRI

Objekti: _____RIKONSTRUKSON_____

Emertimi: _____

Data: ___/___/2023

PRERJA A-A
SH: 1:100

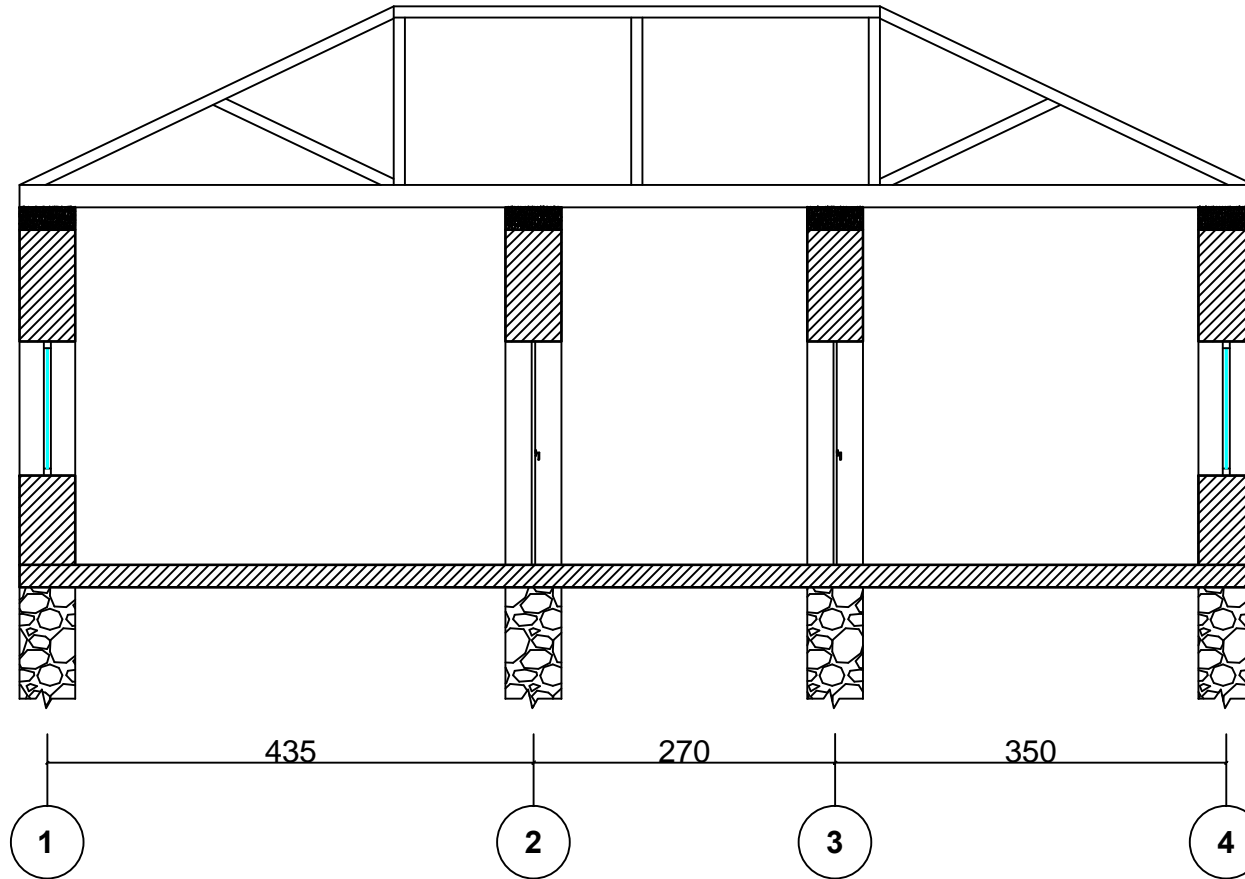

REPUBLIKA E SHQIPERISE
BASHKIA PUSTEC
SEKTORI I URBANISTIKES

MIRATOI
KRYETARI I BASHKISE
PALI KOLEFSKI

AUTORET E PROJEKTIT

ARKITEKT: PAOLO ROPI
TOPOGRAF: VASKA ARGJIRI

Objekti: _____RIKONSTRUKSON_____

Emertimi: _____

Data: ___/___/2023

PRERJA B-B
SH: 1:100

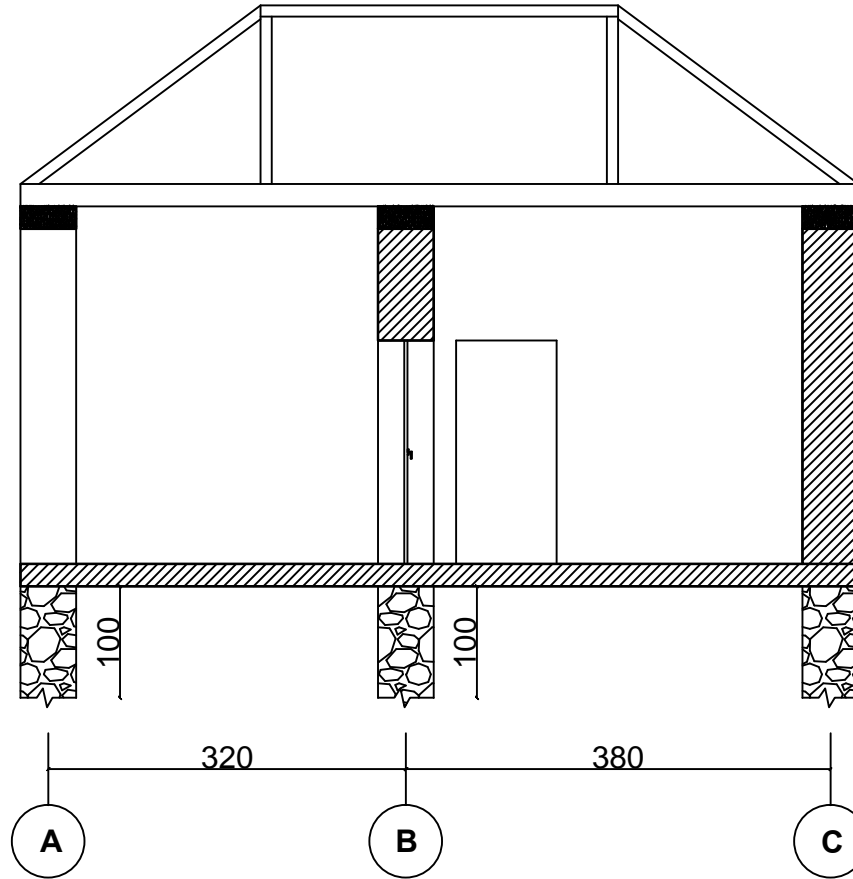

REPUBLIKA E SHQIPERISE
BASHKIA PUSTEC
SEKTTORI I URBANISTIKES

MIRATOI
KRYETARI I BASHKISE
PALI KOLEFSKI

AUTORET E PROJEKTIT

ARKITEKT: PAOLO ROPI
TOPOGRAF: VASKA ARGJIRI

Objekti: _____RIKONSTRUKSON_____

Emertimi: _____

Data: __/__/2023

PLANI I KONSTRUKTIV I CATISE
SH: 1:100

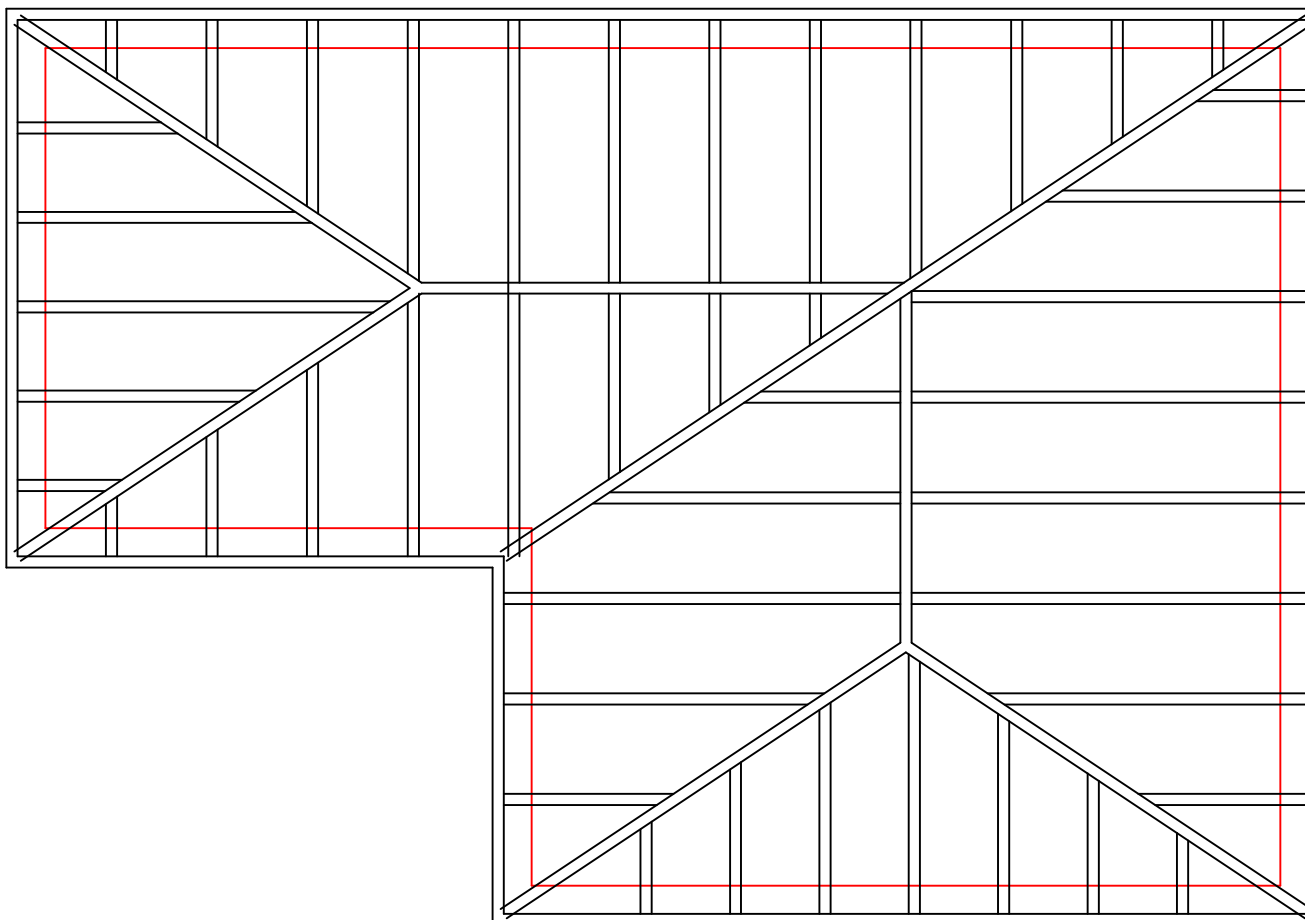

SHPJEGIM TEKNIK

NDERTIMI I CATISE DO REALIZOHET ME
LENDE DRRURI TE SHARRUARTE CILAT
DO TE MBESHTEEN MBI TRARET E
TAVANIT 20X20 CM TE CILAT DO JENE
SHARUAR DHE STAZHONUAR SIMBAS K.T.Z
RISTELAT KU DO MBESHTEEN
TJEGULLAT DO JENE ME PERMASA 5X4CM DHE
DO VENDOSEN CDO 30-35CM SIMBAS
LLOJIT TE TJEGULLES
PERMASAT E MAHIVE DO JENE ME PERMASA
10X8CM DISTANCA E TE CILAVE
DO JENE CDO 80CM
TJEGULLA TE PLANIFIKUARA IMPORTI
TRARET HORIZONTALE DHE KULMORE
JANE TE PERMASAVE 10X10CM
NE DREJTIM GJATESOR DO VENDOSEN
KONDRAVENTIME ME PERMASA 10X8
ULLUKET DO JENE LLAMARINE XINGATO



REPUBLIKA E SHQIPERISE
BASHKIA PUSTEC
SEKTTORI I URBANISTIKES

MIRATOI
KRYETARI I BASHKISE
PALI KOLEFSKI

AUTORET E PROJEKTT

ARKITEKT: PAOLO ROPI
TOPOGRAF: VASKA ARGJIRI

Objekti: _____RIKONSTRUKSON_____

Emertimi: _____

Data: ___/___/2023

PLANIMETRI E OBJEKTIT SH: 1:100

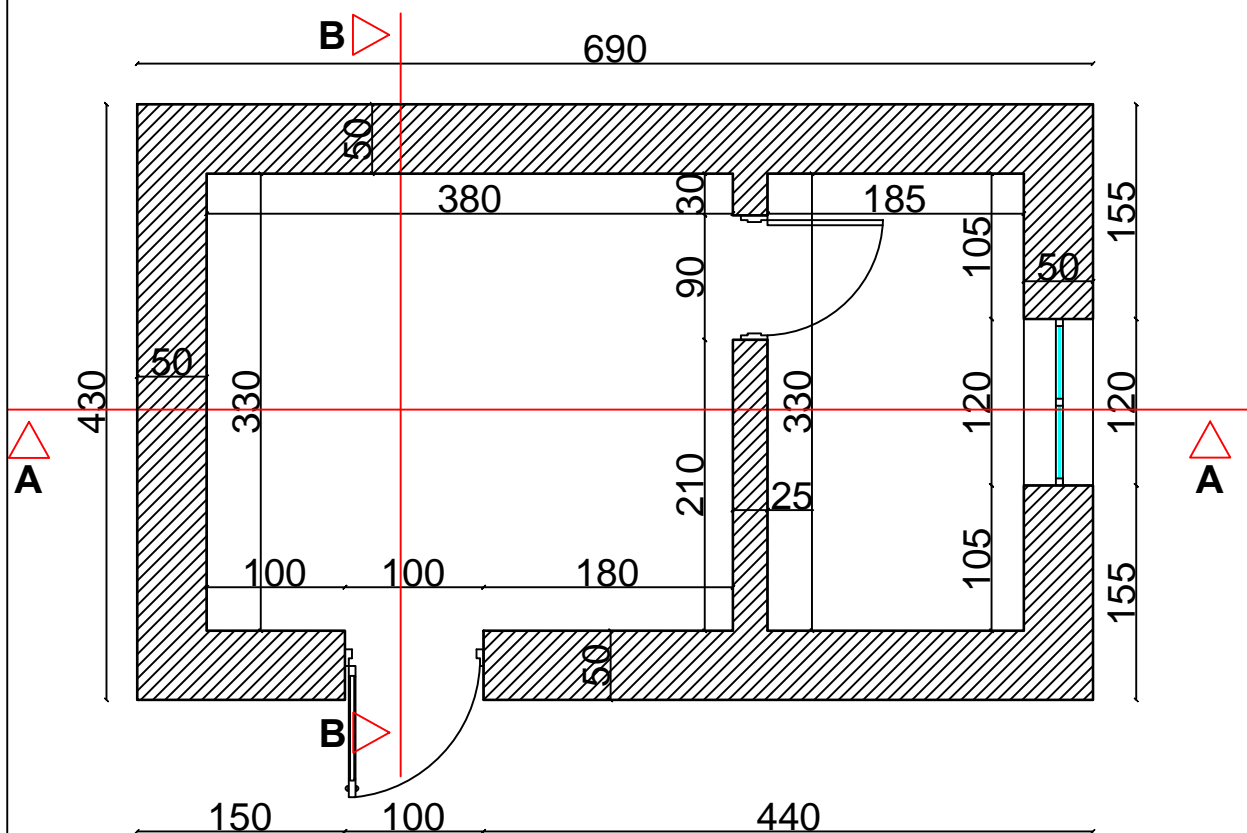

OBJEKTI: RIKONSTRUKSION SHTEPI BANI
FAMILJA: VANGJEL SPASE KRISTO

TE DHENATE E PRONESISE

| | | |
|------------------------|---|------------------------|
| NR.PASURIE | - | 92/1 |
| ZONA KADASTRALE | - | 1488 |
| VOLUMI | - | 3 |
| FAQE | - | 101 |
| SIPERFAQE | - | 60M² |



REPUBLIKA E SHQIPERISE
BASHKIA PUSTEC
 SEKTTORI I URBANISTIKES

MIRATOI
KRYETARI I BASHKISE
PALI KOLEFSKI

AUTORET E PROJEKTIT

ARKITEKT: PAOLO ROPI
TOPOGRAF: VASKA ARGJIRI

Objekti: _____RIKONSTRUKSON_____

Emertimi: _____

Data: ___/___/2023

PLANI I KULLIMIT TE UJJRAVE

SH: 1:100

740

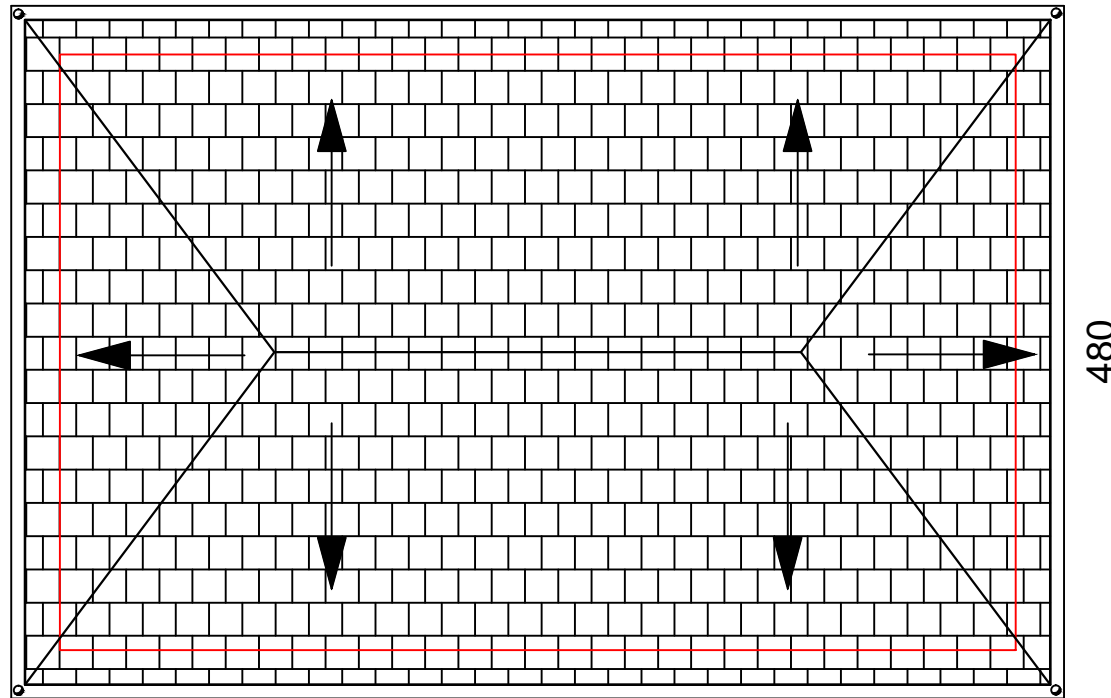

480



REPUBLIKA E SHQIPERISE
BASHKIA PUSTEC
SEKTORI I URBANISTIKES

MIRATOI
KRYETARI I BASHKISE
PALI KOLEFSKI

AUORET E PROJEKTIT

ARKITEKT: PAOLO ROPI
TOPOGRAF: VASKA ARGJIRI

Objekti: _____RIKONSTRUKSON_____

Emertimi: _____

Data: ___/___/2023

PRERJA A-A
SH: 1:100

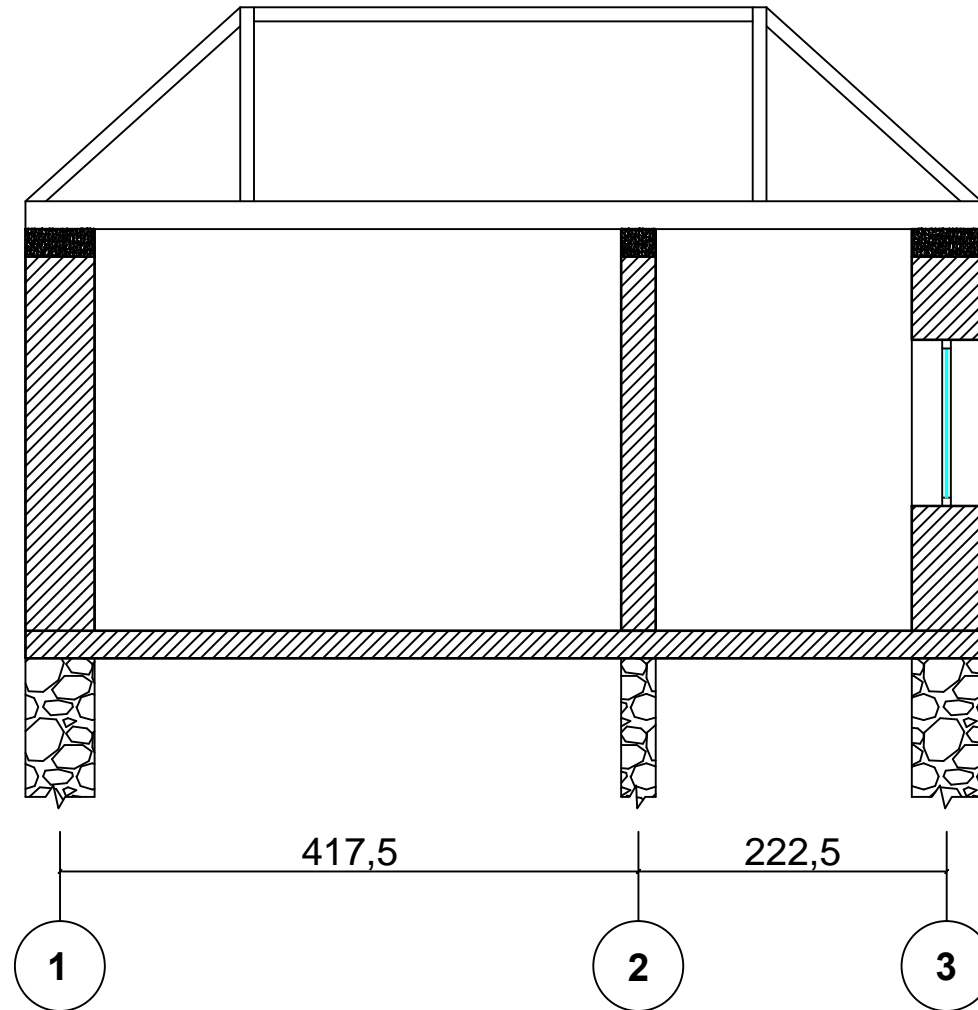

REPUBLIKA E SHQIPERISE
BASHKIA PUSTEC
SEKTTORI I URBANISTIKES

MIRATOI
KRYETARI I BASHKISE
PALI KOLEFSKI

AUTORET E PROJEKTIT

ARKITEKT: PAOLO ROPI
TOPOGRAF: VASKA ARGJIRI

Objekti: _____RIKONSTRUKSON_____

Emertimi: _____

Data: ___/___/2023

PRERJA B-B
SH: 1:100

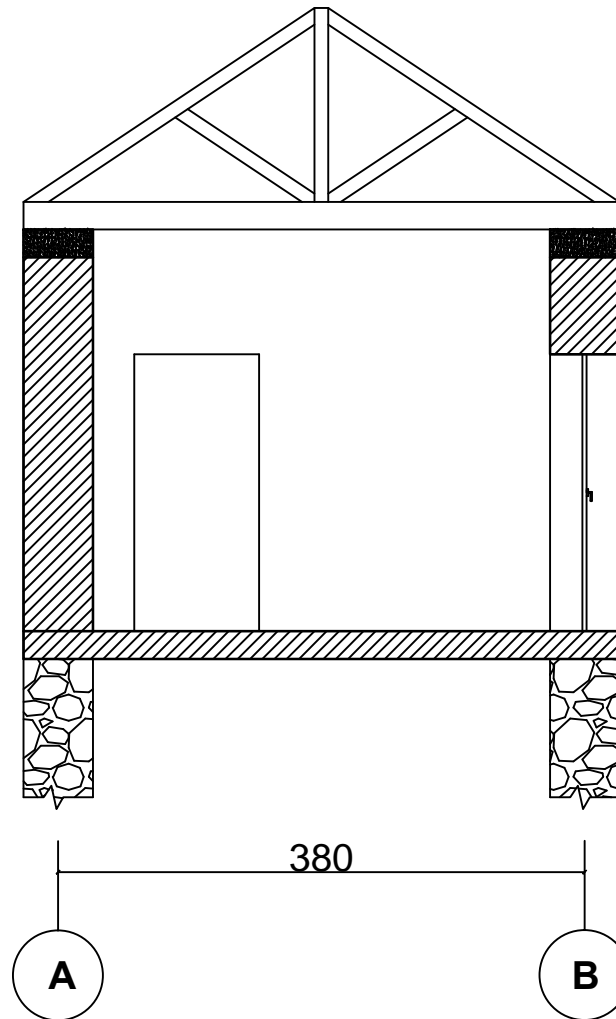

REPUBLIKA E SHQIPERISE
BASHKIA PUSTEC
SEKTORI I URBANISTIKES

MIRATOI
KRYETARI I BASHKISE
PALI KOLEFSKI

AUTORET E PROJEKTIT

ARKITEKT: PAOLO ROPI
TOPOGRAF: VASKA ARGJIRI

Objekti: _____RIKONSTRUKSON_____

Emertimi: _____

Data: ___/___/2023

PLANI I KONSTRUKTIV I CATISE

SH: 1:100

740

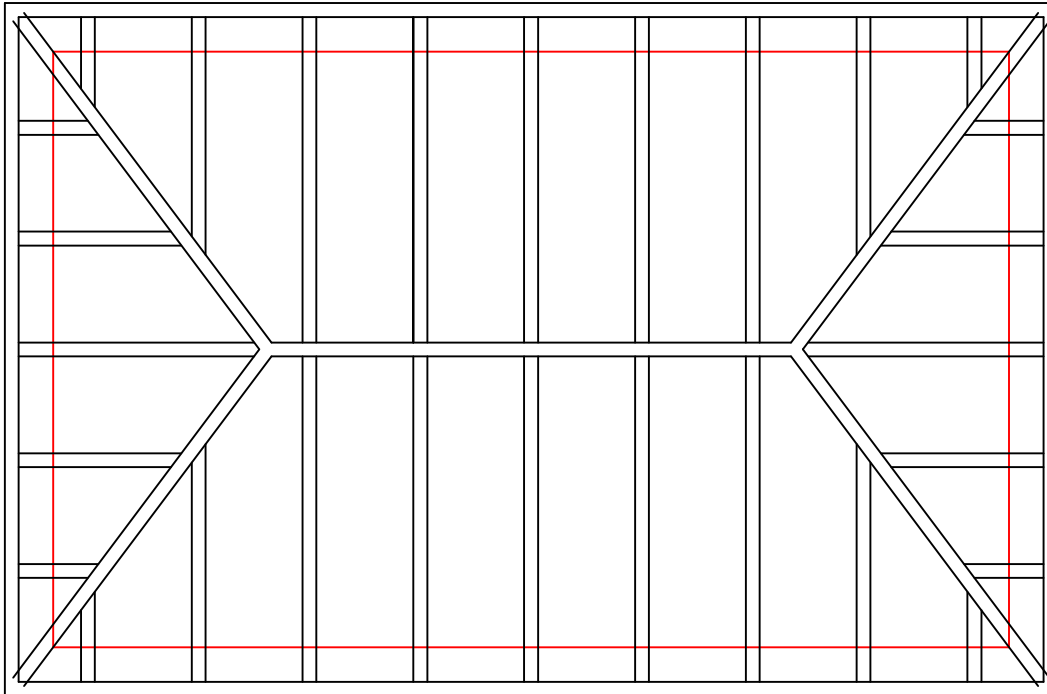

SHPJEGIM TEKNIK

NDERTIMI I CATISE DO REALIZOHET ME
LENDE DRRURI TE SHARRUARTE CILAT
DO TE MBESHTETEN MBI TRARET E
TAVANIT 20X20 CM TE CILAT DO JENE
SHARUAR DHE STAZHONUAR SIMBAS K.T.Z
RISTELAT KU DO MBESHTETEN
TJEGULLAT DO JENE ME PERMASA 5X4CM DHE
DO VENDOSEN CDO 30-35CM SIMBAS
LLOJIT TE TJEGULLES
PERMASAT E MAHIVE DO JENE ME PERMASA
10X8CM DISTANCA E TE CILAVE
DO JENE CDO 80CM
TJEGULLA TE PLANIFIKUARA IMPORTI
TRARET HORIZONTALE DHE KULMORE
JANE TE PERMASAVE 10X10CM
NE DREJTIM GJATESOR DO VENDOSEN
KONDRARENTIME ME PERMASA 10X8
ULLUKET DO JENE LLAMARINE XINGATO



REPUBLIKA E SHQIPERISE
BASHKIA PUSTEC
SEKTTORI I URBANISTIKES

MIRATOI
KRYETARI I BASHKISE
PALI KOLEFSKI

AUORET E PROJEKTIT

ARKITEKT: PAOLO ROPI
TOPOGRAF: VASKA ARGJIRI

Objekti: _____RIKONSTRUKSON_____

Emertimi: _____

Data: ___/___/2023

PLANIMETRI E OBJEKTIT SH: 1:100

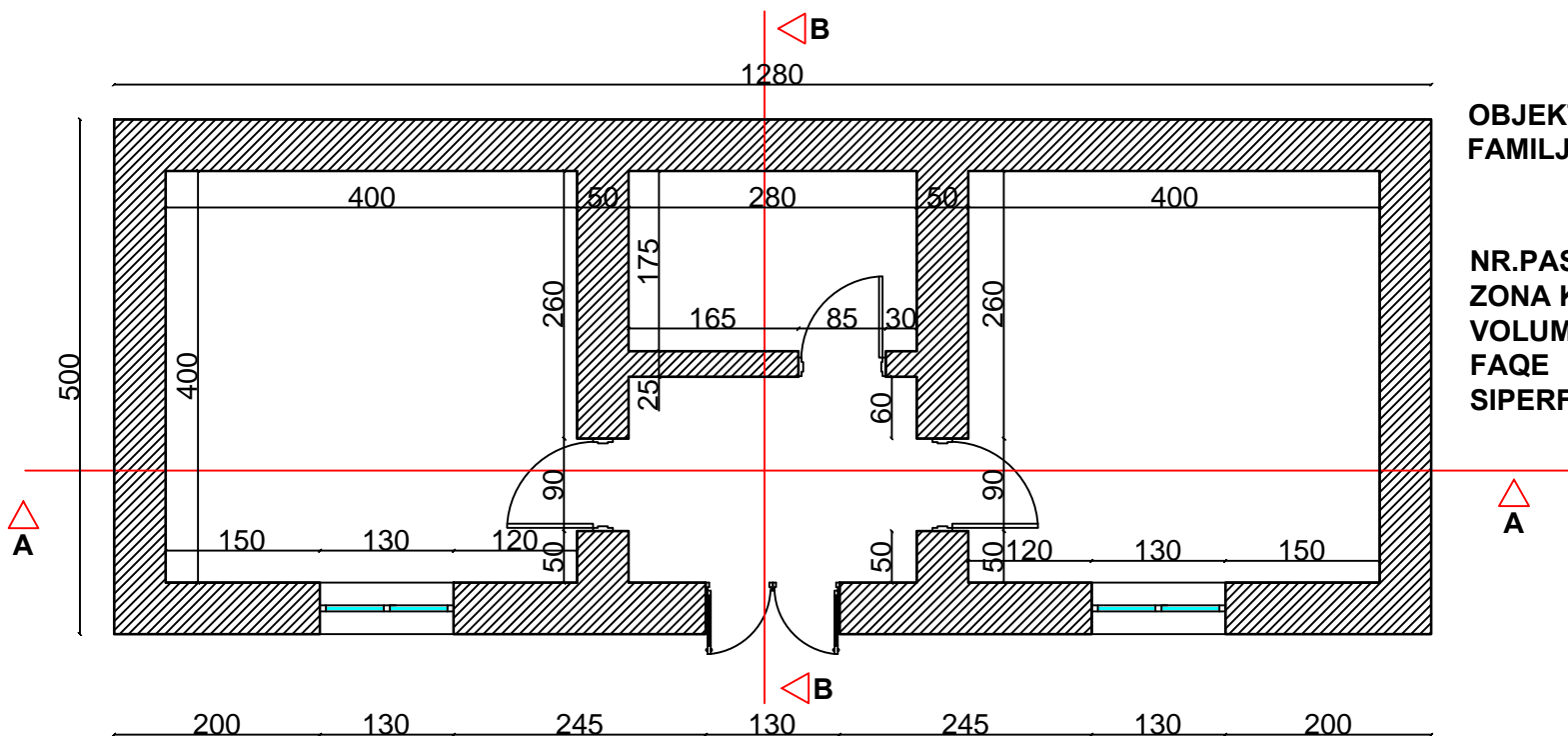

OBJEKTI: RIKONSTRUKSION SHTEPI BANI
FAMILJA: LENA SPIRO VURMO

TE DHENATE E PRONESISE

NR.PASURIE - 152/4
ZONA KADASTRALE - 2045
VOLUMI - 5
FAQE - 148
SIPERFAQE - 70M²



REPUBLIKA E SHQIPERISE
BASHKIA PUSTEC
SEKTTORI I URBANISTIKES

MIRATOI
KRYETARI I BASHKISE
PALI KOLEFSKI

AUTORET E PROJEKTIT

ARKITEKT: PAOLO ROPI
TOPOGRAF: VASKA ARGJIRI

Objekti: _____RIKONSTRUKSON_____

Emertimi: _____

Data: ___/___/2023

PLANI I KULLIMIT TE UJJRAVE
SH: 1:100

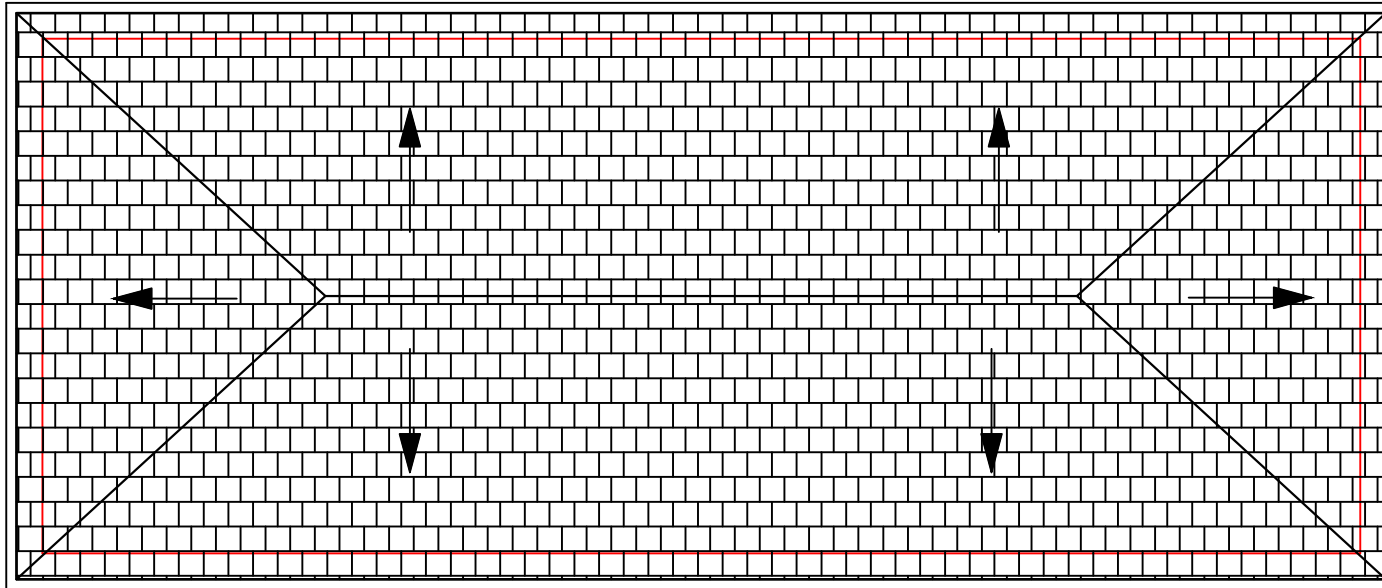

REPUBLIKA E SHQIPERISE
BASHKIA PUSTEC
SEKTORI I URBANISTIKES

MIRATOI
KRYETARI I BASHKISE
PALI KOLEFSKI

AUTORET E PROJEKTIT

ARKITEKT: PAOLO ROPI
TOPOGRAF: VASKA ARGJIRI

Objekti: _____RIKONSTRUKSON_____

Emertimi: _____

Data: ___/___/2023

PRERJA A-A
SH: 1:100

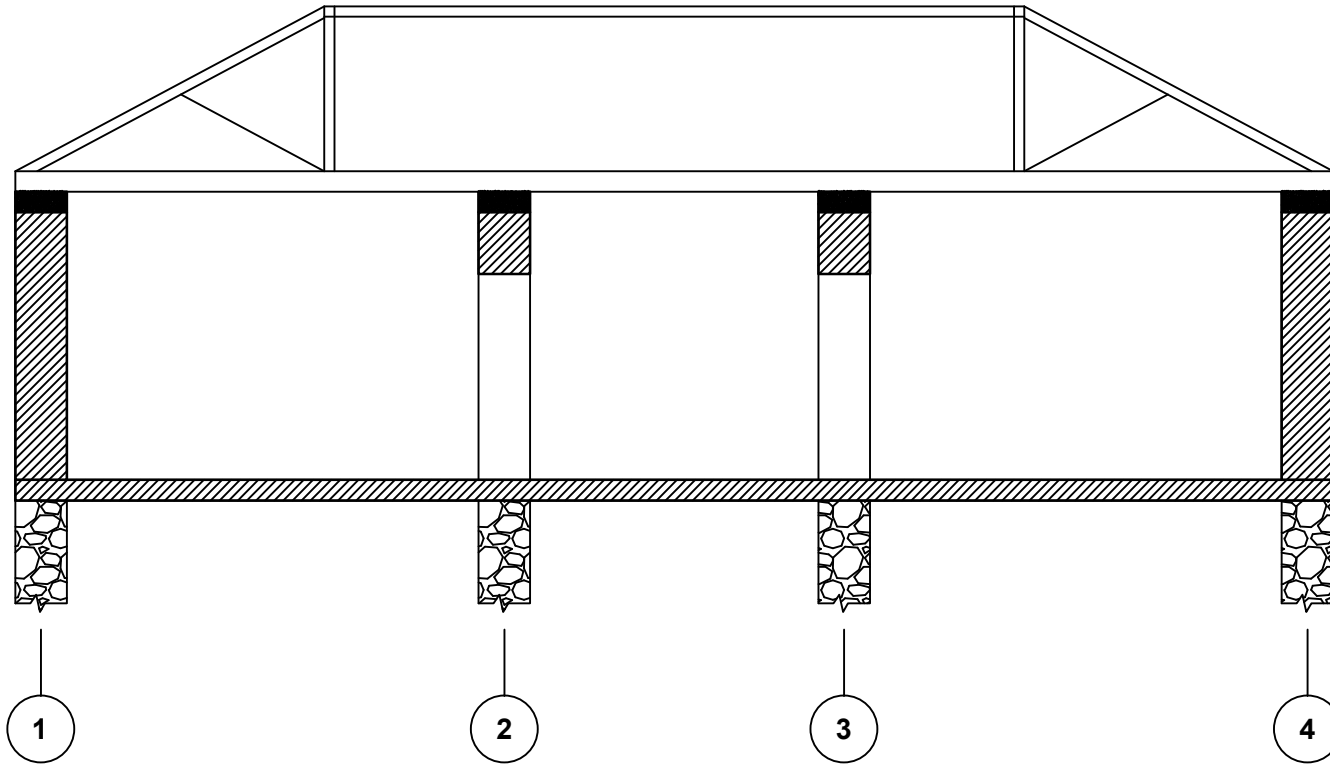

REPUBLIKA E SHQIPERISE
BASHKIA PUSTEC
SEKTORI I URBANISTIKES

MIRATOI
KRYETARI I BASHKISE
PALI KOLEFSKI

AUTORET E PROJEKTIT

ARKITEKT: PAOLO ROPI
TOPOGRAF: VASKA ARGJIRI

Objekti: _____RIKONSTRUKSON_____

Emertimi: _____

Data: ___/___/2023

PRERJA B-B
SH: 1:100

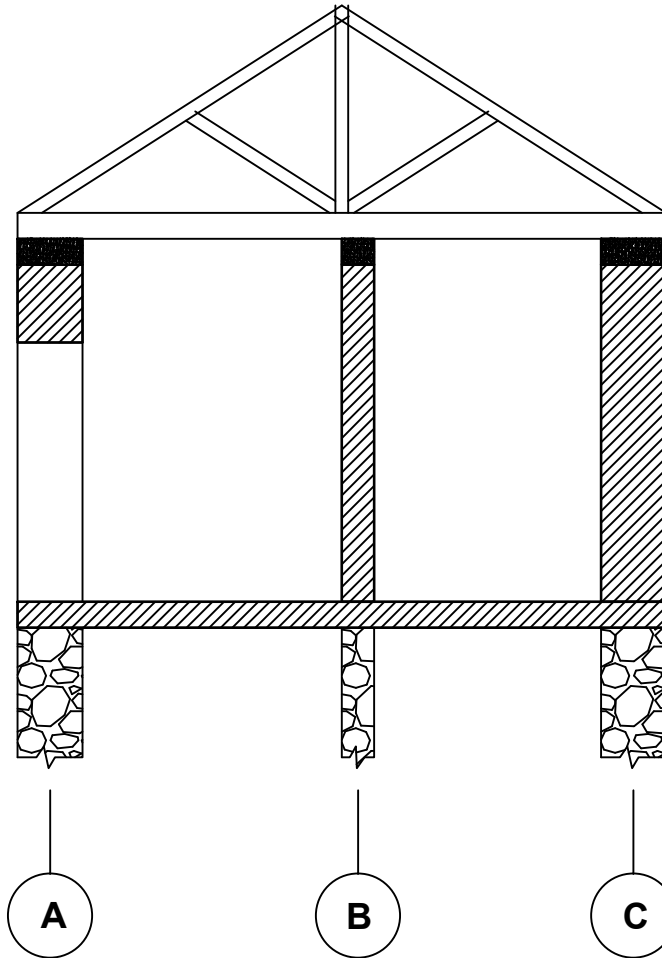

REPUBLIKA E SHQIPERISE
BASHKIA PUSTEC
SEKTORI I URBANISTIKES

MIRATOI
KRYETARI I BASHKISE
PALI KOLEFSKI

AUTORET E PROJEKTIT

ARKITEKT: PAOLO ROPI
TOPOGRAF: VASKA ARGJIRI

Objekti: _____RIKONSTRUKSON_____

Emertimi: _____

Data: ___/___/2023

PLANI I KONSTRUKTIV I CATISE
SH: 1:100

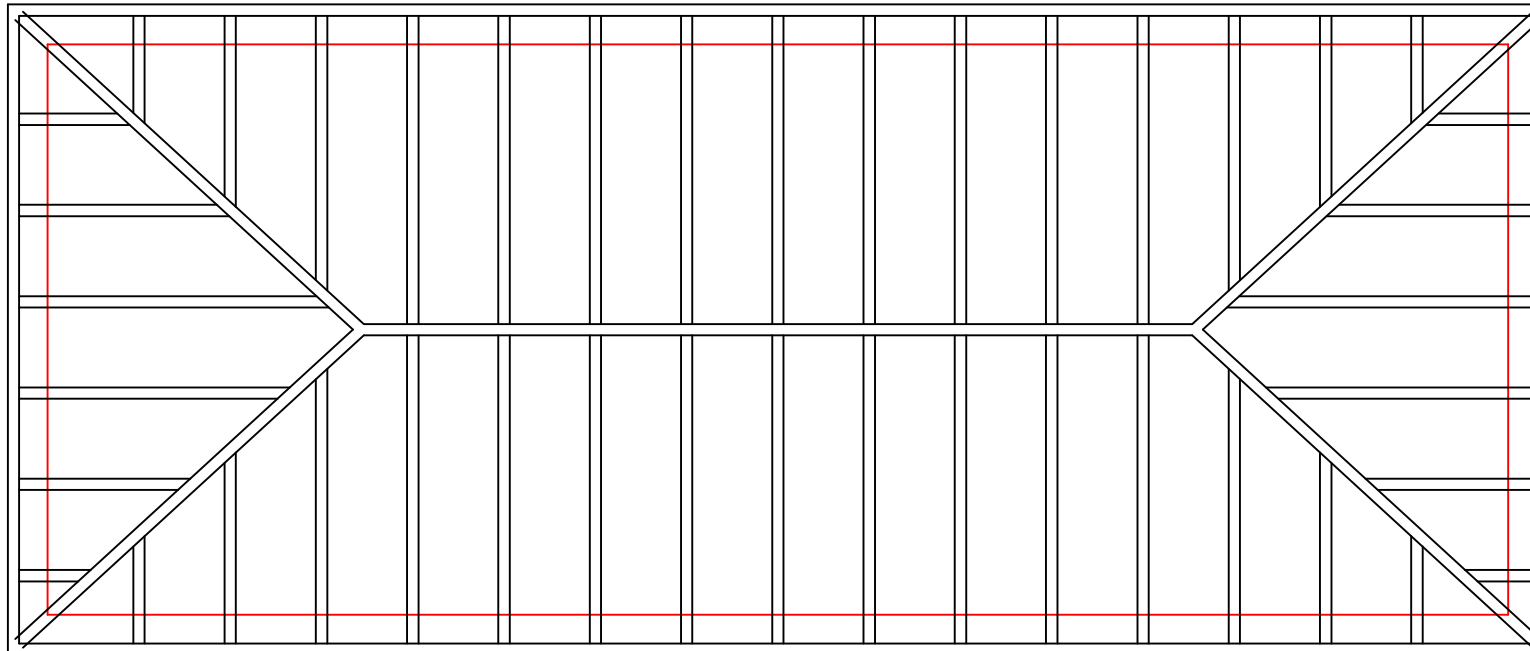

SHPJEGIM TEKNIK

NDERTIMI I CATISE DO REALIZOHET ME
LENDE DRRURI TE SHARRUARTE CILAT
DO TE MBESHTETEN MBI TRARET E
TAVANIT 20X20 CM TE CILAT DO JENE
SHARUAR DHE STAZHONUAR SIMBAS K.T.Z
RISTELAT KU DO MBESHTETEN
TJEGULLAT DO JENE ME PERMASA 5X4CM DH
DO VENDOSEN CDO 30-35CM SIMBAS
LLOJIT TE TJEGULLES
PERMASAT E MAHIVE DO JENE ME PERMASA
10X8CM DISTANCA E TE CILAVE
DO JENE CDO 80CM
TJEGULLA TE PLANIFIKUARA IMPORTI
TRARET HORIZONTALE DHE KULMORE
JANE TE PERMASAVE 10X10CM
NE DREJTIM GJATESOR DO VENDOSEN
KONDRAVENTIME ME PERMASA 10X8
ULLUKET DO JENE LLAMARINE XINGATO



REPUBLIKA E SHQIPERISE
BASHKIA PUSTEC
SEKTTORI I URBANISTIKES

MIRATOI
KRYETARI I BASHKISE
PALI KOLEFSKI

AUTORET E PROJEKTIT

ARKITEKT: PAOLO ROPI
TOPOGRAF: VASKA ARGJIRI

Objekti: _____RIKONSTRUKSON_____

Emertimi: _____

Data: ___/___/2023

PLANIMETRI E OBJEKTIT SH: 1:100

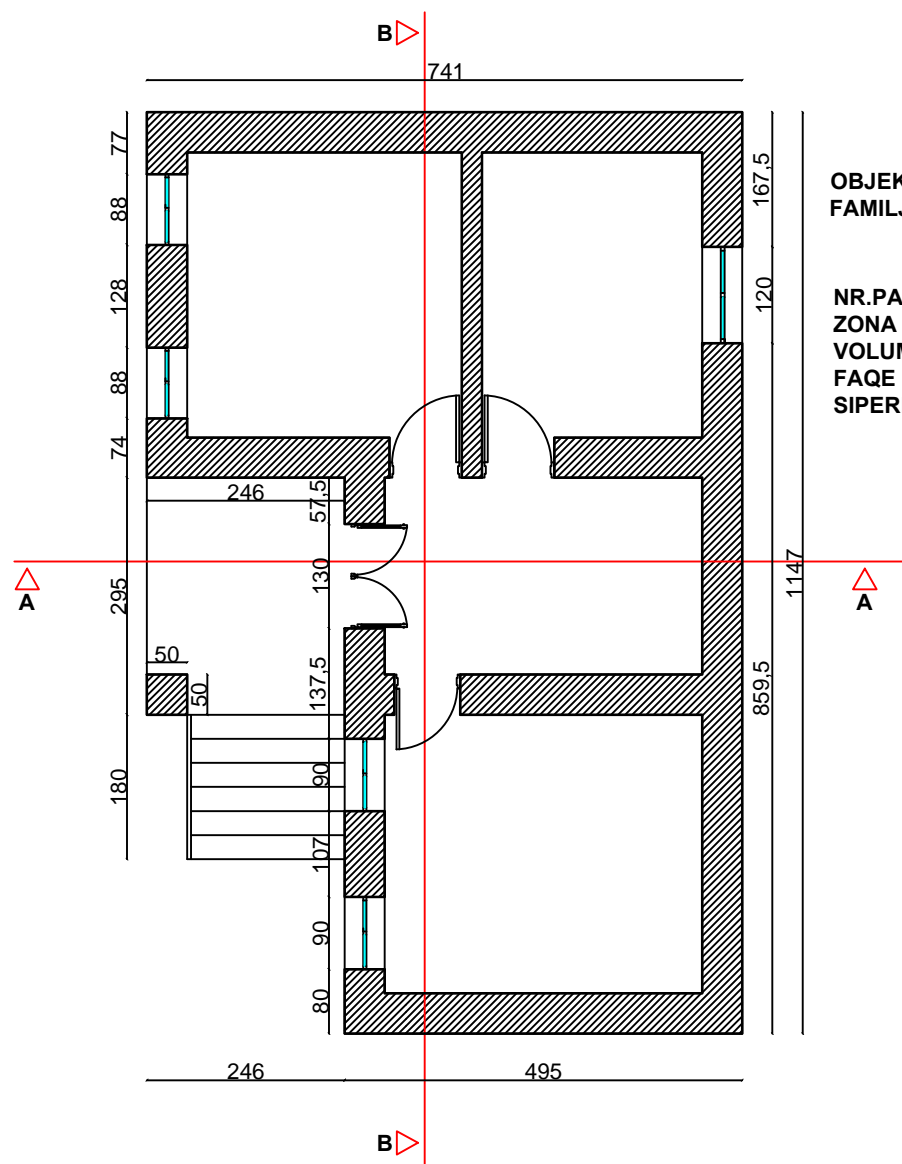

OBJEKTI: RIKONSTRUKSION SHTEPI BANIMI
 FAMILJA: LUBICA SIMON

TE DHENATE E PRONESISE

NR.PASURIE - 80/8
 ZONA KADASTRALE - 1488
 VOLUMI - 3
 FAQE - 9
 SIPERFAQE - 80M²



REPUBLIKA E SHQIPERISE
 BASHKIA PUSTEC
 SEKTTORI I URBANISTIKES

MIRATOI
 KRYETARI I BASHKISE
 PALI KOLEFSKI

AUTORET E PROJEKTIT

ARKITEKT: PAOLO ROPI
 TOPOGRAF: VASKA ARGJIRI

Objekti: _____RIKONSTRUKSON_____

Emertimi: _____

Data: ___/___/2023

PLANI I KULLIMIT TE UJJRAVE
SH: 1:100

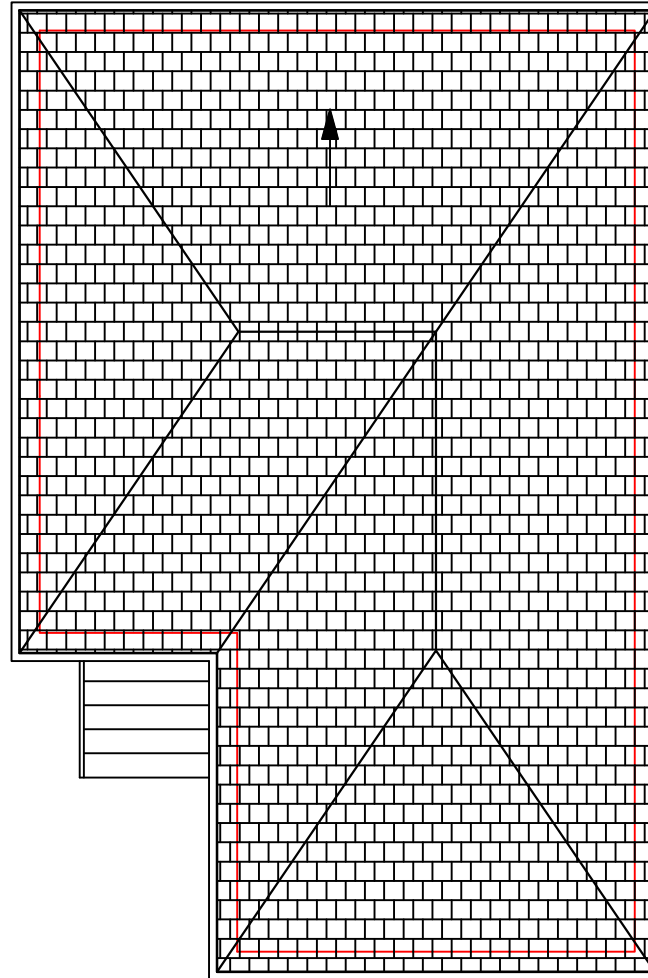

REPUBLIKA E SHQIPERISE
BASHKIA PUSTEC
SEKTORI I URBANISTIKES

MIRATOI
KRYETARI I BASHKISE
PALI KOLEFSKI

AUTORET E PROJEKTIT

ARKITEKT: PAOLO ROPI
TOPOGRAF: VASKA ARGJIRI

Objekti: _____RIKONSTRUKSON_____

Emertimi: _____

Data: ___/___/2023

PLANI I KONSTRUKTIV I CATISE
SH: 1:100

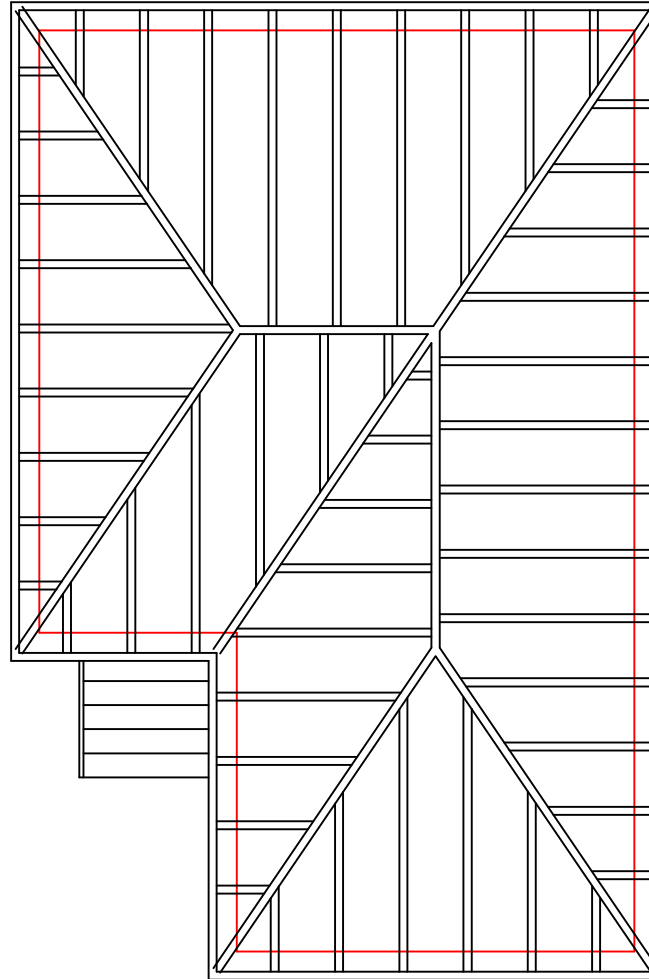

REPUBLIKA E SHQIPERISE
BASHKIA PUSTEC
SEKTORI I URBANISTIKES

MIRATOI
KRYETARI I BASHKISE
PALI KOLEFSKI

AUTORET E PROJEKTIT

ARKITEKT: PAOLO ROPI
TOPOGRAF: VASKA ARGJIRI

Objekti: _____RIKONSTRUKSON_____

Emertimi: _____

Data: ___/___/2023

PRERJA B-B
SH: 1:100

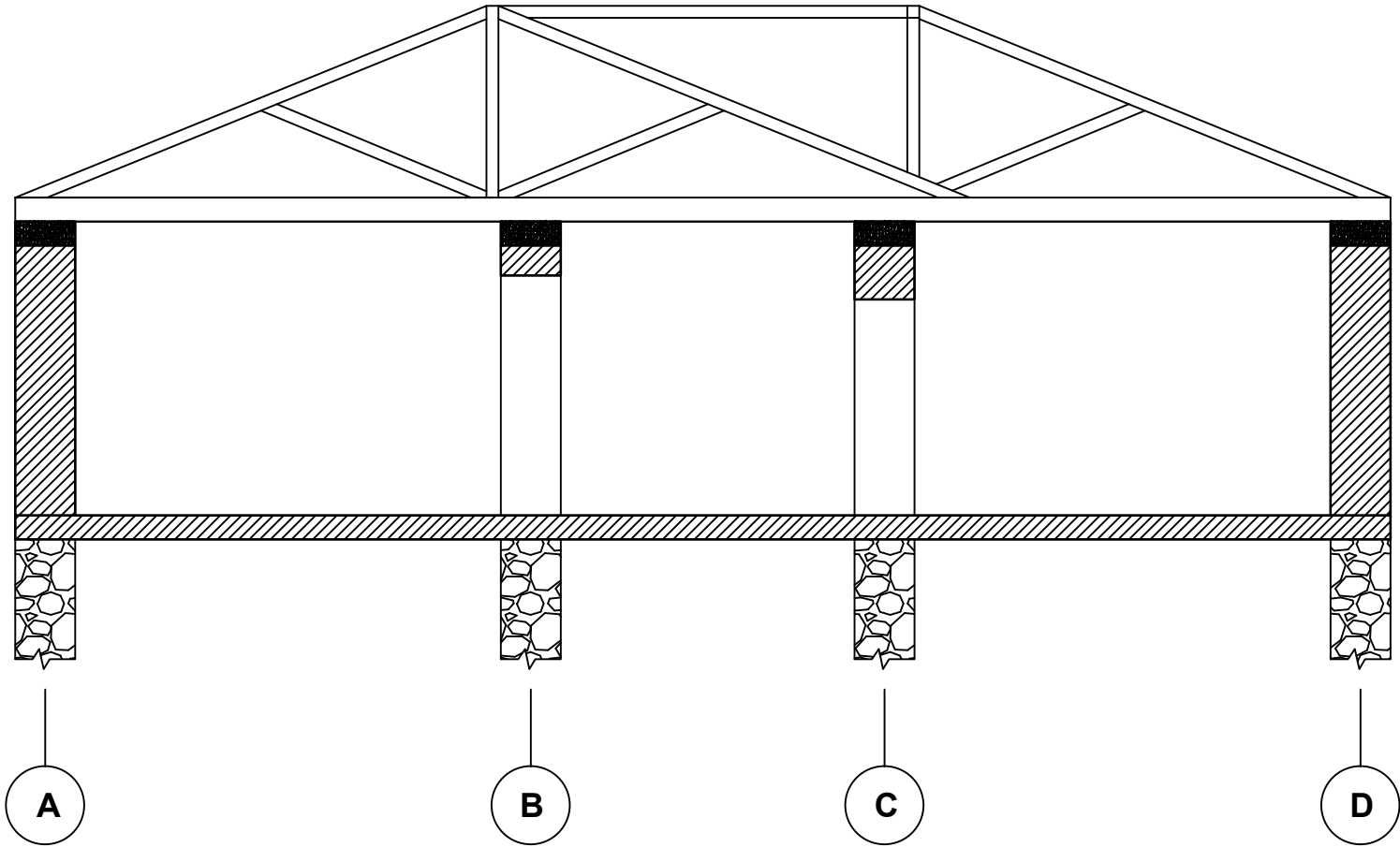

REPUBLIKA E SHQIPERISE
BASHKIA PUSTEC
SEKTORI I URBANISTIKES

MIRATOI
KRYETARI I BASHKISE
PALI KOLEFSKI

AUTORET E PROJEKTIT

ARKITEKT: PAOLO ROPI
TOPOGRAF: VASKA ARGJIRI

Objekti: _____RIKONSTRUKSON_____

Emertimi: _____

Data: ___/___/2023

PRERJA A-A
SH: 1:100

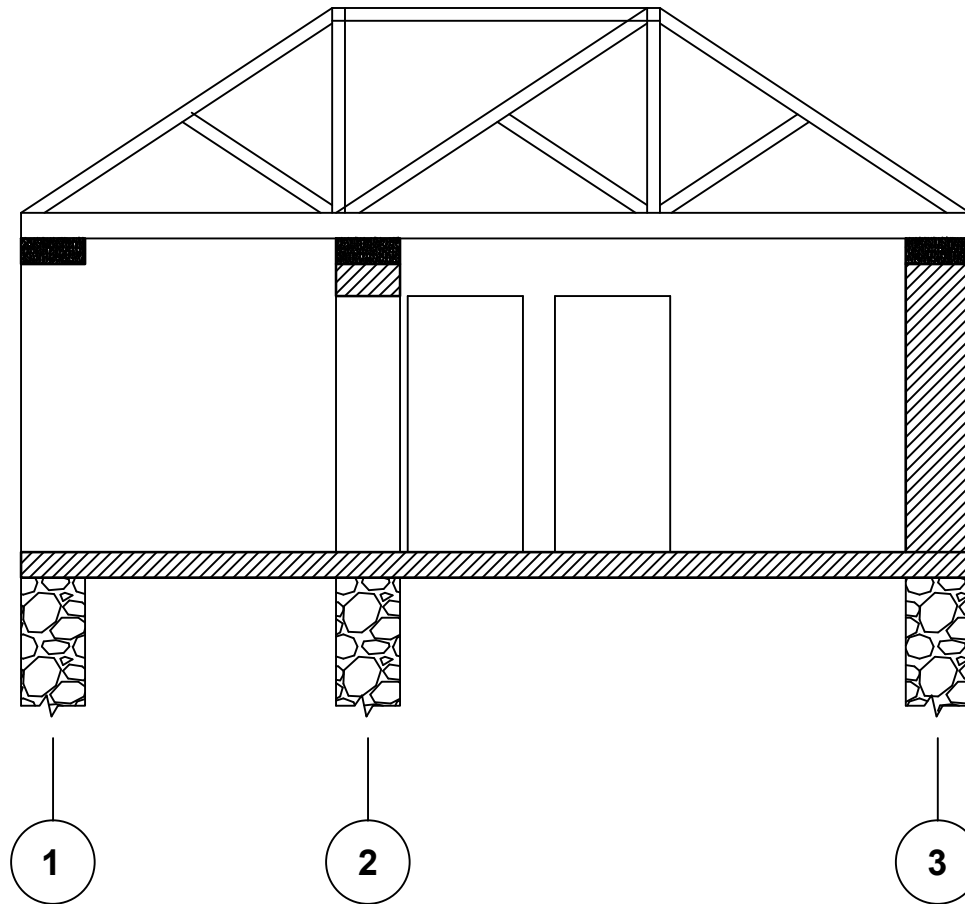

REPUBLIKA E SHQIPERISE
BASHKIA PUSTEC
SEKTORI I URBANISTIKES

MIRATOI
KRYETARI I BASHKISE
PALI KOLEFSKI

AUTORET E PROJEKTIT

ARKITEKT: PAOLO ROPI
TOPOGRAF: VASKA ARGJIRI

Objekti: _____RIKONSTRUKSON_____

Emertimi: _____

Data: ___/___/2023

PLANIMETRI E OBJEKTIT SH: 1:100

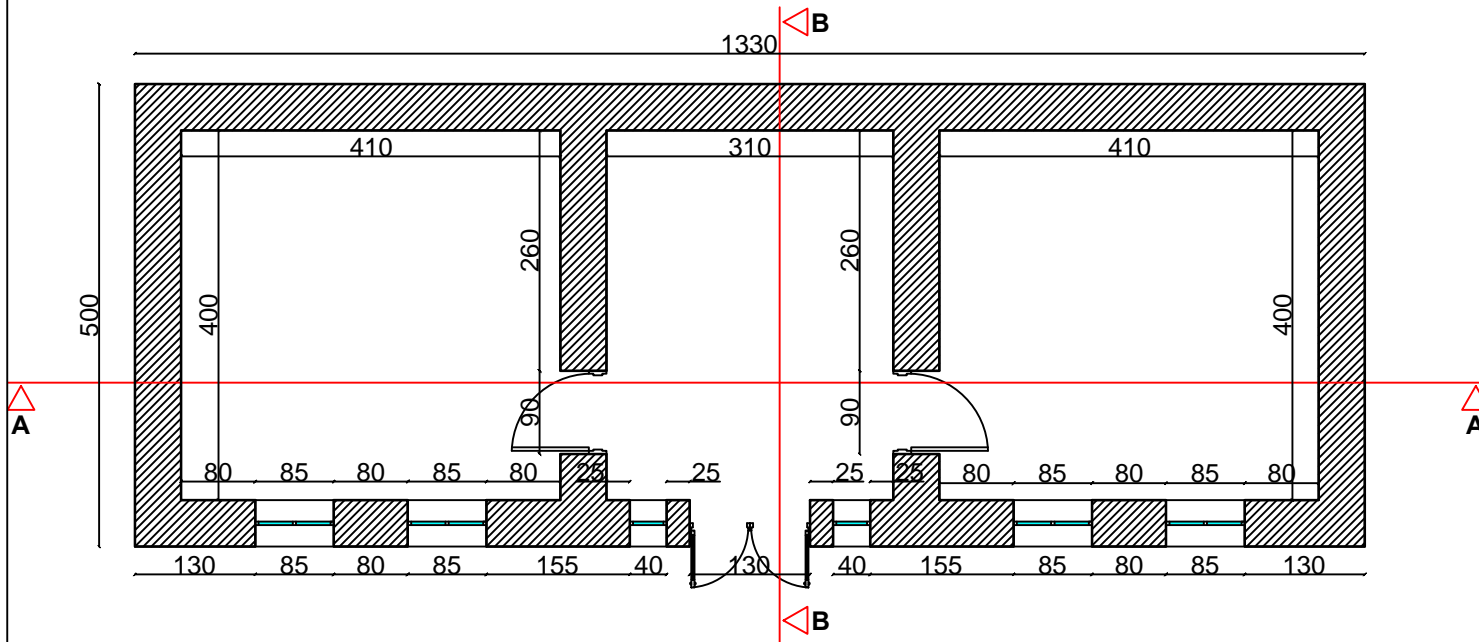

OBJEKTI: RIKONSTRUKSION SHTEPI BANIMI
FAMILJA: ATINKA XHAVO

TE DHENATE E PRONESISE

NR.PASURIE - 288/21
ZONA KADASTRALE - 2462
VOLUMI - 14
FAQE - 168
SIPERFAQE - 70M²



REPUBLIKA E SHQIPERISE
BASHKIA PUSTEC
SEKTTORI I URBANISTIKES

MIRATOI
KRYETARI I BASHKISE
PALI KOLEFSKI

AUTORET E PROJEKTIT

ARKITEKT: PAOLO ROPI
TOPOGRAF: VASKA ARGJIRI

Objekti: _____RIKONSTRUKSON_____

Emertimi: _____

Data: ___/___/2023

PLANI I KULLIMIT TE UJJRAVE
SH: 1:100

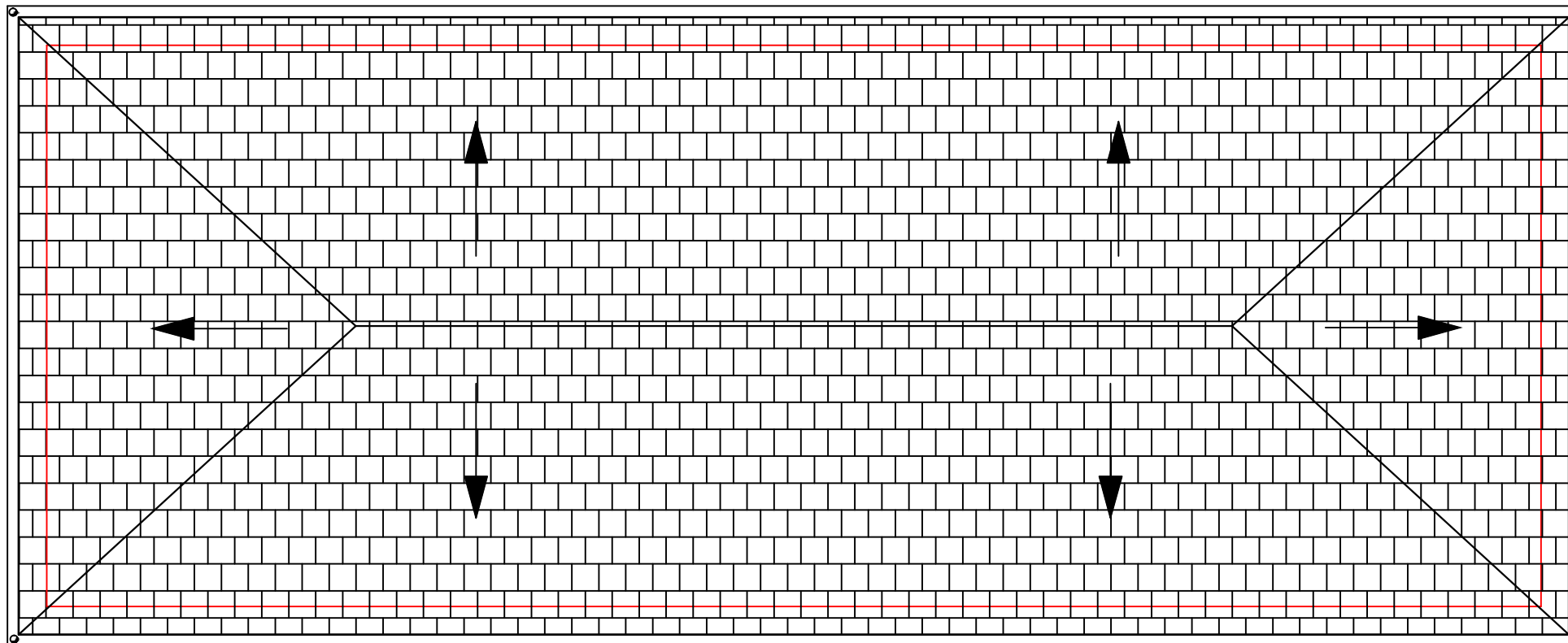

REPUBLIKA E SHQIPERISE
BASHKIA PUSTEC
SEKTTORI I URBANISTIKES

MIRATOI
KRYETARI I BASHKISE
PALI KOLEFSKI

AUTORET E PROJEKTIT

ARKITEKT: PAOLO ROPI
TOPOGRAF: VASKA ARGJIRI

Objekti: RIKONSTRUKSON

Emertimi: _____

Data: ___/___/2023

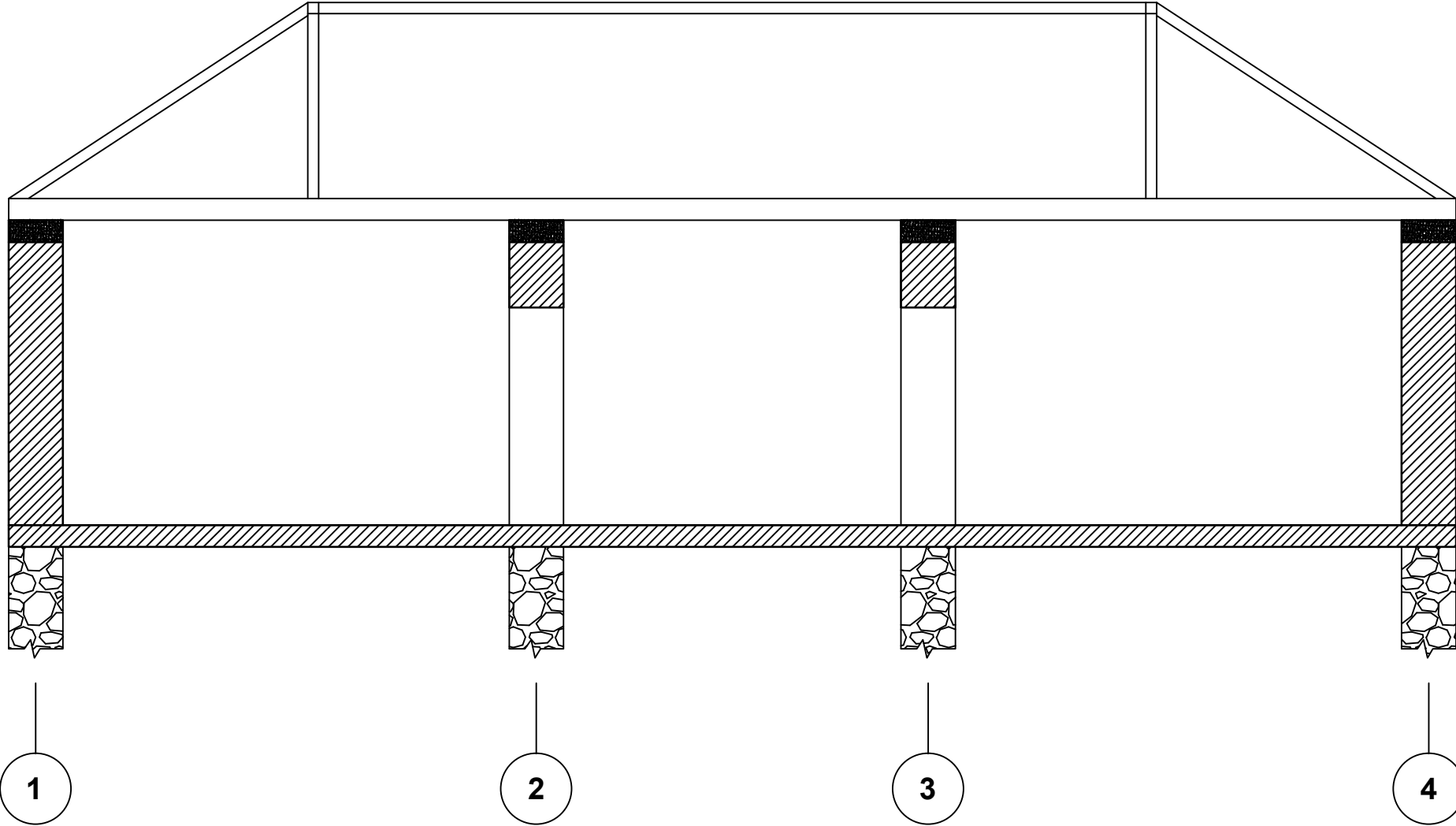

REPUBLIKA E SHQIPERISE
 BASHKIA PUSTEC
 SEKTTORI I URBANISTIKES

MIRATOI
 KRYETARI I BASHKISE
 PALI KOLEFSKI

AUTORET E PROJEKTIT

ARKITEKT: PAOLO ROPI
 TOPOGRAF: VASKA ARGJIRI

Objekti: _____RIKONSTRUKSON_____

Emertimi: _____

Data: __/__/2023

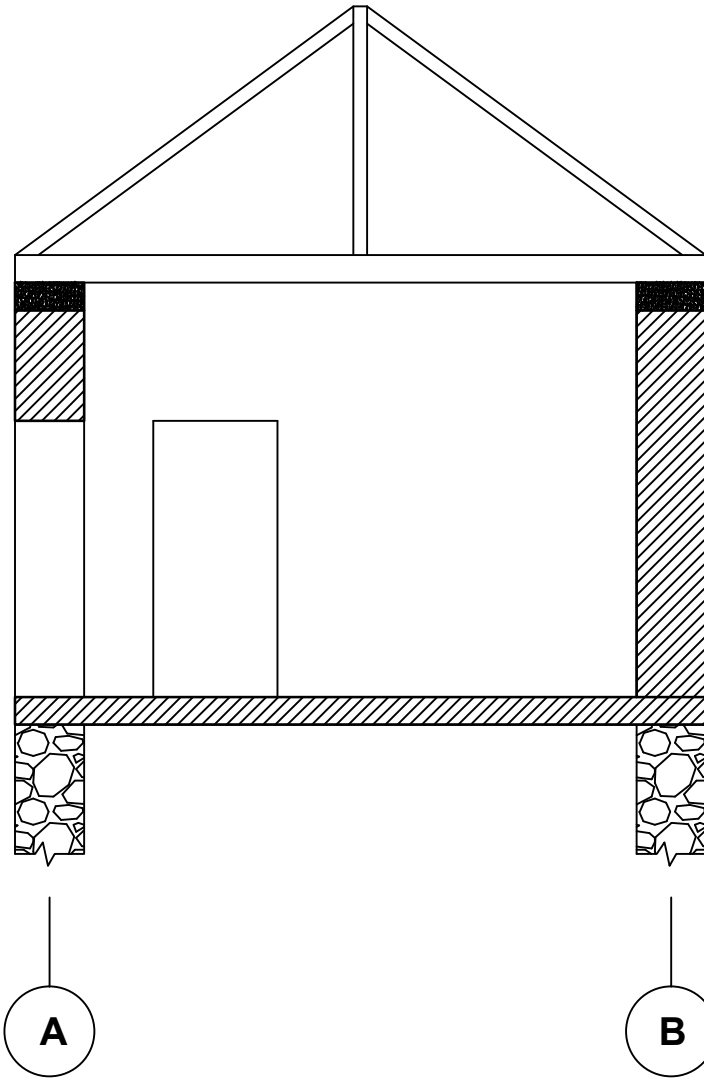

REPUBLIKA E SHQIPERISE
BASHKIA PUSTEC
 SEKTTORI I URBANISTIKES

MIRATOI
 KRYETARI I BASHKISE
 PALI KOLEFSKI

AUTORET E PROJEKTIT

ARKITEKT: PAOLO ROPI
 TOPOGRAF: VASKA ARGJIRI

Objekti: _____RIKONSTRUKSON_____

Emertimi: _____

Data: __/__/2023

PLANI I KONSTRUKTIV I CATISE
SH: 1:100

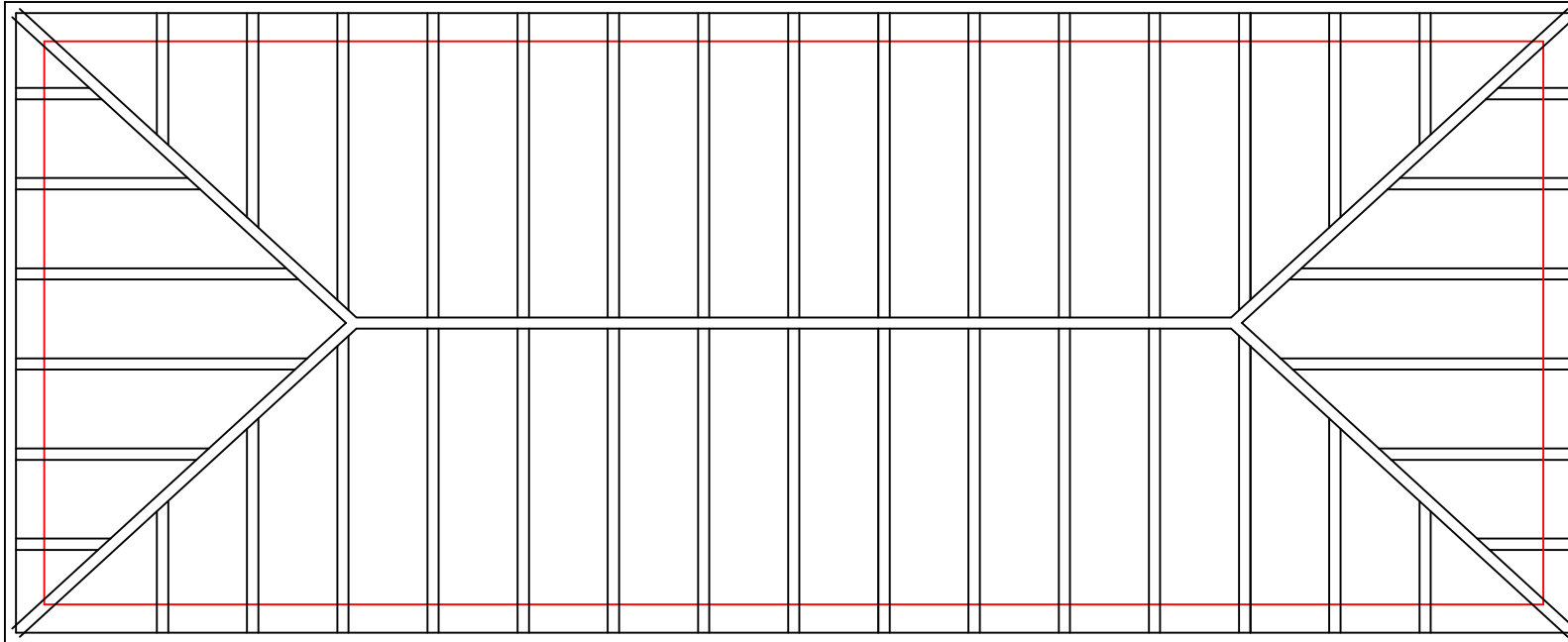

SHPJEGIM TEKNIK

NDERTIMI I CATISE DO REALIZOHET ME
LENDE DRRURI TE SHARRUARTE CILAT
DO TE MBESHTEHEN MBI TRARET E
TAVANIT 20X20 CM TE CILAT DO JENE
SHARUAR DHE STAZHONUAR SIMBAS K.T.Z
RISTELAT KU DO MBESHTEHEN
TJEGULLAT DO JENE ME PERMASA 5X4CM DHE
DO VENDOSEN CDO 30-35CM SIMBAS
LLOJIT TE TJEGULLES
PERMASAT E MAHIVE DO JENE ME PERMASA
10X8CM DISTANCA E TE CILAVE
DO JENE CDO 80CM
TJEGULLA TE PLANIFIKUARA IMPORTI
TRARET HORIZONTALE DHE KULMORE
JANE TE PERMASAVE 10X10CM
NE DREJTIM GJATESOR DO VENDOSEN
KONDRARENTIME ME PERMASA 10X8
ULLUKET DO JENE LLAMARINE XINGATO



REPUBLIKA E SHQIPERISE
BASHKIA PUSTEC
SEKTTORI I URBANISTIKES

MIRATOI
KRYETARI I BASHKISE
PALI KOLEFSKI

AUORET E PROJEKTIT

ARKITEKT: PAOLO ROPI
TOPOGRAF: VASKA ARGJIRI

Objekti: _____RIKONSTRUKSON_____

Emertimi: _____

Data: ___/___/2023

PLANIMETRI E OBJEKTIT SH: 1:100

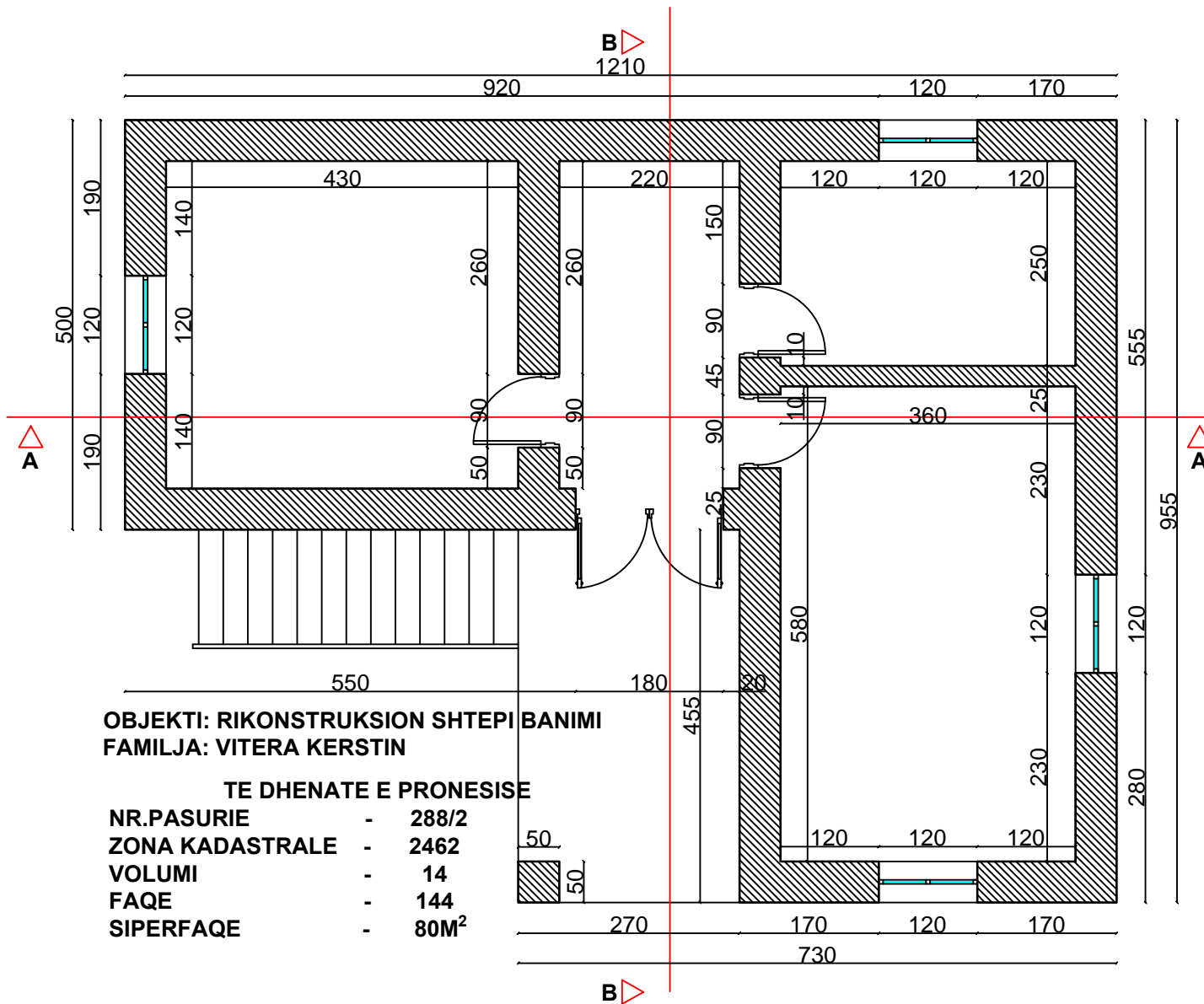

OBJEKTI: RIKONSTRUKSION SHTEPI BANIMI
 FAMILJA: VITERA KERSTIN

TE DHENATE E PRONESISE

| | | |
|-----------------|---|------------------|
| NR.PASURIE | - | 288/2 |
| ZONA KADASTRALE | - | 2462 |
| VOLUMI | - | 14 |
| FAQE | - | 144 |
| SIPERFAQE | - | 80M ² |



REPUBLIKA E SHQIPERISE
 BASHKIA PUSTEC
 SEKTTORI I URBANISTIKES

MIRATOI
 KRYETARI I BASHKISE
 PALI KOLEFSKI

AUTORET E PROJEKTIT

ARKITEKT: PAOLO ROPI
 TOPOGRAF: VASKA ARGJIRI

Objekti: _____RIKONSTRUKSON_____

Emertimi: _____

Data: ___/___/2023

PLANI I KONSTRUKTIV I CATISE
SH: 1:100

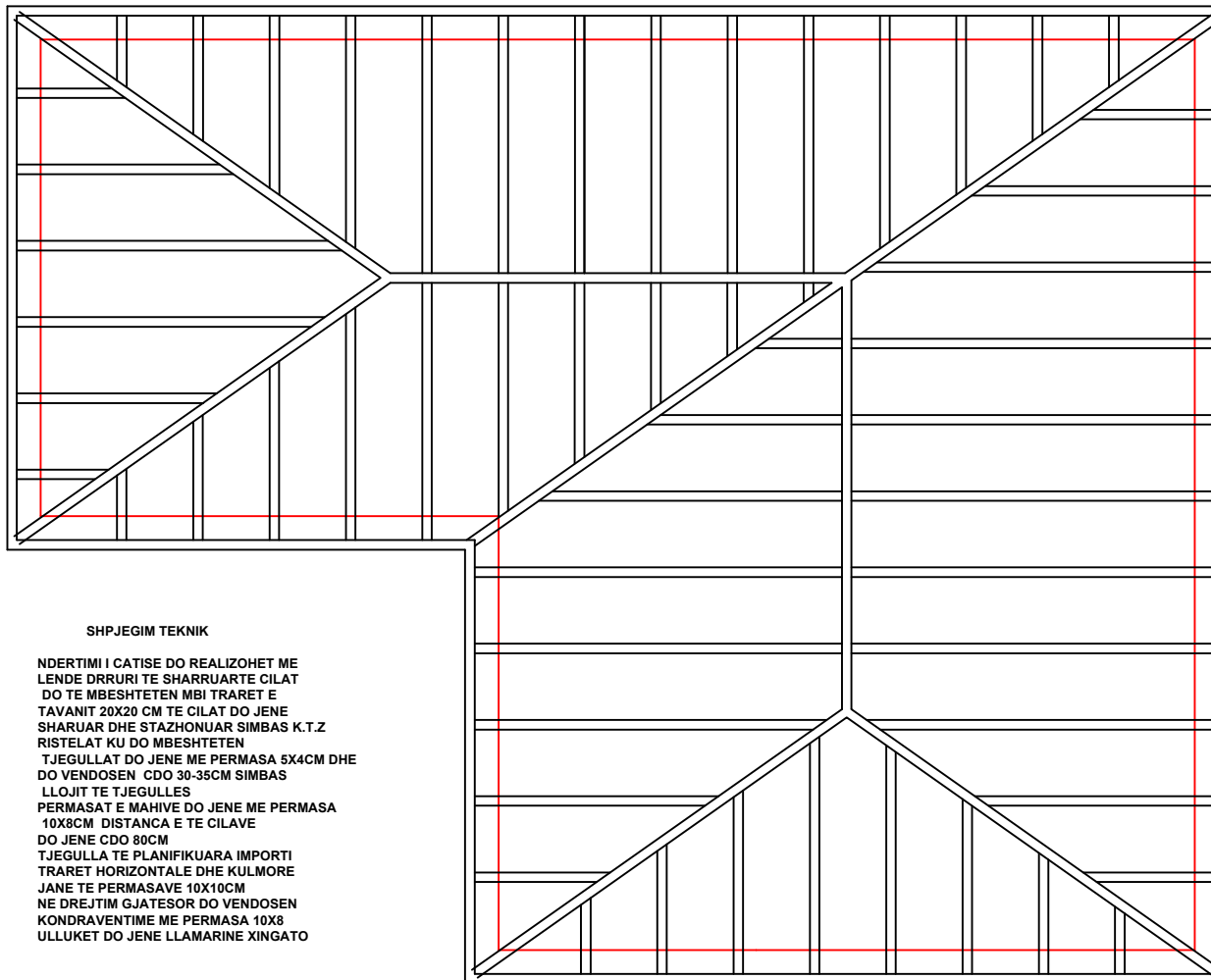

SHPJEGIM TEKNIK

NDERTIMI I CATISE DO REALIZOHET ME
LENDE DRRURI TE SHARRUARTE CILAT
DO TE MBESHTEHEN MBI TRARET E
TAVANIT 20X20 CM TE CILAT DO JENE
SHARUAR DHE STAZHONUAR SIMBAS K.T.Z
RISTELAT KU DO MBESHTEHEN
TJEGULLAT DO JENE ME PERMASA 5X4CM DHE
DO VENDOSEN CDO 30-35CM SIMBAS
LLOJIT TE TJEGULLES
PERMASAT E MAHIVE DO JENE ME PERMASA
10X8CM DISTANCA E TE CILAVE
DO JENE CDO 80CM
TJEGULLA TE PLANIFIKUARA IMPORTI
TRARET HORIZONTALE DHE KULMORE
JANE TE PERMASAVE 10X10CM
NE DREJTIM GJATESOR DO VENDOSEN
KONDRAVENTIME ME PERMASA 10X8
ULLUKET DO JENE LLAMARINE XINGATO



REPUBLIKA E SHQIPERISE
BASHKIA PUSTEC
SEKTORI I URBANISTIKES

MIRATOI
KRYETARI I BASHKISE
PALI KOLEFSKI

AUOTRET E PROJEKITIT

ARKITEKT: PAOLO ROPI
TOPOGRAF: VASKA ARGJIRI

Objekti: _____RIKONSTRUKSON_____

Emertimi: _____

Data: ___/___/2023

PLANI I KULLIMIT TE UJJRAVE
SH: 1:100

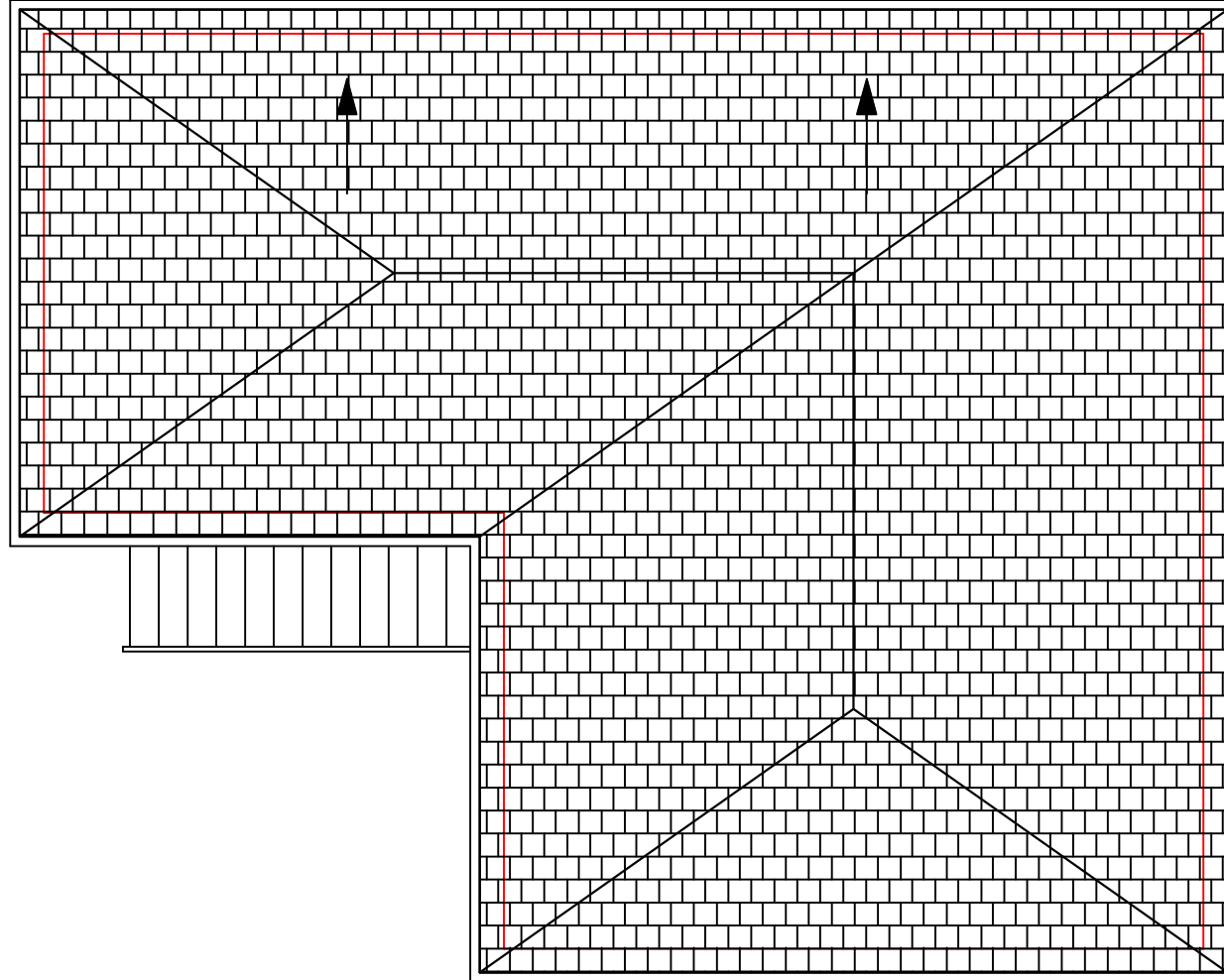

REPUBLIKA E SHQIPERISE
BASHKIA PUSTEC
SEKTORI I URBANISTIKES

MIRATOI
KRYETARI I BASHKISE
PALI KOLEFSKI

AUTORET E PROJEKTIT

ARKITEKT: PAOLO ROPI
TOPOGRAF: VASKA ARGJIRI

Objekti: _____RIKONSTRUKSON_____

Emertimi: _____

Data: ___/___/2023

PRERJA A-A
SH: 1:100

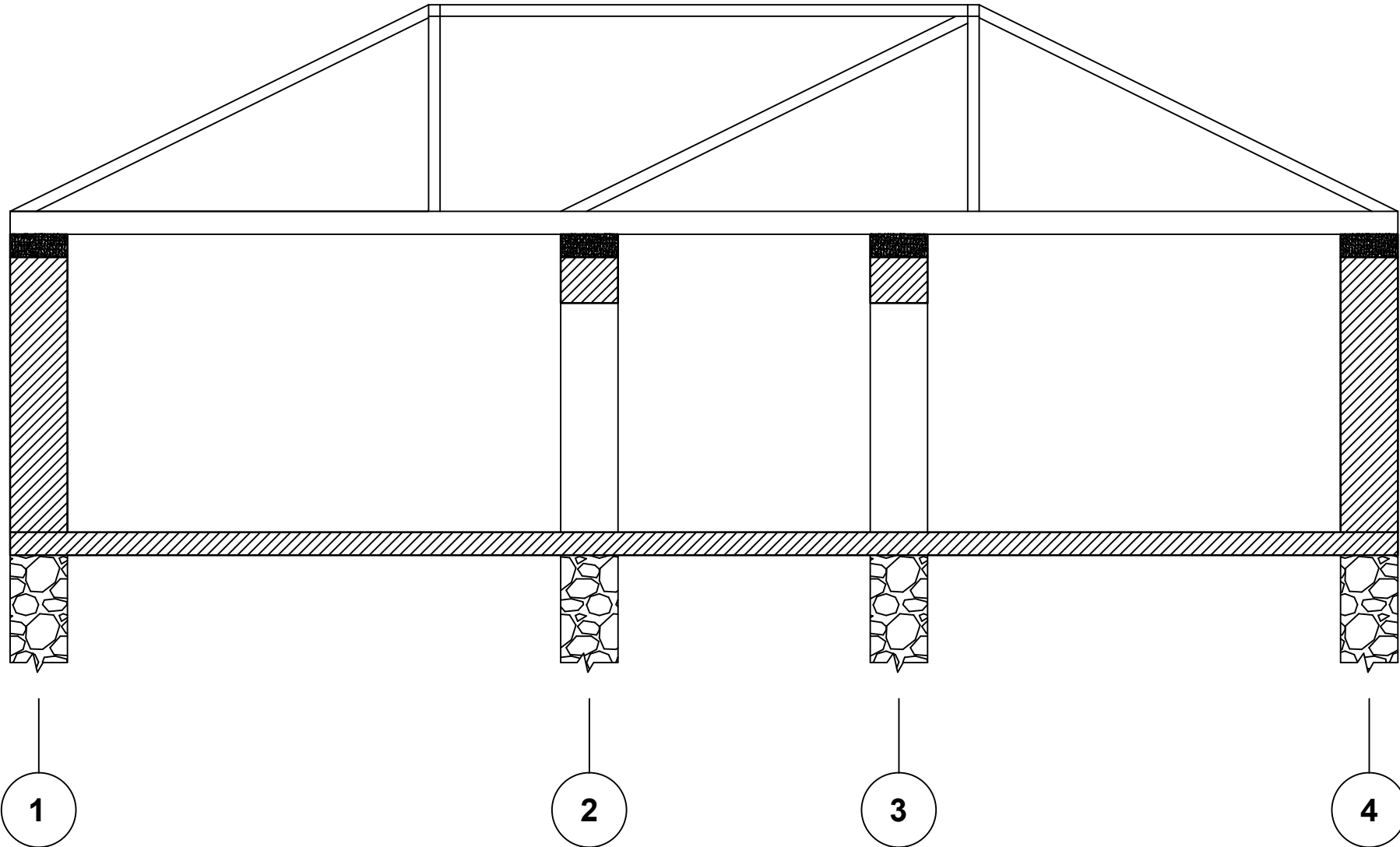

REPUBLIKA E SHQIPERISE
BASHKIA PUSTEC
SEKTTORI I URBANISTIKES

MIRATOI
KRYETARI I BASHKISE
PALI KOLEFSKI

AUTORET E PROJEKTIT

ARKITEKT: PAOLO ROPI
TOPOGRAF: VASKA ARGJIRI

Objekti: _____RIKONSTRUKSON_____

Emertimi: _____

Data: __/__/2023

PRERJA B-B
SH: 1:100

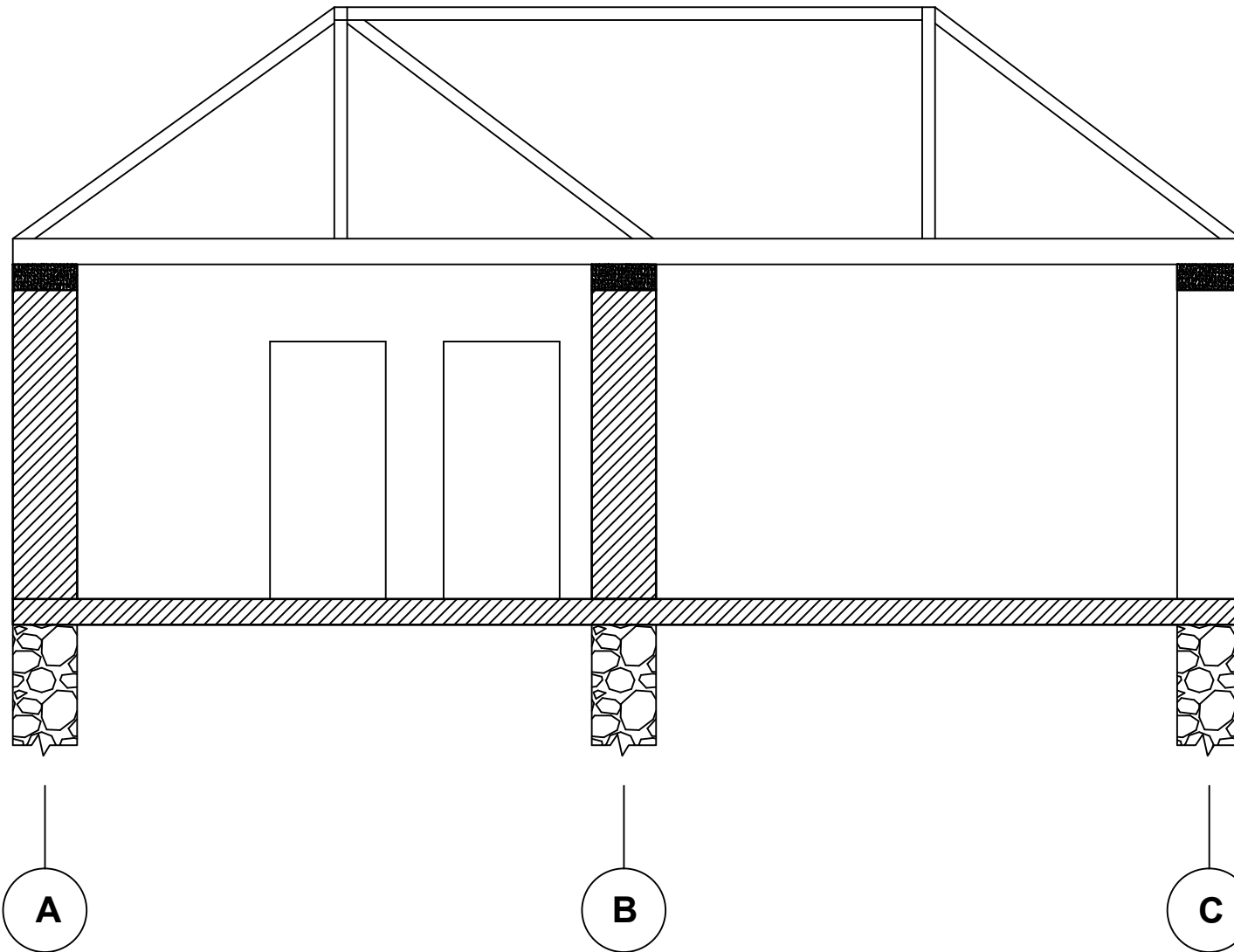

REPUBLIKA E SHQIPERISE
BASHKIA PUSTEC
SEKTORI I URBANISTIKES

MIRATOI
KRYETARI I BASHKISE
PALI KOLEFSKI

AUTORET E PROJEKTIT

ARKITEKT: PAOLO ROPI
TOPOGRAF: VASKA ARGJIRI

Objekti: _____RIKONSTRUKSON_____

Emertimi: _____

Data: ___/___/2023

PLANIMETRI E OBJEKTIT SH: 1:100

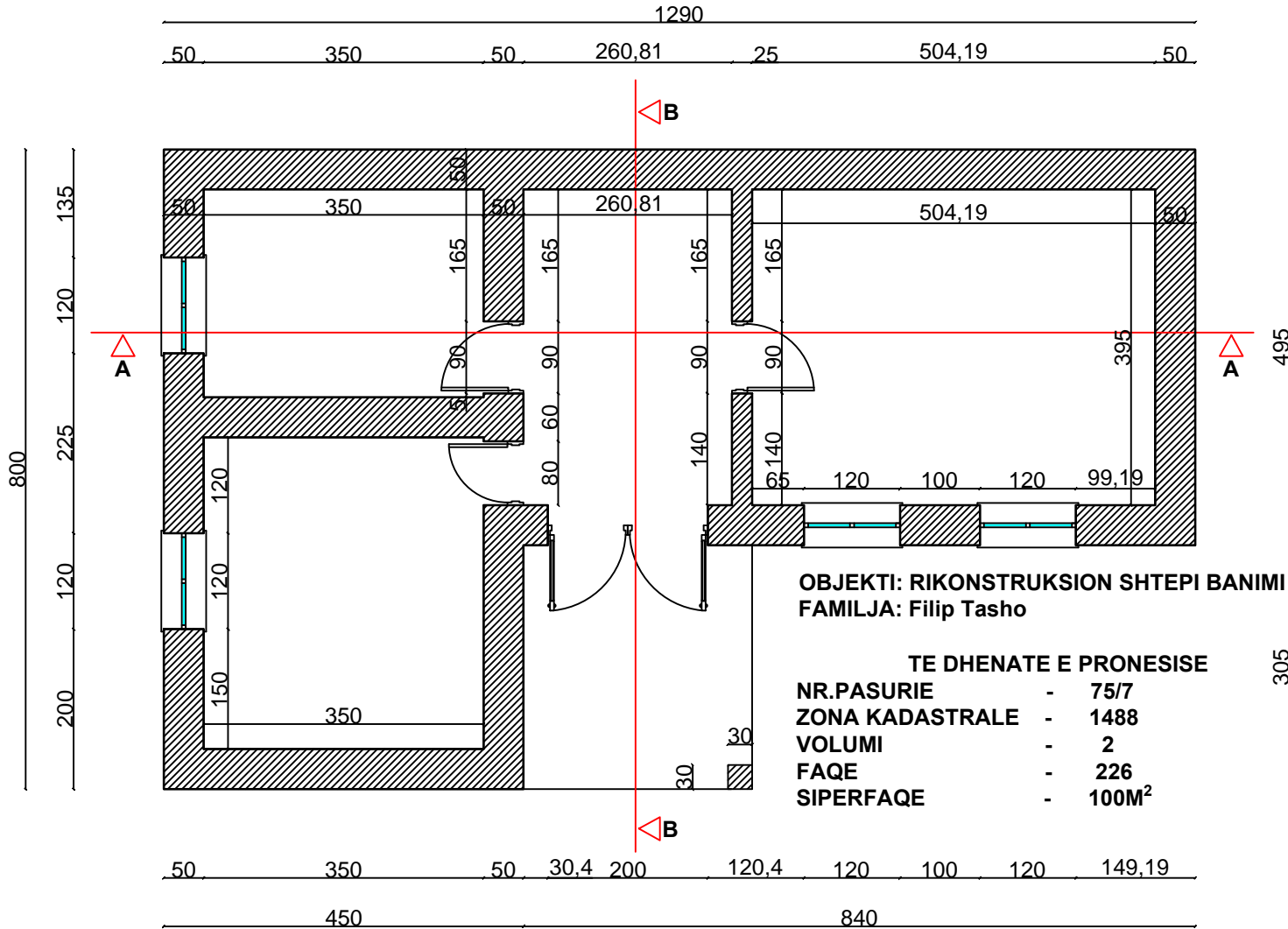

REPUBLIKA E SHQIPERISE
 BASHKIA PUSTEC
 SEKTTORI I URBANISTIKES

MIRATOI
 KRYETARI I BASHKISE
 PALI KOLEFSKI

AUTORET E PROJEKTIT

ARKITEKT: PAOLO ROPI
 TOPOGRAF: VASKA ARGJIRI

Objekti: _____RIKONSTRUKSION_____

Emertimi: _____

Data: ___/___/2023

PLANI I KULLIMIT TE UJARAVE
SH: 1:100

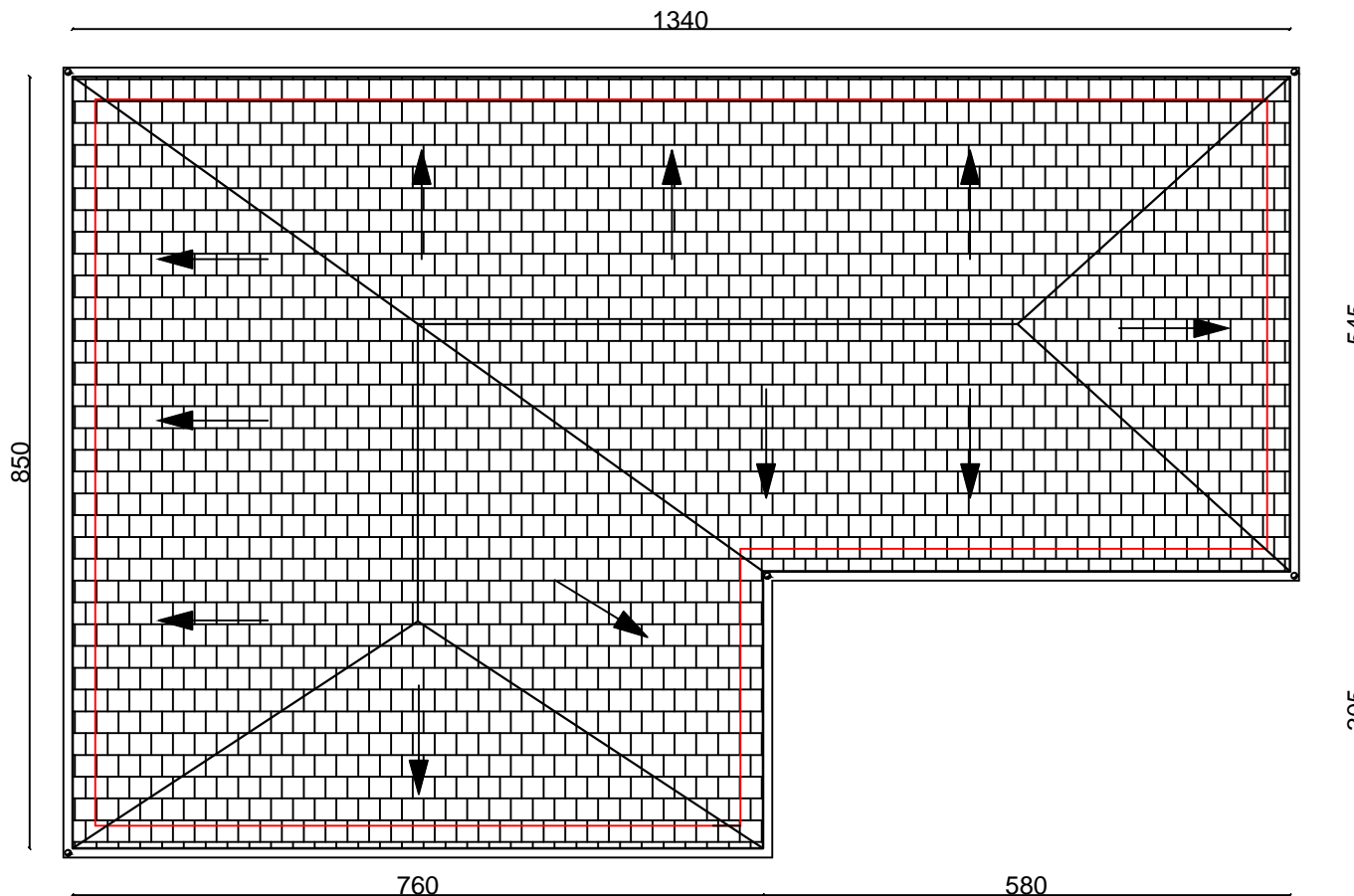

SHPJEGIM TEKNIK

NDERTIMI I CATISE DO REALIZOHET ME
LENDE DRRURI TE SHARRUARTE CILAT
DO TE MBESHTEHEN MBI TRARET E
TAVANIT 20X20 CM TE CILAT DO JENE
SHARUAR DHE STAZHONUAR SIMBAS K.T.Z
RISTELAT KU DO MBESHTEHEN
TJEGULLAT DO JENE ME PERMASA 5X4CM DHE
DO VENDOSEN CDO 30-35CM SIMBAS
LLOJIT TE TJEGULLES
PERMASAT E MAHIVE DO JENE ME PERMASA
10X8CM DISTANCA E TE CILAVE
DO JENE CDO 80CM
TJEGULLA TE PLANIFIKUARA IMPORTI
TRARET HORIZONTALE DHE KULMORE
JANE TE PERMASAVE 10X10CM
NE DREJTIM GJATESOR DO VENDOSEN
KONDRARENTIME ME PERMASA 10X8
ULLUKET DO JENE LLAMARINE XINGATO



REPUBLIKA E SHQIPERISE
BASHKIA PUSTEC
SEKTTORI I URBANISTIKES

MIRATOI
KRYETARI I BASHKISE
PALI KOLEFSKI

AUORET E PROJEKTIT

ARKITEKT: PAOLO ROPI
TOPOGRAF: VASKA ARGJIRI

Objekti: _____RIKONSTRUKSON_____

Emertimi: _____

Data: ___/___/2023

PRERJA A-A
SH: 1:100

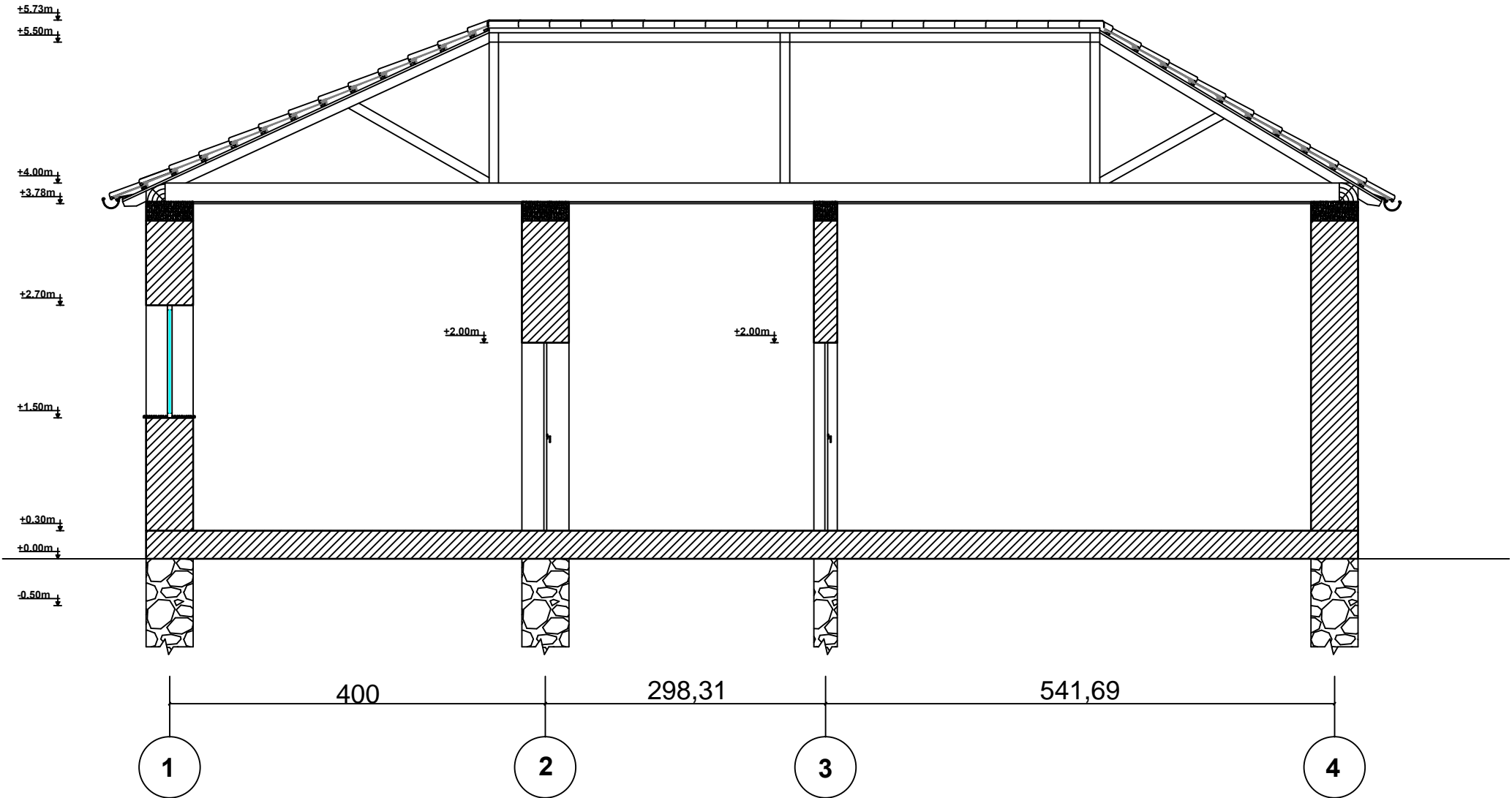

| | | | | | |
|--|------------------------|---|---------------------|---|----------------------------------|
| | REPUBLIKA E SHQIPERISE | MIRATOI KRYETARI I BASHKISE PALI KOLEFSKI | AUTORET E PROJEKMIT | ARKITEKT: PAOLO ROPI TOPOGRAF: VASKA ARGJIRI | Objekti: _____RIKONSTRUKSON_____ |
| | BASHKIA PUSTEC | | | | Emertimi: _____ |
| | SEKTORI I URBANISTIKES | | | | Data: ___/___/2023 |

PRERJA B-B
SH: 1:100

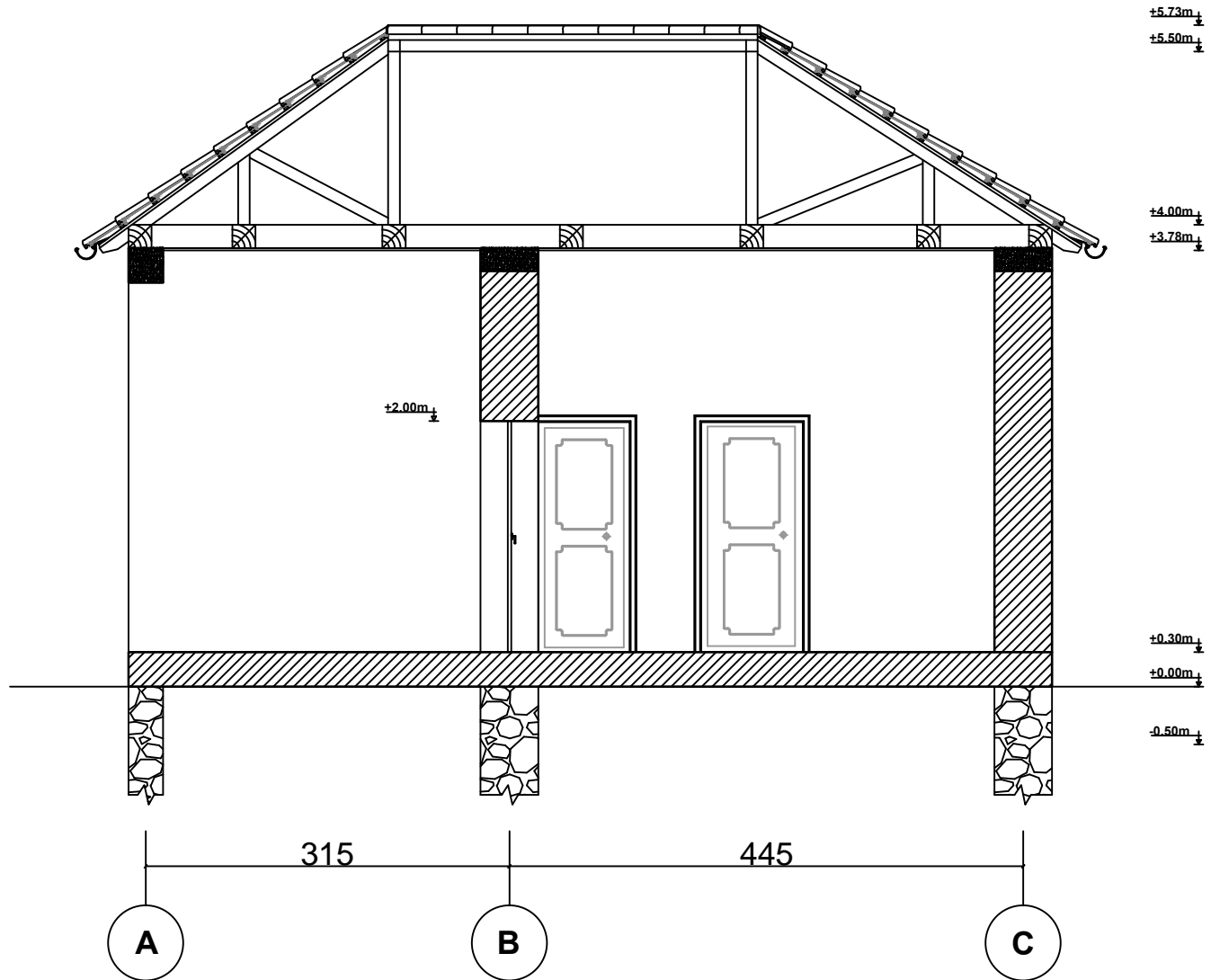

REPUBLIKA E SHQIPERISE
BASHKIA PUSTEC
SEKTTORI I URBANISTIKES

MIRATOI
KRYETARI I BASHKISE
PALI KOLEFSKI

AUTORET E PROJEKTIT

ARKITEKT: PAOLO ROPI
TOPOGRAF: VASKA ARGJIRI

Objekti: _____RIKONSTRUKSON_____

Emertimi: _____

Data: ___/___/2023

PLANI I KONSTRUKTIV I CATISE

SH: 1:100

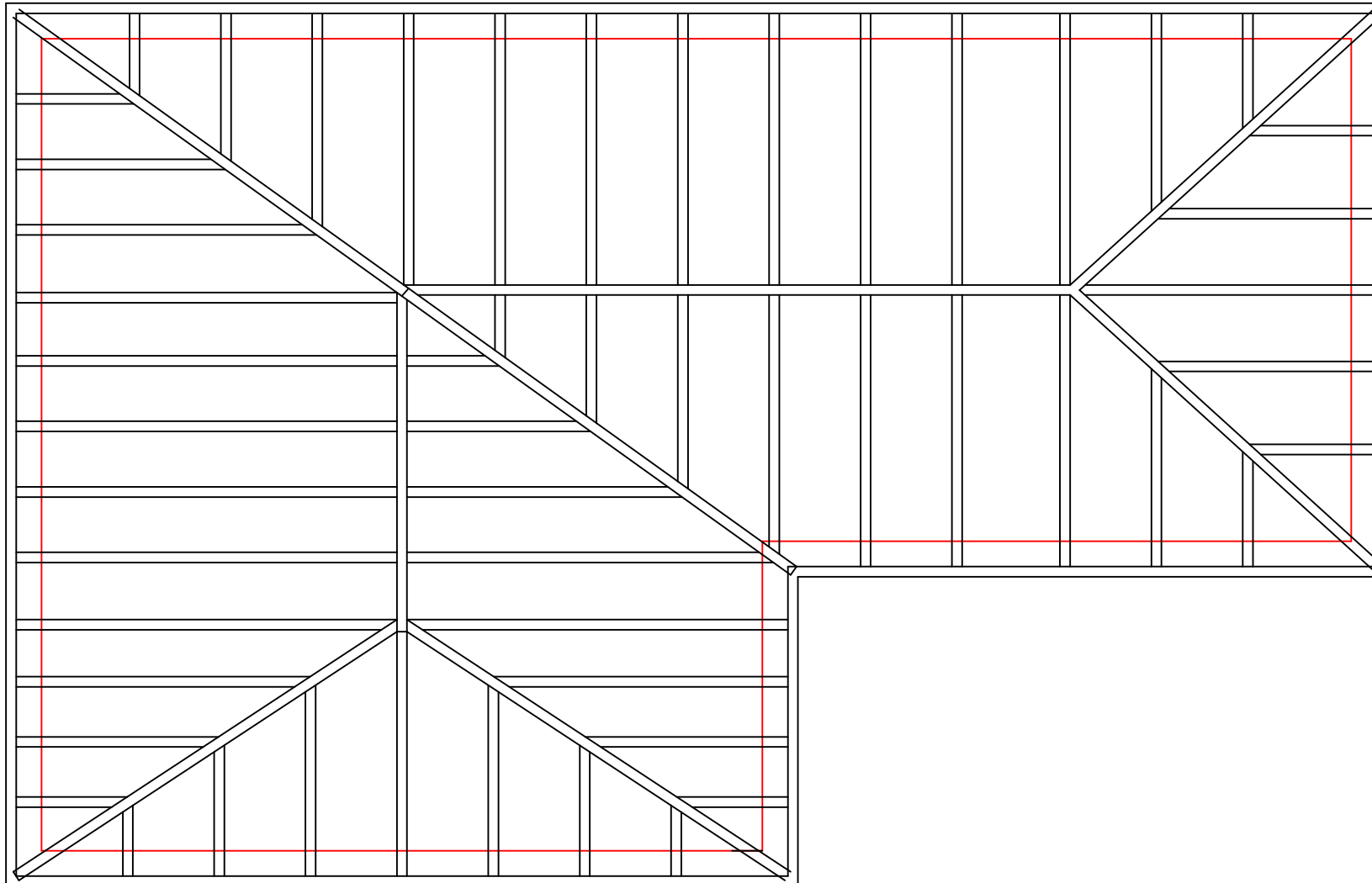

SHPJEGIM TEKNIK

NDERTIMI I CATISE DO REALIZOHET ME
LENDE DRRURI TE SHARRUARTE CILAT
DO TE MBESHTETEN MBI TRARET E
TAVANIT 20X20 CM TE CILAT DO JENE
SHARUAR DHE STAZHONUAR SIMBAS K.T.
RISTELAT KU DO MBESHTETEN
TJEGULLAT DO JENE ME PERMASA 5X4CM
DO VENDOSEN CDO 30-35CM SIMBAS
LLOJIT TE TJEGULLES
PERMASAT E MAHIVE DO JENE ME PERMA
10X8CM DISTANCA E TE CILAVE
DO JENE CDO 80CM
TJEGULLA TE PLANIFIKUARA IMPORTI
TRARET HORIZONTALE DHE KULMORE
JANE TE PERMASAVE 10X10CM
NE DREJTIM GJATESOR DO VENDOSEN
KONDRARENTIME ME PERMASA 10X8
ULLUKET DO JENE LLAMARINE XINGATO



REPUBLIKA E SHQIPERISE

BASHKIA PUSTEC

SEKTTORI I URBANISTIKES

MIRATOI
KRYETARI I BASHKISE
PALI KOLEFSKI

AUTORET E PROJEKTIT

ARKITEKT: PAOLO ROPI
TOPOGRAF: VASKA ARGJIRI

Objekti: _____RIKONSTRUKSON_____

Emertimi: _____

Data: ___/___/2023

PLANIMETRI E OBJEKTIT SH: 1:100

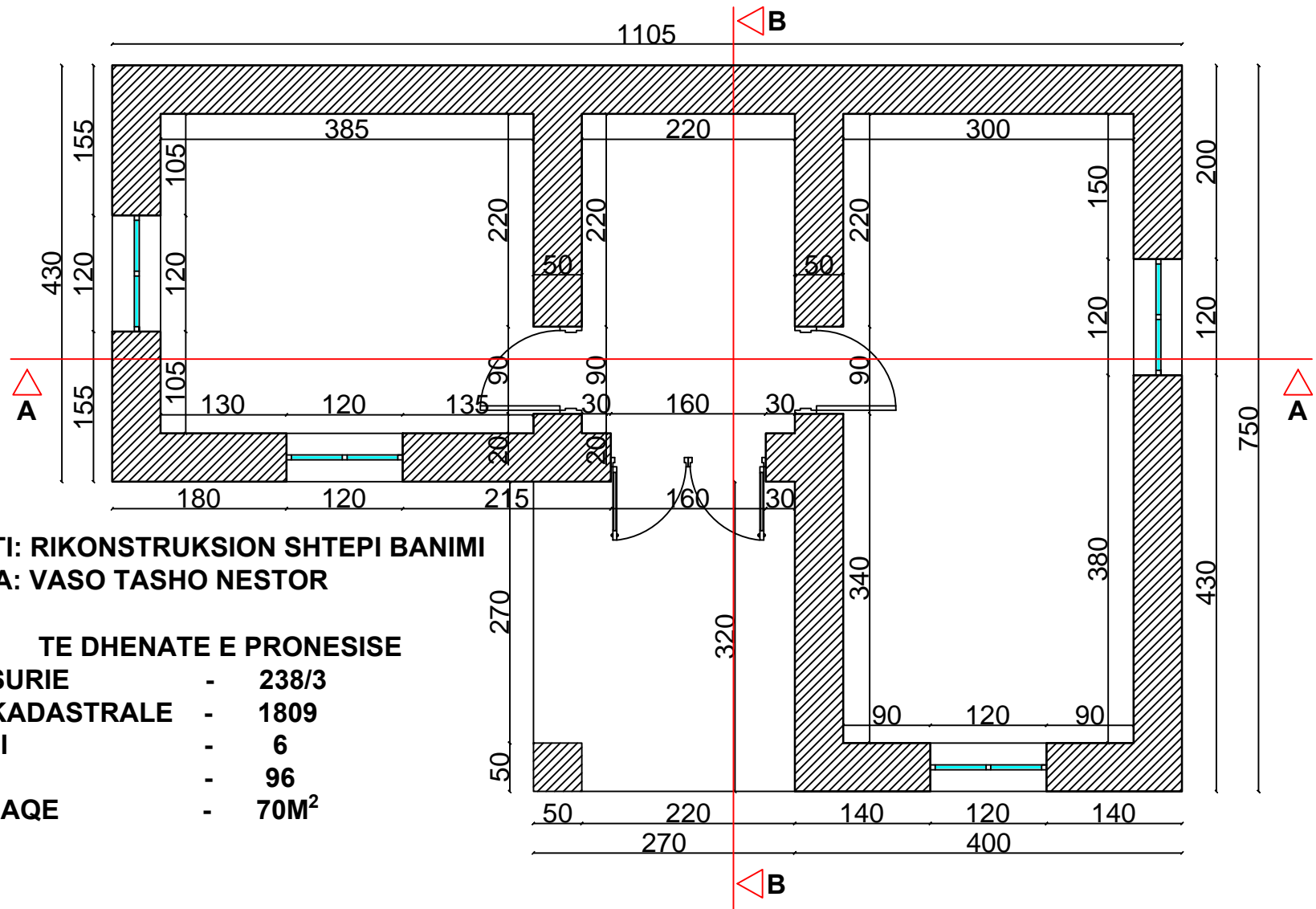

OBJEKTI: RIKONSTRUKSION SHTEPI BANIMI
FAMILJA: VASO TASHO NESTOR

TE DHENATE E PRONESISE

NR.PASURIE - 238/3
ZONA KADASTRALE - 1809
VOLUMI - 6
FAQE - 96
SIPERFAQE - 70M²



REPUBLIKA E SHQIPERISE
 BASHKIA PUSTEC
 SEKTORI I URBANISTIKES

MIRATOI
 KRYETARI I BASHKISE
 PALI KOLEFSKI

AUTORET E PROJEKTTIT

ARKITEKT: PAOLO ROPI
 TOPOGRAF: VASKA ARGJIRI

Objekti: _____RIKONSTRUKSION_____

Emertimi: _____

Data: ___/___/2023

PLANI I KULLIMIT TE UJJRAVE

SH: 1:100

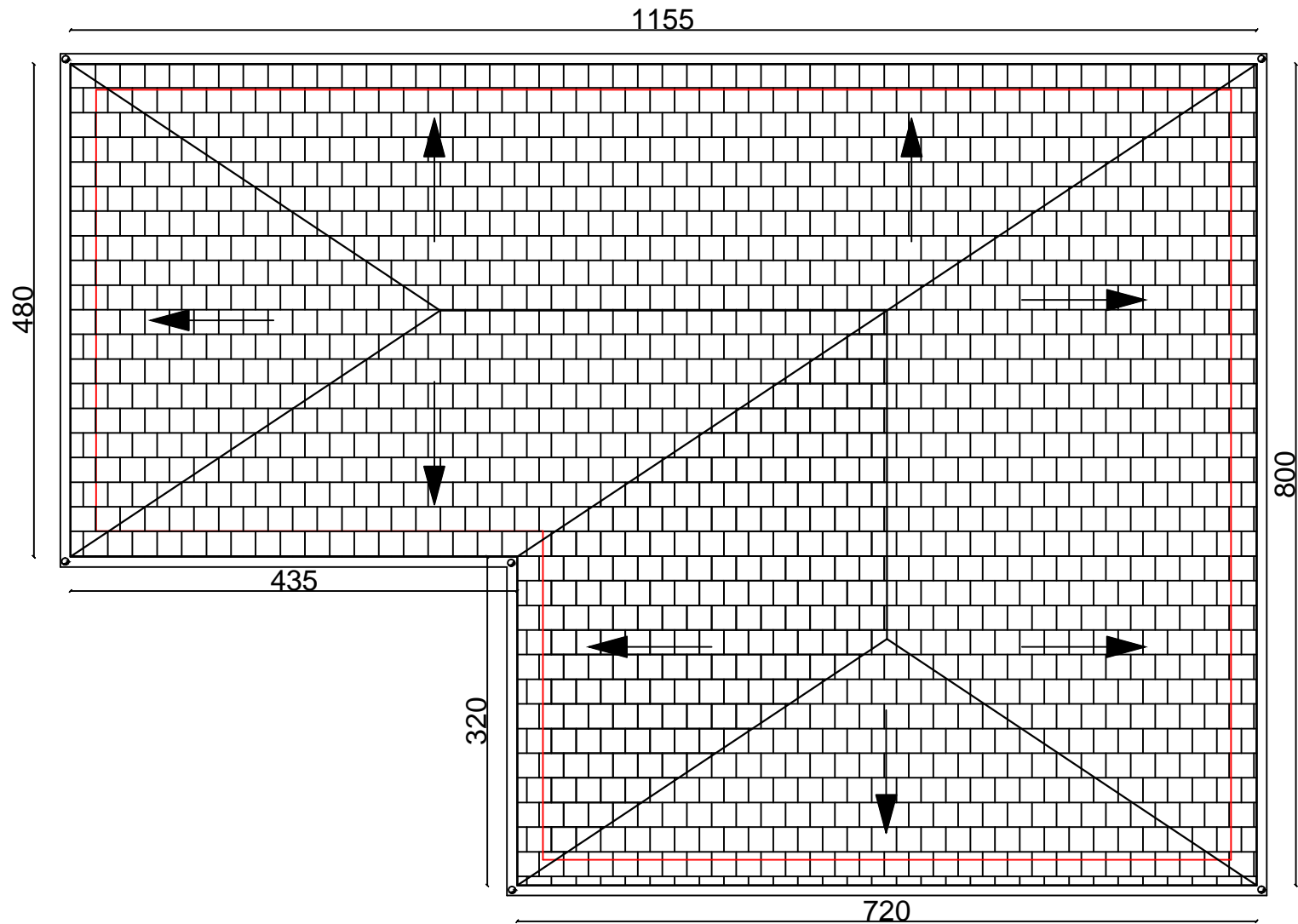

REPUBLIKA E SHQIPERISE
BASHKIA PUSTEC
SEKTORI I URBANISTIKES

MIRATOI
KRYETARI I BASHKISE
PALI KOLEFSKI

AUTORET E PROJEKTIT

ARKITEKT: PAOLO ROPI
TOPOGRAF: VASKA ARGJIRI

Objekti: _____RIKONSTRUKSON_____

Emertimi: _____

Data: ___/___/2023

PRERJA A-A
SH: 1:100

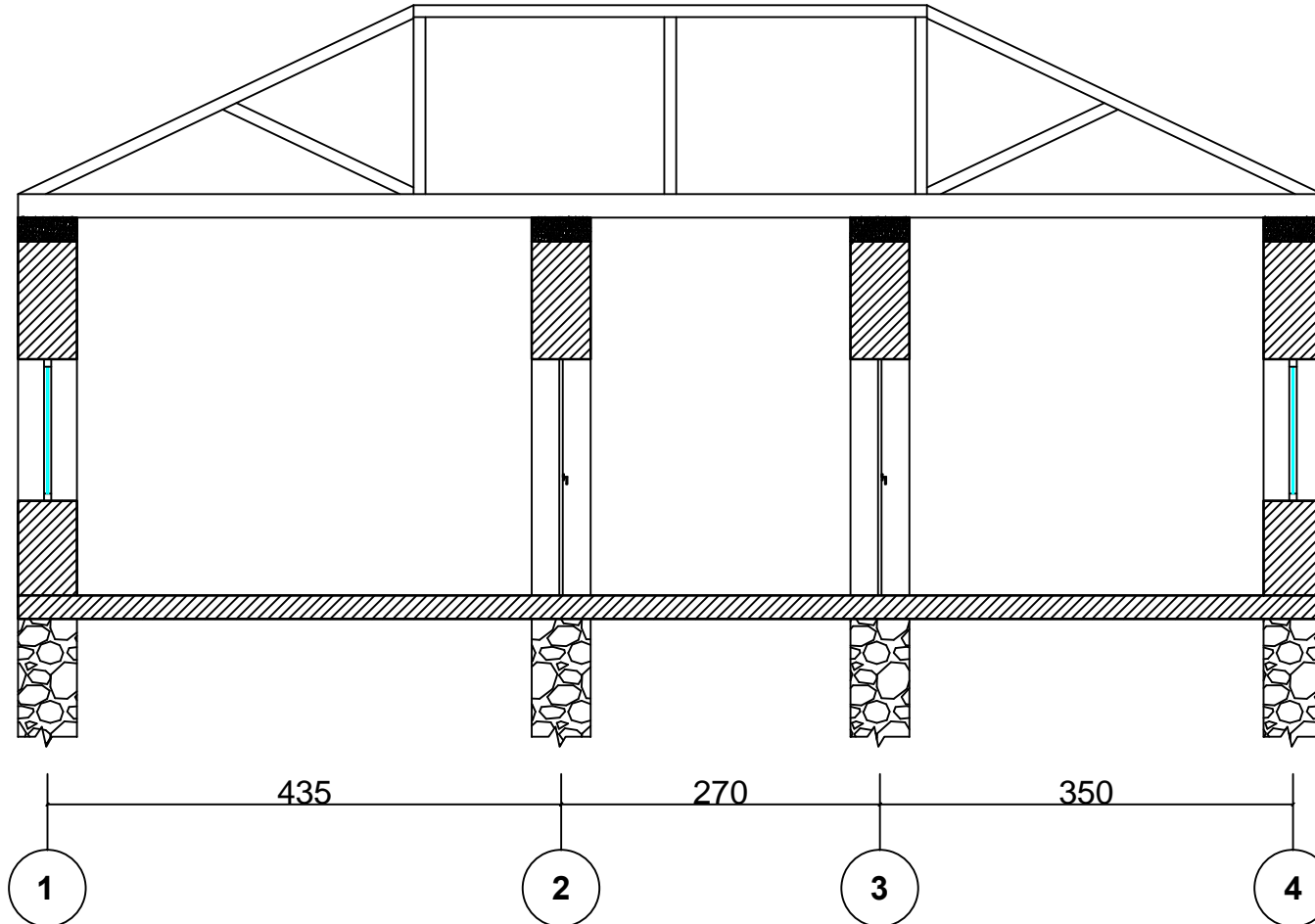

REPUBLIKA E SHQIPERISE
BASHKIA PUSTEC
SEKTORI I URBANISTIKES

MIRATOI
KRYETARI I BASHKISE
PALI KOLEFSKI

AUTORET E PROJEKTIT

ARKITEKT: PAOLO ROPI
TOPOGRAF: VASKA ARGJIRI

Objekti: _____RIKONSTRUKSON_____

Emertimi: _____

Data: __/__/2023

PRERJA B-B
SH: 1:100

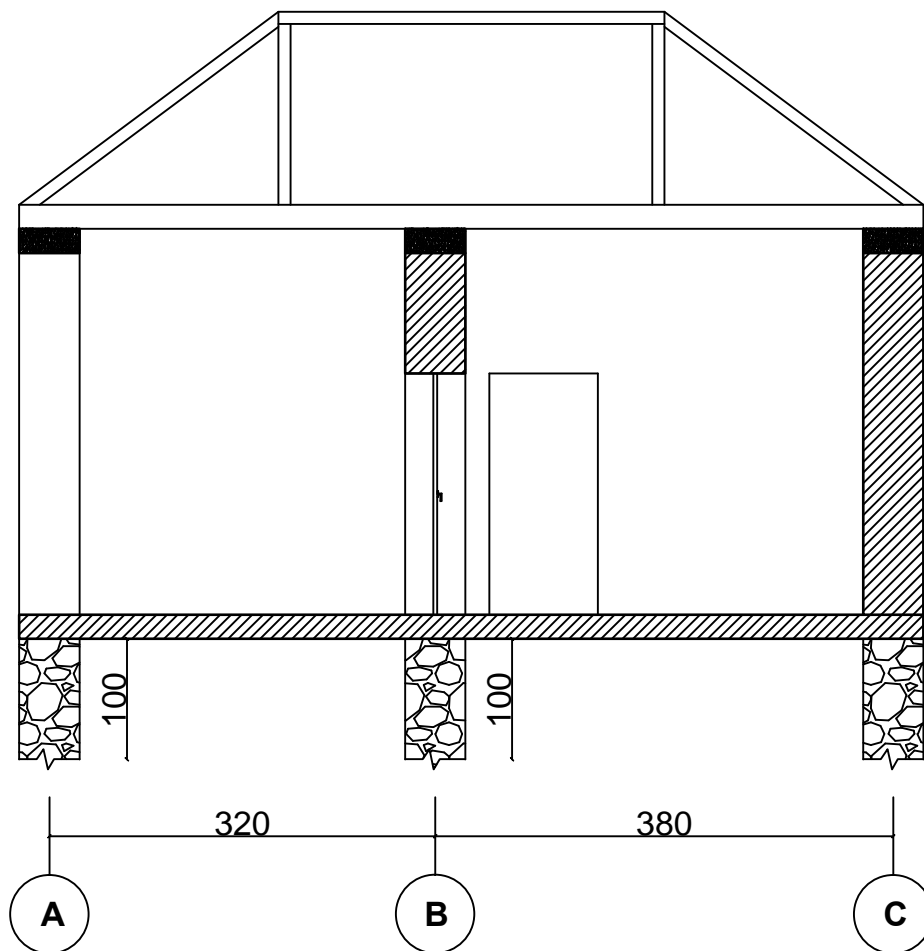

REPUBLIKA E SHQIPERISE
BASHKIA PUSTEC
SEKTORI I URBANISTIKES

MIRATOI
KRYETARI I BASHKISE
PALI KOLEFSKI

AUTORET E PROJEKTIT

ARKITEKT: PAOLO ROPI
TOPOGRAF: VASKA ARGJIRI

Objekti: _____RIKONSTRUKSON_____

Emertimi: _____

Data: ___/___/2023

PLANI I KONSTRUKTIV I CATISE
SH: 1:100

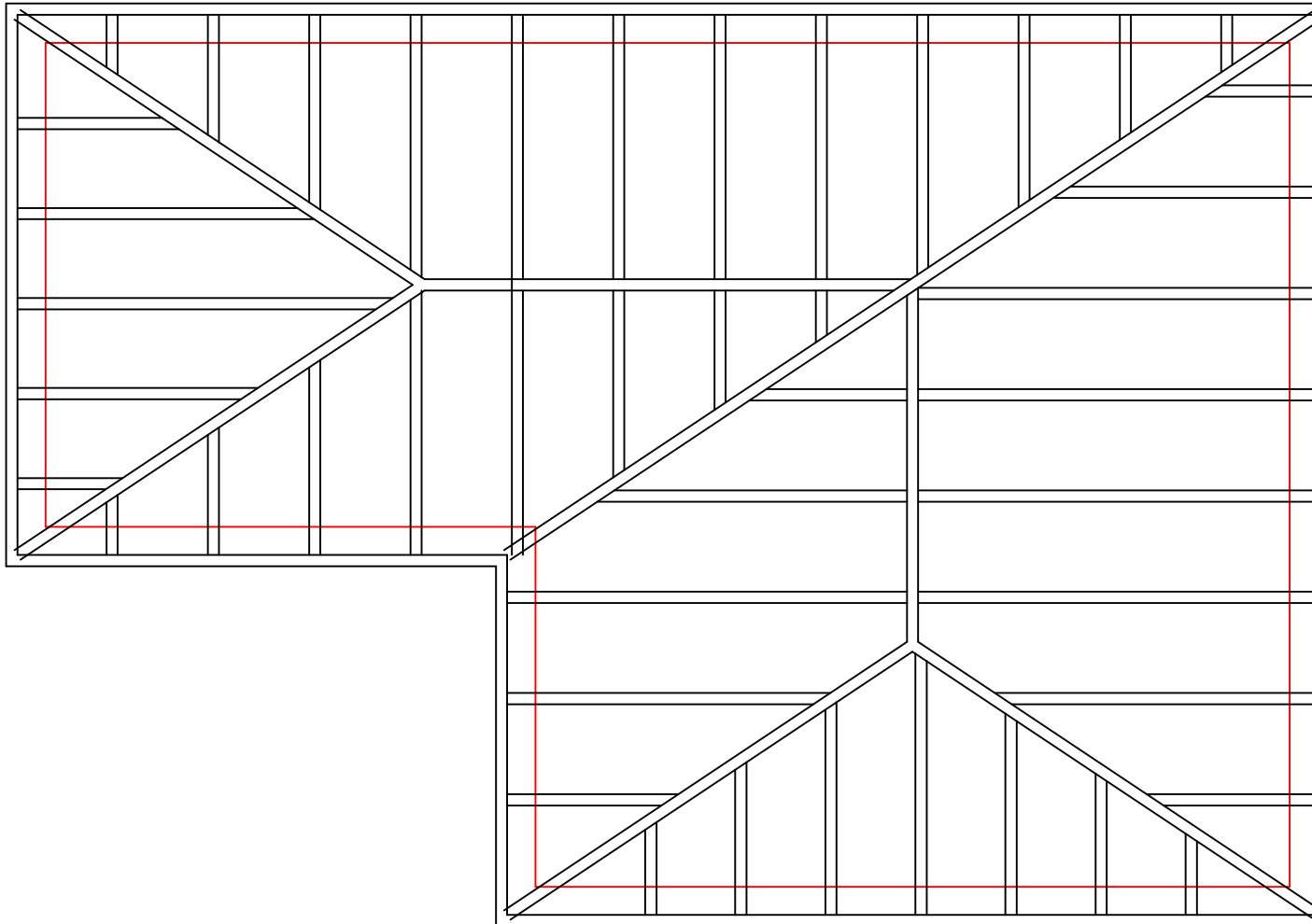

SHPJEGIM TEKNIK

NDERTIMI I CATISE DO REALIZOHET ME
LENDE DRRURI TE SHARRUARTE CILAT
DO TE MBESHTETEN MBI TRARET E
TAVANIT 20X20 CM TE CILAT DO JENE
SHARUAR DHE STAZHONUAR SIMBAS K.T.Z
RISTELAT KU DO MBESHTETEN
TJEGULLAT DO JENE ME PERMASA 5X4CM DHE
DO VENDOSEN CDO 30-35CM SIMBAS
LLOJIT TE TJEGULLES
PERMASAT E MAHIVE DO JENE ME PERMASA
10X8CM DISTANCA E TE CILAVE
DO JENE CDO 80CM
TJEGULLA TE PLANIFIKUARA IMPORTI
TRARET HORIZONTALE DHE KULMORE
JANE TE PERMASAVE 10X10CM
NE DREJTIM GJATESOR DO VENDOSEN
KONDRARENTIME ME PERMASA 10X8
ULLUKET DO JENE LLAMARINE XINGATO



REPUBLIKA E SHQIPERISE
BASHKIA PUSTEC
SEKTTORI I URBANISTIKES

MIRATOI
KRYETARI I BASHKISE
PALI KOLEFSKI

AUTORET E PROJEKTIT

ARKITEKT: PAOLO ROPI
TOPOGRAF: VASKA ARGJIRI

Objekti: _____RIKONSTRUKSON_____

Emertimi: _____

Data: ___/___/2023

PLANIMETRI E OBJEKTIT SH: 1:100

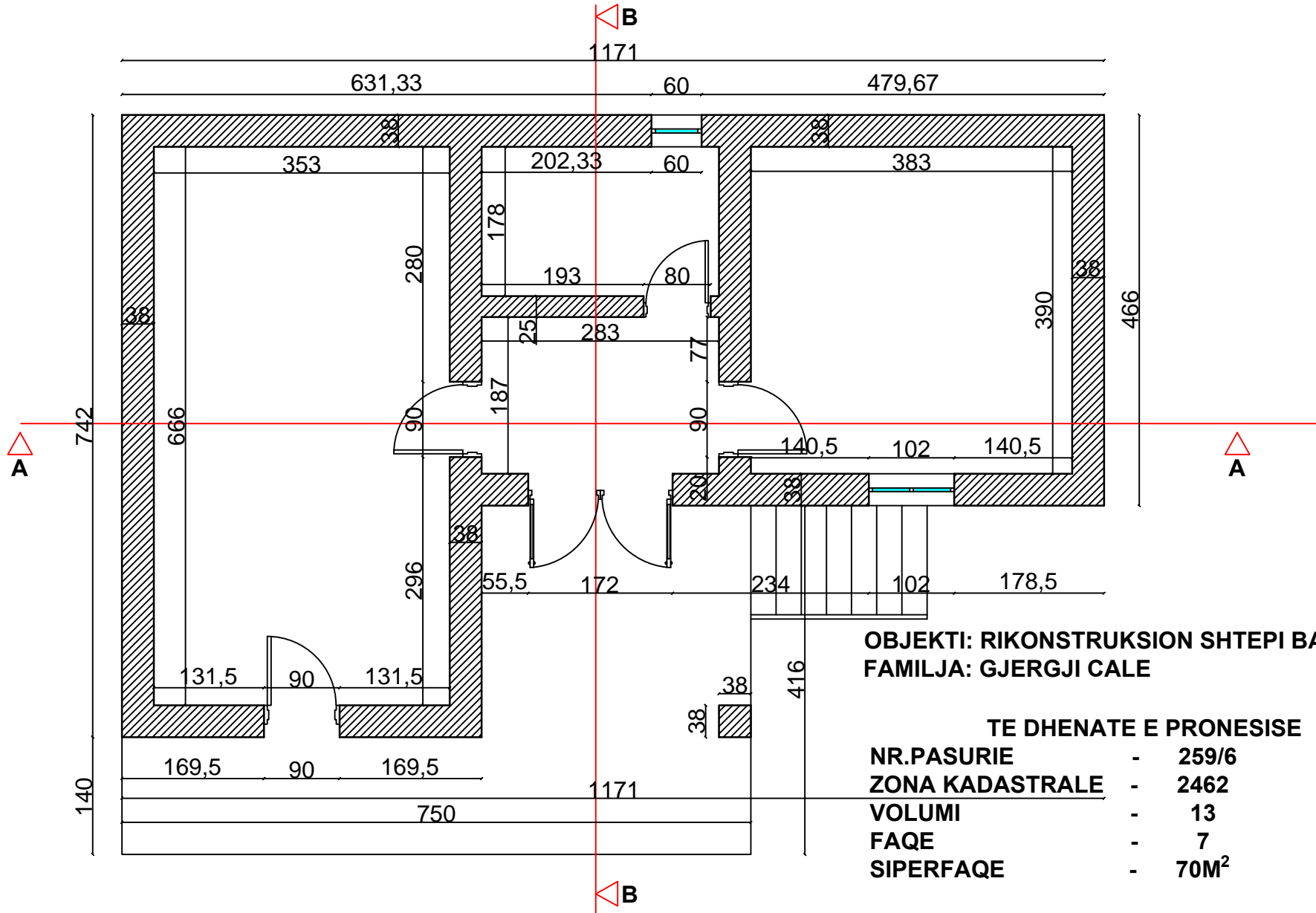

OBJEKTI: RIKONSTRUKSION SHTEPI BANIMI
FAMILJA: GJERGJI CALE

TE DHENATE E PRONESISE

NR.PASURIE - 259/6
ZONA KADASTRALE - 2462
VOLUMI - 13
FAQE - 7
SIPERFAQE - 70M²



REPUBLIKA E SHQIPERISE
 BASHKIA PUSTEC
 SEKTTORI I URBANISTIKES

MIRATOI
 KRYETARI I BASHKISE
 PALI KOLEFSKI

AUTORET E PROJEKTIT

ARKITEKT: PAOLO ROPI
 TOPOGRAF: VASKA ARGJIRI

Objekti: _____RIKONSTRUKSON_____

Emertimi: _____

Data: ___/___/2023

PLANI I KULLIMIT TE UJJRAVE
SH: 1:100

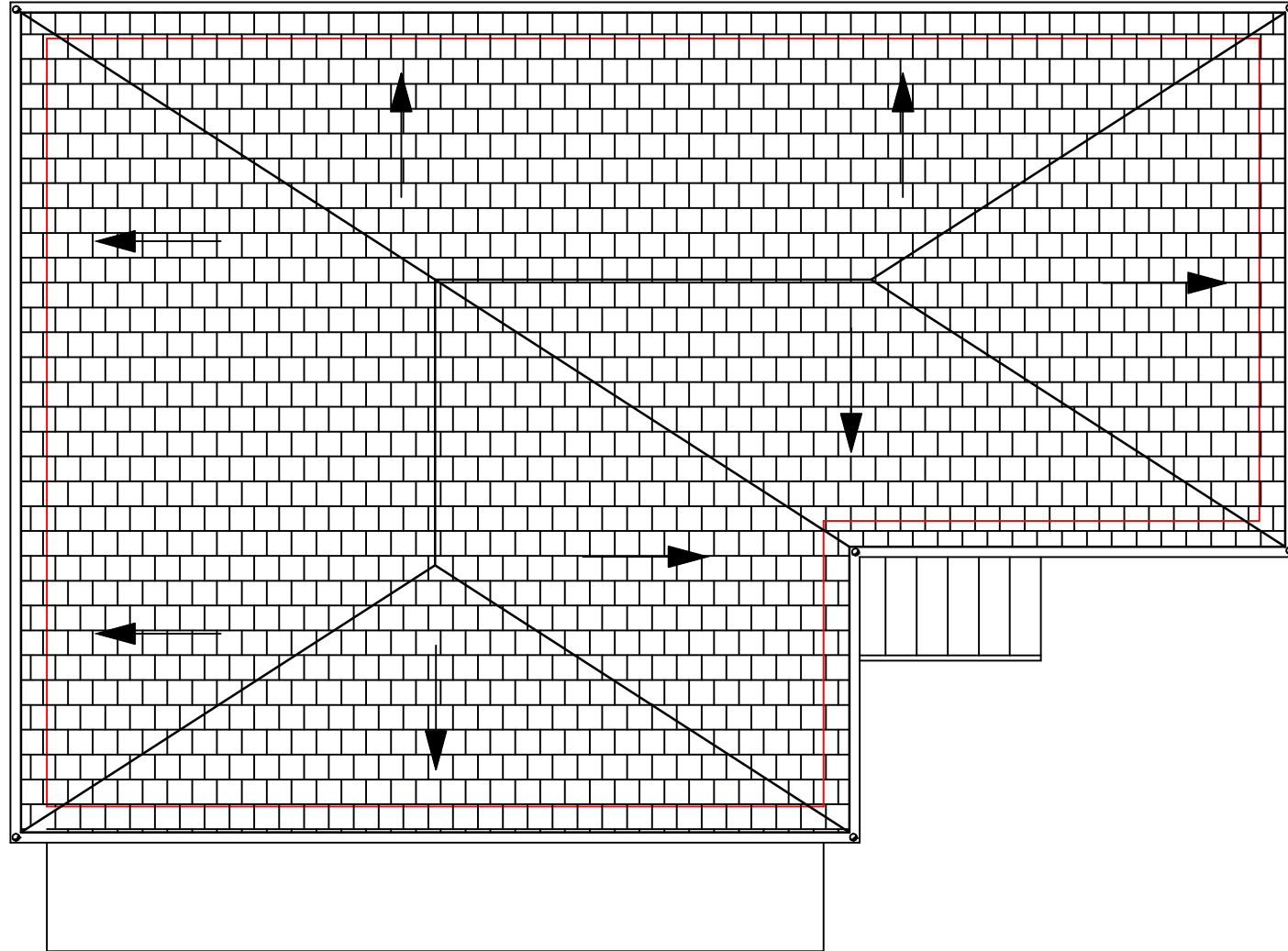

REPUBLIKA E SHQIPERISE
BASHKIA PUSTEC
SEKTORI I URBANISTIKES

MIRATOI
KRYETARI I BASHKISE
PALI KOLEFSKI

AUTORET E PROJEKTIT

ARKITEKT: PAOLO ROPI
TOPOGRAF: VASKA ARGJIRI

Objekti: _____RIKONSTRUKSON_____

Emertimi: _____

Data: ___/___/2023

PRERJA A-A
SH: 1:100

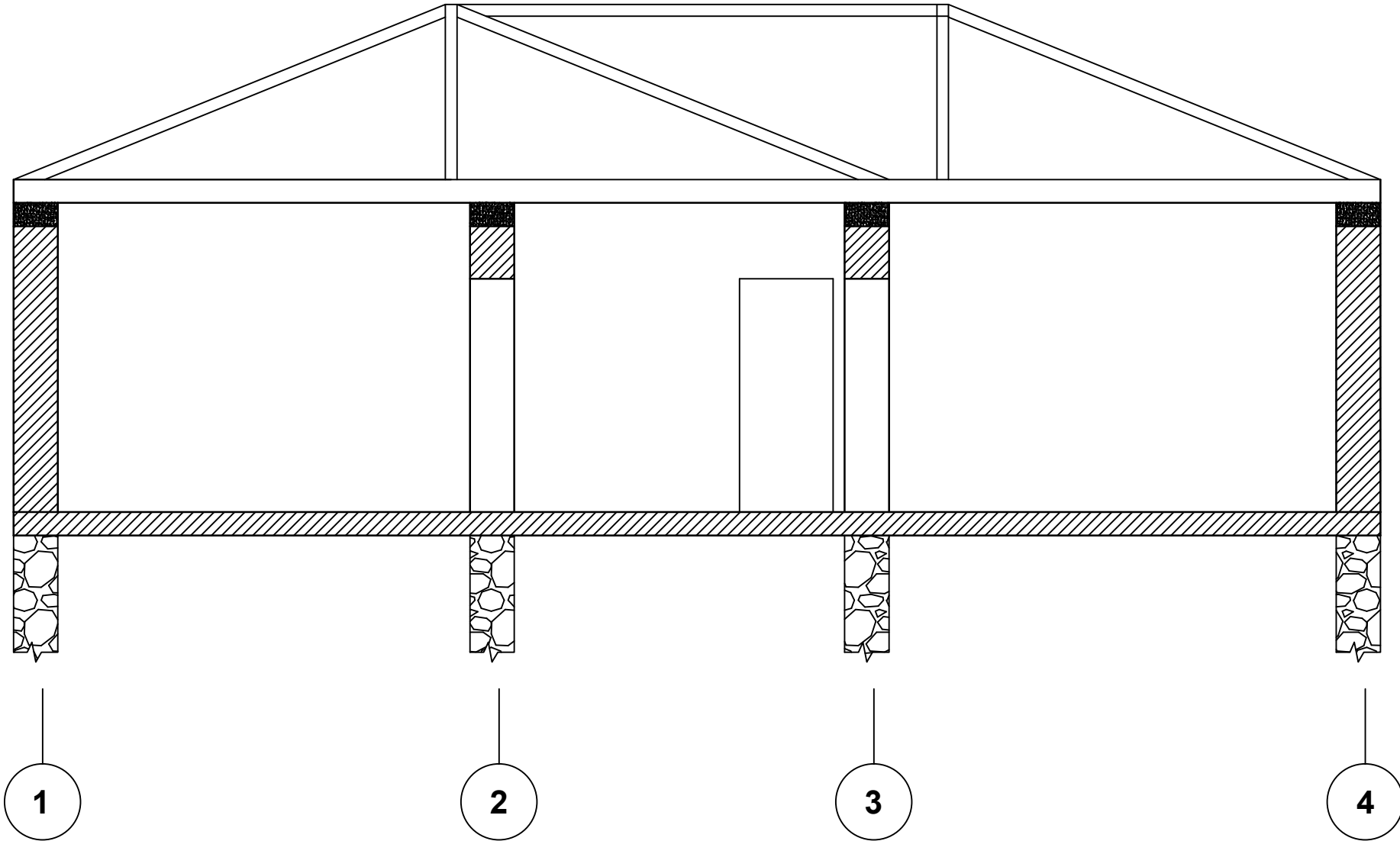

REPUBLIKA E SHQIPERISE
BASHKIA PUSTEC
SEKTORI I URBANISTIKES

MIRATOI
KRYETARI I BASHKISE
PALI KOLEFSKI

AUTORET E PROJEKTIT

ARKITEKT: PAOLO ROPI
TOPOGRAF: VASKA ARGJIRI

Objekti: _____RIKONSTRUKSON_____

Emertimi: _____

Data: ___/___/2023

PRERJA B-B
SH: 1:100

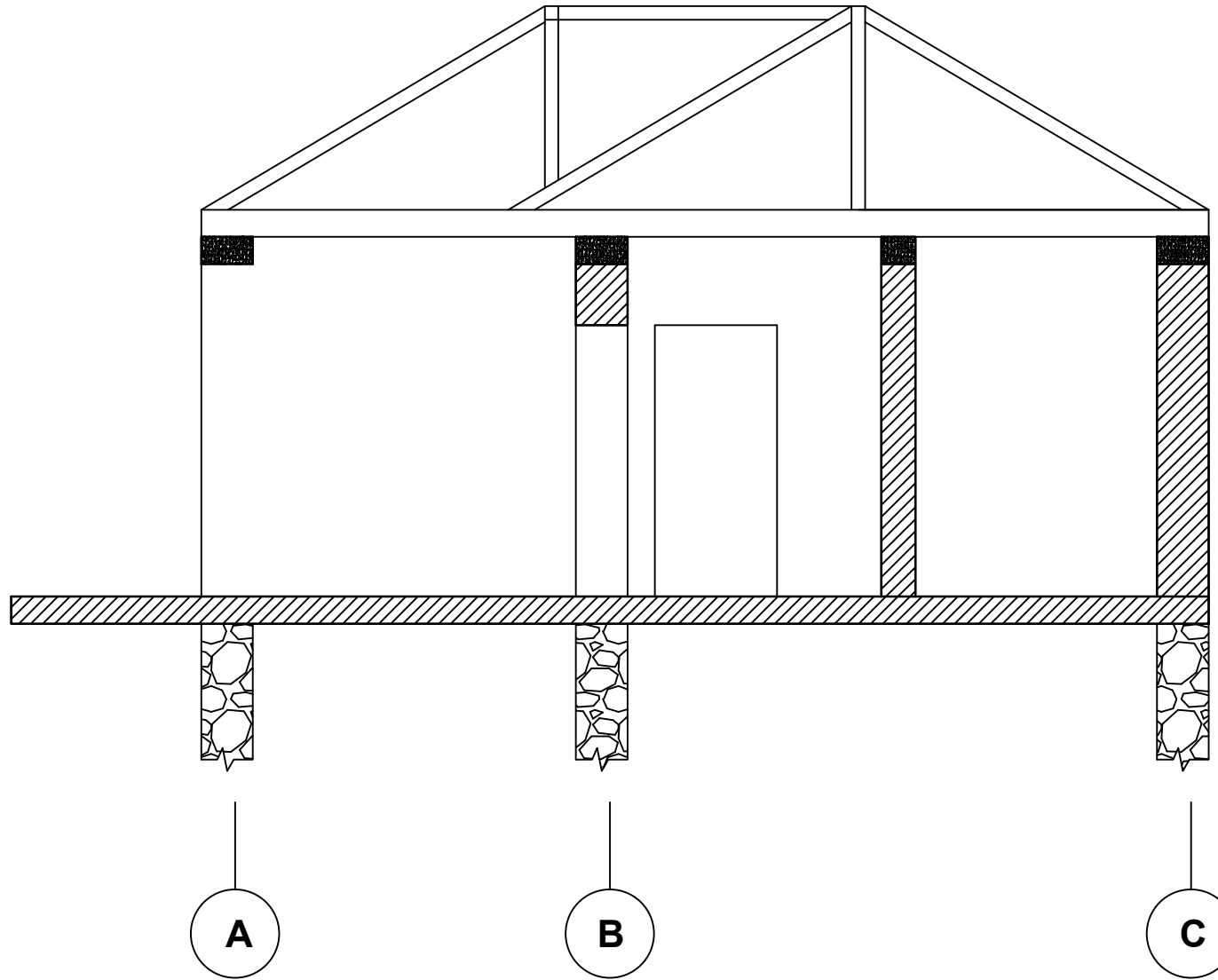

REPUBLIKA E SHQIPERISE
BASHKIA PUSTEC
SEKTTORI I URBANISTIKES

MIRATOI
KRYETARI I BASHKISE
PALI KOLEFSKI

AUTORET E PROJEKTIT

ARKITEKT: PAOLO ROPI
TOPOGRAF: VASKA ARGJIRI

Objekti: RIKONSTRUKSON

Emertimi: _____

Data: __/__/2023

PLANI I KONSTRUKTIV I CATISE
SH: 1:100

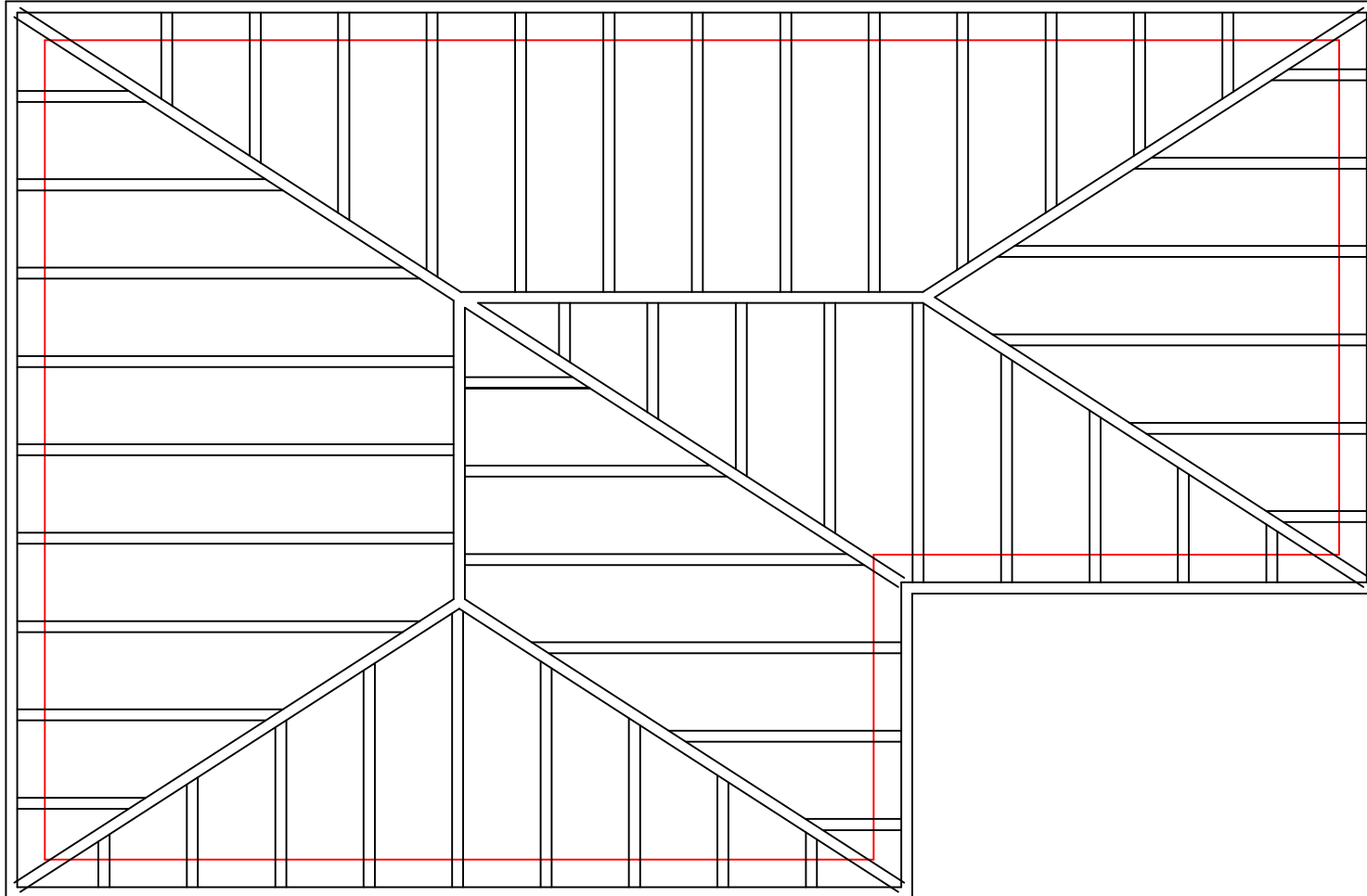

SHPJEGIM TEKNIK

NDERTIMI I CATISE DO REALIZOHET ME
LENDE DRRURI TE SHARRUARTE CILAT
DO TE MBESHTETEN MBI TRARET E
TAVANIT 20X20 CM TE CILAT DO JENE
SHARUAR DHE STAZHONUAR SIMBAS K.T.Z
RISTELAT KU DO MBESHTETEN
TJEGULLAT DO JENE ME PERMASA 5X4CM DHE
DO VENDOSEN CDO 30-35CM SIMBAS
LLOJIT TE TJEGULLES
PERMASAT E MAHIVE DO JENE ME PERMASA
10X8CM DISTANCA E TE CILAVE
DO JENE CDO 80CM
TJEGULLA TE PLANIFIKUARA IMPORTI
TRARET HORIZONTALE DHE KULMORE
JANE TE PERMASAVE 10X10CM
NE DREJTIM GJATESOR DO VENDOSEN
KONDRARENTIME ME PERMASA 10X8
ULLUKET DO JENE LLAMARINE XINGATO



REPUBLIKA E SHQIPERISE
BASHKIA PUSTEC
SEKTTORI I URBANISTIKES

MIRATOI
KRYETARI I BASHKISE
PALI KOLEFSKI

AUOTRET E PROJEKTIT

ARKITEKT: PAOLO ROPI
TOPOGRAF: VASKA ARGJIRI

Objekti: _____RIKONSTRUKSON_____

Emertimi: _____

Data: ___/___/2023