

# PROJEKT ZBATIMI

RIKUALIFIKIMI I RRUGES "AZEM HAJDARI"

Ltot=1300 ml



**BASHKIA KAMËZ**

**MIRATOI**

**KRYETAR I BASHKISË KAMËZ**

**Z. RAKIP SULLI**



**BASHKIA KAMËZ**  
DREJTORIA E SHERBIMEVE PUBLIKE  
DREJTORIA E PROJEKTEVE DHE INVESTIMEVE  
DEPARTAMENTI I PROJEKTEVE

Dr. i Pergj. i Sherbimeve Publike	ELVIS GJIKA
Dr. e Projekteve e Investimeve	FLORA MUÇA
Pergj. Depart. Sektori Projektimi	EMANUELA MËZIU
ING. ARJOLA KURTI	
ING. ERBLIN LALA	
ING. EMANUELA MËZIU	
ING. HAJREDIN MUGRU	

<b>Titulli i Projektit</b>	<b>Pista e Projektit</b>
RIKUALIFIKIMI I RRUGES "AZEM HAJDARI"	PROJEKT ZBATIMI
<b>Emertimi i Pistas</b>	<b>Data e Implementimit:</b>
KAPAKU	Shtetli e Vizatimit:
	<b>Pista Nr.</b>
	<b>A-00</b>



# ORTOFOTO

RIKUALIFIKIMI I RRUGES "AZEM HAJDARI"

Ltot=1300 ml







		<b>BASHKIA KAMËZ</b>
		DREJTORIA E SHERBIMEVE PUBLIKE DREJTORIA E PROJEKTEVE DHE INVESTIMEVE DEPARTAMENTI I PROJEKTEVE
Dr. i Pergj. i Sherbimeve Publike		ELVIS GJIKAJ
Dr. e Projekteve e Investimeve		FLORA MUCA
Pergj. Depart. Sektori Projektimi		EMANUELA MEZIU
STAFI TEKNIK PROJEKTES	Ing.	ARJOLA KURTI
	Ing.	ERBLIN LALA
	Ing.	EMANUELA MEZIU
	Ing.	HAJREDIN MUGRU
Titulli i Projektit		Faza e Projektit
RIKUALIFIKIMI I RRUGES "AZEM HAJDARI"		PROJEKT ZBATIMI
Emertimi i Fases		Data e implementimit :
ORTOFOTO		Shkalla e Vizatimit
		Fleta Nr.
		A-01



# OBJEKTI: RIKUALIFIKIMI I RRUGES "AZEM HAJDARI"



## LEGJENDA

-  RRUGE EKZISTUESE
-  OBJEKTE
-  RRETHIME
-  NDAJE PARCELASH



## BASHKIA KAMEZ

DREJTORIA E SHERBIMEVE PUBLIKE  
DREJTORIA E PROJEKTEVE DHE INVESTIMEVE  
DEPARTAMENTI I PROJEKTEVE

Dr. i Pergj. i Sherbimeve Publike	ELVIS GJIKA
Dr. e Projekteve e Investimeve	FLORA MUÇA
Pergj. Depart. Sektori Projektimi	EMANUELA MEZIU
Ing. ARJOLA KURTI	
Ing. ERBLIN LALA	
Ing. EMANUELA MEZIU	
Ing. HAJREDIN MUGRU	



Titulli i Projektit:	RIKUALIFIKIMI I RRUGES "AZEM HAJDARI"	Faza e Projektit:	PROJEKT ZBATIMI
Emertimi i Fletes:	PLANIMETRIA EKZISTUESE	Data e Implementimit:	
		Shtylla e Vizimit:	
		Fleta Nr.:	T-02



# OBJEKTI: RIKUALIFIKIMI I RRUGES "AZEM HAJDARI"

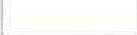

## LEGJENDA

-  RRUGE EKZISTUESE
-  OBJEKTE
-  RRETHIME
-  NDARJE PARCELASH



## BASHKIA KAMEZ

DREJTORIA E SHERBIMEVE PUBLIKE  
DREJTORIA E PROJEKTEVE DHE INVESTIMEVE  
DEPARTAMENTI I PROJEKTEVE

Dr. i Përgj. i Shërbimeve Publike	ELVIS GJIKA	
Dr. e Projekteve e Investimeve	FLORA MUÇA	
Përgj. Depart. Sektorit Projektimi	EMANUELA MEZIU	
STAFI TEKNIK PROJEKTES	Ing. ARJOLA KURTI	
	Ing. ERBUN LALA	
	Ing. EMANUELA MEZIU	
	Ing. HAJREDIN MUGRU	

Titulli i Projektit:  
RIKUALIFIKIMI I RRUGES "AZEM HAJDARI"

Faza e Projektit:  
PROJEKT ZBATIMI

Emërtimi i Planit:

PLANIMETRIA EKZISTUESE

Data e Implementimit:

Shkalla e Vizatimit:

Plota Nr.:





T-03

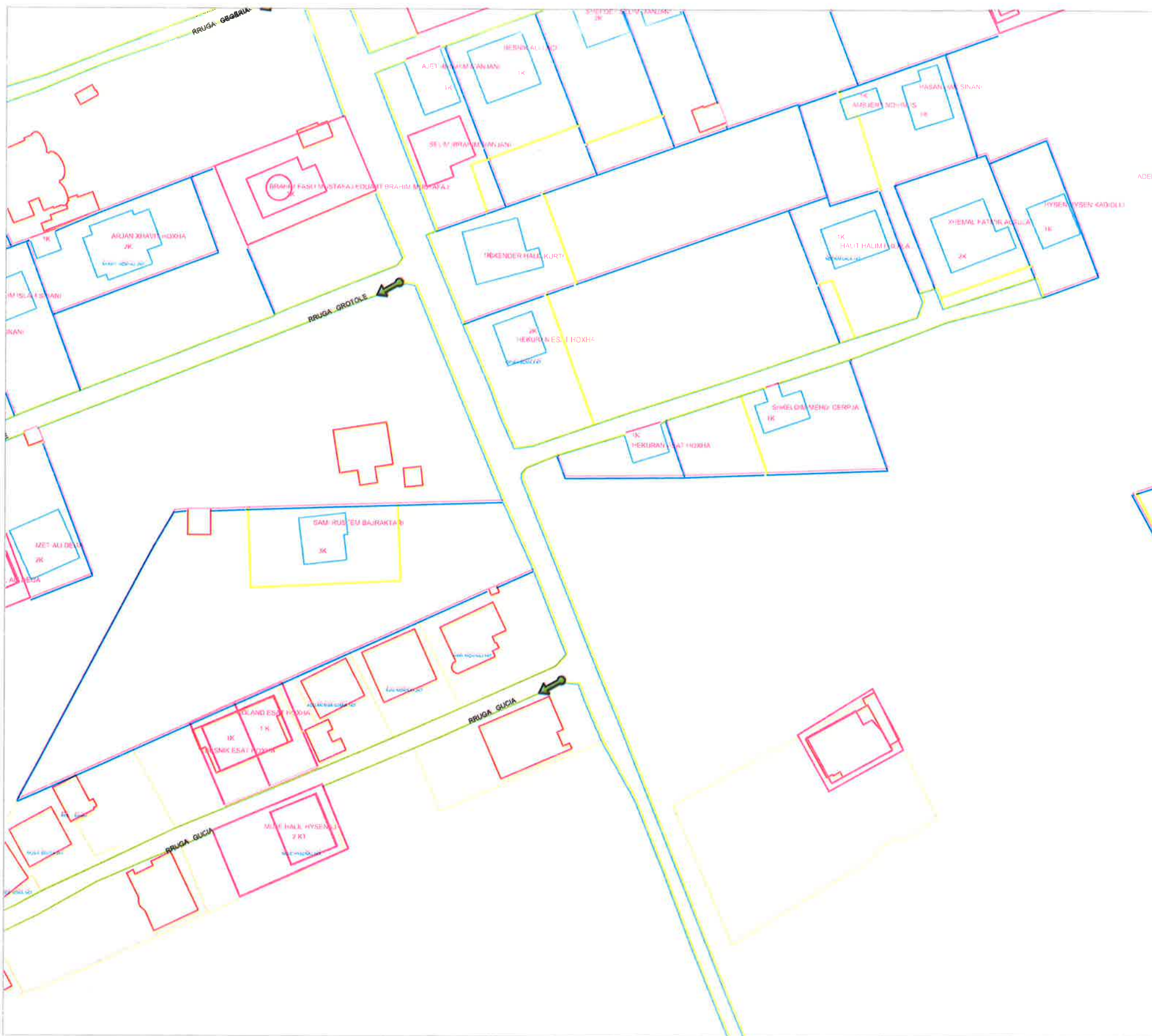

# OBJEKTI: RIKUALIFIKIMI I RRUGES "AZEM HAJDARI"



## LEGJENDA

-  RRUGJE EKZISTUESE
-  OBJEKTE
-  RRETHIME
-  NDARJE PARCELASH

**BASHKIA KAMEZ**  
 DREJTORIA E SHERBIMEVE PUBLIKE  
 DREJTORIA E PROJEKTEVE DHE INVESTIMEVE  
 DEPARTAMENTI I PROJEKTEVE

Dr. i Përgj. i Shërbimeve Publike	ELVIS GJIKA
Dr. e Projekteve e Investimeve	FLORA MUÇA
Përgj. Depart. Sektori Projektimi	EMANUELA MEZIU
Ing. ARJOLA KURTI	
Ing. ERBLIN LALA	
Ing. EMANUELA MEZIU	
Ing. HAJREDIN MUGRU	

Titulli i Projektit:  
**RIKUALIFIKIMI I RRUGES "AZEM HAJDARI"**

Faza e Projektit:  
 PROJEKT ZBATIMI

Data e Implementimit:

Shkalla e Vizimit:

Emertimi i Plotes:  
**PLANIMETRIA EKZISTUESE**

Plota Nr:  
**T-04**

# OBJEKTI: RIKUALIFIKIMI I RRUGES "AZEM HAJDARI"

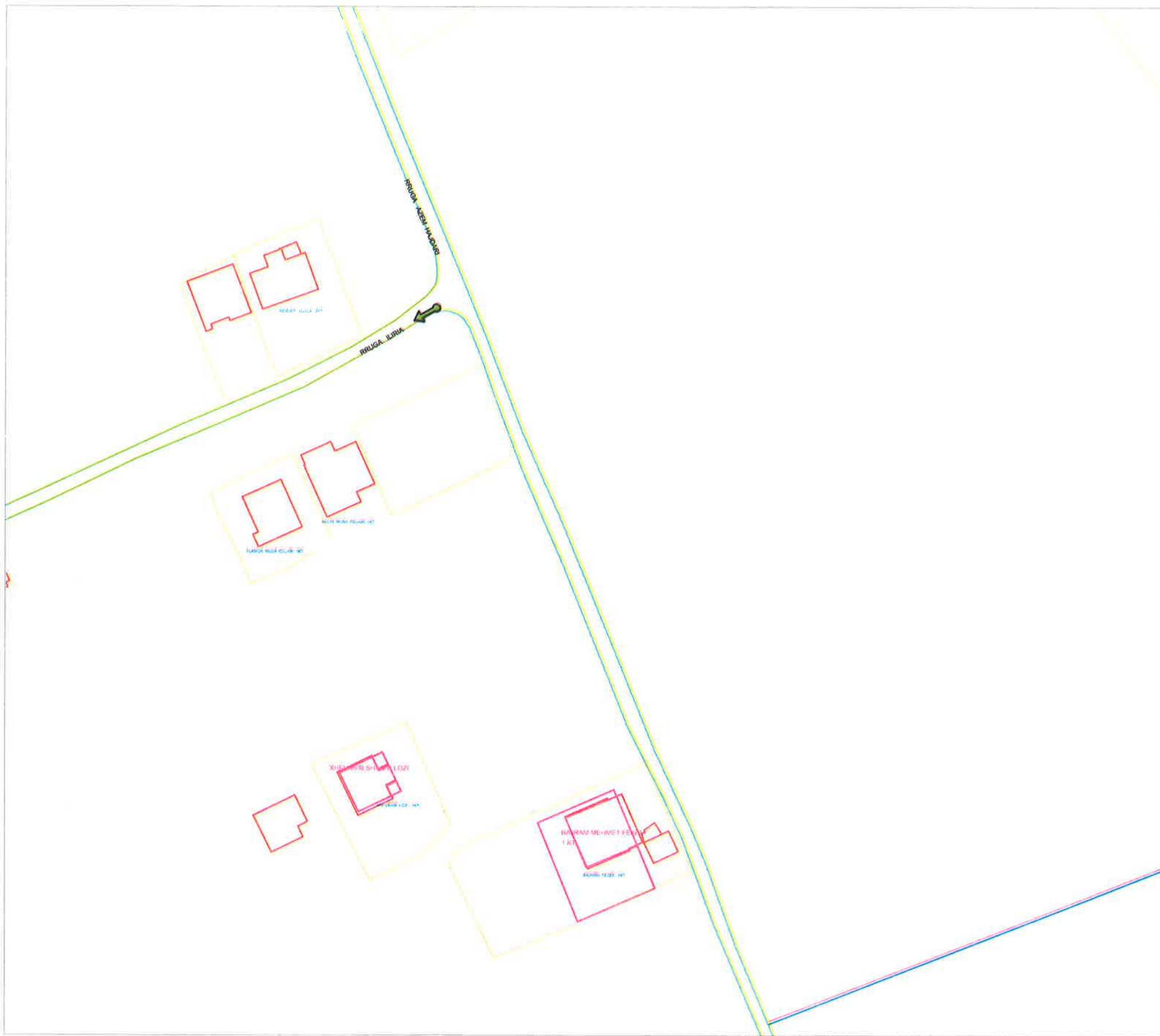

## LEGJENDA

-  RRUGE EKZISTUESE
-  OBJEKTE
-  RRETHIME
-  NDARJE PARCELASH



## BASHKIA KAMEZ

DREJTORIA E SHERBIMEVE PUBLIKE  
DREJTORIA E PROJEKTEVE DHE INVESTIMEVE  
DEPARTAMENTI I PROJEKTEVE

Dr. i Pergi. i Shërbimeve Publike	ELVIS GJIKA
Dr. e Projekteve e Investimeve	FLORA MUÇA
Pergi. Depart. Sektori Projektimi	EMANUELA MEZIU
Ing. ARJOLA KURTI	
Ing. ERBLIN LALA	
Ing. EMANUELA MEZIU	
Ing. HAJREDIN MUGRU	

Titulli i Projektit:  
**RIKUALIFIKIMI I RRUGES "AZEM HAJDARI"**

Faza e Projektit:  
PROJEKT ZBATIMI

Data e Implementimit:

Emertimi i Plotes:  
**PLANIMETRIA EKZISTUESE**

Skalla e Vizatimit:  
Plota Nr. **T-05**



# OBJEKTI: RIKUALIFIKIMI I RRUGES "AZEM HAJDARI"



## LEGJENDA

-  RRUGE EKZISTUESE
-  OBJEKTE
-  RRETHIME
-  NDAJE PARCELASH



## BASHKIA KAMEZ

DREJTORIA E SHERBIMEVE PUBLIKE  
DREJTORIA E PROJEKTEVE DHE INVESTIMEVE  
DEPARTAMENTI I PROJEKTEVE

Dr. i Pergi. i Sherbimeve Publike	ELVIS GJIKAJ	
Dr. e Projekteve e Investimeve	FLORA MUÇA	
Pergi. Depart. Sektorit Projektimi	EMANUELA MËZIU	
STAFI TEKNIK PROJEKTES	Ing. ARJOLA KURTI	
	Ing. ERBLIN LALA	
	Ing. EMANUELA MËZIU	
	Ing. HAJREDIN MUGRU	

Titulli i Projektit:	RIKUALIFIKIMI I RRUGES "AZEM HAJDARI"	Faza e Projektit:	PROJEKT ZBATIM
Emertimi i Fletes:	PLANIMETRIA EKZISTUESE	Data e Implementimit:	
		Shkalla e Vizatimit:	
		Fleta Nr.:	T-06

# OBJEKTI: RIKUALIFIKIMI I RRUGES "AZEM HAJDARI"

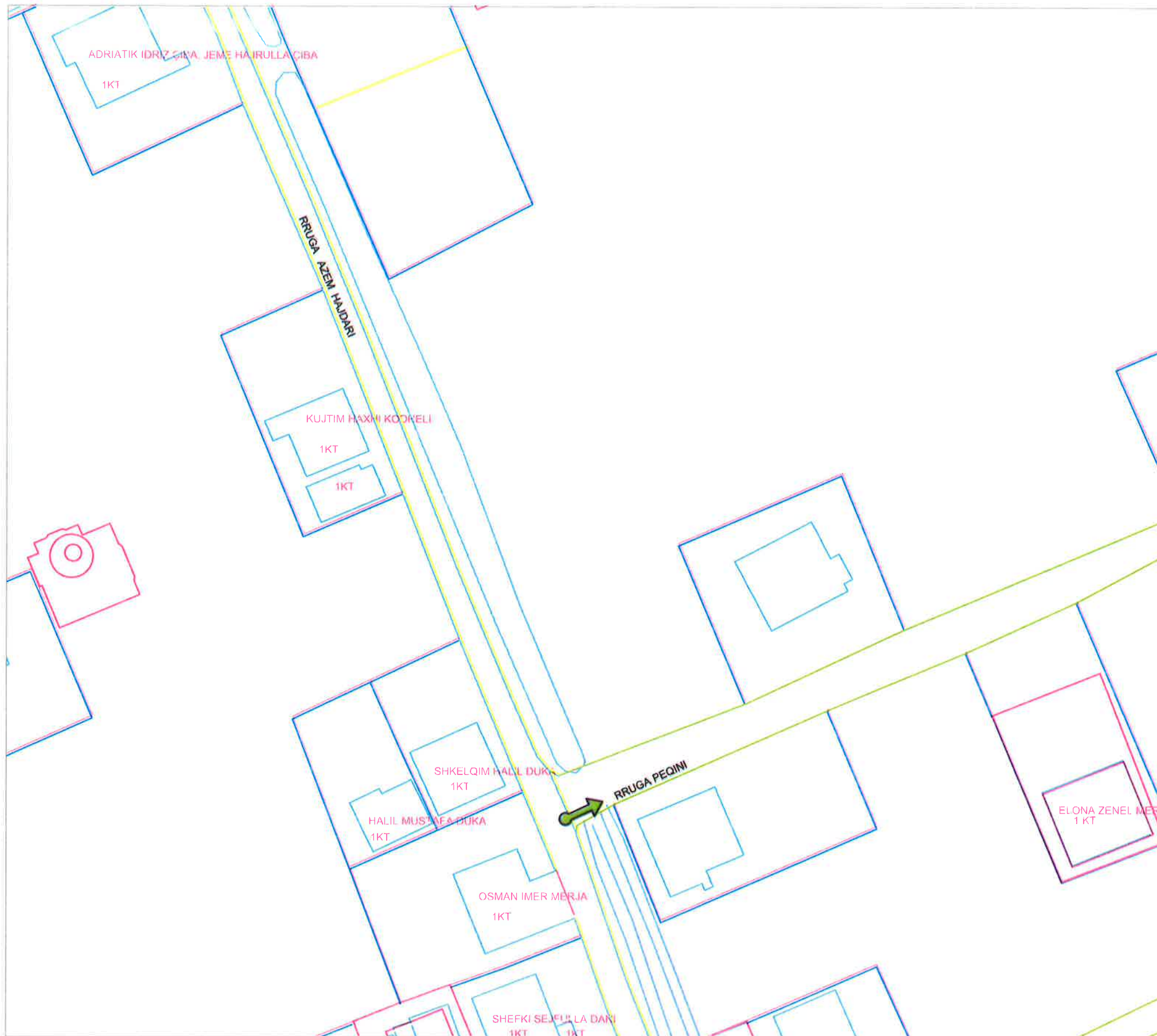

## LEGJENDA

-  RRUGE EKZISTUESE
-  OBJEKTE
-  RRETHIME
-  NDAJE PARCELASH



## BASHKIA KAMEZ

DREJTORIA E SHERBIMEVE PUBLIKE  
DREJTORIA E PROJEKTEVE DHE INVESTIMEVE  
DEPARTAMENTI I PROJEKTEVE

Dr. i Pergj. i Shërbimeve Publike	ELVIS GJIKA								
Dr. e Projekteve e Investimeve	FLORA MUÇA								
Pergj. Depart. Sektori Projektimi	EMANUELA MEZIU								
STAFI TEKNIK PROJEKTIME	<table border="1"> <tr> <td>Ing.</td> <td>ARJOLA KURTI</td> </tr> <tr> <td>Ing.</td> <td>ERBLIN LALA</td> </tr> <tr> <td>Ing.</td> <td>EMANUELA MEZIU</td> </tr> <tr> <td>Ing.</td> <td>HAJREDIN MUGRU</td> </tr> </table>	Ing.	ARJOLA KURTI	Ing.	ERBLIN LALA	Ing.	EMANUELA MEZIU	Ing.	HAJREDIN MUGRU
Ing.	ARJOLA KURTI								
Ing.	ERBLIN LALA								
Ing.	EMANUELA MEZIU								
Ing.	HAJREDIN MUGRU								

Titulli i Projektit:	RIKUALIFIKIMI I RRUGES "AZEM HAJDARI"
Faza e Projektit:	PROJEKT ZBATIMI
Data e Implementimit:	
Emertimi i Plotes:	PLANIMETRIA EKZISTUESE
Shkalla e Vizatimit:	
Fleta Nr.:	T-07



# OBJEKTI: RIKUALIFIKIMI I RRUGES "AZEM HAJDARI"

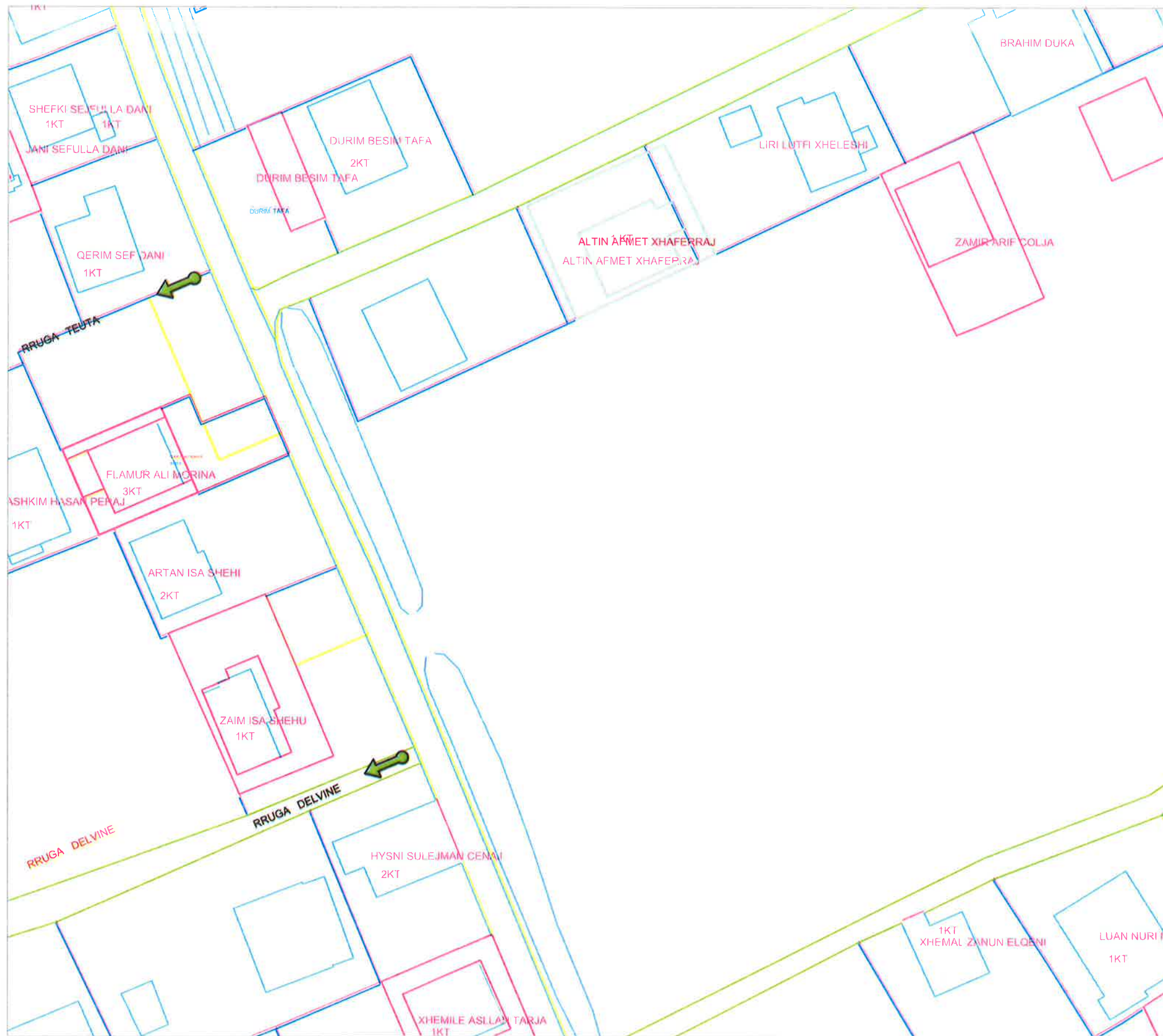

## LEGJENDA

-  RRUGE EKZISTUESE
-  OBJEKTE
-  RRETHIME
-  NDARJE PARCELASH



## BASHKIA KAMEZ

DREJTORIA E SHERBIMEVE PUBLIKE  
DREJTORIA E PROJEKTEVE DHE INVESTIMEVE  
DEPARTAMENTI I PROJEKTEVE

Dr. i Përgj. i Shërbimeve Publike	ELVIS GJIKA
Dr. e Projekteve e Investimeve	FLORA MUÇA
Përgj. Depart. Sektorit Projektimi	EMANUELA MËZIU
STAFI TEKNIK	Ing. ARJOLA KURTI
PROJEKTUES	Ing. ERBLIN LALA
	Ing. EMANUELA MËZIU
	Ing. HAJREDIN MUGRU

Titulli i Projektit:  
RIKUALIFIKIMI I RRUGES "AZEM HAJDARI"

Faza e Projektit:  
PROJEKT ZBATIMI

Emertimi i Planit:  
PLANIMETRIA EKZISTUESE

Shkalla e Vizimit:

Plota Nr.  
T-08



# OBJEKTI: RIKUALIFIKIMI I RRUGES "AZEM HAJDARI"



## LEGJENDA

-  RRUGE EKZISTUESE
-  OBJEKTE
-  RRETHIME
-  NDARJE PARCELASH



## BASHKIA KAMEZ

DREJTORIA E SHERBIMEVE PUBLIKE  
DREJTORIA E PROJEKTEVE DHE INVESTIMEVE  
DEPARTAMENTI I PROJEKTEVE

Dr. i Përgj. i Shërbimeve Publike	ELVIS GJIKA								
Dr. e Projekteve e Investimeve	FLORA MUÇA								
Përgj. Depart. Sektori Projektimi	EMANUELA MËZIU								
STAFI TEKNIK PROJEKTORES	<table border="1"> <tr> <td>Ing.</td> <td>ARJOLA KURTI</td> </tr> <tr> <td>Ing.</td> <td>ERBLIN LALA</td> </tr> <tr> <td>Ing.</td> <td>EMANUELA MËZIU</td> </tr> <tr> <td>Ing.</td> <td>HAJREDIN MUGRU</td> </tr> </table>	Ing.	ARJOLA KURTI	Ing.	ERBLIN LALA	Ing.	EMANUELA MËZIU	Ing.	HAJREDIN MUGRU
Ing.	ARJOLA KURTI								
Ing.	ERBLIN LALA								
Ing.	EMANUELA MËZIU								
Ing.	HAJREDIN MUGRU								

Titulli i Projektit: **RIKUALIFIKIMI I RRUGES "AZEM HAJDARI"**

Faza e Projektit: **PROJEKT ZBATIMI**

Data e Implementimit:

Shkalla e Vizimit:

Emertimi i Fotos: **PLANIMETRIA EKZISTUESE**



Fleta Nr. **T-09**



# OBJEKTI: RIKUALIFIKIMI I RRUGES "AZEM HAJDARI"



## LEGJENDA

-  Puseta K.U.B
-  Tub HDPE Dn315 per K.U.B



## BASHKIA KAMEZ

DREJTORIA E SHERBIMEVE PUBLIKE  
DREJTORIA E PROJEKTEVE DHE INVESTIMEVE  
DEPARTAMENTI I PROJEKTEVE

Dr. i Pergj. i Sherbimeve Publike	ELVIS GJIK	
Dr. e Projekteve e Investimeve	FLORA MUÇA	
Pergj. Depart. Sektori Projektimi	EMANUELA MEZIU	
STAFI TEKNIK	Ing. ARJOLA KURTI	
PROJEKTUES	Ing. ERBLIN LALA	
	Ing. EMANUELA MEZIU	
	Ing. HAJREDIN MUGRU	

Titulli i Projektit:	Rikualifikimi i RRUGES "AZEM HAJDARI"	Faza e Projektit:	PROJEKTZBATIMI
Emertimi i Fletes:	PLANIMETRIA KUB	Data e Implementimit:	
		Shkalla e Vizimit:	
		Fleta Nr.:	T-10



# OBJEKTI: RIKUALIFIKIMI I RRUGES "AZEM HAJDARI"



## LEGJENDA

Puseta K.U.B

Tub HDPE Dn315 per K.U.B



## BASHKIA KAMEZ

DREJTORIA E SHERBIMEVE PUBLIKE  
DREJTORIA E PROJEKTEVE DHE INVESTIMEVE  
DEPARTAMENTI I PROJEKTEVE

Dr. i Pergj. i Sherbimeve Publike	ELVIS GJIKA	
Dr. e Projekteve e Investimeve	FLORA MUÇA	
Pergj. Depart. Sektori Projektimi	EMANUELA MËZIU	
STAFI TEKNIK PROJEKTES	Ing. ARJOLA KURTI	
	Ing. ERBLIN LALA	
	Ing. EMANUELA MËZIU	
	Ing. HAJREDIN MUGRU	

Titulli i Projektit:	Faza e Projektit:
RIKUALIFIKIMI I RRUGES "AZEM HAJDARI"	PROJEKT ZBATIMI
Emerenti i Flotes:	Data e Implementimit:
PLANIMETRIA KUB	
	Shtylla e Vizatimit:
	Flota Nr.:
	T-11



# OBJEKTI: RIKUALIFIKIMI I RRUGES "AZEM HAJDARI"

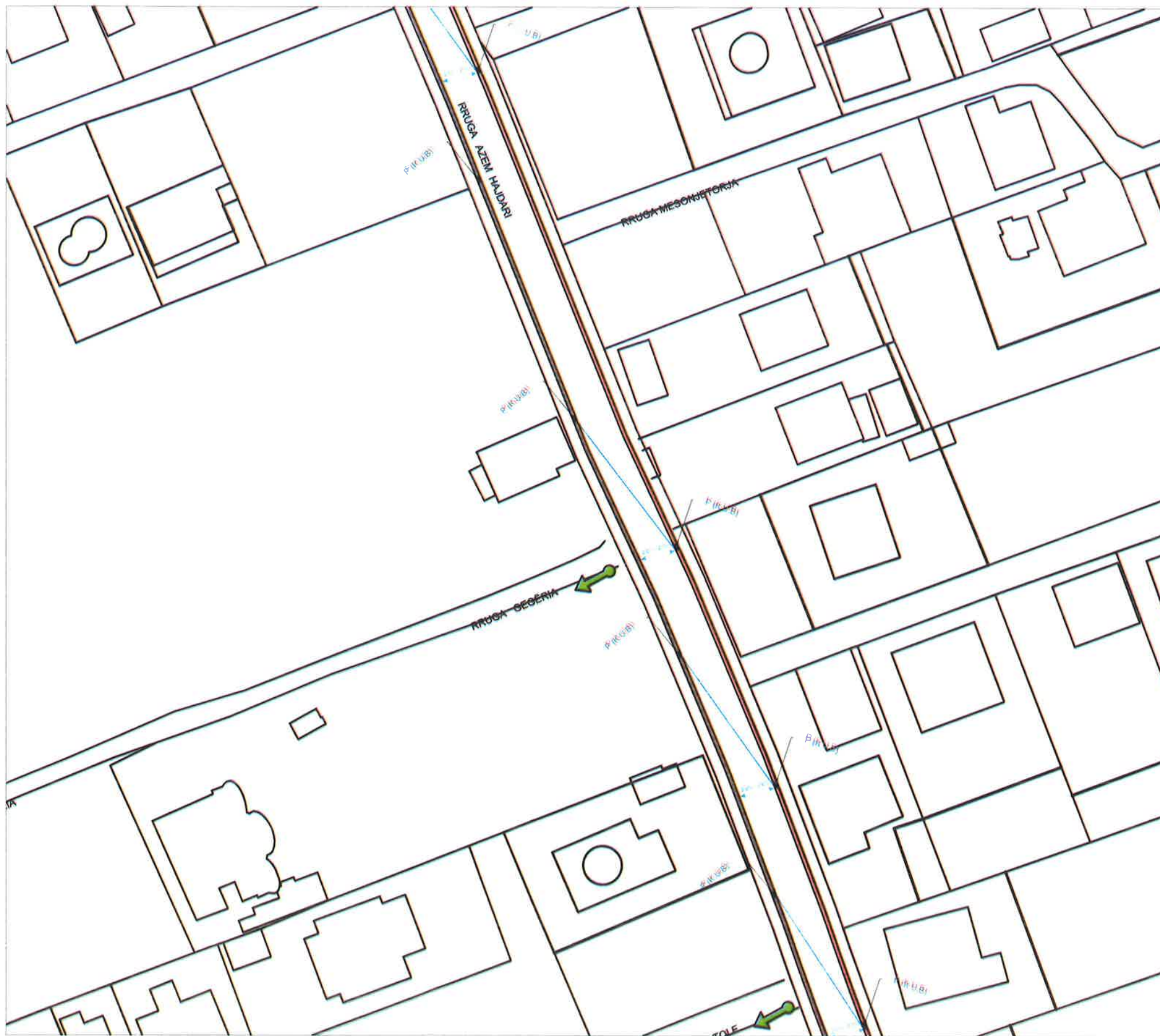

## LEGJENDA

 Puseta K.U.B

 Tub HDPE Dn315 per K.U.B



## BASHKIA KAMEZ

DREJTORIA E SHËRBIMEVE PUBLIKE  
DREJTORIA E PROJEKTEVE DHE INVESTIMEVE  
DEPARTAMENTI I PROJEKTEVE

Dir. i Përgj. i Shërbimeve Publike	ELVIS GJIKA	
Dir. e Projekteve e Investimeve	FLORA MUÇA	
Përgj. Depart. Sektori Projektimi	EMANUELA MEZIU	
STAFI TEKNIK PROJEKTES	Ing. ARJOLA KURTI	
	Ing. ERBUN LALA	
	Ing. EMANUELA MEZIU	
	Ing. HAJREDIN MUGRU	

Titulli i Projektit:	RIKUALIFIKIMI I RRUGES "AZEM HAJDARI"	Faza e Projektit:	PROJEKT ZBATIMI
Emertimi i Fotos:	PLANIMETRIA KUB	Data e Implementimit:	
		Shtetja e Vizatimit:	
		Fleta Nr.:	T-12



# OBJEKTI: RIKUALIFIKIMI I RRUGES "AZEM HAJDARI"

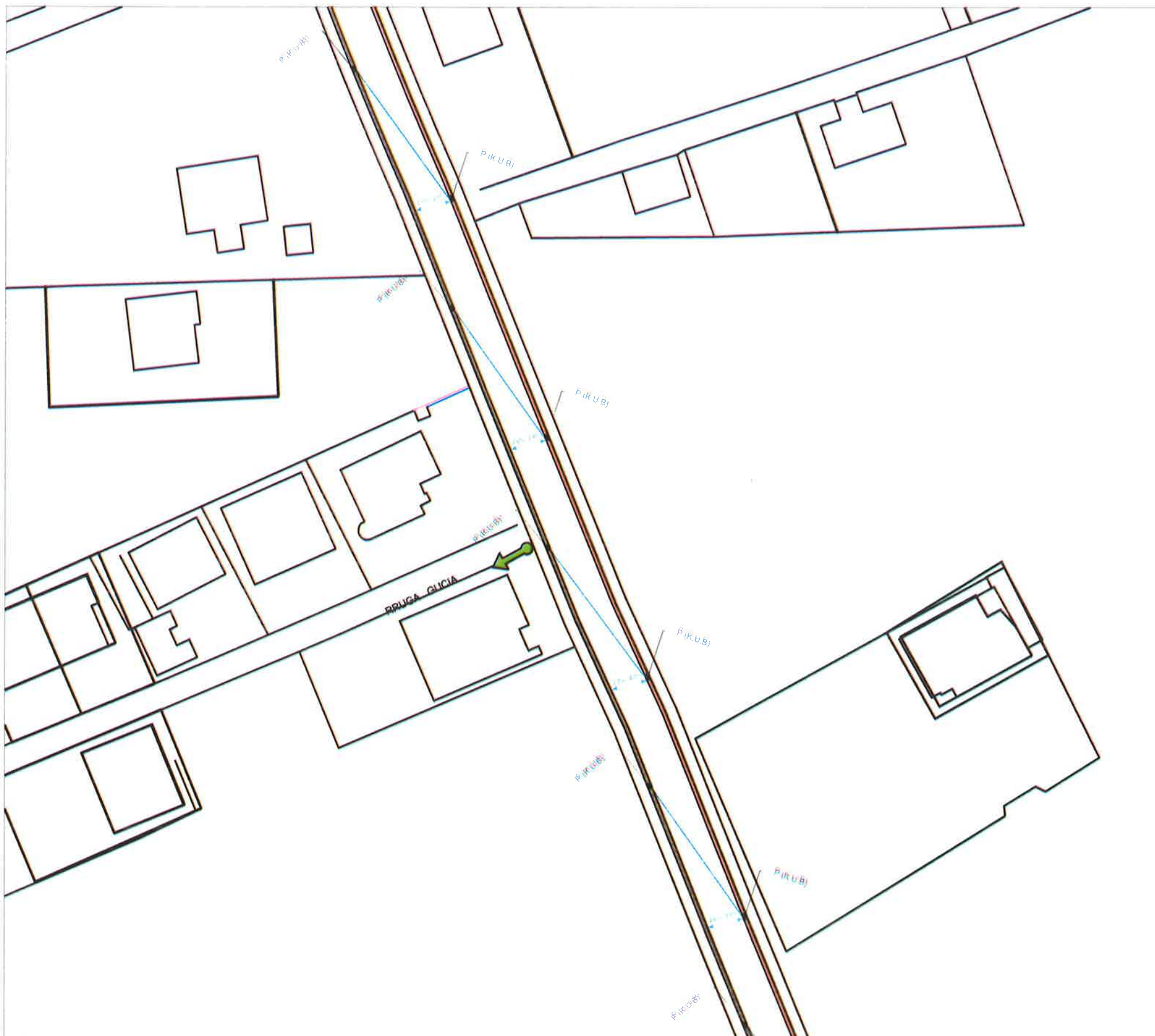

## LEGJENDA



Puseta K.U.B



Tub HDPE Dn315 per K.U.B



## BASHKIA KAMEZ

DREJTORIA E SHERBIMEVE PUBLIKE  
DREJTORIA E PROJEKTEVE DHE INVESTIMEVE  
DEPARTAMENTI I PROJEKTEVE

Dr. i Pergj. i Sherbimeve Publike	ELVIS GJIKA
Dr. e Projekteve e Investimeve	FLORA MUÇA
Pergj. Depart. Sektori Projektimi	EMANUELA MEZIU
STAFI TEKNIK PROJEKTES	
Ing.	ARJOLA KURTI
Ing.	ERBLIN LALA
Ing.	EMANUELA MEZIU
Ing.	HAJREDIN MUGRU

Titulli i Projektit:	Faza e Projektit:
RIKUALIFIKIMI I RRUGES "AZEM HAJDARI"	PROJEKT ZBATIM
Emertimi i Plotes:	Data e Implementimit:
PLANIMETRIA KUB	
	Shkalla e Vizimit:
	Fletë Nr.:
	T-13



# OBJEKTI: RIKUALIFIKIMI I RRUGES "AZEM HAJDARI"



## LEGJENDA



Puseta K.U.B



Tub HDPE Dn315 per K.U.B



## BASHKIA KAMEZ

DREJTORIA E SHERBIMEVE PUBLIKE  
DREJTORIA E PROJEKTEVE DHE INVESTIMEVE  
DEPARTAMENTI I PROJEKTEVE

Dr. i Pergj. i Sherbimeve Publike	ELVIS GJIKI
Dr. e Projekteve e Investimeve	FLORA MUÇA
Pergj. Depart. Sektori Projektimi	EMANUELA MEZIU
STAFI TEKNIK I PROJEKTEVE	
Ing.	ARJOLA KURTI
Ing.	ERBLIN LALA
Ing.	EMANUELA MEZIU
Ing.	HAJREDIN MUGRU

Titulli i Projektit:  
RIKUALIFIKIMI I RRUGES "AZEM HAJDARI"

Faza e Projektit:  
PROJEKT ZBATIM

Emertimi i Plotes:  
PLANIMETRIA KUB

Data e Implementimit:

Dihalla e Vlastimit:

Fleta Nr.

T-14



# OBJEKTI: RIKUALIFIKIMI I RRUGES "AZEM HAJDARI"

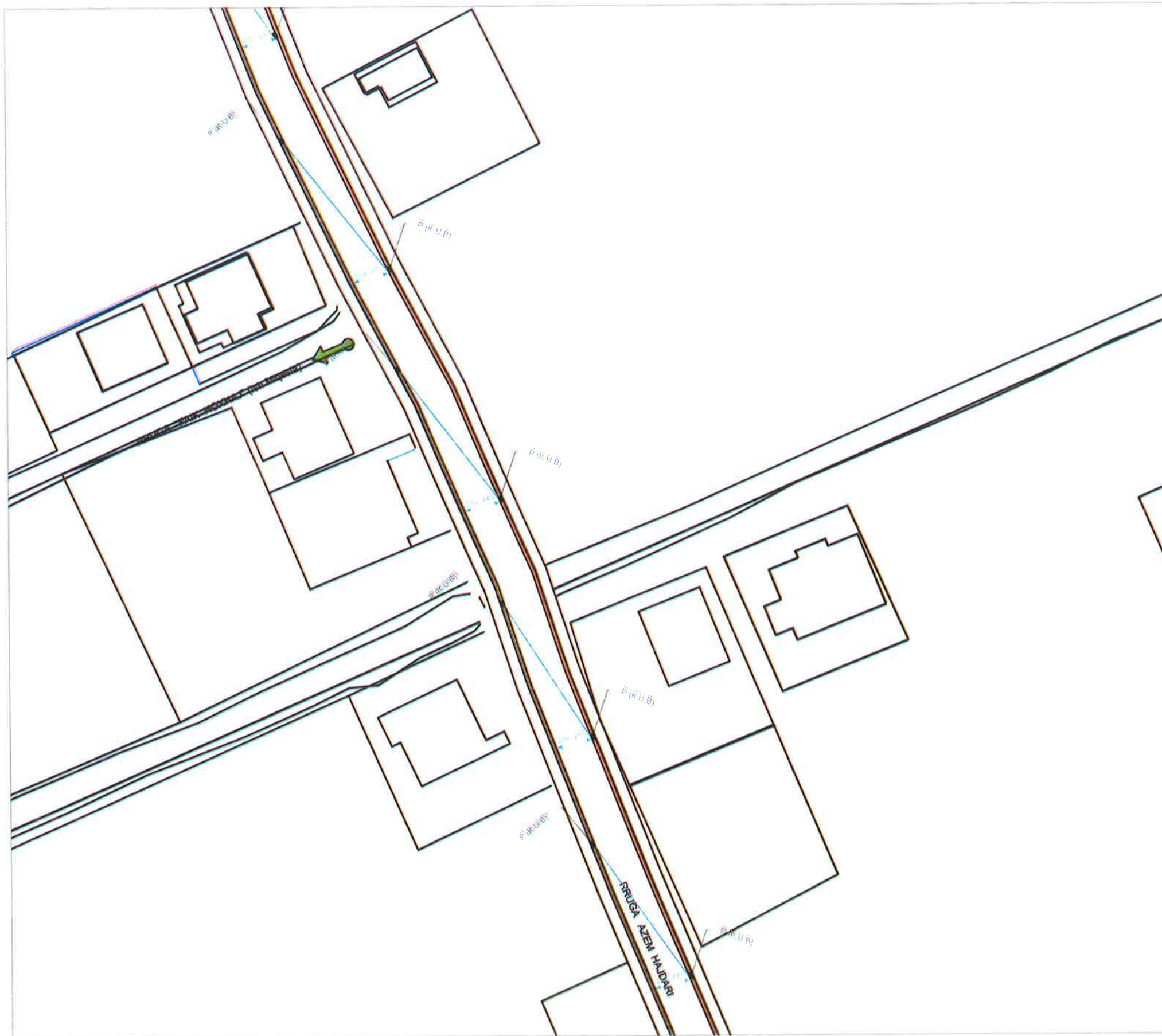

## LEGJENDA

 Puseta K.U.B

 Tub HDPE Dn315 per K.U.B



## BASHKIA KAMEZ

DREJTORIA E SHERBIMEVE PUBLIKE  
DREJTORIA E PROJEKTEVE DHE INVESTIMEVE  
DEPARTAMENTI I PROJEKTEVE

Dr. i Pergj. i Shërbimeve Publike	ELVIS GJIKA
Dr. e Projekteve e Investimeve	FLORA MUÇA
Pergj. Depart. Sektori Projektimi	EMANUELA MËZIU
STAFI TEKNIK	Ing. ARJOLA KURTI
PROJEKTES	Ing. ERBLIN LALA
	Ing. EMANUELA MËZIU
	Ing. HAJREDIN MUGRU

Titulli i Projektit:  
RIKUALIFIKIMI I RRUGES "AZEM HAJDARI"

Emertimi i Planos:  
**PLANIMETRIA KUB**

Faza e Projektit:  
PROJEKT ZBATIMI

Data e Implementimit:

Shkalla e Vërtimit:

Plota Nr.:

**T-15**



# OBJEKTI: RIKUALIFIKIMI I RRUGES "AZEM HAJDARI"



## LEGJENDA

 Puseta K.U.B

 Tub HDPE Dn315 per K.U.B



## BASHKIA KAMEZ

DREJTORIA E SHERBIMEVE PUBLIKE  
DREJTORIA E PROJEKTEVE DHE INVESTIMEVE  
DEPARTAMENTI I PROJEKTEVE

Dr. i Pergj. i Sherbimeve Publike	ELVIS GJIKA	
Dr. e Projekteve e Investimeve	FLORA MUÇA	
Pergj. Depart. Sektori Projektimi	EMANUELA MEZIU	
STAFI BEZEMK PROJEKTES	Ing. ARJOLA KURTI	
	Ing. ERBLIN LALA	
	Ing. EMANUELA MEZIU	
	Ing. HAJREDIN MUGRU	

Titulli i Projektit:	RIKUALIFIKIMI I RRUGES "AZEM HAJDARI"	Faza e Projektit:	PROJEKT ZBATIMI
Emertimi i Plotes:	PLANIMETRIA KUB	Data e Implementimit:	
		Skalla e Vizimit:	
		Plota Nr.:	T-16



# OBJEKTI: RIKUALIFIKIMI I RRUGES "AZEM HAJDARI"



## LEGJENDA

 Puseta K.U.B

 Tub HDPE Dn315 per K.U.B



## BASHKIA KAMEZ

DREJTORIA E SHERBIMEVE PUBLIKE  
DREJTORIA E PROJEKTEVE DHE INVESTIMEVE  
DEPARTAMENTI I PROJEKTEVE

Dr. i Pergj. i Sherbimeve Publike	ELVIS GJIKA
Dr. e Projekteve e Investimeve	FLORA MUÇA
Pergj. Depart. Sektori Projektimi	EMANUELA MEZIU
STAFI TEKNIK PROJEKTES	
Ing. ARJOLA KURTI	
Ing. ERBLIN LALA	
Ing. EMANUELA MEZIU	
Ing. HAJREDIN MUGRU	

Titulli i Projektit:  
RIKUALIFIKIMI I RRUGES "AZEM HAJDARI"

Faza e Projektit:  
PROJEKT ZBATIMI

Data e Implementimit:

Shkalla e Vizimit:

Emertimi i Planos:

PLANIMETRIA KUB

Plota Nr:

T-17



# OBJEKTI: RIKUALIFIKIMI I RRUGES "AZEM HAJDARI"



## LEGJENDA



TROTUAR

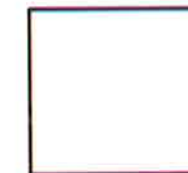

OBJEKTE



## BASHKIA KAMEZ

DREJTORIA E SHERBIMEVE PUBLIKE  
DREJTORIA E PROJEKTEVE DHE INVESTIMEVE  
DEPARTAMENTI I PROJEKTEVE

Dr. i Pergj. i Shërbimeve Publike	ELVIS GJIKA	
Dr. e Projekteve e Investimeve	FLORA MUÇA	
Pergj. Depart. Sektori Projektimi	EMANUELA MEZIU	
STAFI TEKNIK PROJEKTES	Ing. ARJOLA KURTI	
	Ing. ERBLIN LALA	
	Ing. EMANUELA MEZIU	
	Ing. HAJREDIN MUGRU	

Titulli i Projektit:  
RIKUALIFIKIMI I RRUGES "AZEM HAJDARI"

Faza e Projektit:  
PROJEKT ZBATIMI

Data e Implementimit:

Emertimi i Planit:

PLANIMETRIA TROTUARI

Shtylla e Vizimit:

Plan Nr.

T-18



# OBJEKTI: RIKUALIFIKIMI I RRUGES "AZEM HAJDARI"



## LEGJENDA



TROTUAR



OBJEKTE



## BASHKIA KAMEZ

DREJTORIA E SHERBIMEVE PUBLIKE  
DREJTORIA E PROJEKTEVE DHE INVESTIMEVE  
DEPARTAMENTI I PROJEKTEVE

Dr. i Pergj. i Sherbimeve Publike	ELVIS GJIKA	
Dr. e Projekteve e Investimeve	FLORA MUÇA	
Pergj. Depart. Sektori Projektimi	EMANUELA MEZIU	
STAFI TEKNIK	Ing. ARJOLA KURTI	
PROJEKTUES	Ing. ERBLIN LALA	
	Ing. EMANUELA MEZIU	
	Ing. HAJREDIN MUGRU	

Titulli i Projektit:  
RIKUALIFIKIMI I RRUGES "AZEM HAJDARI"

Emertimi i Fotos:

PLANIMETRIA TROTUARI

Faza e Projektit:  
PROJEKT ZBATIMI

Data e Implementimit:

Shkalla e Vizatimit:

Fleta Nr.

T-19



# OBJEKTI: RIKUALIFIKIMI I RRUGES "AZEM HAJDARI"



## LEGJENDA



TROTUAR



OBJEKTE



**BASHKIA KAMEZ**

DREJTORIA E SHERBIMEVE PUBLIKE  
DREJTORIA E PROJEKTEVE DHE INVESTIMEVE  
DEPARTAMENTI I PROJEKTEVE

Dr. i Pergj. i Sherbimeve Publike	ELVIS GJIKA	
Dr. e Projekteve e Investimeve	FLORA MUÇA	
Pergj. Depart. Sektori Projektimi	EMANUELA MËZIU	
STAFI TEKNIK PROJEKTORES	Ing. ARJOLA KURTI	
	Ing. ERBLIN LALA	
	Ing. EMANUELA MËZIU	
	Ing. HAJREDIN MUGRU	

Titulli i Projektit:  
RIKUALIFIKIMI I RRUGES "AZEM HAJDARI"

Faza e Projektit:  
PROJEKT ZBATIMI

Data e Implementimit:

Emertimi i Plotes:

**PLANIMETRIA TROTUARI**

Shkalla e Vizatimit:

Fleta Nr.



**T-20**



# OBJEKTI: RIKUALIFIKIMI I RRUGES "AZEM HAJDARI"



## LEGJENDA

-  TROTUAR
-  OBJEKTE



## BASHKIA KAMEZ

DREJTORIA E SHERBIMEVE PUBLIKE  
DREJTORIA E PROJEKTEVE DHE INVESTIMEVE  
DEPARTAMENTI I PROJEKTEVE

Dr. i Pergj. i Sherbimeve Publike	ELVIS GJICA
Dr. e Projekteve e Investimeve	FLORA MUÇA
Pergj. Depart. Sektori Projektimi	EMANUELA MËZIU
STAFI TEKNIK	
PROJEKTUES	
Ing. ARJOLA KURTI	
Ing. ERBLIN LALA	
Ing. EMANUELA MËZIU	
Ing. HAJREDIN MUGRU	

Titulli i Projektit:		Faza e Projektit:
RIKUALIFIKIMI I RRUGES "AZEM HAJDARI"		PROJEKT ZBATIMI
Emertimi i Fletës:		Data e Implementimit:
PLANIMETRIA TROTUARI		
		Shkalla e Vizatimit:
		Fleta Nr.:
		T-21



# OBJEKTI: RIKUALIFIKIMI I RRUGES "AZEM HAJDARI"



## LEGJENDA



TROTUAR



OBJEKTE



## BASHKIA KAMEZ

DREJTORIA E SHERBIMEVE PUBLIKE  
DREJTORIA E PROJEKTEVE DHE INVESTIMEVE  
DEPARTAMENTI I PROJEKTEVE

Dr. i Pergi. i Sherbimeve Publike	ELVIS GJIKA
Dr. e Projekteve e Investimeve	FLORA MUÇA
Pergi. Depart. Sektori Projektimi	EMANUELA MËZIU
STARI TEKNIK PROJEKTES	
Ing. ARJOLA KURTI	
Ing. ERBLIN LALA	
Ing. EMANUELA MËZIU	
Ing. HAJREDIN MUGRU	

Titulli i Projektit:		Faza e Projektit: PROJEKT ZBATIMI
RIKUALIFIKIMI I RRUGES "AZEM HAJDARI"		Data e Implementimit:
Emertimi i Pictes:		Shkalla e Vizatimit:
PLANIMETRIA TROTUARI		Fleta Nr: T-22



# OBJEKTI: RIKUALIFIKIMI I RRUGES "AZEM HAJDARI"

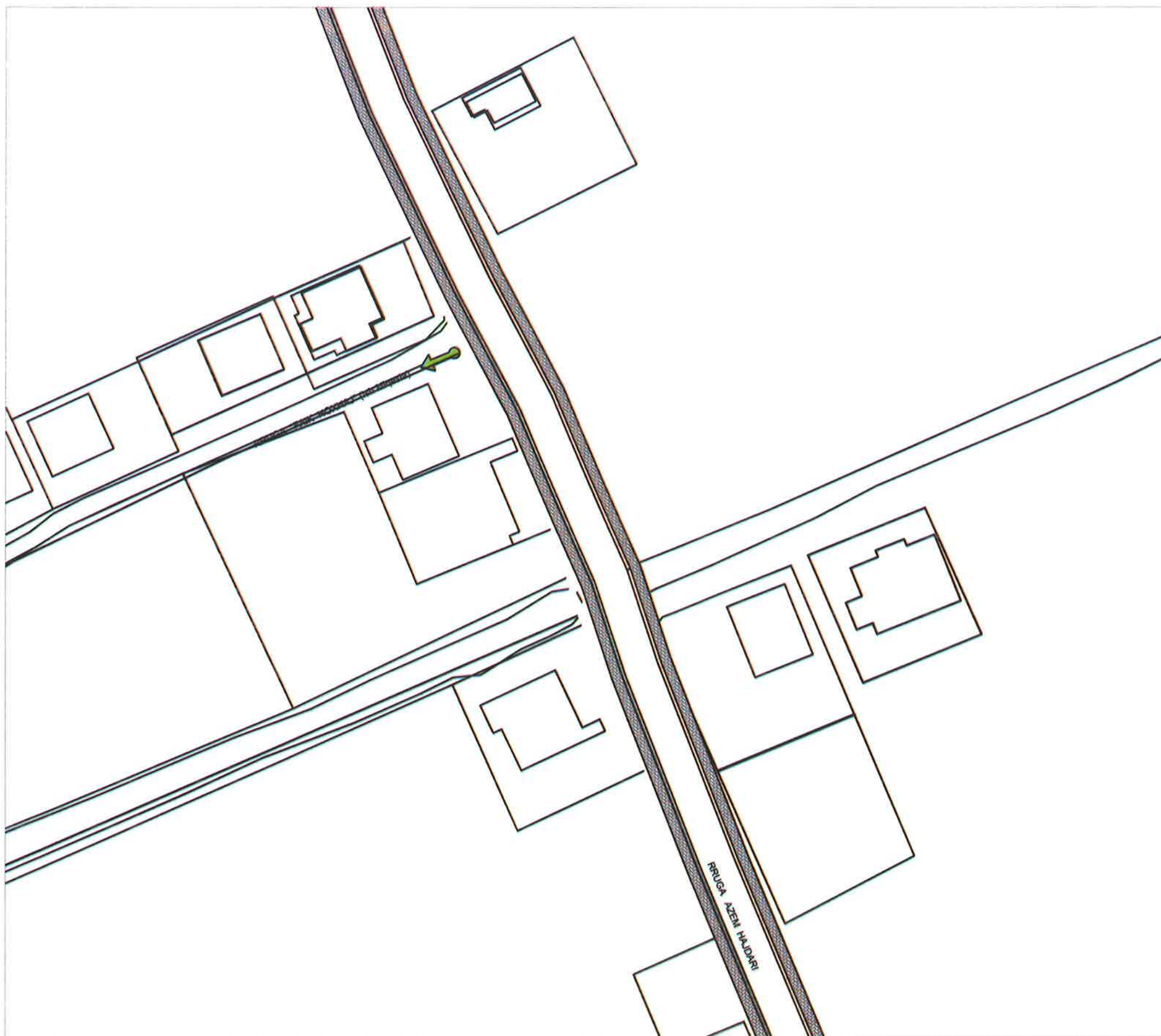

## LEGJENDA



TROTUAR



OBJEKTE



## BASHKIA KAMEZ

DREJTORIA E SHERBIMEVE PUBLIKE  
DREJTORIA E PROJEKTEVE DHE INVESTIMEVE  
DEPARTAMENTI I PROJEKTEVE

Dr. i Përgj. i Shërbimeve Publike	ELVIS GJIKA								
Dr. e Projekteve e Investimeve	FLORA MUÇA								
Përgj. Depart. Sektori Projektimi	EMANUELA MËZIU								
STAFI TEKNIK PROJEKTES	<table border="1"> <tr> <td>Ing.</td> <td>ARJOLA KURTI</td> </tr> <tr> <td>Ing.</td> <td>ERBLIN LALA</td> </tr> <tr> <td>Ing.</td> <td>EMANUELA MËZIU</td> </tr> <tr> <td>Ing.</td> <td>HAJREDIN MUGRU</td> </tr> </table>	Ing.	ARJOLA KURTI	Ing.	ERBLIN LALA	Ing.	EMANUELA MËZIU	Ing.	HAJREDIN MUGRU
Ing.	ARJOLA KURTI								
Ing.	ERBLIN LALA								
Ing.	EMANUELA MËZIU								
Ing.	HAJREDIN MUGRU								

Titulli i Projektit:  
RIKUALIFIKIMI I RRUGES "AZEM HAJDARI"

Faza e Projektit:  
PROJEKT ZBATIMI

Emertimi i Plotes:

PLANIMETRIA TROTUARI

Data e Implementimit:

Shkalla e Vizatimit:

Fleta Nr.

T-23



# OBJEKTI: RIKUALIFIKIMI I RRUGES "AZEM HAJDARI"



## LEGJENDA

 TROTUAR

 OBJEKTE



## BASHKIA KAMEZ

DREJTORIA E SHERBIMEVE PUBLIKE  
DREJTORIA E PROJEKTEVE DHE INVESTIMEVE  
DEPARTAMENTI I PROJEKTEVE

Dr. i Pergj. i Sherbimeve Publike	ELVIS GJIKA	
Dr. e Projekteve e Investimeve	FLORA MUÇA	
Pergj. Depart. Sektori Projektimi	EMANUELA MEZIU	
STAFI TEKNIK PROJEKTES	Ing. ARJOLA KURTI	
	Ing. ERBLIN LALA	
	Ing. EMANUELA MEZIU	
	Ing. HAJREDIN MUGRU	

**Titulli i Projektit:**  
RIKUALIFIKIMI I RRUGES "AZEM HAJDARI"

**Faza e Projektit:**  
PROJEKT ZBATIMI

**Emertimi i Plotes:**  
PLANIMETRIA TROTUARI

**Shkalla e Vizatimit:**  
Plota Nr.  
T-24



# OBJEKTI: RIKUALIFIKIMI I RRUGES "AZEM HAJDARI"



## LEGJENDA



TROTUAR



OBJEKTE



## BASHKIA KAMEZ

DREJTORIA E SHERBIMEVE PUBLIKE  
DREJTORIA E PROJEKTEVE DHE INVESTIMEVE  
DEPARTAMENTI I PROJEKTEVE

Dr. i Pergj. i Shërbimeve Publike	ELVIS GJIKA
Dr. e Projekteve e Investimeve	FLORA MUÇA
Pergj. Depart. Sektori Projektimi	EMANUELA MËZIU
STAFI TEKNIK	Ing. ARJOLA KURTI
PROJEKTUES	Ing. ERBLIN LALA
	Ing. EMANUELA MËZIU
	Ing. HAJREDIN MUGRU

**Titulli i Projektit:**  
RIKUALIFIKIMI I RRUGES "AZEM HAJDARI"

**Emertimi i Planit:**  
PLANIMETRIA TROTUARI

**Faza e Projektit:**  
PROJEKT ZBATIMI

**Data e Implementimit:**

**Shkalla e Vizimit:**

**Plota Nr.:**

T-25



# OBJEKTI: RIKUALIFIKIMI I RRUGES "AZEM HAJDARI"



## LEGJENDA



SHTYLLA ELEKTRIKE



TUB KARROGATO  
PER TELEFONINE



TUB KARROGATO NDRICIMI  
DHE ELEKTRIKUN



## BASHKIA KAMEZ

DREJTORIA E SHERBIMEVE PUBLIKE  
DREJTORIA E PROJEKTEVE DHE INVESTIMEVE  
DEPARTAMENTI I PROJEKTEVE

Dr. i Përgj. i Shërbimeve Publike	ELVIS GJIKA
Dr. e Projekteve e Investimeve	FLORA MUÇA
Përgj. Depart. Sektori Projektimi	EMANUELA MËZIU
STAFI TEKNIK	Ing. ARJOLA KURTI
PROJEKTUES	Ing. ERLIN LALA
	Ing. EMANUELA MËZIU
	Ing. HAJREDIN MUGRU

Titulli i Projektit:  
RIKUALIFIKIMI I RRUGES "AZEM HAJDARI"

Faza e Projektit:  
PROJEKT ZBATIM

Emertimi i Planit:

PLANIMETRIA NDRICIMI

Data e Implementimit:

Shkalla e Vizatimit:

Plota Nr.:

T-26



# OBJEKTI: RIKUALIFIKIMI I RRUGES "AZEM HAJDARI"



## LEGJENDA



SHTYLLA ELEKTRIKE



TUB KARROGATO  
PER TELEFONINE



TUB KARROGATO NDRICIMI  
DHE ELEKTRIKUN



## BASHKIA KAMEZ

DREJTORIA E SHERBIMEVE PUBLIKE  
DREJTORIA E PROJEKTEVE DHE INVESTIMEVE  
DEPARTAMENTI I PROJEKTEVE

Dr. i Përgj. i Shërbimeve Publike	ELVIS GJIKA
Dr. e Projekteve e Investimeve	FLORA MUÇA
Përgj. Depart. Sektori Projektimi	EMANUELA MËZIU
STAFI TEKNIK PROJEKTRUES	Ing. ARJOLA KURTI
	Ing. ERLIN LALA
	Ing. EMANUELA MËZIU
	Ing. HAJREDIN MUGRU

Titulli i Projektit:  
RIKUALIFIKIMI I RRUGES "AZEM HAJDARI"

Faza e Projektit:  
PROJEKT ZBATIMI

Data e Implementimit:

Shkalla e Vërtimit:

Emertimi i Plotes:

PLANIMETRIA NDRICIMI

Fleta Nr.

T-27



# OBJEKTI: RIKUALIFIKIMI I RRUGES "AZEM HAJDARI"



## LEGJENDA



SHTYLLA ELEKTRIKE



TUB KARROGATO  
PER TELEFONINE



TUB KARROGATO NDRICIMI  
DHE ELEKTRIKUN



## BASHKIA KAMEZ

DREJTORIA E SHERBIMEVE PUBLIKE  
DREJTORIA E PROJEKTEVE DHE INVESTIMEVE  
DEPARTAMENTI I PROJEKTEVE

Dr. i Pergj. i Sherbimeve Publike	ELVIS GJIKA
Dr. e Projekteve e Investimeve	FLORA MUÇA
Pergj. Depart. Sektori Projektimi	EMANUELA MEZIU
STAFI TEKNIK	
PROJEKTUES	
Ing. ARJOLA KURTI	
Ing. ERBLIN LALA	
Ing. EMANUELA MEZIU	
Ing. HAJREDIN MUGRU	

Titulli i Projektit:  
RIKUALIFIKIMI I RRUGES "AZEM HAJDARI"

Faza e Projektit:  
PROJEKT ZBATIMI

Emertimi i Fletes:

PLANIMETRIA NDRICIMI

Data e Implementimit:

Shtalla e Vizatimit:

Fleta Nr.:

T-28



# OBJEKTI: RIKUALIFIKIMI I RRUGES "AZEM HAJDARI"

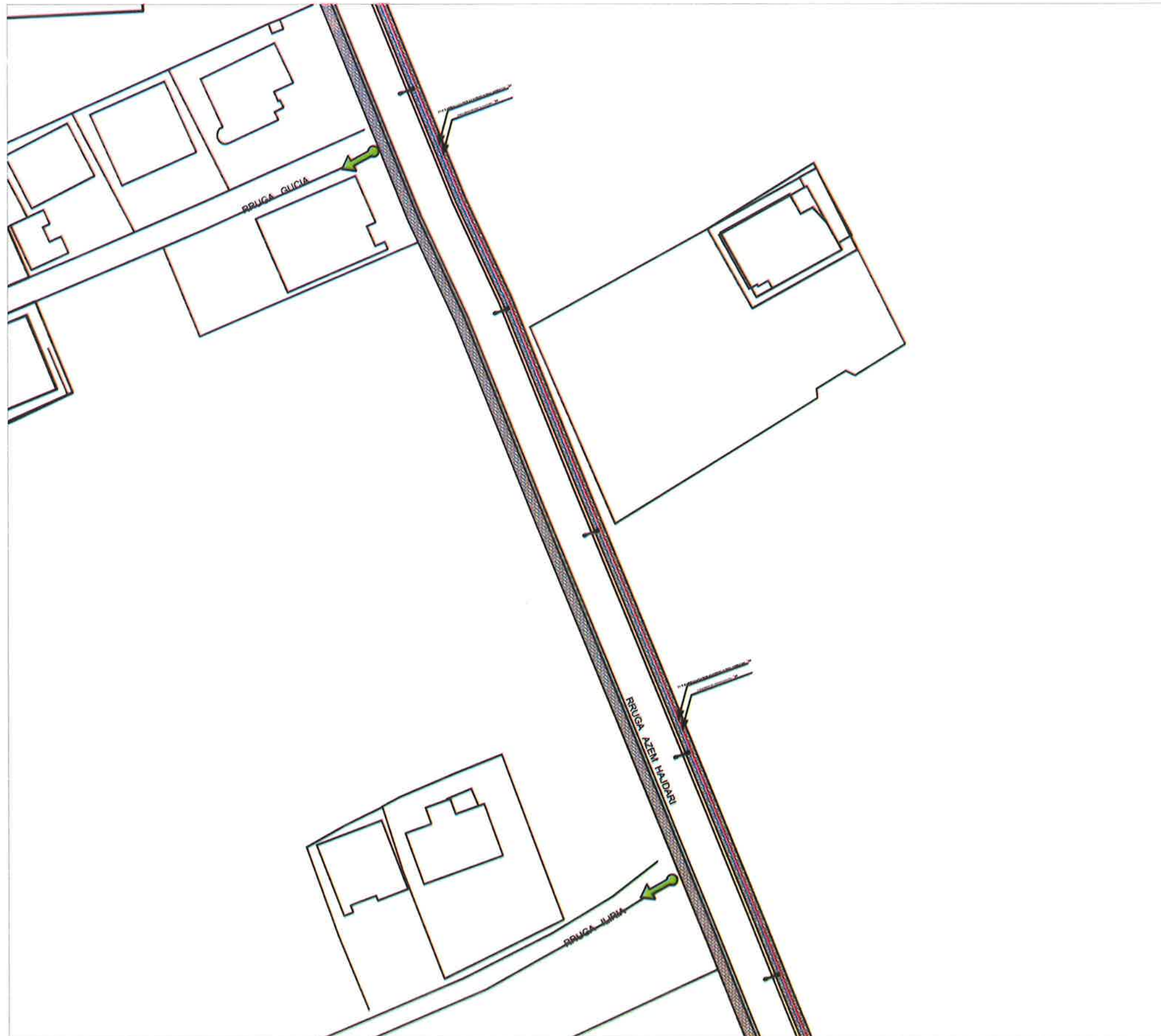

## LEGJENDA



SHTYLLA ELEKTRIKE



TUB KARROGATO  
PER TELEFONINE



TUB KARROGATO NDRICIMI  
DHE ELEKTRIKUN



## BASHKIA KAMEZ

DREJTORIA E SHERBIMEVE PUBLIKE  
DREJTORIA E PROJEKTEVE DHE INVESTIMEVE  
DEPARTAMENTI I PROJEKTEVE

Dr. i Pergj. i Sherbimeve Publike	ELVIS GJIKA	
Dr. e Projekteve e Investimeve	FLORA MUÇA	
Pergj. Depart. Sektori Projektimi	EMANUELA MËZIU	
STAFI TEKNIK	Ing. ARJOLA KURTI	
PROJEKTES	Ing. ERBLIN LALA	
	Ing. EMANUELA MËZIU	
	Ing. HAJREDIN MUGRU	

Titulli i Projektit:  
RIKUALIFIKIMI I RRUGES "AZEM HAJDARI"

Faza e Projektit:  
PROJEKT ZBATIMI

Data e Implementimit:

Shkalla e Vizatimit:

Emertimi i Fletes:

PLANIMETRIA NDRICIMI

Fleta Nr.:

T-29



# OBJEKTI: RIKUALIFIKIMI I RRUGES "AZEM HAJDARI"

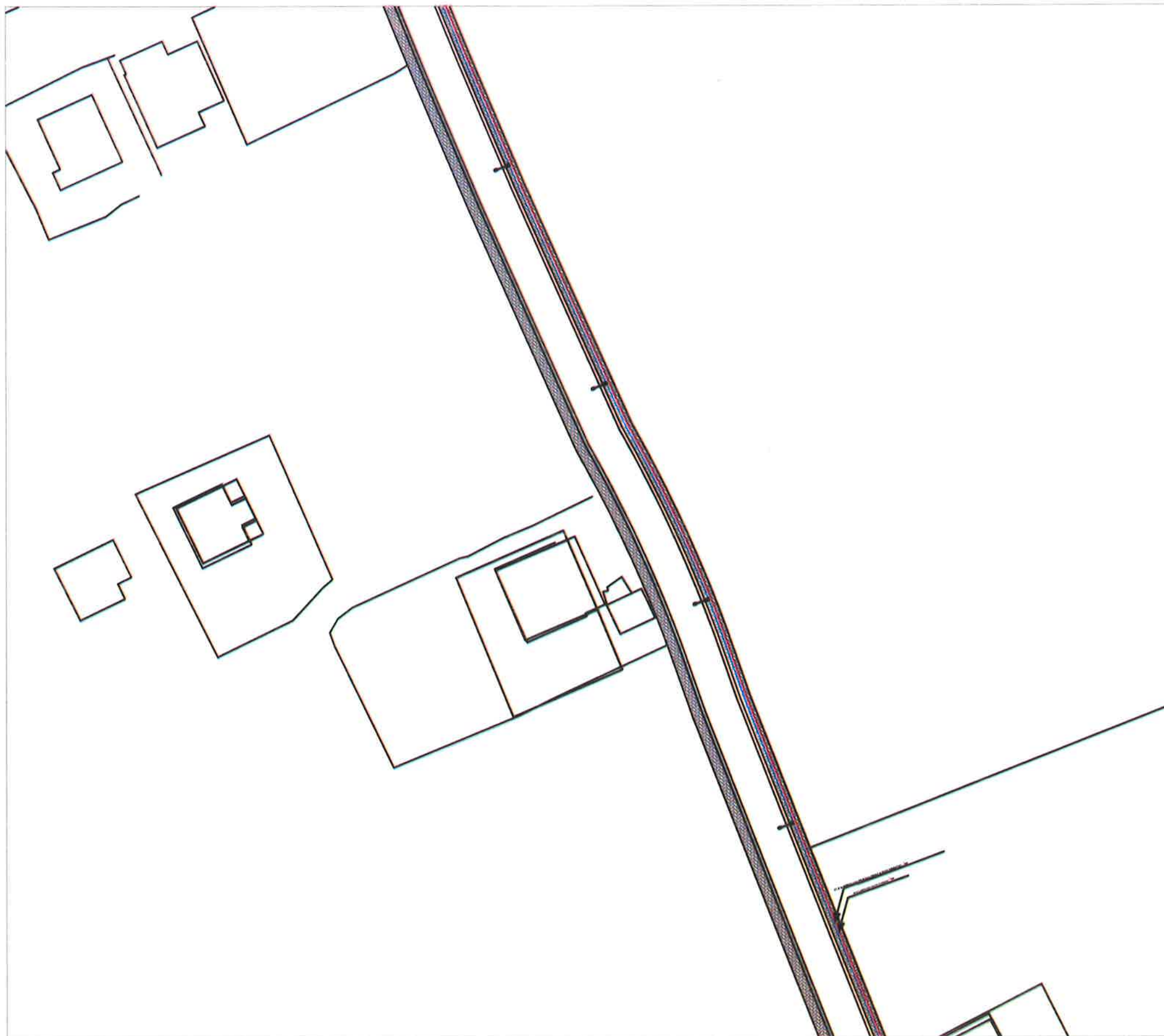

## LEGJENDA



SHTYLLA ELEKTRIKE



TUB KARROGATO  
PER TELEFONINE



TUB KARROGATO NDRICIMI  
DHE ELEKTRIKUN



## BASHKIA KAMEZ

DREJTORIA E SHERBIMEVE PUBLIKE  
DREJTORIA E PROJEKTEVE DHE INVESTIMEVE  
DEPARTAMENTI I PROJEKTEVE

Dr. i Pergj. i Sherbimeve Publike	ELVIS GJIKA	
Dr. e Projekteve e Investimeve	FLORA MUÇA	
Pergj. Depart. Sektori Projektimi	EMANUELA MËZIU	
STAFI TEKNIK PROJEKTUES	Ing. ARJOLA KURTI	
	Ing. ERBLIN LALA	
	Ing. EMANUELA MËZIU	
	Ing. HAJREDIN MUGRU	

<b>Titulli i Projektit:</b>	<b>Faza e Projektit:</b>
RIKUALIFIKIMI I RRUGES "AZEM HAJDARI"	PROJEKT ZBATIMI
<b>Data e Implementimit:</b>	
<b>Shtalla e Vizimit:</b>	
<b>Emertimi i Plotes:</b>	<b>Plota Nr.:</b>
PLANIMETRIA NDRICIMI	T-30



# OBJEKTI: RIKUALIFIKIMI I RRUGES "AZEM HAJDARI"

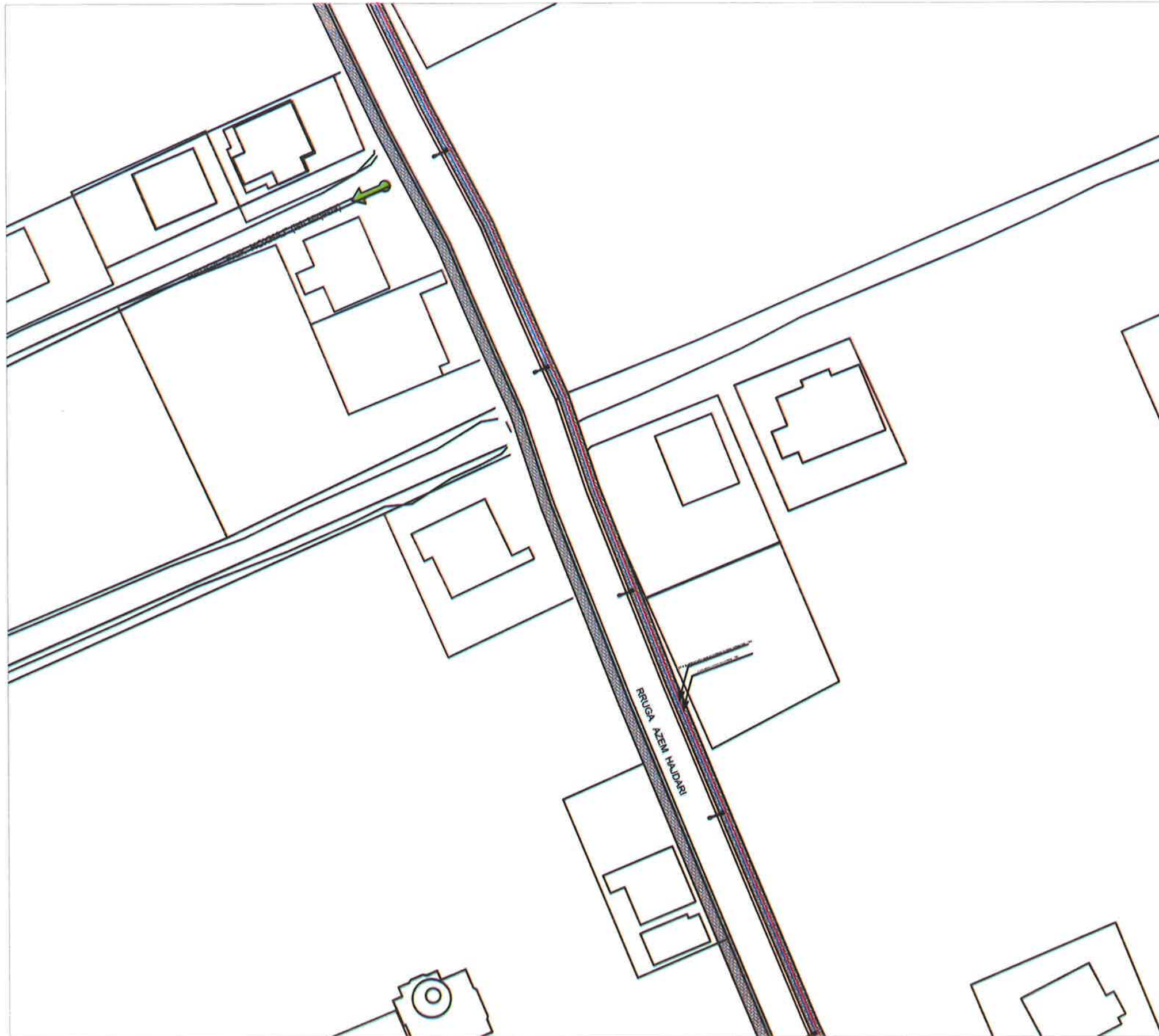

## LEGJENDA



SHTYLLA ELEKTRIKE



TUB KARROGATO  
PER TELEFONINE



TUB KARROGATO NDRICIMI  
DHE ELEKTRIKUN



## BASHKIA KAMEZ

DREJTORIA E SHERBIMEVE PUBLIKE  
DREJTORIA E PROJEKTEVE DHE INVESTIMEVE  
DEPARTAMENTI I PROJEKTEVE

Dr. i Pergj. i Sherbimeve Publike	ELVIS GJIKA	
Dr. e Projekteve e Investimeve	FLORA MUÇA	
Pergj. Depart. Sektori Projektimi	EMANUELA MEZIU	
STAFI TEKNIK	Ing. ARJOLA KURTI	
PROJEKTES	Ing. ERBLIN LALA	
	Ing. EMANUELA MEZIU	
	Ing. HAJREDIN MUGRU	

Titulli i Projektit:  
RIKUALIFIKIMI I RRUGES "AZEM HAJDARI"

Faza e Projektit:  
PROJEKT ZBATIMI

Data e Implementimit:

Shkalla e Vizimit:

Emertimi i Plotes:

PLANIMETRIA NDRICIMI

Fleta Nr.:

T-31



# OBJEKTI: RIKUALIFIKIMI I RRUGES "AZEM HAJDARI"



## LEGJENDA



SHTYLLA ELEKTRIKE

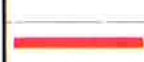

TUB KARROGATO  
PER TELEFONINE



TUB KARROGATO NDRICIMI  
DHE ELEKTRIKUN



## BASHKIA KAMEZ

DREJTORIA E SHERBIMEVE PUBLIKE  
DREJTORIA E PROJEKTEVE DHE INVESTIMEVE  
DEPARTAMENTI I PROJEKTEVE

Dr. i Pergj. i Shërbimeve Publike	ELVIS GJIKA
Dr. e Projekteve e Investimeve	FLORA MUÇA
Pergj. Depart. Sektori Projektimi	EMANUELA MËZIU
STAFI TEKNIK PROJEKTES	Ing. ARJOLA KURTI
	Ing. ERLIN LALA
	Ing. EMANUELA MËZIU
	Ing. HAJREDIN MUGRU

Titulli i Projektit:  
RIKUALIFIKIMI I RRUGES "AZEM HAJDARI"

Faza e Projektit:  
PROJEKT ZBATIMI

Data e Implementimit:

Shkalla e Vizimit:

Emertimi i Fletës:

PLANIMETRIA NDRICIMI

Fleta Nr.

T-32



# OBJEKTI: RIKUALIFIKIMI I RRUGES "AZEM HAJDARI"

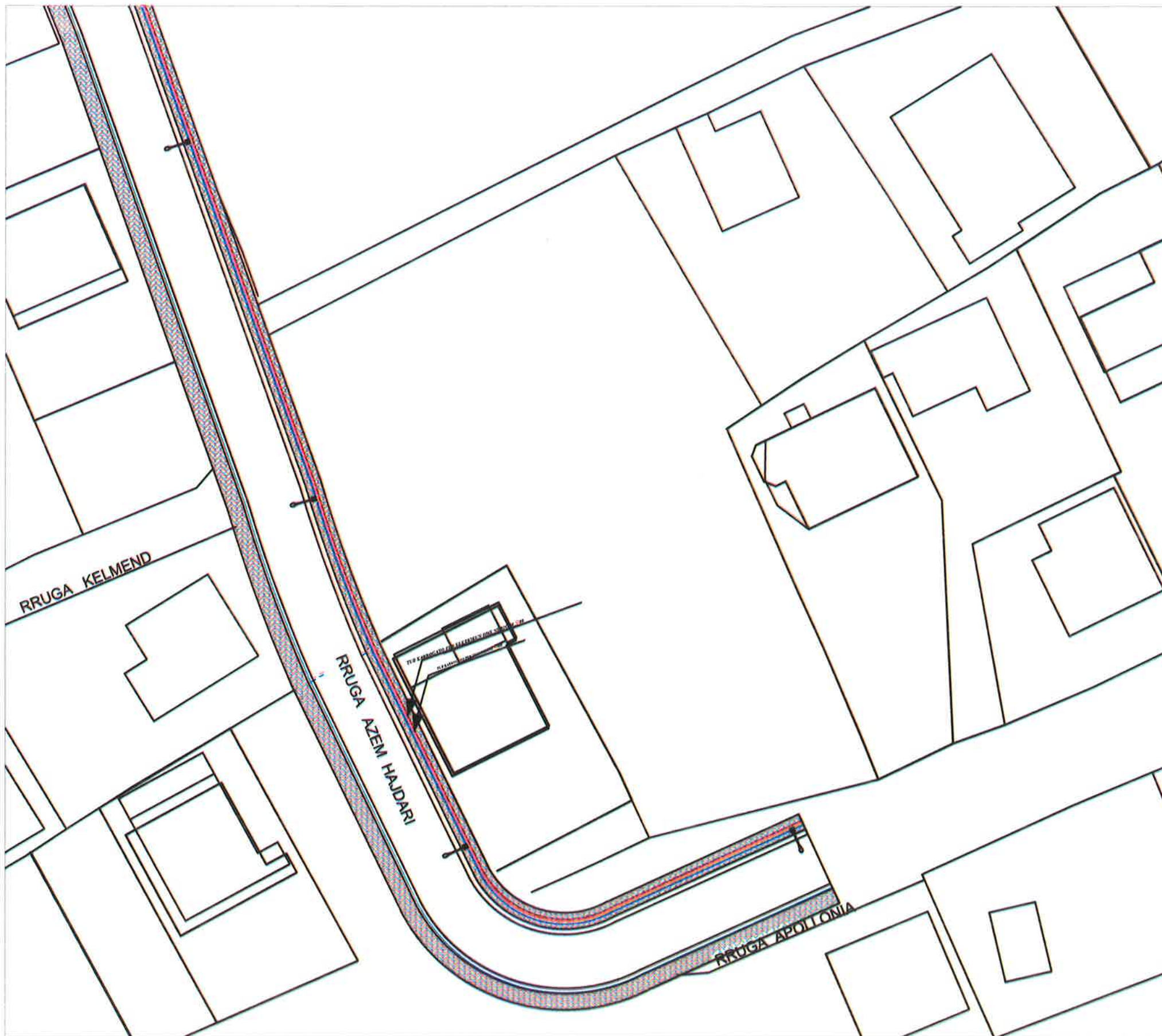

## LEGJENDA



SHTYLLA ELEKTRIKE



TUB KARROGATO  
PER TELEFONINE



TUB KARROGATO NDRICIMI  
DHE ELEKTRIKUN



## BASHKIA KAMEZ

DREJTORIA E SHERBIMEVE PUBLIKE  
DREJTORIA E PROJEKTEVE DHE INVESTIMEVE  
DEPARTAMENTI I PROJEKTEVE

Dr. i Pergj. i Sherbimeve Publike	ELVIS GJIKA	
Dr. e Projekteve e Investimeve	FLORA MUÇA	
Pergj. Depart. Sektorit Projektimi	EMANUELA MEZIU	
STAFI TEKNIK PROJEKTES	Ing. ARJOLA KURTI	
	Ing. ERBLIN LALA	
	Ing. EMANUELA MEZIU	
	Ing. HAJREDIN MUGRU	

Titulli i Projektit:	Rikualifikimi i RRUGES "AZEM HAJDARI"	Faza e Projektit:	PROJEKT ZBATIMI
Emertimi i Fletes:	PLANIMETRIA NDRICIMI	Data e Implementimit:	
		Rikalla e Vizatimit:	
		Fleta Nr.:	T-33



# OBJEKTI: RIKUALIFIKIMI I RRUGES "AZEM HAJDARI"

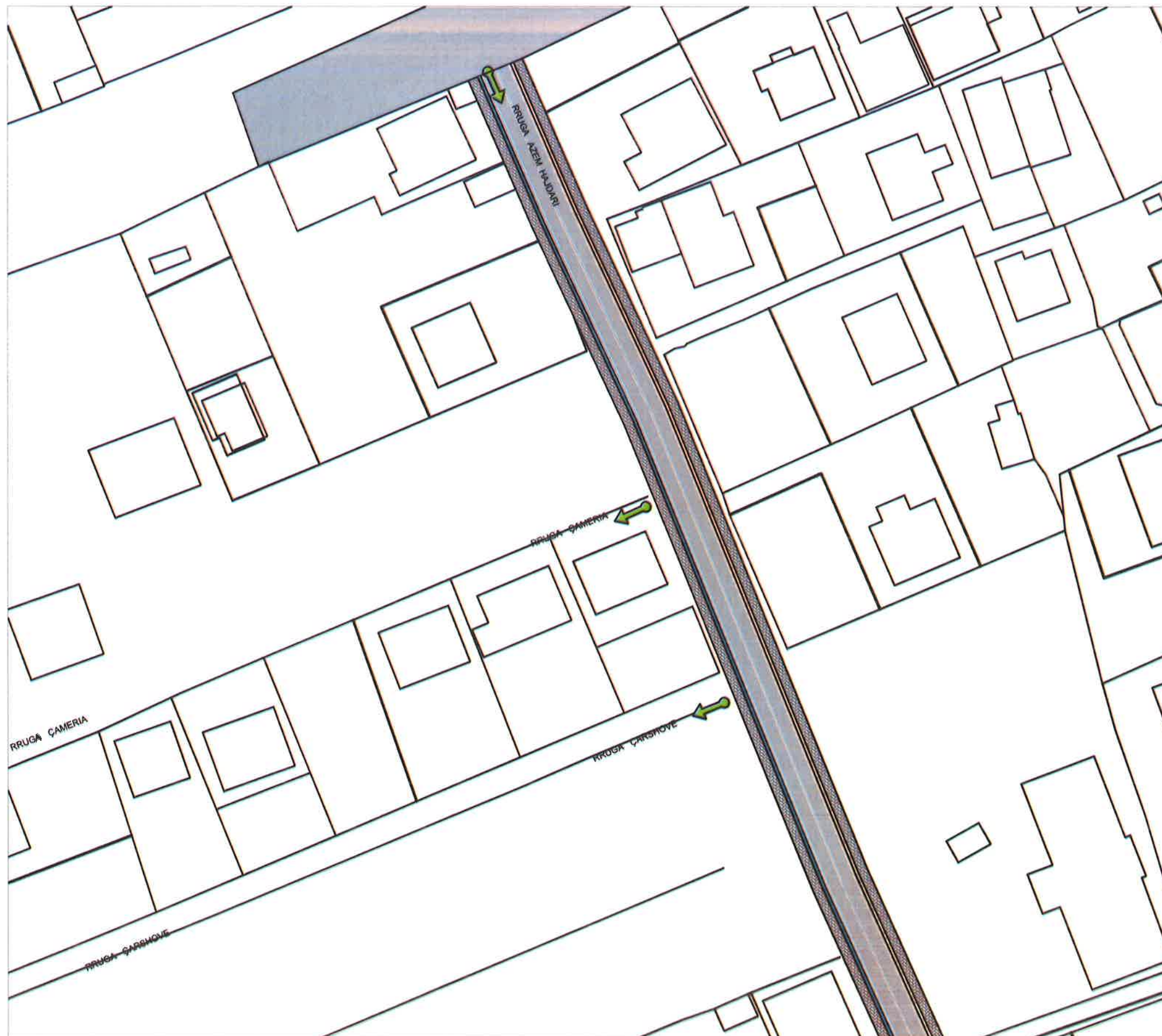

## LEGJENDA

 GJURME ASFALTI

 OBJEKTE



## BASHKIA KAMEZ

DREJTORIA E SHËRBIMEVE PUBLIKE  
DREJTORIA E PROJEKTEVE DHE INVESTIMEVE  
DEPARTAMENTI I PROJEKTEVE

Dr. i Përgj. i Shërbimeve Publike	ELVIS GJIKA								
Dr. e Projekteve e Investimeve	FLORA MUÇA								
Përgj. Depart. Sektori Projektimi	EMANUELA MËZIU								
STAFI IERSONIK PROJEKTES	<table border="1"> <tr> <td>Ing.</td> <td>ARJOLA KURTI</td> </tr> <tr> <td>Ing.</td> <td>ERBLIN LALA</td> </tr> <tr> <td>Ing.</td> <td>EMANUELA MËZIU</td> </tr> <tr> <td>Ing.</td> <td>HAJREDIN MUGRU</td> </tr> </table>	Ing.	ARJOLA KURTI	Ing.	ERBLIN LALA	Ing.	EMANUELA MËZIU	Ing.	HAJREDIN MUGRU
Ing.	ARJOLA KURTI								
Ing.	ERBLIN LALA								
Ing.	EMANUELA MËZIU								
Ing.	HAJREDIN MUGRU								

Titulli i Projektit:	Faza e Projektit:
RIKUALIFIKIMI I RRUGES "AZEM HAJDARI"	PROJEKT ZBATIMI
Emertimi i Fletës:	Data e Implementimit:
PLANIMETRIA ASFALTI	
	Shkalla e Vlerimit:
	Fleta Nr.:
	T-34



# OBJEKTI: RIKUALIFIKIMI I RRUGES "AZEM HAJDARI"

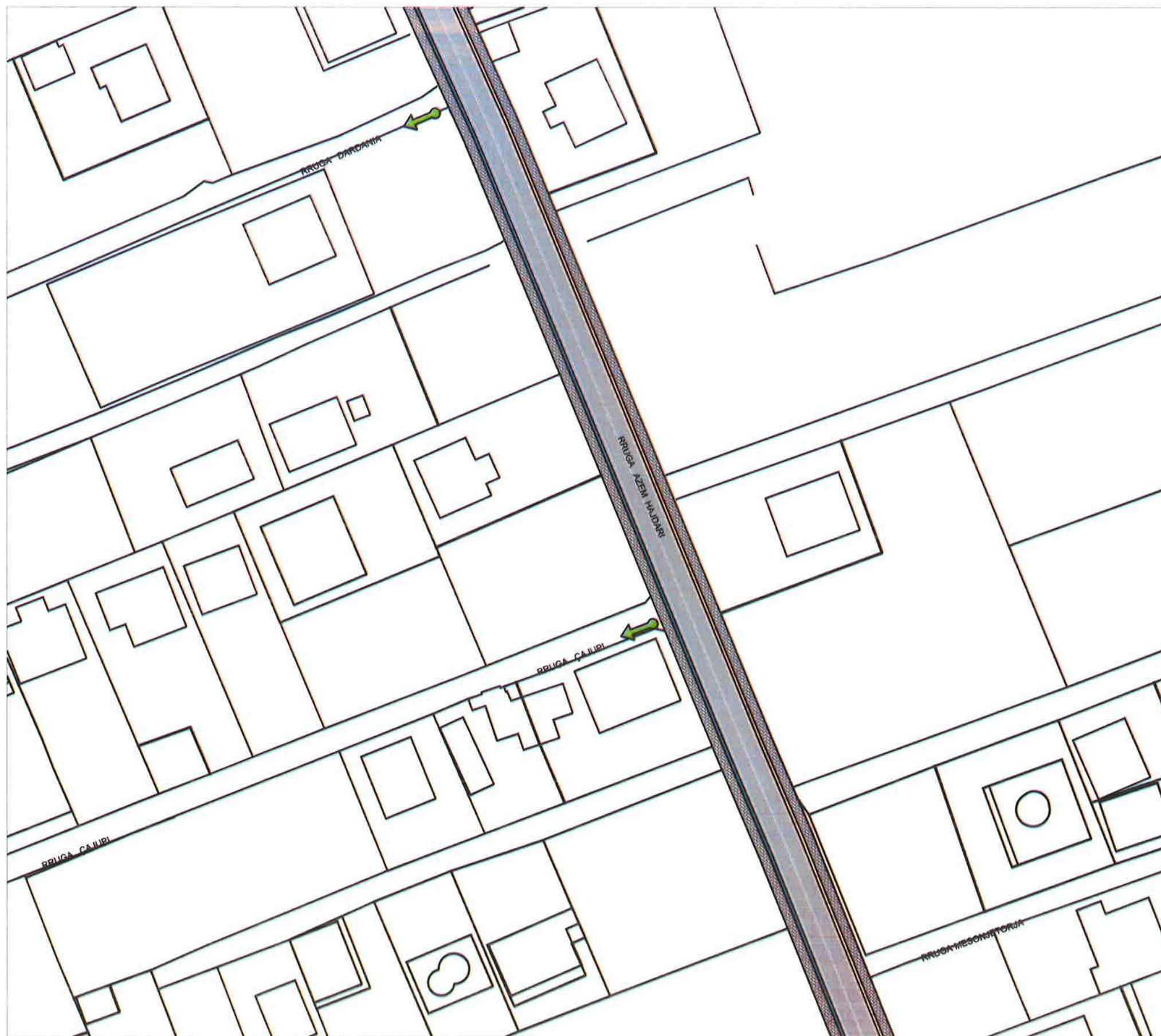

## LEGJENDA

-  GJURME ASFALTI
-  OBJEKTE



## BASHKIA KAMEZ

DREJTORIA E SHERBIMEVE PUBLIKE  
DREJTORIA E PROJEKTEVE DHE INVESTIMEVE  
DEPARTAMENTI I PROJEKTEVE

Dr. i Pergj. i Sherbimeve Publike	ELVIS GJIKA
Dr. e Projekteve e Investimeve	FLORA MUÇA
Pergj. Depart. Sektorit Projektimi	EMANUELA MEZIU
STAFI TEKNIK	Ing. ARJOLA KURTI
PROJEKTUES	Ing. ERBLIN LALA
	Ing. EMANUELA MEZIU
	Ing. HAJREDIN MUGRU

Titulli i Projektit:  
RIKUALIFIKIMI I RRUGES "AZEM HAJDARI"

Faza e Projektit:  
PROJEKT ZBATIMI

Emertimi i Plotes:  
PLANIMETRIA ASFALTI

Data e Implementimit:  
Shkalla e Vizatimit:  
Folia Nr.  
**T-35**



# OBJEKTI: RIKUALIFIKIMI I RRUGES "AZEM HAJDARI"



## LEGJENDA

-  GJURME ASFALTI
-  OBJEKTE



## BASHKIA KAMEZ

DREJTORIA E SHËRBIMEVE PUBLIKE  
DREJTORIA E PROJEKTEVE DHE INVESTIMEVE  
DEPARTAMENTI I PROJEKTEVE

Dr. i Përgj. i Shërbimeve Publike	ELVIS GJIKA
Dr. e Projekteve e Investimeve	FLORA MUÇA
Përgj. Depart. Sektori Projektimi	EMANUELA MËZIU
STAFI TEKNIK	
PROJEKTUES	
Ing.	ARJOLA KURTI
Ing.	ERBLIN LALA
Ing.	EMANUELA MËZIU
Ing.	HAJREDIN MUGRU

Titulli i Projektit:  
RIKUALIFIKIMI I RRUGES "AZEM HAJDARI"

Faza e Projektit:  
PROJEKT ZBATIMI

Emërtimi i Planit:  
PLANIMETRIA ASFALTI

Data e Implementimit:  
Shkalla e Vizatimit:  
Fleta Nr. T-36



# OBJEKTI: RIKUALIFIKIMI I RRUGES "AZEM HAJDARI"

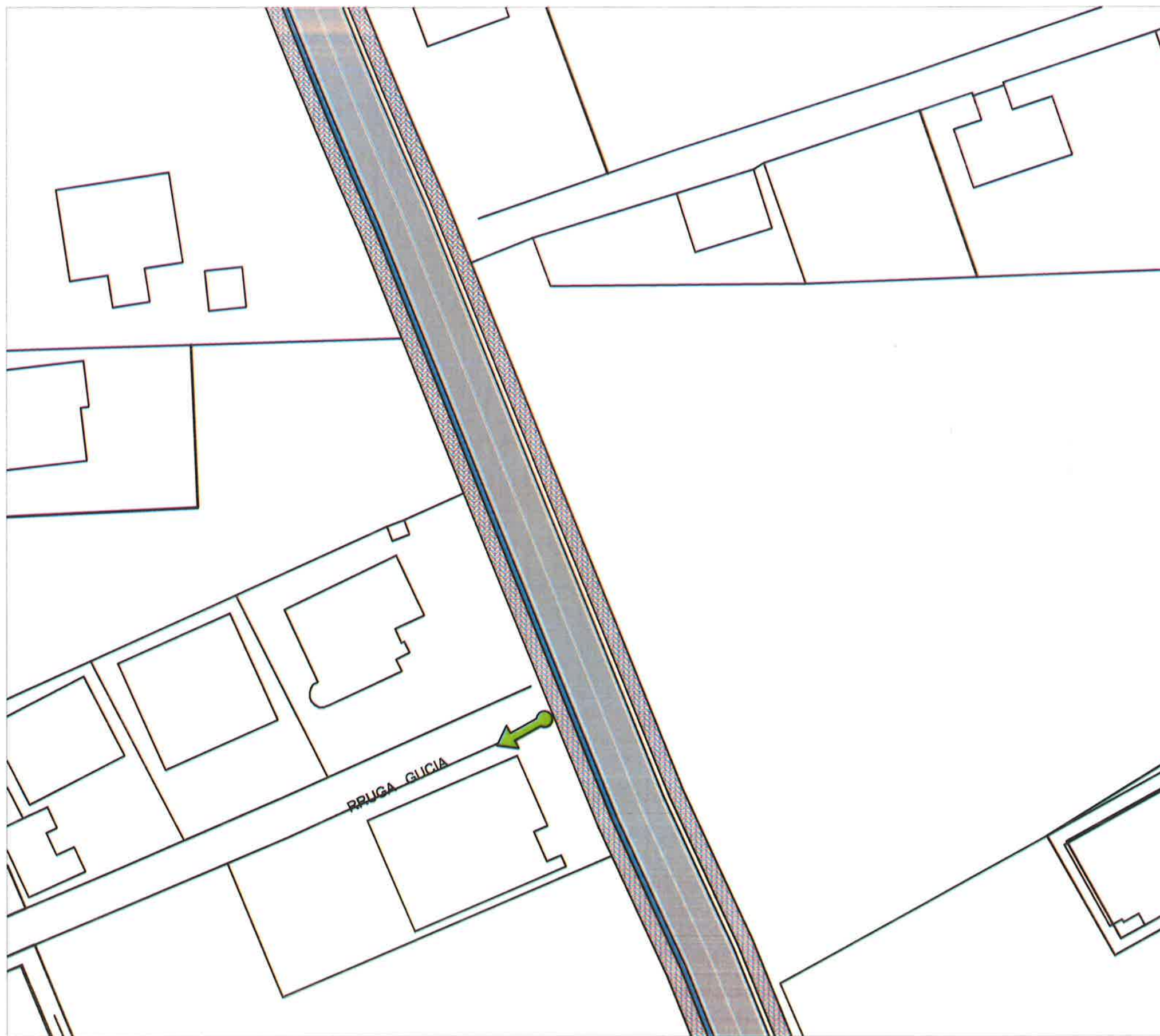

## LEGJENDA



GJURME ASFALTI

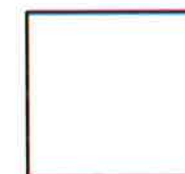

OBJEKTE



## BASHKIA KAMEZ

DREJTORIA E SHERBIMEVE PUBLIKE  
DREJTORIA E PROJEKTEVE DHE INVESTIMEVE  
DEPARTAMENTI I PROJEKTEVE

Dr. i Pergj. i Shërbimeve Publike	ELVIS GJIKA
Dr. e Projekteve e Investimeve	FLORA MUÇA
Pergj. Depart. Sektori Projektimi	EMANUELA MËZIU
STAFI TEKNIK	
PROJEKTUES	
Ing. ARJOLA KURTI	
Ing. ERBLIN LALA	
Ing. EMANUELA MËZIU	
Ing. HAJREDIN MUGRU	

Titulli i Projektit:  
RIKUALIFIKIMI I RRUGES "AZEM HAJDARI"

Emertimi i Planos:  
**PLANIMETRIA ASFALTI**

Faza e Projektit:  
PROJEKT ZBATIMI  
Data e Implementimit:  
Shkalla e Viteimit:  
Plota Nr:  
**T-37**



# OBJEKTI: RIKUALIFIKIMI I RRUGES "AZEM HAJDARI"



## LEGJENDA



GJURME ASFALTI



OBJEKTE



## BASHKIA KAMEZ

DREJTORIA E SHERBIMEVE PUBLIKE  
DREJTORIA E PROJEKTEVE DHE INVESTIMEVE  
DEPARTAMENTI I PROJEKTEVE

Dr. i Pergj. i Shërbimeve Publike	ELVIS GJIKA
Dr. e Projekteve e Investimeve	FLORA MUÇA
Pergj. Depart. Sektori Projektimi	EMANUELA MEZIU
STAFI TEKNIK PROJEKTUES	Ing. ARJOLA KURTI
	Ing. ERBLIN LALA
	Ing. EMANUELA MEZIU
	Ing. HAJREDIN MUGRU

Titulli i Projektit:		Faza e Projektit:
RIKUALIFIKIMI I RRUGES "AZEM HAJDARI"		PROJEKT ZBATIMI
Emertimi i Fotos:		Data e Implementimit:
PLANIMETRIA ASFALTI		Rikalla e Vizatimit:
		Fleta Nr:
		T-38



# OBJEKTI: RIKUALIFIKIMI I RRUGES "AZEM HAJDARI"

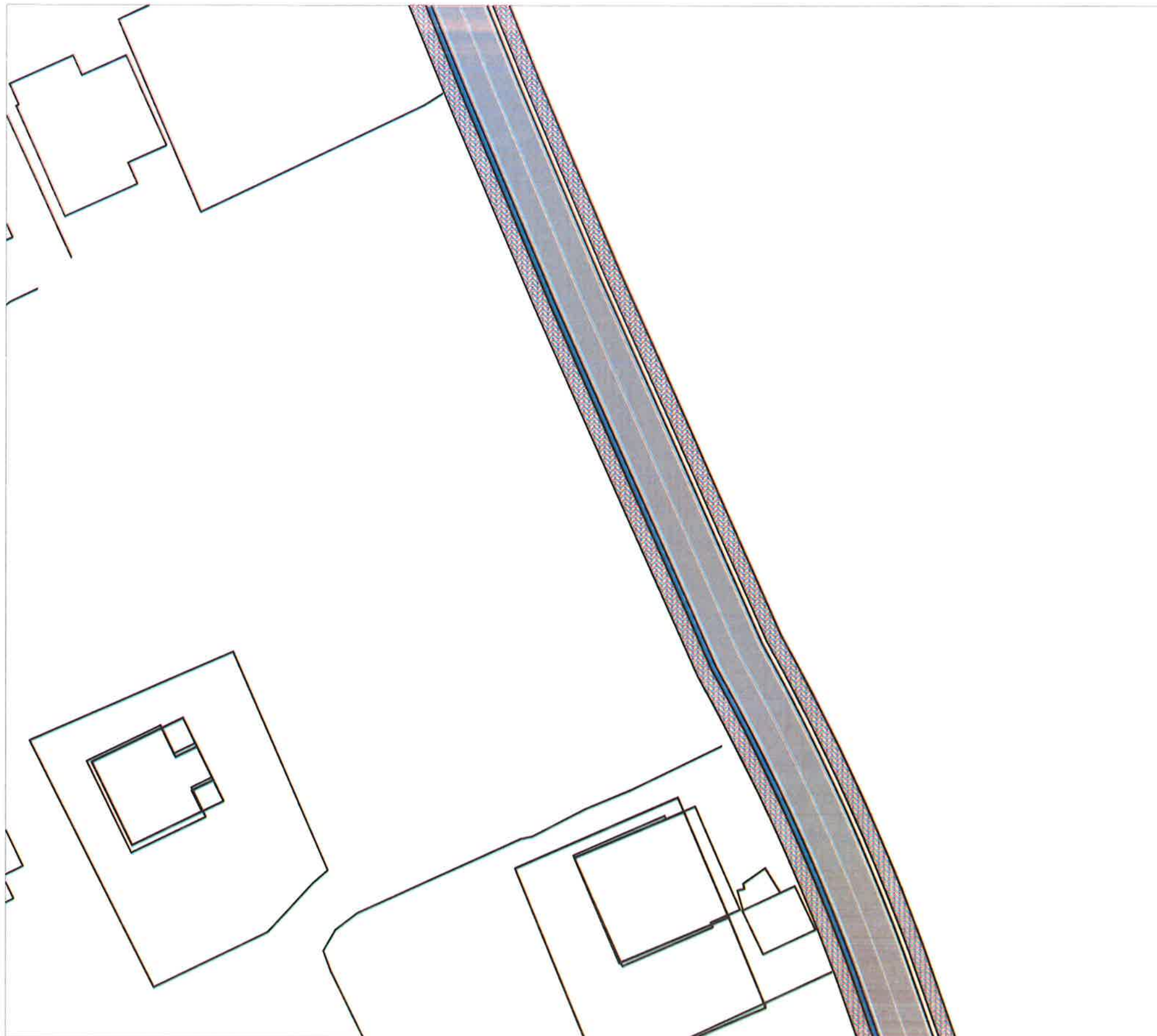

## LEGJENDA

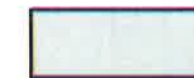

GJURME ASFALTI



OBJEKTE



## BASHKIA KAMEZ

DREJTORIA E SHERBIMEVE PUBLIKE  
DREJTORIA E PROJEKTEVE DHE INVESTIMEVE  
DEPARTAMENTI I PROJEKTEVE

Dr. i Pergj. i Sherbimeve Publike	ELVIS GJIKA
Dr. e Projekteve e Investimeve	FLORA MUÇA
Pergj. Depart. Sektori Projektimi	EMANUELA MEZIU
STAFI TEKNIK	
PROJEKTUES	
Ing. ARJOLA KURTI	
Ing. ERBLIN LALA	
Ing. EMANUELA MEZIU	
Ing. HAJREDIN MUGRU	

Titulli i Projektit:  
RIKUALIFIKIMI I RRUGES "AZEM HAJDARI"

Emertimi i Fotos:

PLANIMETRIA ASFALTI

Faza e Projektit:  
PROJEKT ZBATIMI

Data e Implementimit:

Shkalla e Vizatimit:

Fleta Nr.

T-39



# OBJEKTI: RIKUALIFIKIMI I RRUGES "AZEM HAJDARI"

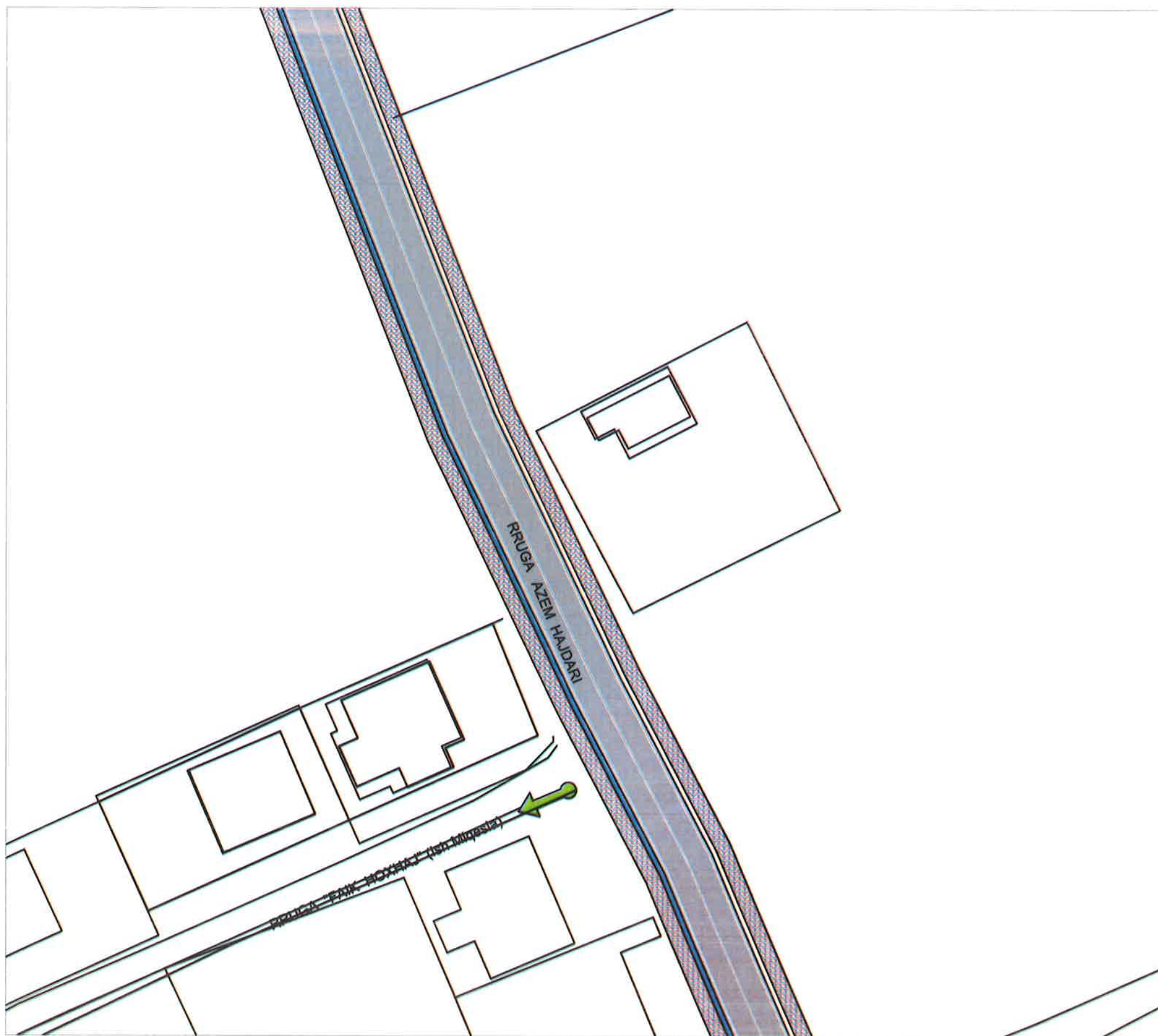

## LEGJENDA



GJURME ASFALTI



OBJEKTE



## BASHKIA KAMEZ

DREJTORIA E SHERBIMEVE PUBLIKE  
DREJTORIA E PROJEKTEVE DHE INVESTIMEVE  
DEPARTAMENTI I PROJEKTEVE

Dr. i Pergj. i Sherbimeve Publike	ELVIS GJIKA
Dr. e Projekteve e Investimeve	FLORA MUÇA
Pergj. Depart. Sektori Projektimi	EMANUELA MEZIU
Ing. ARJOLA KURTI	
Ing. ERBLIN LALA	
Ing. EMANUELA MEZIU	
Ing. HAJREDIN MUGRU	

Titulli i Projektit:  
RIKUALIFIKIMI I RRUGES "AZEM HAJDARI"

Faza e Projektit:  
PROJEKT ZBATIMI

Data e Implementimit :

Shkala e Vizimit:

Emertimi i Fotos:

PLANIMETRIA ASFALTI

Fleta Nr.

T-40



# OBJEKTI: RIKUALIFIKIMI I RRUGES "AZEM HAJDARI"

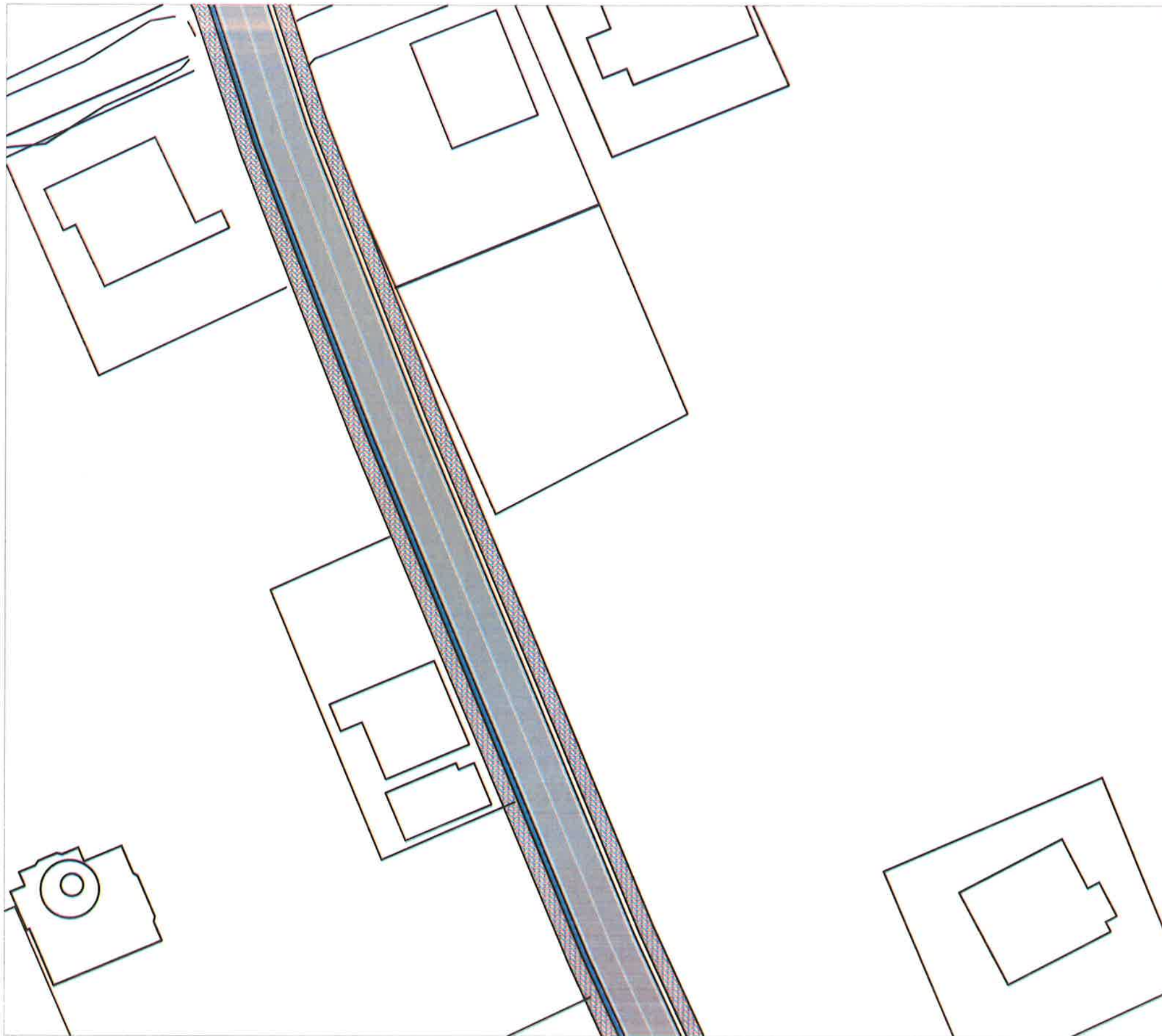

## LEGJENDA

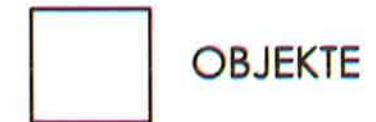

## BASHKIA KAMEZ

DREJTORIA E SHERBIMEVE PUBLIKE  
DREJTORIA E PROJEKTEVE DHE INVESTIMEVE  
DEPARTAMENTI I PROJEKTEVE

Dr. i Pergj. i Sherbimeve Publike	ELVIS GJIKA	
Dr. e Projekteve e Investimeve	FLORA MUÇA	
Pergj. Depart. Sektari Projektimi	EMANUELA MËZIU	
STAFI I TEKNIK PROJEKTES	Ing. ARJOLA KURTI	
	Ing. ERBLIN LALA	
	Ing. EMANUELA MËZIU	
	Ing. HAJREDIN MUGRU	

Titulli i Projektit:

RIKUALIFIKIMI I RRUGES "AZEM HAJDARI"

Faza e Projektit:

PROJEKT ZBATIM

Data e Implementimit:

Emertimi i Plotes:

PLANIMETRIA ASFALTI

Shkalla e Vizimit:

Fleta Nr.

T-41



# OBJEKTI: RIKUALIFIKIMI I RRUGES "AZEM HAJDARI"

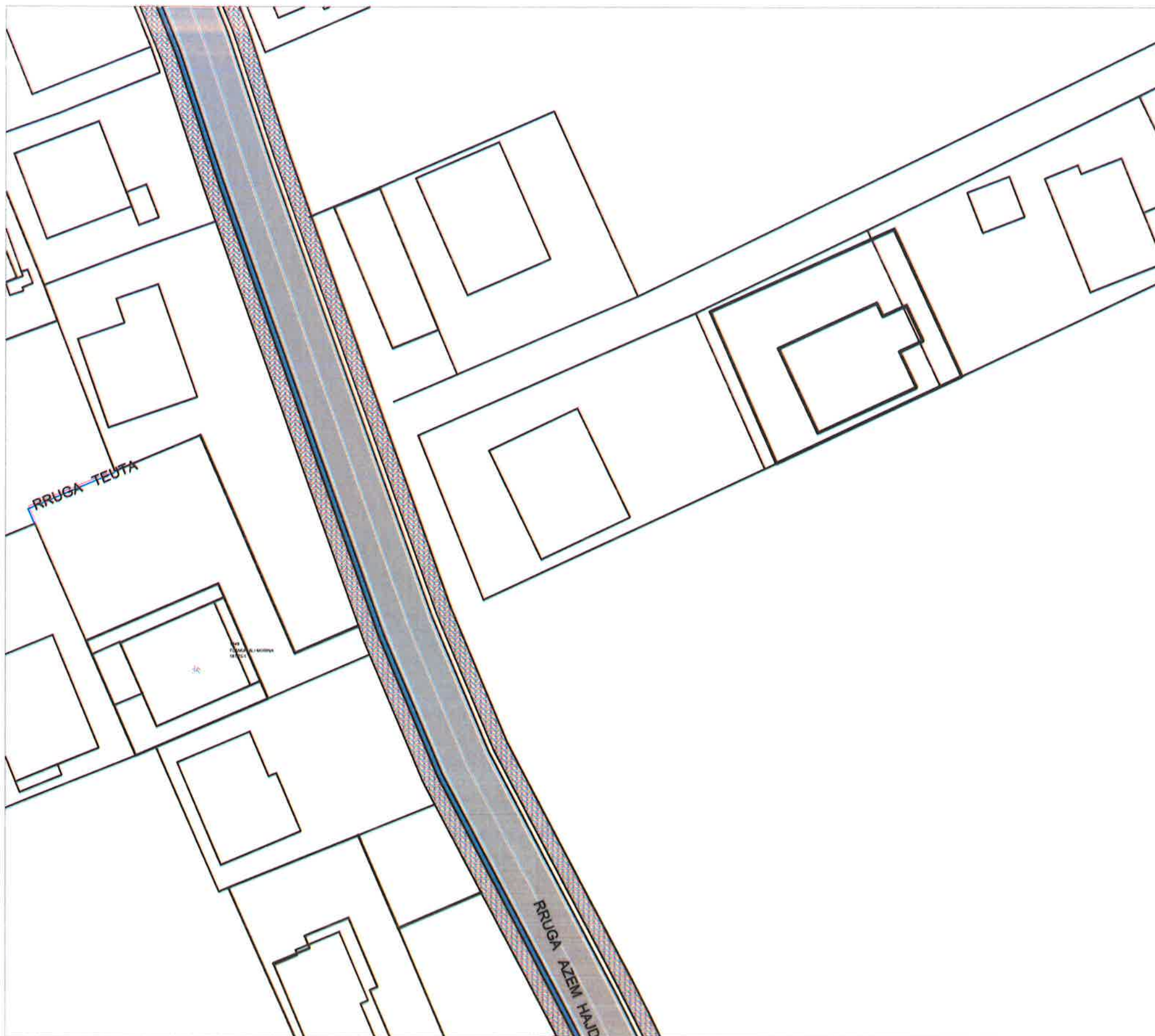

## LEGJENDA

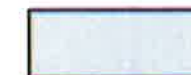

GJURME ASFALTI



OBJEKTE



## BASHKIA KAMEZ

DREJTORIA E SHERBIMEVE PUBLIKE  
DREJTORIA E PROJEKTEVE DHE INVESTIMEVE  
DEPARTAMENTI I PROJEKTEVE

Dr. i Përgj. i Shërbimeve Publike	ELVIS GJIKA
Dr. e Projekteve e Investimeve	FLORA MUÇA
Përgj. Depart. Sektorit Projektimi	EMANUELA MEZIU
STAFI TEKNIK	
PROJEKTUES	
Ing.	ARJOLA KURTI
Ing.	ERBLIN LALA
Ing.	EMANUELA MEZIU
Ing.	HAJREDIN MUGRU

Titulli i Projektit:

RIKUALIFIKIMI I RRUGES "AZEM HAJDARI"

Emërtimi i Planos:

PLANIMETRIA ASFALTI

Faza e Projektit:

PROJEKT ZBATIMI

Data e Implementimit:

Shkalla e Vizatimit:

Fleta Nr.

T-42



# OBJEKTI: RIKUALIFIKIMI I RRUGES "AZEM HAJDARI"



## LEGJENDA

 GJURME ASFALTI

 OBJEKTE



## BASHKIA KAMEZ

DREJTORIA E SHERBIMEVE PUBLIKE  
DREJTORIA E PROJEKTEVE DHE INVESTIMEVE  
DEPARTAMENTI I PROJEKTEVE

Dr. i Pergj. i Sherbimeve Publike	ELVIS GJIKA	
Dr. e Projekteve e Investimeve	FLORA MUÇA	
Pergj. Depart. Sektori Projektimi	EMANUELA MEZIU	
Shtafi Teknik i Projektit	Ing. ARJOLA KURTI	
	Ing. ERBLIN LALA	
	Ing. EMANUELA MEZIU	
	Ing. HAJREDIN MUGRU	

Titulli i Projektit: **PROJEKT ZBATIM**  
RIKUALIFIKIMI I RRUGES "AZEM HAJDARI"

Emertimi i Plotes: **PLANIMETRIA ASFALTI**

Data e Implementimit:  
Shkalla e Vizatimit:  
Fleta Nr. **T-43**



# OBJEKTI: RIKUALIFIKIMI I RRUGES "AZEM HAJDARI"

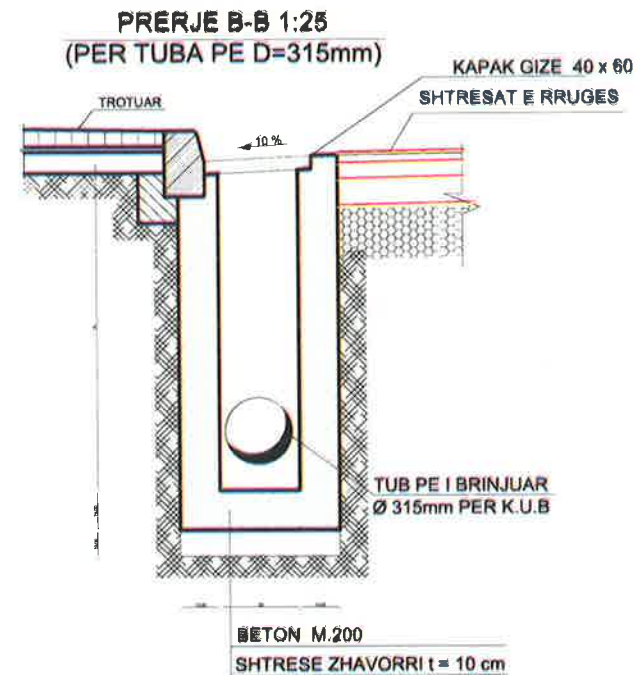
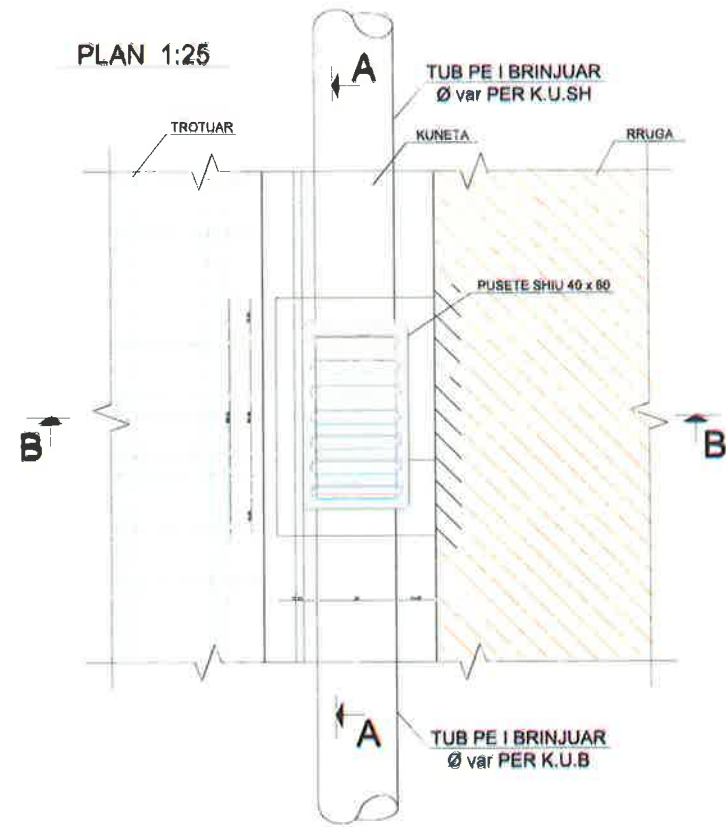

PRERJE A-A 1:25

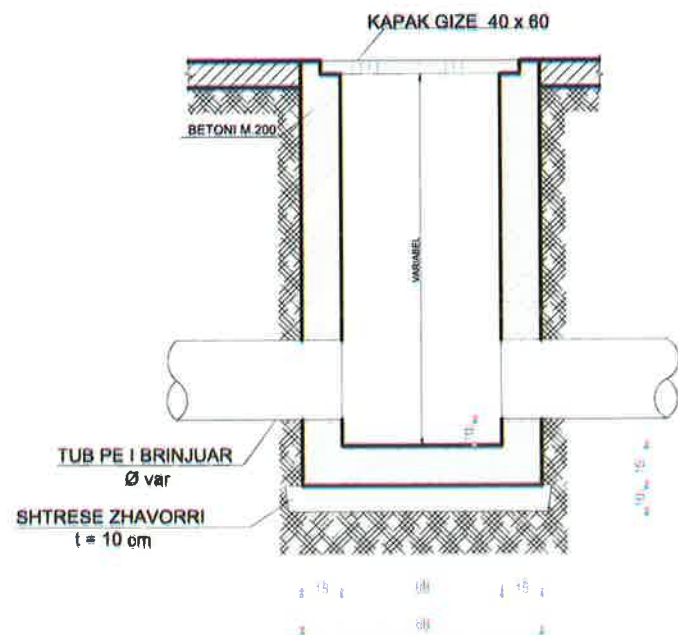

PRERJE B-B 1:20  
(PER TUBA PE D=315 )

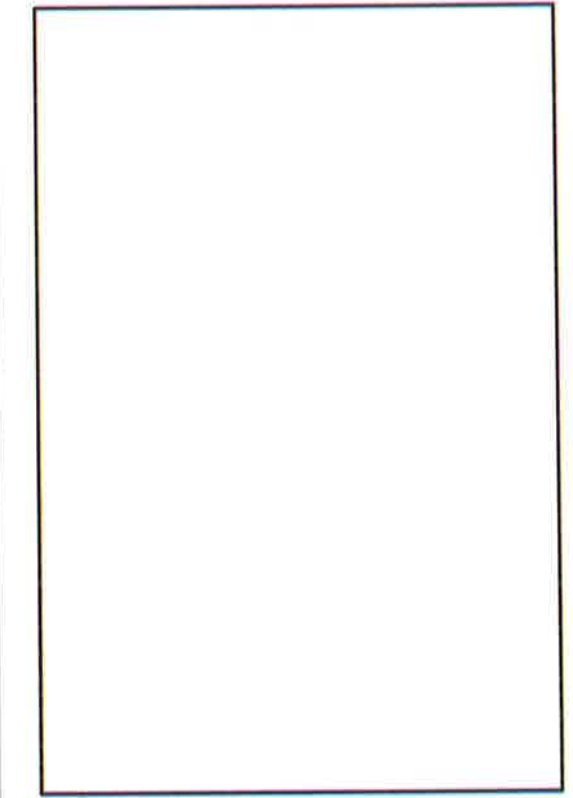
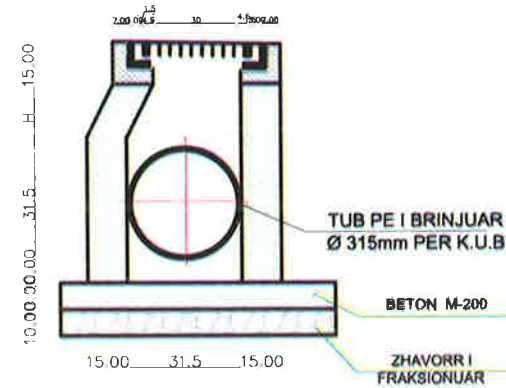

**BASHKIA KAMEZ**  
DREJTORIA E SHERBIMEVE PUBLIKE  
DREJTORIA E PROJEKTEVE DHE INVESTIMEVE  
DEPARTAMENTI I PROJEKTEVE

Dr. i Pergj. i Sherbimeve Publike	ELVIS GJIK
Dr. e Projekteve e Investimeve	FLORA MUÇA
Pergj. Depart. Sektori Projektimi	EMANUELA MEZIU
STAFI TEKNIK	Ing. ARJOLA KURTI
PROJEKTUES	Ing. ERBLIN LALA
	Ing. EMANUELA MEZIU
	Ing. HAJREDIN MUGRU

Titulli i Projektit: RIKUALIFIKIMI I RRUGES "AZEM HAJDARI"  
Faza e Projektit: PROJEKT ZBATIMI  
Data e Implementimit:  
Shkalla e Vizatimit:  
Emertimi i Fletes: PROFIL TIP KUB  
Fleta Nr: T-44



# OBJEKTI: RIKUALIFIKIMI I RRUGES "AZEM HAJDARI"

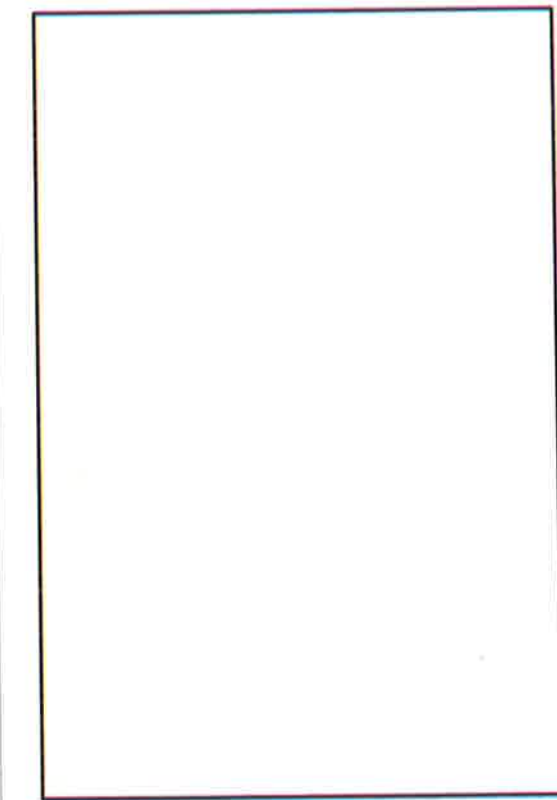
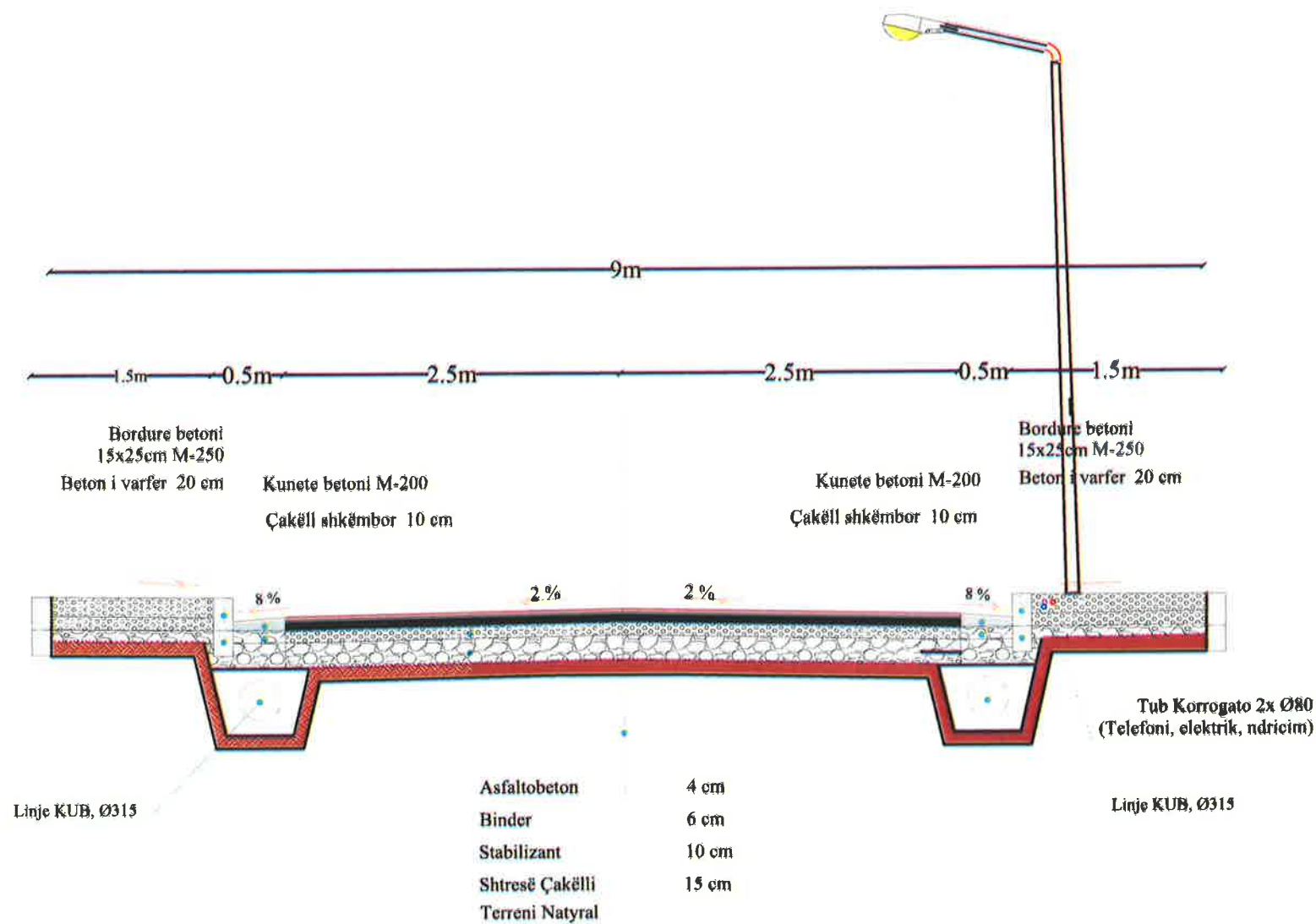

**BASHKIA KAMEZ**  
 DREJTORIA E SHERBIMEVE PUBLIKE  
 DREJTORIA E PROJEKTEVE DHE INVESTIMEVE  
 DEPARTAMENTI I PROJEKTEVE

Dr. i Pergj. i Sherbimeve Publike	ELVIS GJIKA
Dr. e Projekteve e Investimeve	FLORA MUÇA
Pergj. Depart. Sektori Projektimi	EMANUELA MEZIU
Ing. ARJOLA KURTI	
Ing. ERBLIN LALA	
Ing. EMANUELA MEZIU	
Ing. HAJREDIN MUGRU	

Titulli i Projektit:	RIKUALIFIKIMI I RRUGES "AZEM HAJDARI"
Faza e Projektit:	PROJEKT ZBATIMI
Data e Implementimit:	
Shkalla e Vizimit:	
Emertimi i Fletës:	PROFIL TIP
Fleta Nr.:	T-45