

SHKOLLA 9-VJECARE "AVNI
RUSTEMI"



BASHKIA VLORE

DREJTORIA E
PLANIFIKIMIT DHE
ZHVILLIMIT TË
TERRITORIT

GRUPI I PROJEKTIMIT:

Ark. Ilir Kokuri

Ark. Suela Abazaj

Ing. Ana Celaj

Ing. Edmond Beqiri

VLORE 2020

K-01

SHKOLLA 9-VJECARE "AVNI RUSTEMI"



A07-19-10.JPG

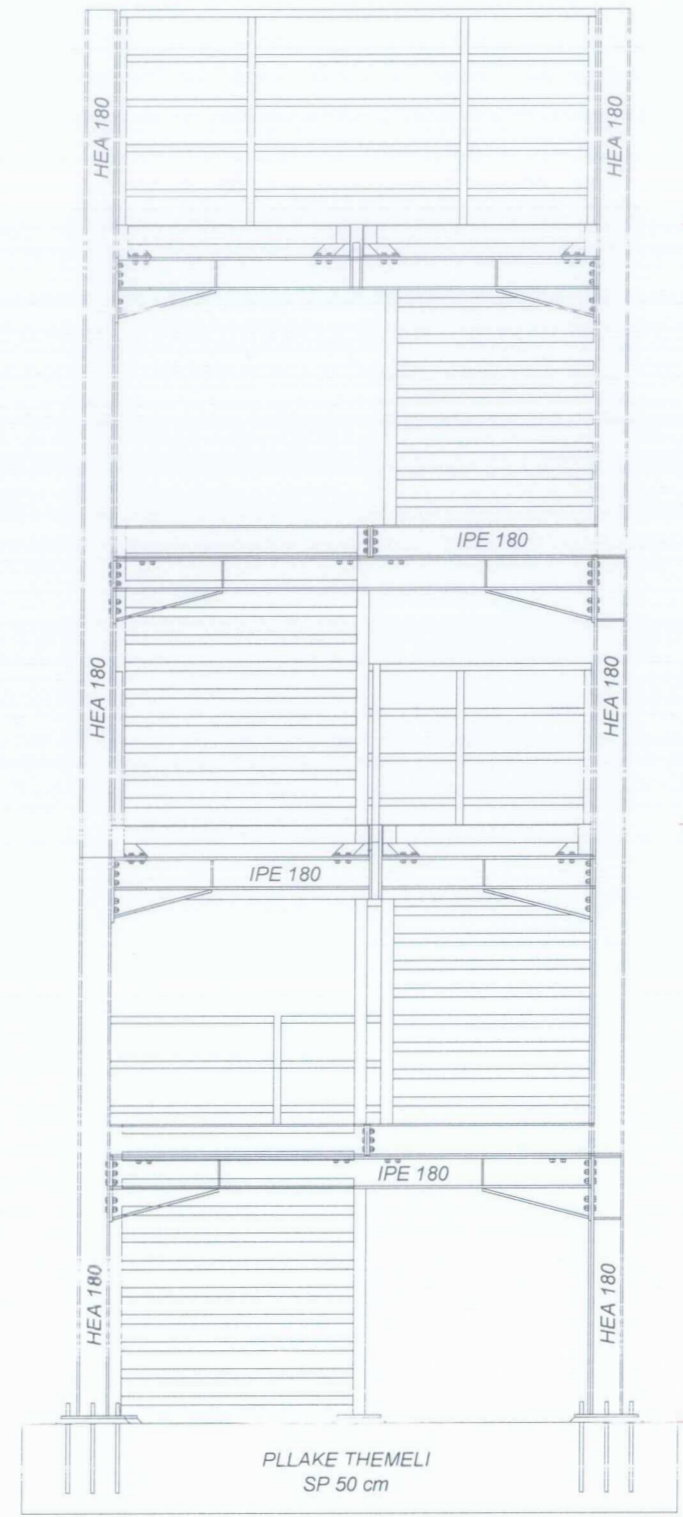
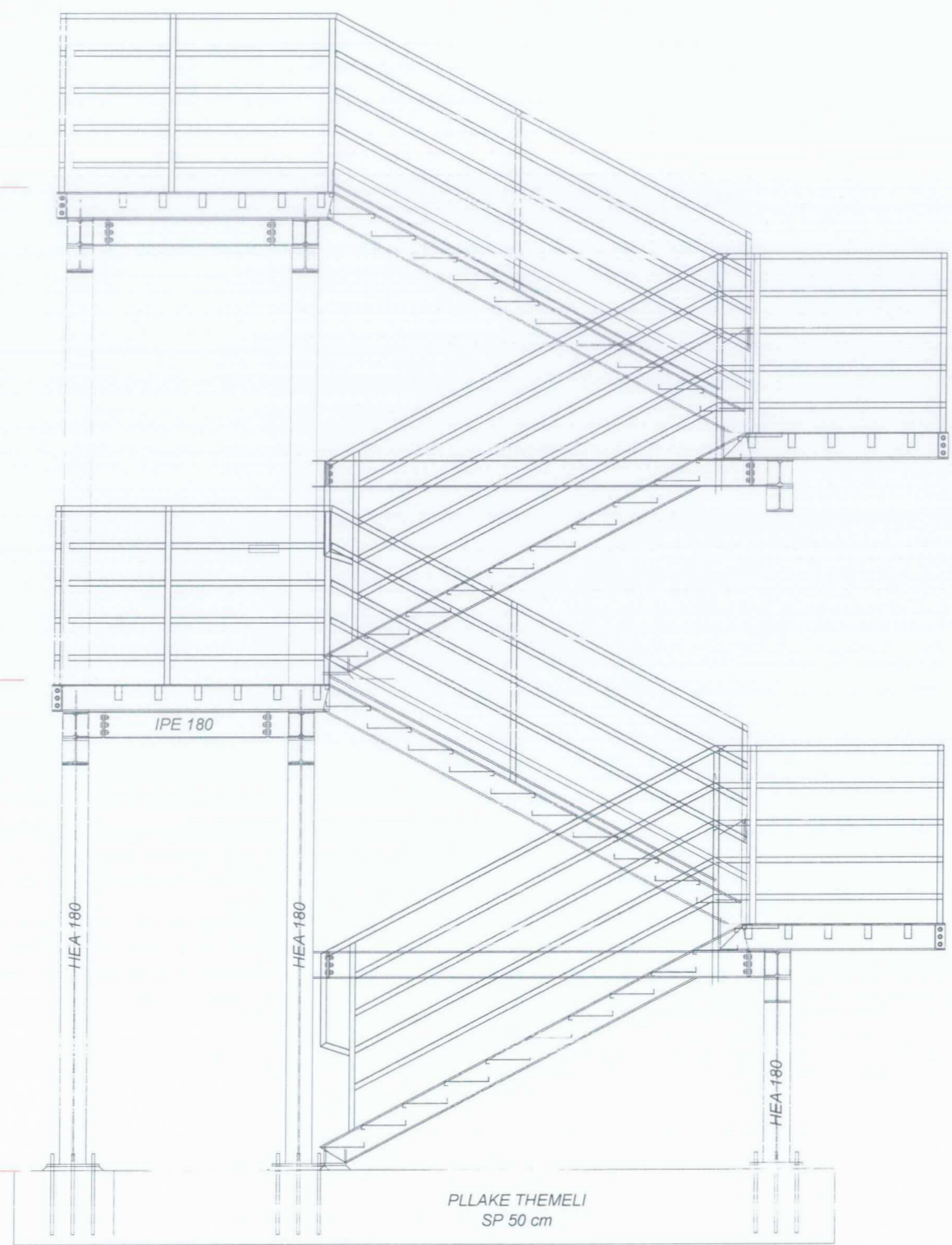

BASHKIA VLORE

DREJTORIA E
PLANIFIKIMIT DHE
ZHVILLIMIT TË
TERRITORIT

GRUPI I PROJEKTIMIT:
Ark. Ilir Kokuri
Ark. Suela Abazaj
Ing. Ana Celaj
Ing. Edmond Beqiri

VLORE 2020

K-02

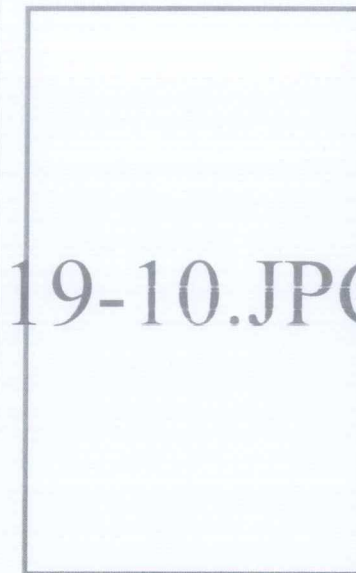
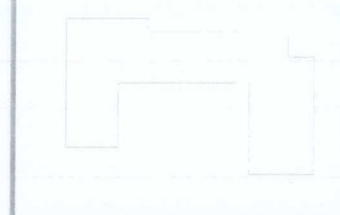

A07-19-10.JPG

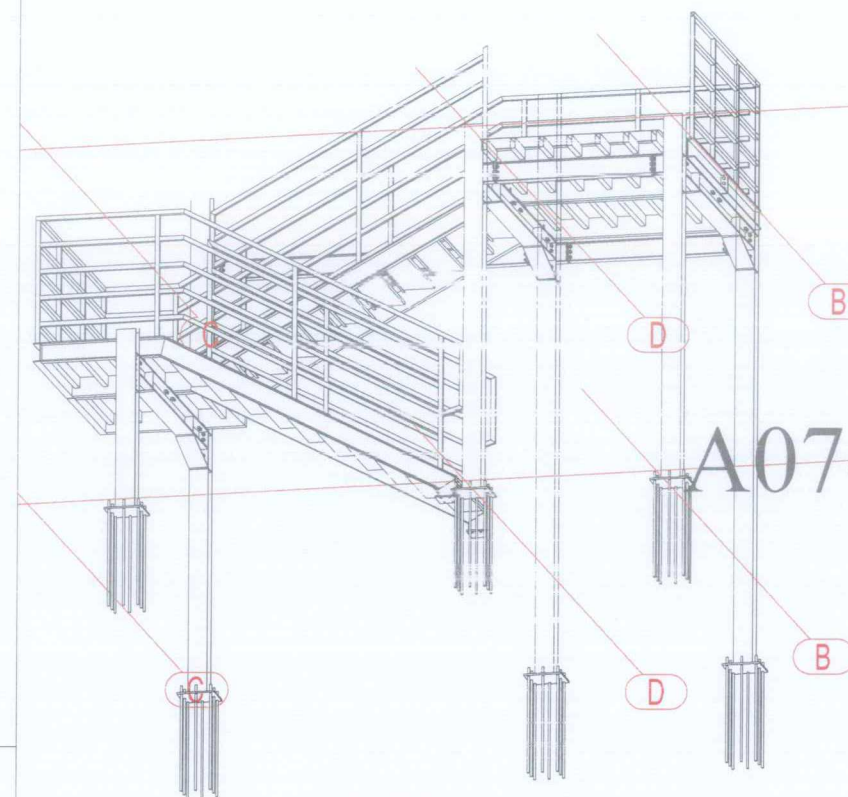
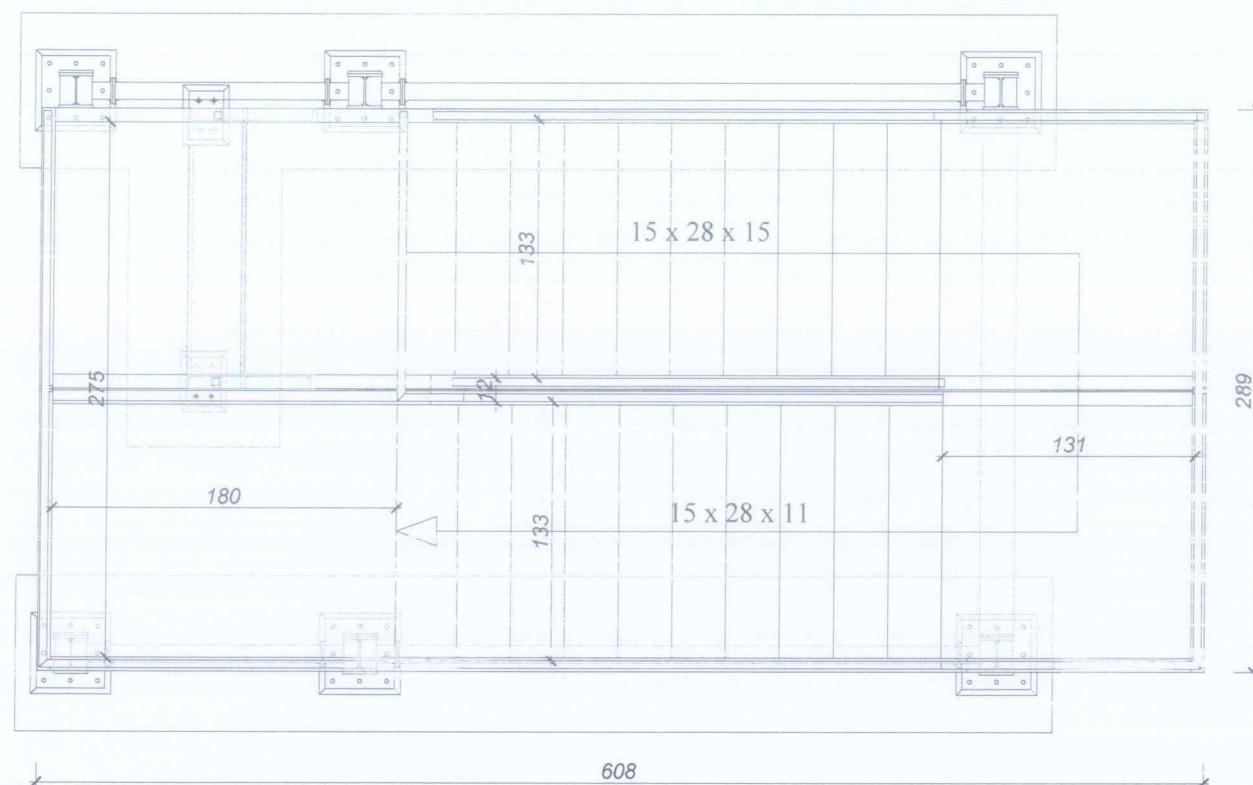

View_02 (3d Q 0.00 - 3.30)



TABELA MATERIALE

BETON ARMET KLASA M250 Rezistenca karakteristike $f_{cm} \geq 200 \text{ Kg/cm}^2$
 Dimensioe zhavorr max : 20 mm
 ESHTË KATEGORIKISHT E NDALUAR SHTIMI I UJIT PERPARA
 DERDHJES INXHINJERI SBATUES PERPARA
 CDO DERDHJE DUHET TE KONTROLLOJE KARAKTERISTIKAT
 E BETONIT
 CELIK PER BETON TIP S500s me karakteristika : $f_{yk} \geq 430 \text{ N/mm}^2$ e $f_{tk} \geq 540 \text{ N/mm}^2$ A $\geq 12\%$. $f_y / f_{yk} < 1.35$
 INXHINJERI SBATUES PERPARA CDO DERDHJE DUHET TE
 KONTROLLOJE KARAKTERISTIKAT E
 CELIKUT NE CERTIFIKATA.
 PROFILE HEKURI TIP Fe360 Me karakteristika : f_t (keputje) $\geq 3400 \text{ kg/cm}^2$;
 f_y (rrjedhshmeri) $\geq 2350 \text{ kg/cm}^2$
 CDO FURNITURE DUHET TE SHOQEROHET ME CERTIFIKATAT
 E CILLSISE TE DHENA NGA PRODHIUESI
 BULLONATURA CLASA 8.8 Me karakteristika : f_t (keputje) $\geq 6000 \text{ kg/cm}^2$; f_y
 (rrjedhshmeri) $\geq 3600 \text{ kg/cm}^2$
 SALDIMET me rreze 12 mm pergjat gjithë gjatesise se kontaktit

BASHKIA VLORE

DREJTORIA E
PLANIFIKIMIT DHE
ZHVILLIMIT TË
TERRITORIT

GRUPI I PROJEKTIMIT:

Ark. Ilir Kokuri

Ark. Suela Abazaj

Ing. Ana Celaj

Ing. Edmond Beqiri

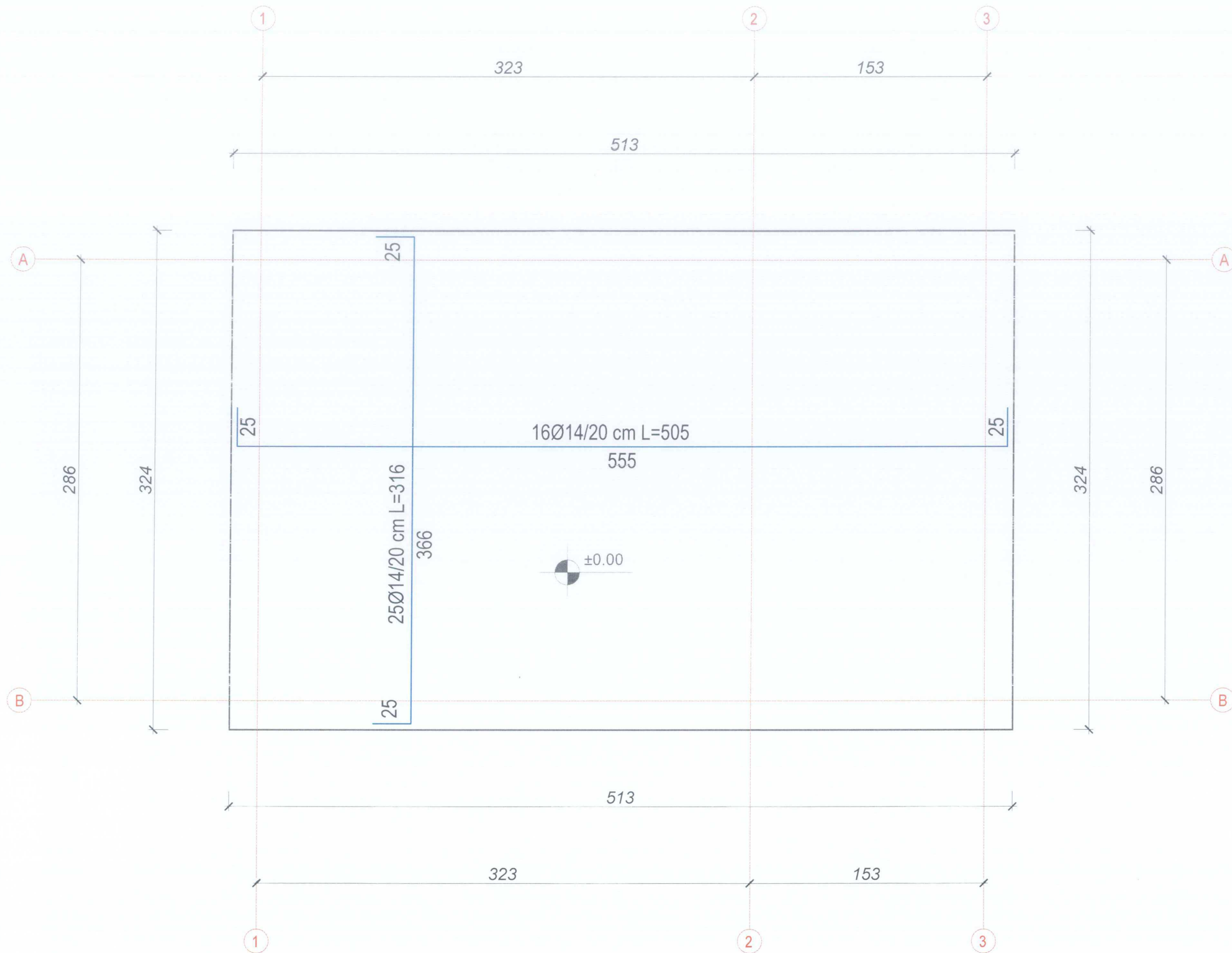

SHKOLLA 9-VJECARE "AVNI RUSTEMI"



BASHKIA VLORE

DREJTORIA E
PLANIFIKIMIT DHE
ZHVILLIMIT TË
TERRITORIT

GRUPI I PROJEKTIMIT:
Ark. Ilir Kokuri
Ark. Suela Abazaj
Ing. Ana Celaj
Ing. Edmond Beqiri



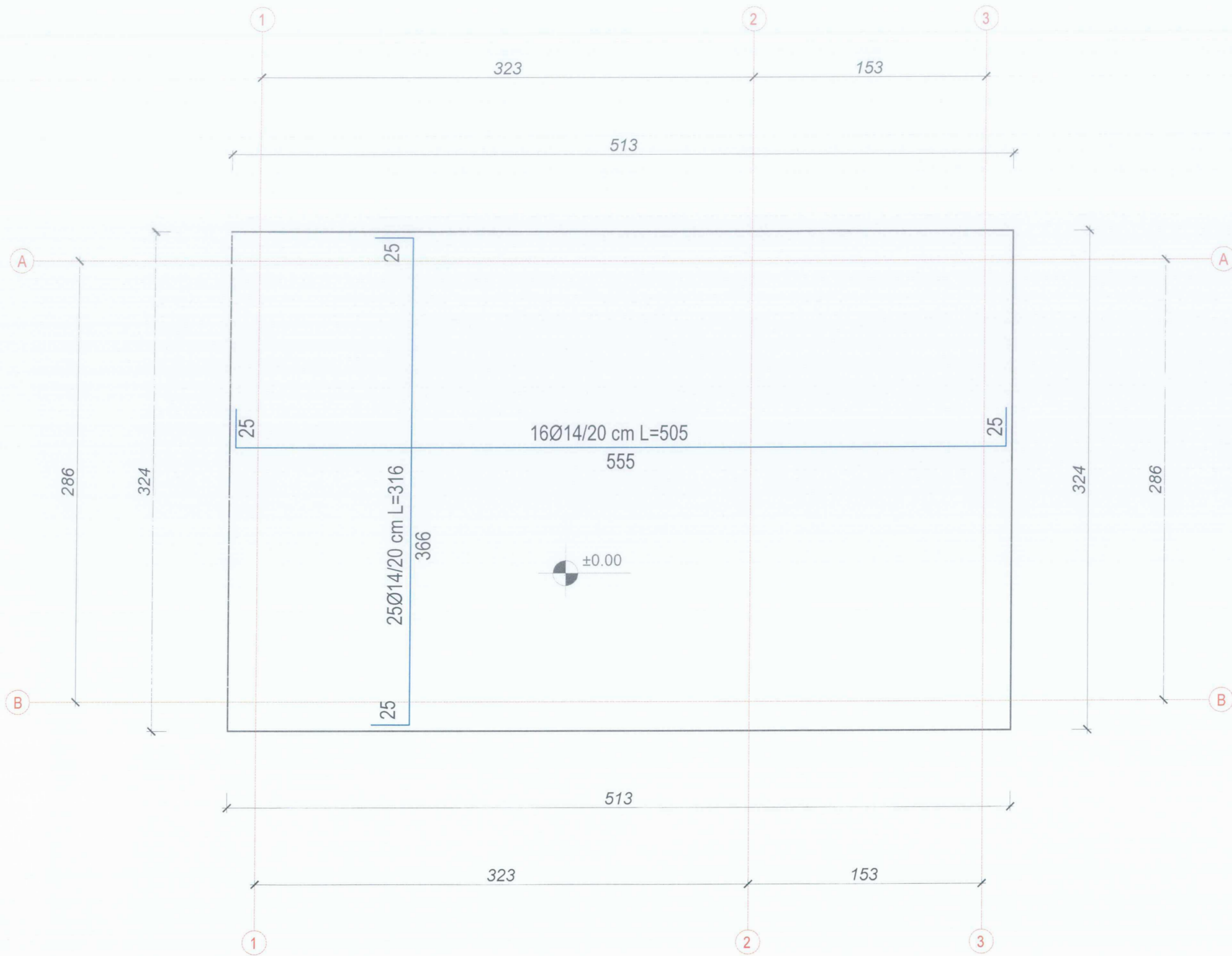

SHKOLLA 9-VJECARE "AVNI RUSTEMI"



BASHKIA VLORË

DREJTORIA E
PLANIFIKIMIT DHE
ZHVILLIMIT TË
TERRITORIT

GRUPI I PROJEKTIMIT:
Ark. Ilir Kokuri
Ark. Suela Abazaj
Ing. Ana Celaj
Ing. Edmond Beqiri

SHKOLLA 9-VJECARE "AVNI RUSTEMI"

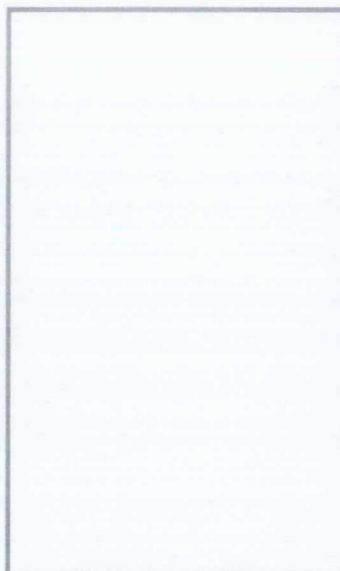
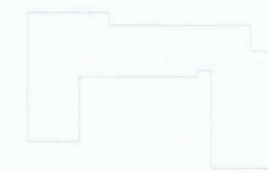

BASHKIA VLORE

DREJTORIA E
PLANIFIKIMIT DHE
ZHVILLIMIT TË
TERRITORIT

GRUPI I PROJEKTIMIT:

Ark. Ilir Kokuri

Ark. Suela Abazaj

Ing. Ana Celaj

Ing. Edmond Beqiri

VLORE 2020

K-06

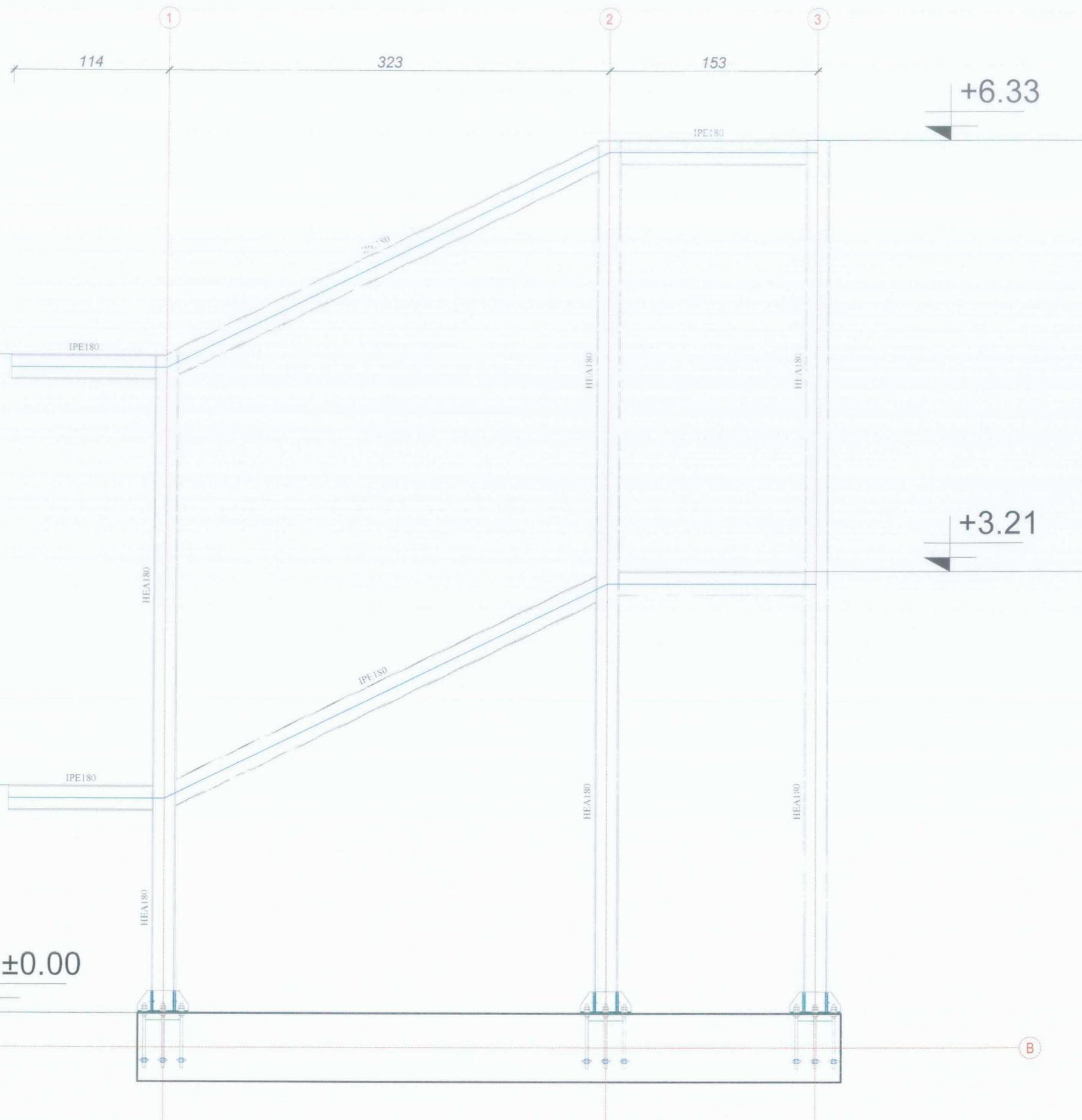

SHKOLLA 9-VJECARE "AVNI RUSTEMI"



BASHKIA VLORE

DREJTORIA E
PLANIFIKIMIT DHE
ZHVILLIMIT TË
TERRITORIT

GRUPI I PROJEKTIMIT:
Ark. Ilir Kokuri
Ark. Suela Abazaj
Ing. Ana Celaj
Ing. Edmond Beqiri

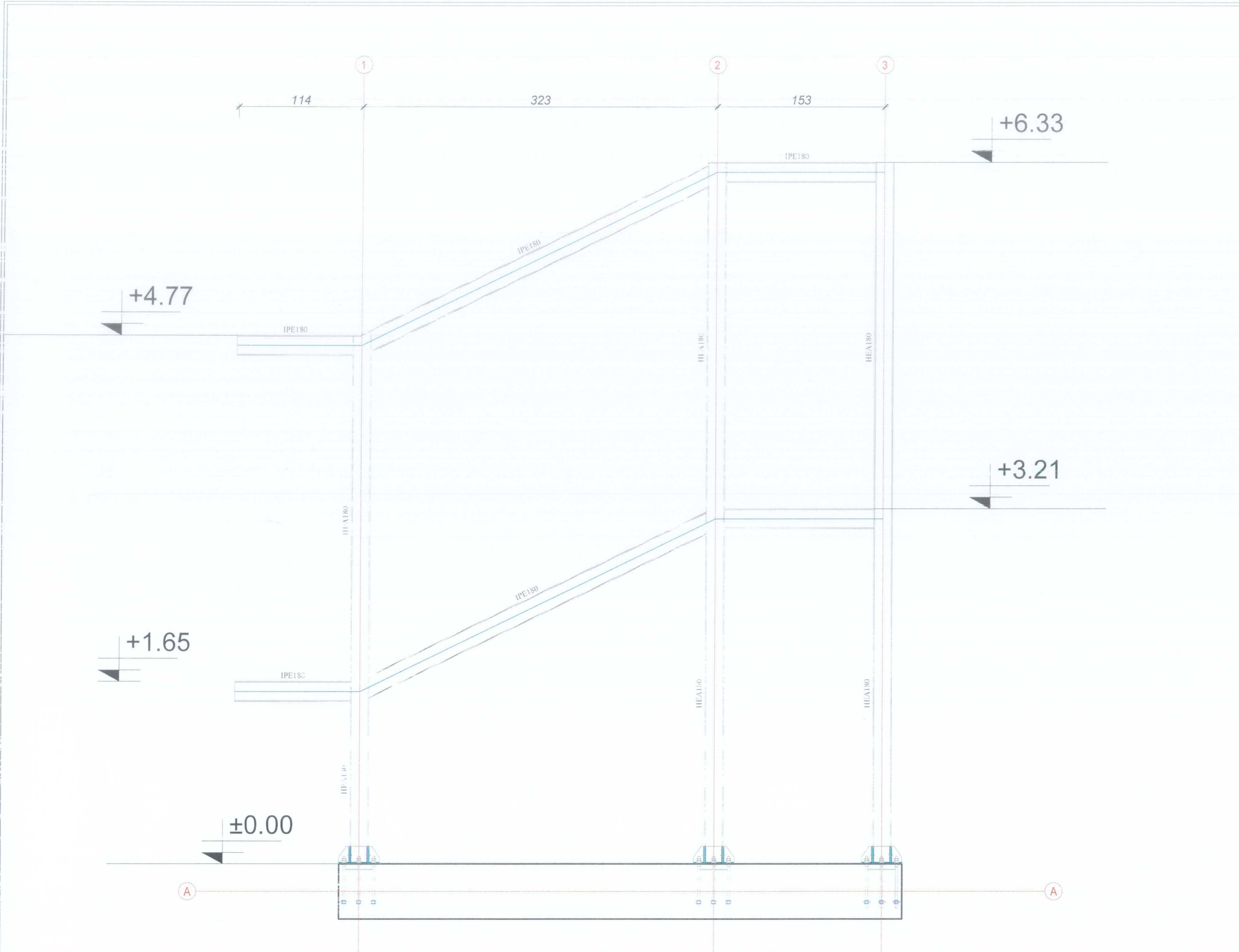

SHKOLLA 9-VJECARE "AVNI RUSTEMI"

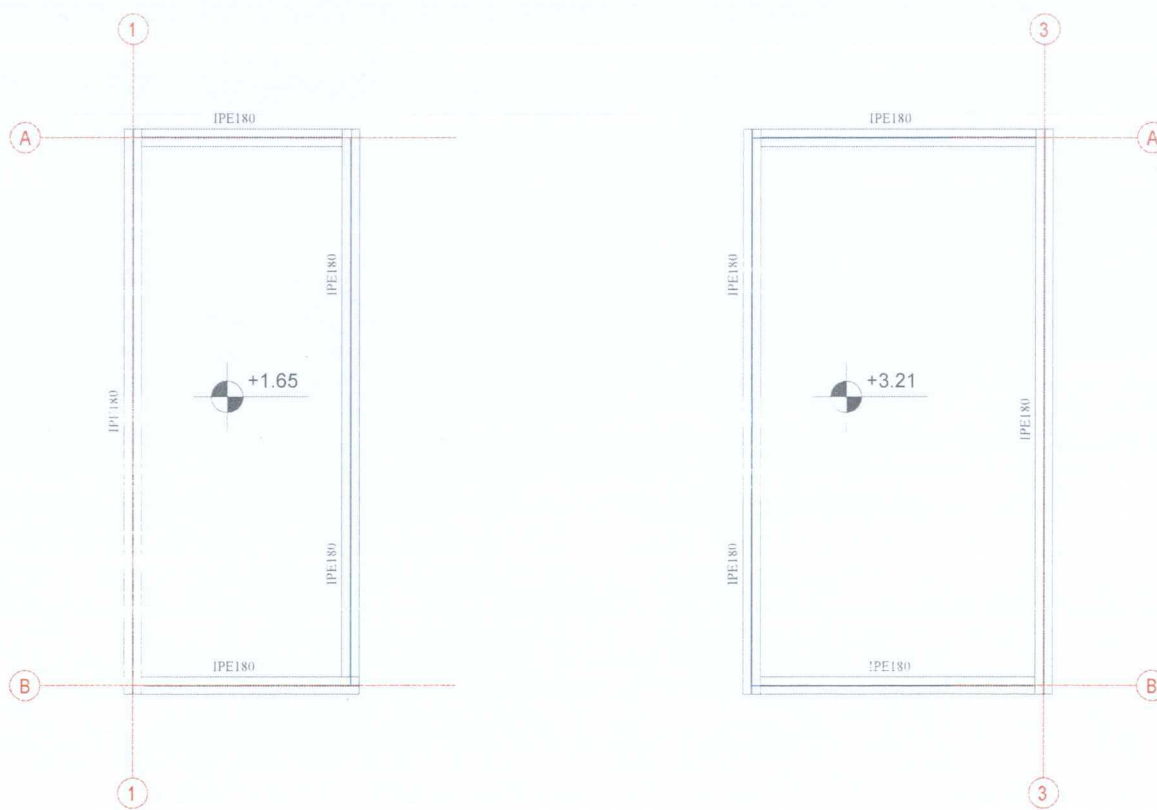
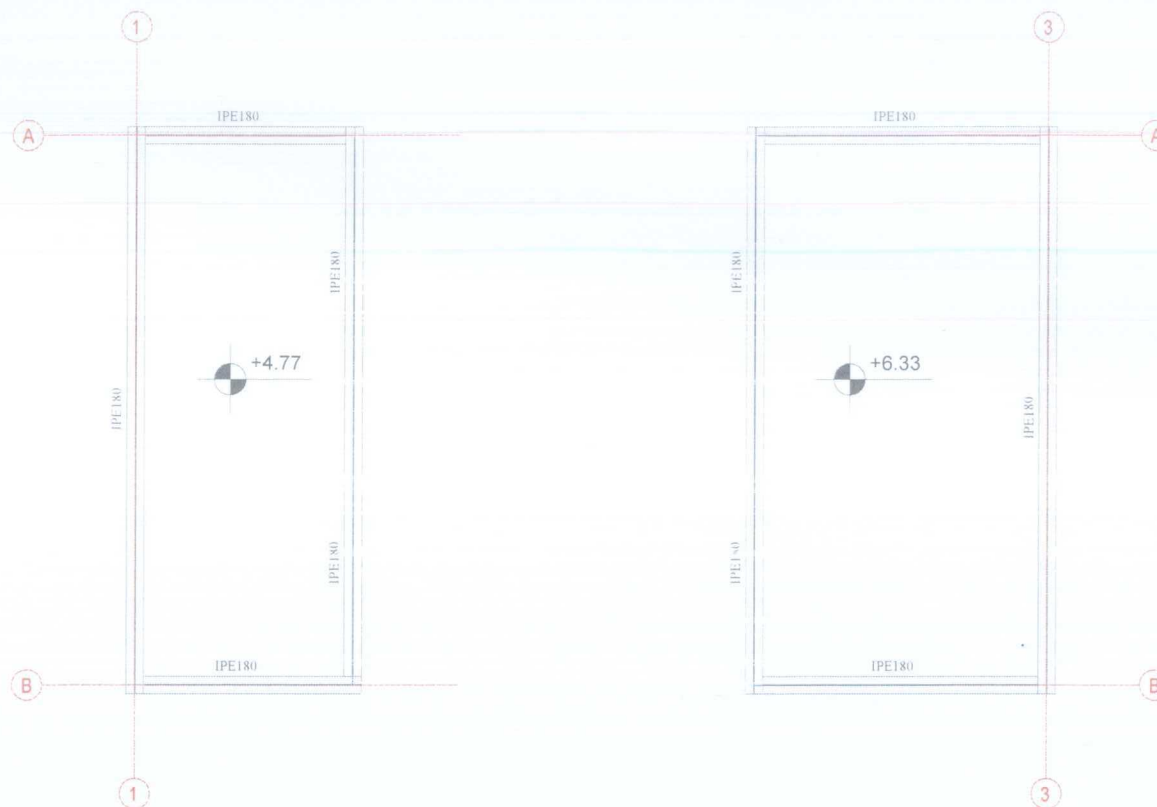

BASHKIA VLORE

DREJTORIA E
PLANIFIKIMIT DHE
ZHVILLIMIT TË
TERRITORIT

GRUPI I PROJEKTIMIT:

Ark. Ilir Kokuri

Ark. Suela Abazaj

Ing. Ana Celaj

Ing. Edmond Beqiri

VLORE 2020

K-08

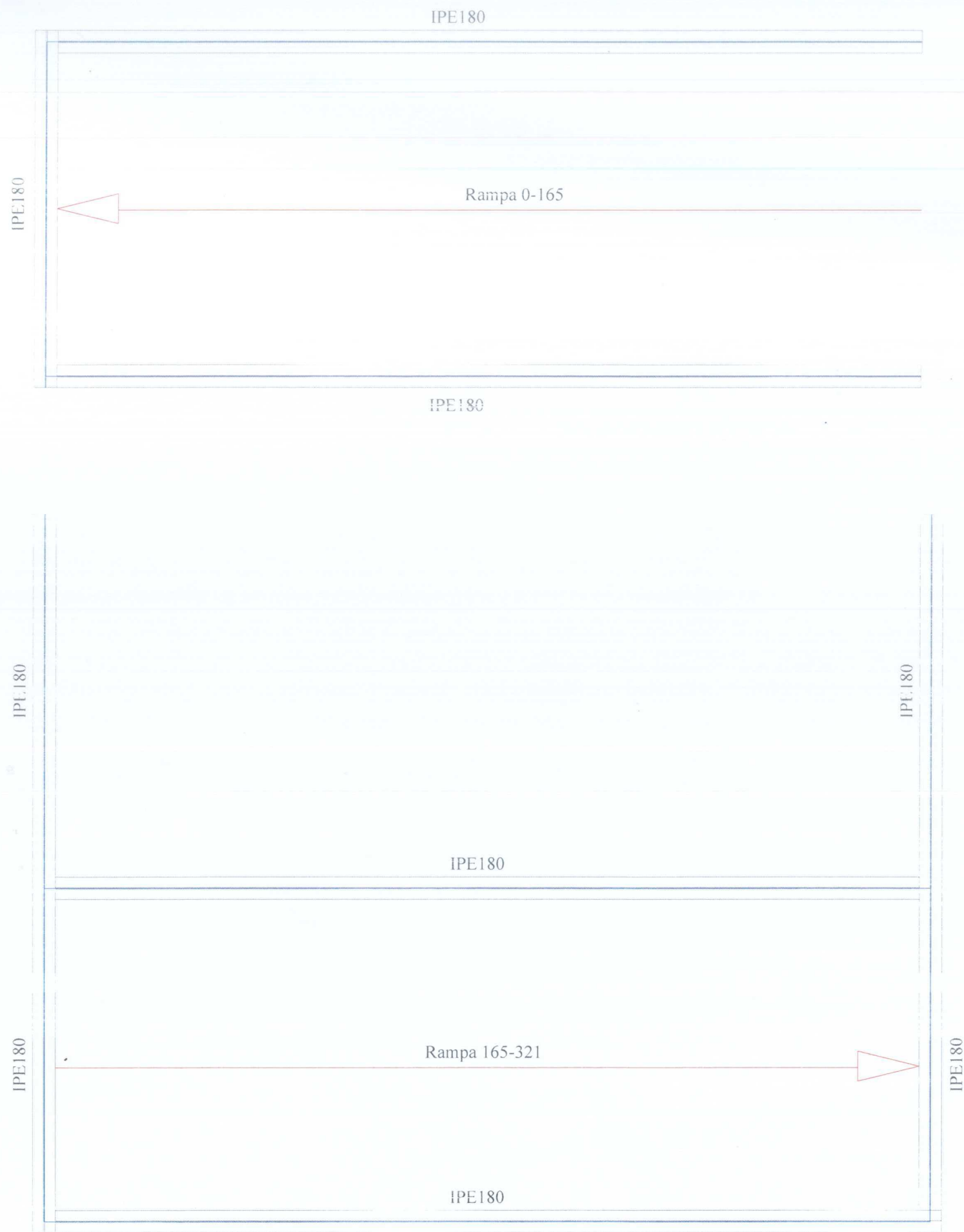

SHKOLLA 9-VJECARE "AVNI RUSTEMI"

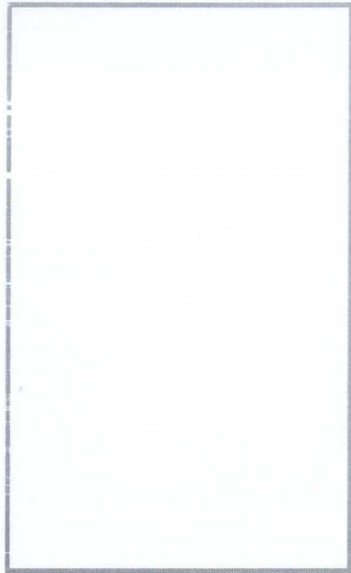

BASHKIA VLORE

DREJTORIA E
PLANIFIKIMIT DHE
ZHVILLIMIT TË
TERRITORIT

GRUPI I PROJEKTIMIT:
Ark. Ilir Kokuri
Ark. Suela Abazaj
Ing. Ana Celaj
Ing. Edmond Beqiri



SHKOLLA 9-VJECARE "AVNI RUSTEMI"

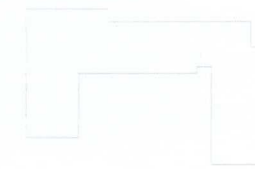

IPE 180

Rampa 321-477

IPE 180

IPE 180

BASHKIA VLORË

DREJTORIA E
PLANIFIKIMIT DHE
ZHVILLIMIT TË
TERRITORIT

GRUPI I PROJEKTIMIT:

Ark. Ilir Kokuri

Ark. Suela Abazaj

Ing. Ana Celaj

Ing. Edmond Beqiri

VLORE 2020

K-10

SHKOLLA 9-VJECARE "AVNI RUSTEMI"

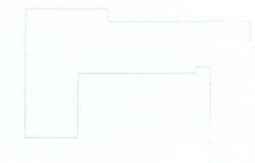

BASHKIA VLORE

DREJTORIA E
PLANIFIKIMIT DHE
ZHVILLIMIT TË
TERRITORIT

GRUPI I PROJEKTIMIT:

Ark. Ilir Kokuri

Ark. Suela Abazaj

Ing. Ana Celaj

Ing. Edmond Beqiri

ESECUTIVO SOGE 1:1,08

SEZIONE A-A

SEZIONE B-B

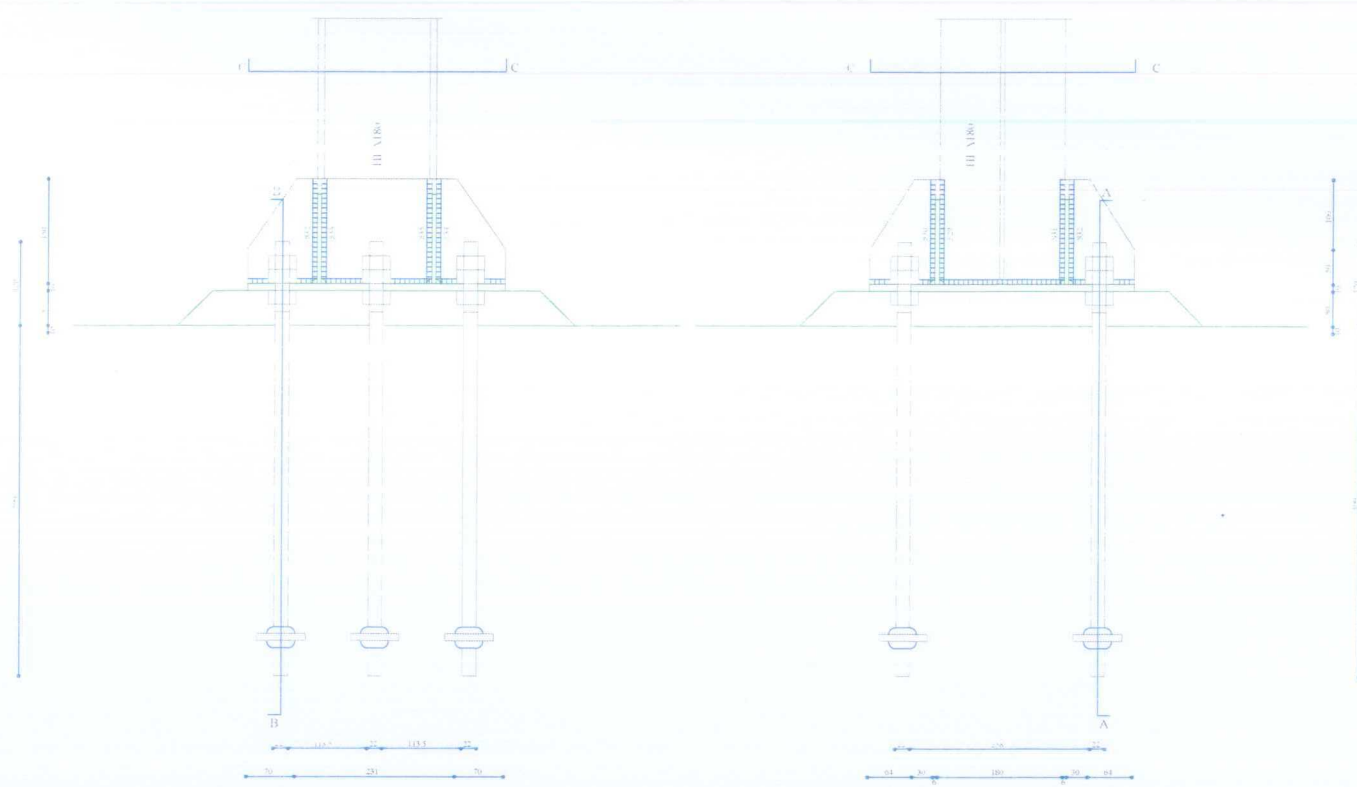

NO	DESCRIZIONE	Q	UNITA'	VALORE
1
2
3
4
5
6
7
8
9
10
11
12
13
14
15
16
17
18
19
20
21
22
23
24
25
26
27
28
29
30
31
32
33
34
35
36
37
38
39
40
41
42
43
44
45
46
47
48
49
50

TRAFONDO

SEZIONE C-C

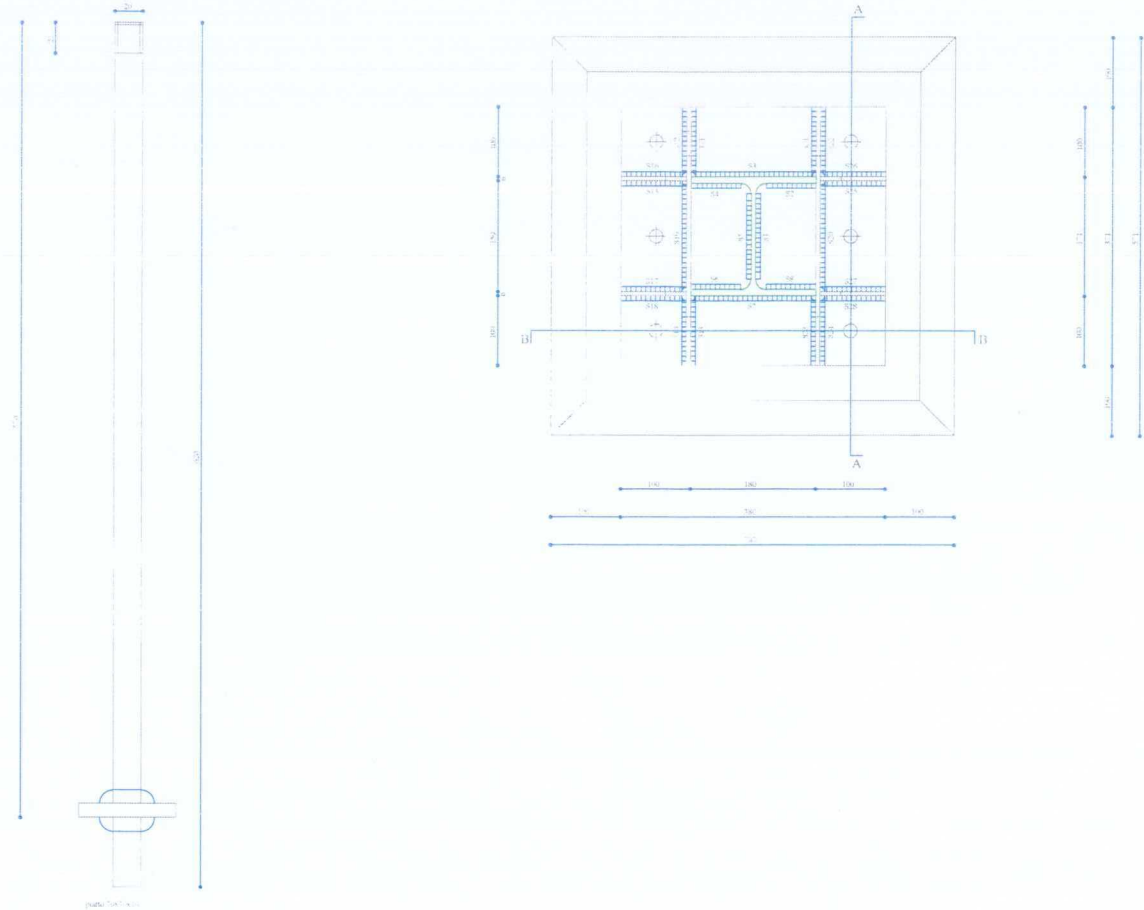

SHKOLLA 9-VJECARE "AVNI RUSTEMI"



BASHKIA VLORE

DREJTORIA E PLANIFIKIMIT DHE ZHVILLIMIT TË TERRITORIT

GRUPI I PROJEKTIMIT:

Ark. Ilir Kokuri

Ark. Suela Abazaj

Ing. Ana Celaj

Ing. Edmond Beqiri



VLORE 2020

K-12

SHKOLLA 9-VJECARE "AVNI RUSTEMI"

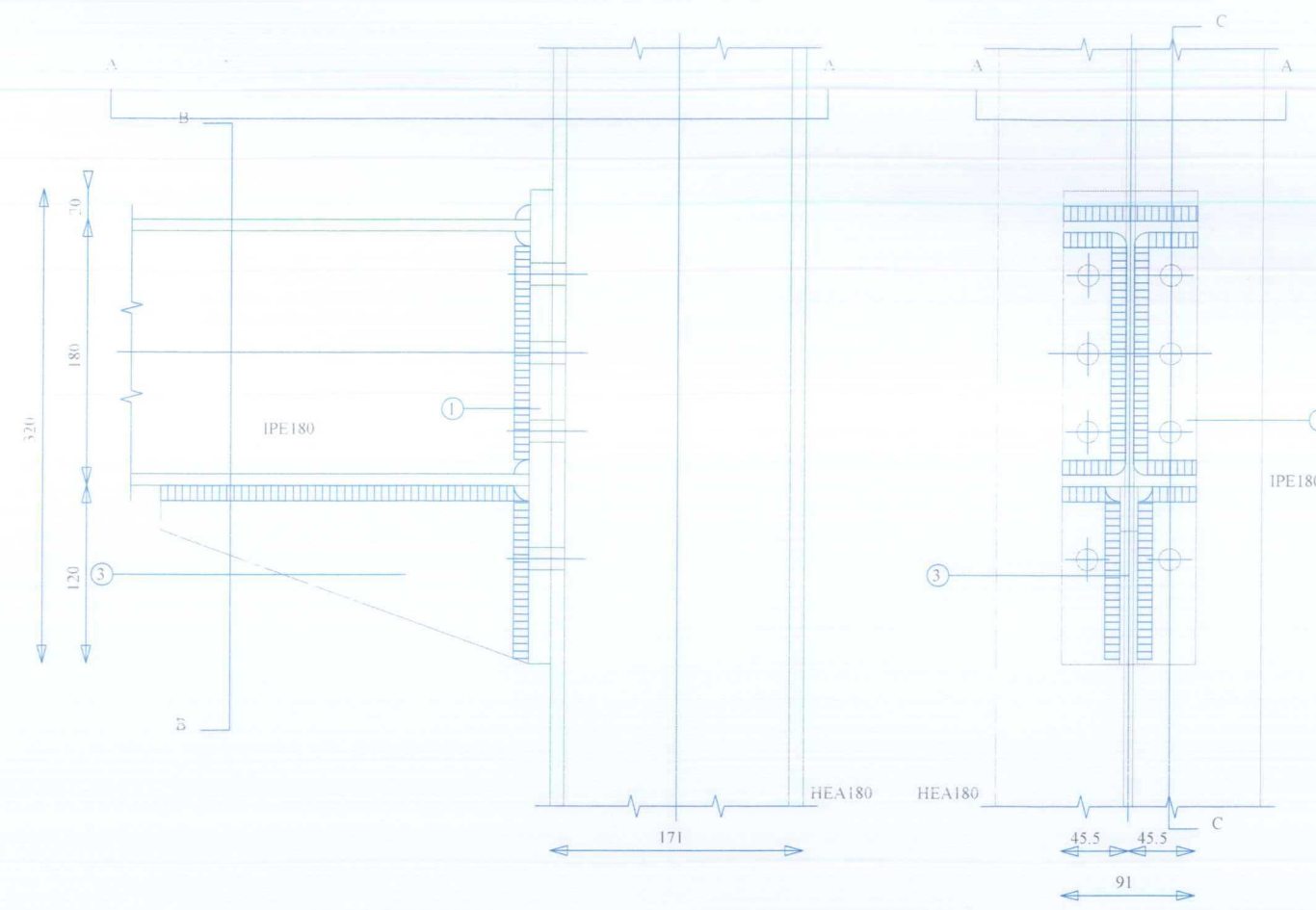

Piastra in acciaio tipo S 275 (Fe 430)
 Viti classe 8.8
 Lato saldature su trave: 10
 Lato saldature su colonna: 10

SEZIONE CC

SEZIONE BB

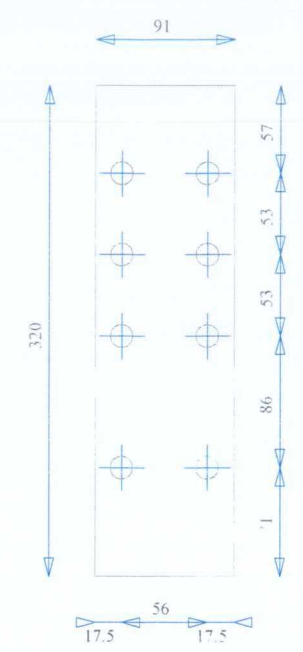
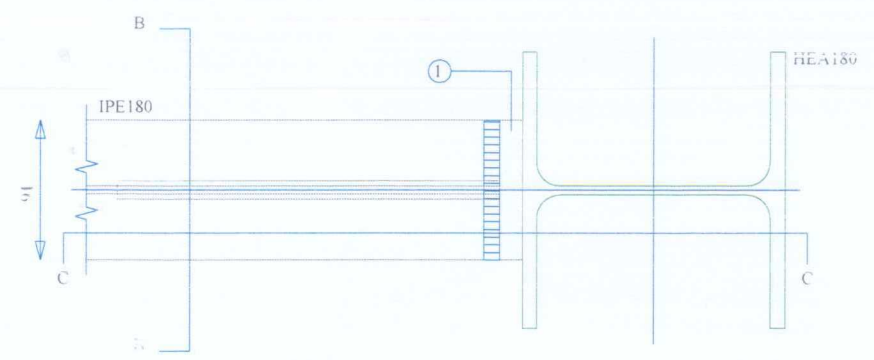

spessore = 15
 fori Ø15
 bulloni M14

spessore = 12

PIASTRA 3

SEZIONE AA

PIASTRA 1

BASHKIA VLORE

DREJTORIA E
 PLANIFIKIMIT DHE
 ZHVILLIMIT TË
 TERRITORIT

GRUPI I PROJEKTIMIT:
 Ark. Ilir Kokuri
 Ark. Suela Abazaj
 Ing. Ana Celaj
 Ing. Mandi Karocieri

VLORE 2020

K-17

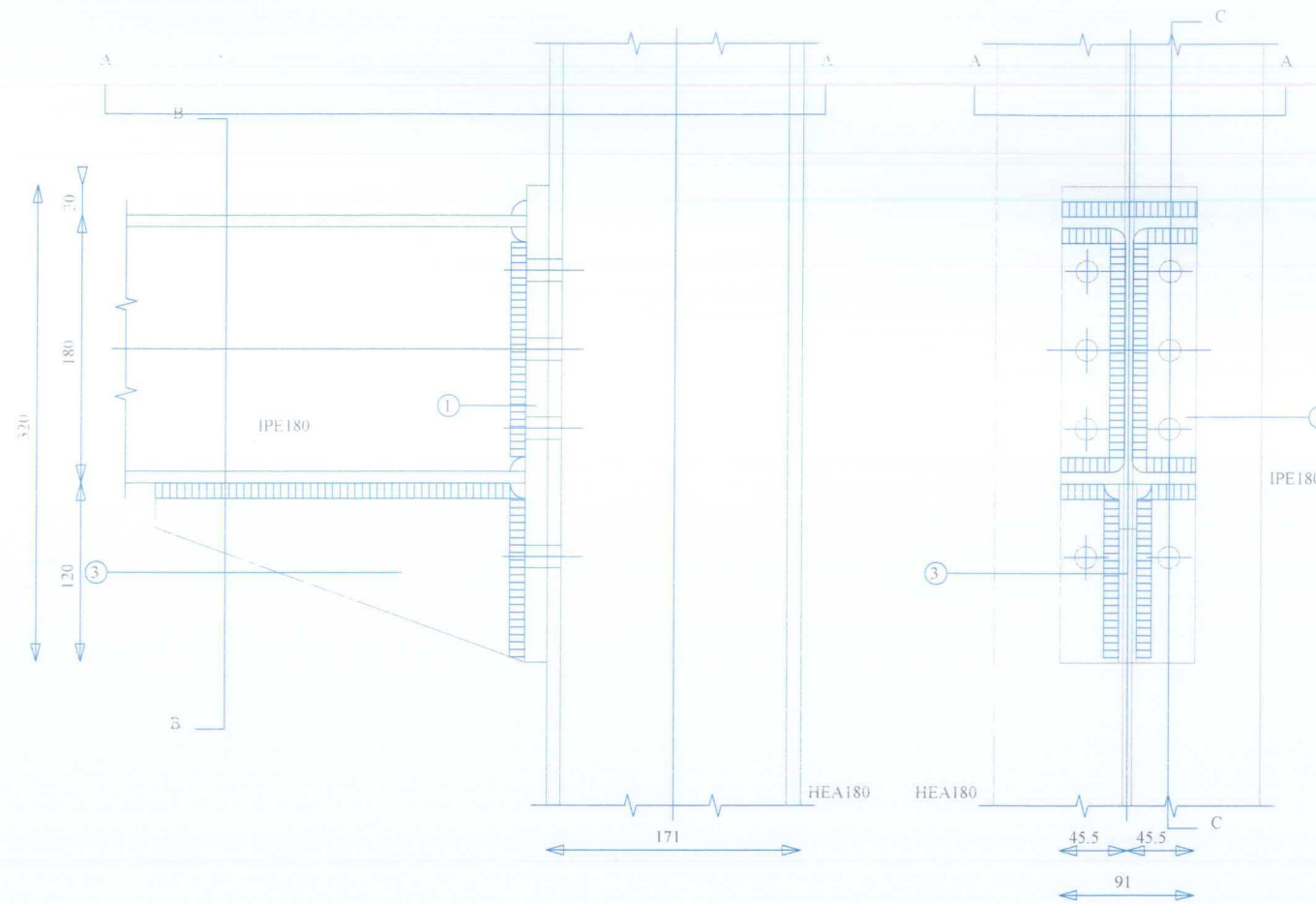

Piastre in acciaio tipo S 275 (Fe 430)
 Viti classe 8.8
 Lato saldature su trave: 10
 Lato saldature su colonna: 10

SHKOLLA 9-VJECARE "AVNI RUSTEMI"



SEZIONE CC

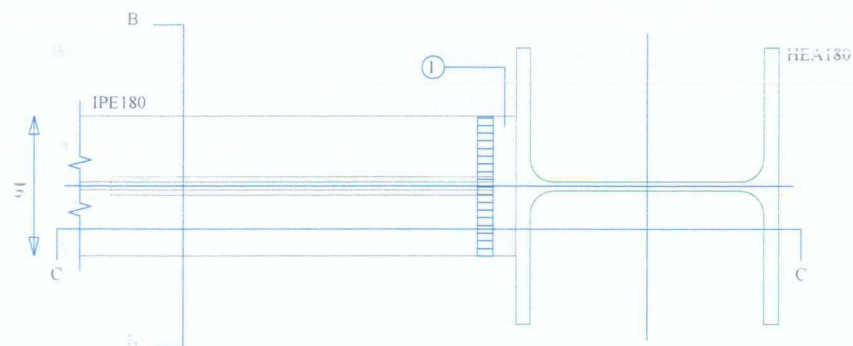

SEZIONE AA

SEZIONE BB



spessore = 15
 fori Ø15
 bulloni M14

PIASTRA 1



spessore = 12

PIASTRA 3

BASHKIA VLORE

DREJTORIA E
 PLANIFIKIMIT DHE
 ZHVILLIMIT TË
 TERRITORIT

GRUPI I PROJEKTIMIT:

Ark. Ilir Kokuri

Ark. Suela Abazaj

Ing. Ana Celaj

Ing. Mandi Karocieri

VLORE 2020

K-17