

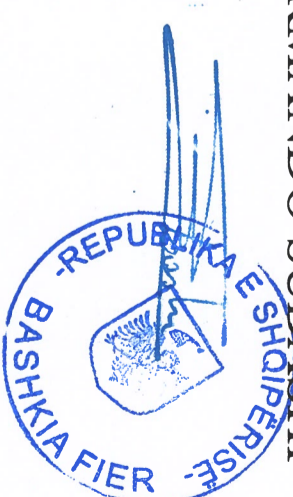

BASHKIA FIER

DREJTORIA E PROJEKTEVE TE INFRASTRUKTURES

MIRATOI
KRYETARI I BASHKISE FIER
ARMANDO SUBASHI





PROJEKT ZBATIMI

NDERTIMI I KOLEKTORIT KUZ - BULEVARDI "JAKOV XOXHA"

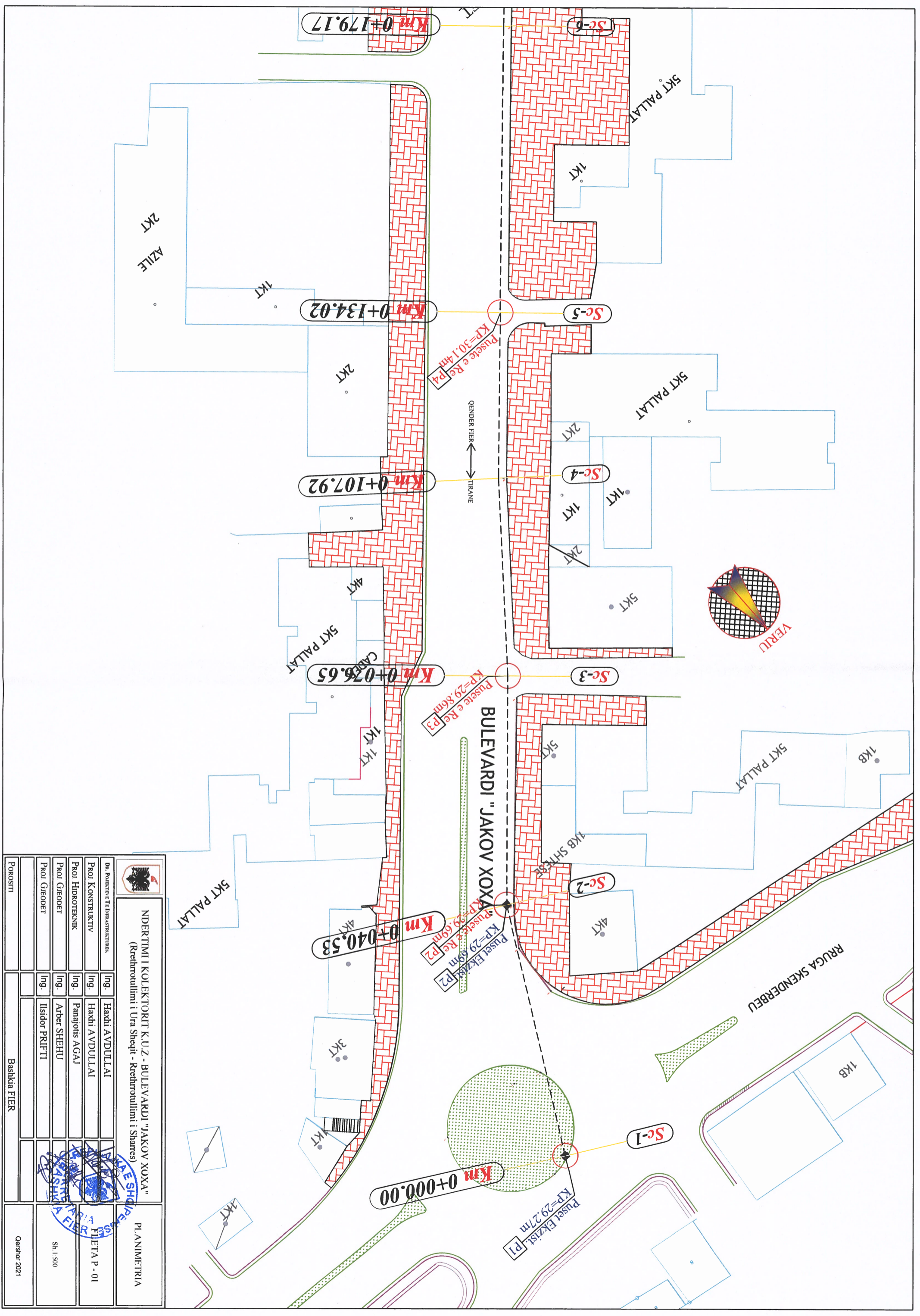
"Rrethe rrotullimi i Ura Sheqit - Rrethe rrotullimi i sharres"





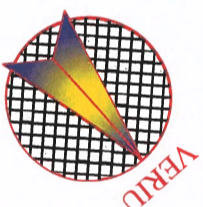
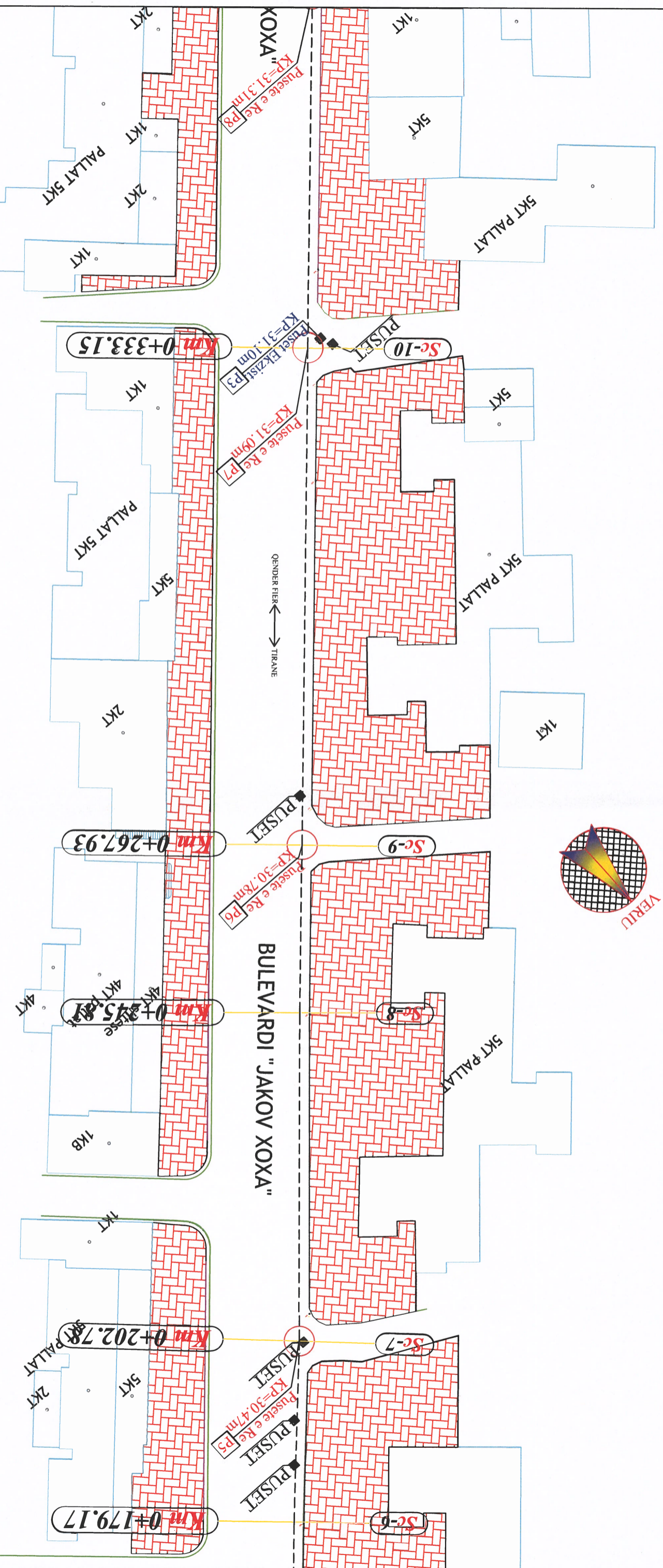

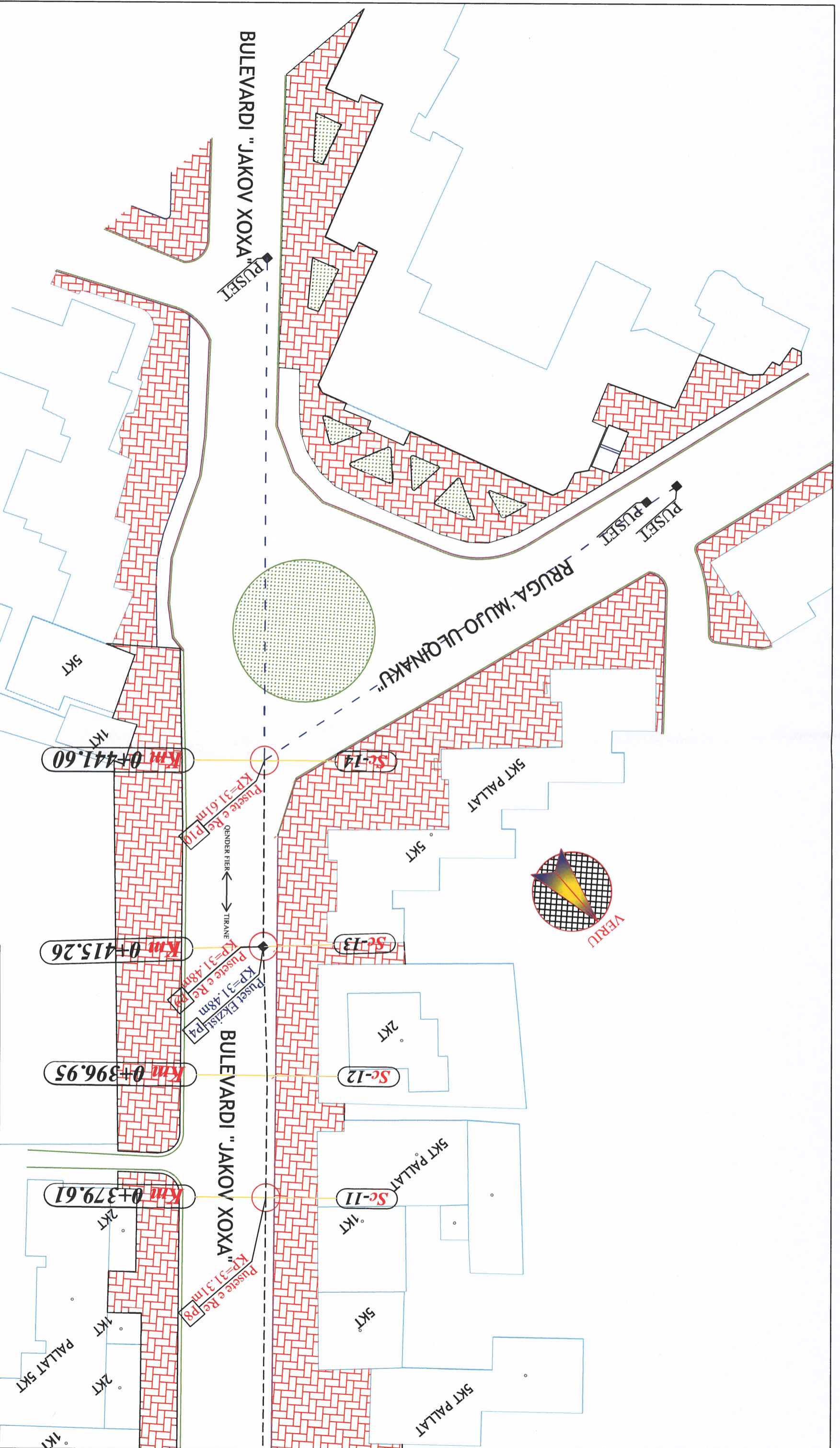

		NDERTIMI I KOLEKTORIT K.U.Z. - BULEVARDI "JAKOV XOXA" (Rethrutullimi i Ura Sheqit - Rethrutullimi i Shares)			
DR. PUSHTENI & T.E. INER.STRUKTURUES.	Ing.	Haxhi AVDULLAI	Ing.	Haxhi AVDULLAI	PLANIMETRIA FLETA P - 01 Sh. 1:500 Qershor 2021
PROJ. KONSTRUKTIV	Ing.	Haxhi AVDULLAI	Ing.	Haxhi AVDULLAI	
PROJ. HIDROTEKNIK	Ing.	Panajotis AGAJ	Ing.	Panajotis AGAJ	
PROJ. GJEODET	Ing.	Arber SHEHU	Ing.	Arber SHEHU	
PROJ. GJEODET	Ing.	Ilisidor PRIFTI	Ing.	Ilisidor PRIFTI	
POROSITTI	Bashkia FIER				



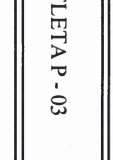
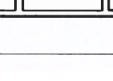

		NDERTIMI I KOLEKTORIT K.U.Z - BULEVARDI "JAKOV XOXA" (Rethrotullimi i Ura Sheqitë - Rethrotullimi i Sharrës)		PLANIMETRIA	
Dr. Projektive e Te Infrastukturës,	Ing.	Haxhi AVDULLAI			
Proi Konstruktiv	Ing.	Haxhi AVDULLAI			FLETA P - 02
Proi Hidroteknik	Ing.	Pangjotes AGAJ			
Proi Gjeodet	Ing.	Aber SHEHU			Sh. 1.500
Proi Gjeodet	Ing.	Ilisidor PRLE TI			
Porositi					Qershor 2021
Bashkia FIER					

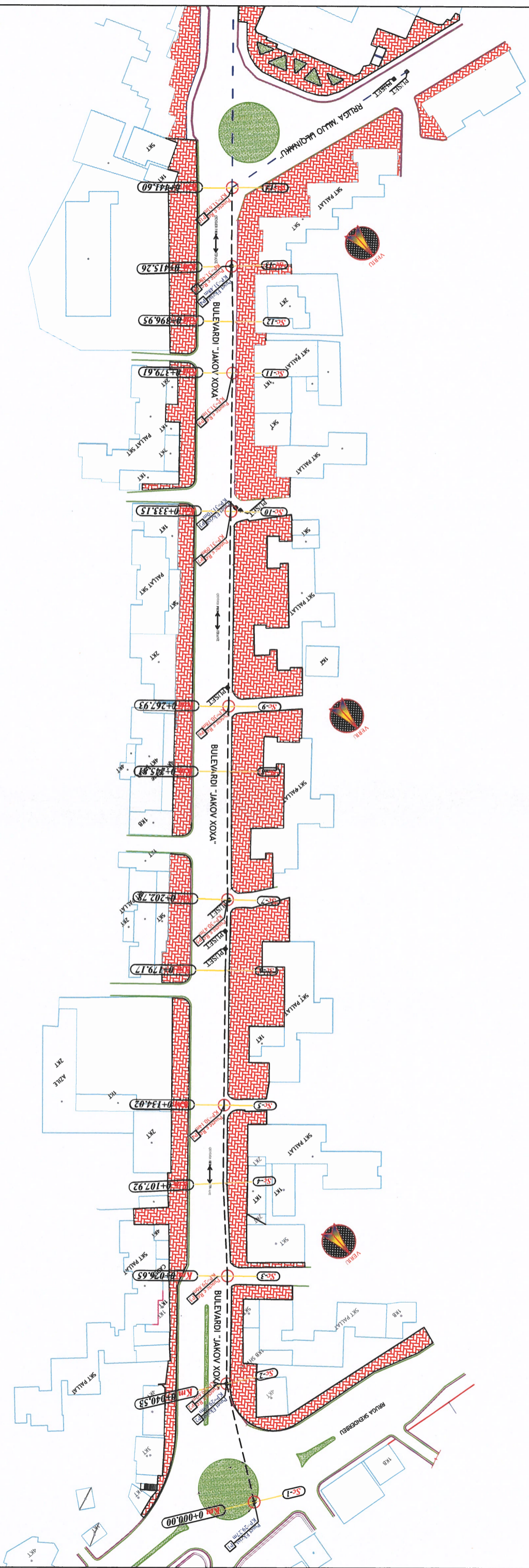

		NDERTIMI I KOLEKTORIT K.U.Z. - BULEVARDI "JAKOV XOXA" (Rrethrotullimi i Ura Sheqit - Rrethrotullimi i Sharrës SHQIP)				PLANIMETRIA	
DR. PLOTINË E TË INFRASTRUKTURËS.		Ing.	Haxhi AVDULLAI			PLANIMETRIA	
PROJ. KONSTRUKTIV		Ing.	Haxhi AVDULLAI			LETA P - 03	
PROJ. HIPROTEKNIK		Ing.	Pangjots AGAJ			SH. 1:500	
PROJ. GJEODET		Ing.	Arber SHEHU				
PROJ. GJEODET		Ing.	Ilisdr PRIFTI				
POROSITI		Bashkia FIER				Qershor 2021	

PLANIMETRIA E PERGJITTHESHME



		NDERTIMI I KOLEKTORIT K.U.Z. - BULEVARDI "JAKOV XOXA" (Rethrotullimi i Ura Sheqit - Rethrotullimi i Sharrës)		PLANIMETRIA E PLOTE	
DR. ROBERTE TRINBAR-STRUKTURES	Ing.	Haxhi AVDULLAI		PLANIMETRIA E PLOTE Sh. 1:500 Qershor 2021	
PROJ KONSTRUKTIV	Ing.	Haxhi AVDULLAI			
PROJ HIDROTEKNIK	Ing.	Panajotis AGAJ			
PROJ GJEODET	Ing.	Arber SHEHU			
PROJ GJEODET	Ing.	Isidor PRIFTI			
POROSITI		Bashkia FIER			



Profili Gjatesor
 Kolektori Jakov Xoxa
 SH.Vertikale 1:50
 SH.Horizontalale 1:500

Pjerrësia	Seksionet	Dist.Pjesore	Dist.Progres	Kuota Tokes	Kuota Projekt	Kuota Punes
	Sc-1	40.53	0+000.00	34.63	29.27	-5.36
	Sc-2	36.13	0+040.53	34.19	29.69	-4.50
	Sc-3	31.27	0+076.65	33.64	29.86	-3.78
	Sc-4	26.10	0+107.92	33.58	30.01	-3.57
	Sc-5	45.14	0+134.02	33.51	30.14	-3.37
	Sc-6	23.62	0+179.17	33.47	30.35	-3.12
	Sc-7	23.62	0+202.78	33.58	30.47	-3.12
	Sc-8	22.12	0+245.81	33.77	30.67	-3.09
	Sc-9	65.22	0+267.93	33.96	30.78	-3.18
	Sc-10	46	0+333.15	34.31	31.09	-3.22

NDERITIMI I KOLEKTORIT K.U.Z. - BULEVARDI "JAKOV XOXA" (Rrethrotullimi i Ura Sheqit - Rrethrotullimi i Shares)		PROFILI GJATESOR Fletë A.GJ - 05
Dr. ROKETVE TE INZHINIERI KTRIBES	Ing.	Haxhi AVDULLAI
PROJ KONSTRUKTIV	Ing.	Haxhi AVDULLAI
PROJ HIDROTEKNIK	Ing.	Panajotis AGAJ
PROJ GJEODET	Ing.	Arber SHEHU
PROJ GJEODET	Ing.	Ilisidor PRIFTI
POROSITI	Bashkia FIER	
		Qershor 2021

Profilu Gjatesor
 Kolektori Jakov Xoxa
 SH.Vertikale 1:50
 SH.Horizontalale 1:500

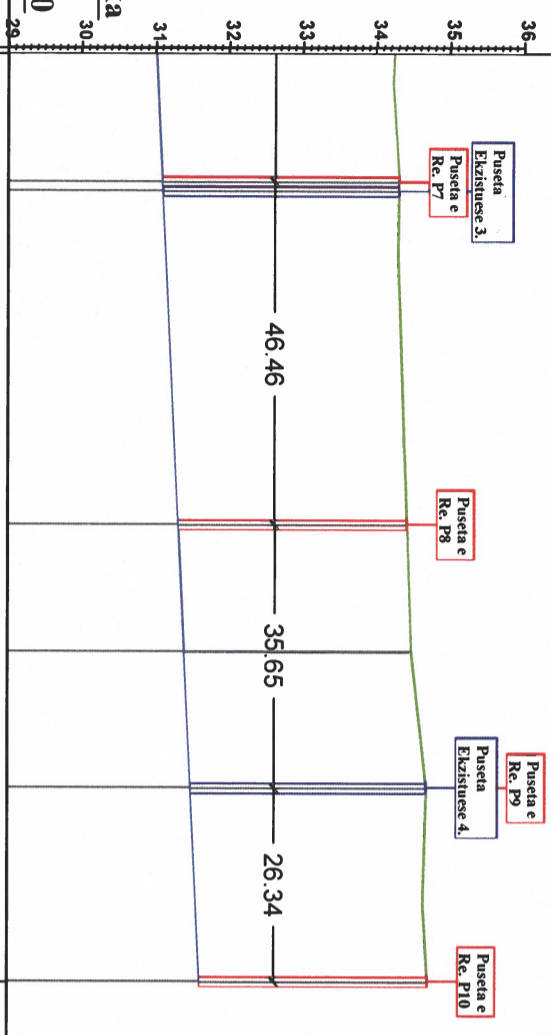

Pjerrësia	L=401.07				
Seksionet	Sc-10	Sc-11	Sc-12	Sc-13	Sc-14
Dist.Pjesore	46.46	17.34	18.31	26.34	
Dist.Progres	0+333.15	0+379.61	0+396.95	0+415.26	0+441.60
Kuota Tokes	34.31	34.42	34.48	34.68	34.70
Kuota Projekt	31.09	31.31	31.40	31.48	31.61
Kuota Punes	-3.22	-3.10	-3.08	-3.20	-3.09

NDERITMI I KOLEKTORIT K.U.Z - BULEVARDI "JAKOV XOXA" (Rrethrotullimi i Ura Sheqit - Rrethrotullimi i Shares)		PROFILI GJATESOR SH. Vertikale 1:50 SH. Horizontalale 1:500	
Dr. PREDKES TE INZHINJERIT	Ing.	Haxhi AVDULLAI	
PROJ KONSTRUKTIV	Ing.	Haxhi AVDULLAI	FL.ETA GJ - 06
PROJ HIDROTEKNIK	Ing.	Panajotis AGAJ	
PROJ GJEODET	Ing.	Arber SHEHU	Sh. Varibel
PROJ GJEODET	Ing.	Ilisidor PRIFTI	
POROSITI		Bashkia FIER	Qershor 2021

PRERJA TERTHORE E KANALIT

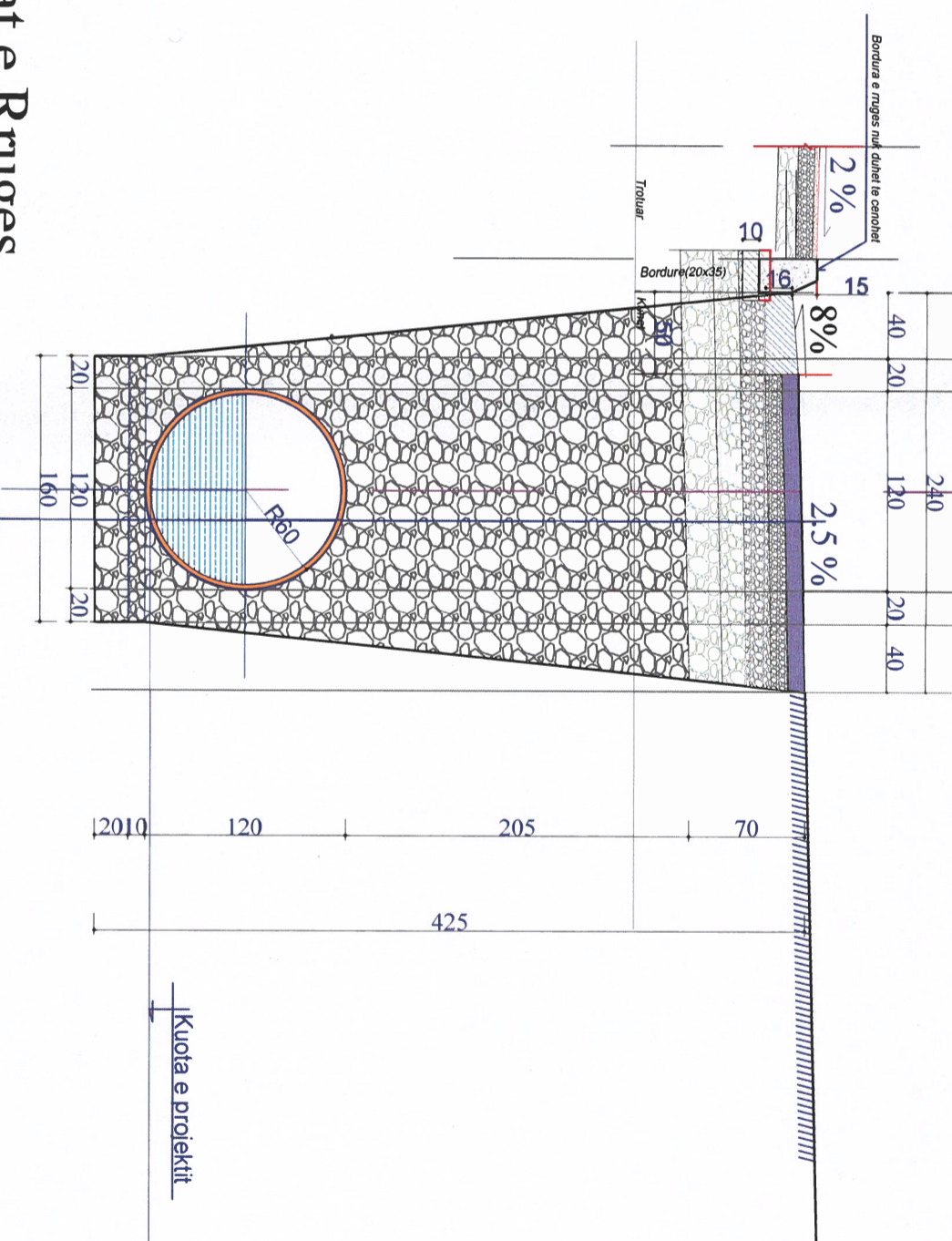

Shtresat e Rrugës

- Shtrese Asfalto betoni 4 cm
- Shtrese Binderi 6 cm
- Shtrese stabilizanti (0-20)10 cm
- Shtrese cakulli i thyer 5-50mm (1x15) cm
- Shtrese çakelli mbeturine kave t=20cm,
- Mbushje e ngjeshje me zhavor lumi t=10cm
- Tub i brinjëzuar me Ø1200mm
- Shtrese zhavor lumi t=10cm
- Shtrese çakelli mbeturine kave t=20cm,

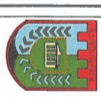
		NDERTIMI I KOLEKTORIT K.U.Z – BULEVARDI "JAKOV XOXHA" (Rrethrotullimi i Ura e Sheqit – Rrethrotullimi i Sharrës)		PRERJA TERTHORE E KANALIT K.U.Z	
Dr. Përkrahës Teknologjik	Ing.	Haxhi AVDULLAI			
Proj. KONSTRUKTIV	Ing.	Haxhi AVDULLAI			F. JETA - 08
Proj. HIDROTEKNIK	Ing.	Panajotis AGAJ			Sh. Varbel
Proj. GJEODET	Ing.	Arber SHEHU			
Proj. Gjeomet	Ing.	Ilisidor PRIFTI			
POROSITI					
		Bashkia FIER			Qershor 2021

PUSETE D=150cm TIPI-2

PER TUBATE BRINJEUZUARA 1200mm

PRERJA 1-1
SHK.1:50

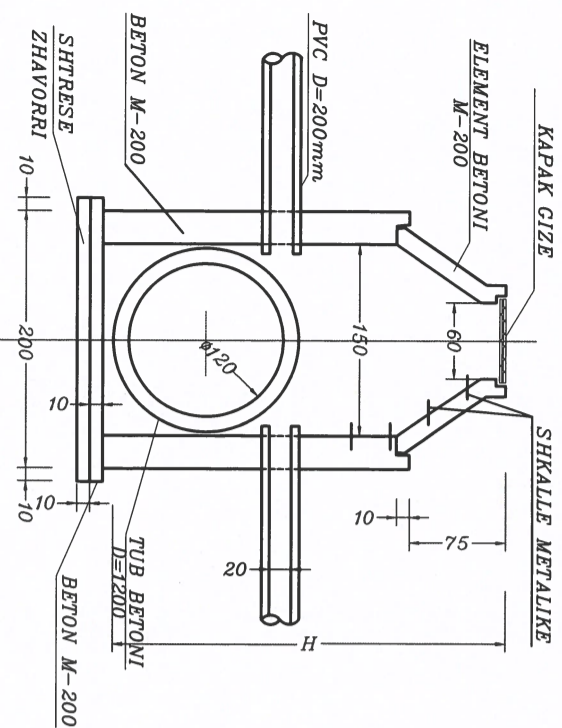

PRERJA 2-2 Shk.1:50

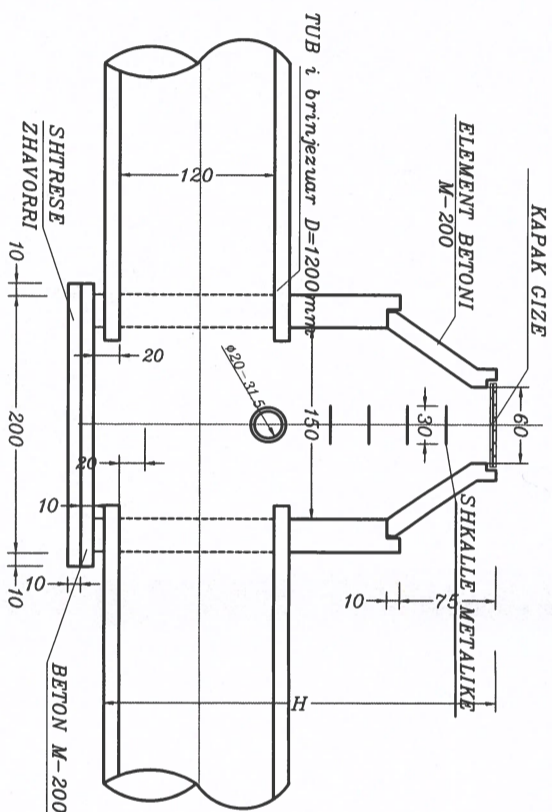

ELEMENT BETONI
SHK.1:20

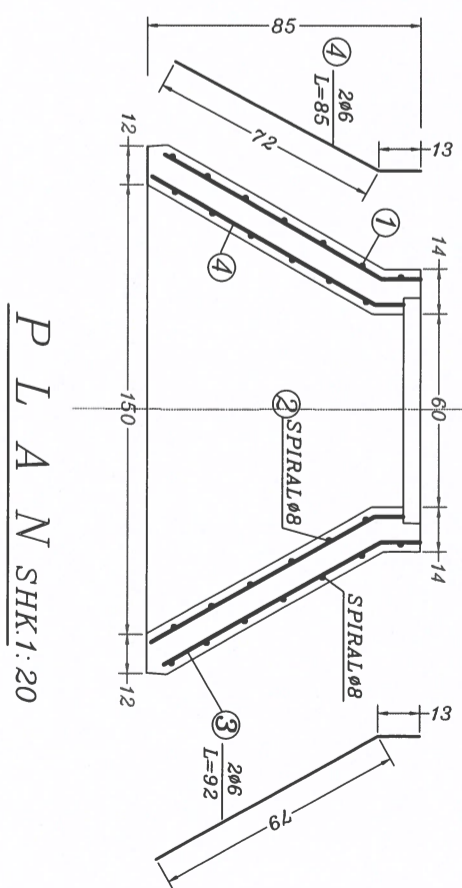

PLAN SHK.1:20

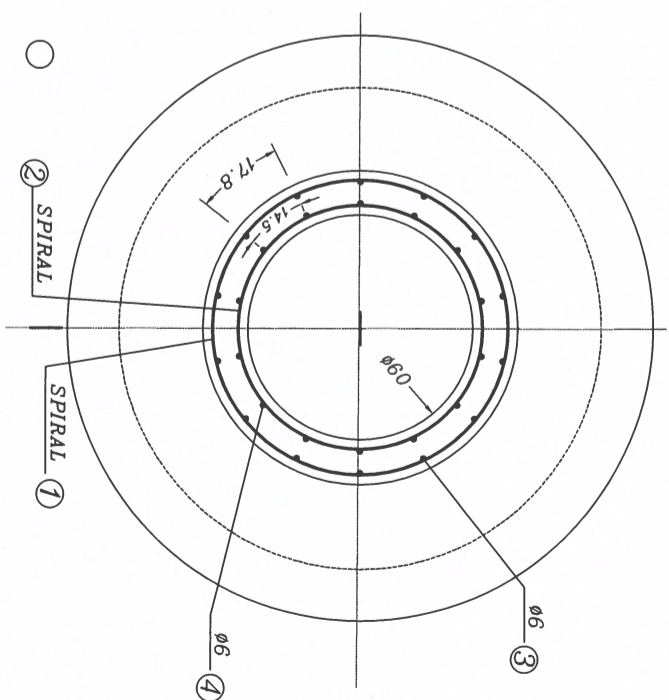
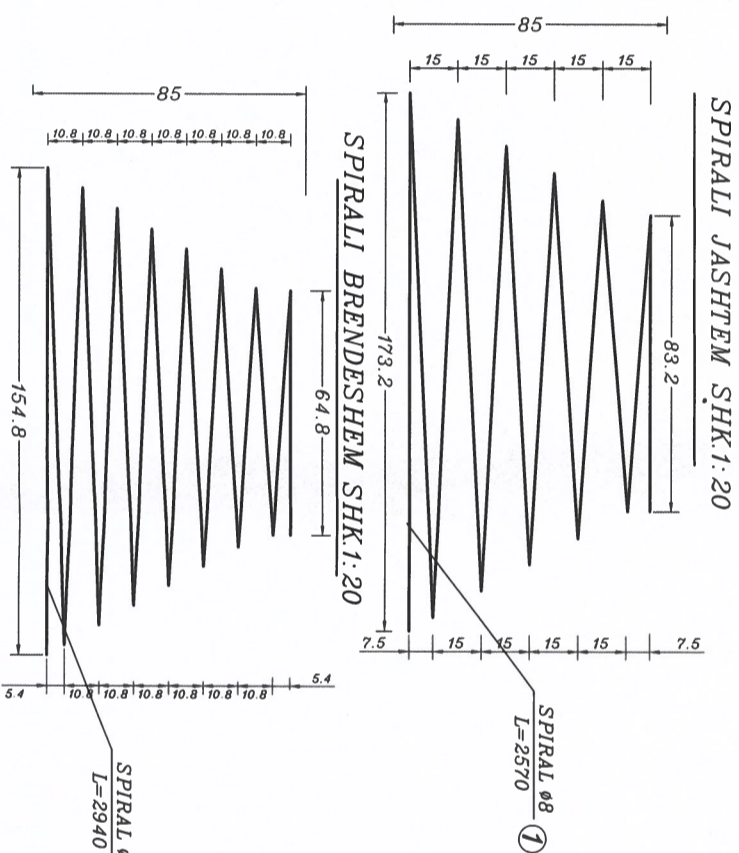
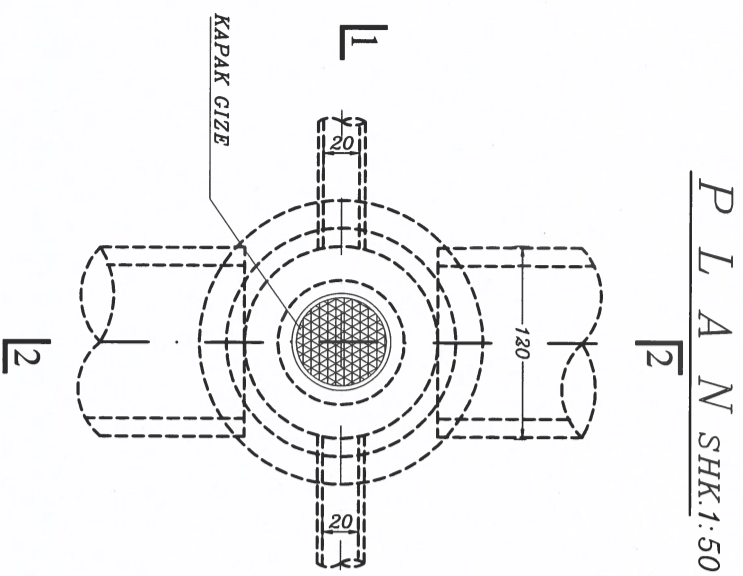

		NDERTIMI I KOLEKTORIT K.U.Z – BULEVARDI "JAKOV XOXHA" (Rethrotullimi i Ura e Sheqit – Rethrotullimi i Shqerres)		PUSETATE KONTROLLIT TE KUZ	
Dr. POKOSITI, Të Inxhinjeringut	Ing.	Haxhi AVDULLAI	Ing.	FLETA -09	
PROJ KONSTRUKTIV	Ing.	Haxhi AVDULLAI	Ing.		
PROJ HIDROTEKNIK	Ing.	Pangjotis AGAJ	Ing.		
PROJ GJEODET	Ing.	Arber SHEHU	Ing.		
PROJ GJEOMET	Ing.	Ilisidor PRIFTI	Ing.		
POKOSITI					
Bashkia FIER					
			Qershor 2021		

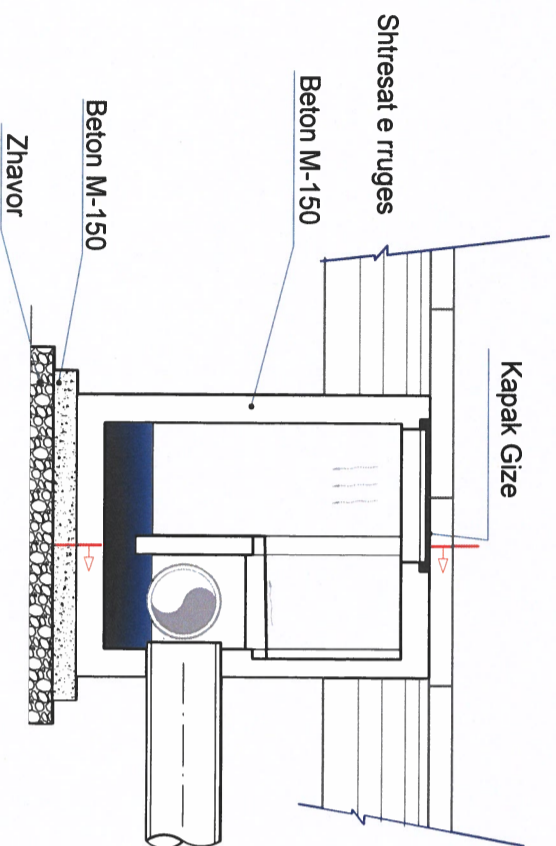

PUSETE UB ME SINFON VAR.1

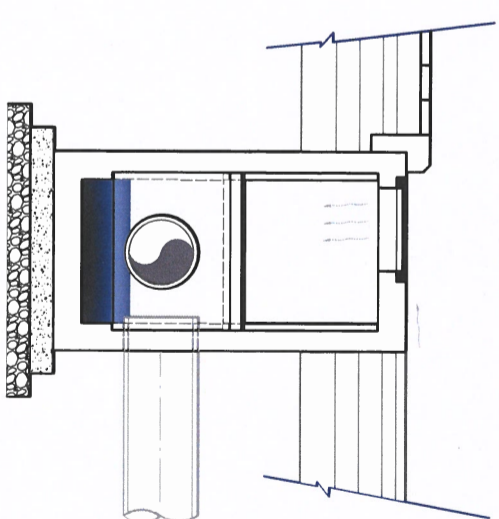

PUSETE UB ME SINFON VAR.2

A-A

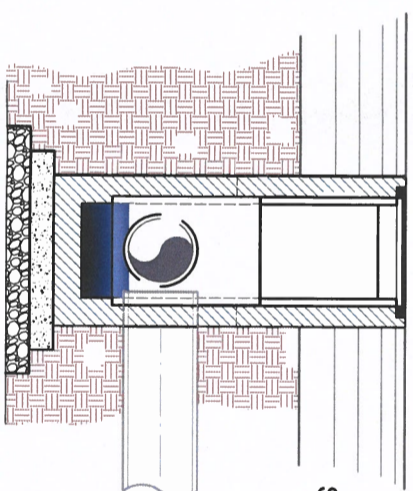
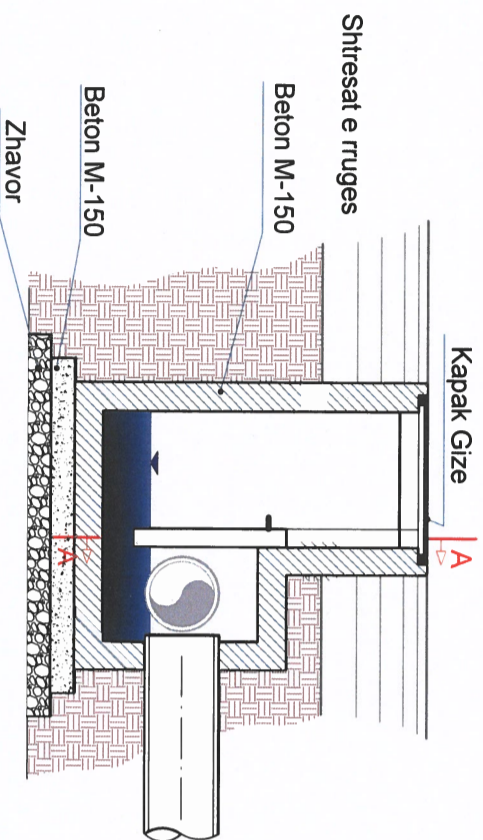

Shtresat e rruges

		NDERTIMI I KOLEKTORIT K.U.Z – BULEVARDI "JAKOV XHAXHAJ" (Rrethrotullimi i Ura e Sheqit – Rrethrotullimi i Sheqres)		PUSETATE UB ME SINFON	
Dr. Projektivë & Te Inzhinjeri Teknike	Ing.	Haxhi AVDULLAI			
Proj KONSTRUKTIV	Ing.	Haxhi AVDULLAI			FLETA -10
Proj HIDROTEKNIK	Ing.	Panajotis AGAJ			
Proj GJEODET	Ing.	Arber SHEHU			Sh. Varibel
PROJ GJEOMET	Ing.	Ilisidor PRIFTI			
POROSITI					
		Bashkia FIER			Qershor 2021