

PROJEKT ZBATIM

NDERTIM RRUGA: "BETIM MUÇO"



BASHKIA KAMËZ

MIRATOI

KRYETAR I BASHKISË KAMËZ

Z. RAKIP SULLI



BASHKIA KAMËZ

DREJTORIA E PROJEKTEVE DHE INVESTIMEVE
DEPARTAMENTI I PROJEKTEVE

Dr. e Projekteve e Investimeve FLORA MUCA

STAFI TEKNIK
PROJEKTUES

- Ing. ERBLIN LALA
- Ing. ARJOLA KURTI
- Ing. DENIS PRENÇI
- Ing. EGLANTINA DISHA
- Ing. RAMADAN HYSA

Titulli i Projektit
NDERTIM RRUGA "BETIM MUÇO"

Faza e Projektit
PROJEKT ZBATIMI

Data e Implementimit:

Shkalla e Vizatimit

Emertimi i Fletës
PROJEKT ZBATIM





Fleta Nr.

A-00

NDERTIM RRUGA: "BETIM MUÇO"



LEGJENDA

-  RRUGE EKZISTUESE
-  OBJEKTE
-  RRETHIME
-  NDARJE PARCELASH

BASHKIA KAMËZ

DREJTORIA E PROJEKTEVE DHE INVESTIMEVE
DEPARTAMENTI I PROJEKTEVE

Dr. e Projekteve e Investimeve	FLORA MUCA	<i>[Signature]</i>
STAFI TEKNIK PROJEKTES	Ing.	ERBLIN LALA
	Ing.	ARJOLA KURTI
	Ing.	DENIS PRENÇI
	Ing.	EGLANTINA DISHA
	Ing.	RAMADAN HYSA

Titulli i Projektit NDERTIM RRUGA "BETIM MUÇO"	Faza e Projektit PROJEKT ZBATIMI
Emertimi i Fletes PROJEKT ZBATIM	Data e Implementimit:
	Shkalla e Vizatimit
	Fiota Nr. A-01

NDERTIM RRUGA: "BETIM MUÇO"

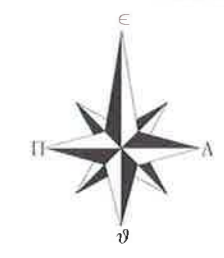

LEGJENDA

-  RRUGE EKZISTUESE
-  OBJEKTE
-  RRETHIME
-  NDARJE PARCELASH

BASHKIA KAMËZ

DREJTORIA E PROJEKTEVE DHE INVESTIMEVE
DEPARTAMENTI I PROJEKTEVE

Dr. e Projekteve e Investimeve		FLORA MUCA	
STAFI TEKNIK PROJEKTUES	Ing.	ERBLIN LALA	
	Ing.	ARJOLA KURTI	
	Ing.	DENIS PRENÇI	
	Ing.	EGLANTINA DISHA	
	Ing.	RAMADAN HYSA	

Titulli i Projektit	NDERTIM RRUGA "BETIM MUÇO"	Faza e Projektit	PROJEKT ZBATIMI
Emertimi i Flotes	PROJEKT ZBATIM	Data e Implementimit:	
		Shkalla e Vizatimit	
		Flota Nr.	A-02

NDERTIM RRUGA: "BETIM MUÇO"

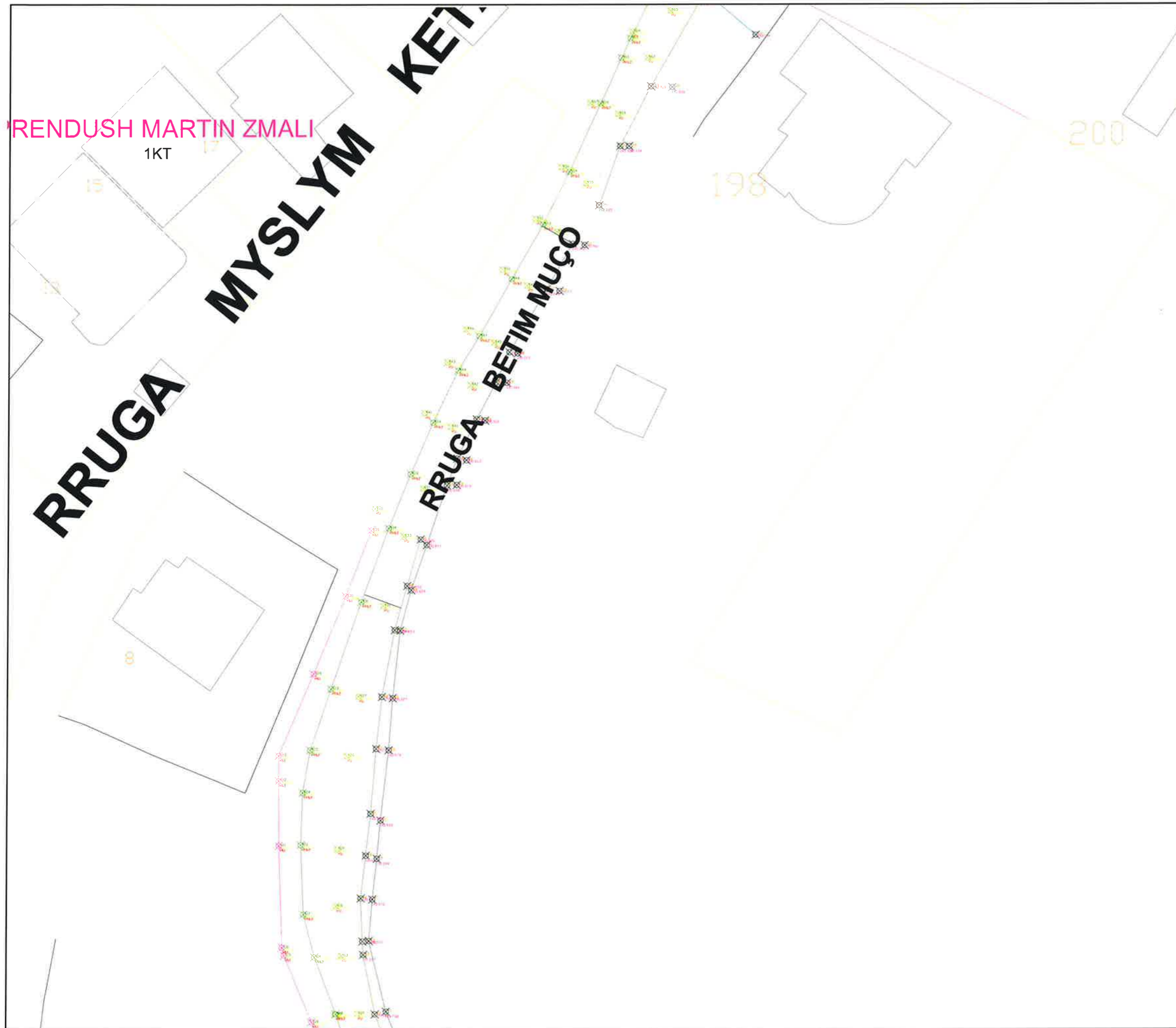

LEGJENDA

-  RRUGE EKZISTUESE
-  OBJEKTE
-  RRETHIME
-  NDARJE PARCELASH

BASHKIA KAMËZ

DREJTORIA E PROJEKTEVE DHE INVESTIMEVE
DEPARTAMENTI I PROJEKTEVE



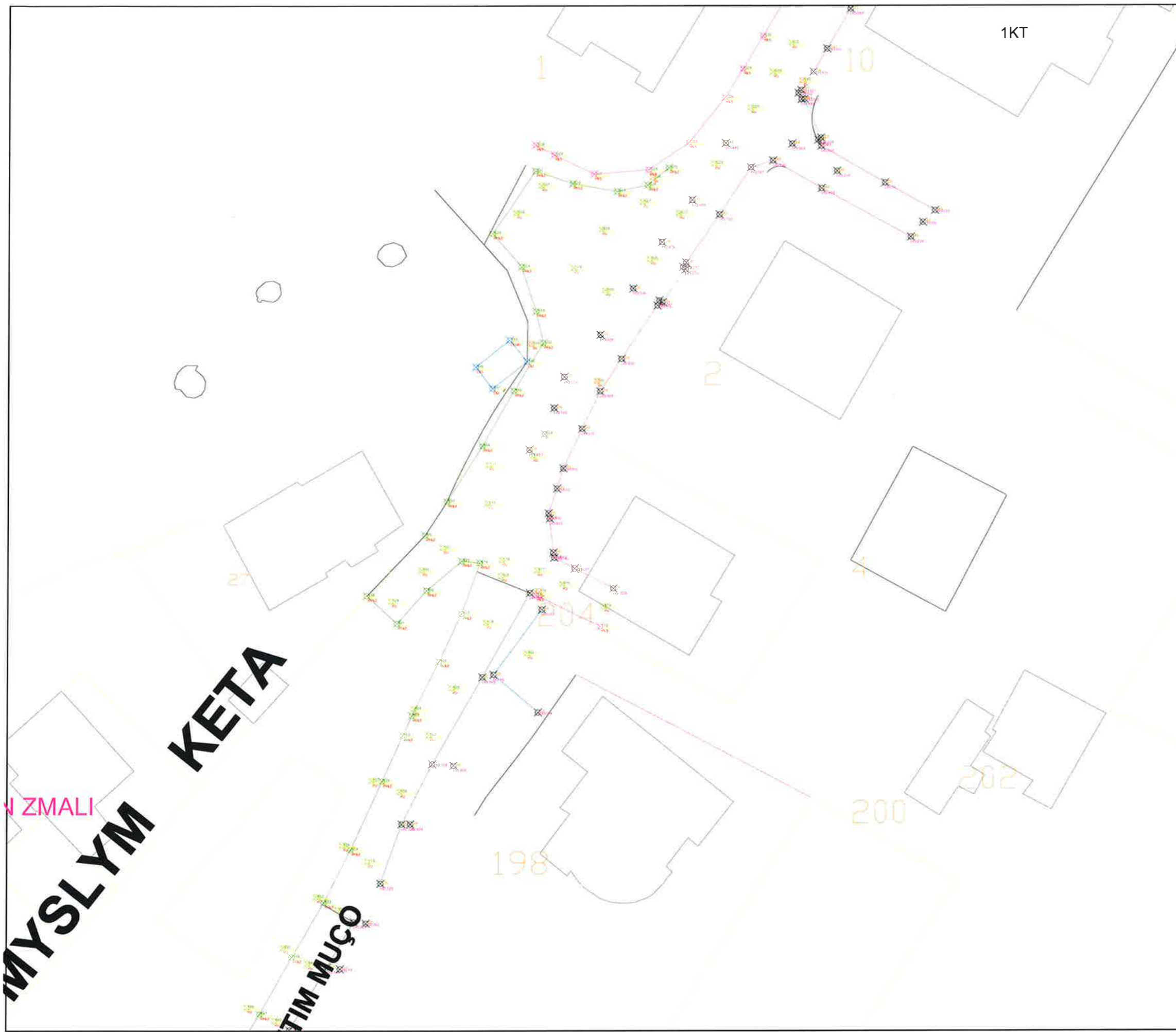

Dr. e Projekteve e Investimeve	FLORA MUCA	
STAFI TEKNIK PROJEKTUES	Ing. ERBLIN LALA	
	Ing. ARJOLA KURTI	
	Ing. DENIS PRENÇI	
	Ing. EGLANTINA DISHA	
	Ing. RAMADAN HYSA	

Titulli i Projektit NDERTIM RRUGA "BETIM MUÇO"	Faza e Projektit PROJEKT ZBATIMI
Emertimi i Fletes PROJEKT ZBATIM	Data e Implementimit:
	Shkalla e Vizatimit
	Fleta Nr. A-03

NDERTIM RRUGA: "BETIM MUÇO"

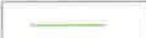

LEGJENDA

-  RRUGE EKZISTUESE
-  OBJEKTE
-  RRETHIME
-  NDARJE PARCELASH

BASHKIA KAMËZ

DREJTORIA E PROJEKTEVE DHE INVESTIMEVE
DEPARTAMENTI I PROJEKTEVE

Dr. e Projekteve e Investimeve	FLORA MUCA	
STAFI TEKNIK	Ing. ERBLIN LALA	
PROJEKTUES	Ing. ARJOLA KURTI	
	Ing. DENIS PRENÇI	
	Ing. EGLANTINA DISHA	
	Ing. RAMADAN HYSA	

Titulli i Projektit
NDERTIM RRUGA "BETIM MUÇO"

Faza e Projektit
PROJEKT ZBATIMI

Emertimi i Fletes
PROJEKT ZBATIM

Data e Implementimit:



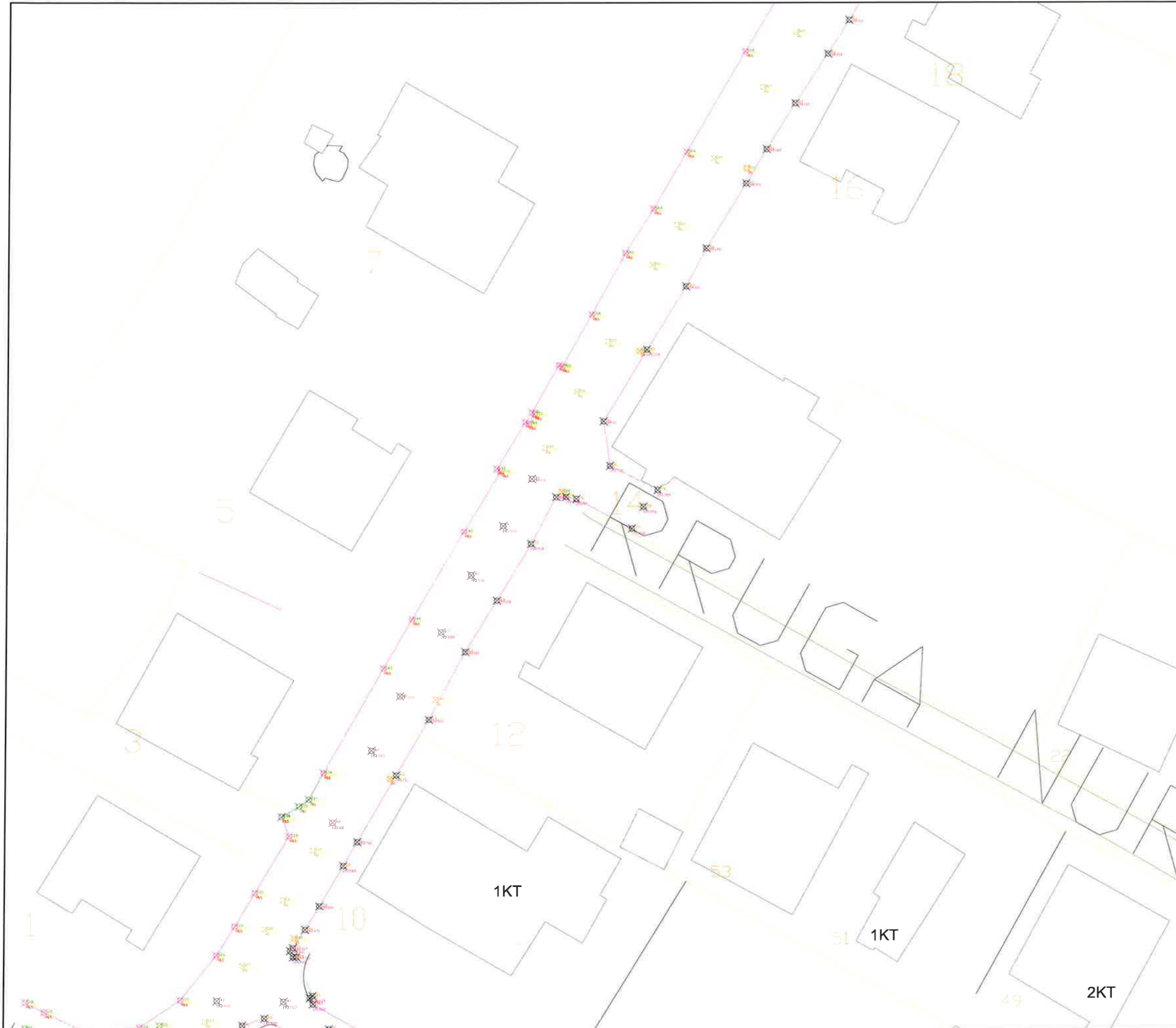

Shkalla e Vizatimit

Fleta Nr.
A-04

NDERTIM RRUGA: "BETIM MUÇO"



LEGJENDA

-  RRUGE EKZISTUESE
-  OBJEKTE
-  RRETHIME
-  NDARJE PARCELASH

BASHKIA KAMËZ

DREJTORIA E PROJEKTEVE DHE INVESTIMEVE
DEPARTAMENTI I PROJEKTEVE



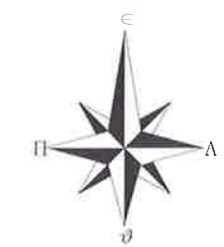
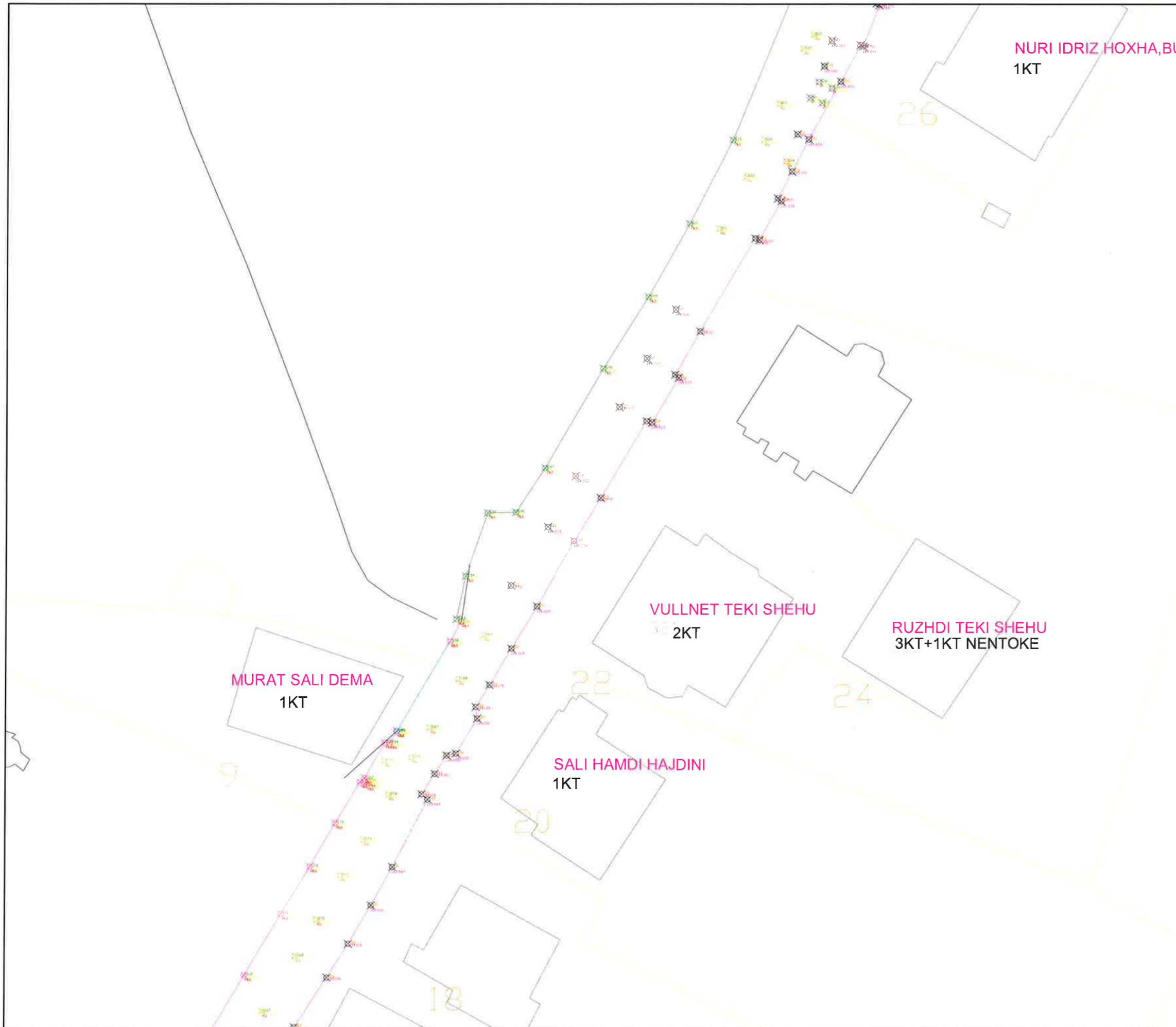

Dr. e Projekteve e Investimeve		FLORA MUCA	
STAFI TEKNIK PROJEKTES	Ing.	ERBLIN LALA	
	Ing.	ARJOLA KURTI	
	Ing.	DENIS PRENÇI	
	Ing.	EGLANTINA DISHA	
	Ing.	RAMADAN HYSA	

Titulli i Projektit NDERTIM RRUGA "BETIM MUÇO"		Faza e Projektit PROJEKT ZBATIMI
Emertimi i Fletes PROJEKT ZBATIM		Data e Implementimit : Shkalla e Vizatimit Fleta Nr. A-05

NDERTIM RRUGA: "BETIM MUÇO"









LEGJENDA

-  RRUGE EKZISTUESE
-  OBJEKTE
-  RRETHIME
-  NDARJE PARCELASH

BASHKIA KAMËZ

DREJTORIA E PROJEKTEVE DHE INVESTIMEVE
DEPARTAMENTI I PROJEKTEVE



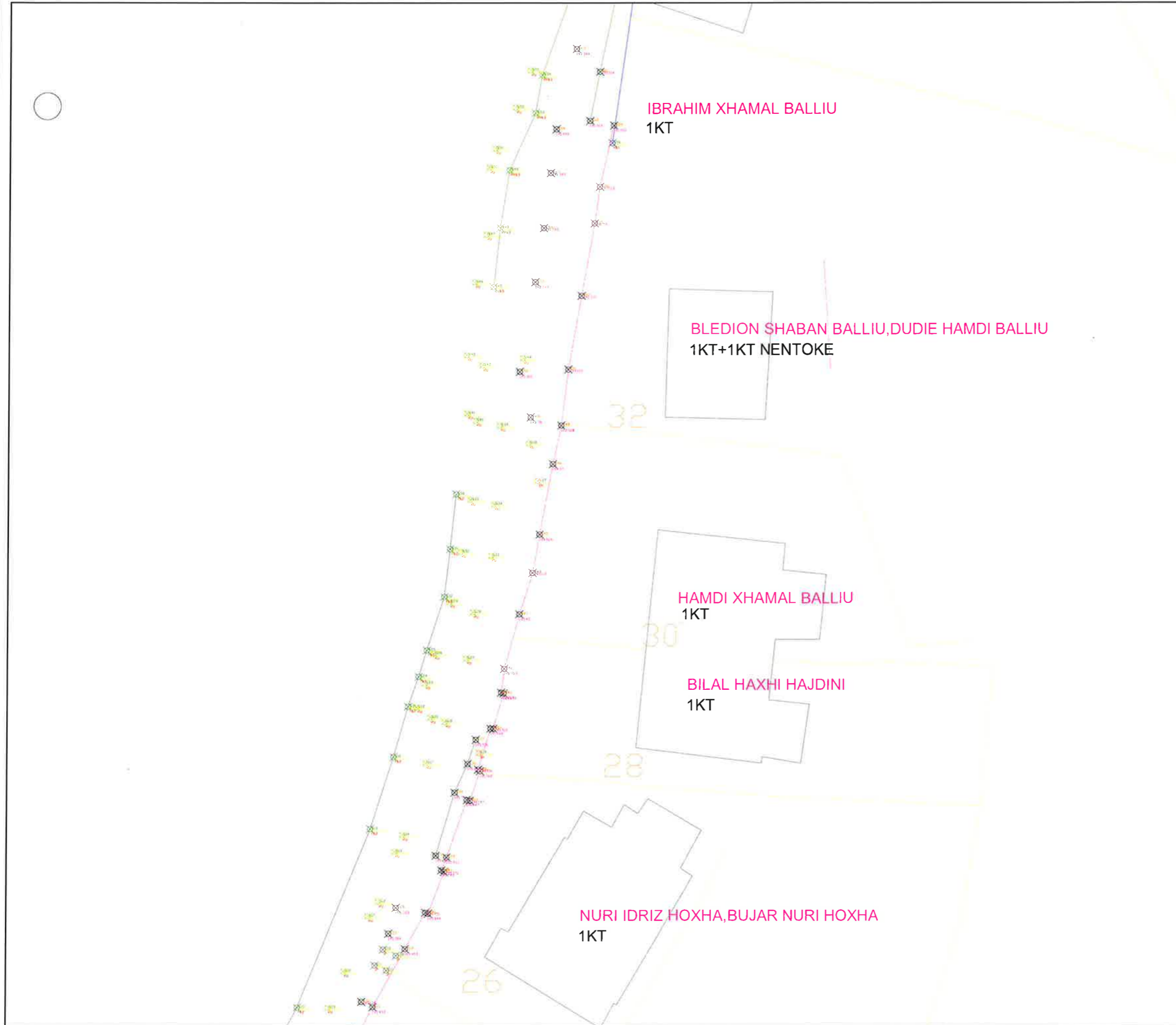

Dr. e Projekteve e Investimeve	FLORA MUCA	
STAFI TEKNIK PROJEKTUES	Ing. ERBLIN LALA	
	Ing. ARJOLA KURTI	
	Ing. DENIS PRENÇI	
	Ing. EGLANTINA DISHA	
	Ing. RAMADAN HYSA	

Titulli i Projektit NDERTIM RRUGA "BETIM MUÇO"	Faza e Projektit PROJEKT ZBATIMI
Emertimi i Fletes PROJEKT ZBATIM	Data e Implementimit :
	Shkalla e Vizatimit
	Fleta Nr. A-06

NDERTIM RRUGA: "BETIM MUÇO"



LEGJENDA

-  RRUGE EKZISTUESE
-  OBJEKTE
-  RRETHIME
-  NDARJE PARCELASH

BASHKIA KAMËZ

DREJTORIA E PROJEKTEVE DHE INVESTIMEVE
DEPARTAMENTI I PROJEKTEVE

Dr. e Projekteve e Investimeve		FLORA MUCA	
STAFI TEKNIK PROJEKTES	Ing.	ERBLIN LALA	
	Ing.	ARJOLA KURTI	
	Ing.	DENIS PRENÇI	
	Ing.	EGLANTINA DISHA	
	Ing.	RAMADAN HYSA	

Titulli i Projektit	Faza e Projektit
NDERTIM RRUGA "BETIM MUÇO"	PROJEKT ZBATIMI
Emertimi i Fletës	Data e Implementimit :
PROJEKT ZBATIM	
	Shkalla e Vizimit
	Fleta Nr.
	A-07

NDERTIM RRUGA: "BETIM MUÇO"





LEGJENDA

-  RRUGE EKZISTUESE
-  OBJEKTE
-  RRETHIME
-  NDARJE PARCELASH

BASHKIA KAMËZ

DREJTORIA E PROJEKTEVE DHE INVESTIMEVE
DEPARTAMENTI I PROJEKTEVE

Dr. e Projekteve e Investimeve		FLORA MUCA	
STAFI TEKNIK PROJEKTUES	Ing.	ERBLIN LALA	
	Ing.	ARJOLA KURTI	
	Ing.	DENIS PRENÇI	
	Ing.	EGLANTINA DISHA	
	Ing.	RAMADAN HYSA	
Titulli i Projektit		Faza e Projektit	
NDERTIM RRUGA "BETIM MUÇO"		PROJEKT ZBATIMI	
Emertimi i Fletës		Data e Implementimit:	
PROJEKT ZBATIM		Shkalla e Vizatimit:	
		Fleta Nr.	
		A-08	

NDERTIM RRUGA: "BETIM MUÇO"



LEGJENDA

-  RRUGE EKZISTUESE
-  OBJEKTE
-  RRETHIME
-  NDARJE PARCELASH

BASHKIA KAMËZ

DREJTORIA E PROJEKTEVE DHE INVESTIMEVE
DEPARTAMENTI I PROJEKTEVE



Dr. e Projekteve e Investimeve		FLORA MUCA	
STAFI TEKNIK PROJEKTUES	Ing.	ERBLIN LALA	
	Ing.	ARJOLA KURTI	
	Ing.	DENIS PRENÇI	
	Ing.	EGLANTINA DISHA	
	Ing.	RAMADAN HYSA	

Titulli i Projektit		Faza e Projektit	
NDERTIM RRUGA "BETIM MUÇO"		PROJEKT ZBATIMI	
Emertimi i Flotes		Data e Implementimit :	
PROJEKT ZBATIM		Shkalla e Vizatimit	
		Flota Nr.	
		A-09	

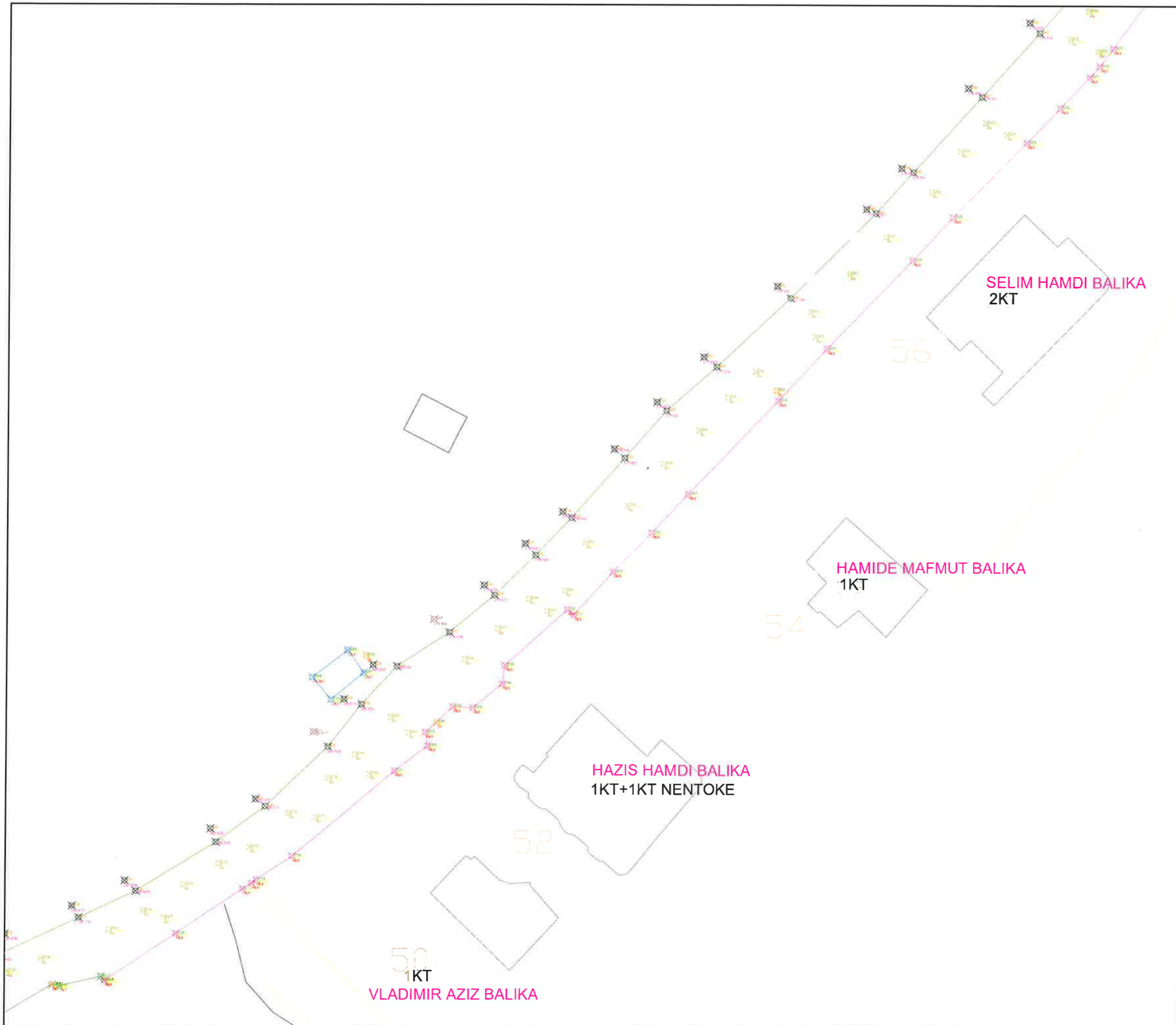
NDERTIM RRUGA: "BETIM MUÇO"

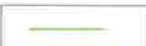

LEGJENDA

-  RRUGE EKZISTUESE
-  OBJEKTE
-  RRETHIME
-  NDARJE PARCELASH

BASHKIA KAMËZ

DREJTORIA E PROJEKTEVE DHE INVESTIMEVE
DEPARTAMENTI I PROJEKTEVE





Dr. e Projekteve e Investimeve		FLORA MUCA	
STAFI TEKNIK PROJEKTUES	Ing.	ERBLIN LALA	
	Ing.	ARJOLA KURTI	
	Ing.	DENIS PRENÇI	
	Ing.	EGLANTINA DISHA	
	Ing.	RAMADAN HYSA	

Titulli i Projektit NDERTIM RRUGA "BETIM MUÇO"	Faza e Projektit PROJEKT ZBATIMI
Emertimi i Flotes PROJEKT ZBATIM	Data e Implementimit:
	Shkalla e Vizatimit
	Fieta Nr. A-10

NDERTIM RRUGA: "BETIM MUÇO"

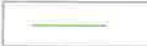

LEGJENDA

-  RRUGE EKZISTUESE
-  OBJEKTE
-  RRETHIME
-  NDARJE PARCELASH

BASHKIA KAMËZ

DREJTORIA E PROJEKTEVE DHE INVESTIMEVE
DEPARTAMENTI I PROJEKTEVE

Dr. e Projekteve e Investimeve		FLORA MUCA	
STAFI TEKNIK PROJEKTUES	Ing.	ERBLIN LALA	
	Ing.	ARJOLA KURTI	
	Ing.	DENIS PRENÇI	
	Ing.	EGLANTINA DISHA	
	Ing.	RAMADAN HYSA	

Titulli i Projektit	Faza e Projektit
NDERTIM RRUGA "BETIM MUÇO"	PROJEKT ZBATIMI
Emertimi i Fietes	Data e Implementimit:
PROJEKT ZBATIM	Shkalla e Vizatimit:
	Fleta Nr.
	A-10

NDERTIM RRUGA: "BETIM MUÇO"



LEGJENDA

 GJURME ASFALTI

 OBJEKTE

 RRETHIME

 NDARJE PARCELASH

 TROTUAR



BASHKIA KAMËZ

DREJTORIA E PROJEKTEVE DHE INVESTIMEVE
DEPARTAMENTI I PROJEKTEVE

Dr. e Projekteve e Investimeve FLORA MUCA

STAFI TEKNIK
PROJEKTUES

- Ing. ERBLIN LALA
- Ing. ARJOLA KURTI
- Ing. DENIS PRENÇI
- Ing. EGLANTINA DISHA
- Ing. RAMADAN HYSA

Titulli i Projektit
NDERTIM RRUGA "BETIM MUÇO"

Emertimi i Fletes
PLANIMETRI ASFALTI

Faza e Projektit
PROJEKT ZBATIMI

Data e Implementimit :

Shkalla e Vizatimit





Fleta Nr.

A-11

NDERTIM RRUGA: "BETIM MUÇO"



LEGJENDA

-  GJURME ASFALTI
-  OBJEKTE
-  RRETHIME
-  NDARJE PARCELASH
-  TROTUAR

BASHKIA KAMËZ
 DREJTORIA E PROJEKTEVE DHE INVESTIMEVE
 DEPARTAMENTI I PROJEKTEVE



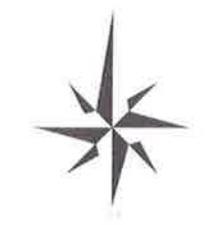
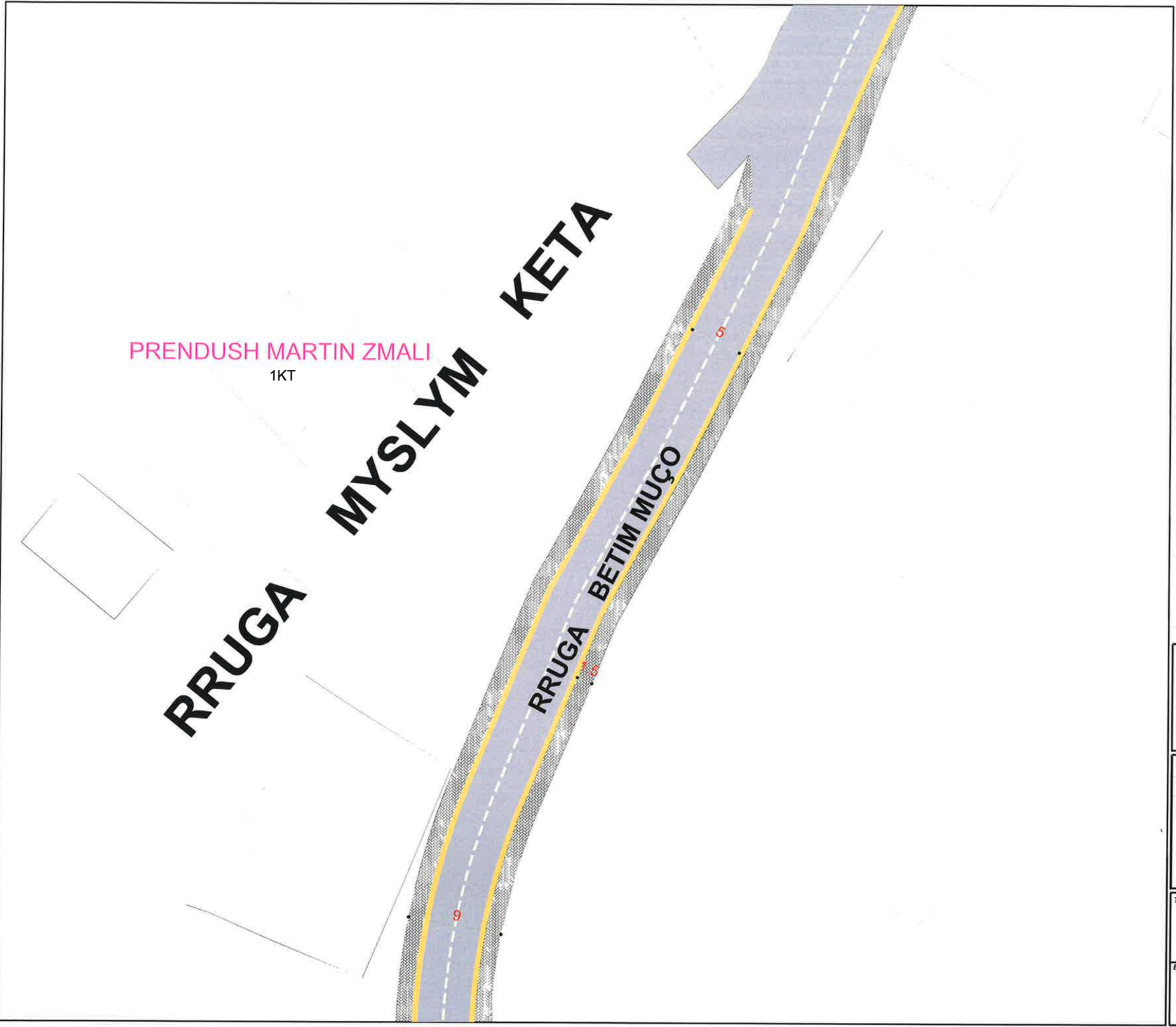

Dr. e Projekteve e Investimeve	FLORA MUCA	<i>[Signature]</i>
STAFI TEKNIK PROJEKTUES	Ing. ERBLIN LALA	<i>[Signature]</i>
	Ing. ARJOLA KURTI	<i>[Signature]</i>
	Ing. DENIS PRENÇI	<i>[Signature]</i>
	Ing. EGLANTINA DISHA	<i>[Signature]</i>
	Ing. RAMADAN HYSA	<i>[Signature]</i>

Titulli i Projektit	NDERTIM RRUGA "BETIM MUÇO"	Faza e Projektit	PROJEKT ZBATIMI
Emertimi i Fletes	PLANIMETRI ASFALTI	Data e Implementimit :	
		Shkalla e Vizatimit	
		Fleta Nr.	A-12

NDERTIM RRUGA: "BETIM MUÇO"



LEGJENDA

-  GJURME ASFALTI
-  OBJEKTE
-  RRETHIME
-  NDARJE PARCELASH
-  TROTUAR

 **BASHKIA KAMËZ**
 DREJTORIA E PROJEKTEVE DHE INVESTIMEVE
 DEPARTAMENTI I PROJEKTEVE





Dr. e Projekteve e Investimeve	FLORA MUCA	
STAFI TEKNIK PROJEKTUES	Ing. ERBLIN LALA	
	Ing. ARJOLA KURTI	
	Ing. DENIS PRENÇI	
	Ing. EGLANTINA DISHA	
	Ing. RAMADAN HYSA	

Titulli i Projektit NDERTIM RRUGA "BETIM MUÇO"	Faza e Projektit PROJEKT ZBATIMI
Emertimi i Fletes PLANIMETRI ASFALTI	Data e Implementimit :
	Shkalla e Vizatimit
	Flota Nr. A-13

NDERTIM RRUGA: "BETIM MUÇO"



LEGJENDA

-  GJURME ASFALTI
-  OBJEKTE
-  RRETHIME
-  NDARJE PARCELASH
-  TROTUAR



BASHKIA KAMËZ

DREJTORIA E PROJEKTEVE DHE INVESTIMEVE
DEPARTAMENTI I PROJEKTEVE

Dr. e Projekteve e Investimeve FLORA MUCA

STAFI TEKNIK
PROJEKTUES

- Ing. ERBLIN LALA
- Ing. ARJOLA KURTI
- Ing. DENIS PRENÇI
- Ing. EGLANTINA DISHA
- Ing. RAMADAN HYSA

Titulli i Projektit
NDERTIM RRUGA "BETIM MUÇO"

Faza e Projektit
PROJEKT ZBATIMI

Emertimi i Fletes

PLANIMETRI ASFALTI

Shkalla e Vizatimit





Fleta Nr.

A-14

NDERTIM RRUGA: "BETIM MUÇO"



LEGJENDA

-  GJURME ASFALTI
-  OBJEKTE
-  RRETHIME
-  NDARJE PARCELASH
-  TROTUAR

 **BASHKIA KAMËZ**
DREJTORIA E PROJEKTEVE DHE INVESTIMEVE
DEPARTAMENTI I PROJEKTEVE



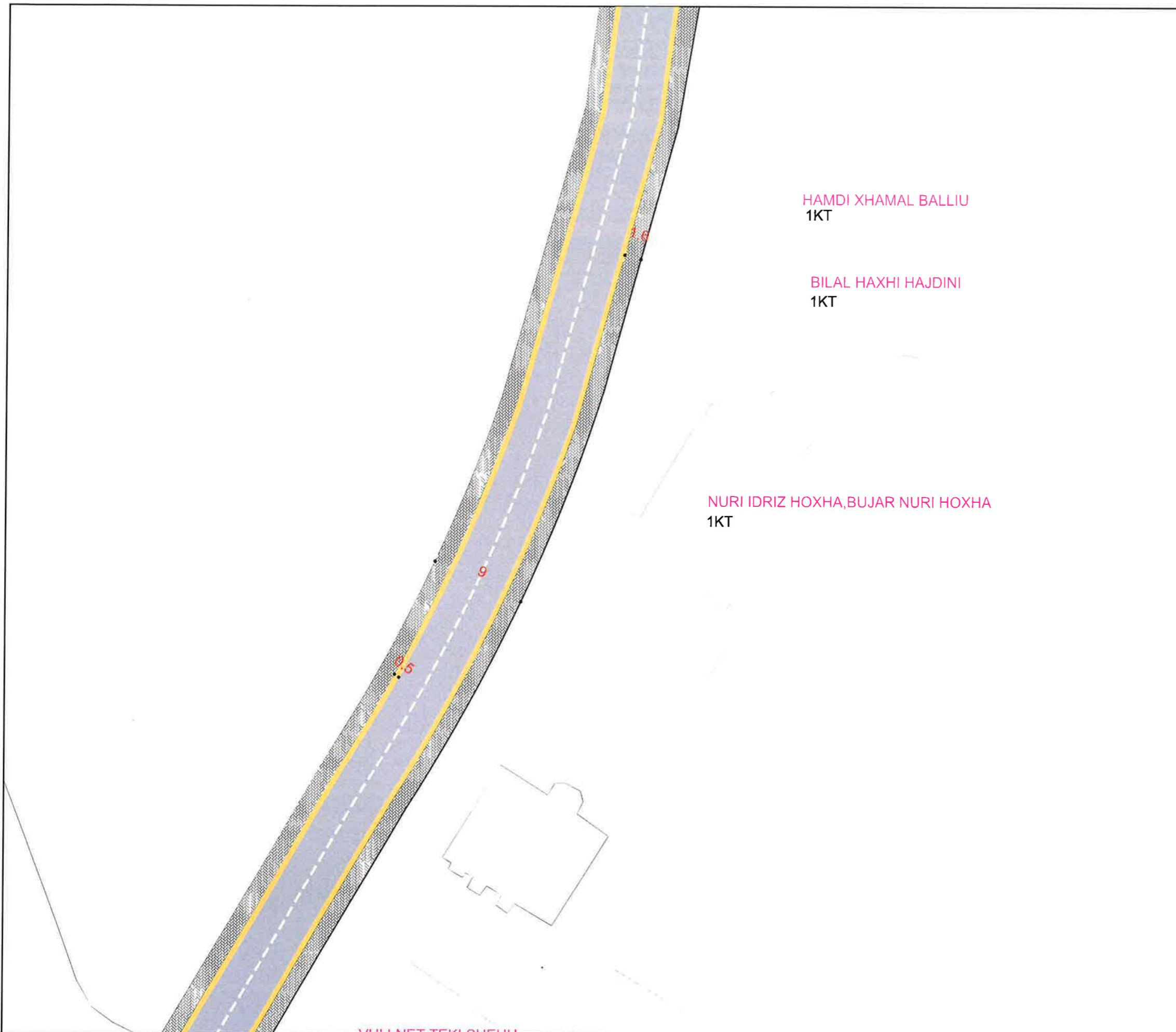

Dr. e Projekteve e Investimeve	FLORA MUCA	
STAFI TEKNIK PROJEKTUES	Ing. ERBLIN LALA	
	Ing. ARJOLA KURTI	
	Ing. DENIS PRENÇI	
	Ing. EGLANTINA DISHA	
	Ing. RAMADAN HYSA	

Titulli i Projektit	NDERTIM RRUGA "BETIM MUÇO"	Faza e Projektit	PROJEKT ZBATIMI
Emertimi i Fletes	PLANIMETRI ASFALTI	Data e Implementimit :	
		Shkalla e Vizatimit	
		Fleta Nr.	A-15

NDERTIM RRUGA: "BETIM MUÇO"



LEGJENDA

-  GJURME ASFALTI
-  OBJEKTE
-  RRETHIME
-  NDARJE PARCELASH
-  TROTUAR

 **BASHKIA KAMËZ**
DREJTORIA E PROJEKTEVE DHE INVESTIMEVE
DEPARTAMENTI I PROJEKTEVE

Dr. e Projekteve e Investimeve	FLORA MUCA	
STAFI TEKNIK PROJEKTUES	Ing. ERBLIN LALA	
	Ing. ARJOLA KURTI	
	Ing. DENIS PRENÇI	
	Ing. EGLANTINA DISHA	
	Ing. RAMADAN HYSA	

Titulli i Projektit NDERTIM RRUGA "BETIM MUÇO"	Faza e Projektit PROJEKT ZBATIMI
Emertimi i Fletes PLANIMETRI ASFALTI	Data e Implementimit :
	Shkalla e Vizatimit
	Fleta Nr. A-16

NDERTIM RRUGA: "BETIM MUÇO"



BESIM ZYBER ELEZAJ
1KT+1KT NENTOKE

YMER ZYBER ELEZI
1KT





SABRI ZYBER ELEZI
1KT

IBRAHIM XHAMAL BALLIU
1KT

BLEDION SHABAN BALLIU, DUDIE HAMDİ BALLIU
1KT+1KT NENTOKE



LEGJENDA

-  GJURME ASFALTI
-  OBJEKTE
-  RRETHIME
-  NDARJE PARCELASH
-  TROTUAR



BASHKIA KAMËZ

DREJTORIA E PROJEKTEVE DHE INVESTIMEVE
DEPARTAMENTI I PROJEKTEVE

Dr. e Projekteve e Investimeve FLORA MUCA

STAFI TEKNIK
PROJEKTUES

- Ing. ERBLIN LALA
- Ing. ARJOLA KURTI
- Ing. DENIS PRENÇI
- Ing. EGLANTINA DISHA
- Ing. RAMADAN HYSA

Titulli i Projektit
NDERTIM RRUGA "BETIM MUÇO"

Emertimi i Fletes
PLANIMETRI ASFALTI

Faza e Projektit
PROJEKT ZBATIMI

Data e Implementimit :

Shkalla e Vizimit

Fleta Nr.

A-17

NDERTIM RRUGA: "BETIM MUÇO"



LEGJENDA

-  GJURME ASFALTI
-  OBJEKTE
-  RRETHIME
-  NDARJE PARCELASH
-  TROTUAR



BASHKIA KAMËZ

DREJTORIA E PROJEKTEVE DHE INVESTIMEVE
DEPARTAMENTI I PROJEKTEVE



Dr. e Projekteve e Investimeve	FLORA MUCA	
STAFI TEKNIK PROJEKTUES	Ing. ERBLIN LALA Ing. ARJOLA KURTI Ing. DENIS PRENÇI Ing. EGLANTINA DISHA Ing. RAMADAN HYSA	  

Titulli i Projektit	Faza e Projektit
NDERTIM RRUGA "BETIM MUÇO"	PROJEKT ZBATIMI
Emertimi i Fletes	Data e Implementimit:
PLANIMETRI ASFALTI	Shkalla e Vizatimit
	Fleta Nr.
	A-18

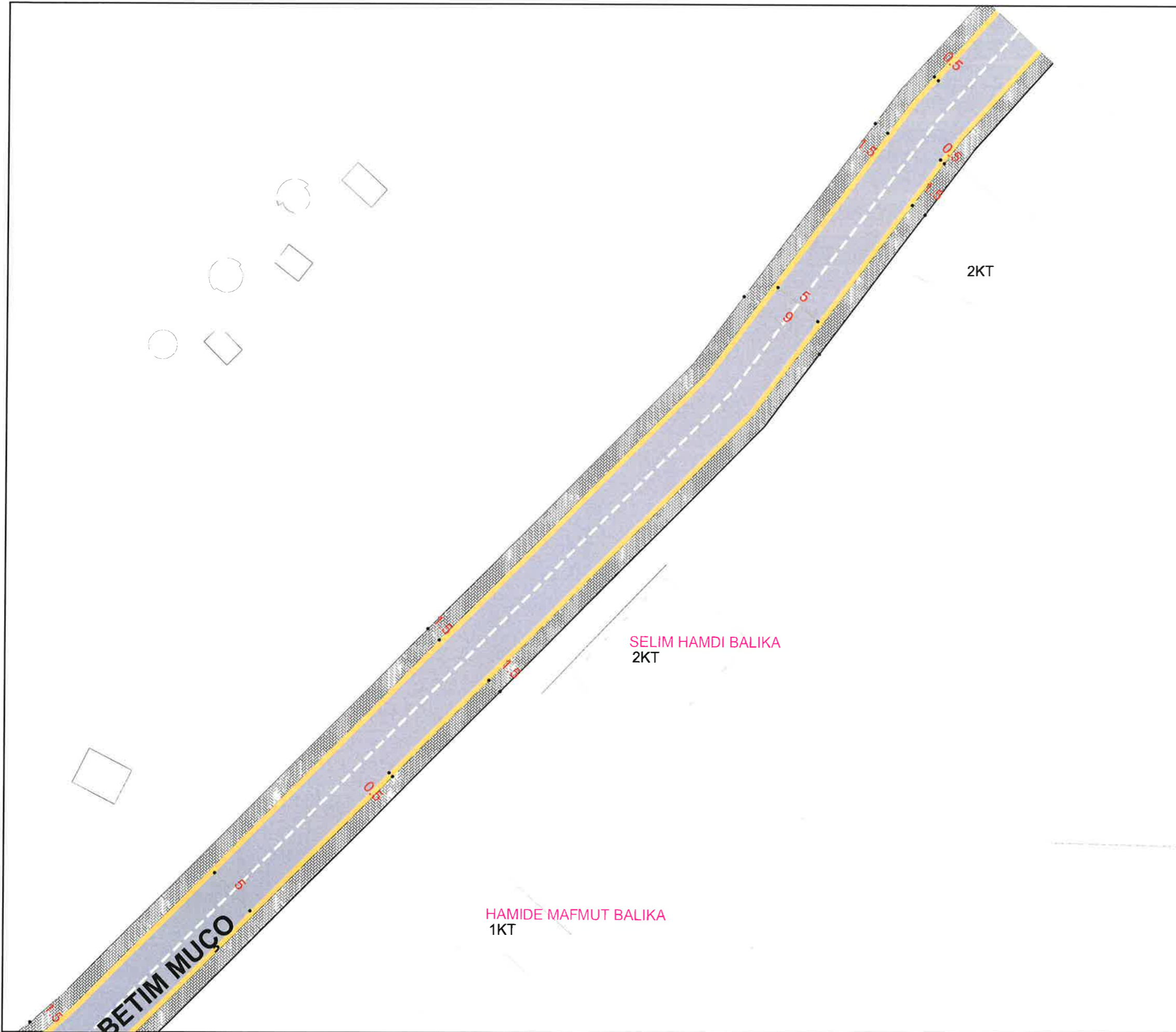
NDERTIM RRUGA: "BETIM MUÇO"



LEGJENDA

-  GJURME ASFALTI
-  OBJEKTE
-  RRETHIME
-  NDARJE PARCELASH
-  TROTUAR



BASHKIA KAMËZ

DREJTORIA E PROJEKTEVE DHE INVESTIMEVE
DEPARTAMENTI I PROJEKTEVE

Dr. e Projekteve e Investimeve FLORA MUCA

STAFI TEKNIK
PROJEKTUES

- Ing. ERBLIN LALA
- Ing. ARJOLA KURTI
- Ing. DENIS PRENÇI
- Ing. EGLANTINA DISHA
- Ing. RAMADAN HYSA

Titulli i Projektit
NDERTIM RRUGA "BETIM MUÇO"

Emertimi i Fletes
PLANIMETRI ASFALTI

Faza e Projektit
PROJEKT ZBATIMI

Data e implementimit :

Shkalla e Vizatimit

Fleta Nr.

A-19

NDERTIM RRUGA: "BETIM MUÇO"



LEGJENDA

Puseta K.U.SH

Tub HDPE Dn315 per K.U.SH



BASHKIA KAMËZ

DREJTORIA E PROJEKTEVE DHE INVESTIMEVE
DEPARTAMENTI I PROJEKTEVE

Dr. e Projekteve e Investimeve FLORA MUÇA

STAFI TEKNIK
PROJEKTUES

- Ing. ERBLIN LALA
- Ing. ARJOLA KURTI
- Ing. DENIS PRENÇI
- Ing. EGLANTINA DISHA
- Ing. RAMADAN HYSA

Titulli i Projektit

NDERTIM RRUGA "BETIM MUÇO"

Emertimi i Fletes

PLANIMETRI KUB

Faza e Projektit

PROJEKT ZBATIMI

Data e Implementimit :

Shkalla e Vizatimit

Fleta Nr.

A-20

NDERTIM RRUGA: "BETIM MUÇO"

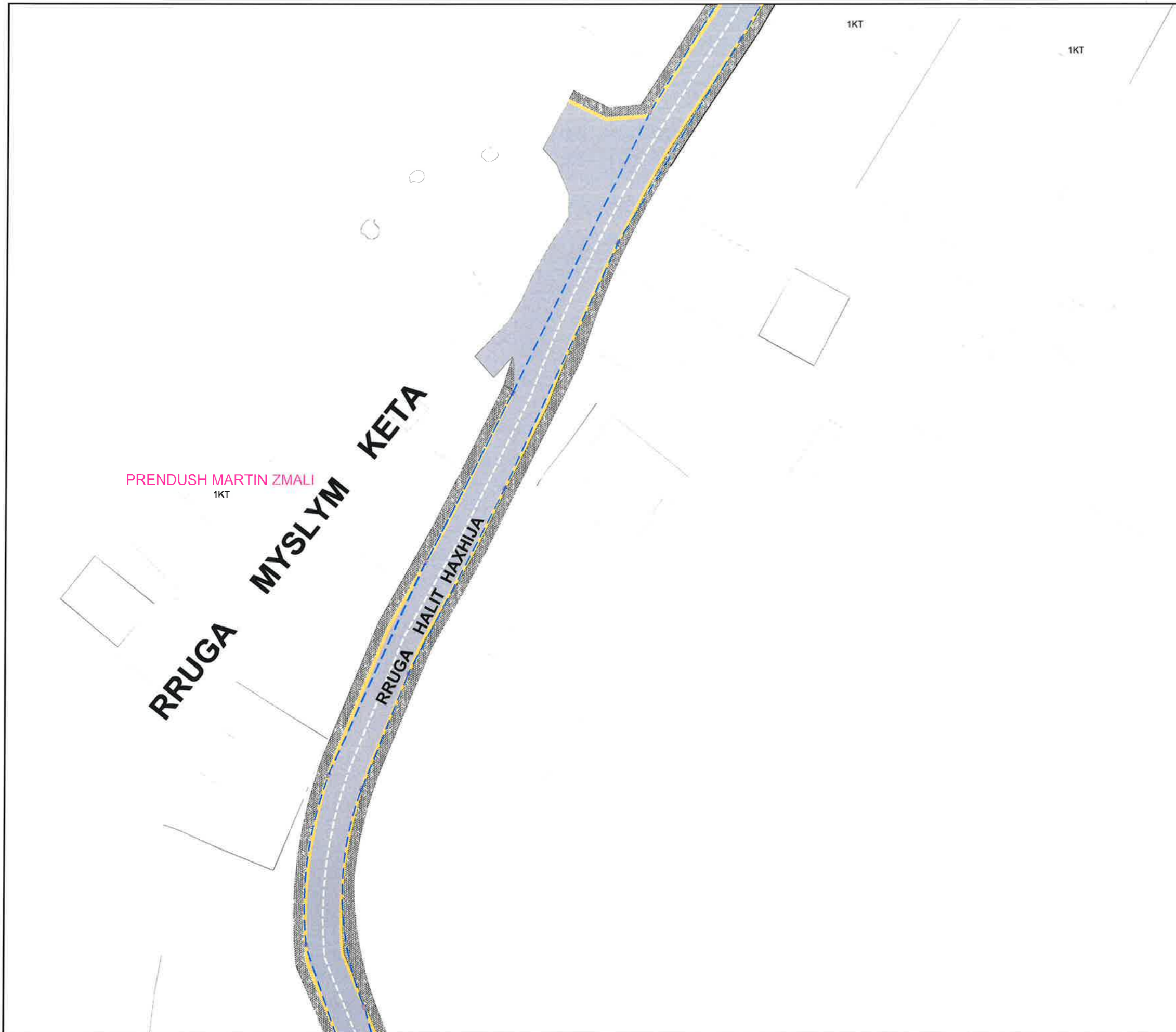

LEGJENDA

Puseta K.U.SH

Tub HDPE Dn315 per K.U.SH



BASHKIA KAMËZ

DREJTORIA E PROJEKTEVE DHE INVESTIMEVE
DEPARTAMENTI I PROJEKTEVE

Dr. e Projekteve e Investimeve FLORA MUÇA

STAFI TEKNIK
PROJEKTUES

- Ing. ERBLIN LALA
- Ing. ARJOLA KURTI
- Ing. DENIS PRENÇI
- Ing. EGLANTINA DISHA
- Ing. RAMADAN HYSA

Titulli i Projektit

NDERTIM RRUGA "BETIM MUÇO"

Emertimi i Fletes

PLANIMETRI KUB

Faza e Projektit

PROJEKT ZBATIMI

Data e Implementimit :

Shkalla e Vizatimit



Fleta Nr.

A-21

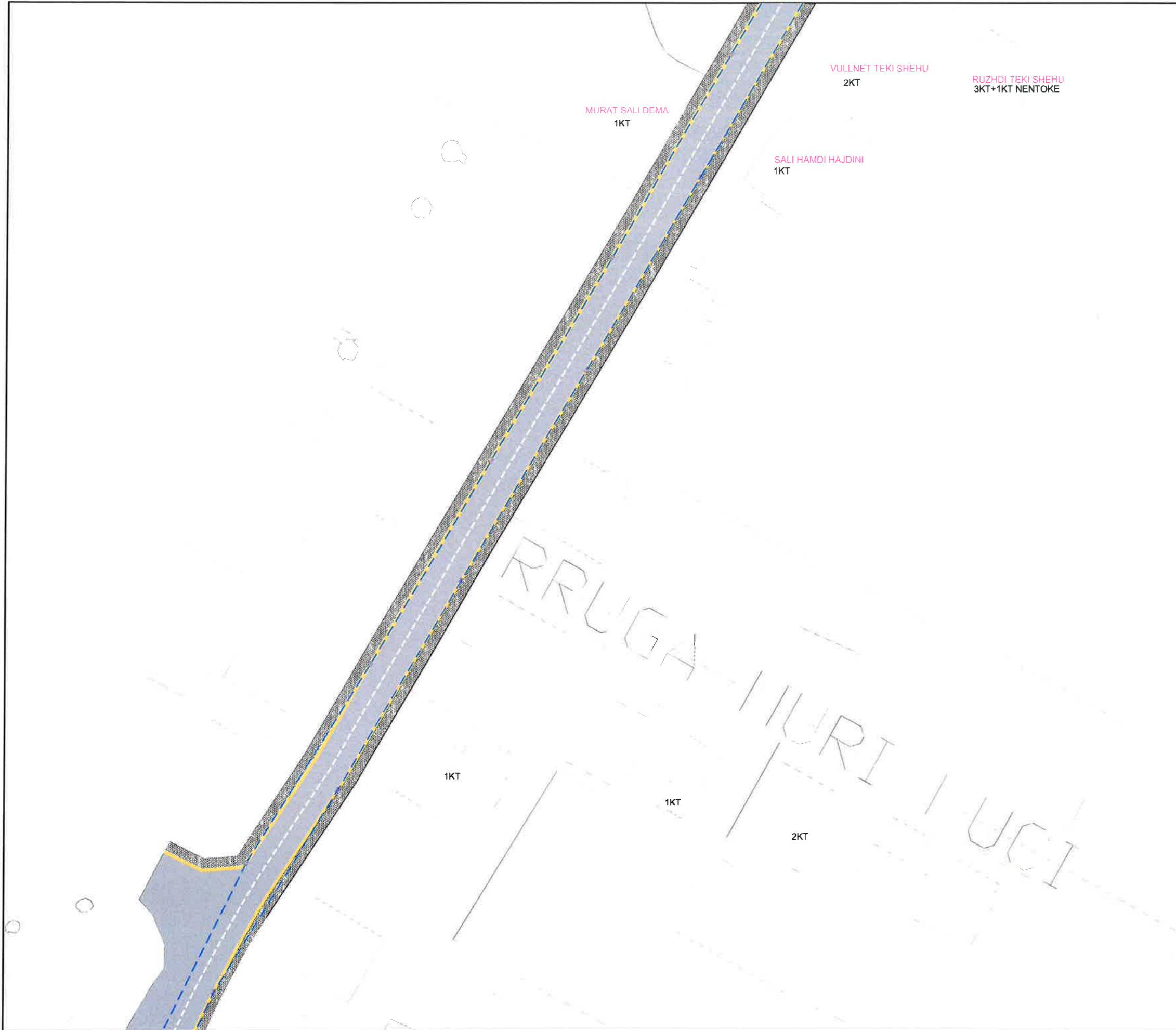
NDERTIM RRUGA: "BETIM MUÇO"



LEGJENDA

-  Puseta K.U.SH
-  Tub HDPE Dn315 per K.U.SH

 **BASHKIA KAMËZ**
DREJTORIA E PROJEKTEVE DHE INVESTIMEVE
DEPARTAMENTI I PROJEKTEVE

Dr. e Projekteve e Investimeve		FLORA MUÇA	
STAFI TEKNIK PROJEKTUES	Ing.	ERBLIN LALA	
	Ing.	ARJOLA KURTI	
	Ing.	DENIS PRENÇI	
	Ing.	EGLANTINA DISHA	
	Ing.	RAMADAN HYSA	

Titulli i Projektit	Faza e Projektit
NDERTIM RRUGA "BETIM MUÇO"	PROJEKT ZBATIMI
Emertimi i Fletes	Data e Implementimit:
PLANIMETRI KUB	
	Shkalla e Vizatimit
	Fieta Nr.
	A-22

NDERTIM RRUGA: "BETIM MUÇO"

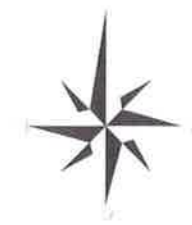
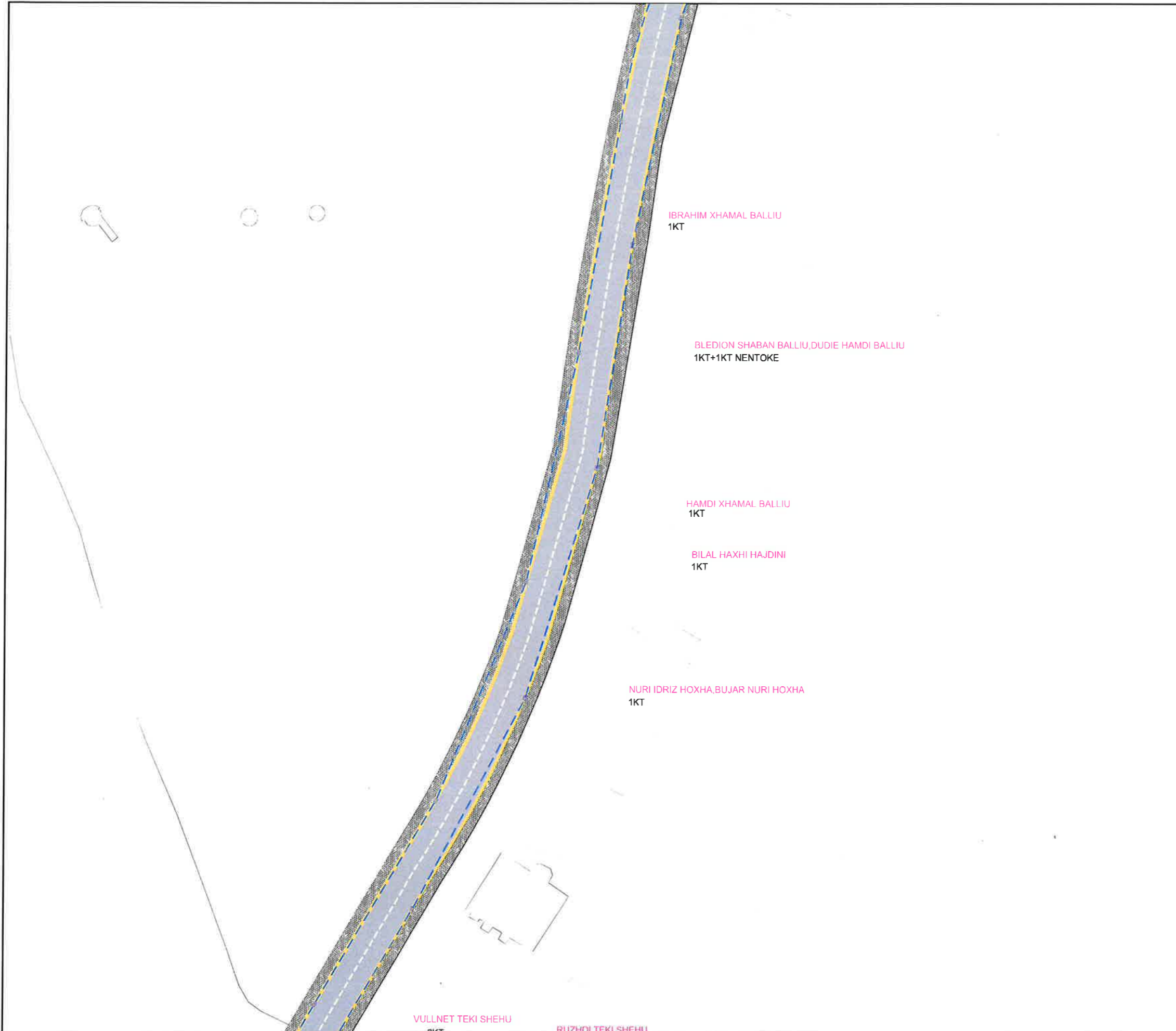

LEGJENDA

Puseta K.U.SH

 Tub HDPE Dn315 per K.U.SH



BASHKIA KAMËZ

DREJTORIA E PROJEKTEVE DHE INVESTIMEVE
DEPARTAMENTI I PROJEKTEVE

Dr. e Projekteve e Investimeve		FLORA MUCA	
STAFI TEKNIK PROJEKTUES	Ing.	ERBLIN LALA	
	Ing.	ARJOLA KURTI	
	Ing.	DENIS PRENÇI	
	Ing.	EGLANTINA DISHA	
	Ing.	RAMADAN HYSA	

Titulli i Projektit
NDERTIM RRUGA "BETIM MUÇO"

Emertimi i Fletes
PLANIMETRI KUB

Faza e Projektit
PROJEKT ZBATIMI

Data e Implementimit :

Shkalla e Vizatimit

Fleta Nr.
A-23

NDERTIM RRUGA: "BETIM MUÇO"

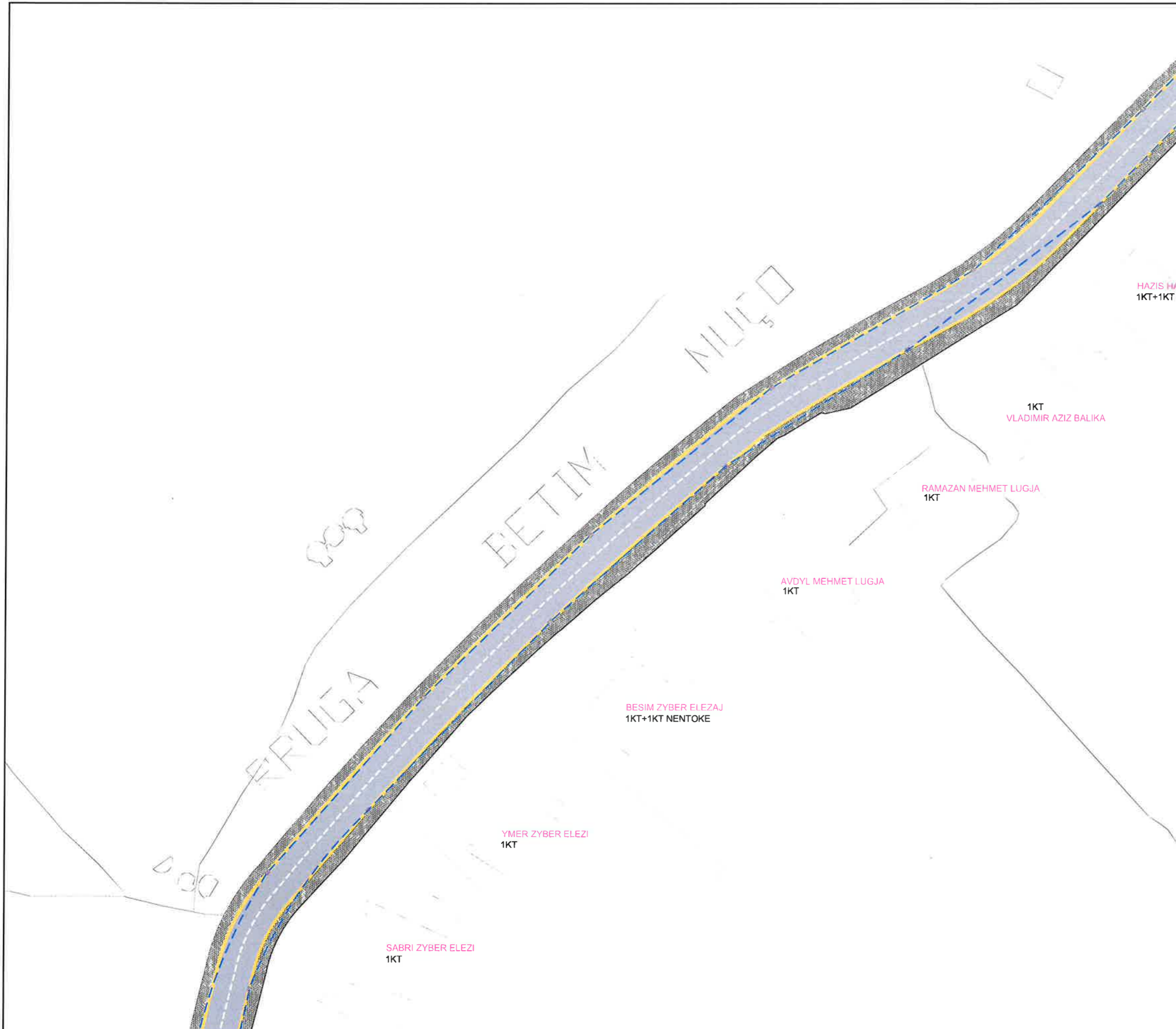

LEGJENDA

Puseta K.U.SH

 Tub HDPE Dn315 per K.U.SH



BASHKIA KAMËZ

DREJTORIA E PROJEKTEVE DHE INVESTIMEVE
DEPARTAMENTI I PROJEKTEVE

Dr. e Projekteve e Investimeve FLORA MUCA

STAFI TEKNIK
PROJEKTUES

- Ing. ERBLIN LALA
- Ing. ARJOLA KURTI
- Ing. DENIS PRENÇI
- Ing. EGLANTINA DISHA
- Ing. RAMADAN HYSA

Titulli i Projektit

NDERTIM RRUGA "BETIM MUÇO"

Emertimi i Fletes

PLANIMETRI KUB

Faza e Projektit

PROJEKT ZBATIMI

Data e Implementimit :

Shkalla e Vizatimit



Fleta Nr.

A-24

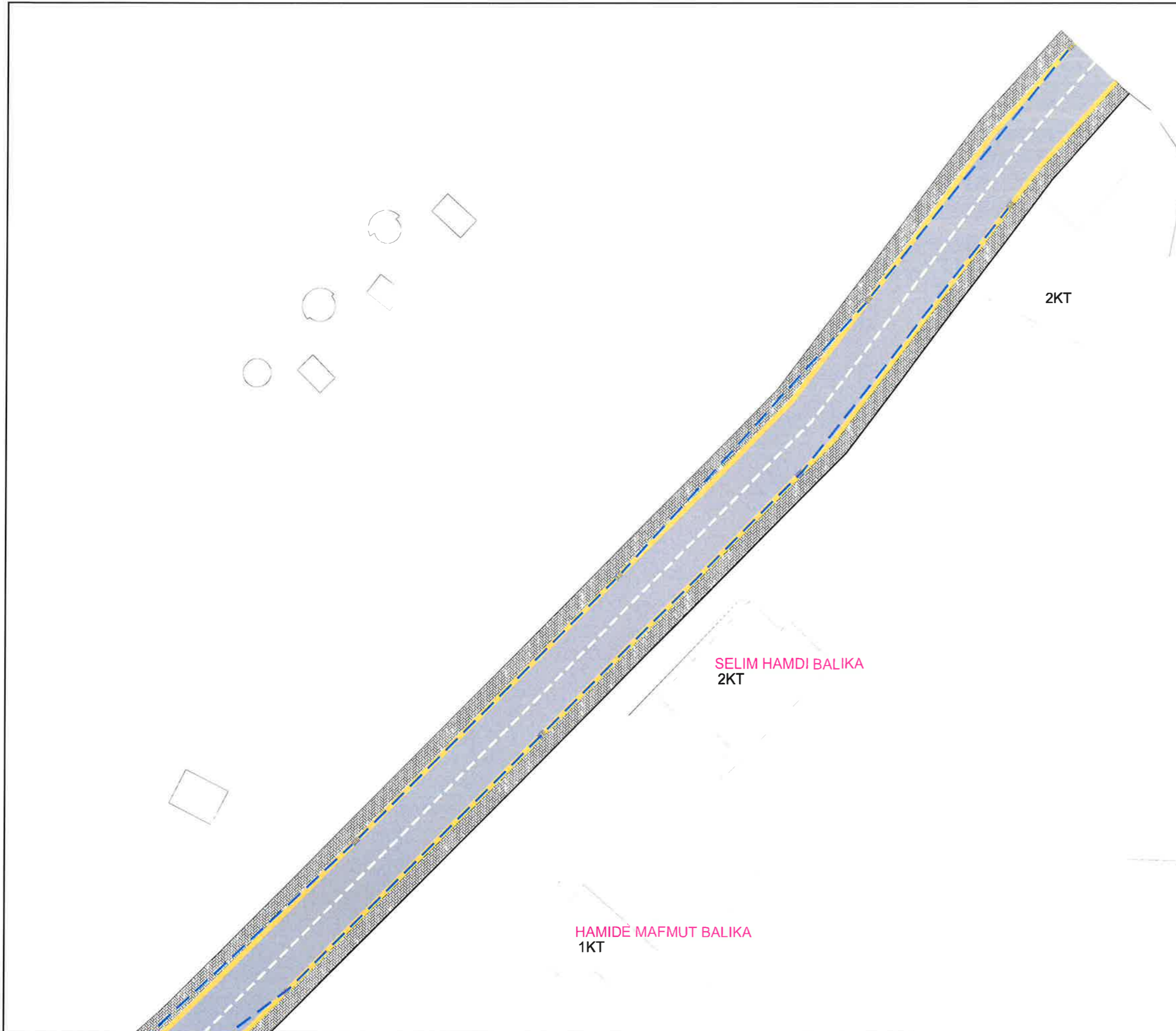
NDERTIM RRUGA: "BETIM MUÇO"



LEGJENDA

-  Puseta K.U.SH
-  Tub HDPE Dn315 per K.U.SH

 **BASHKIA KAMËZ**
DREJTORIA E PROJEKTEVE DHE INVESTIMEVE
DEPARTAMENTI I PROJEKTEVE

Dr. e Projekteve e Investimeve		FLORA MUCA	
STAFI TEKNIK PROJEKTES	Ing.	ERBLIN LALA	
	Ing.	ARJOLA KURTI	
	Ing.	DENIS PRENÇI	
	Ing.	EGLANTINA DISHA	
	Ing.	RAMADAN HYSA	

Titulli i Projektit	Faza e Projektit
NDERTIM RRUGA "BETIM MUÇO"	PROJEKT ZBATIMI
Emertimi i Fletes	Data e Implementimit :
PLANIMETRI KUB	
	Shkalla e Vizatimit
	Fleta Nr.
	A-25

NDERTIM RRUGA: "BETIM MUÇO" DETAJE K.U.B

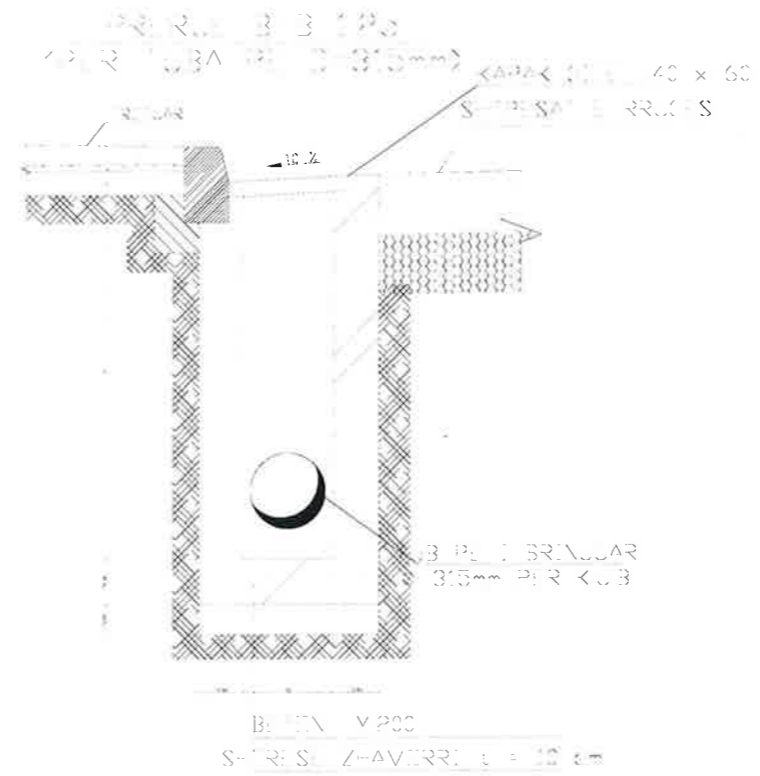
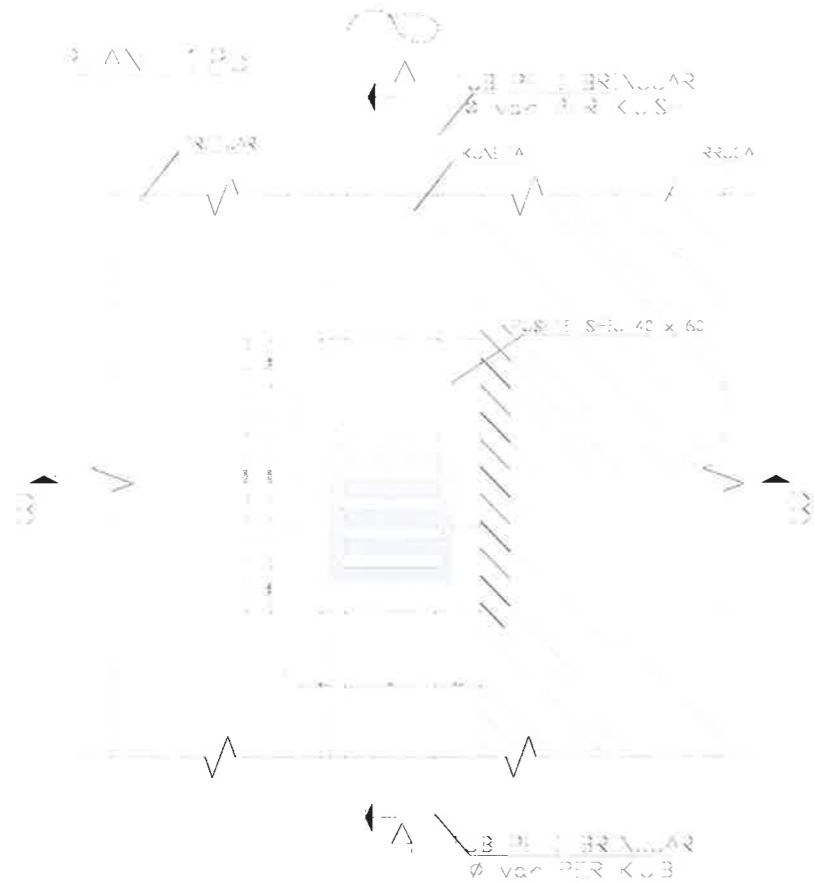

LEGJENDA

Puseta K.U.SH

Tub HDPE Dn315 per K.U.SH

PRERJE A-A 1:25

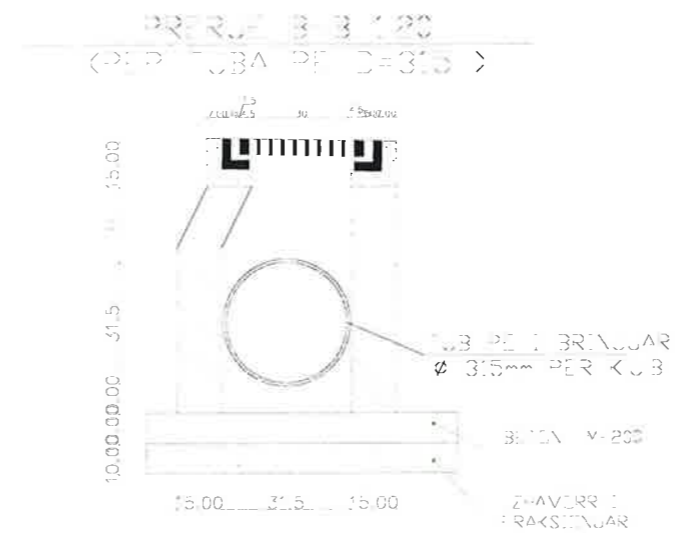
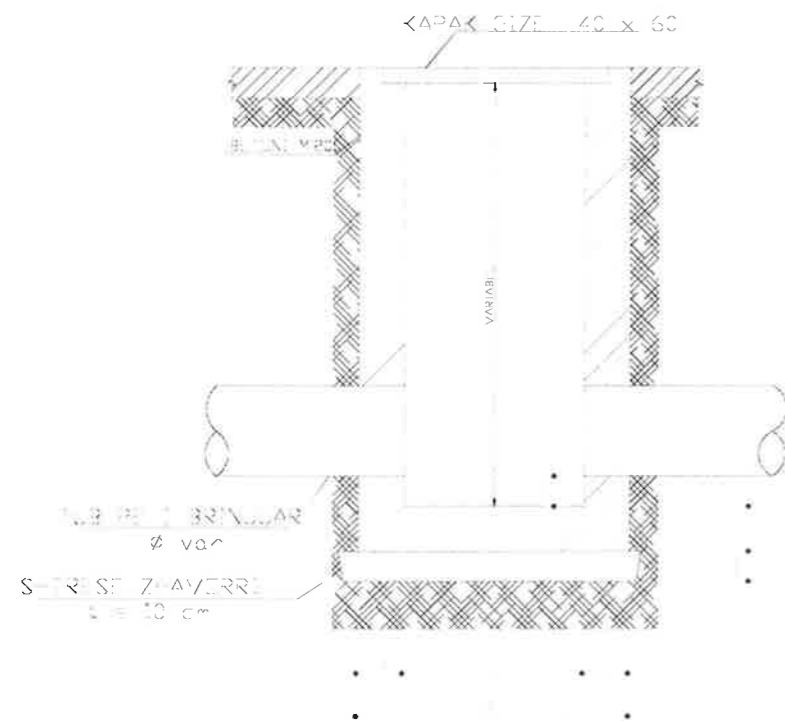

BASHKIA KAMËZ

DREJTORIA E PROJEKTEVE DHE INVESTIMEVE
DEPARTAMENTI I PROJEKTEVE

Dr. e Projekteve e Investimeve FLORA MUCA

STAFI TEKNIK
PROJEKTUES

- Ing. ERBLIN LALA
- Ing. ARJOLA KURTI
- Ing. DENIS PRENÇI
- Ing. EGLANTINA DISHA
- Ing. RAMADAN HYSA

Titulli i Projektit

NDERTIM RRUGA "BETIM MUÇO"

Emertimi i Fletes

DETAJE KUB

Faza e Projektit

PROJEKT ZBATIMI

Data e Implementimit :

Shkalla e Vizatimit

Fleta Nr.

A-26

NDERTIM RRUGA: "BETIM MUÇO"



LEGJENDA

Puseta K.U.N

 Tub HDPE Dn315 per K.U.N



BASHKIA KAMËZ

DREJTORIA E PROJEKTEVE DHE INVESTIMEVE
DEPARTAMENTI I PROJEKTEVE

Dr. e Projekteve e Investimeve FLORA MUCA

STAFI TEKNIK
PROJEKTUES

- Ing. ERBLIN LALA
- Ing. ARJOLA KURTI
- Ing. DENIS PRENÇI
- Ing. EGLANTINA DISHA
- Ing. RAMADAN HYSA

Titulli i Projektit

NDERTIM RRUGA "BETIM MUÇO"

Emertimi i Fletes

PLANIMETRI KUN

Faza e Projektit

PROJEKT ZBATIMI

Data e Implementimit :

Shkalla e Vizatimit

Fleta Nr.

A-27

NDERTIM RRUGA: "BETIM MUÇO"



LEGJENDA

Puseta K.U.N

 Tub HDPE Dn315 per K.U.N



BASHKIA KAMËZ

DREJTORIA E PROJEKTEVE DHE INVESTIMEVE
DEPARTAMENTI I PROJEKTEVE

Dr. e Projekteve e Investimeve FLORA MUCA

STAFI TEKNIK
PROJEKTUES

- Ing. ERBLIN LALA
- Ing. ARJOLA KURTI
- Ing. DENIS PRENÇI
- Ing. EGLANTINA DISHA
- Ing. RAMADAN HYSA

Titulli i Projektit

NDERTIM RRUGA "BETIM MUÇO"

Emertimi i Fletes

PLANIMETRI KUN

Faza e Projektit

PROJEKT ZBATIMI

Data e Implementimit :

Shkalla e Vizatimit

Fleta Nr.

A-28

NDERTIM RRUGA: "BETIM MUÇO"



LEGJENDA

Puseta K.U.N

 Tub HDPE Dn315 per K.U.N



BASHKIA KAMËZ

DREJTORIA E PROJEKTEVE DHE INVESTIMEVE
DEPARTAMENTI I PROJEKTEVE

Dr. e Projekteve e Investimeve FLORA MUCA

STAFI TEKNIK
PROJEKTUES

- Ing. ERBLIN LALA
- Ing. ARJOLA KURTI
- Ing. DENIS PRENÇI
- Ing. EGLANTINA DISHA
- Ing. RAMADAN HYSA

Titulli i Projektit

NDERTIM RRUGA "BETIM MUÇO"

Emertimi i Fletes

PLANIMETRI KUN

Faza e Projektit

PROJEKT ZBATIMI

Data e Implementimit:

Shkalla e Vizatimit



Fleta Nr.

A-29

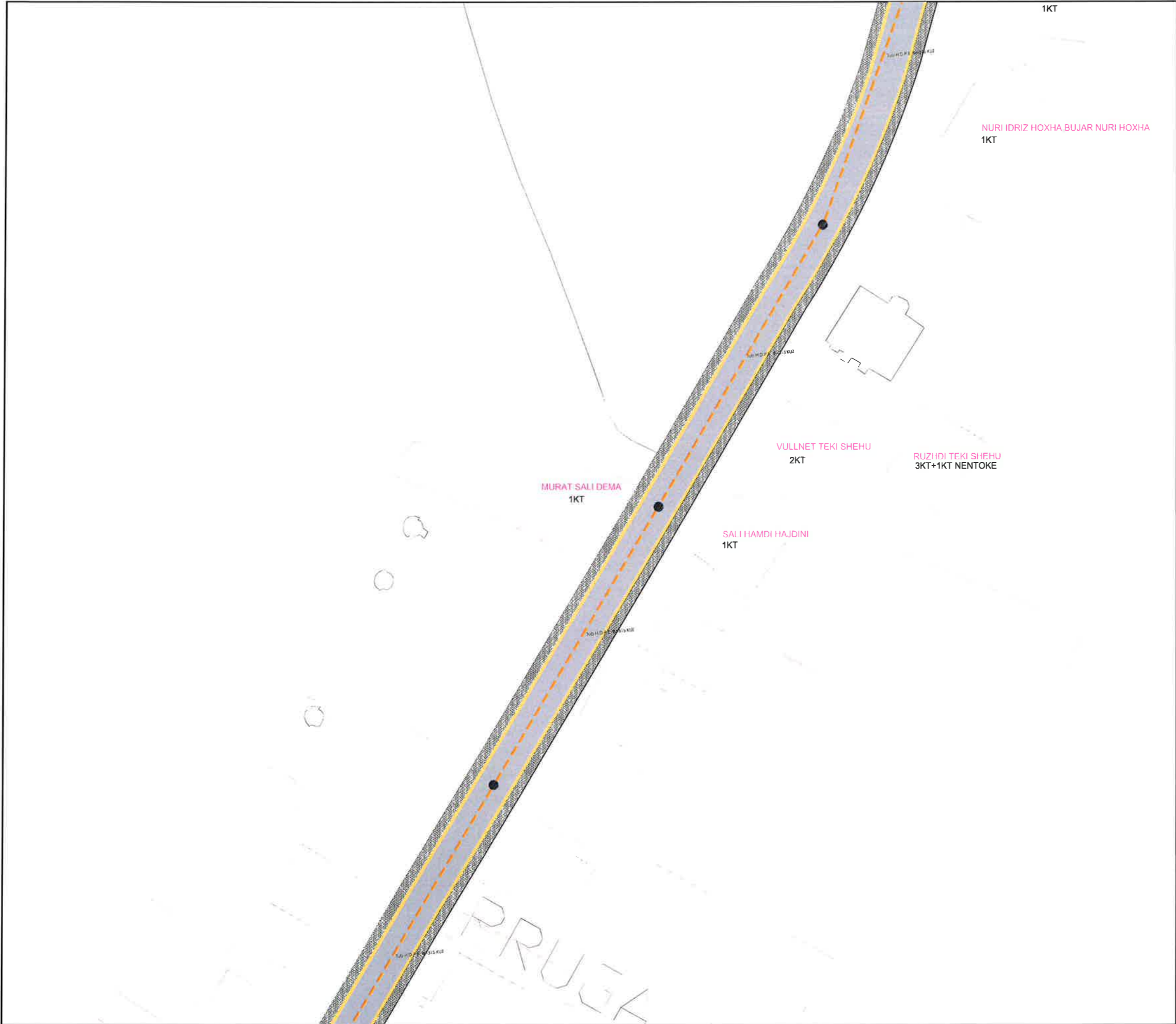
NDERTIM RRUGA: "BETIM MUÇO"



LEGJENDA

-  Puseta K.U.N
-  Tub HDPE Dn315 per K.U.N

 **BASHKIA KAMËZ**
DREJTORIA E PROJEKTEVE DHE INVESTIMEVE
DEPARTAMENTI I PROJEKTEVE

Dr. e Projekteve e Investimeve	FLORA MUCA
STAFI TEKNIK PROJEKTUES	Ing. ERBLIN LALA
	Ing. ARJOLA KURTI
	Ing. DENIS PRENÇI
	Ing. EGLANTINA DISHA
	Ing. RAMADAN HYSA

Titulli i Projektit	Faza e Projektit
NDERTIM RRUGA "BETIM MUÇO"	PROJEKT ZBATIMI
Emertimi i Fletes	Data e Implementimit:
PLANIMETRI KUN	Shkalla e Vizatimit
	Fleta Nr.
	A-30

NDERTIM RRUGA: "BETIM MUÇO"



LEGJENDA

Puseta K.U.N

 Tub HDPE Dn315 per K.U.N



BASHKIA KAMËZ

DREJTORIA E PROJEKTEVE DHE INVESTIMEVE
DEPARTAMENTI I PROJEKTEVE

Dr. e Projekteve e Investimeve FLORA MUCA

STAFI TEKNIK
PROJEKTUES

- Ing. ERBLIN LALA
- Ing. ARJOLA KURTI
- Ing. DENIS PRENÇI
- Ing. EGLANTINA DISHA
- Ing. RAMADAN HYSA

Titulli i Projektit

NDERTIM RRUGA "BETIM MUÇO"

Emertimi i Fletes

PLANIMETRI KUN

Faza e Projektit

PROJEKT ZBATIMI

Data e Implementimit :

Shkalla e Vizatimit



Fleta Nr.

A-31

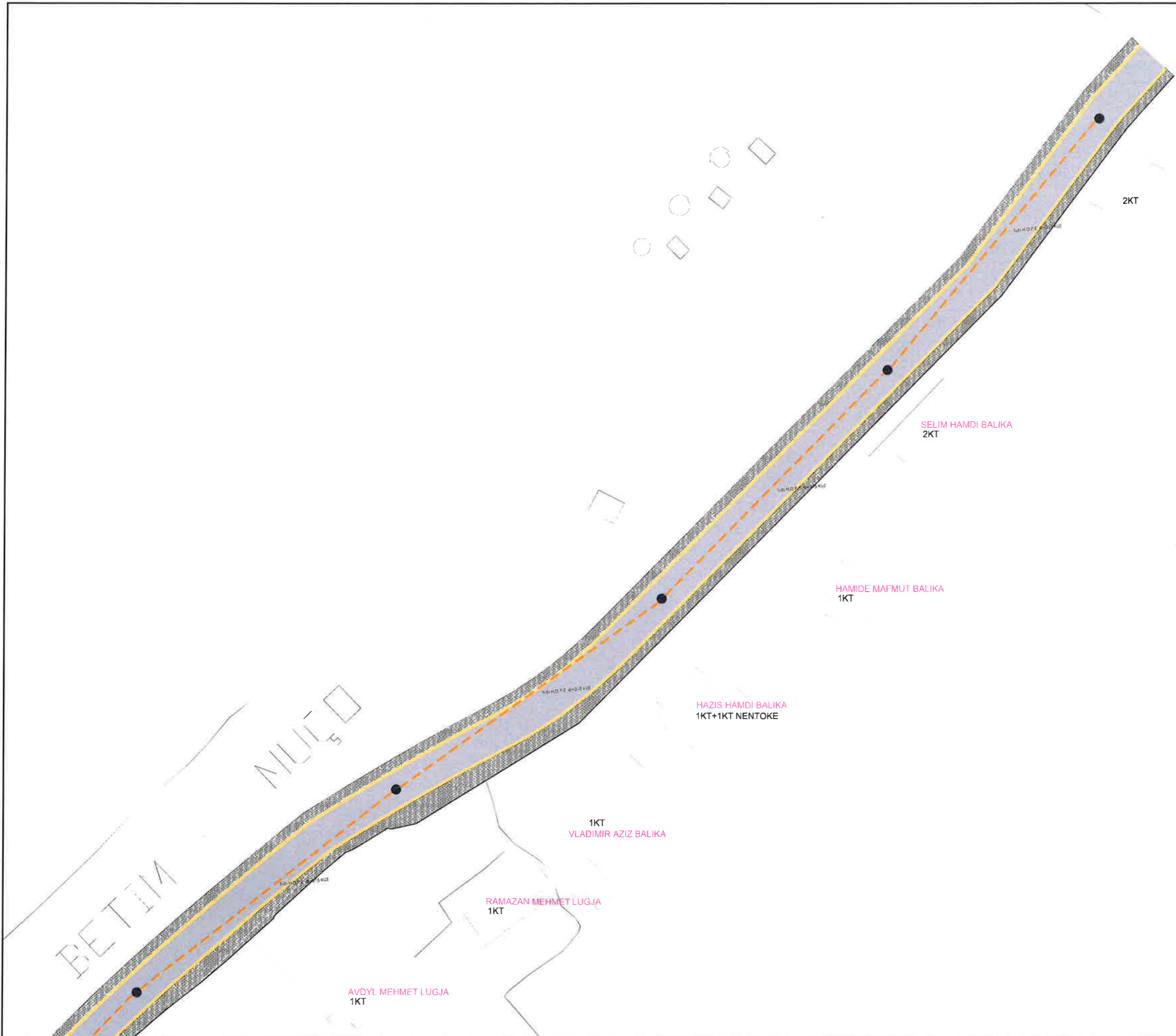
NDERTIM RRUGA: "BETIM MUÇO"



LEGJENDA

-  Puseta K.U.N
-  Tub HDPE Dn315 per K.U.N

 **BASHKIA KAMËZ**
DREJTORIA E PROJEKTEVE DHE INVESTIMEVE
DEPARTAMENTI I PROJEKTEVE

Dr. e Projekteve e Investimeve	FLORA MUCA
STAFI TEKNIK PROJEKTUES	Ing. ERBLIN LALA
	Ing. ARJOLA KURTI
	Ing. DENIS PRENÇI
	Ing. EGLANTINA DISHA
	Ing. RAMADAN HYSA

Titulli i Projektit	Faza e Projektit
NDERTIM RRUGA "BETIM MUÇO"	PROJEKT ZBATIMI
Emertimi i Fletes	Data e Implementimit :
PLANIMETRI KUN	Shkalla e Vizatimit
	Fleta Nr.
	A-32

NDERTIM RRUGA: "BETIM MUÇO"

PUSETE TIP D=100cm

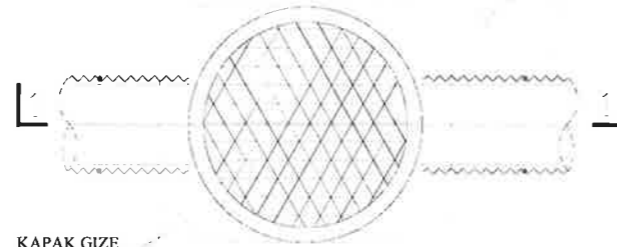

KAPAK GIZE

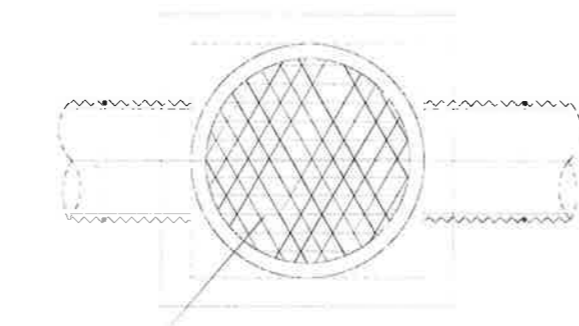

KAPAK GIZE

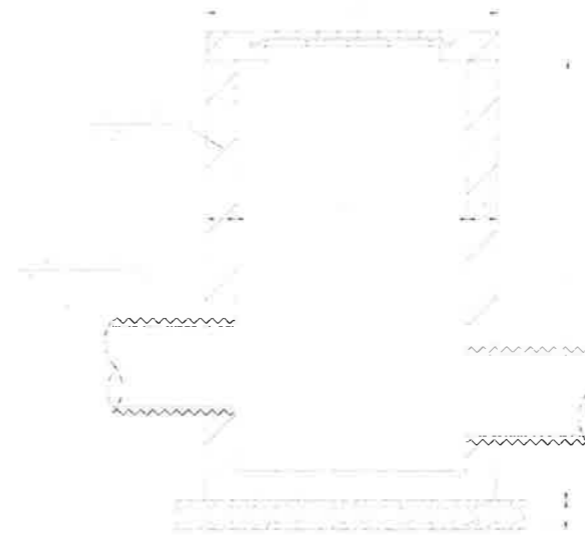

LEGJENDA

Puseta K.U.N

 Tub HDPE Dn315 per K.U.N



BASHKIA KAMËZ

DREJTORIA E PROJEKTEVE DHE INVESTIMEVE
DEPARTAMENTI I PROJEKTEVE

Dr. e Projekteve e Investimeve FLORA MUCA

STAFI TEKNIK
PROJEKTUES
Ing. ERBLIN LALA
Ing. ARJOLA KURTI
Ing. DENIS PRENÇI
Ing. EGLANTINA DISHA
Ing. RAMADAN HYSA

Titulli i Projektit

NDERTIM RRUGA "BETIM MUÇO"

Emertimi i Fletes

PLANIMETRI KUN

Faza e Projektit

PROJEKT ZBATIMI

Data e Implementimit:

Shkalla e Vizatimit

Fleta Nr.

A-33

NDERTIM RRUGA: "BETIM MUÇO"

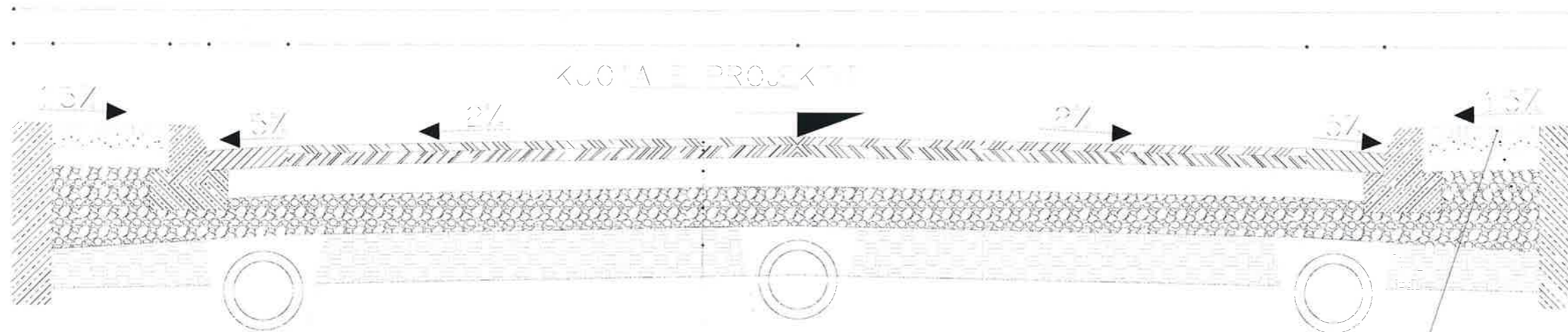

TUB I BRINJEZUAR Ø 350
PER K.U.B

TUB BETONI Ø315mm
MBUSHJE ME ÇAKULL t=15cm

TUB I BRINJEZUAR Ø 350
PER K.U.B

SHTRESE PLLAKE BETONI t = 6cm
MBUSHJE ME STABILIZANT t = 15 cm
MBUSHJE ME ÇAKULL t=20cm

ASFALTOBETON 4 cm
BINDER 6 cm
SHTRESE STABILIZANTI 1 x 15
SHTRESE ÇAKULLI t=20cm
TOKE NATYRALE



BASHKIA KAMËZ

DREJTORIA E PROJEKTEVE DHE INVESTIMEVE
DEPARTAMENTI I PROJEKTEVE

Dr. e Projekteve e Investimeve FLORA MUCA

STAFI TEKNIK
PROJEKTUES

- Ing. ERBLIN LALA
- Ing. ARJOLA KURTI
- Ing. DENIS PRENÇI
- Ing. EGLANTINA DISHA
- Ing. RAMADAN HYSA

Titulli i Projektit

NDERTIM RRUGA "BETIM MUÇO"

Emertimi i Fletes

PROFILI TIP

Faza e Projektit

PROJEKT ZBATIMI

Data e Implementimit:

Shkalla e Vizatimit

Fleta Nr.

A-34

NDERTIM RRUGA: "BETIM MUÇO"

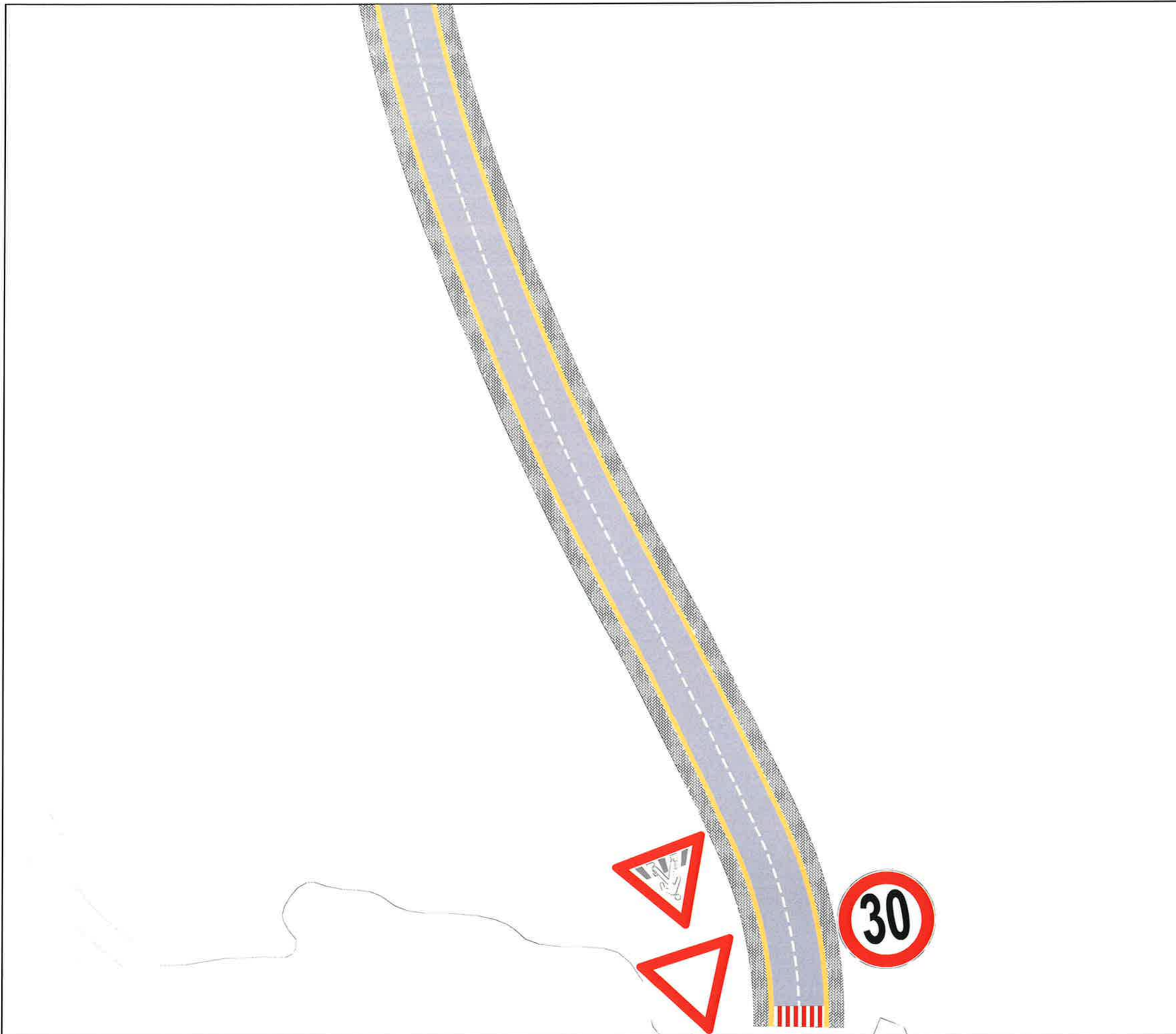

LEGJENDA



BASHKIA KAMËZ

DREJTORIA E PROJEKTEVE DHE INVESTIMEVE
DEPARTAMENTI I PROJEKTEVE

Dr. e Projekteve e Investimeve FLORA MUCA

- STAFI TEKNIK
PROJEKTUES
- Ing. ERBLIN LALA
 - Ing. ARJOLA KURTI
 - Ing. DENIS PRENÇI
 - Ing. EGLANTINA DISHA
 - Ing. RAMADAN HYSA

Titulli i Projektit
NDERTIM RRUGA "BETIM MUÇO"

Emertimi i Fletes
PLANIMETRI ASFALTI

Faza e Projektit
PROJEKT ZBATIMI

Data e Implementimit :

Shkalla e Vizatimit

Fleta Nr.

A-34

NDERTIM RRUGA: "BETIM MUÇO"



LEGJENDA



BASHKIA KAMËZ

DREJTORIA E PROJEKTEVE DHE INVESTIMEVE
DEPARTAMENTI I PROJEKTEVE

Dr. e Projekteve e Investimeve **FLORA MUCA**

STAFI TEKNIK
PROJEKTUES

- Ing. ERBLIN LALA
- Ing. ARJOLA KURTI
- Ing. DENIS PRENÇI
- Ing. EGLANTINA DISHA
- Ing. RAMADAN HYSA

Titulli i Projektit
NDERTIM RRUGA "BETIM MUÇO"

Faza e Projektit
PROJEKT ZBATIMI

Emertimi i Fletes
PLANIMETRI ASFALTI

Fieta Nr.
A-35

NDERTIM RRUGA: "BETIM MUÇO"

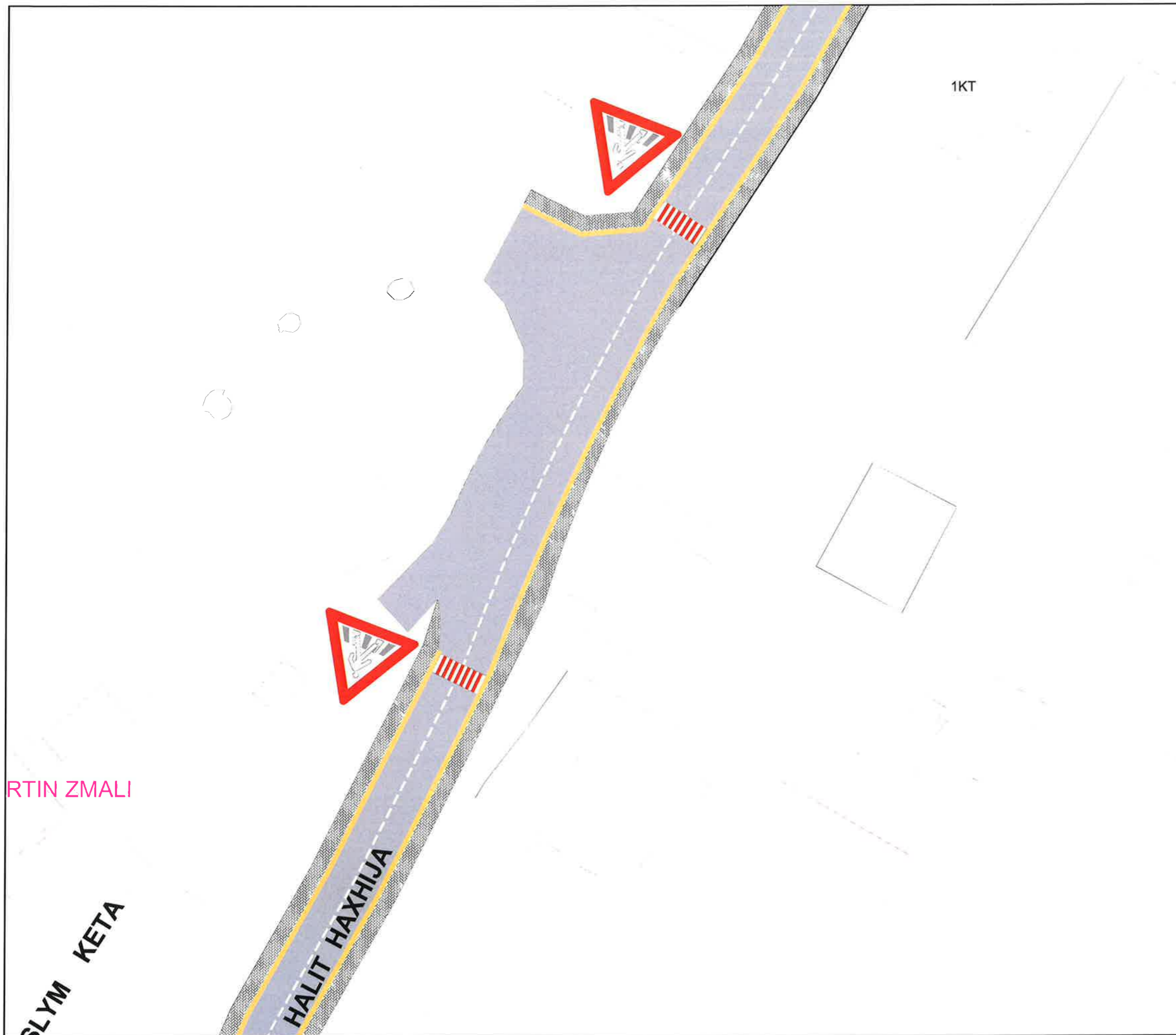

LEGJENDA



BASHKIA KAMËZ

DREJTORIA E PROJEKTEVE DHE INVESTIMEVE
DEPARTAMENTI I PROJEKTEVE

Dr. e Projekteve e Investimeve FLORA MUCA

STAFI TEKNIK
PROJEKTUES

- Ing. ERBLIN LALA
- Ing. ARJOLA KURTI
- Ing. DENIS PRENÇI
- Ing. EGLANTINA DISHA
- Ing. RAMADAN HYSA

Titulli i Projektit
NDERTIM RRUGA "BETIM MUÇO"

Emertimi i Fletes
PLANIMETRI ASFALTI

Faza e Projektit
PROJEKT ZBATIMI

Data e Implementimit:

Shkalla e Vizatimit

Fleta Nr.

A-36

NDERTIM RRUGA: "BETIM MUÇO"

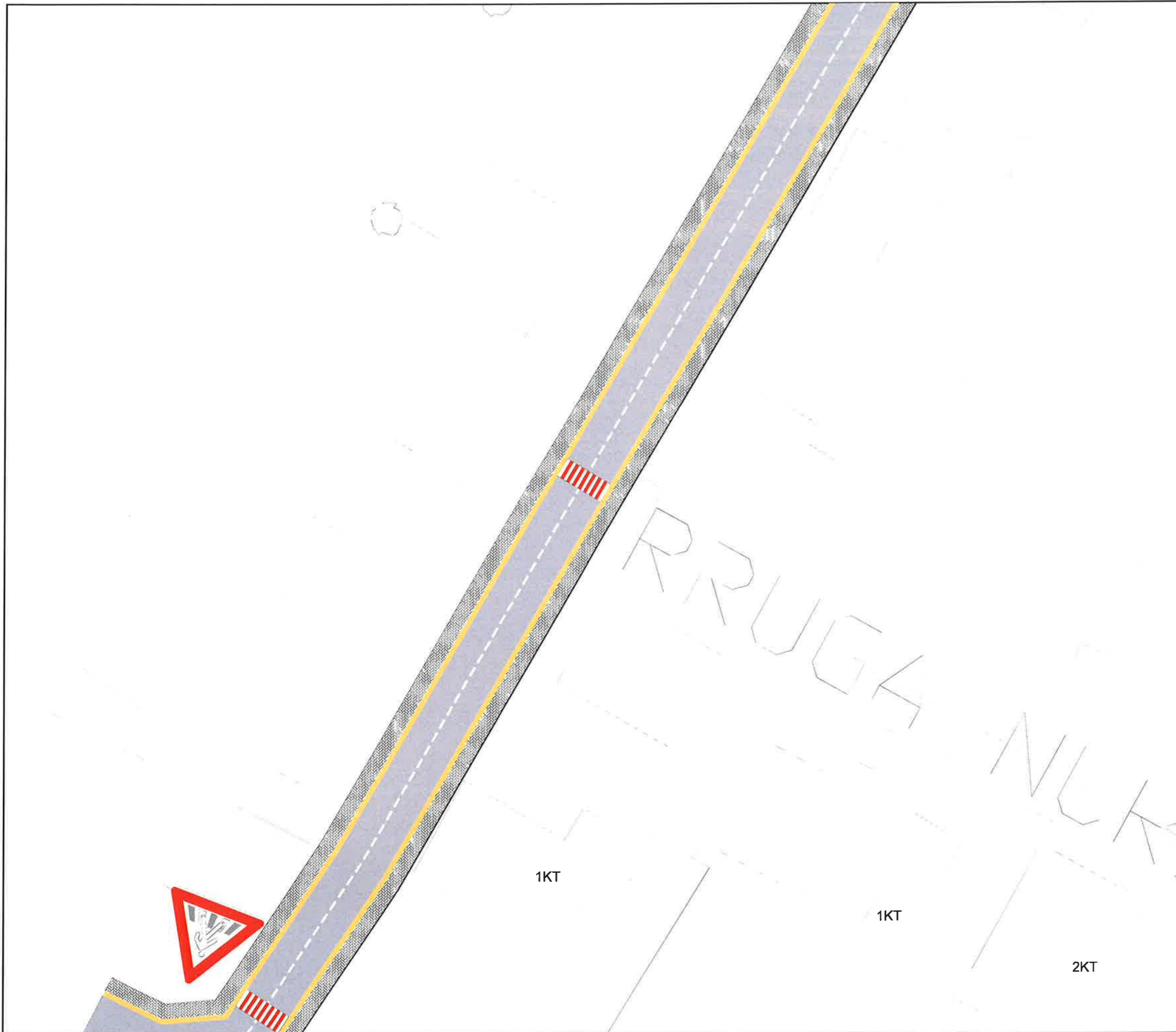

LEGJENDA



BASHKIA KAMËZ

DREJTORIA E PROJEKTEVE DHE INVESTIMEVE
DEPARTAMENTI I PROJEKTEVE

Dr. e Projekteve e Investimeve FLORA MUCA

STAFI TEKNIK
PROJEKTUES

- Ing. ERBLIN LALA
- Ing. ARJOLA KURTI
- Ing. DENIS PRENÇI
- Ing. EGLANTINA DISHA
- Ing. RAMADAN HYSA

Titulli i Projektit
NDERTIM RRUGA "BETIM MUÇO"

Emertimi i Fletes
PLANIMETRI ASFALTI

Faza e Projektit
PROJEKT ZBATIMI

Data e Implementimit :

Shkalla e Vizatimit

Fleta Nr.

A-37

NDERTIM RRUGA: "BETIM MUÇO"



LEGJENDA



 **BASHKIA KAMËZ**
DREJTORIA E PROJEKTEVE DHE INVESTIMEVE
DEPARTAMENTI I PROJEKTEVE

Dr. e Projekteve e Investimeve		FLORA MUCA
STAFI TEKNIK PROJEKTES	Ing.	ERBLIN LALA
	Ing.	ARJOLA KURTI
	Ing.	DENIS PRENÇI
	Ing.	EGLANTINA DISHA
	Ing.	RAMADAN HYSA

Titulli i Projektit	NDERTIM RRUGA "BETIM MUÇO"	Faza e Projektit	PROJEKT ZBATIMI
Emertimi i Fletes	PLANIMETRI ASFALTI	Data e Implementimit :	
		Shkalla e Vizatimit	
		Fleta Nr.	A-38

NDERTIM RRUGA: "BETIM MUÇO"

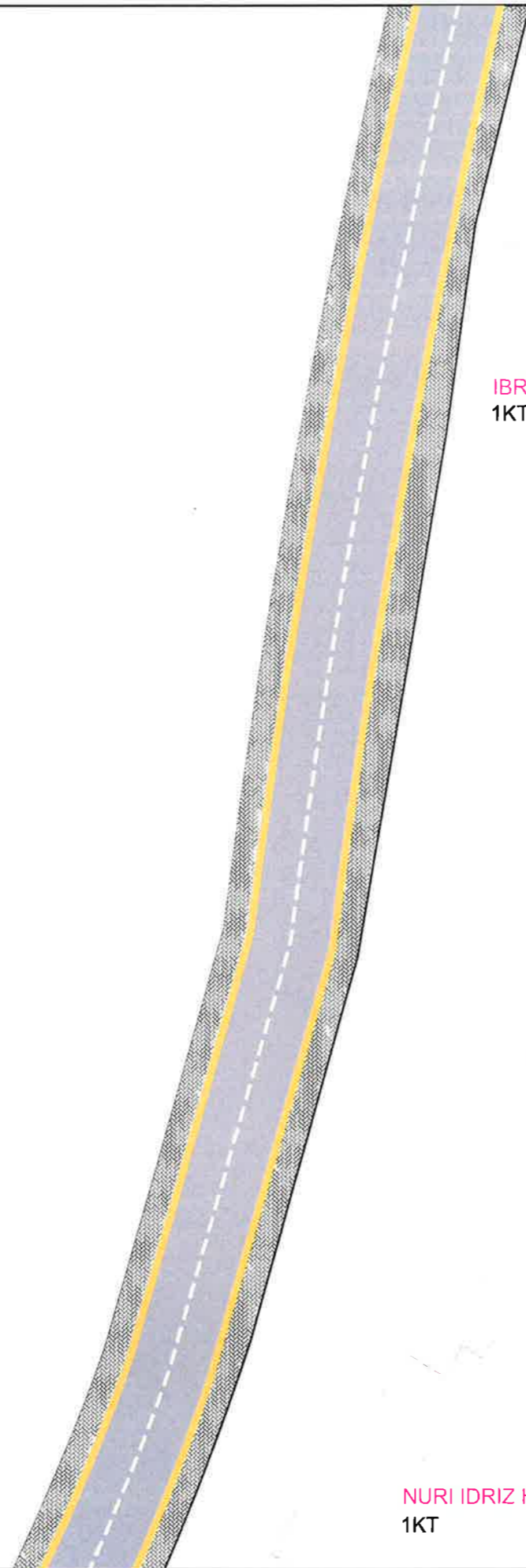

IBRAHIM XHAMAL BALLIU
1KT

BLEDION SHABAN BALLIU, DUDIE HAMDİ BALLIU
1KT+1KT NENTOKE

HAMDİ XHAMAL BALLIU
1KT

BILAL HAXHI HAJDINI
1KT

NURI IDRIZ HOXHA, BUJAR NURI HOXHA
1KT



LEGJENDA



BASHKIA KAMËZ

DREJTORIA E PROJEKTEVE DHE INVESTIMEVE
DEPARTAMENTI I PROJEKTEVE

Dr. e Projekteve e Investimeve	FLORA MUCA	
STAFI TEKNIK PROJEKTUES	Ing. ERBLIN LALA	
	Ing. ARJOLA KURTI	
	Ing. DENIS PRENÇI	
	Ing. EGLANTINA DISHA	
	Ing. RAMADAN HYSA	

Titulli i Projektit NDERTIM RRUGA "BETIM MUÇO"	Faza e Projektit PROJEKT ZBATIMI
Emertimi i Fletes PLANIMETRI ASFALTI	Data e Implementimit :
	Shkalla e Vizatimit
	Fleta Nr. A-39

NDERTIM RRUGA: "BETIM MUÇO"



LEGJENDA



BASHKIA KAMËZ

DREJTORIA E PROJEKTEVE DHE INVESTIMEVE
DEPARTAMENTI I PROJEKTEVE

Dr. e Projekteve e Investimeve FLORA MUCA

STAFI TEKNIK
PROJEKTUES

- Ing. ERBLIN LALA
- Ing. ARJOLA KURTI
- Ing. DENIS PRENÇI
- Ing. EGLANTINA DISHA
- Ing. RAMADAN HYSA

Titulli i Projektit
NDERTIM RRUGA "BETIM MUÇO"

Emertimi i Fletes
PLANIMETRI ASFALTI

Faza e Projektit
PROJEKT ZBATIMI

Data e Implementimit :

Shkalla e Vizatimit

Fleta Nr.

A-40

NDERTIM RRUGA: "BETIM MUÇO"

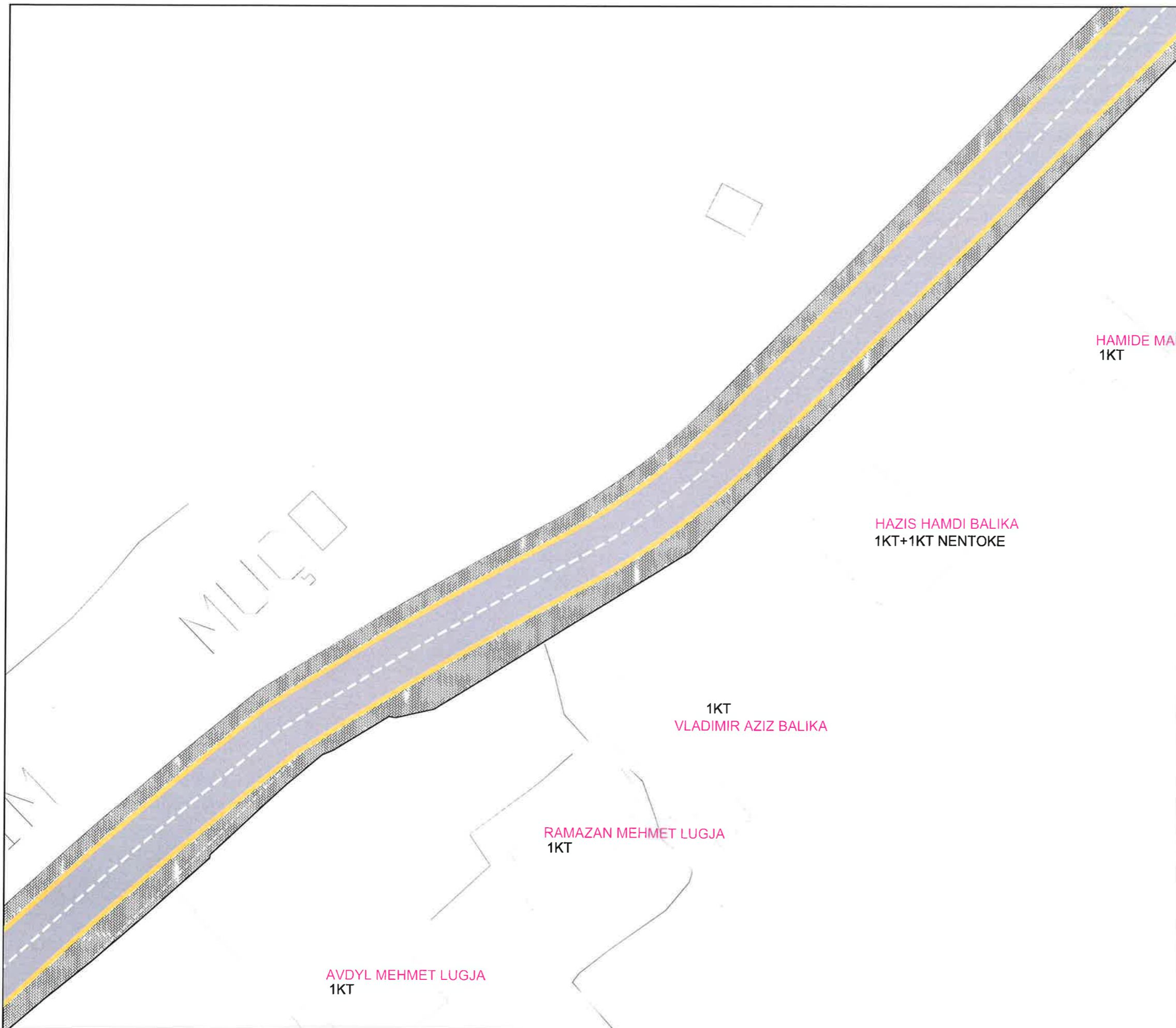

LEGJENDA



BASHKIA KAMËZ

DREJTORIA E PROJEKTEVE DHE INVESTIMEVE
DEPARTAMENTI I PROJEKTEVE

Dr. e Projekteve e Investimeve FLORA MUCA

STAFI TEKNIK
PROJEKTUES

- Ing. ERBLIN LALA
- Ing. ARJOLA KURTI
- Ing. DENIS PRENÇI
- Ing. EGLANTINA DISHA
- Ing. RAMADAN HYSA

Titulli i Projektit
NDERTIM RRUGA "BETIM MUÇO"

Faza e Projektit
PROJEKT ZBATIMI

Data e Implementimit:

Shkalla e Vizatimit

Emertimi i Fletes
PLANIMETRI ASFALTI

Fleta Nr.

A-41

NDERTIM RRUGA: "BETIM MUÇO"



LEGJENDA

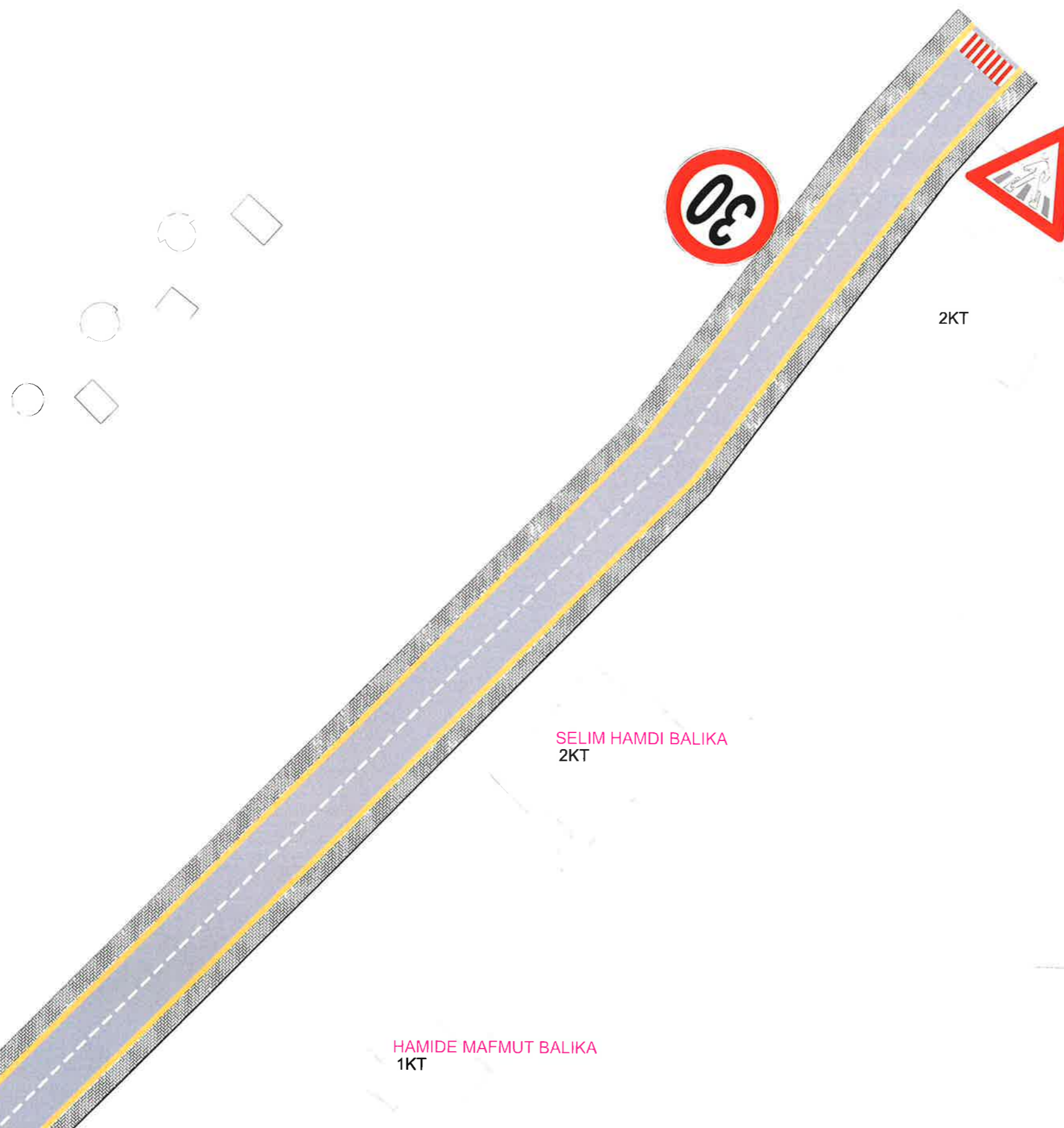

2KT

SELIM HAMDİ BALIKA
2KT

HAMIDE MAFMUT BALIKA
1KT



BASHKIA KAMËZ

DREJTORIA E PROJEKTEVE DHE INVESTIMEVE
DEPARTAMENTI I PROJEKTEVE

Dr. e Projekteve e Investimeve FLORA MUCA

STAFI TEKNIK
PROJEKTUES

- Ing. ERLIN LALA
- Ing. ARJOLA KURTI
- Ing. DENIS PRENÇI
- Ing. EGLANTINA DISHA
- Ing. RAMADAN HYSA

Titulli i Projektit
NDERTIM RRUGA "BETIM MUÇO"

Emertimi i Fletes
PLANIMETRI ASFALTI

Faza e Projektit
PROJEKT ZBATIMI

Data e Implementimit :

Shkalla e Vizatimit

Fiota Nr.
A-42

NDERTIM RRUGA: "BETIM MUÇO" DETAJE SINJALISTIKE

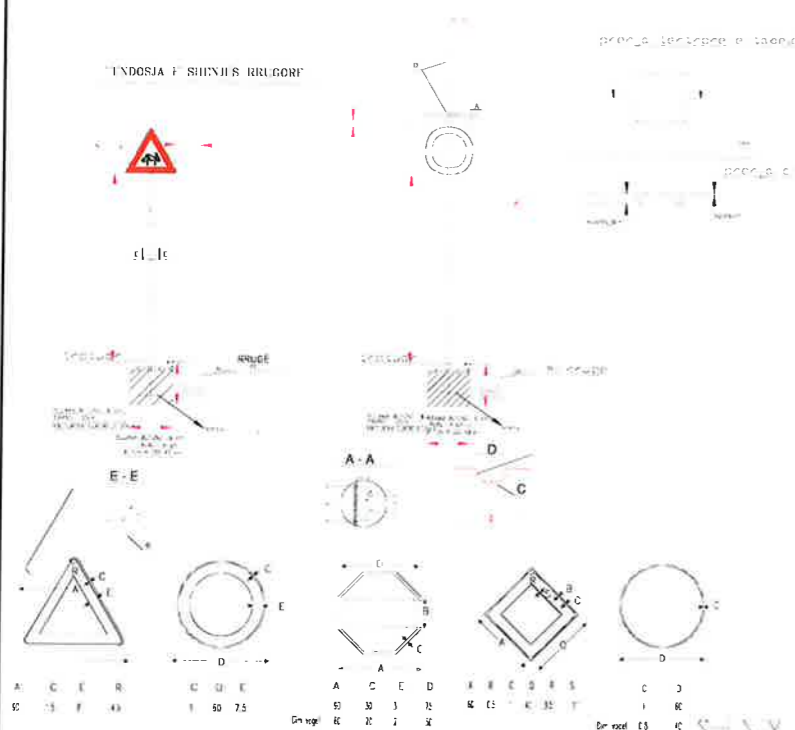

ALVETIM RRUGA NDERTIM RRUGA: "BETIM MUÇO" DETAJE SINJALISTIKE

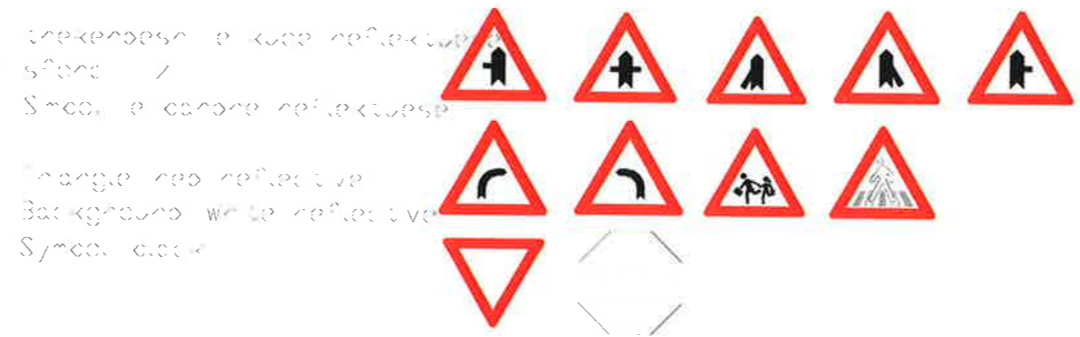

Shenjat rrugore per nga forma, madhesi, ngjyra, reflektiviteti duhet te jene sias Kos. Rrugat te Republikes se Shqiperise
Vatona, praparefleksive duhet te keten jeteqates 10vjet per class B one / 7vjet per class II
Shenjat rrugore shenje rrugore duhet te jene realizuar me coqe te trajtohet me objekte e cila nuk humbet shqetesit praparefleksive
Shenje rrugore realizohen ne jeteqates 10vjet e cila varet me coqe objekto kurororone korzorione trajtohet me objekte

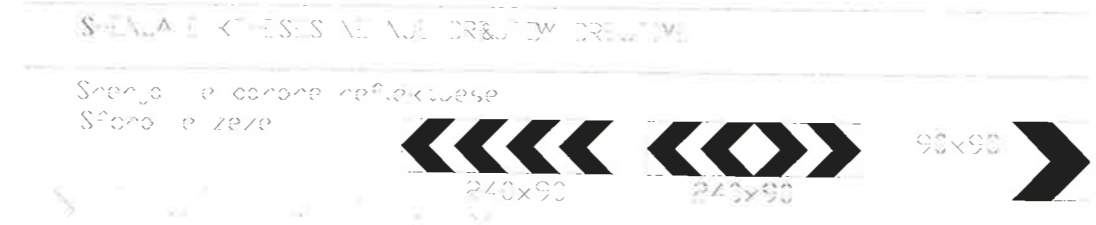

LEGJENDA





BASHKIA KAMËZ

DREJTORIA E PROJEKTEVE DHE INVESTIMEVE
DEPARTAMENTI I PROJEKTEVE

Dr. e Projekteve e Investimeve **FLORA MUCA**

STAFI TEKNIK
PROJEKTUES

Ing.	ERBLIN LALA	
Ing.	ARJOLA KURTI	
Ing.	DENIS PRENÇI	
Ing.	EGLANTINA DISHA	
Ing.	RAMADAN HYSA	

Titulli i Projektit NDERTIM RRUGA "BETIM MUÇO"	Faza e Projektit PROJEKT ZBATIMI
Data e Implementimit:	
Shkalla e Vizatimit	
Emertimi i Fletes DETAJE SINJALISTIKE	
Fleta Nr. A-43	

NDERTIM RRUGA: "BETIM MUÇO" DETAJE VJEZIMI

TIPET E VIZIMEVE TE RRUGES

KALIMETI E KOMBINIMEVE

SHIGJETAT TREGUESHE TE RRUGES



VIJAT KUFIZUES TE KORSISE

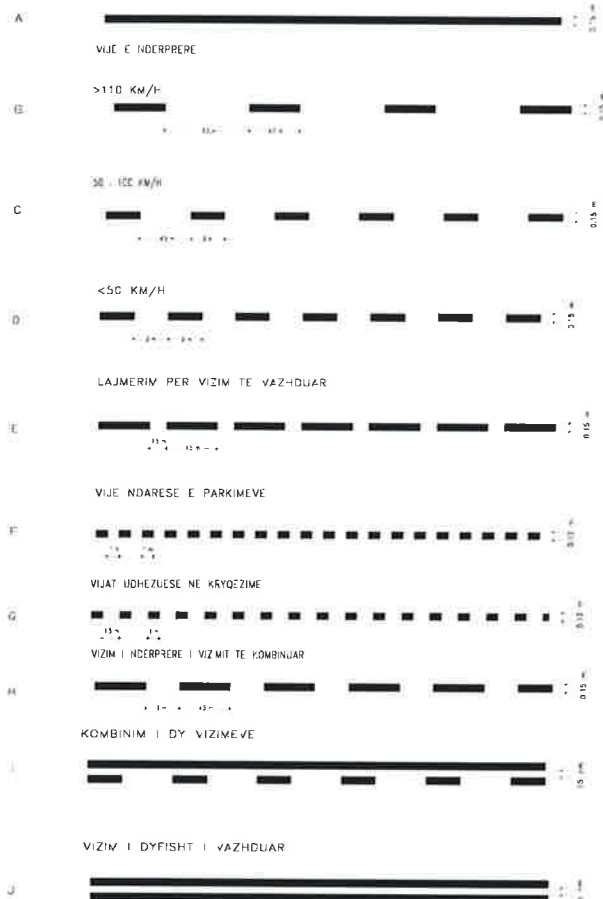

V/V RRUGES

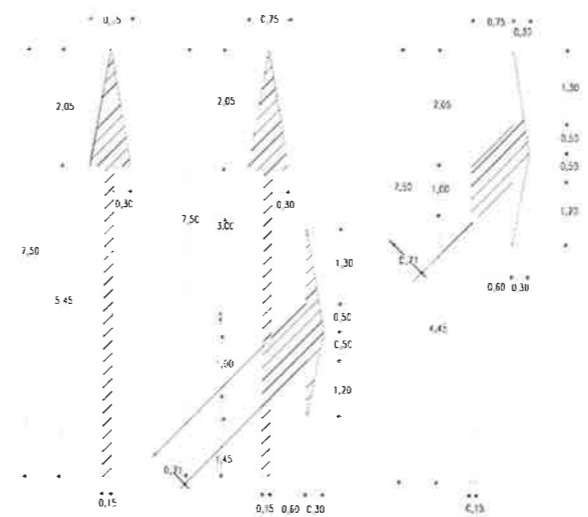
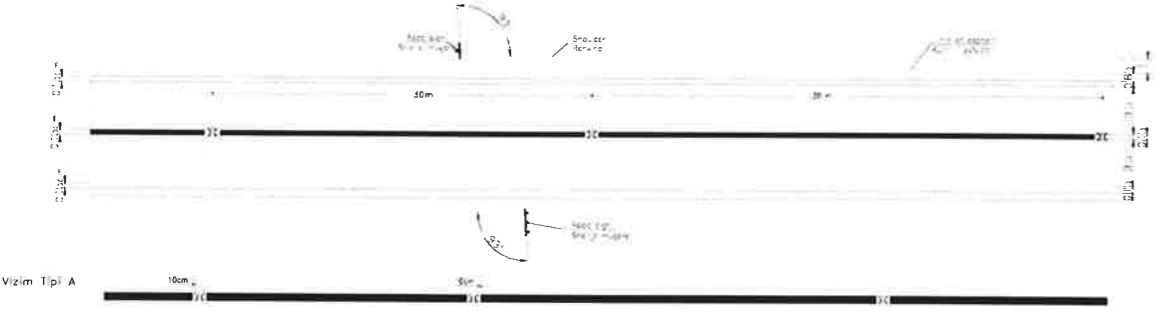

DHENE PERPARESIE

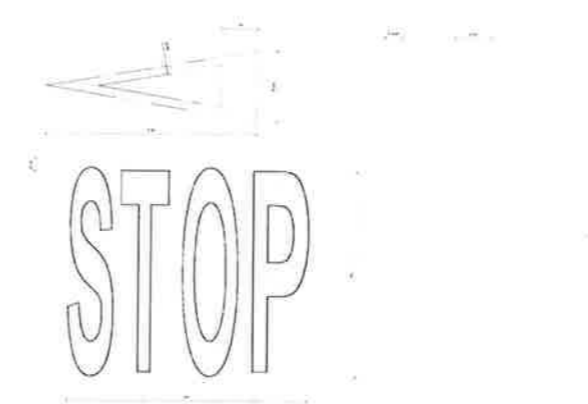

LEGJENDA



BASHKIA KAMËZ
 DREJTORIA E PROJEKTEVE DHE INVESTIMEVE
 DEPARTAMENTI I PROJEKTEVE

Dr. e Projekteve e Investimeve	FLORA MUCA
STAFI TEKNIK PROJEKTUES	Ing. ERBLIN LALA Ing. ARJOLA KURTI Ing. DENIS PRENÇI Ing. EGLANTINA DISHA Ing. RAMADAN HYSA

Titulli i Projektit	NDERTIM RRUGA "BETIM MUÇO"
Emertimi i Fletes	DETAJE VJEZIMI
Faza e Projektit	PROJEKT ZBATIMI
Data e Implementimit:	
Shkalla e Vizimit	
Fleta Nr.	A-44

NDERTIM RRUGA: "BETIM MUÇO" DETAJE VJEZIMI

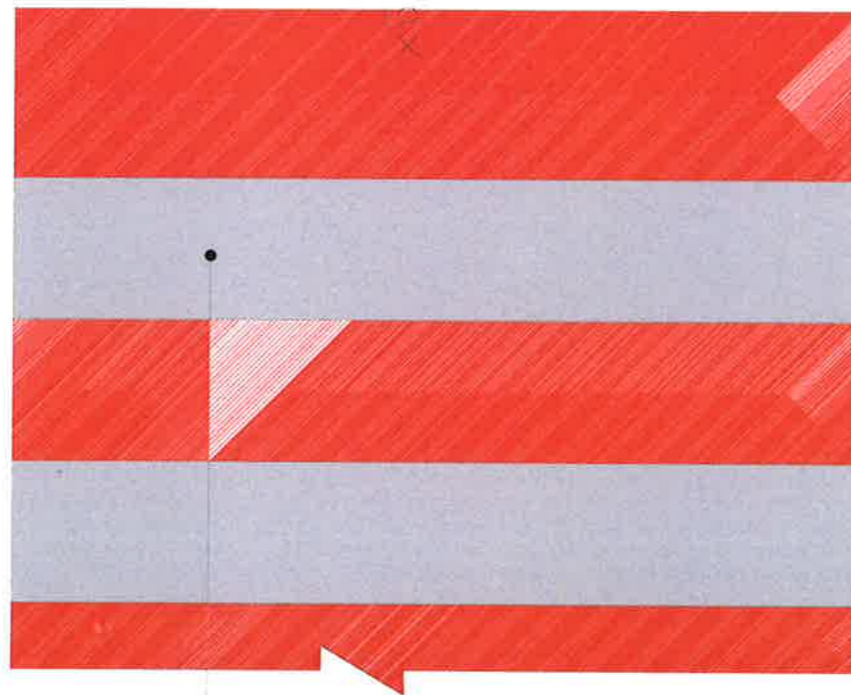
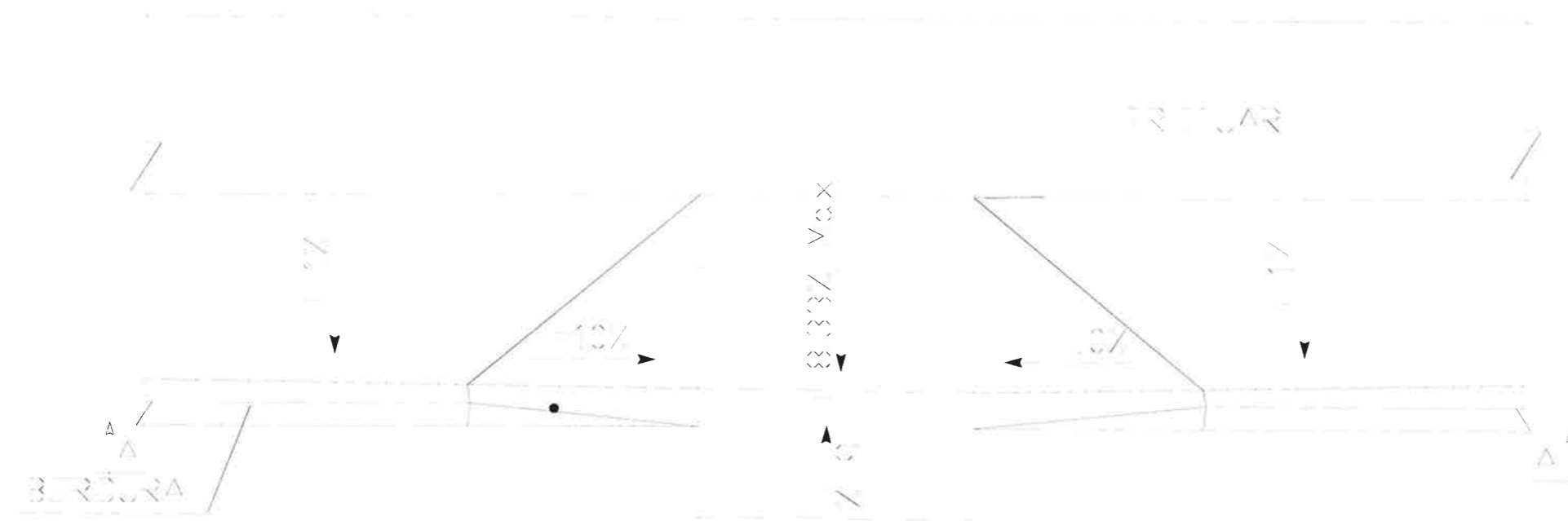

VIZAT E BARDHA DHE TE KUÇE



LEGJENDA



BASHKIA KAMËZ

DREJTORIA E PROJEKTEVE DHE INVESTIMEVE
DEPARTAMENTI I PROJEKTEVE

Dr. e Projekteve e Investimeve FLORA MUCA

STAFI TEKNIK
PROJEKTUES
Ing. ERBLIN LALA
Ing. ARJOLA KURTI
Ing. DENIS PRENÇI
Ing. EGLANTINA DISHA
Ing. RAMADAN HYSA

Titulli i Projektit

NDERTIM RRUGA "BETIM MUÇO"

Emertimi i Fletes

DETAJE VIJEZIMI

Faza e Projektit

PROJEKT ZBATIMI

Data e Implementimit:

Shkalla e Vizatimit

Fleta Nr.

A-45

NDERTIM RRUGA: "BETIM MUÇO"

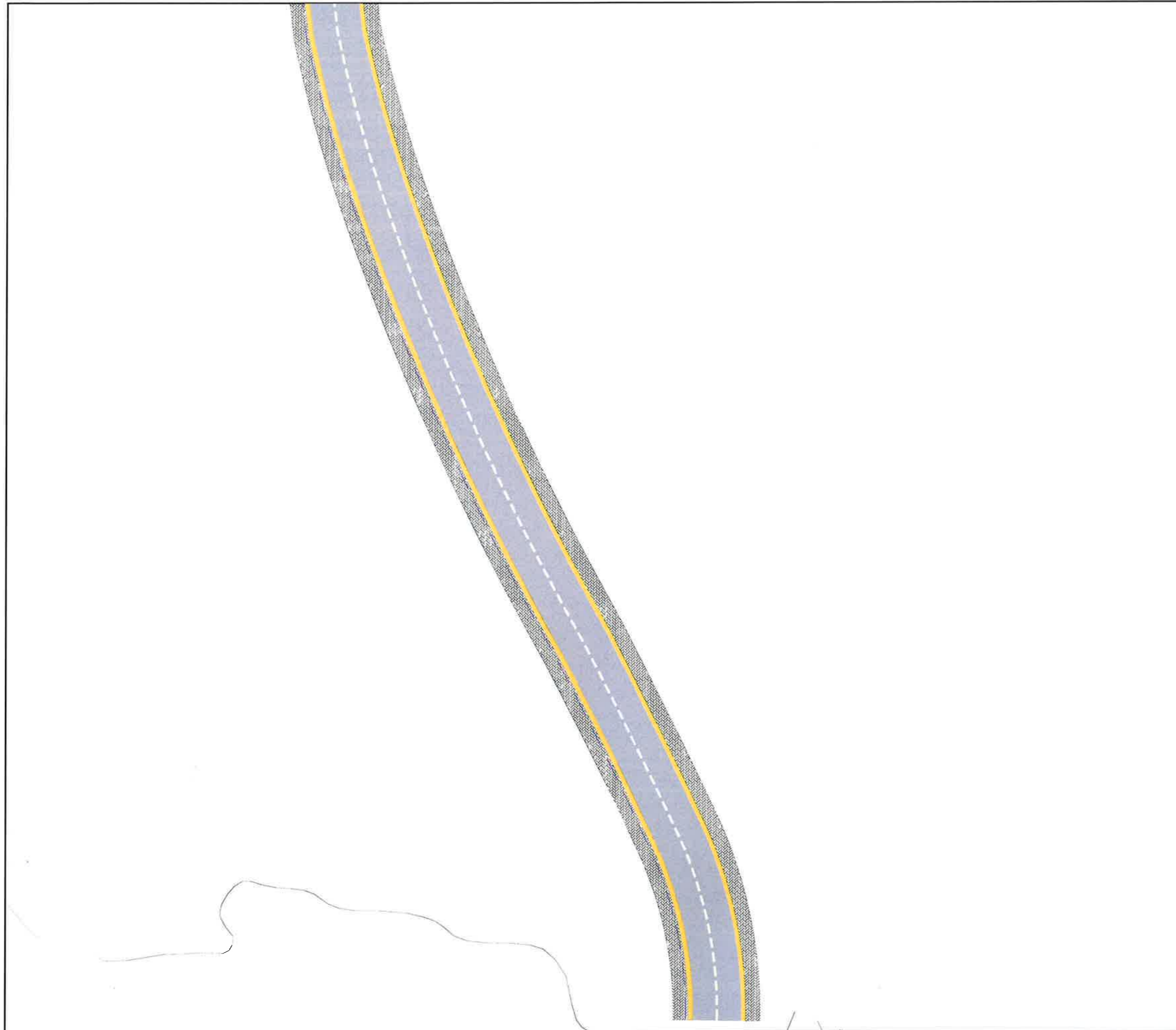

LEGJENDA

 TUB KARROGATO
PER TELEFONINE

 TUB KARROGATO NDRICIMI
DHE ELEKTRIKUN



BASHKIA KAMËZ

DREJTORIA E PROJEKTEVE DHE INVESTIMEVE
DEPARTAMENTI I PROJEKTEVE

Dr. e Projekteve e Investimeve FLORA MUCA

STAFI TEKNIK
PROJEKTUES

Ing.	ERBLIN LALA
Ing.	ARJOLA KURTI
Ing.	DENIS PRENÇI
Ing.	EGLANTINA DISHA
Ing.	RAMADAN HYSA

Titulli i Projektit
NDERTIM RRUGA "BETIM MUÇO"

Emertimi i Fletes
PLANIMETRINDRICIMI

Faza e Projektit
PROJEKT ZBATIMI

Data e Implementimit:

Shkalla e Vizatimit

Fleta Nr.

A-46

NDERTIM RRUGA: "BETIM MUÇO"

PRENDOSH MARTIN ZIMALI

1KT

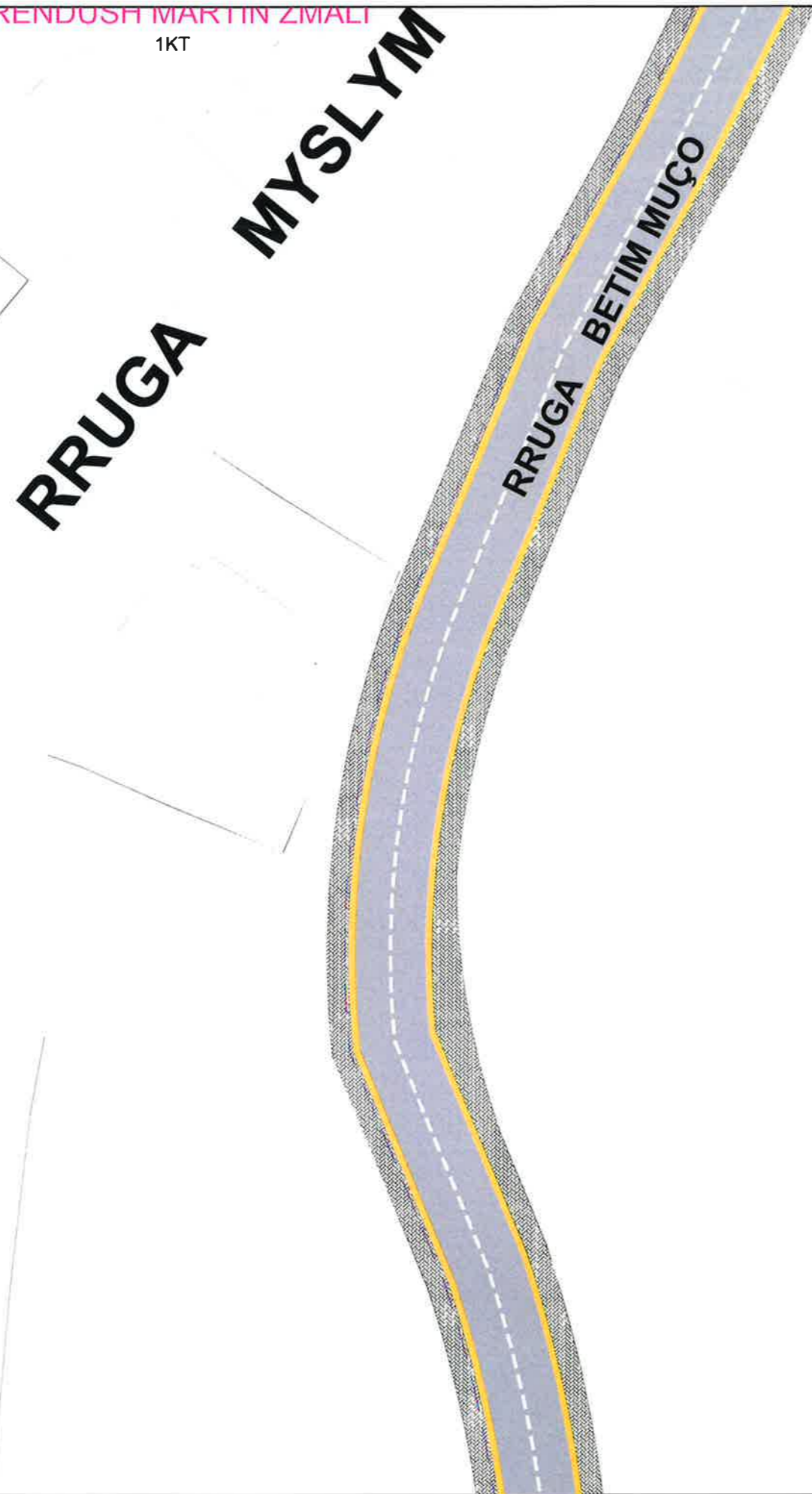

LEGJENDA

 TUB KARROGATO PER TELEFONINE

 TUB KARROGATO NDRICIMI DHE ELEKTRIKUN



BASHKIA KAMËZ

DREJTORIA E PROJEKTEVE DHE INVESTIMEVE
DEPARTAMENTI I PROJEKTEVE

Dr. e Projekteve e Investimeve FLORA MUCA

STAFI TEKNIK
PROJEKTUES

- Ing. ERBLIN LALA
- Ing. ARJOLA KURTI
- Ing. DENIS PRENÇI
- Ing. EGLANTINA DISHA
- Ing. RAMADAN HYSA

Titulli i Projektit
NDERTIM RRUGA "BETIM MUÇO"

Emertimi i Fletes
PLANIMETRINDRICIMI

Emri e Projektit
PROJEKT ZBATIMI

Data e Implementimit :

Shkalla e Vizatimit

Fleta Nr.

A-47

NDERTIM RRUGA: "BETIM MUÇO"

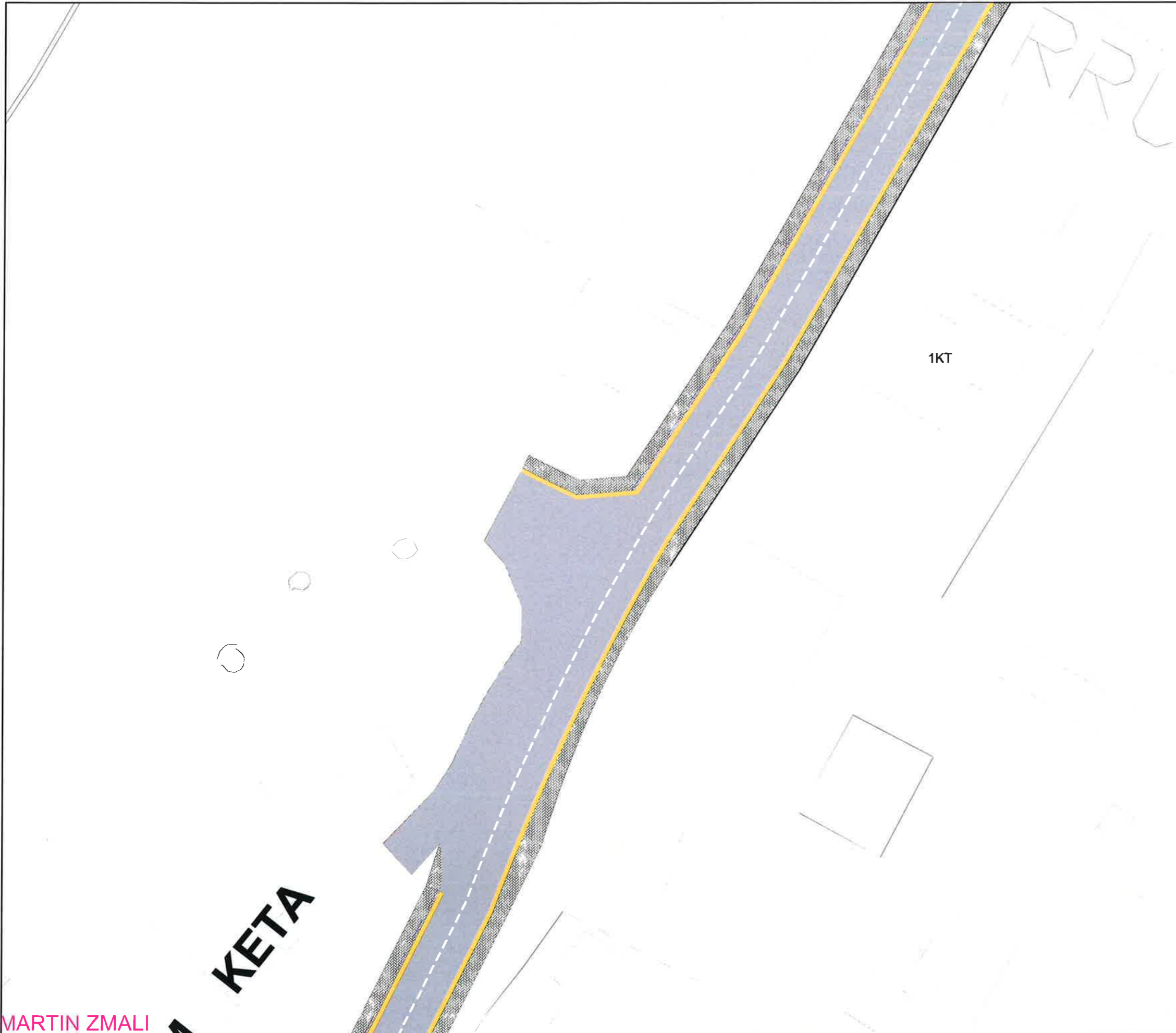

LEGJENDA

-  TUB KARROGATO PER TELEFONINE
-  TUB KARROGATO NDRICIMI DHE ELEKTRIKUN



BASHKIA KAMËZ

DREJTORIA E PROJEKTEVE DHE INVESTIMEVE
DEPARTAMENTI I PROJEKTEVE

Dr. e Projekteve e Investimeve FLORA MUCA

STAFI TEKNIK
PROJEKTUES

- Ing. ERBLIN LALA
- Ing. ARJOLA KURTI
- Ing. DENIS PRENÇI
- Ing. EGLANTINA DISHA
- Ing. RAMADAN HYSA

(Handwritten signatures and initials)

Titulli i Projektit
NDERTIM RRUGA "BETIM MUÇO"

Emertimi i Fletes
PLANIMETRINDRICIMI

Faza e Projektit
PROJEKT ZBATIMI

Data e Implementimit :

Shkalla e Vizatimit

Fleta Nr.

A-48

NDERTIM RRUGA: "BETIM MUÇO"



LEGJENDA

 TUB KARROGATO PER TELEFONINE

 TUB KARROGATO NDRICIMI DHE ELEKTRIKUN



BASHKIA KAMËZ

DREJTORIA E PROJEKTEVE DHE INVESTIMEVE
DEPARTAMENTI I PROJEKTEVE

Dr. e Projekteve e Investimeve FLORA MUCA

STAFI TEKNIK
PROJEKTUES

- Ing. ERBLIN LALA
- Ing. ARJOLA KURTI
- Ing. DENIS PRENÇI
- Ing. EGLANTINA DISHA
- Ing. RAMADAN HYSA

Titulli i Projektit
NDERTIM RRUGA "BETIM MUÇO"

Emertimi i Fletes
PLANIMETRINDRICIMI

Faza e Projektit
PROJEKT ZBATIMI

Data e Implementimit :

Shkalla e Vizatimit



Fleta Nr.

A-49

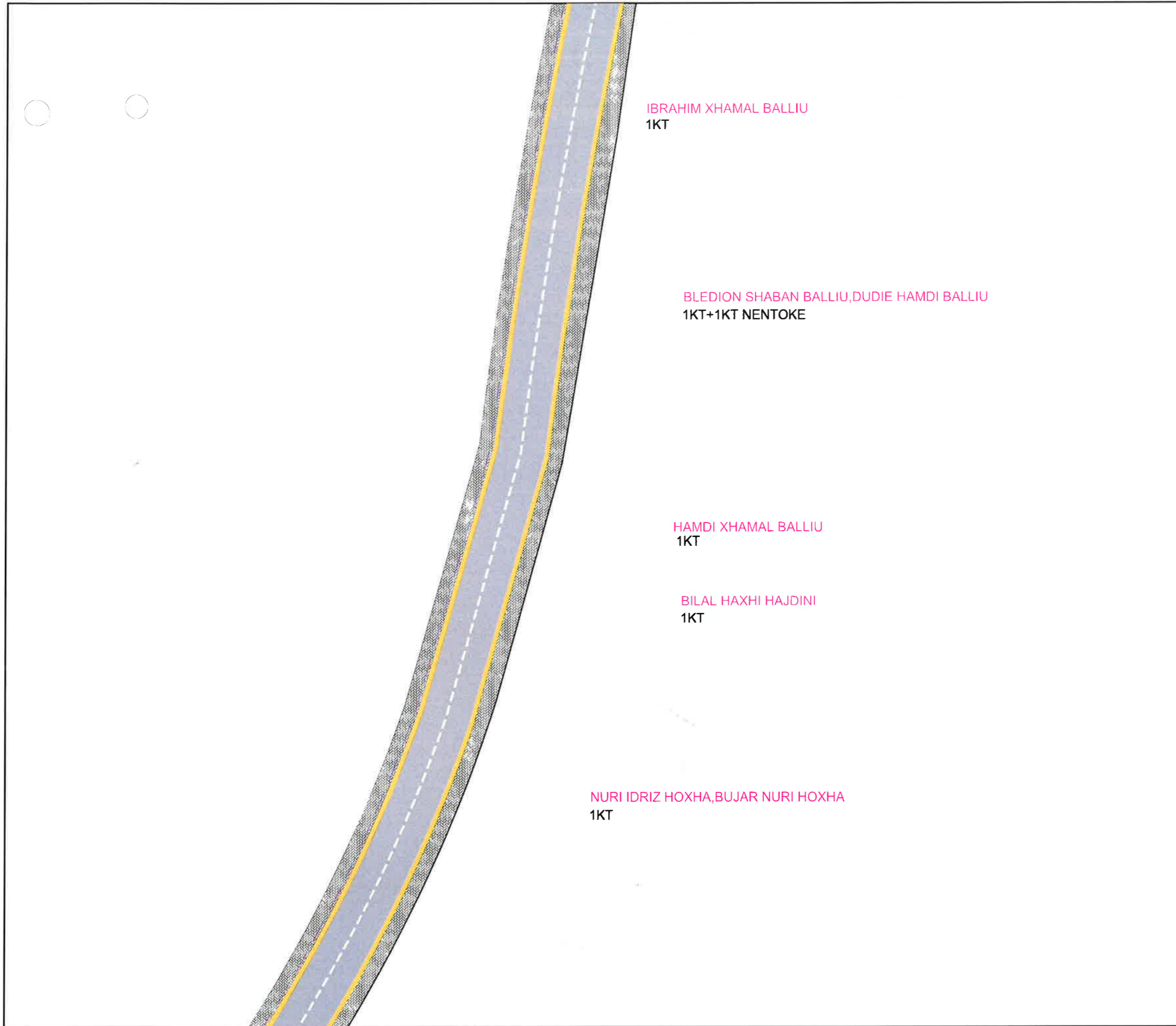
NDERTIM RRUGA: "BETIM MUÇO"



LEGJENDA

-  TUB KARROGATO PER TELEFONINE
-  TUB KARROGATO NDRICIMI DHE ELEKTRIKUN

 **BASHKIA KAMËZ**
DREJTORIA E PROJEKTEVE DHE INVESTIMEVE
DEPARTAMENTI I PROJEKTEVE

Dr. e Projekteve e Investimeve		FLORA MUCA	
STAFI TEKNIK PROJEKTUES	Ing.	ERBLIN LALA	
	Ing.	ARJOLA KURTI	
	Ing.	DENIS PRENÇI	
	Ing.	EGLANTINA DISHA	
	Ing.	RAMADAN HYSA	

Titulli i Projektit	NDERTIM RRUGA "BETIM MUÇO"	Faza e Projektit	PROJEKT ZBATIMI
Emertimi i Fletës	PLANIMETRINDRICIMI	Data e Implementimit:	
		Shkalla e Vizatimit	
		Fleta Nr.	A-50

NDERTIM RRUGA: "BETIM MUÇO"

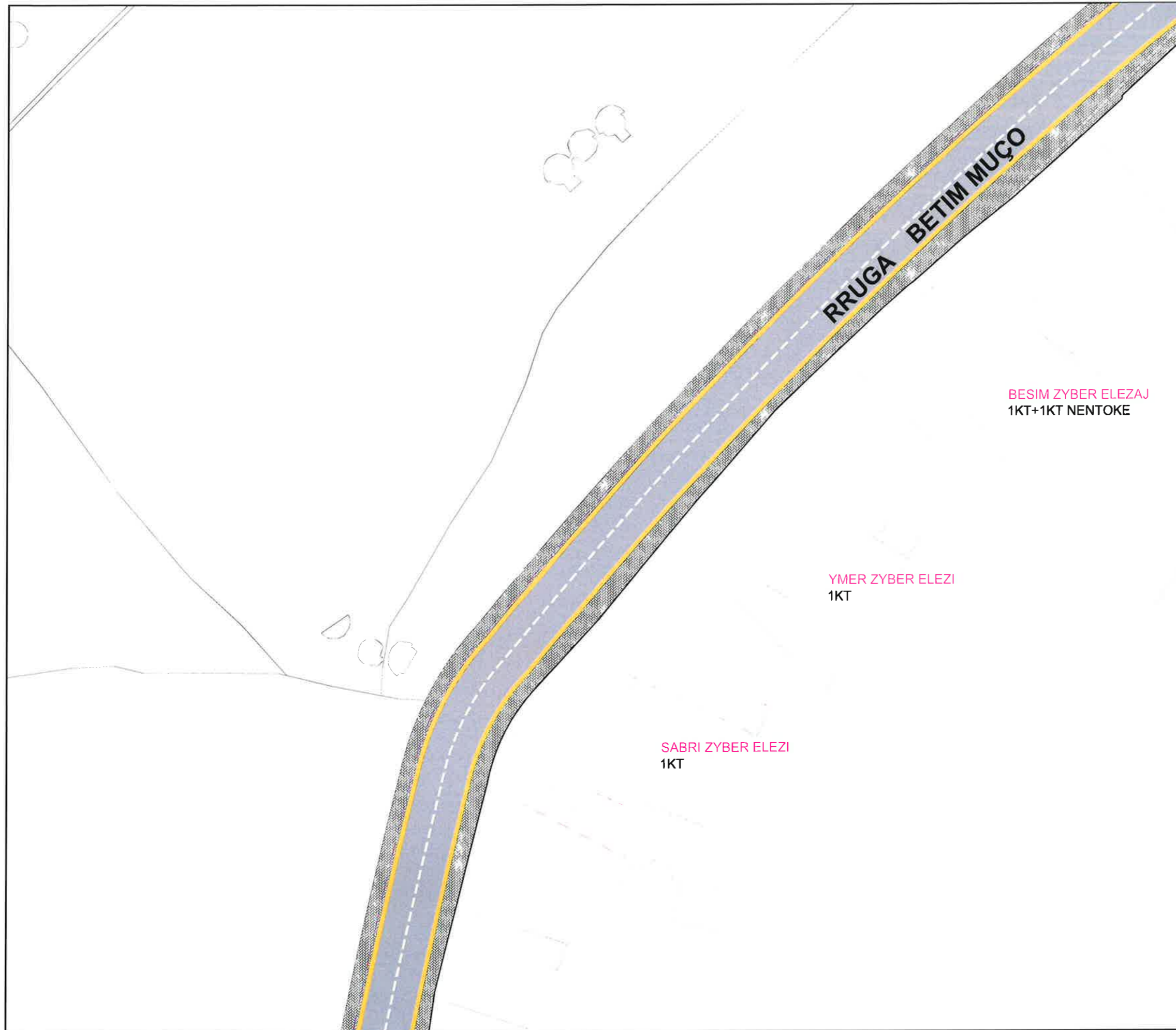

LEGJENDA

-  TUB KARROGATO PER TELEFONINE
-  TUB KARROGATO NDRICIMI DHE ELEKTRIKUN



BASHKIA KAMËZ

DREJTORIA E PROJEKTEVE DHE INVESTIMEVE
DEPARTAMENTI I PROJEKTEVE

Dr. e Projekteve e Investimeve **FLORA MUCA**

STAFI TEKNIK PROJEKTUES	Ing. ERBLIN LALA	
Ing. ARJOLA KURTI		
Ing. DENIS PRENÇI		
Ing. EGLANTINA DISHA		
Ing. RAMADAN HYSA		

Titulli i Projektit
NDERTIM RRUGA "BETIM MUÇO"

Emertimi i Fletes
PLANIMETRINDRICIMI

Pëza e Projektit
PROJEKT ZBATIMI

Data e Implementimit:

Shkalla e Vizatimit

Fleta Nr.
A-51

NDERTIM RRUGA: "BETIM MUÇO"

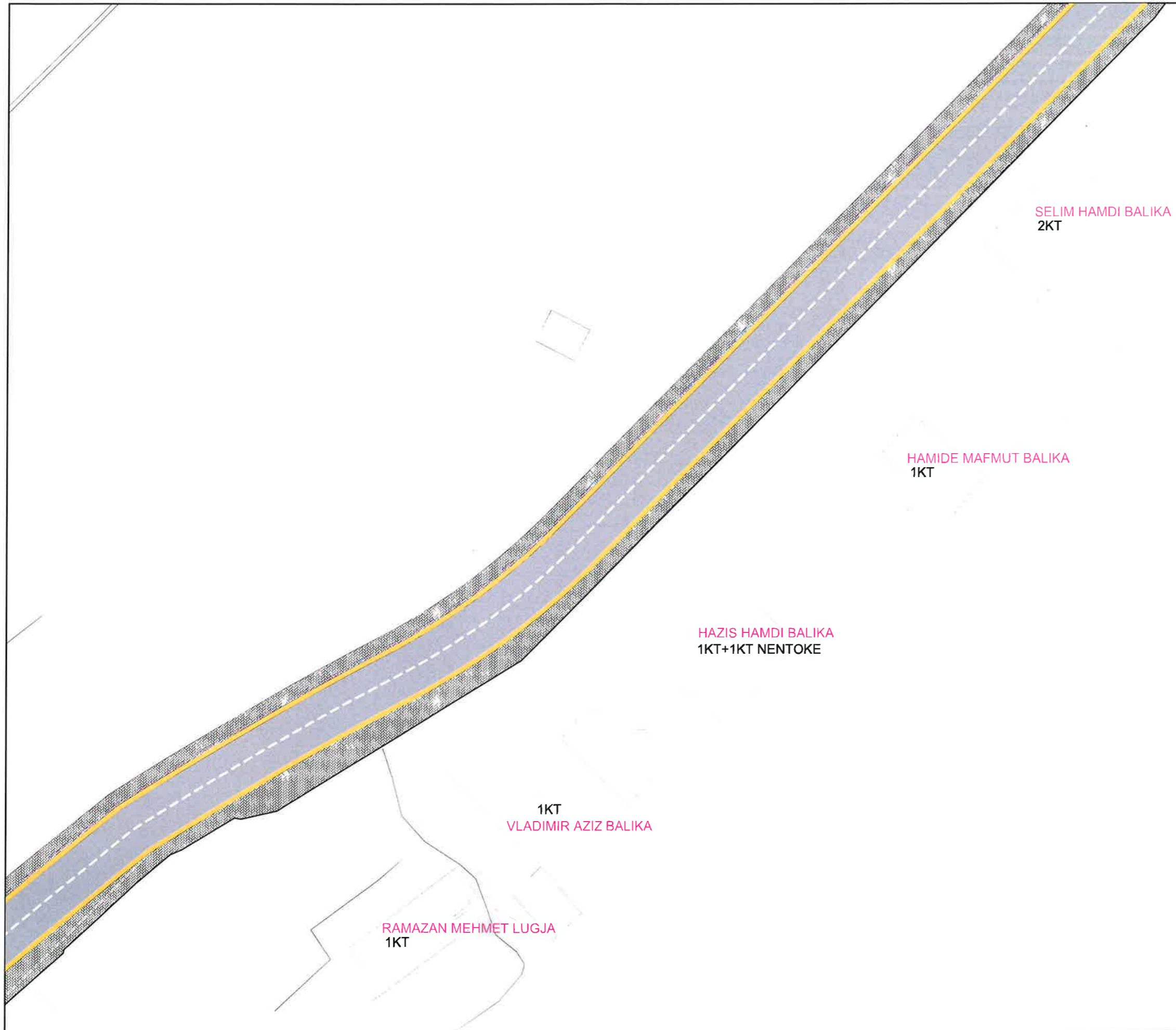

LEGJENDA

 TUB KARROGATO PER TELEFONINE

 TUB KARROGATO NDRICIMI DHE ELEKTRIKUN

 **BASHKIA KAMËZ**
DREJTORIA E PROJEKTEVE DHE INVESTIMEVE
DEPARTAMENTI I PROJEKTEVE



Dr. e Projekteve e Investimeve	FLORA MUCA
STAFI TEKNIK PROJEKTUES	Ing. ERBLIN LALA
	Ing. ARJOLA KURTI
	Ing. DENIS PRENÇI
	Ing. EGLANTINA DISHA
	Ing. RAMADAN HYSA

Titulli i Projektit	NDERTIM RRUGA "BETIM MUÇO"	Faza e Projektit	PROJEKT ZBATIMI
Emertimi i Fletes	PLANIMETRINDRICIMI	Data e Implementimit :	
		Shkalla e Vizatimit	
		Fleta Nr.	A-52

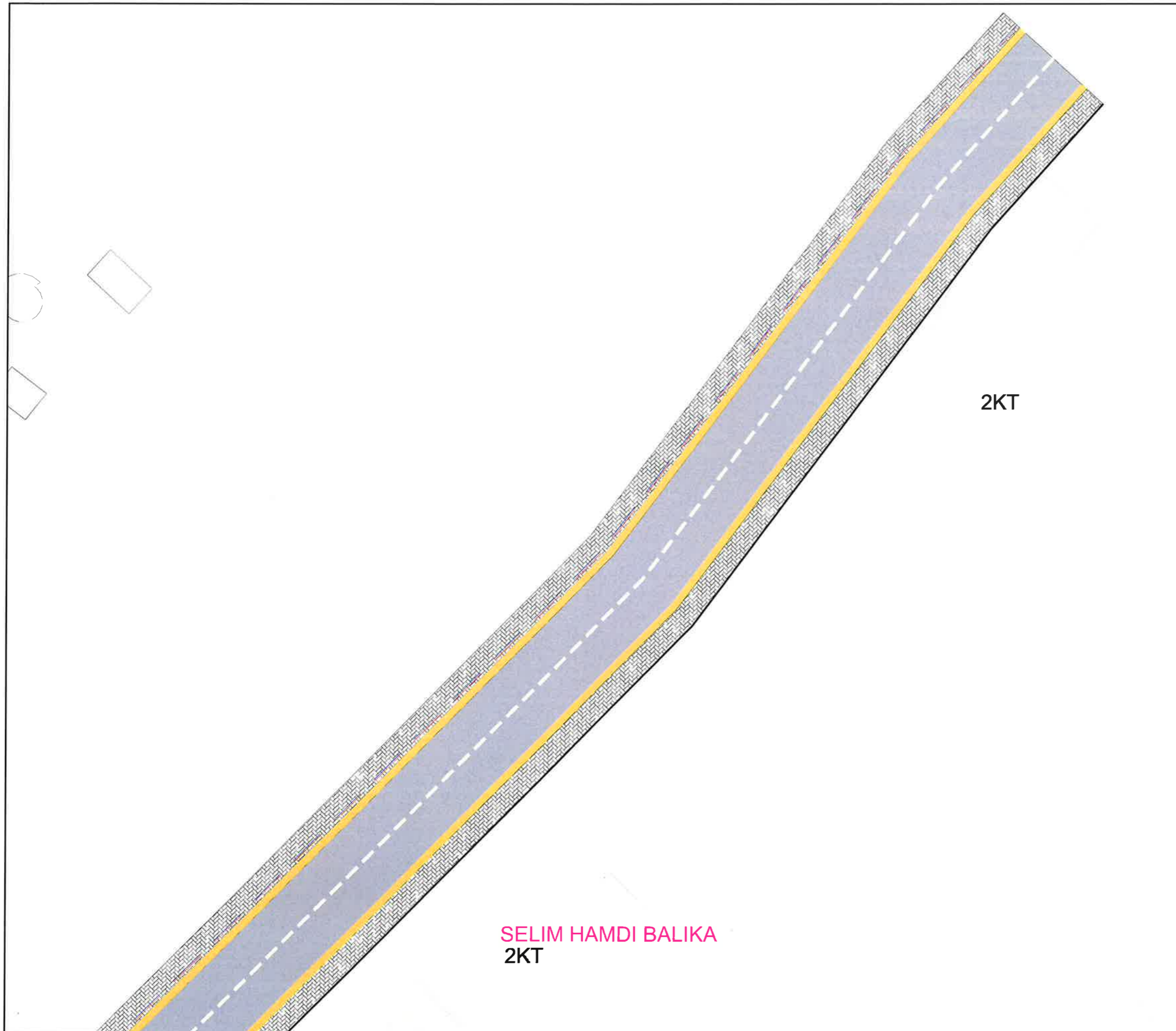
NDERTIM RRUGA: "BETIM MUÇO"



LEGJENDA

-  TUB KARROGATO PER TELEFONINE
- 
-  TUB KARROGATO NDRICIMI DHE ELEKTRIKUN



BASHKIA KAMËZ

DREJTORIA E PROJEKTEVE DHE INVESTIMEVE
DEPARTAMENTI I PROJEKTEVE

Dr. e Projekteve e Investimeve	FLORA MUCA	
STAFI TEKNIK PROJEKTUES	Ing. ERBLIN LALA	
	Ing. ARJOLA KURTI	
	Ing. DENIS PRENÇI	
	Ing. EGLANTINA DISHA	
	Ing. RAMADAN HYSA	

Titulli i Projektit NDERTIM RRUGA "BETIM MUÇO"	Faza e Projektit PROJEKT ZBATIMI
Emertimi i Fletes PLANIMETRINDRICIMI	Data e Implementimit :
	Shkalla e Vizatimit
	Fleta Nr. A-53

NDERTIM RRUGA: "BETIM MUÇO" DETAJE NDRICIMI



LEGJENDA

-  TUB KARROGATO PER TELEFONINE
-  TUB KARROGATO NDRICIMI DHE ELEKTRIKUN

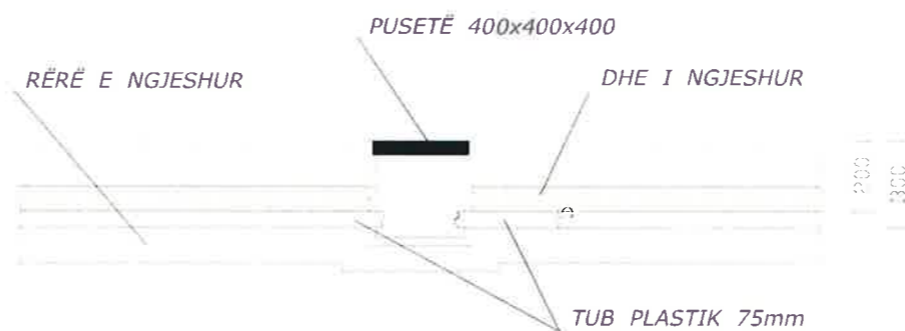

 **BASHKIA KAMËZ**
DREJTORIA E PROJEKTEVE DHE INVESTIMEVE
DEPARTAMENTI I PROJEKTEVE

Dr. e Projekteve e Investimeve	FLORA MUCA
STAFI TEKNIK PROJEKTUES	Ing. ERBLIN LALA
	Ing. ARJOLA KURTI
	Ing. DENIS PRENÇI
	Ing. EGLANTINA DISHA
	Ing. RAMADAN HYSA

Titulli i Projektit NDERTIM RRUGA "BETIM MUÇO"	Faza e Projektit PROJEKT ZBATIMI
Emertimi i Fletes DETAJE SINJALISTIKE	Data e Implementimit:
	Shkalla e Vizatimit
	Fleta Nr. A-55

NDERTIM RRUGA: "BETIM MUÇO" DETAJE NDRICIMI



DETAJE TE NDERTIMIT TE Pusetave dhe Tubacionit TE NDRICIMIT RRUGOR

PRERJA E KAPAKUT PREJ GIZE



KAPAKU PREJ GIZE I Pusetes



PRERJE E Pusetes dhe Tubacionit

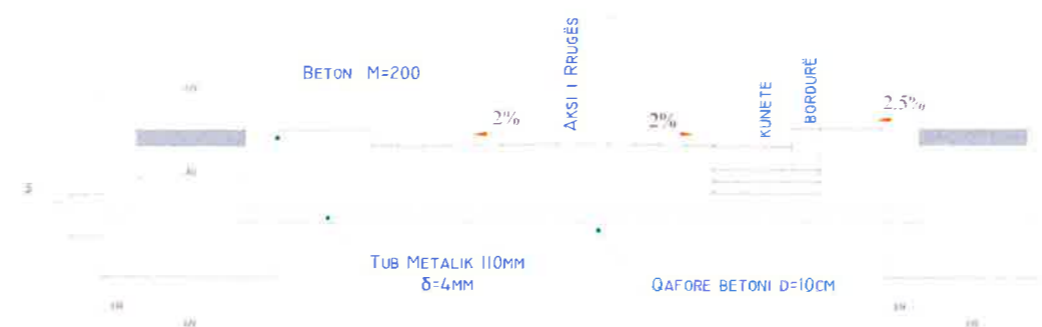

SHËNIME :

- GJATË REALIZIMIT TË INTERSEKTIMEVE KUOTA E VENDOSJES SË Pusetave PREJ GIZE MUND TË NDRYSHOJË SIPAS RASTIT
- TUBI MUND TË VENDOSËT ME NJË PJERRËSI TË LEHTË SIPAS NEVOJËS, POR GJITHNJË THELLËSIA E VENDOSJES DUHET TË JETË MË E VOGËL SE HMIN.=30CM NGA SIPERFAQJA E ASFALTIT.
- NE RASTET KUR DO TE INTERSEKTOHET TRUPI I RRUGES Kryesore, Pusetat DO TE NDERTOHEN ME DIMENSIONE I XIXIM

PRERJE GJATESORE Pusetes dhe Tubacionit NE PJESEN E GJELBERIMIT

Pusetes 40x40x40cm dhe HUMUSOR RERE E NGJESHUR

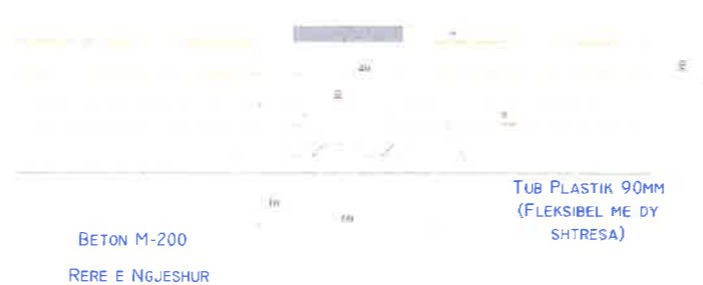

PRERJE GJATESORE E Tubacionit dhe Pusetave NE TROTUARE

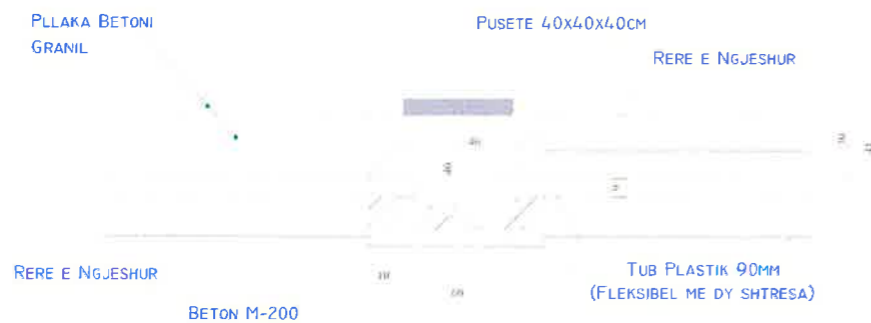

LEGJENDA

 TUB KARROGATO PER TELEFONINE

 TUB KARROGATO NDRICIMI DHE ELEKTRIKUN



BASHKIA KAMËZ

DREJTORIA E PROJEKTEVE DHE INVESTIMEVE
DEPARTAMENTI I PROJEKTEVE

Dr. e Projekteve e Investimeve FLORA MUCA

STAFI TEKNIK
PROJEKTUES

- Ing. ERBLIN LALA
- Ing. ARJOLA KURTI
- Ing. DENIS PRENÇI
- Ing. EGLANTINA DISHA
- Ing. RAMADAN HYSA

Titulli i Projektit
NDERTIM RRUGA "BETIM MUÇO"

Emertimi i Fletes
DETAJE NDRICIMI

Faza e Projektit
PROJEKT ZBATIMI

Data e Implementimit :

Shkalla e Vizatimit

Fleta Nr.

A-56

NDERTIM RRUGA: "BETIM MUÇO" PROFILE TERTHORE



Km.0+058.33

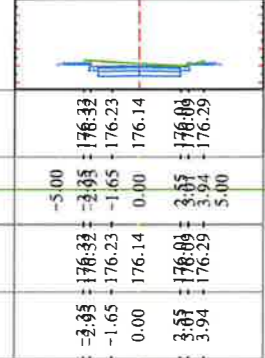

Kuota Terenit	-2.95	-1.65	0.00	3.65	3.94
Dist.Progressive	-5.00	-3.05	-1.65	0.00	3.65
Kuota Projektit	176.32	176.23	176.14	176.05	176.29
Dist.Progressive	-5.00	-3.05	-1.65	0.00	3.65

Km.0+035.09

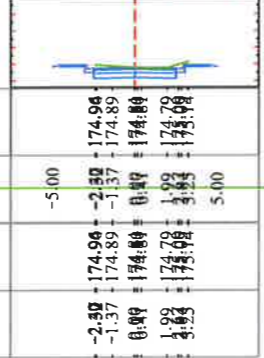

Kuota Terenit	-2.50	-1.37	0.00	1.89	3.63
Dist.Progressive	-5.00	-2.50	-1.37	0.00	1.89
Kuota Projektit	174.94	174.89	174.80	174.79	175.08
Dist.Progressive	-5.00	-2.50	-1.37	0.00	1.89

Km.0+000.00



Kuota Terenit	-2.33	-1.49	0.00	1.09	3.34
Dist.Progressive	-5.00	-2.33	-1.49	0.00	1.09
Kuota Projektit	172.86	172.36	172.55	172.68	172.67
Dist.Progressive	-5.00	-2.33	-1.49	0.00	1.09

Km.0+059.30

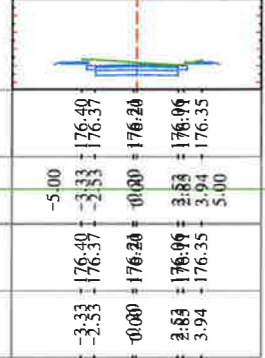

Kuota Terenit	-3.33	-2.33	0.00	3.83	3.94
Dist.Progressive	-5.00	-3.33	-2.33	0.00	3.83
Kuota Projektit	176.34	176.34	176.20	176.09	176.35
Dist.Progressive	-5.00	-3.33	-2.33	0.00	3.83

Km.0+035.29

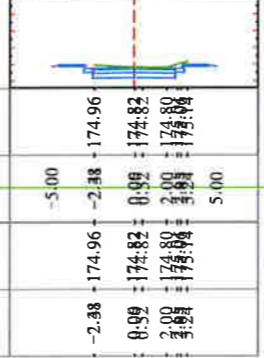

Kuota Terenit	-2.88	-0.92	0.00	2.00	3.64
Dist.Progressive	-5.00	-2.88	-0.92	0.00	2.00
Kuota Projektit	174.96	174.82	174.80	174.80	175.08
Dist.Progressive	-5.00	-2.88	-0.92	0.00	2.00

Km.0+003.18



Kuota Terenit	-4.26	-3.26	-0.09	1.76	3.38
Dist.Progressive	-5.00	-4.26	-3.26	-0.09	1.76
Kuota Projektit	172.54	172.80	172.71	172.73	172.69
Dist.Progressive	-5.00	-4.26	-3.26	-0.09	1.76

Km.0+060.00

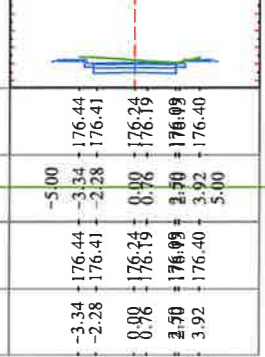

Kuota Terenit	-3.34	-2.28	0.00	3.50	3.92
Dist.Progressive	-5.00	-3.34	-2.28	0.00	3.50
Kuota Projektit	176.44	176.41	176.25	176.09	176.40
Dist.Progressive	-5.00	-3.34	-2.28	0.00	3.50

Km.0+035.49

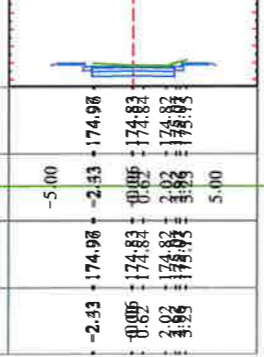

Kuota Terenit	-2.53	-0.06	0.02	3.63	3.63
Dist.Progressive	-5.00	-2.53	-0.06	0.02	3.63
Kuota Projektit	174.96	174.83	174.82	174.82	175.03
Dist.Progressive	-5.00	-2.53	-0.06	0.02	3.63

Km.0+005.29



Kuota Terenit	-3.89	-1.59	0.95	3.02	3.02
Dist.Progressive	-5.00	-3.89	-1.59	0.95	3.02
Kuota Projektit	172.89	172.80	172.74	172.75	172.85
Dist.Progressive	-5.00	-3.89	-1.59	0.95	3.02

BASHKIA KAMËZ

DREJTORIA E PROJEKTEVE DHE INVESTIMEVE
DEPARTAMENTI I PROJEKTEVE

Dr. e Projekteve e Investimeve	FLORA MUCA	6
STAFI TEKNIK PROJEKTES	Ing. ERLIN LALA	[Signature]
	Ing. ARJOLA KURTI	[Signature]
	Ing. DENIS PRENÇI	[Signature]
	Ing. EGLANTINA DISHA	[Signature]
	Ing. RAMADAN HYSA	[Signature]

Titulli i Projektit

NDERTIM RRUGA "BETIM MUÇO"

Emertimi i Fletës

PROFILE TERTHORE

Faza e Projektit

PROJEKT ZBATIMI

Data e Implementimit :

Shkalla e Vizatimit

Fleta Nr.

A-58

NDERTIM RRUGA: "BETIM MUÇO" PROFILE TERTHORE

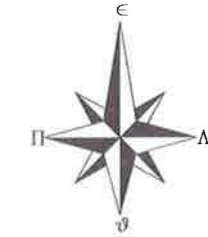

Km.0+152.27 (< > 11)

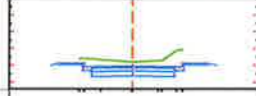

Kuota Terenit					
Dist.Progressive	-5.00	-3.83	-1.93	-0.00	5.00
Kuota Projektit		181.43	181.35	181.22	181.03
Dist.Progressive		-3.83	-1.93	1.59	3.67

Km.0+125.14 (< > 25)

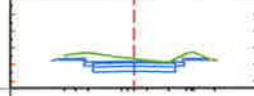

Kuota Terenit					
Dist.Progressive	-5.00	-4.23	-3.79	-0.77	5.00
Kuota Projektit		178.56	178.97	179.26	179.23
Dist.Progressive		-4.23	-3.79	0.79	3.88

Km.0+085.18 (< > 19)

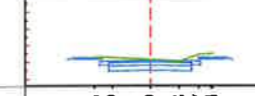

Kuota Terenit					
Dist.Progressive	-5.00	-3.34	-2.26	0.00	5.00
Kuota Projektit		177.33	177.29	177.19	177.43
Dist.Progressive		-3.34	-2.26	1.73	3.88

Km.0+152.82 (< > 12)

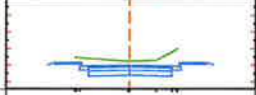

Kuota Terenit					
Dist.Progressive	-5.00	-3.89	-0.00	1.59	5.00
Kuota Projektit		181.46	181.24	181.32	181.80
Dist.Progressive		-3.89	0.00	1.59	3.88

Km.0+133.18 (< > 16)

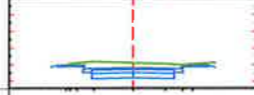

Kuota Terenit					
Dist.Progressive	-5.00	-4.84	-2.38	0.00	5.00
Kuota Projektit		180.04	180.19	180.12	180.14
Dist.Progressive		-4.84	-2.38	1.97	3.01

Km.0+100.00 (< > 20)

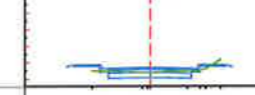

Kuota Terenit					
Dist.Progressive	-5.00	-3.47	-0.66	2.26	5.00
Kuota Projektit		177.51	177.43	177.54	178.21
Dist.Progressive		-3.47	-0.66	3.86	4.28

Km.0+153.37 (< > 13)

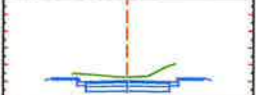

Kuota Terenit					
Dist.Progressive	-5.00	-3.83	-0.00	1.21	5.00
Kuota Projektit		181.45	181.26	181.32	181.85
Dist.Progressive		-3.83	0.00	1.21	2.87

Km.0+140.00 (< > 27)



Kuota Terenit					
Dist.Progressive	-5.00	-3.68	-2.65	-1.11	5.00
Kuota Projektit		180.43	180.43	180.48	180.82
Dist.Progressive		-3.68	-2.65	0.89	3.86

Km.0+110.51 (< > 21)



Kuota Terenit					
Dist.Progressive	-5.00	-3.59	-0.00	2.76	5.00
Kuota Projektit		178.38	177.92	177.97	178.79
Dist.Progressive		-3.59	0.00	3.88	3.86

BASHKIA KAMËZ

DREJTORIA E PROJEKTEVE DHE INVESTIMEVE
DEPARTAMENTI I PROJEKTEVE

Dr. e Projekteve e Investimeve	FLORA MUCA	6
STAFI TEKNIK PROJEKTES	Ing. ERLIN LALA	
	Ing. ARJOLA KURTI	
	Ing. DENIS PRENÇI	
	Ing. EGLANTINA DISHA	
	Ing. RAMADAN HYSA	
Titulli i Projektit NDERTIM RRUGA "BETIM MUÇO"		FAZA E PROJEKTI PROJEKT ZBATIMI
Emertimi i Fletes PROFILE TERTHORE		Data e Implementimit : Shkalla e Vizatimit Fleta Nr. A-59

NDERTIM RRUGA: "BETIM MUÇO" PROFILE TERTHORE

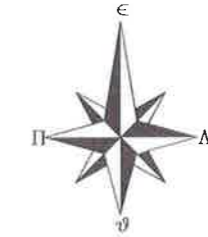

Km.0+062.30 (C/S 13)

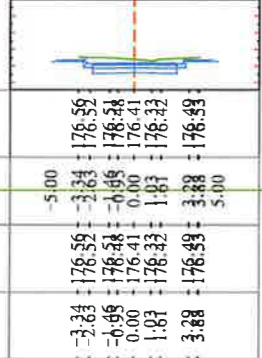

Kuota Terenit				
Dist.Progressive	-5.00	-3.34	176.52	176.41
Kuota Projektit				
Dist.Progressive		-3.34	176.52	176.41

Km.0+040.00 (C/S 10)



Kuota Terenit				
Dist.Progressive	-5.00	-2.86	175.70	175.33
Kuota Projektit				
Dist.Progressive		-2.86	175.70	175.33

Km.0+007.41 (C/S 1)



Kuota Terenit				
Dist.Progressive	-5.00	-3.77	172.94	172.90
Kuota Projektit				
Dist.Progressive		-3.77	172.94	172.90

Km.0+080.00 (C/S 17)

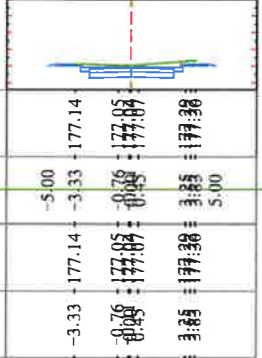

Kuota Terenit				
Dist.Progressive	-5.00	-3.33	177.14	177.05
Kuota Projektit				
Dist.Progressive		-3.33	177.14	177.05

Km.0+042.74 (C/S 11)

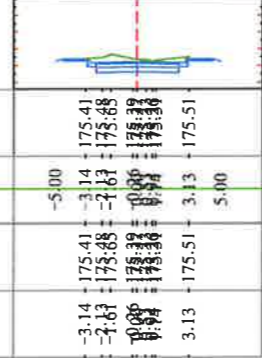

Kuota Terenit				
Dist.Progressive	-5.00	-3.14	175.41	175.68
Kuota Projektit				
Dist.Progressive		-3.14	175.41	175.68

Km.0+020.00 (C/S 5)



Kuota Terenit				
Dist.Progressive	-5.00	-3.09	173.49	173.46
Kuota Projektit				
Dist.Progressive		-3.09	173.49	173.46

Km.0+081.57 (C/S 17)

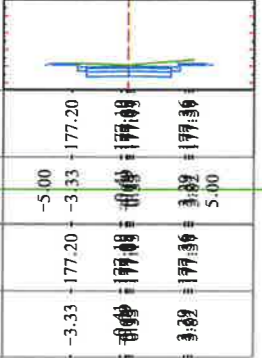

Kuota Terenit				
Dist.Progressive	-5.00	-3.33	177.20	177.09
Kuota Projektit				
Dist.Progressive		-3.33	177.20	177.09

Km.0+057.35 (C/S 12)

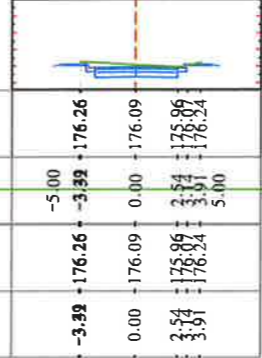

Kuota Terenit				
Dist.Progressive	-5.00	-3.99	176.26	176.09
Kuota Projektit				
Dist.Progressive		-3.99	176.26	176.09

Km.0+029.42 (C/S 6)

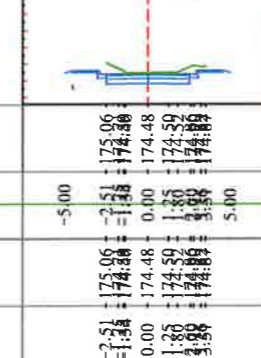

Kuota Terenit				
Dist.Progressive	-5.00	-2.51	175.06	174.48
Kuota Projektit				
Dist.Progressive		-2.51	175.06	174.48

BASHKIA KAMËZ

DREJTORIA E PROJEKTEVE DHE INVESTIMEVE
DEPARTAMENTI I PROJEKTEVE

Dr. e Projekteve e Investimeve	FLORA MUCA	6
STAFI TEKNIK PROJEKTES	Ing. ERBLIN LALA	
	Ing. ARJOLA KURTI	
	Ing. DENIS PRENÇI	
	Ing. EGLANTINA DISHA	
	Ing. RAMADAN HYSA	
Titulli i Projektit NDERTIM RRUGA "BETIM MUÇO"		Faza e Projektit PROJEKT ZBATIMI
Emertimi i Fletes PROFILE TERTHORE		Shkalla e Vizatimit Flota Nr. A-60

NDERTIM RRUGA: "BETIM MUÇO" PROFILE TERTHORE



Km.0+062.30 (C > 16)

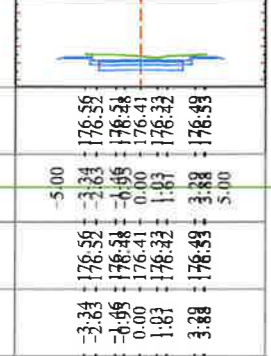

Kuota Terenit	
Dist.Progressive	-5.00
Kuota Projektit	
Dist.Progressive	5.00

Km.0+040.00 (C > 10)

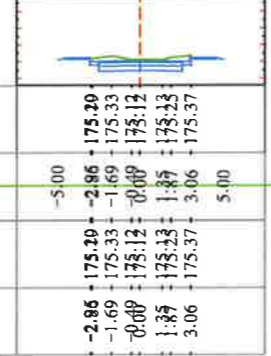

Kuota Terenit	
Dist.Progressive	-5.00
Kuota Projektit	
Dist.Progressive	5.00

Km.0+007.41 (C > 1)



Kuota Terenit	
Dist.Progressive	-5.00
Kuota Projektit	
Dist.Progressive	5.00

Km.0+080.00 (C > 17)

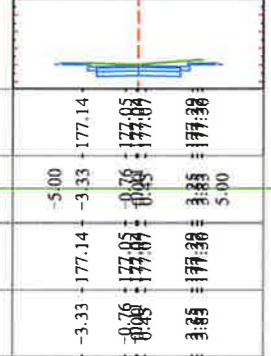

Kuota Terenit	
Dist.Progressive	-5.00
Kuota Projektit	
Dist.Progressive	5.00

Km.0+042.74 (C > 11)

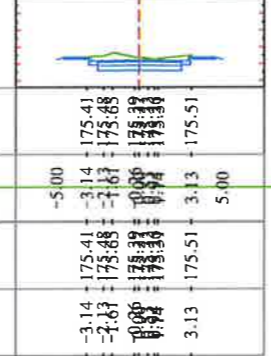

Kuota Terenit	
Dist.Progressive	-5.00
Kuota Projektit	
Dist.Progressive	5.00

Km.0+020.00



Kuota Terenit	
Dist.Progressive	-5.00
Kuota Projektit	
Dist.Progressive	5.00

Km.0+081.57 (C > 18)

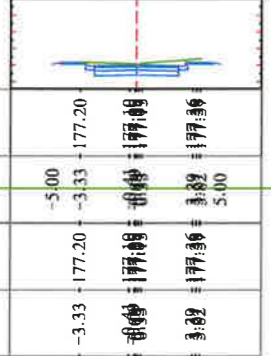

Kuota Terenit	
Dist.Progressive	-5.00
Kuota Projektit	
Dist.Progressive	5.00

Km.0+057.35 (C > 12)

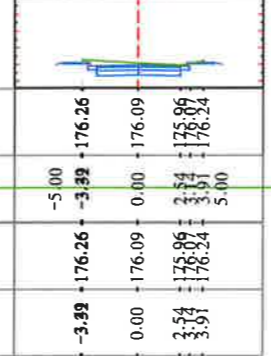

Kuota Terenit	
Dist.Progressive	-5.00
Kuota Projektit	
Dist.Progressive	5.00

Km.0+029.42 (C > 6)

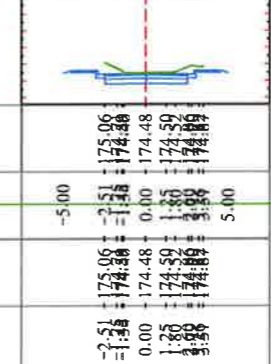

Kuota Terenit	
Dist.Progressive	-5.00
Kuota Projektit	
Dist.Progressive	5.00

BASHKIA KAMËZ

DREJTORIA E PROJEKTEVE DHE INVESTIMEVE
DEPARTAMENTI I PROJEKTEVE

Dr. e Projekteve e Investimeve	FLORA MUCA	
STAFI TEKNIK PROJEKTES	Ing. ERBLIN LALA	
	Ing. ARJOLA KURTI	
	Ing. DENIS PRENÇI	
	Ing. EGLANTINA DISHA	
	Ing. RAMADAN HYSA	
Titulli i Projektit NDERTIM RRUGA "BETIM MUÇO"		Faza e Projektit PROJEKT ZBATIMI
Emertimi i Fletes PROFILE TERTHORE		Data e Implementimit : Shkalla e Vizatimit Fleta Nr. A-61

NDERTIM RRUGA: "BETIM MUÇO" PROFILE TERTHORE



Km.0+216.47 (CS 15)

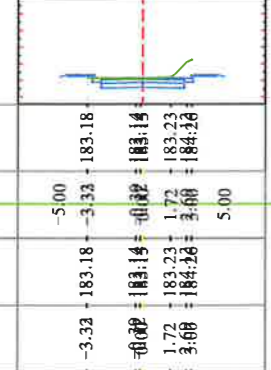

Kuota Terenit	
Dist.Progresive	-5.00
Kuota Projektit	
Dist.Progresive	5.00

Km.0+190.50 (CS 13)

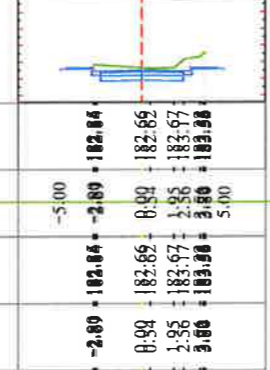

Kuota Terenit	
Dist.Progresive	-5.00
Kuota Projektit	
Dist.Progresive	5.00

Km.0+170.95 (CS 12)

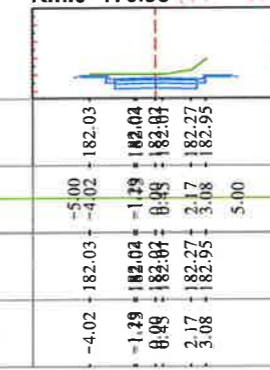

Kuota Terenit	
Dist.Progresive	-5.00
Kuota Projektit	
Dist.Progresive	5.00

Km.0+220.00 (CS 10)

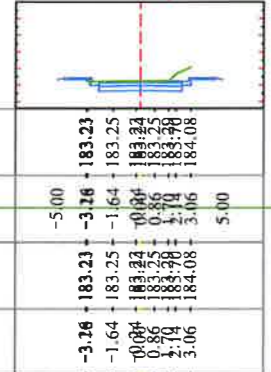

Kuota Terenit	
Dist.Progresive	-5.00
Kuota Projektit	
Dist.Progresive	5.00

Km.0+200.00 (CS 11)

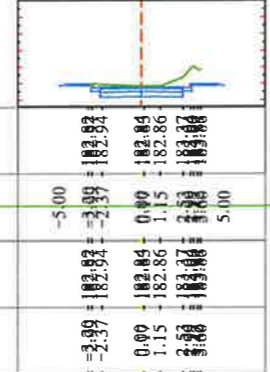

Kuota Terenit	
Dist.Progresive	-5.00
Kuota Projektit	
Dist.Progresive	5.00

Km.0+171.89 (CS 13)

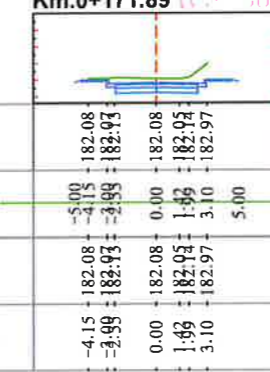

Kuota Terenit	
Dist.Progresive	-5.00
Kuota Projektit	
Dist.Progresive	5.00

Km.0+240.00 (CS 14)

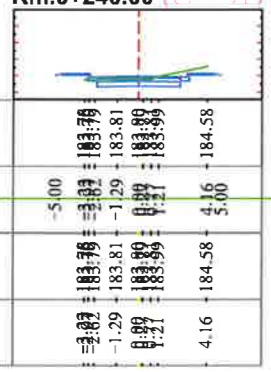

Kuota Terenit	
Dist.Progresive	-5.00
Kuota Projektit	
Dist.Progresive	5.00

Km.0+203.73 (CS 15)

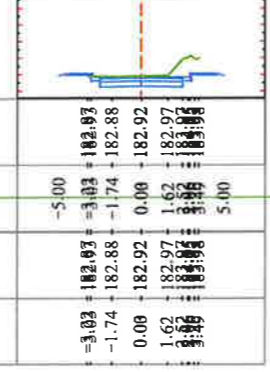

Kuota Terenit	
Dist.Progresive	-5.00
Kuota Projektit	
Dist.Progresive	5.00

Km.0+180.00 (CS 10)

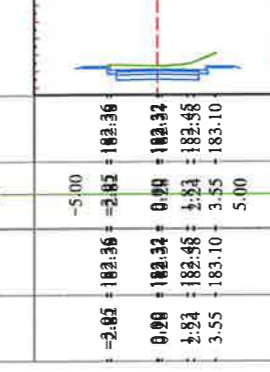

Kuota Terenit	
Dist.Progresive	-5.00
Kuota Projektit	
Dist.Progresive	5.00

BASHKIA KAMËZ

DREJTORIA E PROJEKTEVE DHE INVESTIMEVE
DEPARTAMENTI I PROJEKTEVE

Dr. e Projekteve e Investimeve	FLORA MUCA	<i>[Signature]</i>
STAFI TEKNIK PROJEKTES	Ing. ERBLIN LALA	<i>[Signature]</i>
	Ing. ARJOLA KURTI	<i>[Signature]</i>
	Ing. DENIS PRENÇI	<i>[Signature]</i>
	Ing. EGLANTINA DISHA	<i>[Signature]</i>
	Ing. RAMADAN HYSA	<i>[Signature]</i>
Titulli i Projektit NDERTIM RRUGA "BETIM MUÇO"		Faza e Projektit PROJEKT ZBATIMI
Emeritimi i Fietes PROFILE TERTHORE		Data e Implementimit: Shkalla e Vizatimit Fleta Nr. A-62

NDERTIM RRUGA: "BETIM MUÇO" PROFILE TERTHORE

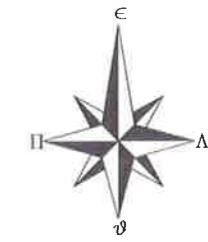

Km.0+300.00 (1.7 15.2)

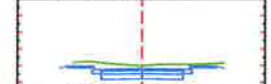

Kuota Terenit	188.26	188.10	188.09	188.06	188.16
Dist.Progressive	-5.00	-3.98	-1.74	-0.02	1.12
Kuota Projektit	188.26	188.10	188.09	188.06	188.16
Dist.Progressive	-4.96	-3.96	-1.74	-0.02	1.12

Km.0+280.00 (1.7 15.2)



Kuota Terenit	186.29	186.15	186.15	186.15	186.15
Dist.Progressive	-5.99	-3.45	0.00	3.94	3.60
Kuota Projektit	186.29	186.15	186.15	186.15	186.15
Dist.Progressive	-4.53	-3.45	0.00	3.94	3.60

Km.0+251.11 (1.7 15.2)

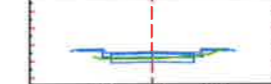

Kuota Terenit	184.99	184.74	184.18	184.42	184.76
Dist.Progressive	-5.00	-3.45	0.99	3.42	3.00
Kuota Projektit	184.99	184.74	184.18	184.42	184.76
Dist.Progressive	-3.45	-2.45	0.99	3.42	3.00

Km.0+300.15 (1.7 15.2)

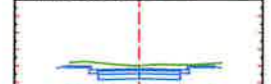

Kuota Terenit	188.28	188.11	188.10	188.07	188.15
Dist.Progressive	-5.00	-3.36	-1.63	-0.02	1.02
Kuota Projektit	188.28	188.11	188.10	188.07	188.15
Dist.Progressive	-4.96	-3.36	-1.63	-0.02	1.02

Km.0+284.08 (1.7 15.2)



Kuota Terenit	186.57	186.53	186.51	186.44	186.45
Dist.Progressive	-5.99	-2.90	0.99	2.08	3.56
Kuota Projektit	186.57	186.53	186.51	186.44	186.45
Dist.Progressive	-4.96	-2.90	0.99	2.08	3.56

Km.0+260.00 (1.7 15.2)

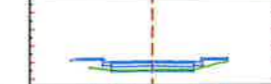

Kuota Terenit	184.68	184.52	184.51	184.53	184.57
Dist.Progressive	-5.00	-3.87	-2.44	-1.52	2.60
Kuota Projektit	184.68	184.52	184.51	184.53	184.57
Dist.Progressive	-3.87	-2.44	-1.52	0.00	2.60

Km.0+302.24 (1.7 15.2)

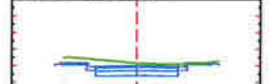

Kuota Terenit	188.24	188.13	188.12	188.27	
Dist.Progressive	-5.00	-0.92	1.11	3.99	5.00
Kuota Projektit	188.24	188.13	188.12	188.27	
Dist.Progressive	-4.69	-0.92	1.11	3.99	5.00

Km.0+286.40 (1.7 15.2)



Kuota Terenit	186.86	186.74	186.74	186.85	186.87
Dist.Progressive	-5.99	-1.68	1.68	3.61	3.00
Kuota Projektit	186.86	186.74	186.74	186.85	186.87
Dist.Progressive	-4.67	-1.68	1.68	3.61	3.00

Km.0+260.26 (1.7 15.2)



Kuota Terenit	184.68	184.54	184.53	184.59	184.93
Dist.Progressive	-5.00	-3.89	-2.62	-1.23	2.40
Kuota Projektit	184.68	184.54	184.53	184.59	184.93
Dist.Progressive	-3.89	-2.62	-1.23	0.00	2.40

BASHKIA KAMËZ

DREJTORIA E PROJEKTEVE DHE INVESTIMEVE
DEPARTAMENTI I PROJEKTEVE

Dr. e Projekteve e Investimeve	FLORA MUCA	
STAFI TEKNIK PROJEKTES	Ing. ERBLIN LALA	
	Ing. ARJOLA KURTI	
	Ing. DENIS PRENÇI	
	Ing. EGLANTINA DISHA	
	Ing. RAMADAN HYSA	
Titulli i Projektit NDERTIM RRUGA "BETIM MUÇO"		Faza e Projektit PROJEKT ZBATIMI
Emeritimi i Fletes PROFILE TERTHORE		Data e Implementimit : Shkalla e Vizatimit Fleta Nr. A-63

NDERTIM RRUGA: "BETIM MUÇO" PROFILE TERTHORE

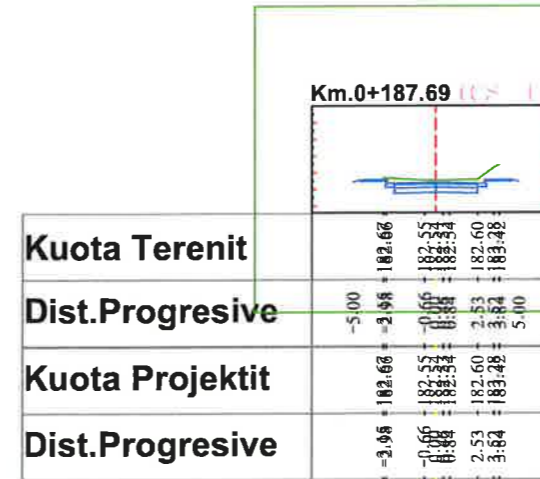
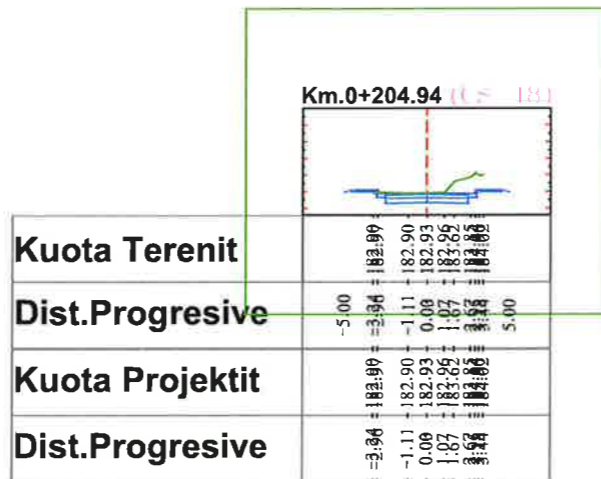
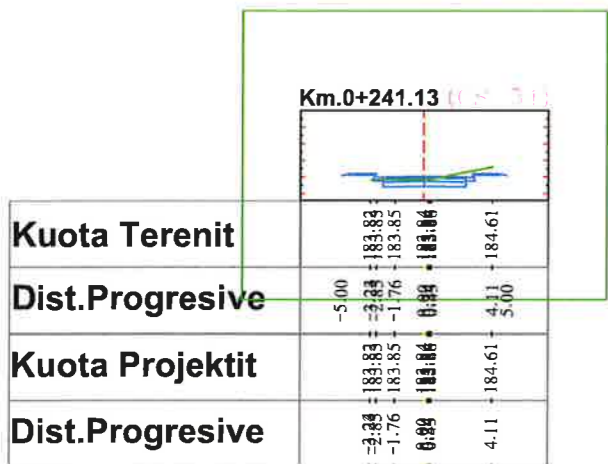
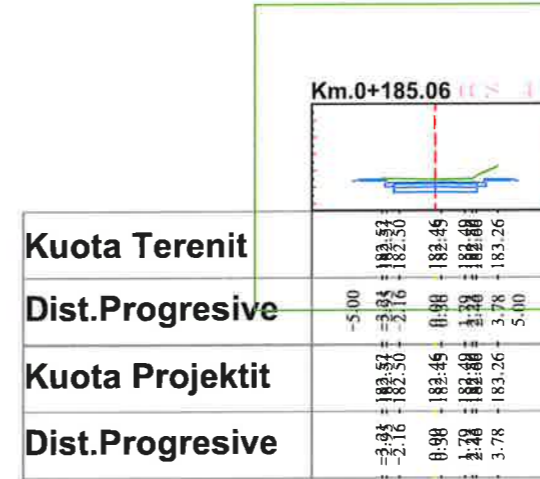
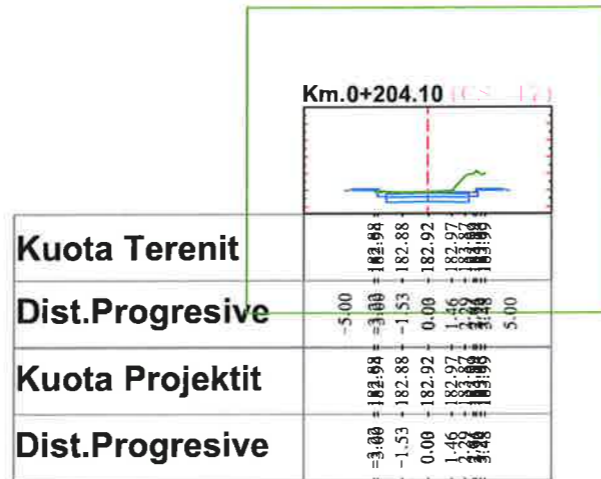
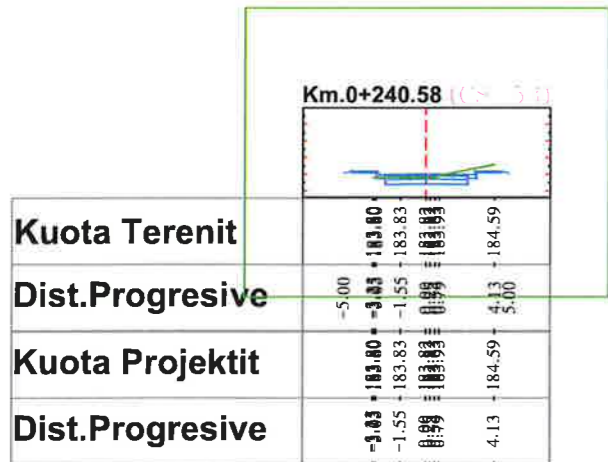
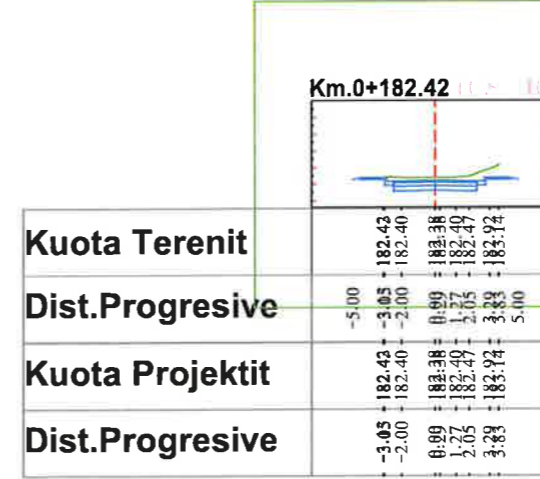
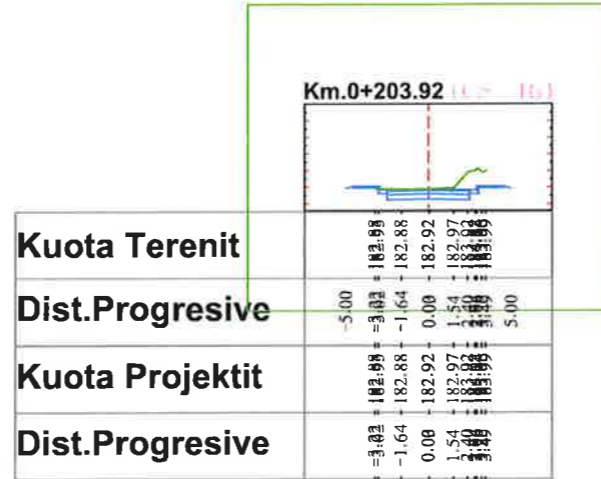
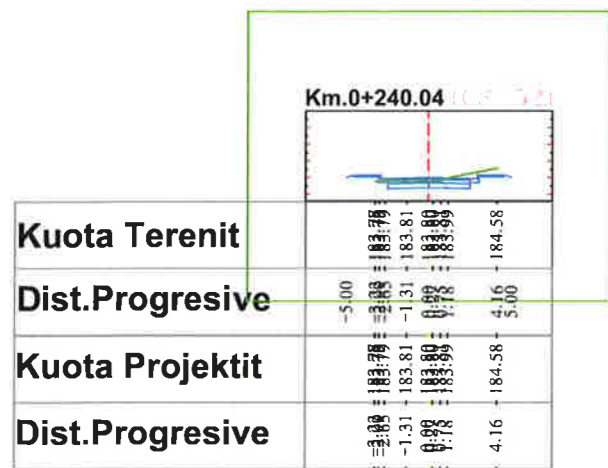

BASHKIA KAMËZ

DREJTORIA E PROJEKTEVE DHE INVESTIMEVE
DEPARTAMENTI I PROJEKTEVE

Dr. e Projekteve e Investimeve	FLORA MUCA										
STAFI TEKNIK PROJEKTES	<table border="1" style="width: 100%; font-size: x-small;"> <tr><td style="width: 20%;">Ing.</td><td>ERBLIN LALA</td></tr> <tr><td>Ing.</td><td>ARJOLA KURTI</td></tr> <tr><td>Ing.</td><td>DENIS PRENÇI</td></tr> <tr><td>Ing.</td><td>EGLANTINA DISHA</td></tr> <tr><td>Ing.</td><td>RAMADAN HYSA</td></tr> </table>	Ing.	ERBLIN LALA	Ing.	ARJOLA KURTI	Ing.	DENIS PRENÇI	Ing.	EGLANTINA DISHA	Ing.	RAMADAN HYSA
Ing.	ERBLIN LALA										
Ing.	ARJOLA KURTI										
Ing.	DENIS PRENÇI										
Ing.	EGLANTINA DISHA										
Ing.	RAMADAN HYSA										
Titulli i Projektit	NDERTIM RRUGA "BETIM MUÇO"										
Faza e Projektit	PROJEKT ZBATIMI										
Emertimi i Fletes	PROFILE TERTHORE										
Data e Implementimit :											
Shkalla e Vizatimit											
Fleta Nr.	A-64										

NDERTIM RRUGA: "BETIM MUÇO" PROFILE TERTHORE



Km.0+320.00 (C> 50)

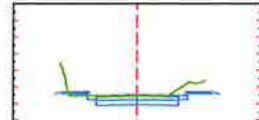

Kuota Terenit	189.46	189.46	189.46	189.46
Dist.Progressive	0.00	0.00	0.00	5.00
Kuota Projektit	189.46	189.46	189.46	189.46
Dist.Progressive	0.00	0.00	0.00	5.00

Km.0+288.72 (C> 61)

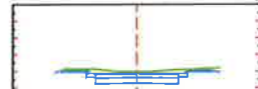

Kuota Terenit	187.15	187.14	187.14	187.15
Dist.Progressive	-4.96	-2.61	-1.18	0.00
Kuota Projektit	187.15	187.14	187.14	187.15
Dist.Progressive	-4.96	-2.61	-1.18	0.00

Km.0+260.86 (C> 51)



Kuota Terenit	184.69	184.58	184.57	184.59
Dist.Progressive	-3.91	-2.96	-1.03	0.00
Kuota Projektit	184.69	184.58	184.57	184.59
Dist.Progressive	-3.91	-2.96	-1.03	0.00

Km.0+326.01 (C> 71)

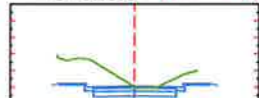

Kuota Terenit	181.98	181.97	181.96	181.96
Dist.Progressive	-4.67	-2.51	-1.47	0.00
Kuota Projektit	181.98	181.97	181.96	181.96
Dist.Progressive	-4.67	-2.51	-1.47	0.00

Km.0+298.05 (C> 63)

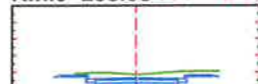

Kuota Terenit	187.88	187.96	187.96	187.88
Dist.Progressive	-3.63	-2.51	-1.47	0.00
Kuota Projektit	187.88	187.96	187.96	187.88
Dist.Progressive	-3.63	-2.51	-1.47	0.00

Km.0+261.47 (C> 73)

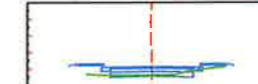

Kuota Terenit	184.79	184.62	184.62	184.67
Dist.Progressive	-3.97	-0.81	1.43	4.44
Kuota Projektit	184.79	184.62	184.62	184.67
Dist.Progressive	-3.97	-0.81	1.43	4.44

Km.0+326.66 (C> 72)

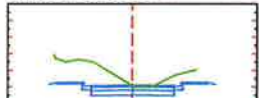

Kuota Terenit	181.94	181.92	181.92	181.98
Dist.Progressive	-4.60	-3.40	-2.56	0.00
Kuota Projektit	181.94	181.92	181.92	181.98
Dist.Progressive	-4.60	-3.40	-2.56	0.00

Km.0+298.62 (C> 65)



Kuota Terenit	188.08	188.08	188.04	188.14
Dist.Progressive	-3.94	-2.65	-0.07	2.08
Kuota Projektit	188.08	188.08	188.04	188.14
Dist.Progressive	-3.94	-2.65	-0.07	2.08

Km.0+269.50 (C> 60)

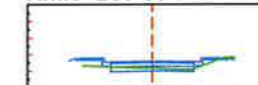

Kuota Terenit	185.35	185.18	185.12	185.80
Dist.Progressive	-4.17	-0.67	1.47	3.85
Kuota Projektit	185.35	185.18	185.12	185.80
Dist.Progressive	-4.17	-0.67	1.47	3.85

BASHKIA KAMËZ

DREJTORIA E PROJEKTEVE DHE INVESTIMEVE
DEPARTAMENTI I PROJEKTEVE

Dr. e Projekteve e Investimeve	FLORA MUCA										
<table border="1" style="width: 100%; border-collapse: collapse;"> <tr> <td style="width: 20px;">Ing.</td> <td>ERBLIN LALA</td> </tr> <tr> <td>Ing.</td> <td>ARJOLA KURTI</td> </tr> <tr> <td>Ing.</td> <td>DENIS PRENÇI</td> </tr> <tr> <td>Ing.</td> <td>EGLANTINA DISHA</td> </tr> <tr> <td>Ing.</td> <td>RAMADAN HYSA</td> </tr> </table>	Ing.	ERBLIN LALA	Ing.	ARJOLA KURTI	Ing.	DENIS PRENÇI	Ing.	EGLANTINA DISHA	Ing.	RAMADAN HYSA	
Ing.	ERBLIN LALA										
Ing.	ARJOLA KURTI										
Ing.	DENIS PRENÇI										
Ing.	EGLANTINA DISHA										
Ing.	RAMADAN HYSA										
Titulli i Projektit NDERTIM RRUGA "BETIM MUÇO"											
Faza e Projektit PROJEKT ZBATIMI											
Data e Implementimit :											
Shkalla e Vizatimit											
Emertimi i Fletes PROFILE TERTHORE											
Fleta Nr. A-65											

NDERTIM RRUGA: "BETIM MUÇO" PROFILE TERTHORE

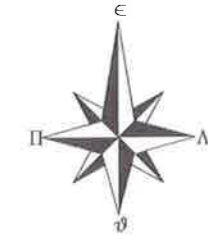

Km.0+380.00 (C > 83)

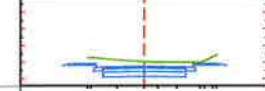

Kuota Terenit					
Dist.Progressive	-5.00	-3.43	-1.66	0.00	1.99
Kuota Projektit	195.29	195.15	195.05	195.00	195.00
Dist.Progressive	-3.43	-1.66	0.00	1.99	3.00

Km.0+348.66 (C > 80)

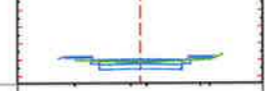

Kuota Terenit					
Dist.Progressive	-5.00	-3.98	0.00	3.59	5.00
Kuota Projektit	191.98	191.85	191.85	192.03	192.35
Dist.Progressive	-3.98	0.00	3.59	5.00	

Km.0+327.31 (C > 77)

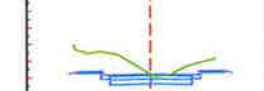

Kuota Terenit					
Dist.Progressive	-5.00	-3.83	-2.03	0.00	2.20
Kuota Projektit	191.94	191.56	191.36	190.04	190.65
Dist.Progressive	-3.83	-2.03	0.00	2.20	3.02

Km.0+398.32 (C > 86)

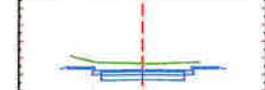

Kuota Terenit					
Dist.Progressive	-5.00	-4.75	-2.17	0.00	3.92
Kuota Projektit	196.03	195.75	195.63	195.74	195.74
Dist.Progressive	-4.75	-2.17	0.00	3.92	5.00

Km.0+360.00 (C > 80)



Kuota Terenit					
Dist.Progressive	-5.00	-3.09	-2.06	0.00	2.71
Kuota Projektit	193.10	193.06	193.06	193.12	193.42
Dist.Progressive	-3.09	-2.06	0.00	2.71	4.08

Km.0+339.41 (C > 71)

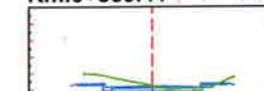

Kuota Terenit					
Dist.Progressive	-5.00	-3.19	0.00	1.70	3.56
Kuota Projektit	191.83	191.23	191.08	191.14	191.66
Dist.Progressive	-3.19	0.00	1.70	3.56	4.66

Km.0+400.00 (C > 82)

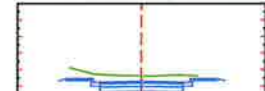

Kuota Terenit					
Dist.Progressive	-5.00	-2.85	-1.95	0.00	2.15
Kuota Projektit	196.03	195.74	195.68	195.67	195.63
Dist.Progressive	-2.85	-1.95	0.00	2.15	3.35

Km.0+369.93 (C > 81)

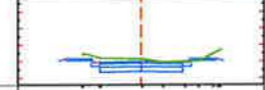

Kuota Terenit					
Dist.Progressive	-5.00	-3.56	-2.82	0.00	1.35
Kuota Projektit	194.39	194.20	194.15	194.02	194.05
Dist.Progressive	-3.56	-2.82	0.00	1.35	2.69

Km.0+340.00 (C > 73)



Kuota Terenit					
Dist.Progressive	-5.00	-4.10	-2.61	0.00	0.86
Kuota Projektit	192.00	191.82	191.28	191.15	191.21
Dist.Progressive	-4.10	-2.61	0.00	0.86	3.71

BASHKIA KAMËZ

DREJTORIA E PROJEKTEVE DHE INVESTIMEVE
DEPARTAMENTI I PROJEKTEVE

Dr. e Projekteve e Investimeve		FLORA MUCA	<i>[Signature]</i>
STAFI TEKNIK PROJEKTES	Ing.	ERBLIN LALA	<i>[Signatures]</i>
	Ing.	ARJOLA KURTI	
	Ing.	DENIS PRENÇI	
	Ing.	EGLANTINA DISHA	
	Ing.	RAMADAN HYSA	
Titulli i Projektit		NDERTIM RRUGA "BETIM MUÇO"	
Emertimi i Fletes		PROFILE TERTHORE	
Faza e Projektit		PROJEKT ZBATIMI	
Data e Implementimit :			
Shkalla e Vizatimit			
Fleta Nr.		A-66	

NDERTIM RRUGA: "BETIM MUÇO" PROFILE TERTHORE



Km.0+540.00 (C > 10%)

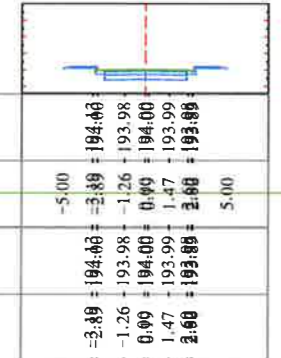

Kuota Terenit					
Dist.Progressive	-5.00	-3.89	194.46	193.98	5.00
Kuota Projektit					
Dist.Progressive	-3.89	194.46	-1.26	194.00	193.99
			0.99	1.47	2.60

Km.0+447.94 (C > 9%)

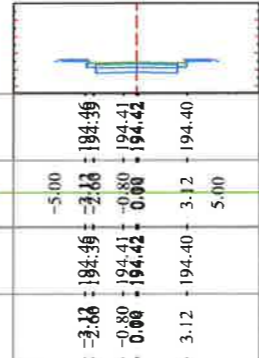

Kuota Terenit					
Dist.Progressive	-5.00	-2.63	194.36	194.41	5.00
Kuota Projektit					
Dist.Progressive	-2.63	194.36	-0.80	194.42	3.12
			0.00	194.40	5.00

Km.0+409.66 (C > 9%)

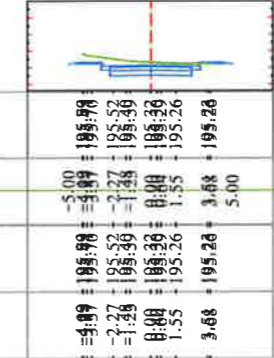

Kuota Terenit					
Dist.Progressive	-5.00	-3.04	195.98	195.32	5.00
Kuota Projektit					
Dist.Progressive	-3.04	195.98	-2.27	195.36	0.00
			0.00	195.26	3.68

Km.0+548.28 (C > 10%)

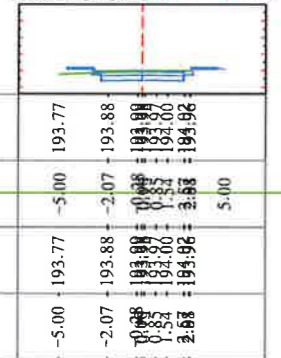

Kuota Terenit					
Dist.Progressive	-5.00	193.77	193.88	193.88	5.00
Kuota Projektit					
Dist.Progressive	-5.00	193.77	-2.07	193.88	0.00
			0.00	193.85	2.68

Km.0+460.00 (C > 9%)

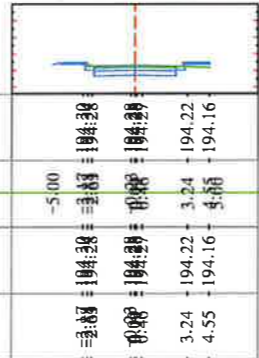

Kuota Terenit					
Dist.Progressive	-5.00	-3.63	194.38	194.22	5.00
Kuota Projektit					
Dist.Progressive	-3.63	194.38	0.00	194.16	3.24
			0.00	194.16	4.55

Km.0+420.00 (C > 9%)



Kuota Terenit					
Dist.Progressive	-5.00	-3.63	195.12	194.92	5.00
Kuota Projektit					
Dist.Progressive	-3.63	195.12	-2.37	194.92	1.87
			0.00	194.89	3.88

Km.0+555.68 (C > 10%)

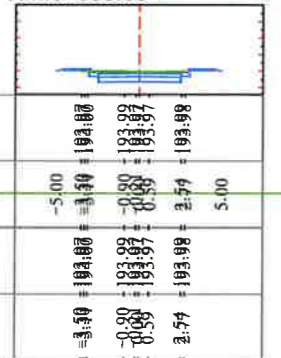

Kuota Terenit					
Dist.Progressive	-5.00	-3.49	194.00	193.99	5.00
Kuota Projektit					
Dist.Progressive	-3.49	194.00	-0.90	193.97	0.00
			0.00	193.99	2.54

Km.0+462.84 (C > 9%)

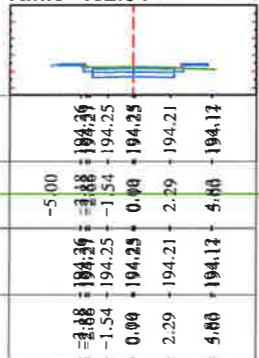

Kuota Terenit					
Dist.Progressive	-5.00	-3.68	194.29	194.25	5.00
Kuota Projektit					
Dist.Progressive	-3.68	194.29	-1.54	194.25	0.00
			0.00	194.21	2.29

Km.0+430.19 (C > 9%)

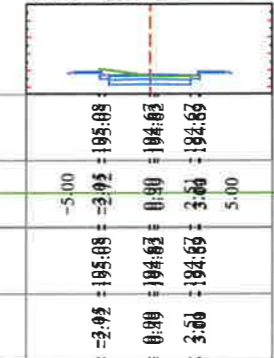

Kuota Terenit					
Dist.Progressive	-5.00	-2.92	195.09	194.82	5.00
Kuota Projektit					
Dist.Progressive	-2.92	195.09	-0.90	194.82	0.00
			0.00	194.66	3.60

BASHKIA KAMËZ

DREJTORIA E PROJEKTEVE DHE INVESTIMEVE
DEPARTAMENTI I PROJEKTEVE

Dr. e Projekteve e Investimeve	FLORA MUCA	
STAFI TEKNIK PROJEKTES	Ing. ERBLIN LALA Ing. ARJOLA KURTI Ing. DENIS PRENÇI Ing. EGLANTINA DISHA Ing. RAMADAN HYSA	
Titulli i Projektit		Faza e Projektit
NDERTIM RRUGA "BETIM MUÇO"		PROJEKT ZBATIMI
Emertimi i Fletes		Data e Implementimit :
PROFILE TERTHORE		Shkalla e Vizatimit
		Fleta Nr.
		A-67

NDERTIM RRUGA: "BETIM MUÇO" PROFILE TERTHORE



Km.0+400.00 (C/S 87)

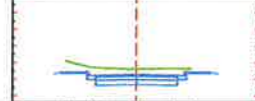

Kuota Terenit	196.99 195.74 195.68
Dist.Progressive	-4.00 -2.85 -1.95
Kuota Projektit	196.99 195.74 195.68
Dist.Progressive	-4.00 -2.85 -1.95

Km.0+369.93 (C/S 81)

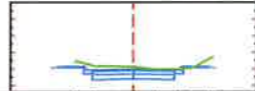

Kuota Terenit	194.38 194.20 194.15
Dist.Progressive	-3.56 -2.32 0.08
Kuota Projektit	194.38 194.20 194.15
Dist.Progressive	-3.56 -2.32 0.08

Km.0+340.00 (C/S 53)

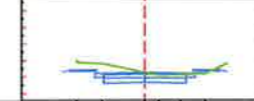

Kuota Terenit	192.00 191.11 191.15
Dist.Progressive	-4.10 -2.61 0.00
Kuota Projektit	192.00 191.11 191.15
Dist.Progressive	-4.10 -2.61 0.00

Km.0+403.95 (C/S 88)

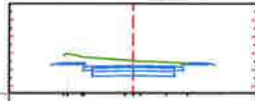

Kuota Terenit	185.87 185.78 185.59
Dist.Progressive	-4.00 -3.00 0.00
Kuota Projektit	185.87 185.78 185.59
Dist.Progressive	-4.00 -3.00 0.00

Km.0+376.67 (C/S 82)

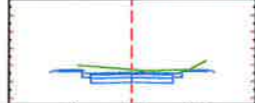

Kuota Terenit	194.98 194.75 194.66
Dist.Progressive	-3.30 0.00 0.77
Kuota Projektit	194.98 194.75 194.66
Dist.Progressive	-3.30 0.00 0.77

Km.0+344.46 (C/S 76)

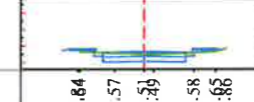

Kuota Terenit	191.64 191.57 191.58
Dist.Progressive	-3.03 -1.79 0.98
Kuota Projektit	191.64 191.57 191.58
Dist.Progressive	-3.03 -1.79 0.98

Km.0+407.41 (C/S 89)

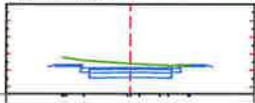

Kuota Terenit	195.08 195.60 195.47
Dist.Progressive	-4.00 -2.82 0.00
Kuota Projektit	195.08 195.60 195.47
Dist.Progressive	-4.00 -2.82 0.00

Km.0+378.27 (C/S 81)

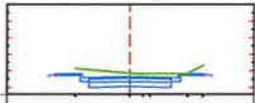

Kuota Terenit	195.18 194.85 194.83
Dist.Progressive	-3.30 0.00 1.22
Kuota Projektit	195.18 194.85 194.83
Dist.Progressive	-3.30 0.00 1.22

Km.0+348.06 (C/S 77)

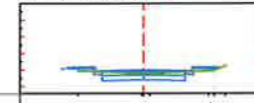

Kuota Terenit	191.94 191.79 191.96
Dist.Progressive	-3.99 0.00 3.00
Kuota Projektit	191.94 191.79 191.96
Dist.Progressive	-3.99 0.00 3.00

BASHKIA KAMËZ

DREJTORIA E PROJEKTEVE DHE INVESTIMEVE
DEPARTAMENTI I PROJEKTEVE

Dr. e Projekteve e Investimeve	FLORA MUCA	
STAFI TEKNIK PROJEKTES	Ing. ERBLIN LALA	
	Ing. ARJOLA KURTI	
	Ing. DENIS PRENÇI	
	Ing. EGLANTINA DISHA	
	Ing. RAMADAN HYSA	
Titulli i Projektit NDERTIM RRUGA "BETIM MUÇO"		Faza e Projektit PROJEKT ZBATIMI
Emertimi i Fletes PROFILE TERTHORE		Data e Implementimit : Shkalla e Vizatimit Fieta Nr. A-68

NDERTIM RRUGA: "BETIM MUÇO" PROFILE TERTHORE



Km.0+560.00 (CZ=106)

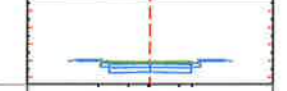

Kuota Terenit				
Dist.Progressive	-5.00	-3.15	193.99	5.00
Kuota Projektit		193.99	193.95	193.96
Dist.Progressive		-3.15	-0.00	1.89

Km.0+480.00 (CZ=100)

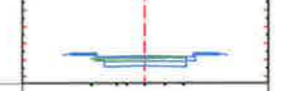

Kuota Terenit				
Dist.Progressive	-5.00	-3.23	194.06	5.00
Kuota Projektit		194.06	194.08	194.09
Dist.Progressive		-3.23	-1.78	1.22

Km.0+431.04 (CZ=91)

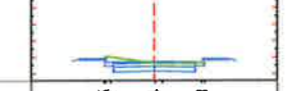

Kuota Terenit				
Dist.Progressive	-5.00	-2.86	194.67	5.00
Kuota Projektit		194.67	194.68	194.68
Dist.Progressive		-2.86	0.99	3.92

Km.0+580.00 (CZ=103)



Kuota Terenit				
Dist.Progressive	-5.00	-3.45	193.74	5.00
Kuota Projektit		193.74	193.79	193.89
Dist.Progressive		-3.45	0.00	2.97

Km.0+500.00 (CZ=101)

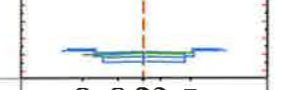

Kuota Terenit				
Dist.Progressive	-5.00	-3.71	194.00	5.00
Kuota Projektit		194.00	194.09	194.11
Dist.Progressive		-3.71	-1.57	2.86

Km.0+431.89 (CZ=95)

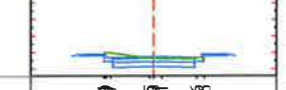

Kuota Terenit				
Dist.Progressive	-5.00	-2.86	194.67	5.00
Kuota Projektit		194.67	194.68	194.68
Dist.Progressive		-2.86	0.99	3.92

Km.0+600.00 (CZ=108)

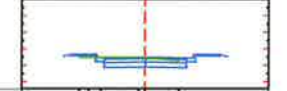

Kuota Terenit				
Dist.Progressive	-5.00	-4.01	193.50	5.00
Kuota Projektit		193.50	193.43	193.30
Dist.Progressive		-4.01	0.00	2.08

Km.0+520.00 (CZ=102)

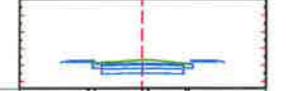

Kuota Terenit				
Dist.Progressive	-5.00	-2.88	194.16	5.00
Kuota Projektit		194.16	194.33	194.09
Dist.Progressive		-2.88	0.94	2.60

Km.0+440.00 (CZ=96)

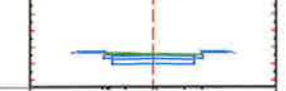

Kuota Terenit				
Dist.Progressive	-5.00	-2.89	194.69	5.00
Kuota Projektit		194.69	194.56	194.53
Dist.Progressive		-2.89	1.92	3.01

BASHKIA KAMËZ

DREJTORIA E PROJEKTEVE DHE INVESTIMEVE
DEPARTAMENTI I PROJEKTEVE

Dr. e Projekteve e Investimeve	FLORA MUCA	<i>[Signature]</i>
STAFI TEKNIK PROJEKTES	Ing. ERBLIN LALA	<i>[Signatures]</i>
	Ing. ARJOLA KURTI	
	Ing. DENIS PRENÇI	
	Ing. EGLANTINA DISHA	
	Ing. RAMADAN HYSA	
Titulli i Projektit NDERTIM RRUGA "BETIM MUÇO"		Faza e Projektit PROJEKT ZBATIMI
Emertimi i Fletes PROFILE TERTHORE		Data e Implementimit : Shkalla e Vizatimit Fleta Nr. A-69

NDERTIM RRUGA: "BETIM MUÇO" PROFILE TERTHORE

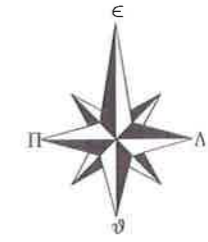

Km.0+656.09 (CS 111)

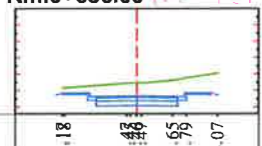

Kuota Terenit		193.18	193.18	193.65	193.65	194.07
Dist.Progressive	-4.09	-5.89	-6.00	-3.06	5.00	
Kuota Projektit	193.18	193.18	193.47	193.58	193.58	194.07
Dist.Progressive	-4.09	-5.89	-6.00	-3.06	5.00	

Km.0+629.67 (CS 111)

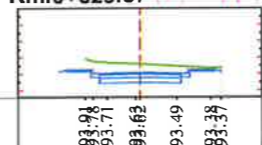

Kuota Terenit		193.81	193.71	193.62	193.49	193.37
Dist.Progressive	-5.00	-3.88	-2.01	0.06	2.27	4.87
Kuota Projektit	193.81	193.71	193.62	193.49	193.37	193.37
Dist.Progressive	-5.00	-3.88	-2.01	0.06	2.27	4.87

Km.0+603.34 (CS 109)

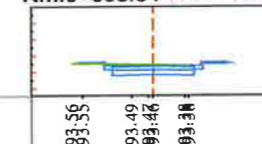

Kuota Terenit		193.59	193.49	193.48	193.38	
Dist.Progressive	-5.00	-3.99	-1.30	0.06	2.98	5.00
Kuota Projektit	193.59	193.49	193.48	193.38	193.38	
Dist.Progressive	-5.00	-3.99	-1.30	0.06	2.98	5.00

Km.0+660.00 (CS 122)

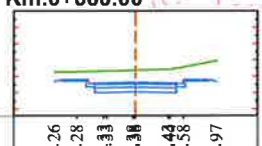

Kuota Terenit		193.26	193.28	193.33	193.43	193.58
Dist.Progressive	-5.00	-3.59	-1.96	0.04	2.04	2.97
Kuota Projektit	193.26	193.33	193.38	193.43	193.58	193.58
Dist.Progressive	-5.00	-3.59	-1.96	0.04	2.04	2.97

Km.0+632.36 (CS 110)

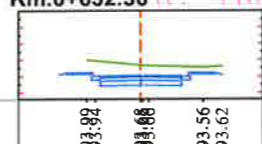

Kuota Terenit		193.92	193.88	193.68	193.56	193.62
Dist.Progressive	-5.00	-2.77	0.08	3.86	5.00	
Kuota Projektit	193.92	193.88	193.68	193.56	193.62	
Dist.Progressive	-5.00	-2.77	0.08	3.86	5.00	

Km.0+603.90 (CS 110)

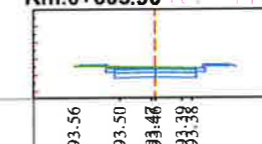

Kuota Terenit		193.56	193.50	193.48	193.38	
Dist.Progressive	-5.00	-2.16	0.02	1.53	5.00	
Kuota Projektit	193.56	193.50	193.48	193.38	193.38	
Dist.Progressive	-5.00	-2.16	0.02	1.53	5.00	

Km.0+673.32 (CS 123)

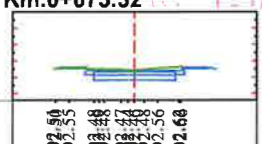

Kuota Terenit		192.50	192.55	192.58	192.58	192.68
Dist.Progressive	-5.00	-4.02	-3.45	0.00	1.46	2.86
Kuota Projektit	192.50	192.55	192.58	192.58	192.58	192.68
Dist.Progressive	-5.00	-4.02	-3.45	0.00	1.46	2.86

Km.0+635.04 (CS 113)

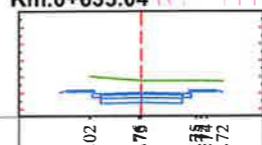

Kuota Terenit		194.02	193.76	193.76	193.76	193.72
Dist.Progressive	-5.00	-3.15	0.06	3.88	5.00	
Kuota Projektit	194.02	193.76	193.76	193.76	193.72	
Dist.Progressive	-5.00	-3.15	0.06	3.88	5.00	

Km.0+604.46 (CS 111)

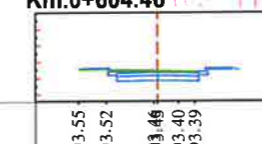

Kuota Terenit		193.55	193.52	193.46	193.40	193.39
Dist.Progressive	-5.00	-3.13	0.02	1.28	2.29	5.00
Kuota Projektit	193.55	193.52	193.46	193.40	193.39	
Dist.Progressive	-5.00	-3.13	0.02	1.28	2.29	5.00

BASHKIA KAMËZ

DREJTORIA E PROJEKTEVE DHE INVESTIMEVE
DEPARTAMENTI I PROJEKTEVE

Dr. e Projekteve e Investimeve	FLORA MUCA										
<table border="1" style="width: 100%; border-collapse: collapse;"> <tr> <td style="width: 20%;">STAFI TEKNIK</td> <td style="width: 80%;">Ing. ERBLIN LALA</td> </tr> <tr> <td>PROJEKTUES</td> <td>Ing. ARJOLA KURTI</td> </tr> <tr> <td></td> <td>Ing. DENIS PRENÇI</td> </tr> <tr> <td></td> <td>Ing. EGLANTINA DISHA</td> </tr> <tr> <td></td> <td>Ing. RAMADAN HYSA</td> </tr> </table>		STAFI TEKNIK	Ing. ERBLIN LALA	PROJEKTUES	Ing. ARJOLA KURTI		Ing. DENIS PRENÇI		Ing. EGLANTINA DISHA		Ing. RAMADAN HYSA
STAFI TEKNIK	Ing. ERBLIN LALA										
PROJEKTUES	Ing. ARJOLA KURTI										
	Ing. DENIS PRENÇI										
	Ing. EGLANTINA DISHA										
	Ing. RAMADAN HYSA										
Titulli i Projektit NDERTIM RRUGA "BETIM MUÇO"											
Faza e Projektit PROJEKT ZBATIMI											
Data e Implementimit :											
Shkalla e Vizatimit											
Emertimi i Fletes PROFILE TERHORE											
Fieta Nr. A-70											

NDERTIM RRUGA: "BETIM MUÇO" PROFILE TERTHORE



Km.0+743.31 (1.2 | 1.19)

Kuota Terenit	190.47 190.47 190.73 190.84 190.99
Dist.Progressive	-5.00 -3.58 -0.47 3.34 5.00
Kuota Projektit	190.47 190.73 190.84 190.99
Dist.Progressive	-3.58 -0.47 3.34 5.00

Km.0+709.97 (1.2 | 1.19)

Kuota Terenit	191.88 192.04 192.03 192.11 192.50
Dist.Progressive	-5.00 -2.88 -0.90 8.00 2.90 5.00
Kuota Projektit	191.88 192.04 192.03 192.11 192.50
Dist.Progressive	-2.88 -0.90 8.00 1.65 2.90

Km.0+684.18 (1.2 | 1.2)

Kuota Terenit	191.96 191.96 192.26 192.19 192.89
Dist.Progressive	-5.00 -3.00 -1.32 0.40 2.89 5.00
Kuota Projektit	191.96 191.96 192.26 192.19 192.89
Dist.Progressive	-3.00 -1.32 0.40 1.89 2.89

Km.0+746.76 (1.2 | 1.19)

Kuota Terenit	190.38 190.38 190.56 190.73 190.85
Dist.Progressive	-5.00 -3.43 -1.54 3.01 5.00
Kuota Projektit	190.38 190.56 190.73 190.85
Dist.Progressive	-3.43 -1.54 3.01 5.00

Km.0+720.00 (1.2 | 1.21)

Kuota Terenit	191.44 191.44 191.65 191.72 192.06
Dist.Progressive	-5.00 -3.68 -2.02 0.00 2.24 3.08 5.00
Kuota Projektit	191.44 191.65 191.72 191.78 192.06
Dist.Progressive	-3.68 -2.02 0.00 2.24 3.08

Km.0+684.75 (1.2 | 1.21)

Kuota Terenit	191.99 191.99 192.26 192.20 192.81
Dist.Progressive	-5.00 -2.89 -1.32 0.98 2.77 5.00
Kuota Projektit	191.99 191.99 192.26 192.20 192.81
Dist.Progressive	-2.89 -1.32 0.98 1.99 2.77

Km.0+749.99 (1.2 | 1.11)

Kuota Terenit	190.40 190.40 190.41 190.60 190.64
Dist.Progressive	-5.00 -3.45 -0.60 3.83 4.97
Kuota Projektit	190.40 190.41 190.60 190.64
Dist.Progressive	-3.45 -0.60 3.83 4.97

Km.0+728.73 (1.2 | 1.15)

Kuota Terenit	191.15 191.15 191.38 191.35 191.73
Dist.Progressive	-5.00 -3.09 -2.54 -0.85 1.17 3.08 5.00
Kuota Projektit	191.15 191.38 191.35 191.34 191.73
Dist.Progressive	-4.37 -3.09 -2.54 -0.85 1.17 3.08

Km.0+700.00 (1.2 | 1.21)

Kuota Terenit	192.08 192.08 192.19 192.22 192.45
Dist.Progressive	-5.00 -2.72 0.90 2.09 3.18 5.00
Kuota Projektit	192.08 192.19 192.22 192.22 192.45
Dist.Progressive	-2.72 0.90 2.09 3.18

BASHKIA KAMËZ

DREJTORIA E PROJEKTEVE DHE INVESTIMEVE
DEPARTAMENTI I PROJEKTEVE

Dr. e Projekteve e Investimeve	FLORA MUCA	
STAFI TEKNIK PROJEKTES	Ing. ERBLIN LALA	
	Ing. ARJOLA KURTI	
	Ing. DENIS PRENÇI	
	Ing. EGLANTINA DISHA	
	Ing. RAMADAN HYSA	
Titulli i Projektit NDERTIM RRUGA "BETIM MUÇO"		Faza e Projektit PROJEKT ZBATIMI
Emertimi i Fletes PROFILE TERTHORE		Shkalla e Vizatimit Fieta Nr. A-71

NDERTIM RRUGA: "BETIM MUÇO" PROFILE TERTHORE

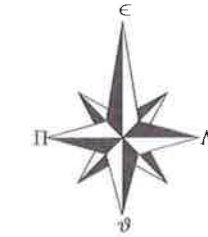

Km.0+674.63



Kuota Terenit	192.46	192.46	192.46	192.65
Dist.Progressive	-8.98	-3.63	1.98	5.00
Kuota Projektit	192.46	192.49	192.22	192.41
Dist.Progressive	-4.95	-1.98	0.00	3.82

Km.0+640.00



Kuota Terenit	193.97	193.97	193.97	193.77
Dist.Progressive	-5.00	-2.45	0.00	5.00
Kuota Projektit	193.97	193.85	193.85	193.77
Dist.Progressive	-2.45	0.00	1.92	5.00

Km.0+606.38



Kuota Terenit	193.57	193.57	193.57	193.40
Dist.Progressive	-5.00	-3.82	0.00	5.00
Kuota Projektit	193.57	193.45	193.45	193.40
Dist.Progressive	-3.82	0.00	2.44	5.00

Km.0+680.00

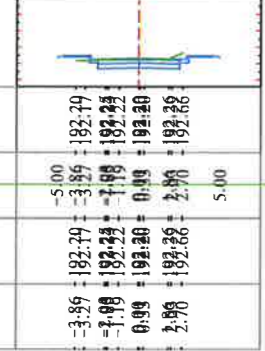

Kuota Terenit	192.79	192.79	192.79	192.66
Dist.Progressive	-5.00	-3.89	1.19	5.00
Kuota Projektit	192.79	192.22	192.22	192.66
Dist.Progressive	-3.89	-7.99	0.00	2.70

Km.0+653.34

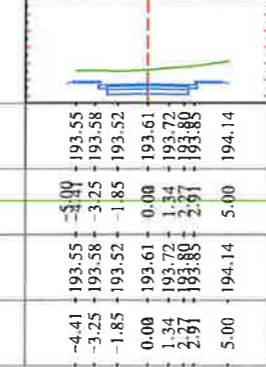

Kuota Terenit	193.55	193.55	193.55	194.14
Dist.Progressive	-5.00	-3.25	1.85	5.00
Kuota Projektit	193.55	193.58	193.58	194.14
Dist.Progressive	-4.41	-1.85	0.00	5.00

Km.0+610.75

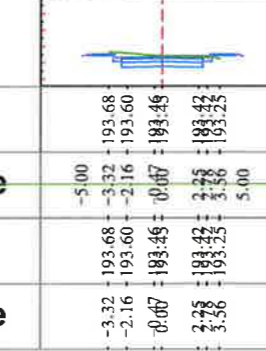

Kuota Terenit	193.68	193.68	193.68	193.42
Dist.Progressive	-5.00	-3.32	2.45	5.00
Kuota Projektit	193.68	193.60	193.45	193.42
Dist.Progressive	-3.32	-2.16	0.00	3.56

Km.0+683.60

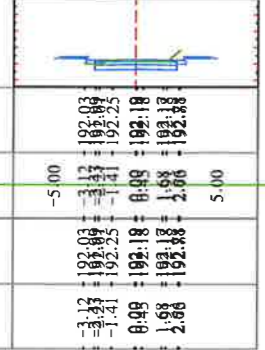

Kuota Terenit	193.03	193.03	193.03	192.88
Dist.Progressive	-5.00	-3.17	0.00	5.00
Kuota Projektit	193.03	192.85	192.85	192.88
Dist.Progressive	-3.17	-1.41	0.00	2.68

Km.0+654.71

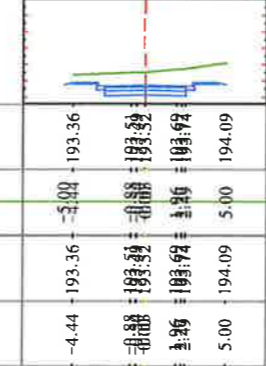

Kuota Terenit	193.36	193.36	193.36	194.09
Dist.Progressive	-5.00	-3.00	1.95	5.00
Kuota Projektit	193.36	193.52	193.52	194.09
Dist.Progressive	-4.44	-1.88	0.00	5.00

Km.0+620.00



Kuota Terenit	193.69	193.69	193.69	193.17
Dist.Progressive	-5.00	-3.53	1.48	5.00
Kuota Projektit	193.69	193.55	193.55	193.17
Dist.Progressive	-3.53	-1.48	0.00	4.79

BASHKIA KAMËZ

DREJTORIA E PROJEKTEVE DHE INVESTIMEVE
DEPARTAMENTI I PROJEKTEVE

Dr. e Projekteve e Investimeve: FLORA MUCA

STAFI TEKNIK
PROJEKTES

Ing.	ERBLIN LALA
Ing.	ARJOLA KURTI
Ing.	DENIS PRENÇI
Ing.	EGLANTINA DISHA
Ing.	RAMADAN HYSA

(Signatures)

Titulli i Projektit
NDERTIM RRUGA "BETIM MUÇO"

Emertimi i Fletes
PROFILE TERTHORE

Faza e Projektit
PROJEKT ZBATIMI

Data e Implementimit :

Shkalla e Vizatimit

Fleta Nr.
A-72

NDERTIM RRUGA: "BETIM MUÇO" PROFILE TERTHORE



Km.0+750.18 (CS 11.5)



Kuota Terenit	198.29	198.29	198.44	198.58	190.63
Dist.Progressive	-5.00	3.16	0.71	3.81	8.99
Kuota Projektit	198.29	198.44	198.44	198.58	190.63
Dist.Progressive	3.16	0.71	0.00	3.81	4.99

Km.0+731.17 (CS 13.6)



Kuota Terenit	181.99	181.99	181.26	191.23	191.68
Dist.Progressive	-5.00	3.82	-0.65	2.88	5.00
Kuota Projektit	181.99	181.26	181.26	191.23	191.68
Dist.Progressive	3.82	-0.65	0.00	2.88	4.34

Km.0+706.50 (CS 13.0)

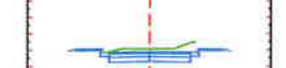

Kuota Terenit	191.06	191.06	192.07	192.48	191.68
Dist.Progressive	-5.00	2.83	0.00	3.73	5.00
Kuota Projektit	191.06	192.07	192.07	192.48	191.68
Dist.Progressive	2.83	1.00	0.00	2.83	4.34

Km.0+753.21 (CS 7.7)

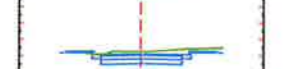

Kuota Terenit	198.15	198.15	190.35	190.43	190.49
Dist.Progressive	-5.00	3.44	1.55	2.60	5.00
Kuota Projektit	198.15	190.27	190.35	190.43	190.49
Dist.Progressive	3.44	-0.61	0.00	2.60	5.00

Km.0+733.60 (CS 13.2)



Kuota Terenit	191.02	191.02	191.15	191.18	191.43
Dist.Progressive	-5.00	3.68	0.68	3.62	5.00
Kuota Projektit	191.02	191.15	191.15	191.18	191.43
Dist.Progressive	3.68	0.68	0.00	3.62	5.00

Km.0+707.04 (CS 13.7)

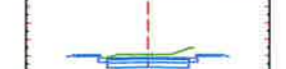

Kuota Terenit	191.85	191.85	192.07	192.38	191.68
Dist.Progressive	-5.00	3.81	0.00	3.57	5.00
Kuota Projektit	191.85	192.07	192.07	192.38	191.68
Dist.Progressive	3.81	1.22	0.00	2.66	4.34

Km.0+760.00 (CS 11.0)

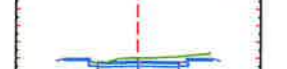

Kuota Terenit	189.75	189.75	190.10	190.23	190.23
Dist.Progressive	-5.00	2.83	0.74	2.24	5.00
Kuota Projektit	189.75	190.02	190.10	190.23	190.23
Dist.Progressive	2.83	0.69	0.00	2.24	4.34

Km.0+740.00 (CS 13.0)



Kuota Terenit	190.66	190.66	190.84	190.91	191.08
Dist.Progressive	-5.00	3.68	0.89	2.81	5.00
Kuota Projektit	190.66	190.84	190.84	190.91	191.08
Dist.Progressive	3.68	0.89	0.00	2.81	5.00

Km.0+708.23 (CS 13.7)

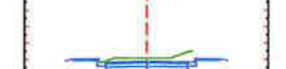

Kuota Terenit	191.85	191.85	192.06	192.40	191.68
Dist.Progressive	-5.00	3.81	0.00	3.59	5.00
Kuota Projektit	191.85	192.06	192.06	192.40	191.68
Dist.Progressive	3.81	1.00	0.00	2.66	4.34

BASHKIA KAMËZ

DREJTORIA E PROJEKTEVE DHE INVESTIMEVE
DEPARTAMENTI I PROJEKTEVE

Dr. e Projekteve e Investimeve		FLORA MUCA	
STAFI TEKNIK PROJEKTES	Ing.	ERBLIN LALA	
	Ing.	ARJOLA KURTI	
	Ing.	DENIS PRENÇI	
	Ing.	EGLANTINA DISHA	
	Ing.	RAMADAN HYSA	
Titulli i Projektit		NDERTIM RRUGA "BETIM MUÇO"	
Emertimi i Fletes		PROFILE TERTHORE	
Faza e Projektit		PROJEKT ZBATIMI	
Data e Implementimit :			
Shkalla e Vizatimit			
Fleta Nr.		A-73	

NDERTIM RRUGA: "BETIM MUÇO" PROFILE TERTHORE



Km.0+820.00 (C=13%)

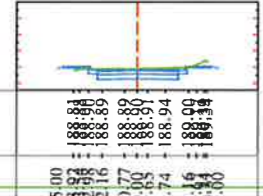

Kuota Terenit	188.85 188.85 188.89 188.94 188.94 189.00 189.34
Dist.Progressive	-5.00 -3.54 -2.16 -0.77 0.65 1.74 3.16 4.60
Kuota Projektit	188.85 188.85 188.89 188.94 188.94 189.00 189.34
Dist.Progressive	-3.54 -2.16 -0.77 0.65 1.74 3.16 4.60

Km.0+788.10 (C=15%)

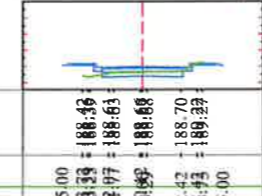

Kuota Terenit	188.43 188.43 188.63 188.68 188.70 188.70 189.33
Dist.Progressive	-5.00 -3.33 -2.07 -0.97 0.00 2.42 3.43 5.00
Kuota Projektit	188.43 188.63 188.68 188.70 188.70 189.33
Dist.Progressive	-3.33 -2.07 -0.97 2.42 3.43

Km.0+769.99 (C=11%)

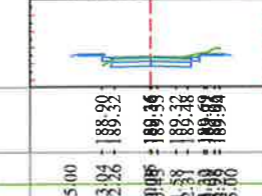

Kuota Terenit	189.32 189.32 189.35 189.38 189.38 189.38 189.94
Dist.Progressive	-5.00 -3.04 -2.04 0.00 1.58 2.81 3.00
Kuota Projektit	189.32 189.35 189.38 189.38 189.38 189.94
Dist.Progressive	-3.04 -2.04 1.58 2.81

Km.0+823.77 (C=13%)

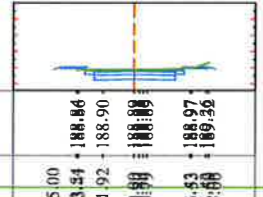

Kuota Terenit	188.84 188.84 188.90 188.99 188.99 189.37 189.38
Dist.Progressive	-5.00 -3.54 -1.92 0.00 1.57 3.53 4.60
Kuota Projektit	188.84 188.90 188.99 188.99 189.37 189.38
Dist.Progressive	-3.54 -1.92 0.00 1.57 3.53

Km.0+800.00 (C=15%)

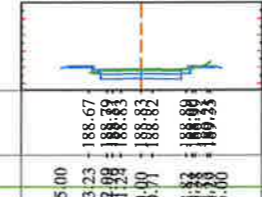

Kuota Terenit	188.67 188.67 188.87 188.92 188.92 188.92 189.33
Dist.Progressive	-5.00 -3.23 -1.98 -0.99 0.00 3.82 4.28 5.00
Kuota Projektit	188.67 188.87 188.92 188.92 188.92 189.33
Dist.Progressive	-3.23 -1.98 -0.99 3.82 4.28

Km.0+770.20 (C=11%)

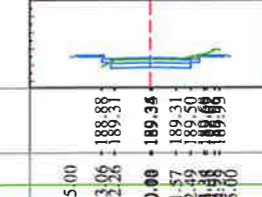

Kuota Terenit	189.31 189.31 189.35 189.35 189.35 189.35 189.94
Dist.Progressive	-5.00 -3.06 -2.26 0.00 1.57 2.49 3.00
Kuota Projektit	189.31 189.35 189.35 189.35 189.35 189.94
Dist.Progressive	-3.06 -2.26 1.57 2.49

Km.0+824.48 (C=13%)

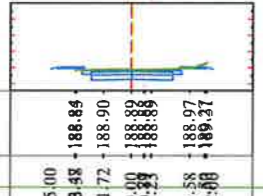

Kuota Terenit	188.85 188.85 188.90 188.99 188.99 189.37 189.37
Dist.Progressive	-5.00 -3.58 -1.72 0.00 1.57 3.58 4.60
Kuota Projektit	188.85 188.90 188.99 188.99 189.37 189.37
Dist.Progressive	-3.58 -1.72 0.00 1.57 3.58

Km.0+801.58 (C=15%)

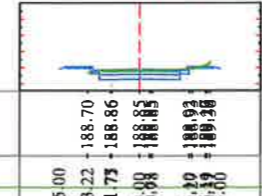

Kuota Terenit	188.70 188.70 188.86 188.95 188.95 188.95 189.36
Dist.Progressive	-5.00 -3.22 -1.73 0.00 1.57 3.40 4.39 5.00
Kuota Projektit	188.70 188.86 188.95 188.95 188.95 189.36
Dist.Progressive	-3.22 -1.73 0.00 1.57 3.40

Km.0+770.41 (C=11%)

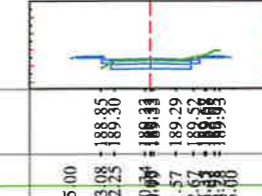

Kuota Terenit	189.32 189.32 189.35 189.38 189.38 189.38 189.94
Dist.Progressive	-5.00 -3.08 -2.25 0.00 1.57 2.67 3.00
Kuota Projektit	189.32 189.35 189.38 189.38 189.38 189.94
Dist.Progressive	-3.08 -2.25 1.57 2.67

BASHKIA KAMËZ

DREJTORIA E PROJEKTEVE DHE INVESTIMEVE
DEPARTAMENTI I PROJEKTEVE

Dr. e Projekteve e Investimeve	FLORA MUCA	E
STAFI TEKNIK PROJEKTES	Ing. ERBLIN LALA	E
	Ing. ARJOLA KURTI	E
	Ing. DENIS PRENÇI	E
	Ing. EGLANTINA DISHA	E
	Ing. RAMADAN HYSA	E
Titulli i Projektit NDERTIM RRUGA "BETIM MUÇO"		Faza e Projektit PROJEKT ZBATIMI
Emertimi i Fletes PROFILE TERTHORE		Shkalla e Vizatimit Flota Nr. A-74

NDERTIM RRUGA: "BETIM MUÇO" PROFILE TERTHORE

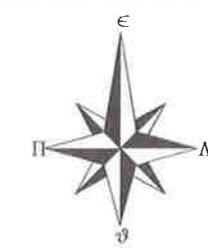

Km.0+903.74 (CS 173)



Kuota Terenit	188.69	188.69	188.58	188.54	188.52
Dist.Progressive	-3.99	-2.66	0.99	2.01	3.02
Kuota Projektit	188.69	188.64	188.58	188.54	188.52
Dist.Progressive	-3.99	-2.66	0.99	2.01	3.02

Km.0+883.53 (CS 169)

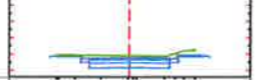

Kuota Terenit	188.94	188.94	188.94	188.87	188.76
Dist.Progressive	-4.43	-3.36	0.99	2.21	3.09
Kuota Projektit	188.94	188.94	188.94	188.87	188.76
Dist.Progressive	-4.43	-3.36	0.99	2.21	3.09

Km.0+859.25 (CS 163)

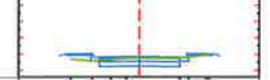

Kuota Terenit	188.69	188.69	188.67	188.79	188.80
Dist.Progressive	-4.25	-2.92	-1.75	0.00	3.14
Kuota Projektit	188.69	188.67	188.75	188.79	188.80
Dist.Progressive	-4.25	-2.92	-1.75	0.00	3.14

Km.0+884.42 (CS 170)

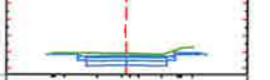

Kuota Terenit	188.93	188.92	188.85	188.85	188.79
Dist.Progressive	-4.88	-1.79	0.99	2.22	3.74
Kuota Projektit	188.93	188.91	188.85	188.85	188.79
Dist.Progressive	-4.88	-1.79	0.99	2.22	3.74

Km.0+860.00 (CS 161)

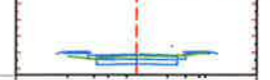

Kuota Terenit	188.73	188.59	188.66	188.79	188.80
Dist.Progressive	-4.28	-2.66	-1.76	0.00	3.05
Kuota Projektit	188.73	188.59	188.66	188.79	188.80
Dist.Progressive	-4.28	-2.66	-1.76	0.00	3.05

Km.0+889.11 (CS 171)

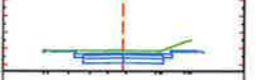

Kuota Terenit	188.88	188.87	188.87	188.86	188.80
Dist.Progressive	-4.89	-3.37	-2.04	0.99	3.85
Kuota Projektit	188.88	188.87	188.87	188.86	188.80
Dist.Progressive	-4.89	-3.37	-2.04	0.99	3.85

Km.0+871.08 (CS 165)

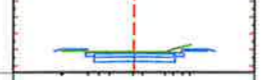

Kuota Terenit	188.93	188.86	188.85	188.85	188.80
Dist.Progressive	-4.80	-2.85	-1.51	0.99	3.48
Kuota Projektit	188.93	188.86	188.85	188.85	188.80
Dist.Progressive	-4.80	-2.85	-1.51	0.99	3.48

BASHKIA KAMËZ

DREJTORIA E PROJEKTEVE DHE INVESTIMEVE
DEPARTAMENTI I PROJEKTEVE

Dr. e Projekteve e Investimeve	FLORA MUCA	6
STAFI TEKNIK PROJEKTES	Ing.	ERBLIN LALA
	Ing.	ARJOLA KURTI
	Ing.	DENIS PRENÇI
	Ing.	EGLANTINA DISHA
	Ing.	RAMADAN HYSA
Titulli i Projektit		Faza e Projektit
NDERTIM RRUGA "BETIM MUÇO"		PROJEKT ZBATIMI
Emertimi i Fletes		Data e Implementimit :
PROFILE TERTHORE		Shkalla e Vizatimit
		Fleta Nr.
		A-75

NDERTIM RRUGA: "BETIM MUÇO" PROFILE TERTHORE



Km.0+840.00 (CS 160)

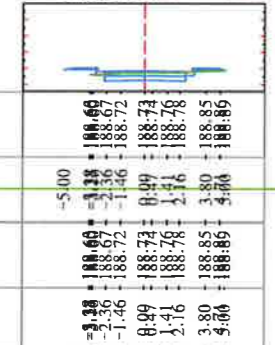

Kuota Terenit	188.65 188.67 188.72 188.78 188.85 188.85
Dist.Progressive	-5.00 -3.38 -2.36 -1.46 0.49 3.80 5.00
Kuota Projektit	188.60 188.67 188.72 188.78 188.85 188.85
Dist.Progressive	-3.38 -1.46 0.49 3.80 5.00

Km.0+816.94 (CS 131)

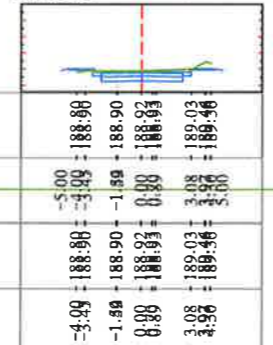

Kuota Terenit	188.90 188.90 188.90 188.90 189.03 189.46
Dist.Progressive	-5.00 -3.49 -1.89 0.80 3.08 4.96 5.00
Kuota Projektit	188.90 188.90 188.92 188.93 189.03 189.46
Dist.Progressive	-3.49 -1.89 0.80 3.08 4.96

Km.0+780.00 (CS 180)

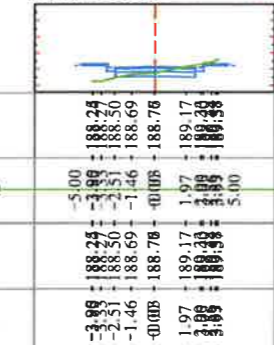

Kuota Terenit	188.24 188.24 188.50 188.69 188.78 189.17 189.46
Dist.Progressive	-5.00 -3.09 -2.51 -1.46 -0.08 1.97 3.09 5.00
Kuota Projektit	188.24 188.50 188.69 188.78 189.17 189.46
Dist.Progressive	-3.09 -2.51 -1.46 -0.08 1.97 3.09

Km.0+857.87 (CS 161)

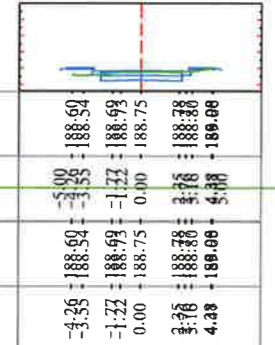

Kuota Terenit	188.54 188.54 188.69 188.75 188.78 189.00
Dist.Progressive	-5.00 -3.26 -1.22 0.00 3.26 4.38 5.00
Kuota Projektit	188.54 188.69 188.75 188.78 189.00
Dist.Progressive	-3.26 -1.22 0.00 3.26 4.38

Km.0+818.37 (CS 155)

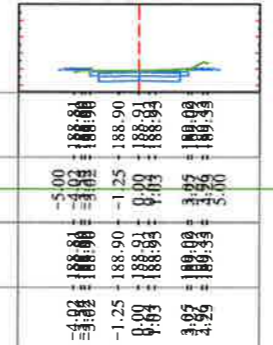

Kuota Terenit	188.90 188.90 188.90 188.93 189.03 189.46
Dist.Progressive	-5.00 -3.02 -1.25 0.00 3.02 4.38 5.00
Kuota Projektit	188.90 188.90 188.93 189.03 189.46
Dist.Progressive	-3.02 -1.25 0.00 3.02 4.38

Km.0+787.18 (CS 179)

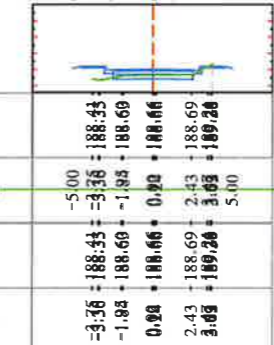

Kuota Terenit	188.45 188.45 188.60 188.66 188.69 189.28
Dist.Progressive	-5.00 -3.36 -1.88 0.28 2.43 3.09 5.00
Kuota Projektit	188.45 188.60 188.66 188.69 189.28
Dist.Progressive	-3.36 -1.88 0.28 2.43 3.09

Km.0+858.56 (CS 162)

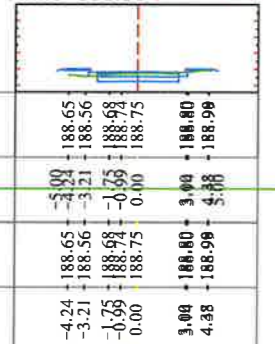

Kuota Terenit	188.65 188.65 188.74 188.75 188.80 188.99
Dist.Progressive	-5.00 -3.24 -1.75 0.00 3.04 4.38 5.00
Kuota Projektit	188.65 188.74 188.75 188.80 188.99
Dist.Progressive	-3.24 -1.75 0.00 3.04 4.38

Km.0+819.80 (CS 156)

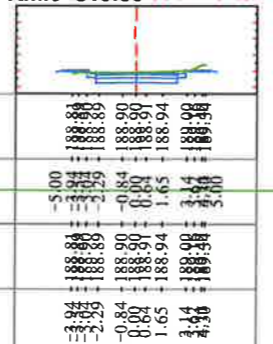

Kuota Terenit	188.80 188.80 188.90 188.94 189.03 189.46
Dist.Progressive	-5.00 -3.04 -0.84 0.00 3.04 4.38 5.00
Kuota Projektit	188.80 188.90 188.94 189.03 189.46
Dist.Progressive	-3.04 -0.84 0.00 3.04 4.38

Km.0+787.64 (CS 170)

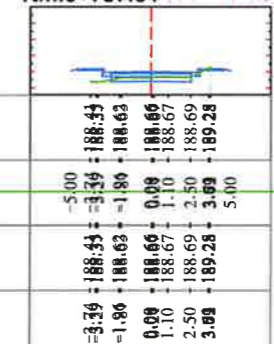

Kuota Terenit	188.45 188.45 188.63 188.65 188.67 189.28
Dist.Progressive	-5.00 -3.39 -1.89 0.09 2.50 3.09 5.00
Kuota Projektit	188.45 188.63 188.65 188.67 189.28
Dist.Progressive	-3.39 -1.89 0.09 2.50 3.09

BASHKIA KAMËZ

DREJTORIA E PROJEKTEVE DHE INVESTIMEVE
DEPARTAMENTI I PROJEKTEVE

Dr. e Projekteve e Investimeve	FLORA MUCA	
STAFI TEKNIK PROJEKTES	Ing. ERBLIN LALA	
	Ing. ARJOLA KURTI	
	Ing. DENIS PRENÇI	
	Ing. EGLANTINA DISHA	
	Ing. RAMADAN HYSA	
Titulli i Projektit NDERTIM RRUGA "BETIM MUÇO"		Faza e Projektit PROJEKT ZBATIMI
Emertimi i Fletes PROFILE TERTHORE		Shkalla e Vizatimit Fleta Nr. A-76

NDERTIM RRUGA: "BETIM MUÇO" PROFILE TERTHORE

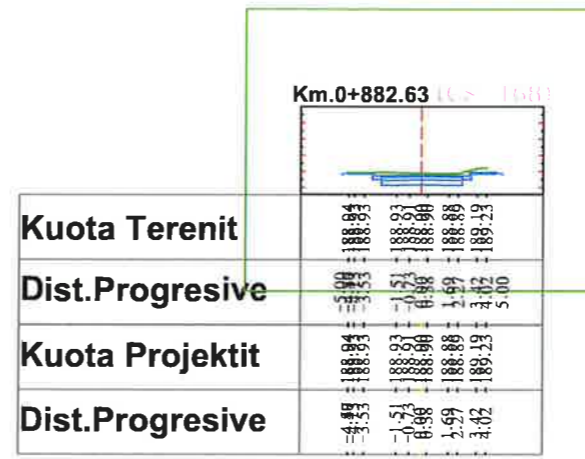
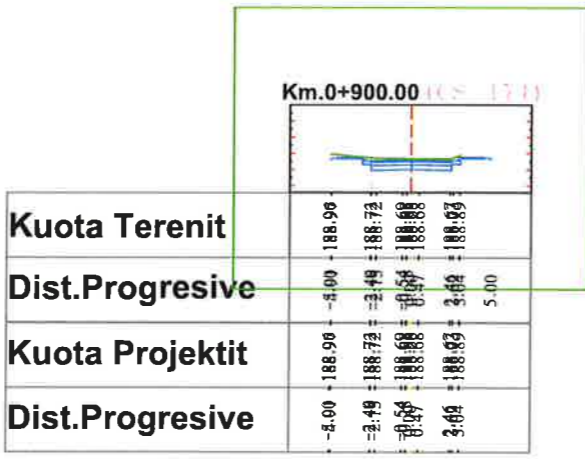
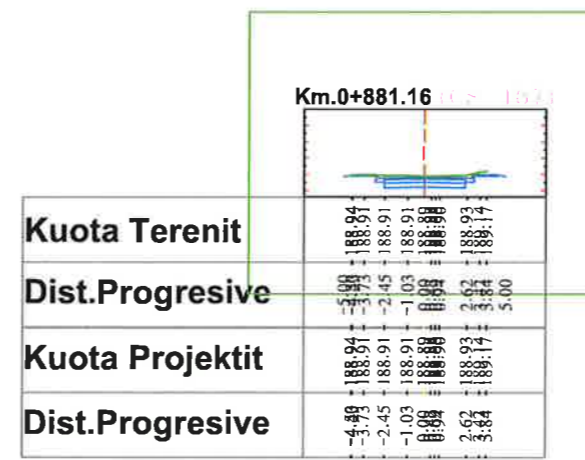
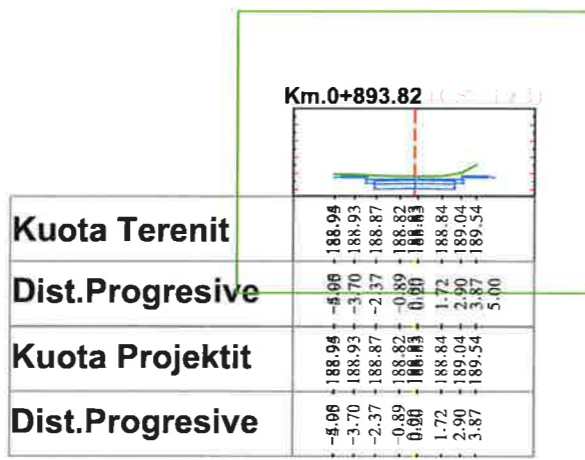
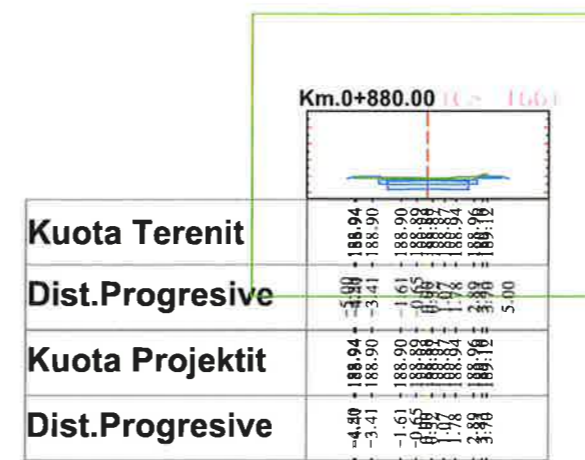
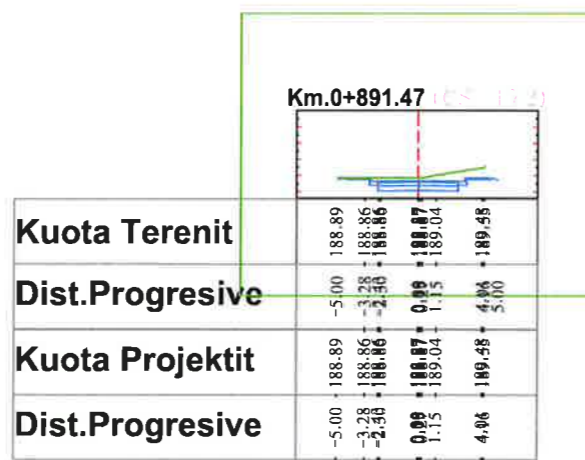
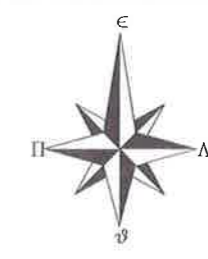

BASHKIA KAMËZ

DREJTORIA E PROJEKTEVE DHE INVESTIMEVE
DEPARTAMENTI I PROJEKTEVE

Dr. e Projekteve e Investimeve	FLORA MUCA	
STAFI TEKNIK PROJEKTES	Ing.	ERBLIN LALA
	Ing.	ARJOLA KURTI
	Ing.	DENIS PRENÇI
	Ing.	EGLANTINA DISHA
	Ing.	RAMADAN HYSA
Titulli i Projektit		Faza e Projektit
NDERTIM RRUGA "BETIM MUÇO"		PROJEKT ZBATIMI
Emertimi i Fletes		Data e Implementimit :
PROFILE TERTHORE		Shkalla e Vizatimit
		Fleta Nr.
		A-77

NDERTIM RRUGA: "BETIM MUÇO" PROFILE TERTHORE

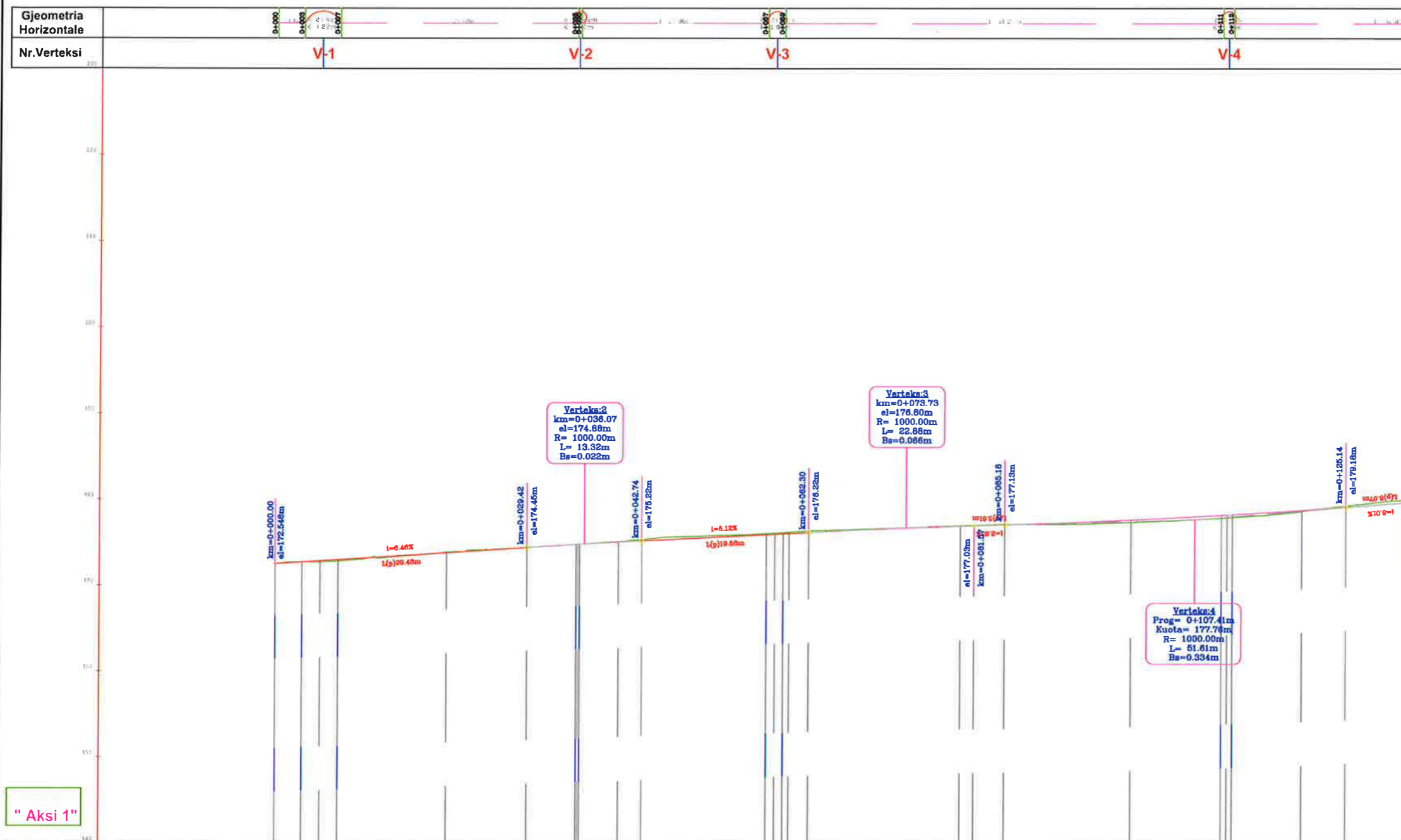

"Aksi 1"

CS-NR.		0+000	0+020	0+040	0+060	0+080	0+100	0+120
Distanca	Pjesore		20	20	20	20	20	20
	Progresive	0+000	0+020	0+040	0+060	0+080	0+100	0+120
Kuota	Terreni	173.91	173.91	175.12	176.24	177.04	177.43	178.72
	Projektit	173.91	173.91	175.12	176.24	177.04	177.43	178.72
	Punes	0.00	0.00	0.00	0.00	0.00	0.00	0.00
Gjeometria Vertikale								

BASHKIA KAMËZ

DREJTORIA E PROJEKTEVE DHE INVESTIMEVE
DEPARTAMENTI I PROJEKTEVE

Dr. e Projekteve e Investimeve		FLORA MUCA	5
STAFI TEKNIK PROJEKTES	Ing.	ERBLIN LALA	
	Ing.	ARJOLA KURTI	
	Ing.	DENIS PRENÇI	
	Ing.	EGLANTINA DISHA	
	Ing.	RAMADAN HYSA	
Titulli i Projektit		Faza e Projektit	
NDERTIM RRUGA "BETIM MUÇO"		PROJEKT ZBATIMI	
Emertimi i Fietes		Data e Implementimit:	
PROFILE TERTHORE		Shkalla e Vizatimit:	
		Fieta Nr.	
		A-78	

NDERTIM RRUGA: "BETIM MUÇO" PROFILE TERTHORE

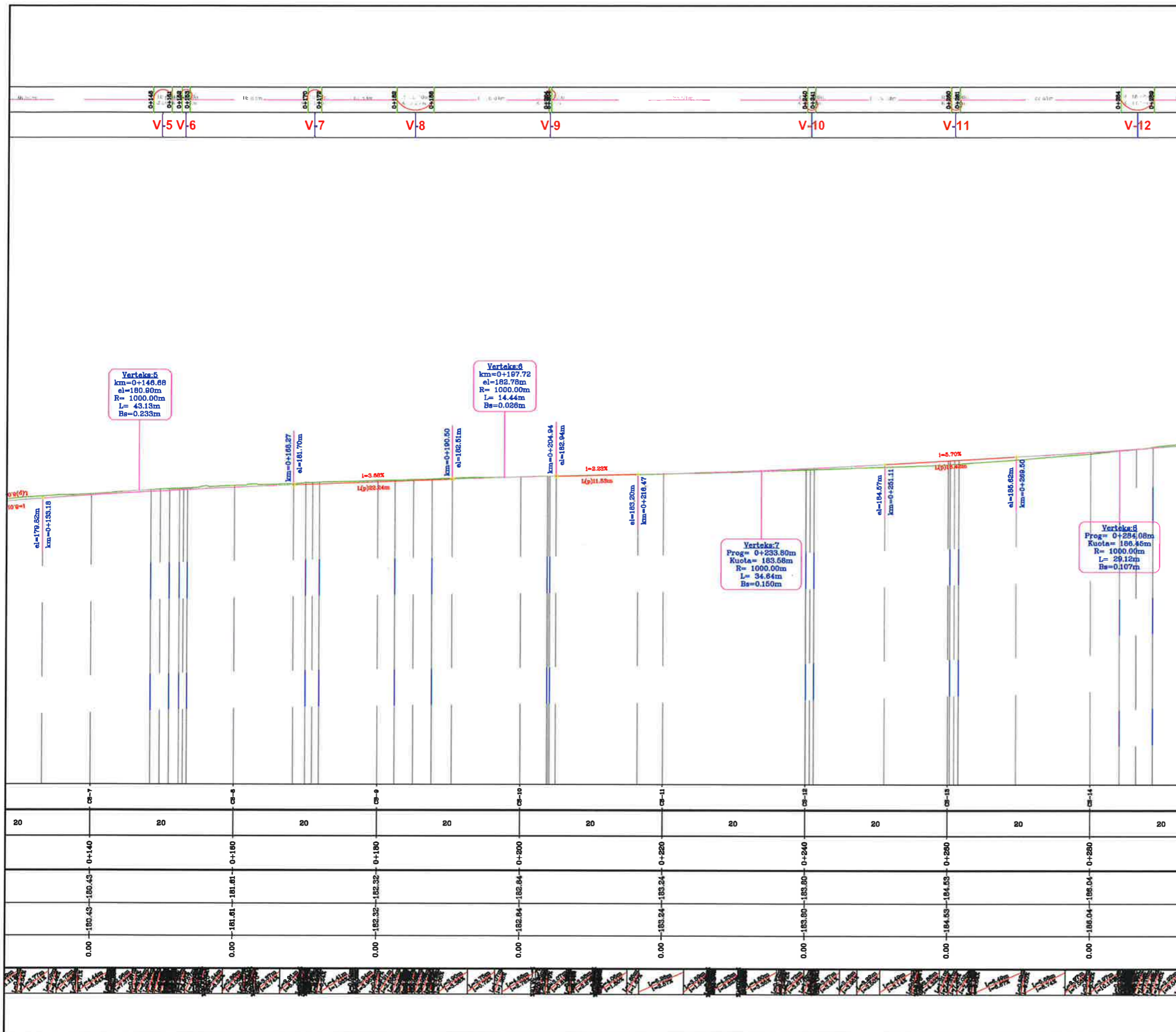

BASHKIA KAMËZ

DREJTORIA E PROJEKTEVE DHE INVESTIMEVE
DEPARTAMENTI I PROJEKTEVE

Dr. e Projekteve e Investimeve	FLORA MUCA											
STAFI TEKNIK PROJEKTES	<table style="width: 100%; border-collapse: collapse;"> <tr><td style="width: 20px; font-size: x-small;">Ing.</td><td>ERBLIN LALA</td></tr> <tr><td style="font-size: x-small;">Ing.</td><td>ARJOLA KURTI</td></tr> <tr><td style="font-size: x-small;">Ing.</td><td>DENIS PRENÇI</td></tr> <tr><td style="font-size: x-small;">Ing.</td><td>EGLANTINA DISHA</td></tr> <tr><td style="font-size: x-small;">Ing.</td><td>RAMADAN HYSA</td></tr> </table>	Ing.	ERBLIN LALA	Ing.	ARJOLA KURTI	Ing.	DENIS PRENÇI	Ing.	EGLANTINA DISHA	Ing.	RAMADAN HYSA	
Ing.	ERBLIN LALA											
Ing.	ARJOLA KURTI											
Ing.	DENIS PRENÇI											
Ing.	EGLANTINA DISHA											
Ing.	RAMADAN HYSA											
Titulli i Projektit NDERTIM RRUGA "BETIM MUÇO"		Faza e Projektit PROJEKT ZBATIMI										
Emertimi i Fletes PROFILE TERTHORE		Data e Implementimit: Shkalla e Vizatimit: Fleta Nr. A-79										

NDERTIM RRUGA: "BETIM MUÇO" PROFILE TERTHORE

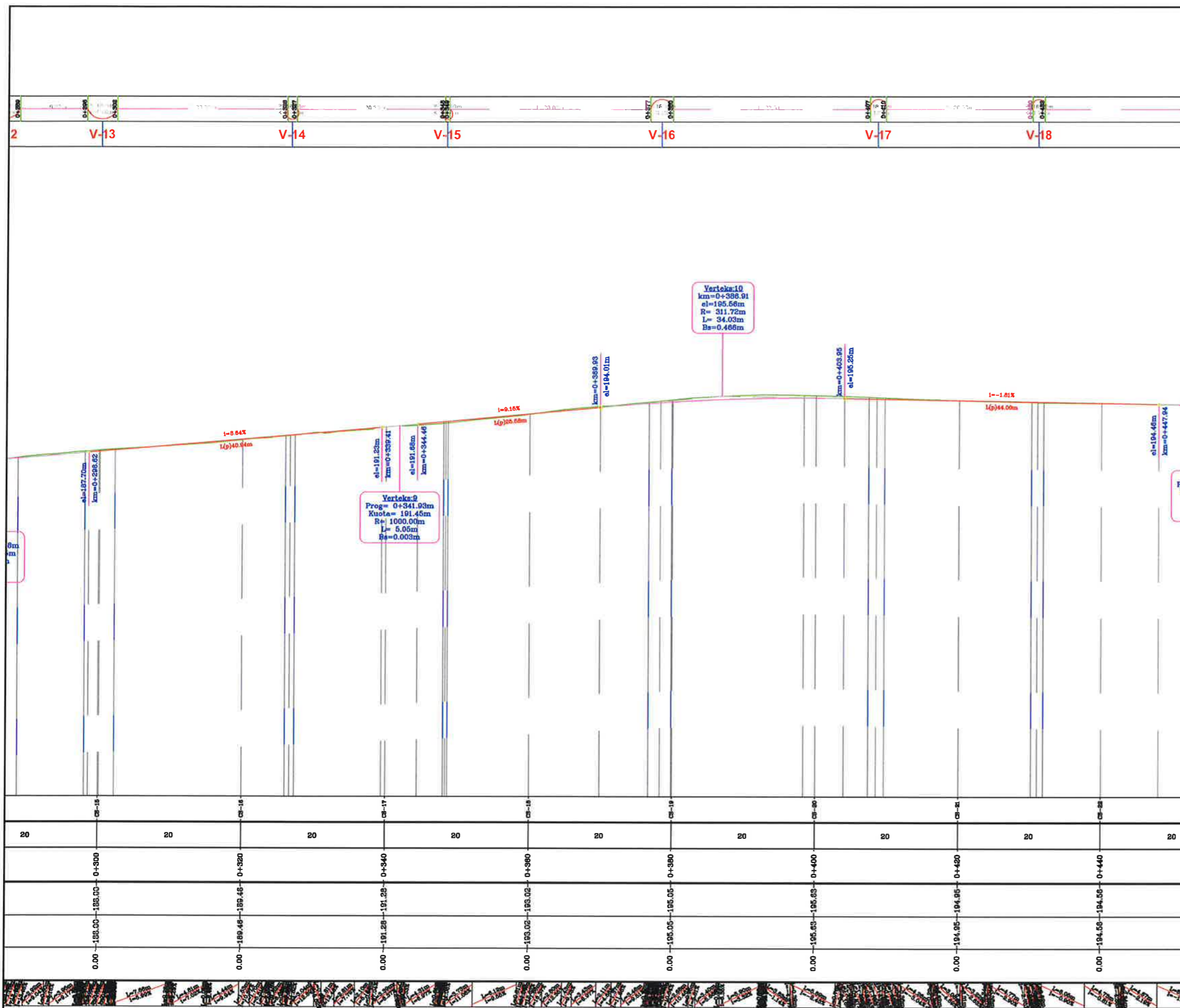

BASHKIA KAMËZ

DREJTORIA E PROJEKTEVE DHE INVESTIMEVE
DEPARTAMENTI I PROJEKTEVE

Dr. e Projekteve e Investimeve	FLORA MUCA	
--------------------------------	------------	--

STAFI TEKNIK PROJEKTES	Ing.	ERBLIN LALA	
	Ing.	ARJOLA KURTI	
	Ing.	DENIS PRENÇI	
	Ing.	EGLANTINA DISHA	
	Ing.	RAMADAN HYSA	

Titulli i Projektit NDERTIM RRUGA "BETIM MUÇO"	Faza e Projektit PROJEKT ZBATIMI
Data e Implementimit :	
Shkalla e Vizatimit	
Emertimi i Fletes PROFILE TERTHORE	
Fleta Nr. <h1 style="font-size: 2em; margin: 0;">A-80</h1>	

NDERTIM RRUGA: "BETIM MUÇO" PROFILE TERTHORE

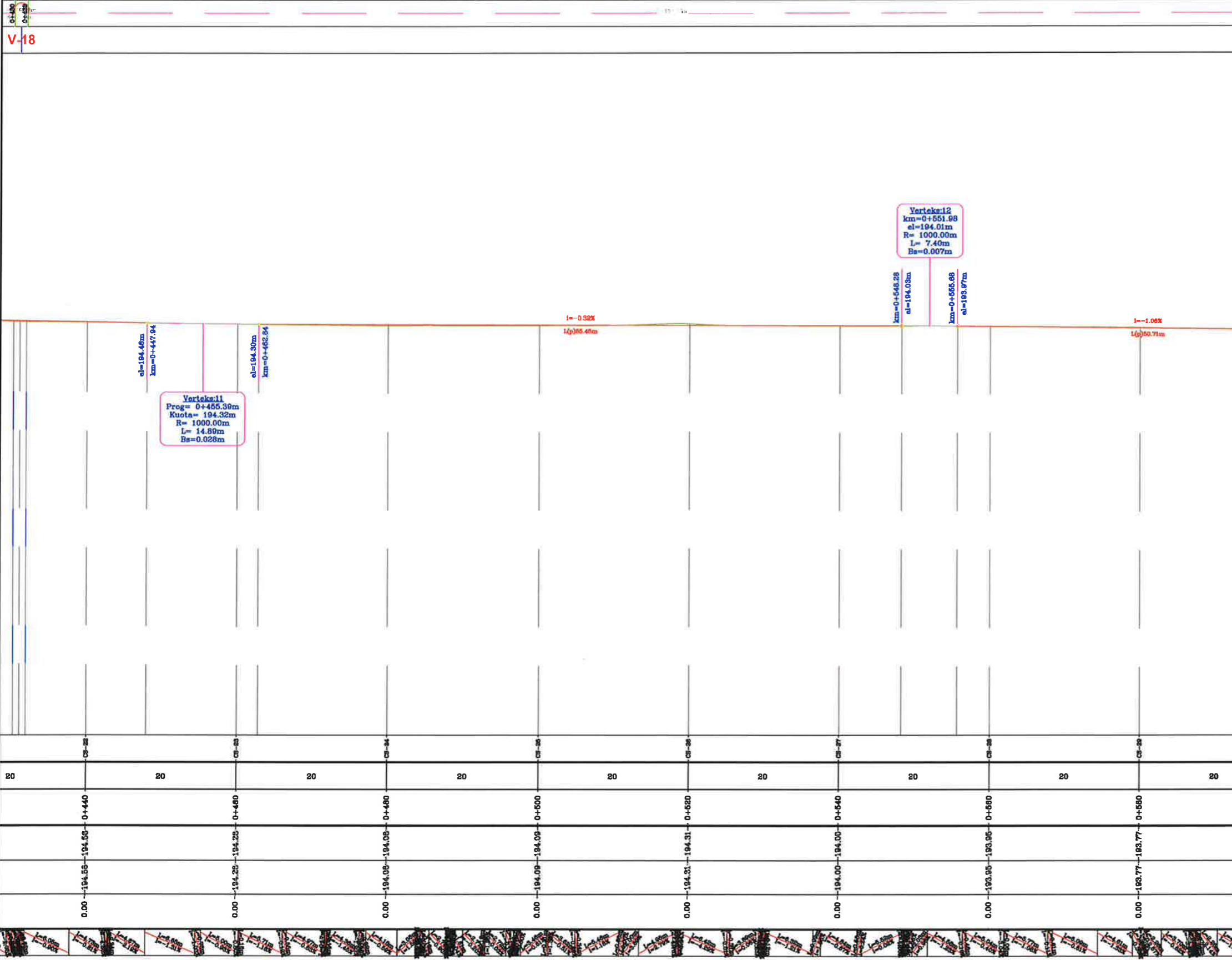
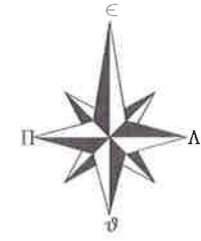



BASHKIA KAMËZ

DREJTORIA E PROJEKTEVE DHE INVESTIMEVE
DEPARTAMENTI I PROJEKTEVE

Dr. e Projekteve e Investimeve	FLORA MUCA															
STAFI TEKNIK	<table border="1" style="width: 100%; border-collapse: collapse;"> <tr><td style="width: 10%;">Ing.</td><td style="width: 50%;">ERBLIN LALA</td><td style="width: 40%;"></td></tr> <tr><td>Ing.</td><td>ARJOLA KURTI</td><td></td></tr> <tr><td>Ing.</td><td>DENIS PRENÇI</td><td></td></tr> <tr><td>Ing.</td><td>EGLANTINA DISHA</td><td></td></tr> <tr><td>Ing.</td><td>RAMADAN HYSA</td><td></td></tr> </table>	Ing.	ERBLIN LALA		Ing.	ARJOLA KURTI		Ing.	DENIS PRENÇI		Ing.	EGLANTINA DISHA		Ing.	RAMADAN HYSA	
Ing.	ERBLIN LALA															
Ing.	ARJOLA KURTI															
Ing.	DENIS PRENÇI															
Ing.	EGLANTINA DISHA															
Ing.	RAMADAN HYSA															
Titulli i Projektit NDERTIM RRUGA "BETIM MUÇO"																
Faza e Projektit PROJEKT ZBATIMI																
Data e Implementimit:																
Shkalla e Vizatimit																
Emertimi i Fletës PROFILE TERTHORE																
Fleta Nr. A-81																

NDERTIM RRUGA: "BETIM MUÇO" PROFILE TERTHORE

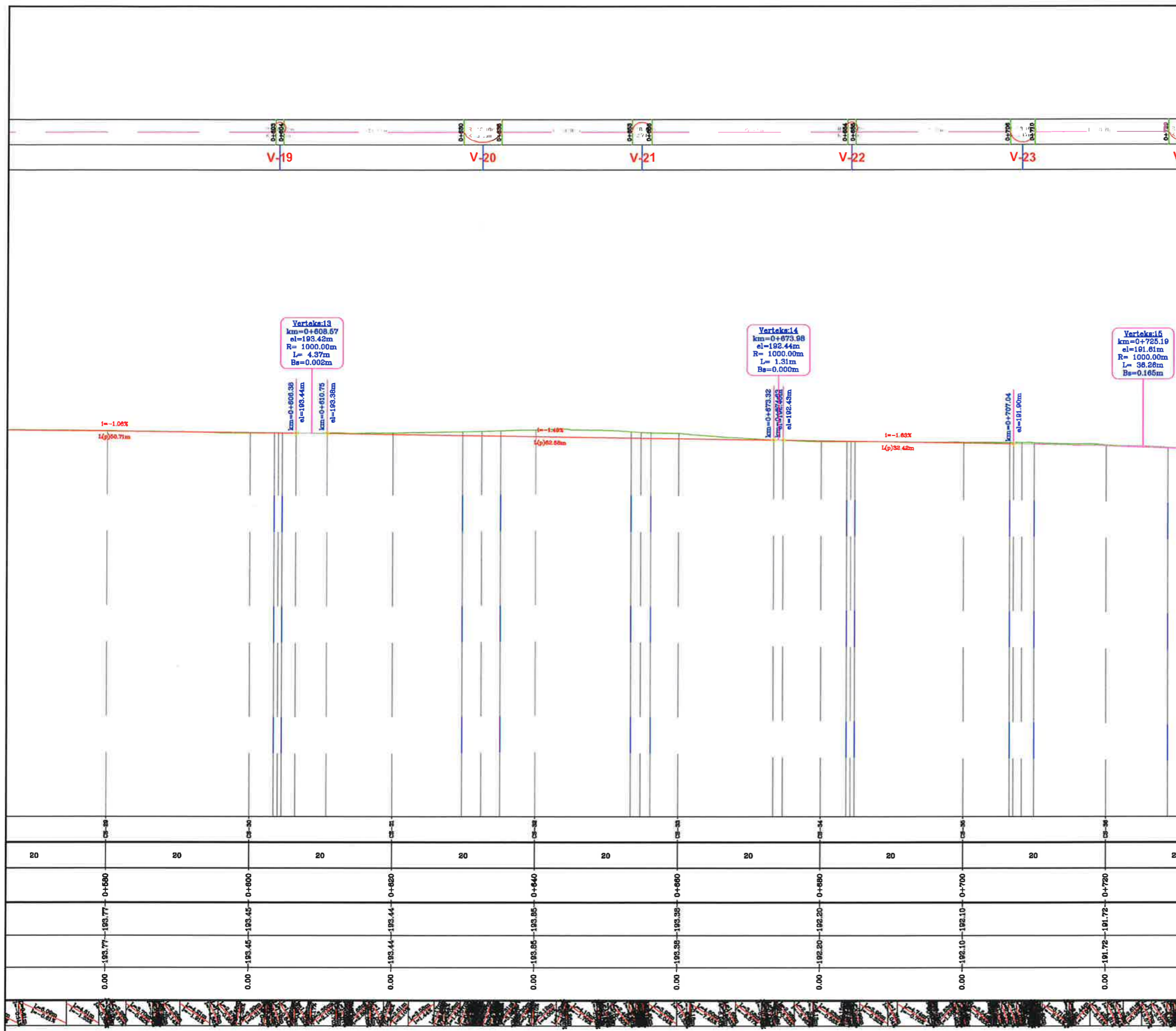



BASHKIA KAMËZ

DREJTORIA E PROJEKTEVE DHE INVESTIMEVE
DEPARTAMENTI I PROJEKTEVE

Dr. e Projekteve e Investimeve		FLORA MUCA	<i>[Signature]</i>
STAFI TEKNIK PROJEKTES	Ing.	ERBLIN LALA	<i>[Signatures]</i>
	Ing.	ARJOLA KURTI	
	Ing.	DENIS PRENÇI	
	Ing.	EGLANTINA DISHA	
	Ing.	RAMADAN HYSA	
Titulli i Projektit		Faza e Projektit	
NDERTIM RRUGA "BETIM MUÇO"		PROJEKT ZBATIMI	
Emertimi i Fletes		Shkalla e Vizatimit	
PROFILE TERTHORE		Fieta Nr.	
		A-82	

NDERTIM RRUGA: "BETIM MUÇO" PROFILE TERTHORE

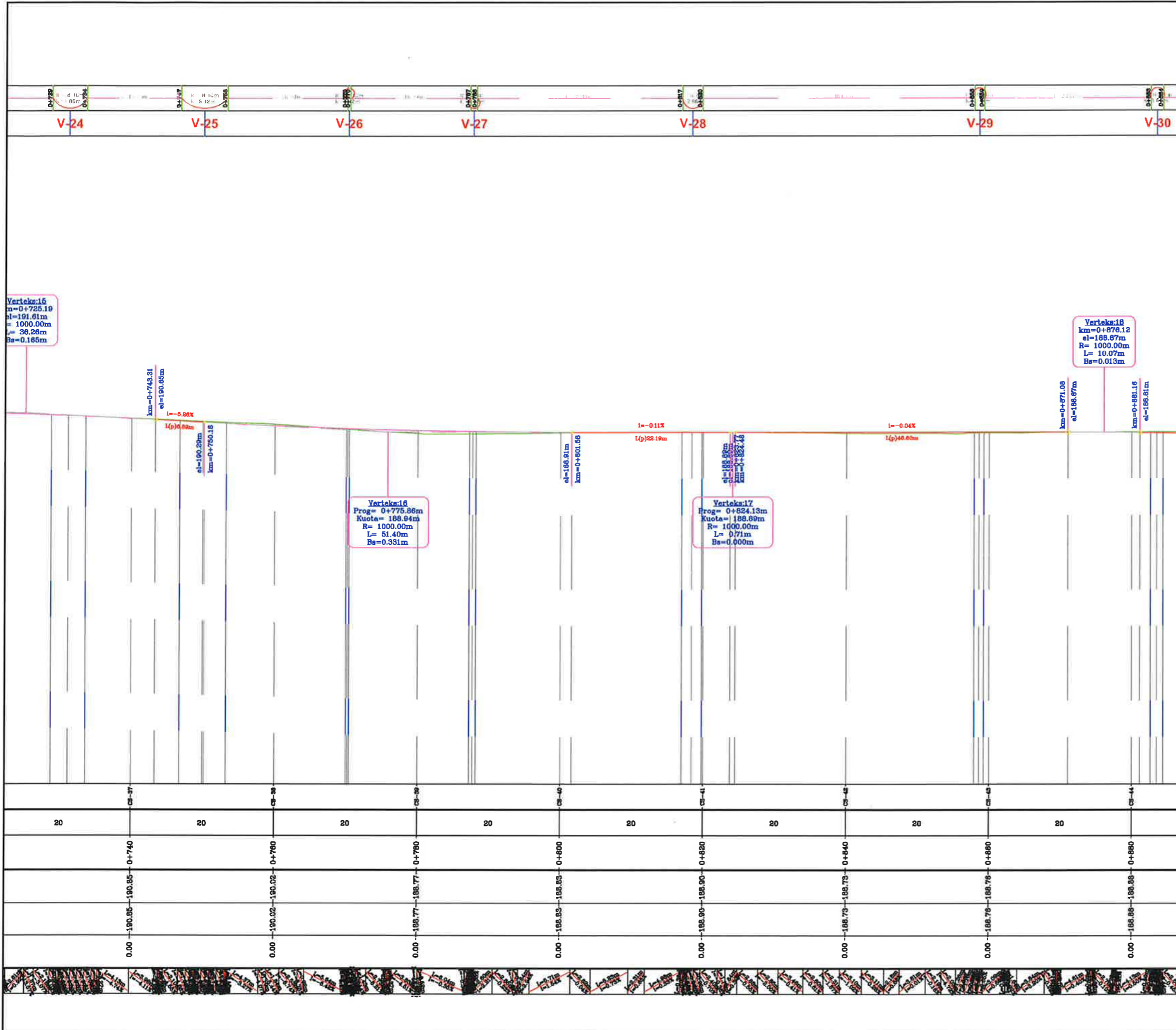

BASHKIA KAMËZ

DREJTORIA E PROJEKTEVE DHE INVESTIMEVE
DEPARTAMENTI I PROJEKTEVE

Dr. e Projekteve e Investimeve	FLORA MUCA
STAFI TEKNIK PROJEKTES	<ul style="list-style-type: none"> Ing. ERBLIN LALA Ing. ARJOLA KURTI Ing. DENIS PRENÇI Ing. EGLANTINA DISHA Ing. RAMADAN HYSA
Titulli i Projektit NDERTIM RRUGA "BETIM MUÇO"	
Faza e Projektit PROJEKT ZBATIMI	
Data e Implementimit :	
Shkalla e Vizatimit	
Emertimi i Fletës PROFILE TERTHORE	
Flota Nr. A-83	

NDERTIM RRUGA: "BETIM MUÇO" PROFILE TERTHORE

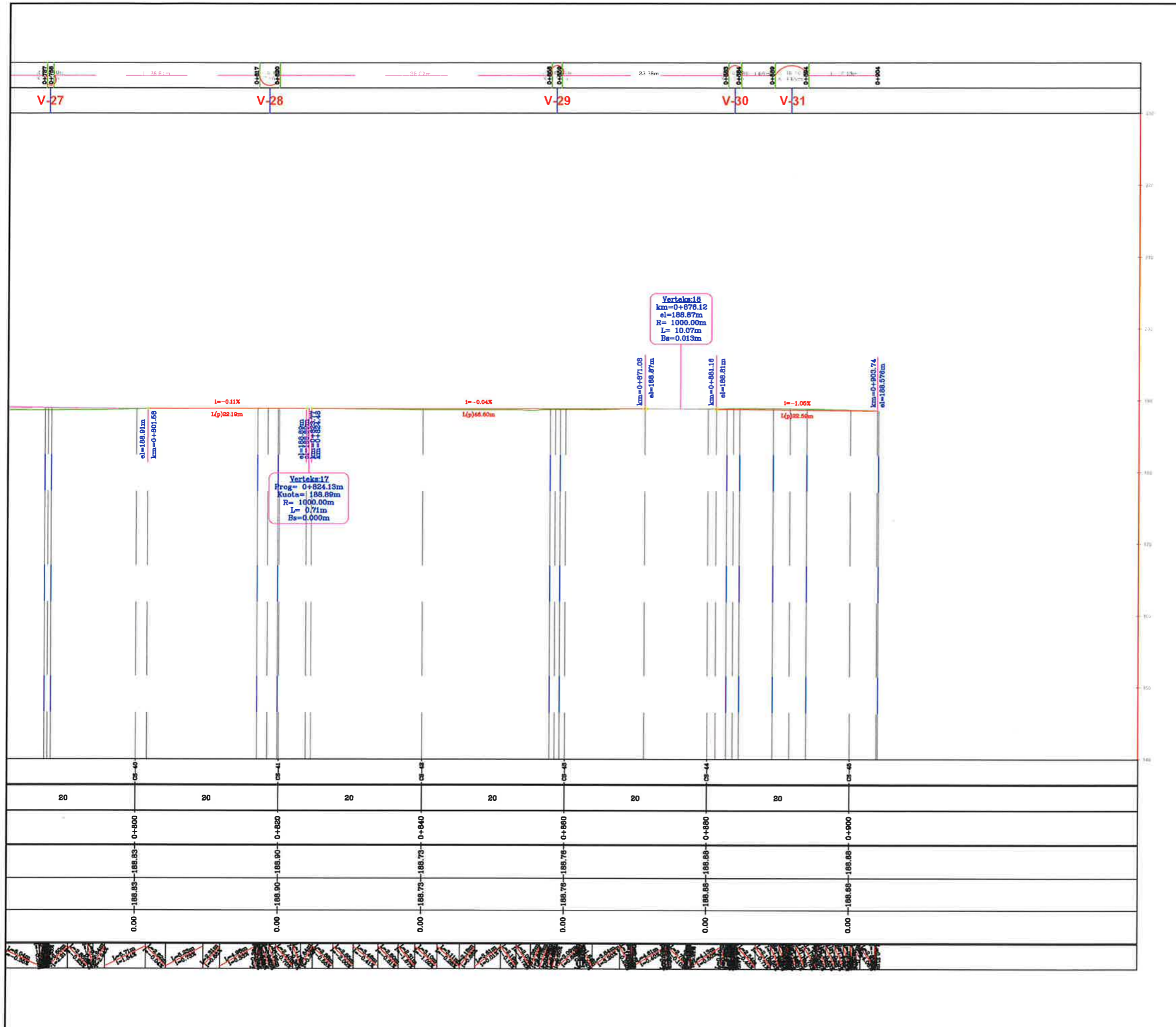

BASHKIA KAMËZ

DREJTORIA E PROJEKTEVE DHE INVESTIMEVE
DEPARTAMENTI I PROJEKTEVE

Dr. e Projektëve e Investimeve	FLORA MUCA															
STAFI TEKNIK PROJEKTES	<table style="width: 100%; border-collapse: collapse;"> <tr> <td style="width: 10%; text-align: center;">Ing.</td> <td style="width: 70%;">ERBLIN LALA</td> <td style="width: 20%;"></td> </tr> <tr> <td style="text-align: center;">Ing.</td> <td>ARJOLA KURTI</td> <td></td> </tr> <tr> <td style="text-align: center;">Ing.</td> <td>DENIS PRENÇI</td> <td></td> </tr> <tr> <td style="text-align: center;">Ing.</td> <td>EGLANTINA DISHA</td> <td></td> </tr> <tr> <td style="text-align: center;">Ing.</td> <td>RAMADAN HYSA</td> <td></td> </tr> </table>	Ing.	ERBLIN LALA		Ing.	ARJOLA KURTI		Ing.	DENIS PRENÇI		Ing.	EGLANTINA DISHA		Ing.	RAMADAN HYSA	
Ing.	ERBLIN LALA															
Ing.	ARJOLA KURTI															
Ing.	DENIS PRENÇI															
Ing.	EGLANTINA DISHA															
Ing.	RAMADAN HYSA															
Titulli i Projektit NDERTIM RRUGA "BETIM MUÇO"		Faza e Projektit PROJEKT ZBATIMI														
Emertimi i Fletes PROFILE TERTHORE		Data e Implementimit : Shkalla e Vizatimit Fieta Nr. A-84														