



PROJEKT ZBATIMI

Objekti: Ndertim kanalesh vadites, fshati Gorican, Bashkia Dimal

Projektues



ARENA MK
shpk

2024





	Titulli i projektit	Projektues	Viti	Emertimi i fletes
	Ndertim kanalesh vadites, fshati Gorican, Bashkia Dimal	 ARENA MK shpk	2024	Planimetri e pergjithshme





	Titulli i projektit	Projektues	Viti	Emertimi i fletes
	Ndertim kanalesh vadites, fshati Gorican, Bashkia Dimal	 ARENA MK shpk	2024	Planimetri kanali 1





	Titulli i projektit	Projektues	Viti	Emertimi i fletes
	Ndertim kanalesh vadites, fshati Gorican, Bashkia Dimal	 ARENA MK shpk	2024	Planimetri kanali 2





	Titulli i projektit	Projektues	Viti	Emertimi i fletes
	Ndertim kanalesh vadites, fshati Gorican, Bashkia Dimal	 ARENA MK shpk	2024	Planimetri kanali 3





 BASHKIA DIMAL	Titulli i projektit	Projektues	Viti	Emertimi i fletes
	Ndertim kanalesh vadites, fshati Gorican, Bashkia Dimal	 ARENA MK shpk	2024	Planimetri kanali 4





	Titulli i projektit	Projektues	Viti	Emertimi i fletes
	Ndertim kanalesh vadites, fshati Gorican, Bashkia Dimal	 ARENA MK shpk	2024	Planimetri kanali 5



	Titulli i projektit	Projektues	Viti	Emertimi i fletes
	Ndertim kanalesh vadites, fshati Gorican, Bashkia Dimal	 ARENA MK shpk	2024	Planimetri kanali 6





 BASHKIA DIMAL	Titulli i projektit	Projektues	Viti	Emertimi i fletes
	Ndertim kanalesh vadites, fshati Gorican, Bashkia Dimal	 ARENA MK shpk	2024	Planimetri kanali 7



Seman River

KANALI 8
L=986m

 BASHKIA DIMAL	<p>Titulli i projektit</p> <p>Ndertim kanalesh vadites, fshati Gorican, Bashkia Dimal</p>	<p>Projektues</p>  ARENA MK shpk	<p>Viti</p> <p>2024</p>	<p>Emertimi i fletes</p> <p>Planimetri kanali 8</p>
---	--	--	--------------------------------	--

103/29	103/29	98/25	97/
103/28	103/28	98/23	97/
103/27	103/27	98/22	97/
103/26	103/26	98/21	
103/25	103/25	98/20	
103/24	103/24	98/19	
103/23	103/23	98/18	9
103/22	103/22	98/17	
103/21	103/21	98/16	
103/20	103/20	98/15	97/
103/19	103/19	98/14	97/3
103/31	103/31	98/13	
103/18	103/18	98/12	
103/17	103/17	98/11	
103/16	103/16	98/10	
103/15	103/15	98/9	
103/14	103/14	98/8	
103/13	103/13	98/7	97
103/12	103/12	98/6	
103/11	103/11	98/5	97
103/10	103/10		
103/9	103/9		

KANALI 1

 <p>REPUBLIKA E SHQIPËRISË BASHKIA DIMAL</p>	AUTORITETI KONTRAKTOR : BASHKIA DIMAL	FAZA : PROJEKT ZBATIMI	EMËRTIMI I FLETËS :		KAPITULLI :	PROJEKTI ARKITEKTONIK
	HARTIMI I PROJEKTIT PËR OBJEKTIN : NDËRTIM KANALESH VADITËS , FSHATI GORICAN, BASHKIA DIMAL	 <p>PROJEKTUES : "ARENA MK" SHPK</p>	PLANVENDOSJE E PJESSHME nr.1, KANALI VADITËS 1		NR. I FLETËS :	A - 01
		SHKALLA E VIZATIMIT :	Sh 1:1	FORMATI I VIZATIMIT - A3	DATA :	DIMAL 2024

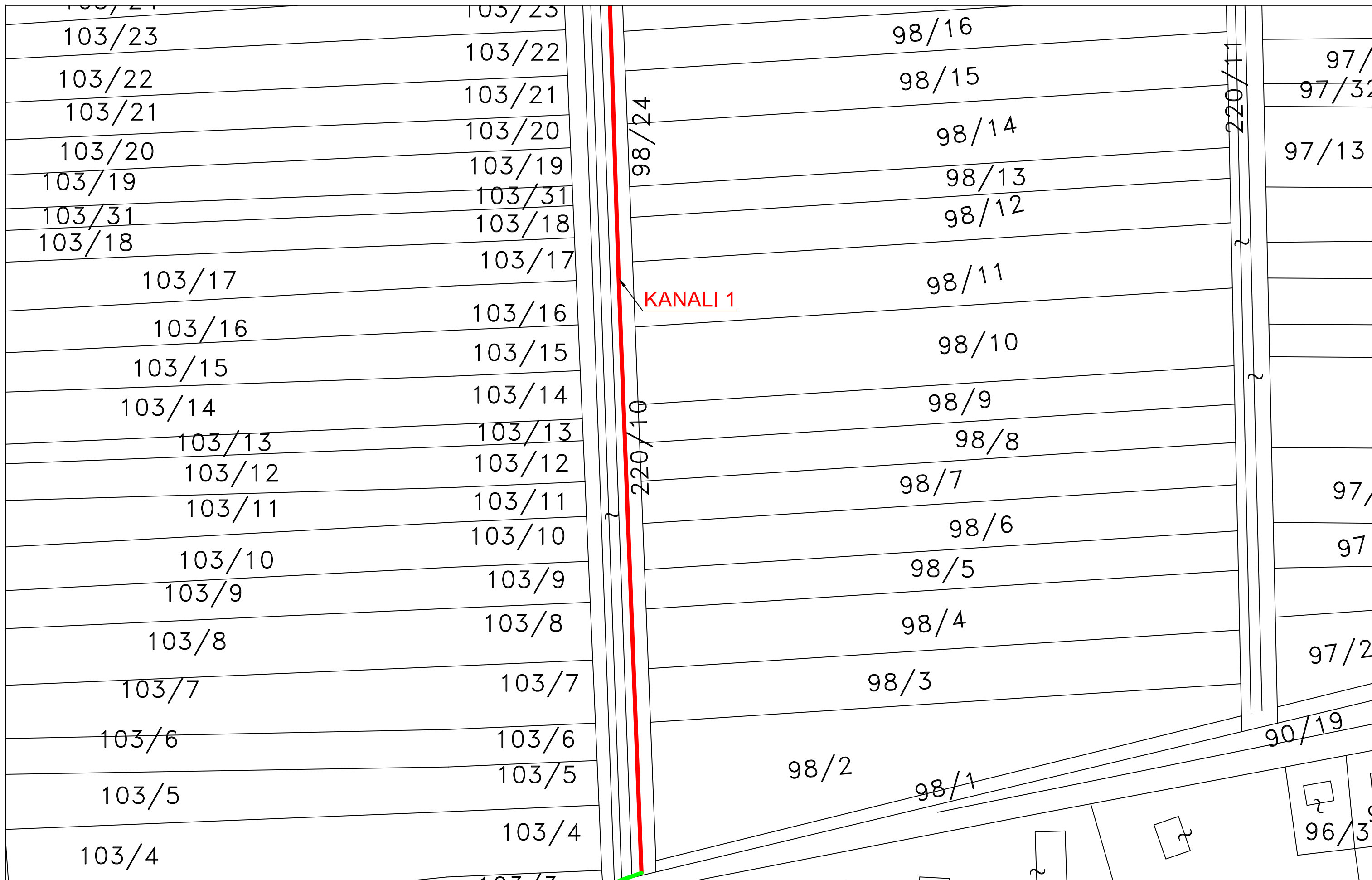

 REPUBLIKA E SHQIPËRISË BASHKIA DIMIAL	AUTORITETI KONTRAKTOR : BASHKIA DIMIAL	FAZA : PROJEKT ZBATIMI	EMËRTIMI I FLETËS :		KAPITULLI :	PROJEKTI ARKITEKTONIK
	HARTIMI I PROJEKTIT PËR OBJEKTIN : NDËRTIM KANALESH VADITËS , FSHATI GORICAN, BASHKIA DIMIAL	 "ARENA MK" SHPK	PLANVENDOSJE E PJESSHME nr.2, KANALI VADITËS 1		NR. I FLETËS :	A - 02
		SHKALLA E VIZATIMIT :	Sh 1:1	FORMATI I VIZATIMIT - A3	DATA :	DIMAL 2024

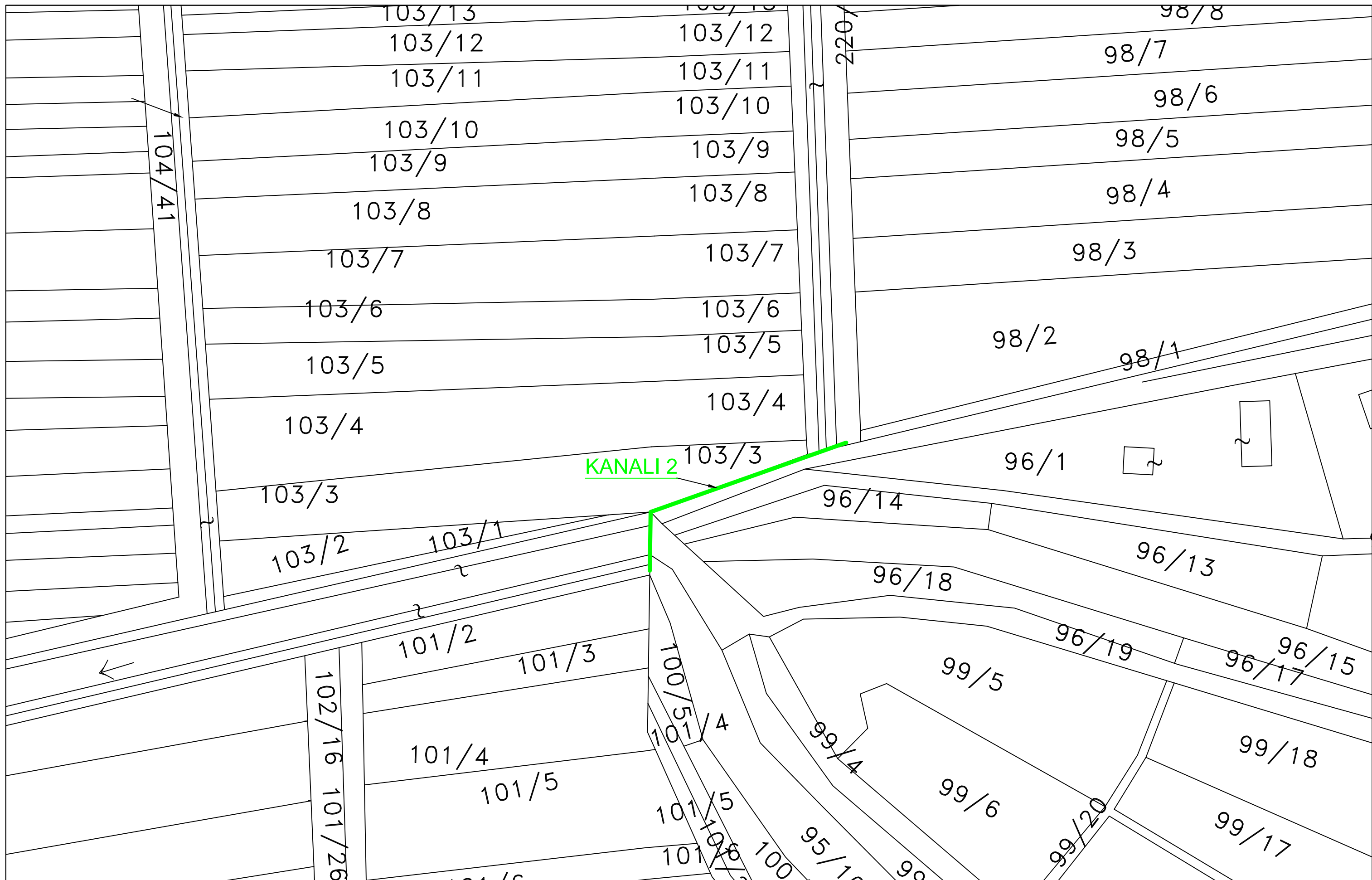

 <p>REPUBLIKA E SHQIPËRISË BASHKIA DIMAL</p>	AUTORITETI KONTRAKTOR : BASHKIA DIMAL	FAZA : PROJEKT ZBATIMI	EMËRTIMI I FLETËS :		KAPITULLI :	PROJEKTI ARKITEKTONIK
	HARTIMI I PROJEKTIT PËR OBJEKTIN : NDËRTIM KANALESH VADITËS , FSHATI GORICAN, BASHKIA DIMAL	 <p>PROJEKTUES : "ARENA MK" SHPK</p>	PLANVENDOSJE , KANALI VADITËS 2		NR. I FLETËS :	A - 03
			SHKALLA E VIZATIMIT : Sh 1:1	FORMATI I VIZATIMIT - A3	DATA :	DIMAL 2024

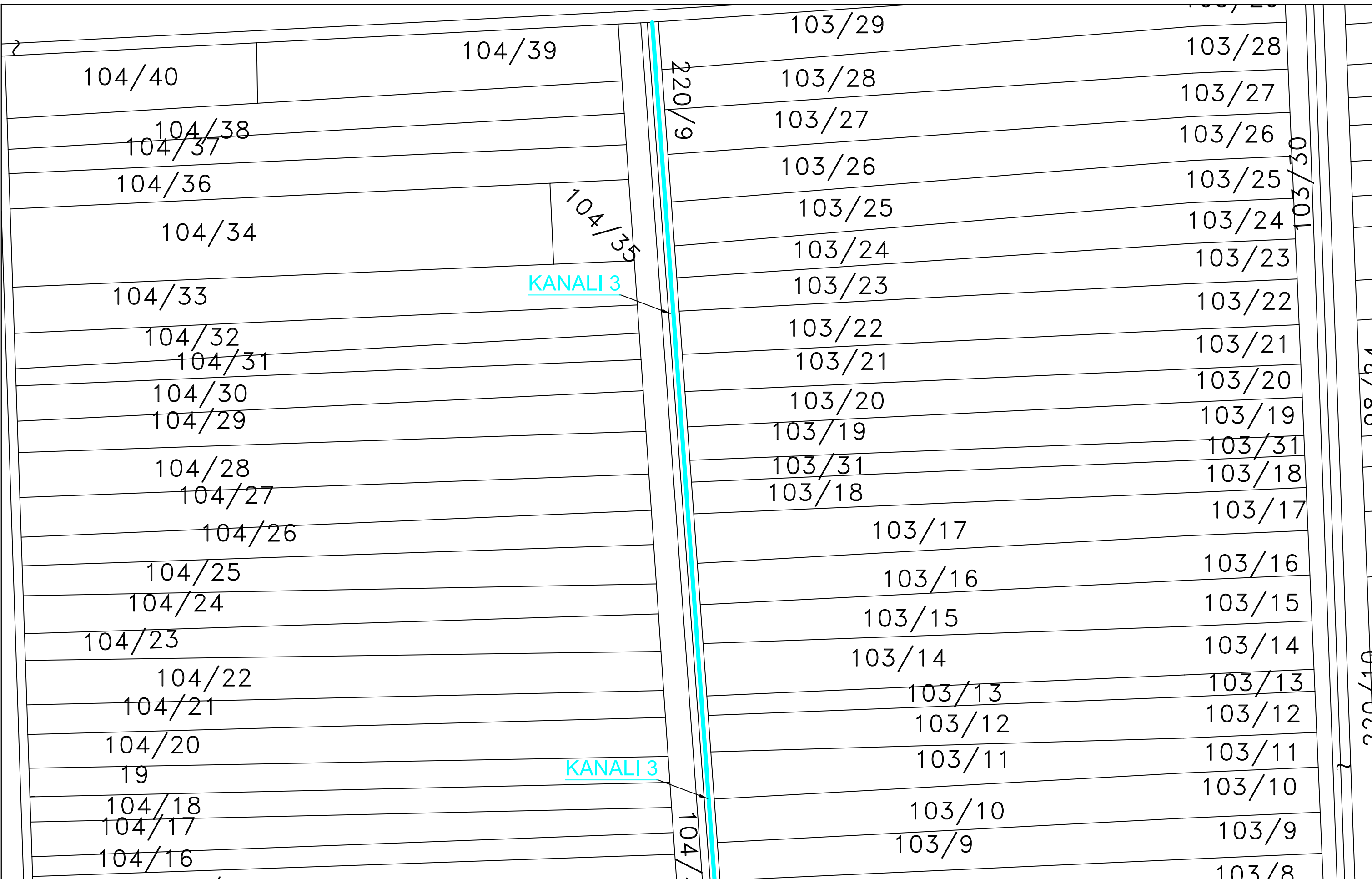

 <p>REPUBLIKA E SHQIPËRISË BASHKIA DIMAL</p>	<p>AUTORITETI KONTRAKTOR : BASHKIA DIMAL</p>	<p>FAZA : PROJEKT ZBATIMI</p>	<p>EMËRTIMI I FLETËS :</p>		<p>KAPITULLI :</p>	<p>PROJEKTI ARKITEKTONIK</p>
	<p>HARTIMI I PROJEKTIT PËR OBJEKTIN : NDËRTIM KANALESH VADITËS , FSHATI GORICAN, BASHKIA DIMAL</p>	 <p>PROJEKTUES : "ARENA MK" SHPK</p>	<p>PLANVENDOSJE E PJESSHME nr.1 , KANALI VADITËS 3</p>		<p>NR. I FLETËS :</p>	<p>A - 04</p>
			<p>SHKALLA E VIZATIMIT : Sh 1:1</p>	<p>FORMATI I VIZATIMIT - A3</p>	<p>DATA :</p>	<p>DIMAL 2024</p>



 <p>REPUBLIKA E SHQIPËRISË BASHKIA DIMAL</p>	<p>AUTORITETI KONTRAKTOR : BASHKIA DIMAL</p>	<p>FAZA : PROJEKT ZBATIMI</p>	<p>EMËRTIMI I FLETËS :</p>		<p>KAPITULLI :</p>	<p>PROJEKTI ARKITEKTONIK</p>
	<p>HARTIMI I PROJEKTIT PËR OBJEKTIN : NDËRTIM KANALESH VADITËS , FSHATI GORICAN, BASHKIA DIMAL</p>	 <p>PROJEKTUES : "ARENA MK" SHPK</p>	<p>PLANVENDOSJE E PJESSHME nr.2 , KANALI VADITËS 3</p>		<p>NR. I FLETËS :</p>	<p>A - 05</p>
			<p>SHKALLA E VIZATIMIT : Sh 1:1</p>	<p>FORMATI I VIZATIMIT - A3</p>	<p>DATA :</p>	<p>DIMAL 2024</p>

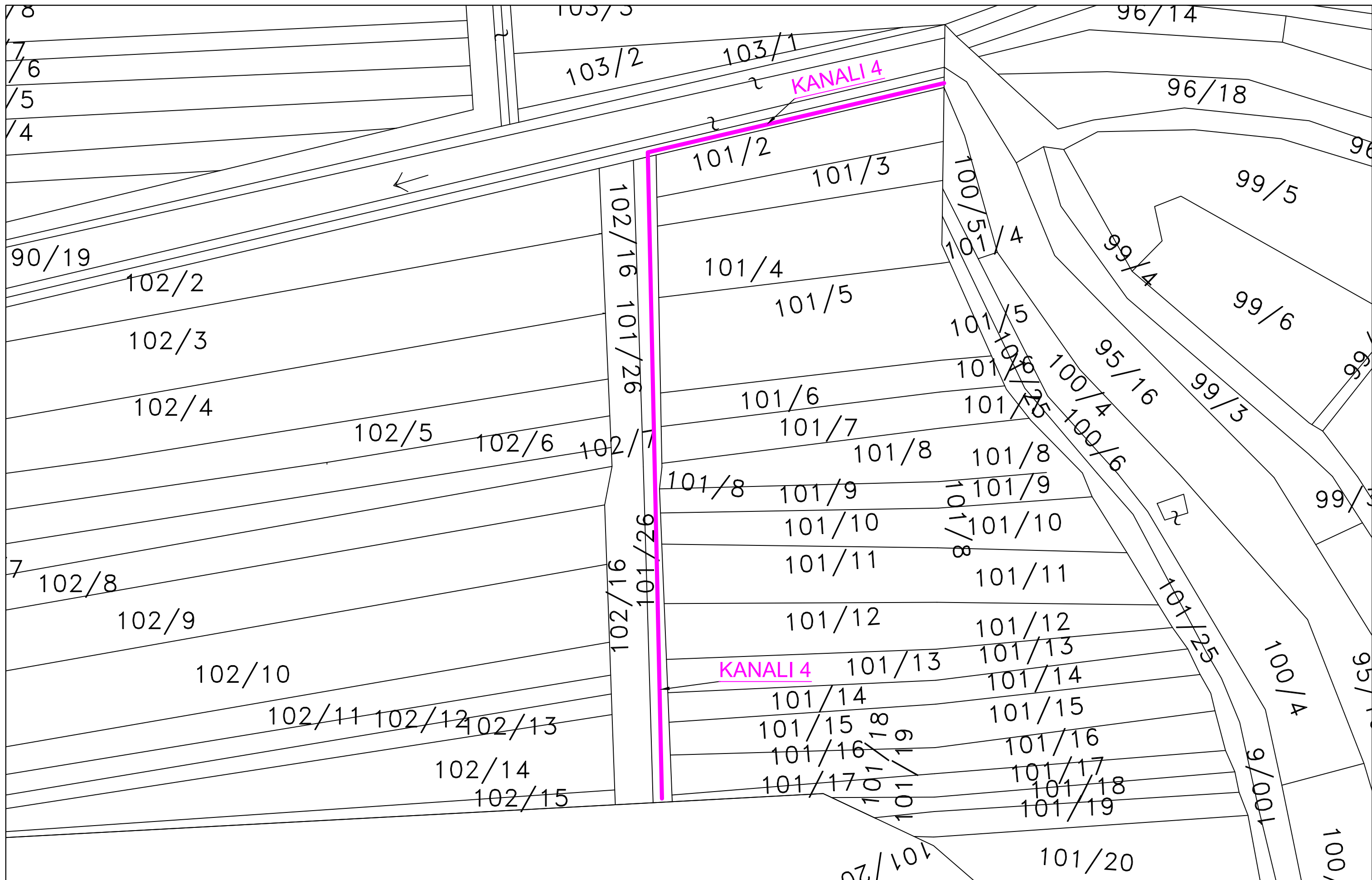

 <p>REPUBLIKA E SHQIPËRISË BASHKIA DIMAL</p>	<p>AUTORITETI KONTRAKTOR : BASHKIA DIMAL</p>	<p>FAZA : PROJEKT ZBATIMI</p>	<p>EMËRTIMI I FLETËS :</p>		<p>KAPITULLI :</p>
	<p>HARTIMI I PROJEKTIT PËR OBJEKTIN : NDËRTIM KANALESH VADITËS , FSHATI GORICAN, BASHKIA DIMAL</p>	 <p>PROJEKTUES : "ARENA MK" SHPK</p>	<p>PLANVENDOSJE , KANALI VADITËS 4</p>		<p>NR. I FLETËS : A - 06</p>
		<p>SHKALLA E VIZATIMIT : Sh 1:1</p>	<p>FORMATI I VIZATIMIT - A3</p>	<p>DATA :</p>	<p>DIMAL 2024</p>

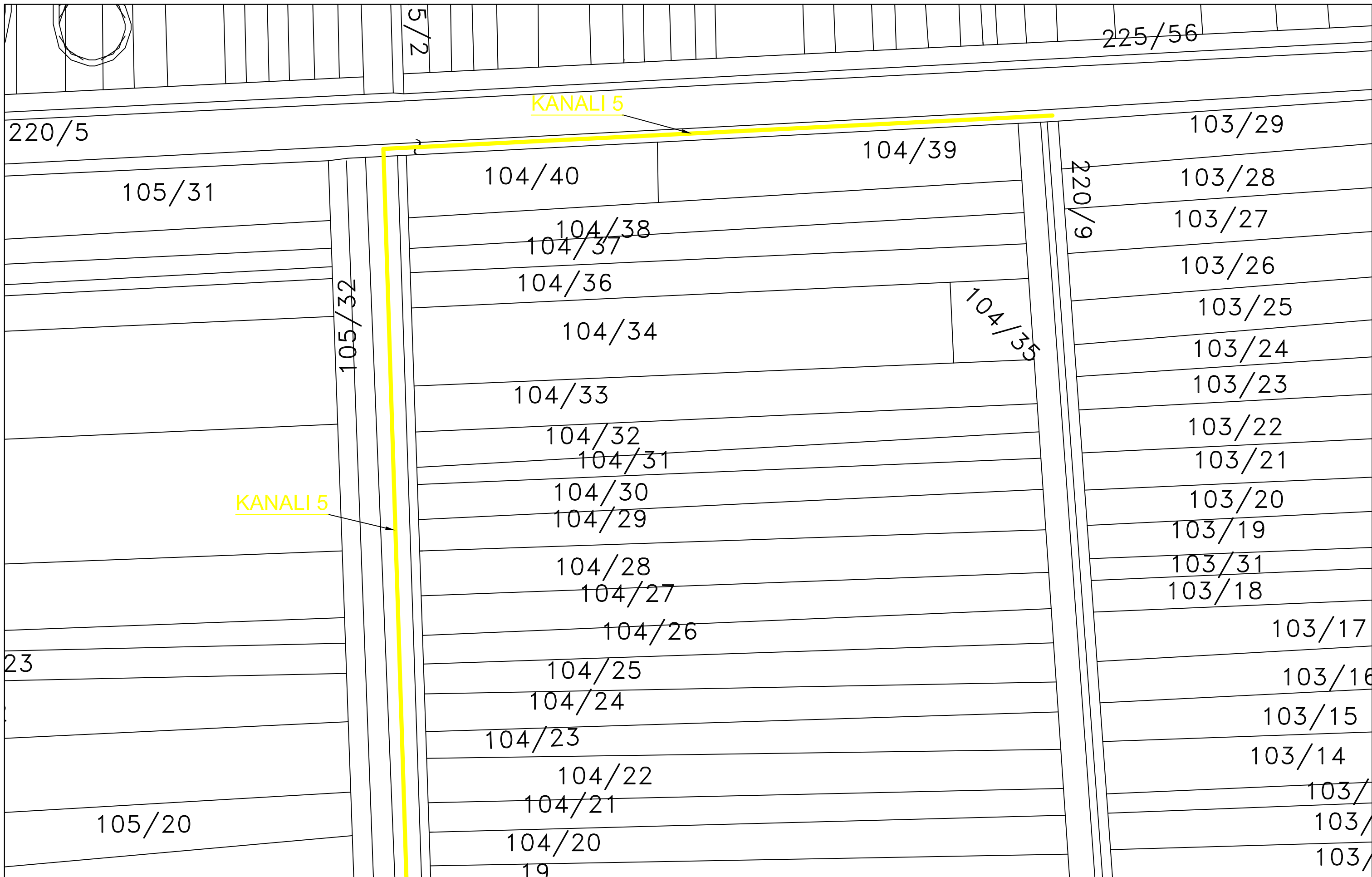

 REPUBLIKA E SHQIPËRISË BASHKIA DIMAL	AUTORITETI KONTRAKTOR : BASHKIA DIMAL	FAZA : PROJEKT ZBATIMI	EMËRTIMI I FLETËS :		KAPITULLI :	PROJEKTI ARKITEKTONIK	
	HARTIMI I PROJEKTIT PËR OBJEKTIN : NDËRTIM KANALESH VADITËS , FSHATI GORICAN, BASHKIA DIMAL	 PROJEKTUES : "ARENA MK" SHPK	PLANVENDOSJE E PJESSHME nr.1 , KANALI VADITËS 5		NR. I FLETËS :	A - 07	
			SHKALLA E VIZATIMIT :	Sh 1:1	FORMATI I VIZATIMIT - A3	DATA :	DIMAL 2024

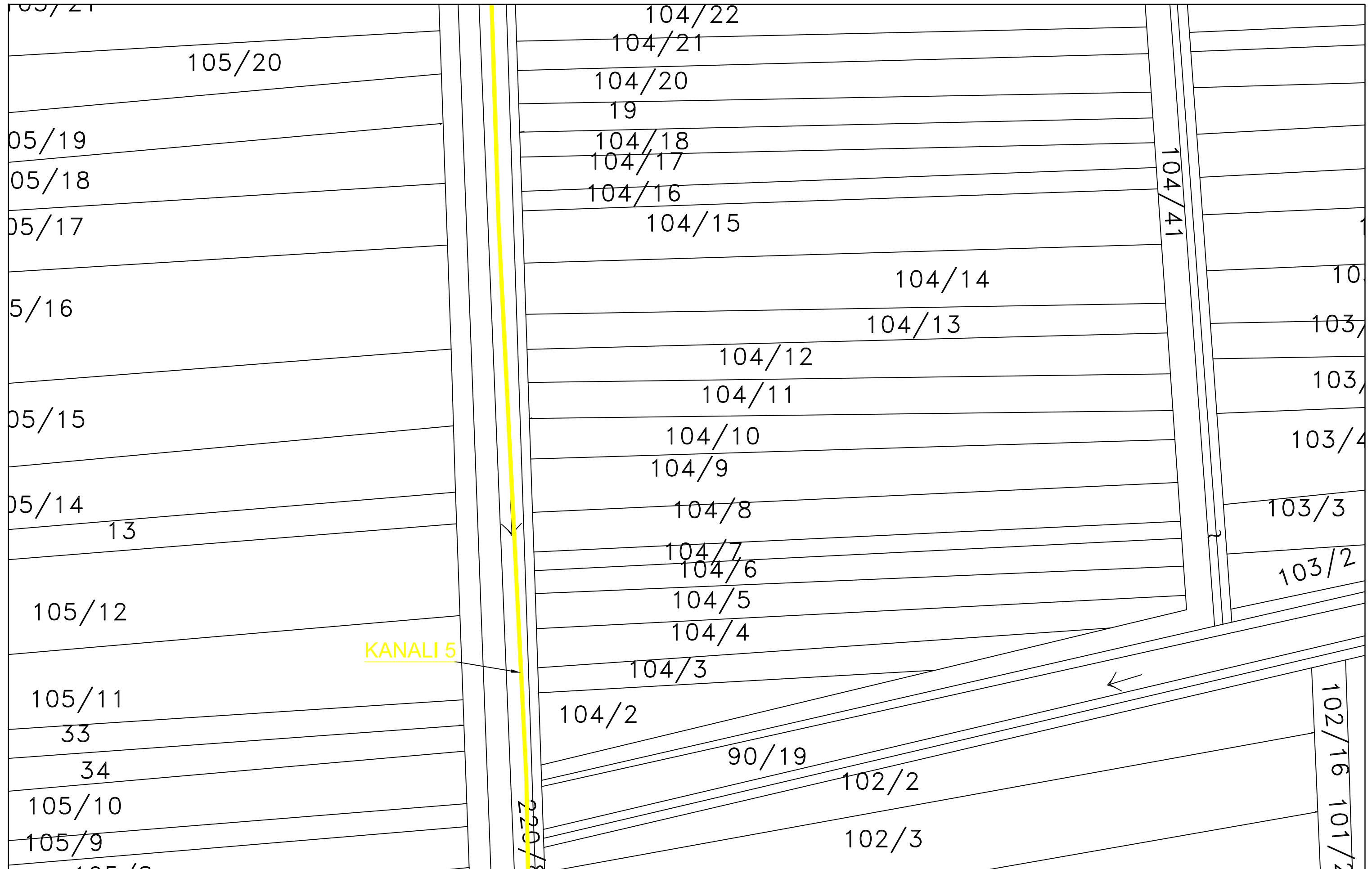

 REPUBLIKA E SHQIPËRISË BASHKIA DIMAL	AUTORITETI KONTRAKTOR : BASHKIA DIMAL	FAZA : PROJEKT ZBATIMI	EMËRTIMI I FLETËS :		KAPITULLI :	PROJEKTI ARKITEKTONIK	
	HARTIMI I PROJEKTIT PËR OBJEKTIN : NDËRTIM KANALESH VADITËS , FSHATI GORICAN, BASHKIA DIMAL	 PROJEKTUES : "ARENA MK" SHPK	PLANVENDOSJE E PJESSHME nr.2 , KANALI VADITËS 5		NR. I FLETËS :	A - 08	
			SHKALLA E VIZATIMIT :	Sh 1:1	FORMATI I VIZATIMIT - A3	DATA :	DIMAL 2024



 REPUBLIKA E SHQIPËRISË BASHKIA DIMAL	AUTORITETI KONTRAKTOR : BASHKIA DIMAL	FAZA : PROJEKT ZBATIMI	EMËRTIMI I FLETËS :		KAPITULLI :	PROJEKTI ARKITEKTONIK	
	HARTIMI I PROJEKTIT PËR OBJEKTIN : NDËRTIM KANALESH VADITËS , FSHATI GORICAN, BASHKIA DIMAL	 PROJEKTUES : "ARENA MK" SHPK	PLANVENDOSJE E PJESSHME nr.3 , KANALI VADITËS 5		NR. I FLETËS :	A - 09	
			SHKALLA E VIZATIMIT :	Sh 1:1	FORMATI I VIZATIMIT - A3	DATA :	DIMAL 2024

220/5

105/31

106/1

105/30

105/29

105/36

105/28

106/2

105/27

106/3

KANALI 6

105/26

106/4

105/25

106/5

24

106/6

23

106/7

105/22

106/8

105/21

106/9

105/20

106/10

105/19

106/11

105/18

106/12

105/17

107/24

22



REPUBLIKA E SHQIPËRISË
BASHKIA DIMAL

AUTORITETI KONTRAKTOR : BASHKIA DIMAL

HARTIMI I PROJEKTIT PËR OBJEKTIN :
NDËRTIM KANALESH VADITËS , FSHATI GORICAN,
BASHKIA DIMAL

FAZA : PROJEKT ZBATIMI



PROJEKTUES :
"ARENA MK" SHPK

EMËRTIMI I FLETËS :

PLANVENDOSJE E PJESSHME nr.1 , KANALI VADITËS 6

SHKALLA E VIZATIMIT :

Sh 1:1

FORMATI I VIZATIMIT - A3

KAPITULLI :

PROJEKTI
ARKITEKTONIK

NR. I FLETËS :

A - 10

DATA :

DIMAL 2024

105/18

105/19

105/20

105/21

32

106/22

106/23

106/23

106/24

106/25

106/26

106/27

106/28

106/29

106/30 106/31

KANALI 6

105/12

105/11

33

34

105/10

105/9

105/8

105/7

105

105/6

105/37

105/5

105/4

105/3

105/2

105/1

105/7

220/7

107/24

220/6

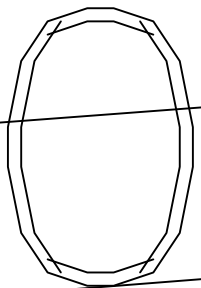

CLIRIM



REPUBLIKA E SHQIPËRISË
BASHKIA DIMAL

AUTORITETI KONTRAKTOR : BASHKIA DIMAL

HARTIMI I PROJEKTIT PËR OBJEKTIN :
NDËRTIM KANALESH VADITËS , FSHATI GORICAN,
BASHKIA DIMAL

FAZA : PROJEKT ZBATIMI



PROJEKTUES :
"ARENA MK" SHPK

EMËRTIMI I FLETËS :

PLANVENDOSJE E PJESSHME nr.2 , KANALI VADITËS 6

SHKALLA E VIZATIMIT :

Sh 1:1

FORMATI I VIZATIMIT - A3

KAPITULLI :

NR. I FLETËS :

DATA :

PROJEKTI
ARKITEKTONIK

A - 11

DIMAL 2024

24/1

24/2

107/23

107/22

21
20

107/19

107/18

24/3

24/4

24/5

107/17

24/6

24/7

KANALI 7

24/24

107/16

24/8

24/9

107/15

24/10

107/14

24/11

13

341/20

42

NOVICE



REPUBLIKA E SHQIPËRISË
BASHKIA DIMAL

AUTORITETI KONTRAKTOR : BASHKIA DIMAL

HARTIMI I PROJEKTIT PËR OBJEKTIN :
NDËRTIM KANALESH VADITËS , FSHATI GORICAN,
BASHKIA DIMAL

FAZA : PROJEKT ZBATIMI



PROJEKTUES :
"ARENA MK" SHPK

EMËRTIMI I FLETËS :

PLANVENDOSJE E PJESSHME nr.1, KANALI VADITËS 7

SHKALLA E VIZATIMIT :

Sh 1:1

FORMATI I VIZATIMIT - A3

KAPITULLI :

PROJEKTI
ARKITEKTONIK

NR. I FLETËS :

A - 12

DATA :

DIMAL 2024

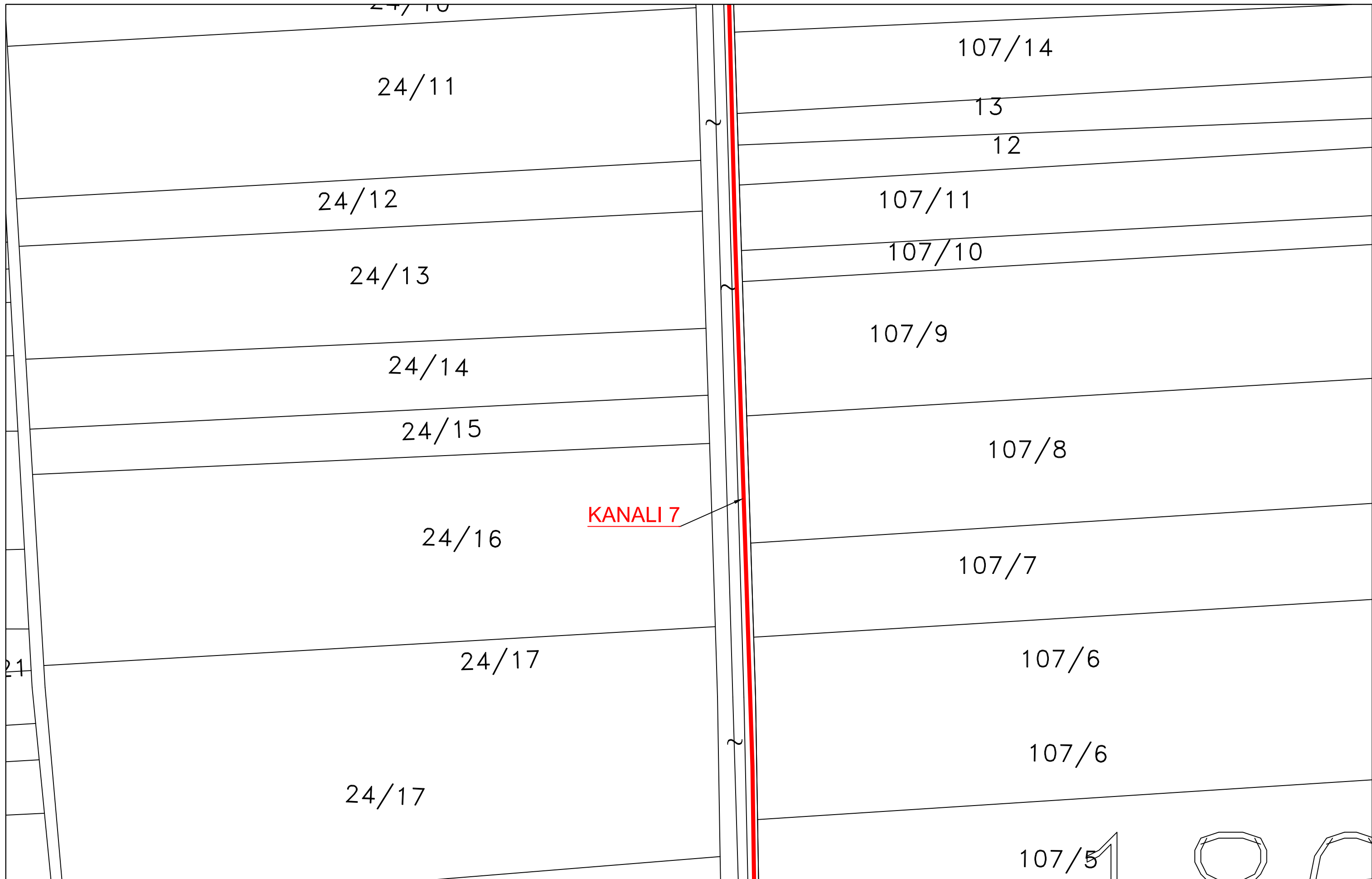

 <p>REPUBLIKA E SHQIPËRISË BASHKIA DIMAL</p>	<p>AUTORITETI KONTRAKTOR : BASHKIA DIMAL</p>	<p>FAZA : PROJEKT ZBATIMI</p>	<p>EMËRTIMI I FLETËS :</p>		<p>KAPITULLI :</p>	<p>PROJEKTI ARKITEKTONIK</p>
	<p>HARTIMI I PROJEKTIT PËR OBJEKTIN : NDËRTIM KANALESH VADITËS , FSHATI GORICAN, BASHKIA DIMAL</p>	 <p>PROJEKTUES : "ARENA MK" SHPK</p>	<p>PLANVENDOSJE E PJESSHME nr.2, KANALI VADITËS 7</p>	<p>NR. I FLETËS :</p>	<p>A - 13</p>	<p>DATA :</p>
		<p>SHKALLA E VIZATIMIT :</p>	<p>Sh 1:1</p>	<p>FORMATI I VIZATIMIT - A3</p>		

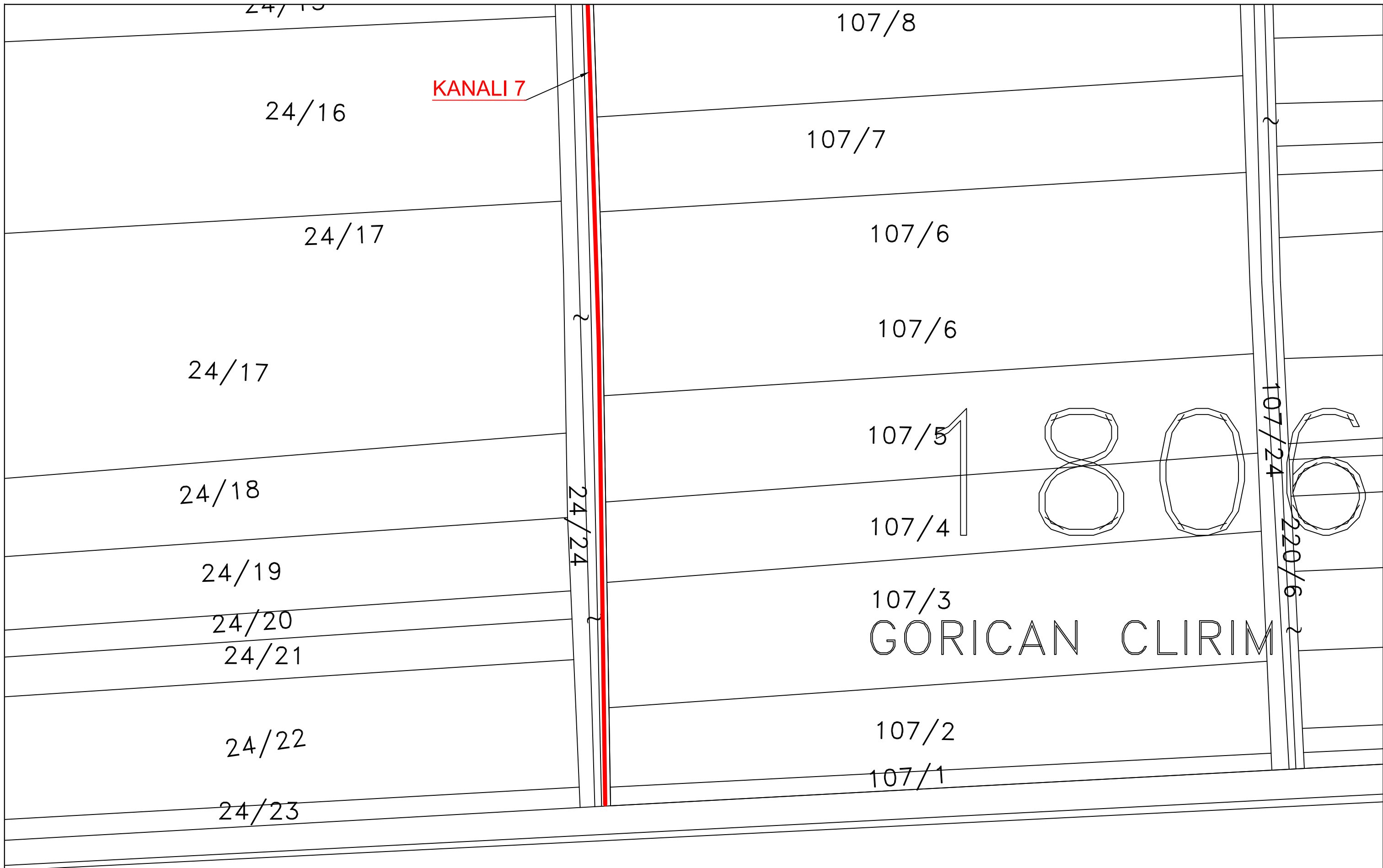

KANALI 7

GORICAN CLIRIM

800

 <p>REPUBLIKA E SHQIPËRISË BASHKIA DIMAL</p>	<p>AUTORITETI KONTRAKTOR : BASHKIA DIMAL</p>	<p>FAZA : PROJEKT ZBATIMI</p>	<p>EMËRTIMI I FLETËS :</p>		<p>KAPITULLI :</p>	<p>PROJEKTI ARKITEKTONIK</p>
	<p>HARTIMI I PROJEKTIT PËR OBJEKTIN : NDËRTIM KANALESH VADITËS , FSHATI GORICAN, BASHKIA DIMAL</p>	 <p>PROJEKTUES : "ARENA MK" SHPK</p>	<p>PLANVENDOSJE E PJESSHME nr.3, KANALI VADITËS 7</p>		<p>NR. I FLETËS :</p>	<p>A - 14</p>
		<p>SHKALLA E VIZATIMIT : Sh 1:1</p>	<p>FORMATI I VIZATIMIT - A3</p>	<p>DATA :</p>	<p>DIMAL 2024</p>	

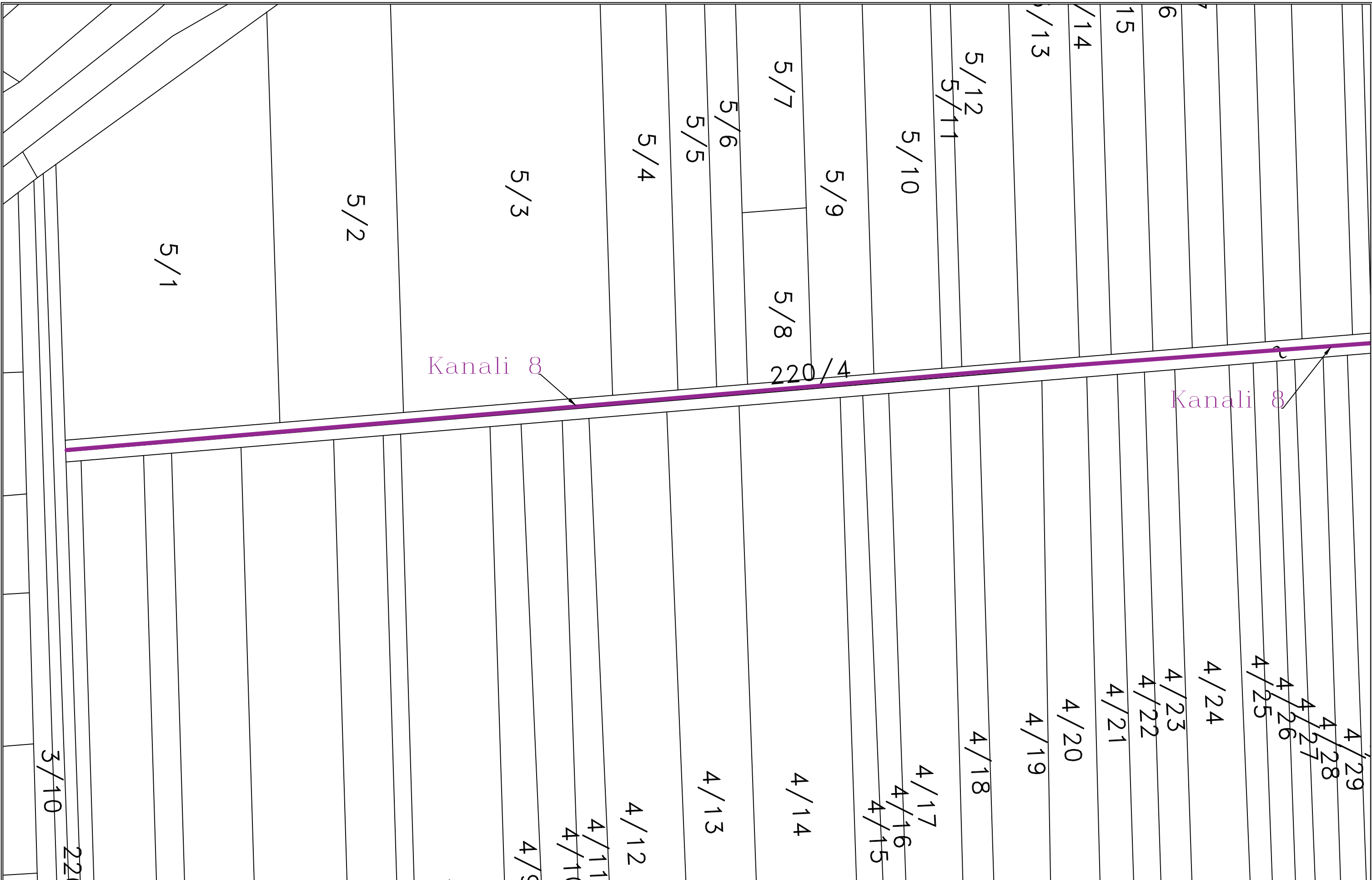

REPUBLIKA E SHQIPËRISË
BASHKIA DIMAL

AUTORITETI KONTRAKTOR : BASHKIA DIMAL

HARTIMI I PROJEKTIT PËR OBJEKTIN :
NDËRTIM KANALESH VADITËS , FSHATI GORICAN,
BASHKIA DIMAL



FAZA : PROJEKT ZBATIMI

PROJEKTUES :
"ARENA MK" SHPK

EMËRTIMI I FLETËS :

PLANVENDOSJE E PJESSHME nr.1, KANALI VADITËS 8

SHKALLA E VIZATIMIT :

Sh 1:1

FORMATI I VIZATIMIT - A3

KAPITULLI :

PROJEKTI
ARKITEKTONIK

NR. I FLETËS :

A - 15

DATA :

DIMAL 2024

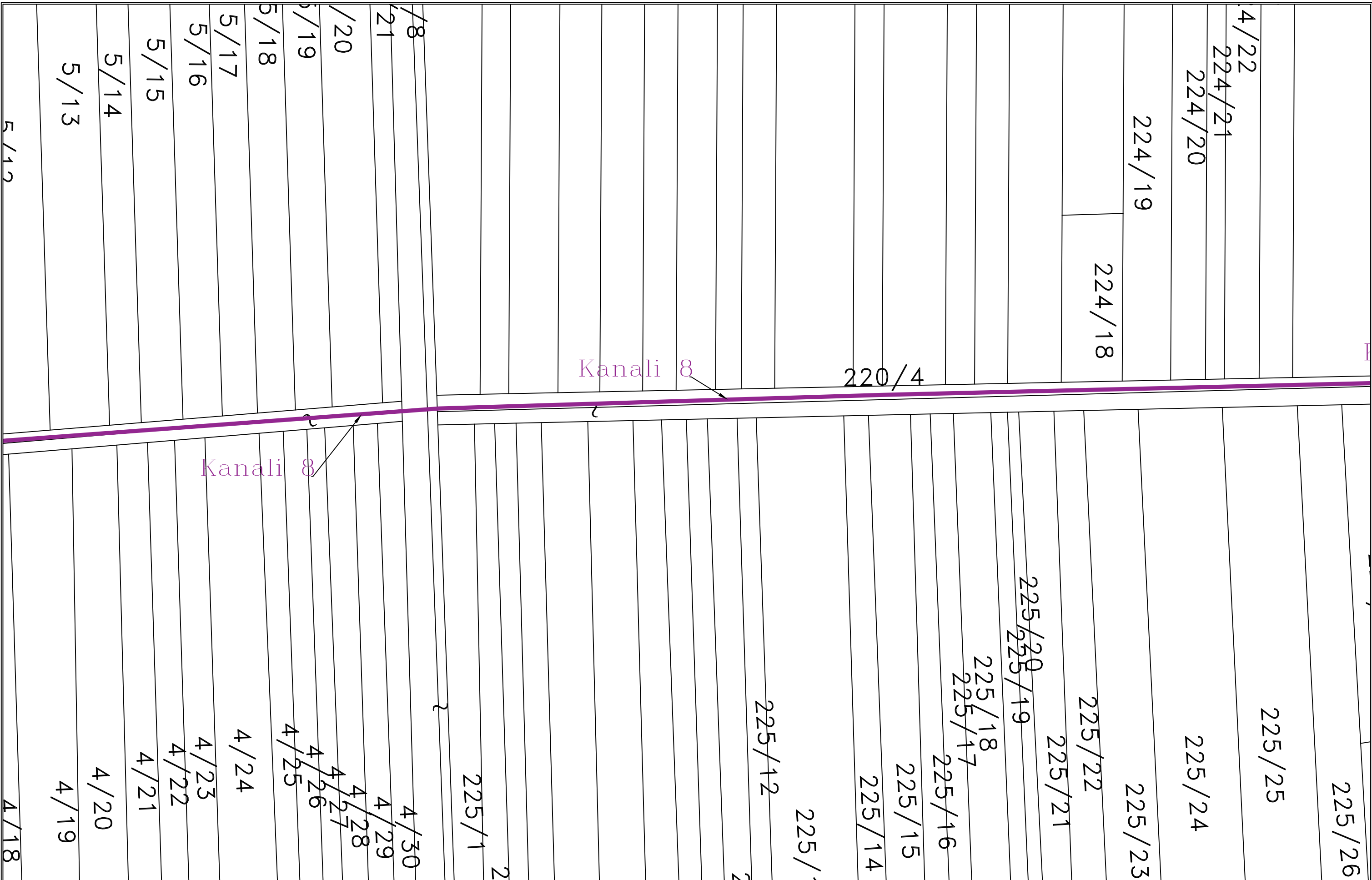

 <p>REPUBLIKA E SHQIPËRISË BASHKIA DIMAL</p>	<p>AUTORITETI KONTRAKTOR : BASHKIA DIMAL</p>	<p>FAZA : PROJEKT ZBATIMI</p>	<p>EMËRTIMI I FLETËS :</p>		<p>KAPITULLI :</p>	<p>PROJEKTI ARKITEKTONIK</p>
	<p>HARTIMI I PROJEKTIT PËR OBJEKTIN : NDËRTIM KANALESH VADITËS , FSHATI GORICAN, BASHKIA DIMAL</p>	 <p>PROJEKTUES : "ARENA MK" SHPK</p>	<p>PLANVENDOSJE E PJESSHME nr.2, KANALI VADITËS 8</p>		<p>NR. I FLETËS :</p>	<p>A - 16</p>
		<p>SHKALLA E VIZATIMIT :</p>	<p>Sh 1:1</p>	<p>FORMATI I VIZATIMIT - A3</p>	<p>DATA :</p>	<p>DIMAL 2024</p>

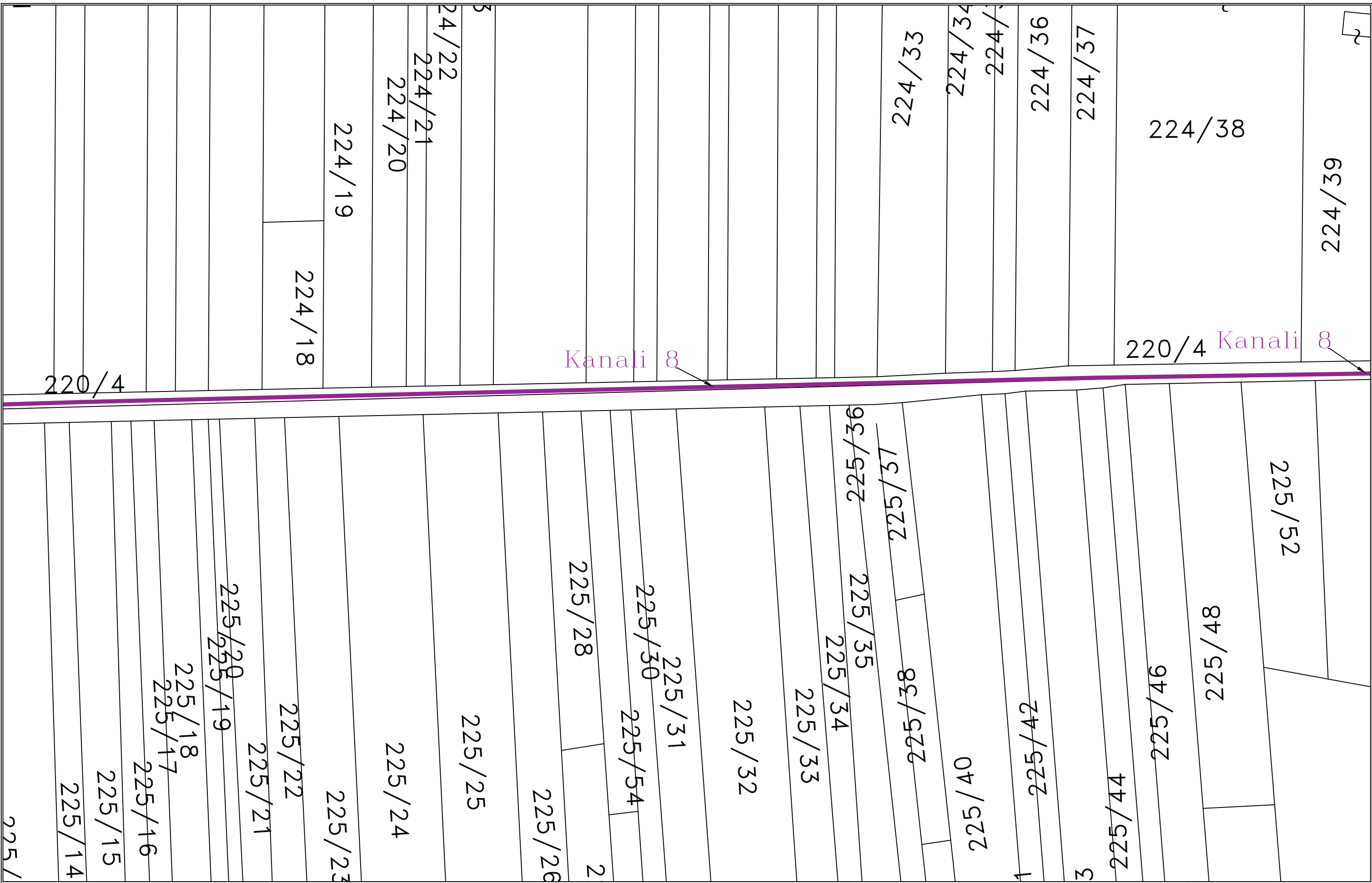

 <p>REPUBLIKA E SHQIPËRISË BASHKIA DIMAL</p>	<p>AUTORITETI KONTRAKTOR : BASHKIA DIMAL</p>	<p>FAZA : PROJEKT ZBATIMI</p>	<p>EMËRTIMI I FLETËS :</p>		<p>KAPITULLI :</p>	<p>PROJEKTI ARKITEKTONIK</p>
	<p>HARTIMI I PROJEKTIT PËR OBJEKTIN : NDËRTIM KANALESH VADITËS , FSHATI GORICAN, BASHKIA DIMAL</p>	 <p>PROJEKTUES : "ARENA MK" SHPK</p>	<p>PLANVENDOSJE E PJESSHME nr.3, KANALI VADITËS 8</p>	<p>SHKALLA E VIZATIMIT : Sh 1:1</p>	<p>FORMATI I VIZATIMIT - A3</p>	<p>NR. I FLETËS : A - 17</p>

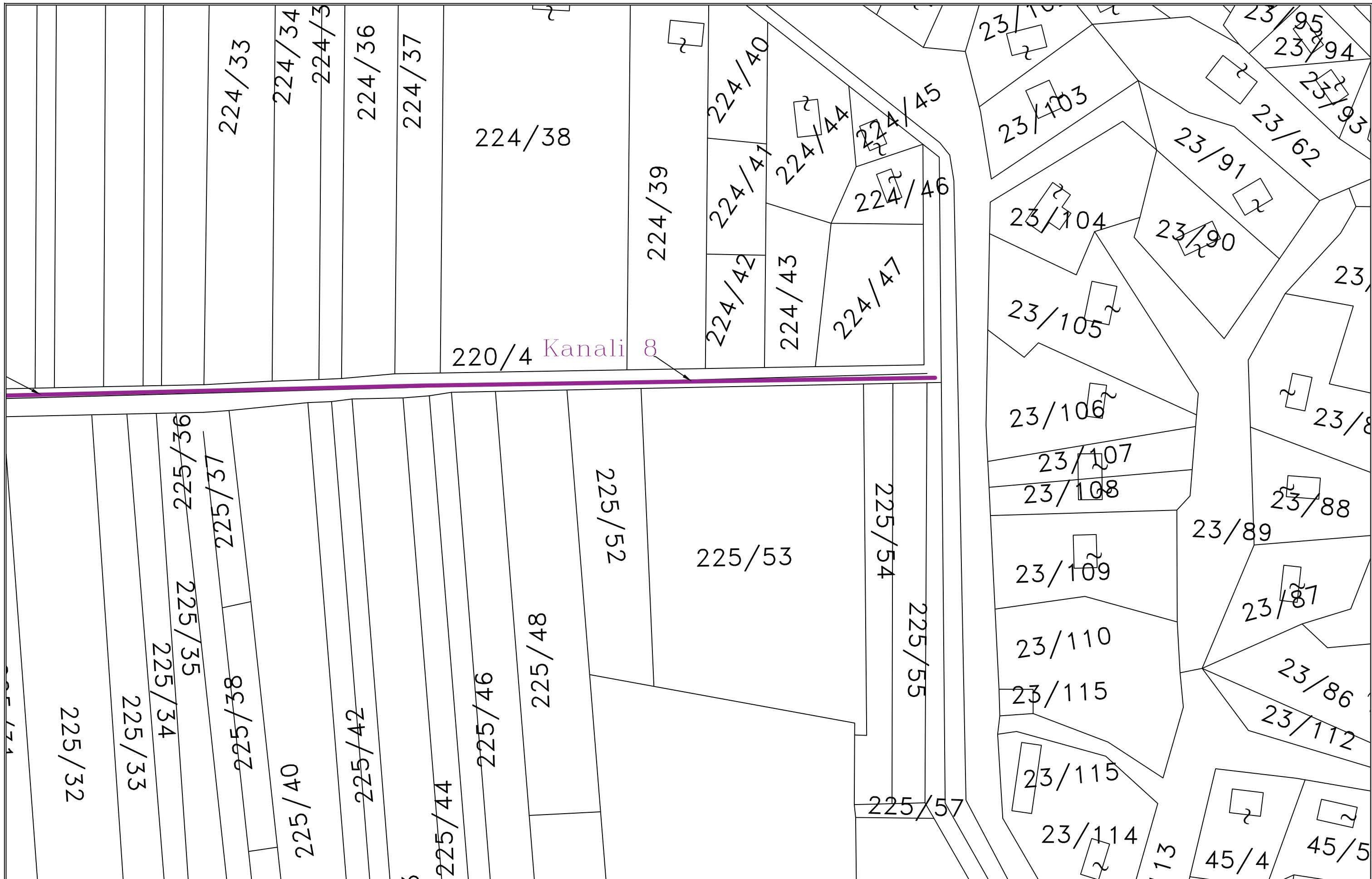

 <p>REPUBLIKA E SHQIPËRISË BASHKIA DIMAL</p>	<p>AUTORITETI KONTRAKTOR : BASHKIA DIMAL</p>	<p>FAZA : PROJEKT ZBATIMI</p>	<p>EMËRTIMI I FLETËS :</p>		<p>KAPITULLI :</p>	<p>PROJEKTI ARKITEKTONIK</p>
	<p>HARTIMI I PROJEKTIT PËR OBJEKTIN : NDËRTIM KANALESH VADITËS , FSHATI GORICAN, BASHKIA DIMAL</p>	 <p>PROJEKTUES : "ARENA MK" SHPK</p>	<p>PLANVENDOSJE E PJESSHME nr.4, KANALI VADITËS 8</p>		<p>NR. I FLETËS :</p>	<p>A - 18</p>
		<p>SHKALLA E VIZATIMIT : Sh 1:1</p>	<p>FORMATI I VIZATIMIT - A3</p>	<p>DATA :</p>	<p>DIMAL 2024</p>	

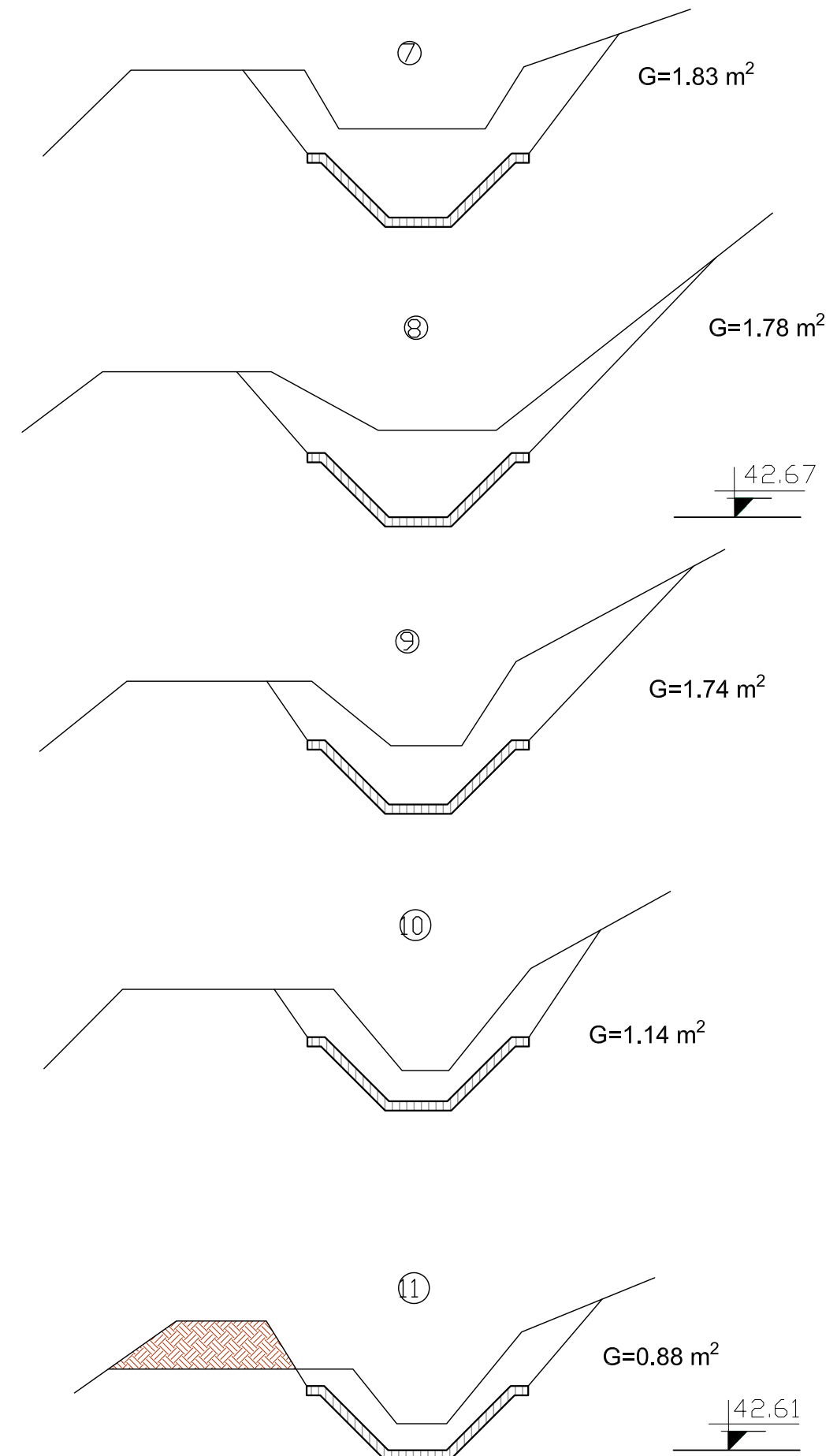
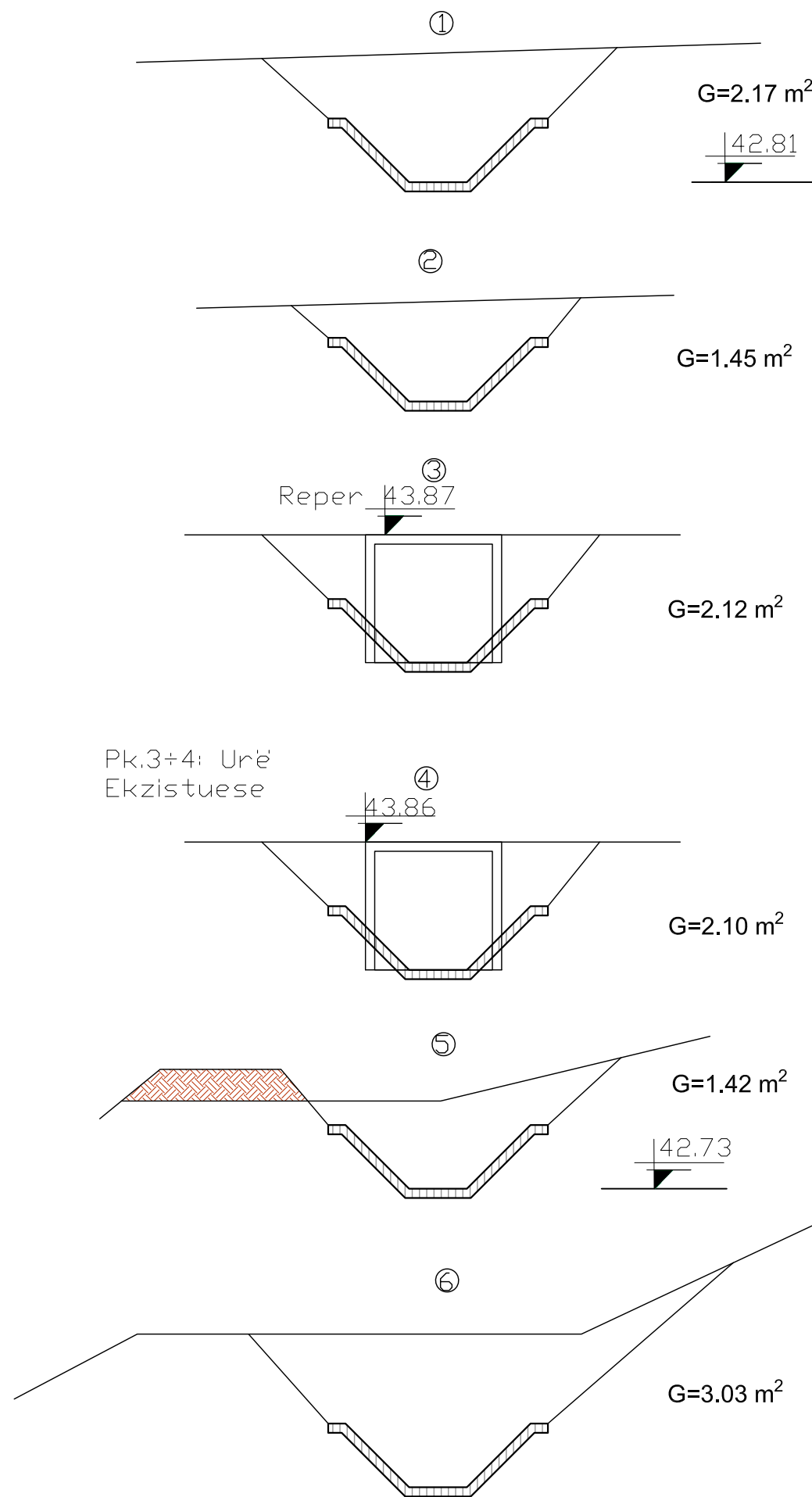

 <p>REPUBLIKA E SHQIPËRISË BASHKIA DIMAL</p>	AUTORITETI KONTRAKTOR : BASHKIA DIMAL	FAZA : PROJEKT ZBATIMI	EMËRTIMI I FLETËS :		KAPITULLI :	PROJEKTI ARKITEKTONIK
	HARTIMI I PROJEKTIT PËR OBJEKTIN : NDËRTIM KANALESH VADITËS , FSHATI GORICAN, BASHKIA DIMAL	 <p>PROJEKTUES : "ARENA MK" SHPK</p>	PROFILE TËRTHORE, PIKETA 1-11, KANALI VADITËS 8		NR. I FLETËS :	A - 19
			SHKALLA E VIZATIMIT : Sh 1:5	FORMATI I VIZATIMIT - A 3	DATA :	DIMAL 2024

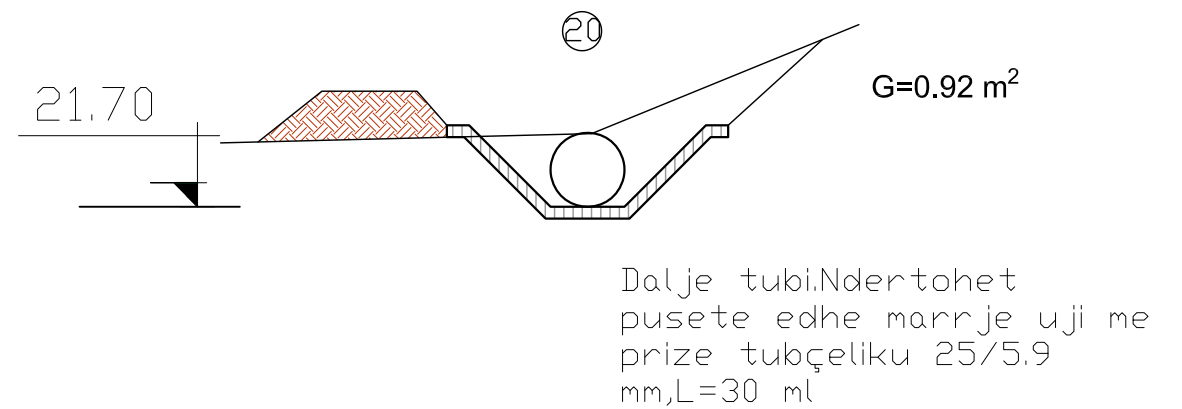
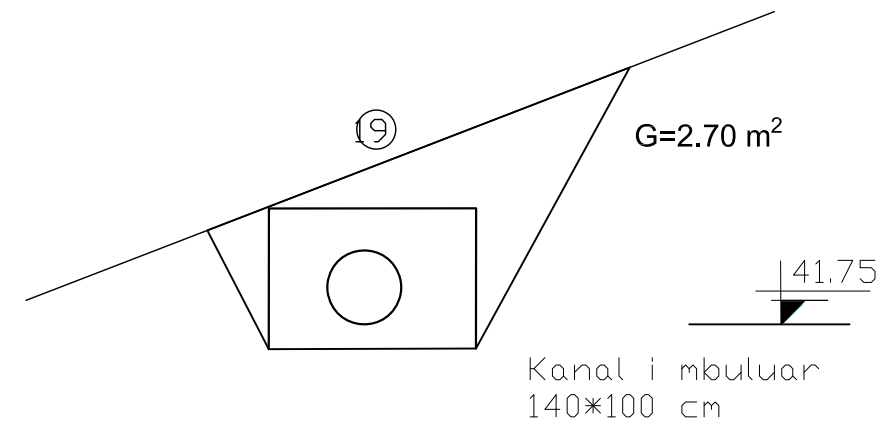
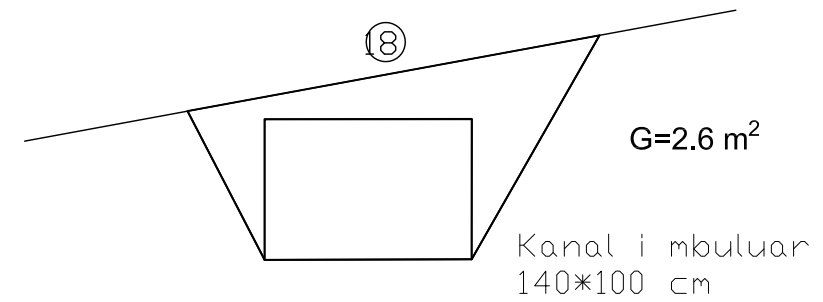
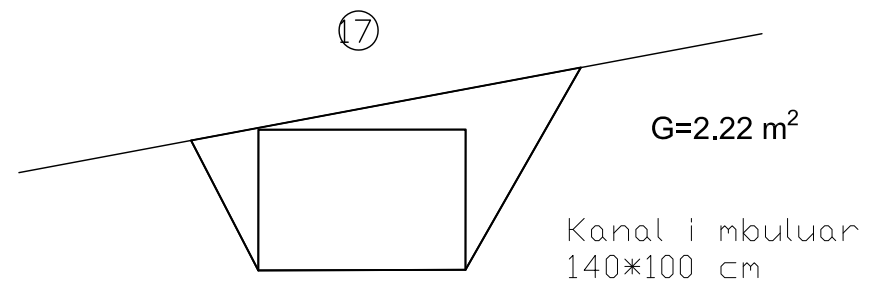
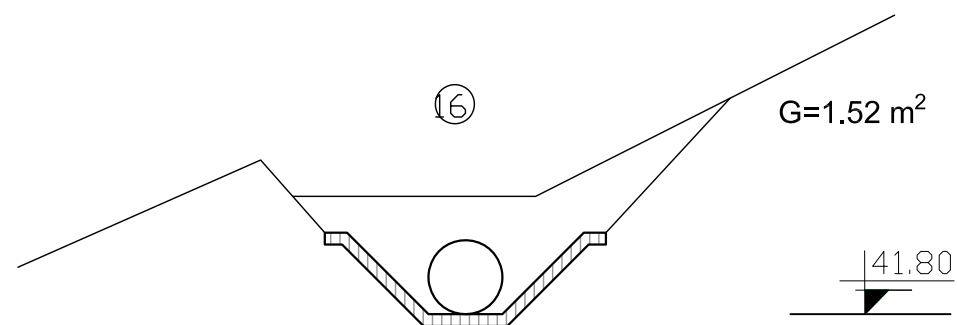
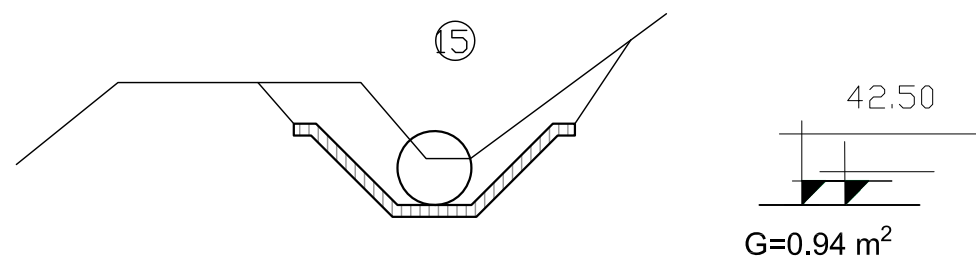
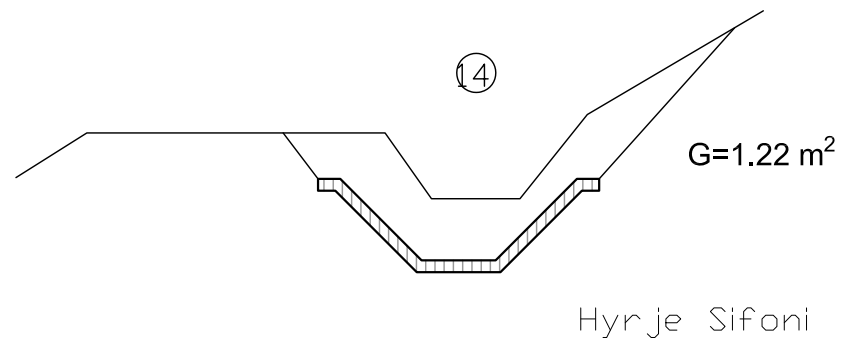
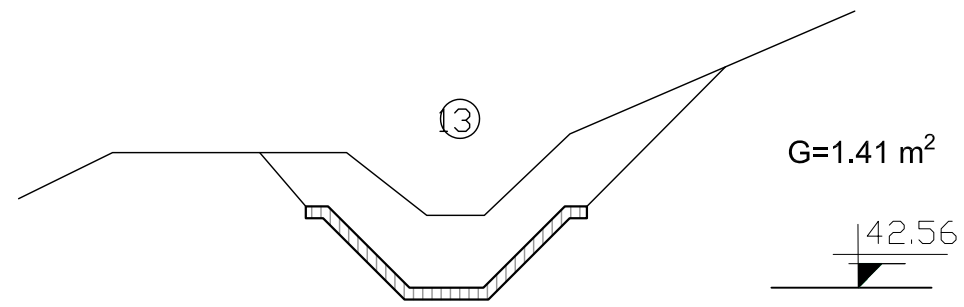
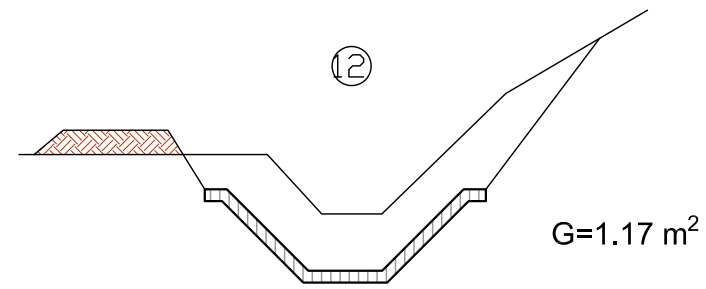

 <p>REPUBLIKA E SHQIPËRISË BASHKIA DIMAL</p>	AUTORITETI KONTRAKTOR : BASHKIA DIMAL	FAZA : PROJEKT ZBATIMI	EMËRTIMI I FLETËS :		KAPITULLI :	PROJEKTI ARKITEKTONIK
	HARTIMI I PROJEKTIT PËR OBJEKTIN : NDËRTIM KANALESH VADITËS , FSHATI GORICAN, BASHKIA DIMAL	 <p>PROJEKTUES : "ARENA MK" SHPK</p>	PROFILE TËRTHORE, PIKETA 12-20, KANALI VADITËS 8		NR. I FLETËS :	A - 20
			SHKALLA E VIZATIMIT : Sh 1:5	FORMATI I VIZATIMIT - A 3	DATA :	DIMAL 2024

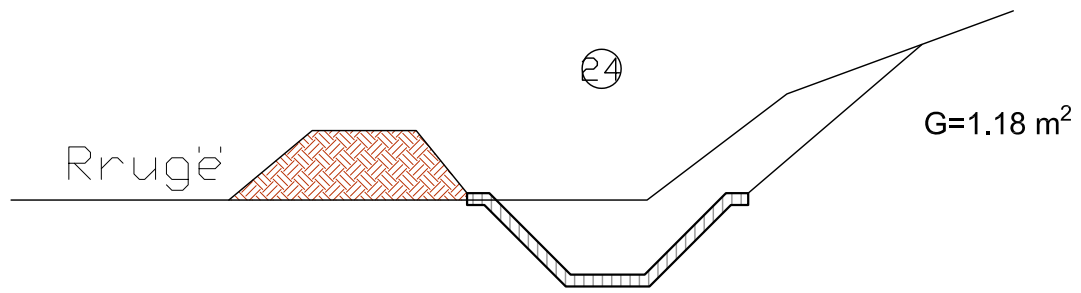
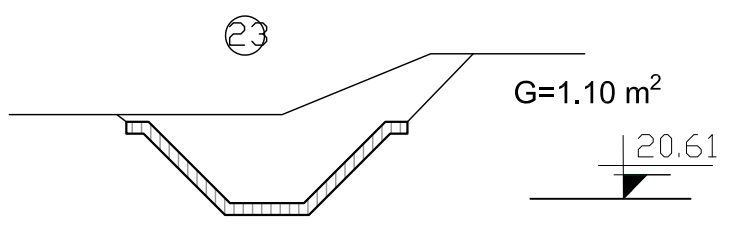
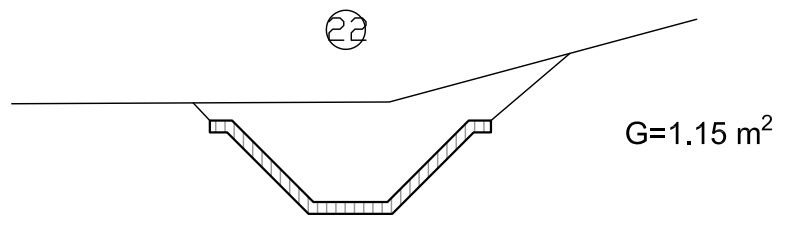
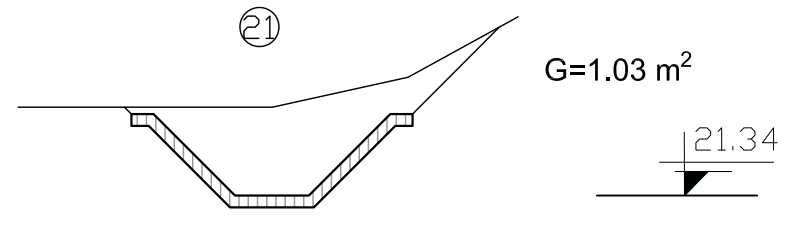

Ndertohej pusete +
kalim me tubo çeliku
250/5.9 mm, L=30 ml

 <p>REPUBLIKA E SHQIPËRISË BASHKIA DIMAL</p>	<p>AUTORITETI KONTRAKTOR : BASHKIA DIMAL</p>	<p>FAZA : PROJEKT ZBATIMI</p>	<p>EMËRTIMI I FLETËS :</p>		<p>KAPITULLI :</p>	<p>PROJEKTI ARKITEKTONIK</p>
	<p>HARTIMI I PROJEKTIT PËR OBJEKTIN : NDËRTIM KANALESH VADITËS , FSHATI GORICAN, BASHKIA DIMAL</p>	 <p>PROJEKTUES : "ARENA MK" SHPK</p>	<p>PROFILE TËRTHORE, PIKETA 21-24, KANALI VADITËS 8</p>		<p>NR. I FLETËS :</p>	<p>A - 21</p>
			<p>SHKALLA E VIZATIMIT : Sh 1:5</p>	<p>FORMATI I VIZATIMIT - A3</p>	<p>DATA :</p>	<p>DIMAL 2024</p>

PRERJA A - A SH.1:50

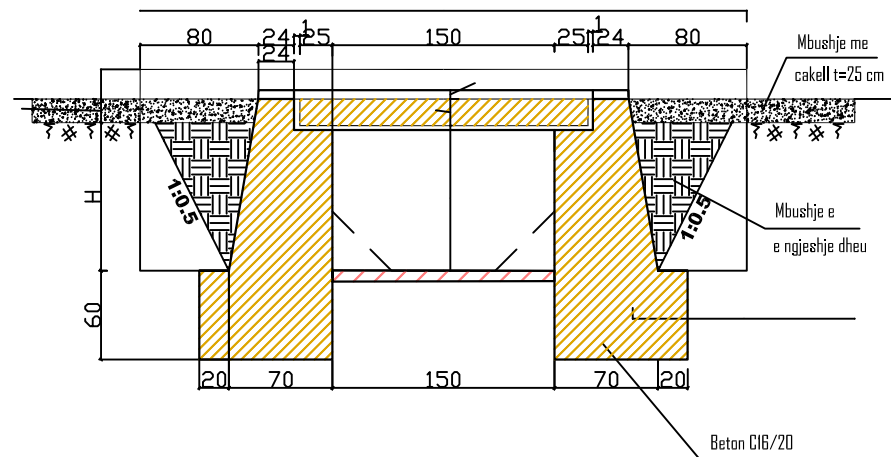

PAMJE NGA SIPER SH. 1:50

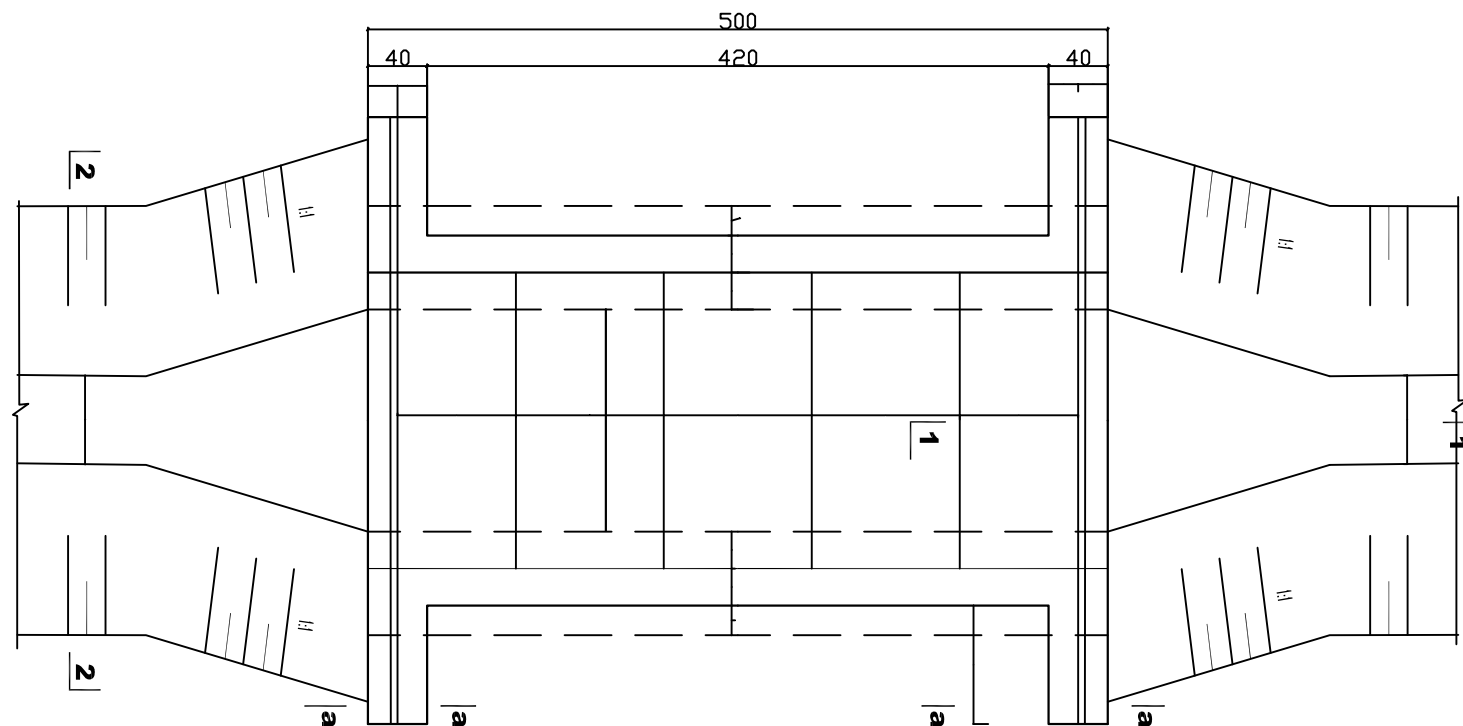

 <p>REPUBLIKA E SHQIPËRISË BASHKIA DIMAL</p>	<p>AUTORITETI KONTRAKTOR : BASHKIA DIMAL</p>	<p>FAZA : PROJEKT ZBATIMI</p>	<p>EMËRTIMI I FLETËS :</p>		<p>KAPITULLI :</p>	<p>PROJEKTI ARKITEKTONIK</p>
	<p>HARTIMI I PROJEKTIT PËR OBJEKTIN : NDËRTIM KANALESH VADITËS , FSHATI GORICAN, BASHKIA DIMAL</p>	 <p>PROJEKTUES : "ARENA MK" SHPK</p>	<p>PAMJE E URËS SË KALIMIT, KANALI VADITËS 8</p>		<p>NR. I FLETËS :</p>	<p>A - 22</p>
			<p>SHKALLA E VIZATIMIT : Sh 1:5</p>	<p>FORMATI I VIZATIMIT - A 3</p>	<p>DATA :</p>	<p>DIMAL 2024</p>

URE KALIMI HD=1.5 M ; L=5 ML

PRERJA 1 - 1 SH. 1:50

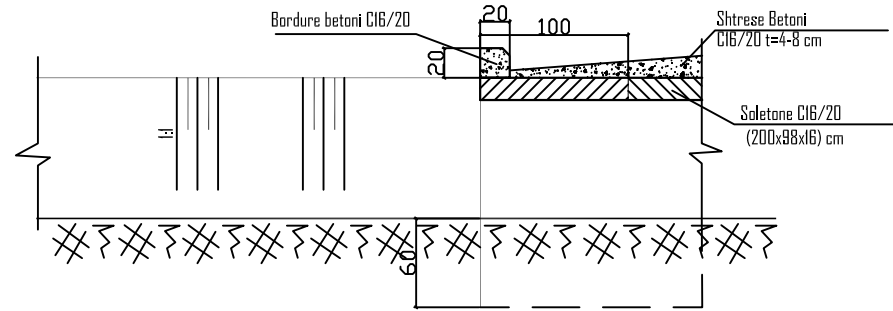

PRERJA 2 - 2 SH. 1:50

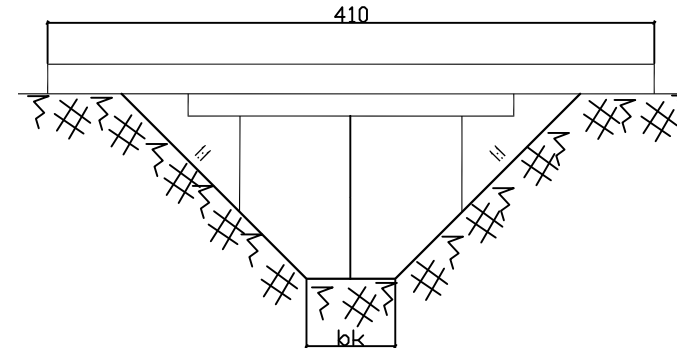

ARMIMI I SOLETONIT SH. 1:20

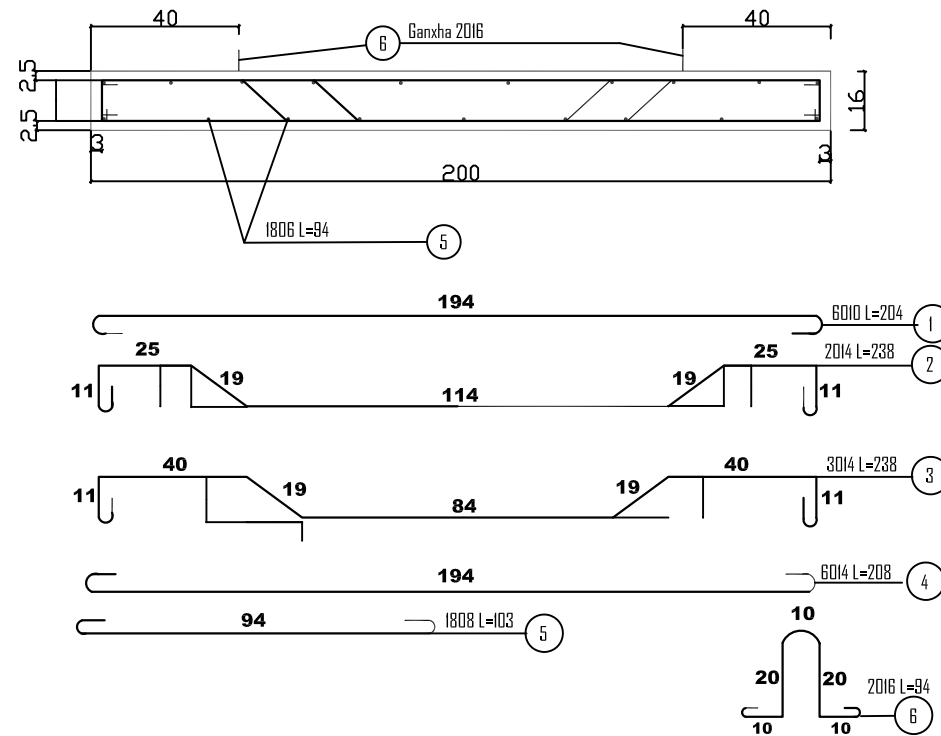

PRERJA a - a SH. 1:50

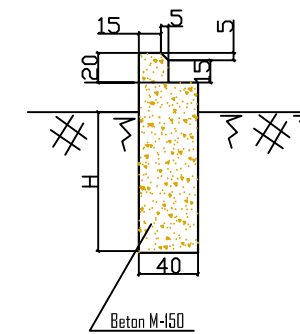

PRERJE TERTHORE SH. 1:20

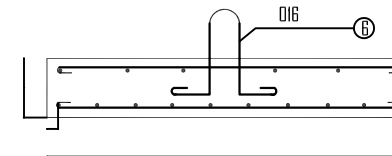

REPUBLIKA E SHQIPËRISË
BASHKIA DIMAL

AUTORITETI KONTRAKTOR : BASHKIA DIMAL

HARTIMI I PROJEKTIT PËR OBJEKTIN :
NDËRTIM KANALESH VADITËS , FSHATI GORICAN,
BASHKIA DIMAL

FAZA : PROJEKT ZBATIMI



PROJEKTUES :
"ARENA MK" SHPK

EMËRTIMI I FLETËS :

ARMIMI I URËS SË KALIMIT, KANALI VADITËS 8

SHKALLA E VIZATIMIT :

Sh 1:5

FORMATI I VIZATIMIT - A 3

KAPITULLI :

PROJEKTI
ARKITEKTONIK

NR. I FLETËS :

A - 23

DATA :

DIMAL 2024

Profil tip

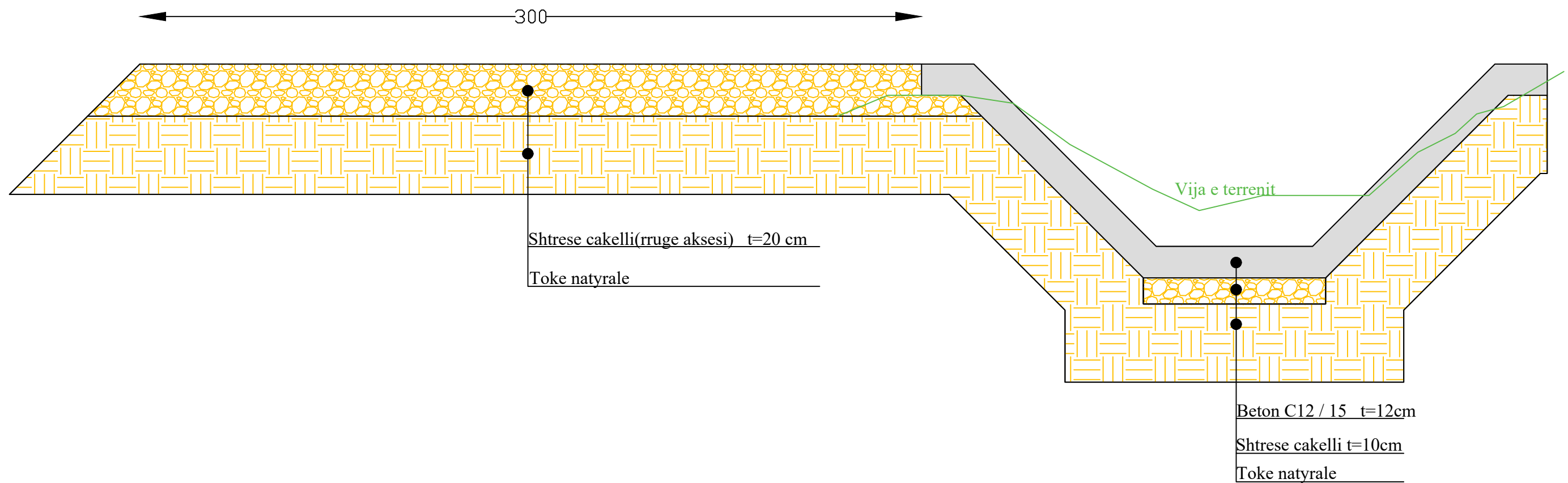

Titulli i projektit
Ndertim kanalesh vadites, fshati Gorican, Bashkia Dimal



Projektues
ARENA MK
shpk

Viti
2024

Emertimi i fletes
Profili tip

Dimensionimi

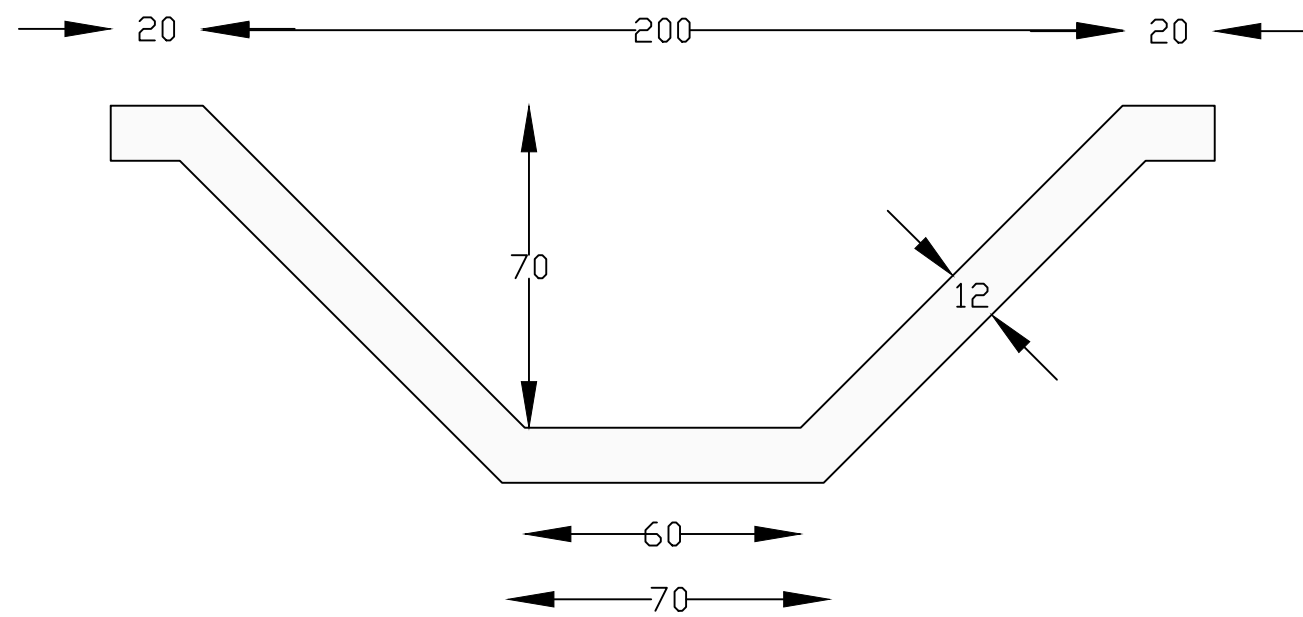

Armimi

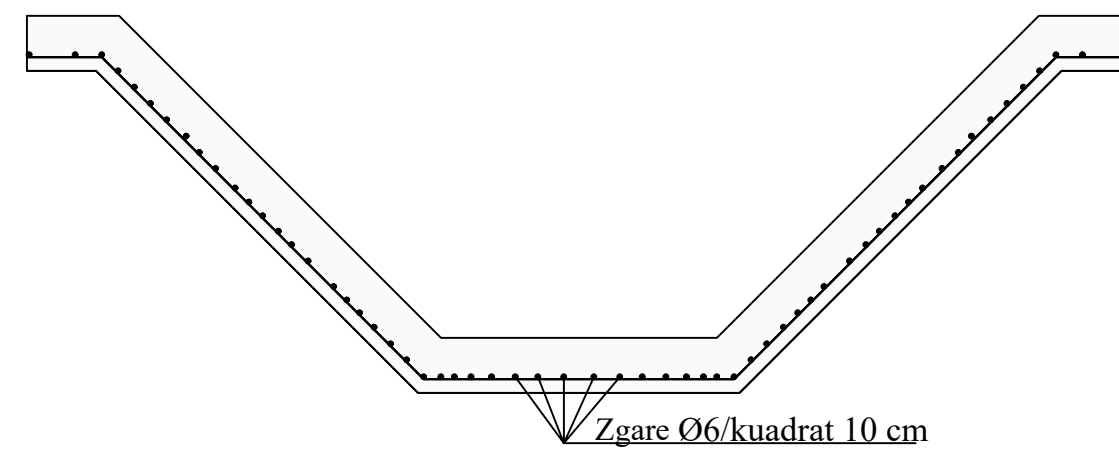

	Titulli i projektit	Projektues		Viti	Emertimi i fletes
	Ndertim kanalesh vadites, fshati Gorican, Bashkia Dimal		ARENA MK shpk	2024	Dimensionimi dhe armimi i kanalit

PRIZE TIP 40X50 CM ME TOMBINO Ø 40cm, L=2 M

PRERJE GJATESORE 1 - 1 SH. 1:50 (PRIZE NE KANALIN 1,2,3,4,5,6,7,8)

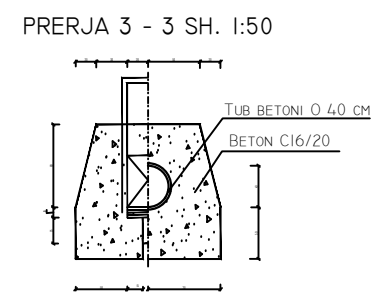
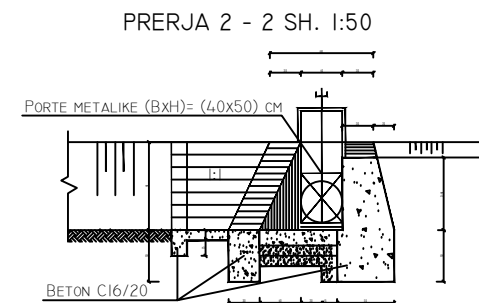
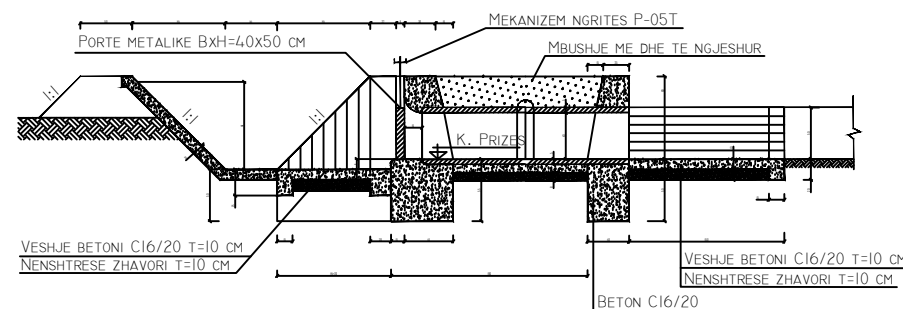

PLANIMETRIA SH. 1:50

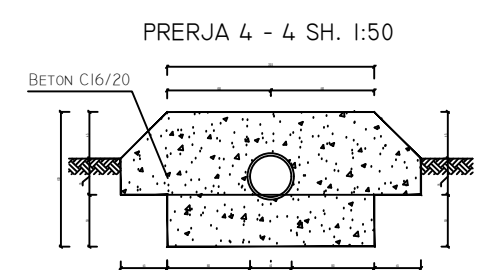
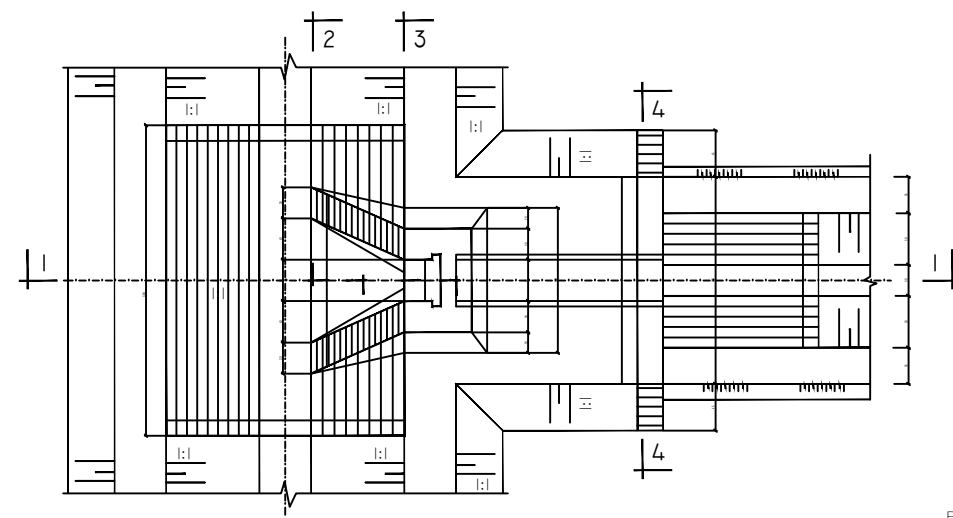

PUSETE PK.4 (100*100*80CM)

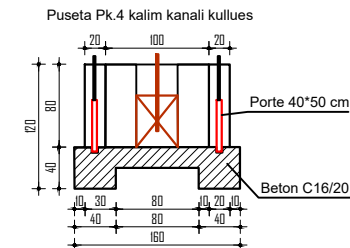
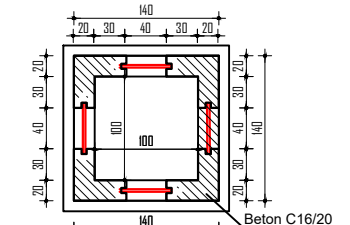

SHENIME:
 1. KUOTA E PRIZES MERRRET NGA PROFILI GJATESOR I KANALIT.
 DISNIVELI "A" DO TE LLOGARITET SI DIFERENCA E KUOTES SE PRIZES ME KUOTEN E TABANIT TE KANALIT SEKONDAR NGA I CILI MERRRET UJI.
 2. PERMASAT JEPEN NE CENTIMETRA.

PRIZE 40X50CM ME TUB CELIKU 323.9/5.6 MM, L=20 ML, PK.3

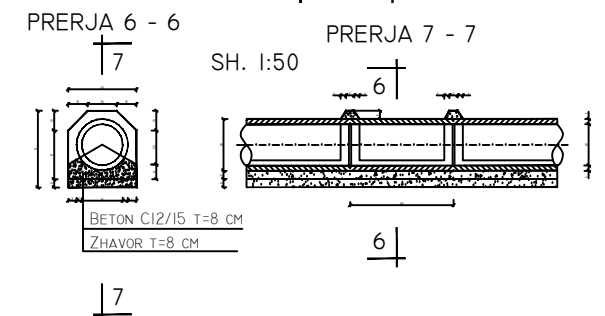
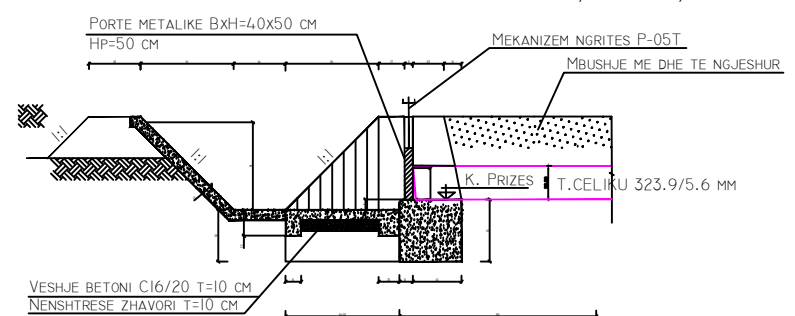

Titulli i projektit

Projektues

Viti

Emertimi i fletes

Ndertim kanalesh vadites, fshati Gorican, Bashkia Dimal

ARENA MK shpk

2024

Detaji i prizave

