

OBJEKTI: PERMIRESIMI I BANESAVE EKZISTUENSE PER KOMUNITETET TE VARFERA DHE TE PAFAVORIZUARA

Projekt zbatimi

2024

MIRATOHJET: KRYETARI: Z-MARIGLEN DISHA	EMERTIMI I PROJEKTTI: OBJEKTI: PERMIRESIMI I BANESAVE EKZISTUENSE PER KOMUNITETE TE VARFERA DHE TE PAFAVORIZUARA VENDNDODHUA: BASHKIA LIBRAZHID	EMERTIMI I FLETES:
ZYRA E PROJEKTEVE DHE INVESTIMEVE: GRUHEKONIK I PONES: 1. Dodon Haxhiu 3. Adila Haskurti	Z-Shermet Bushi	SHKALLA:
		NUMRI I FLETES: /
		DATA: / / 2024

DETAJ I ULLUQVEVE DHE MBULESES

Mbulesa me tjegulla marsejeze

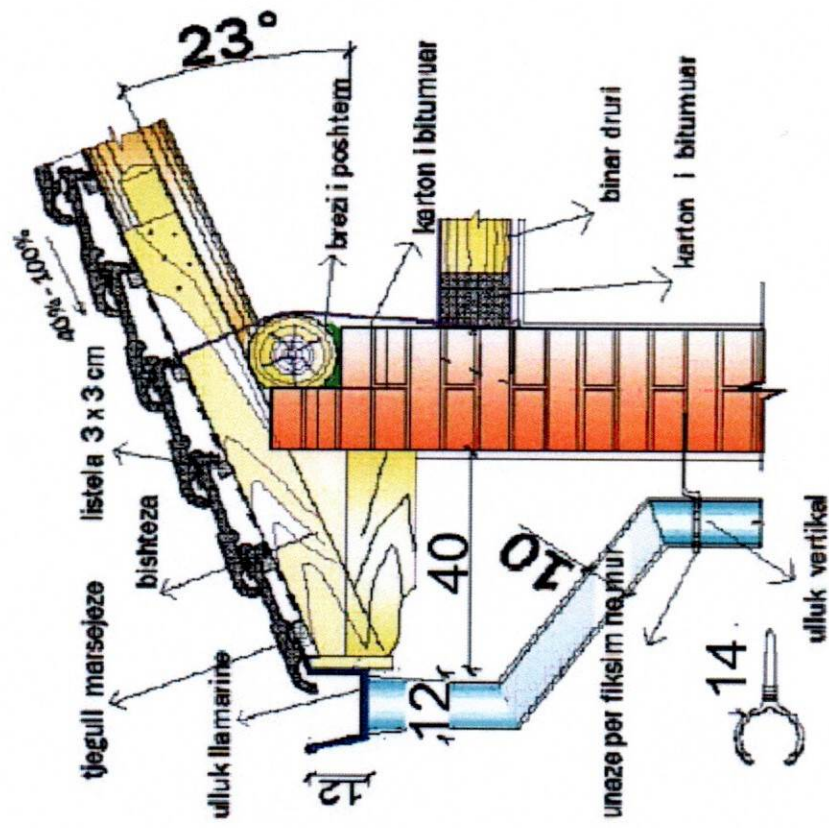

OBJEKTI:

Permiresimi i banesave ekzistuese per komunitet e varfera dhe te pafortizuara

PUNOI :
ZYRA E PROJEKTEVE DHE INVESTIMEVE

SHKALLA 1:100

DETAJI I ARMIMIT TE BREZIT TE BETONIT

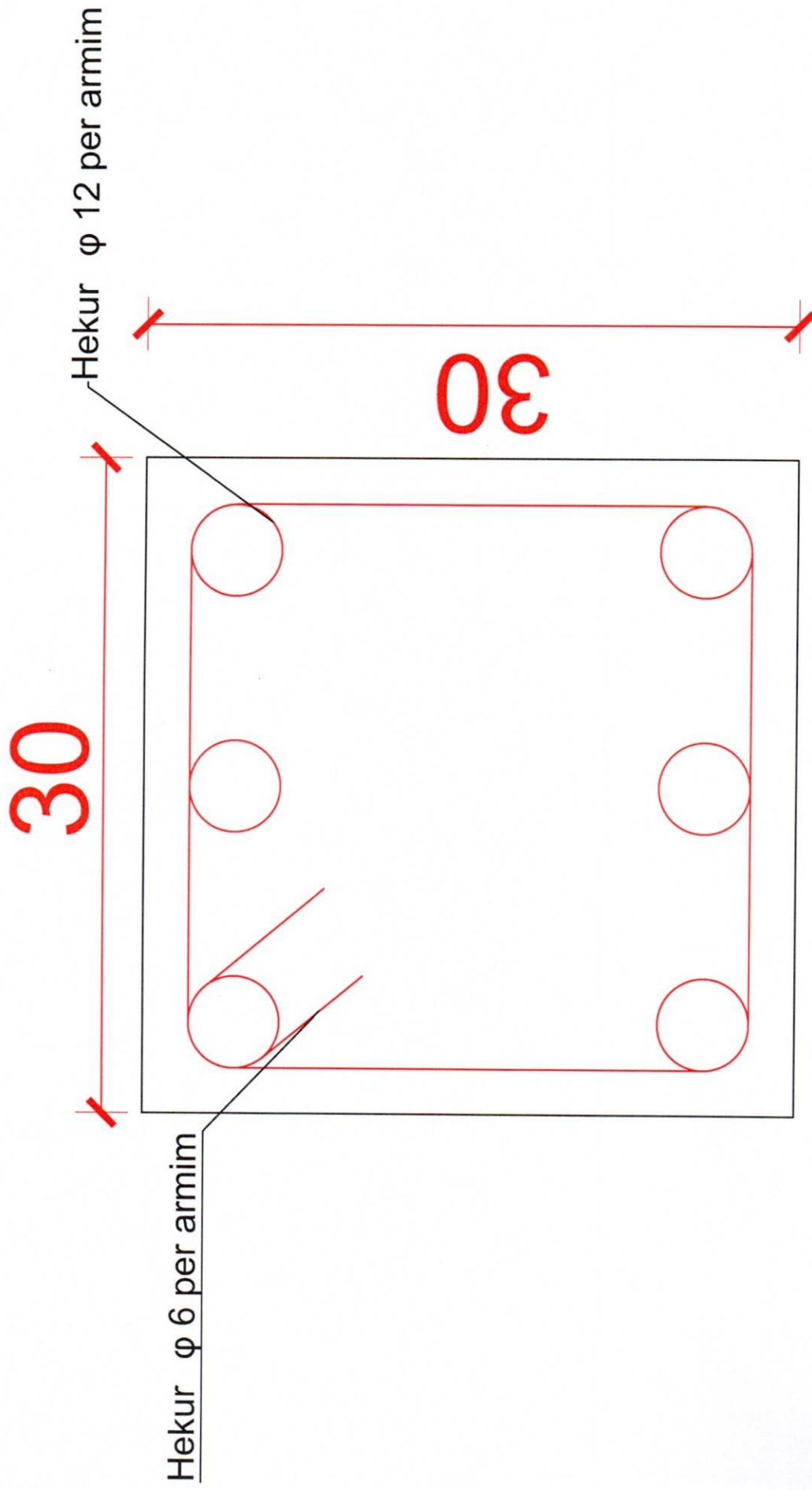

OBJEKTI:

Permiresimi i banesave ekzistuese per komunitet e varfera dhe te paforizuara

PUNOI :
ZYRA E PROJEKTEVE DHE INVESTIMEVE

SHKALLA 1:100

DETAJI I ARMIMIT TE BREZIT TE BETONIT

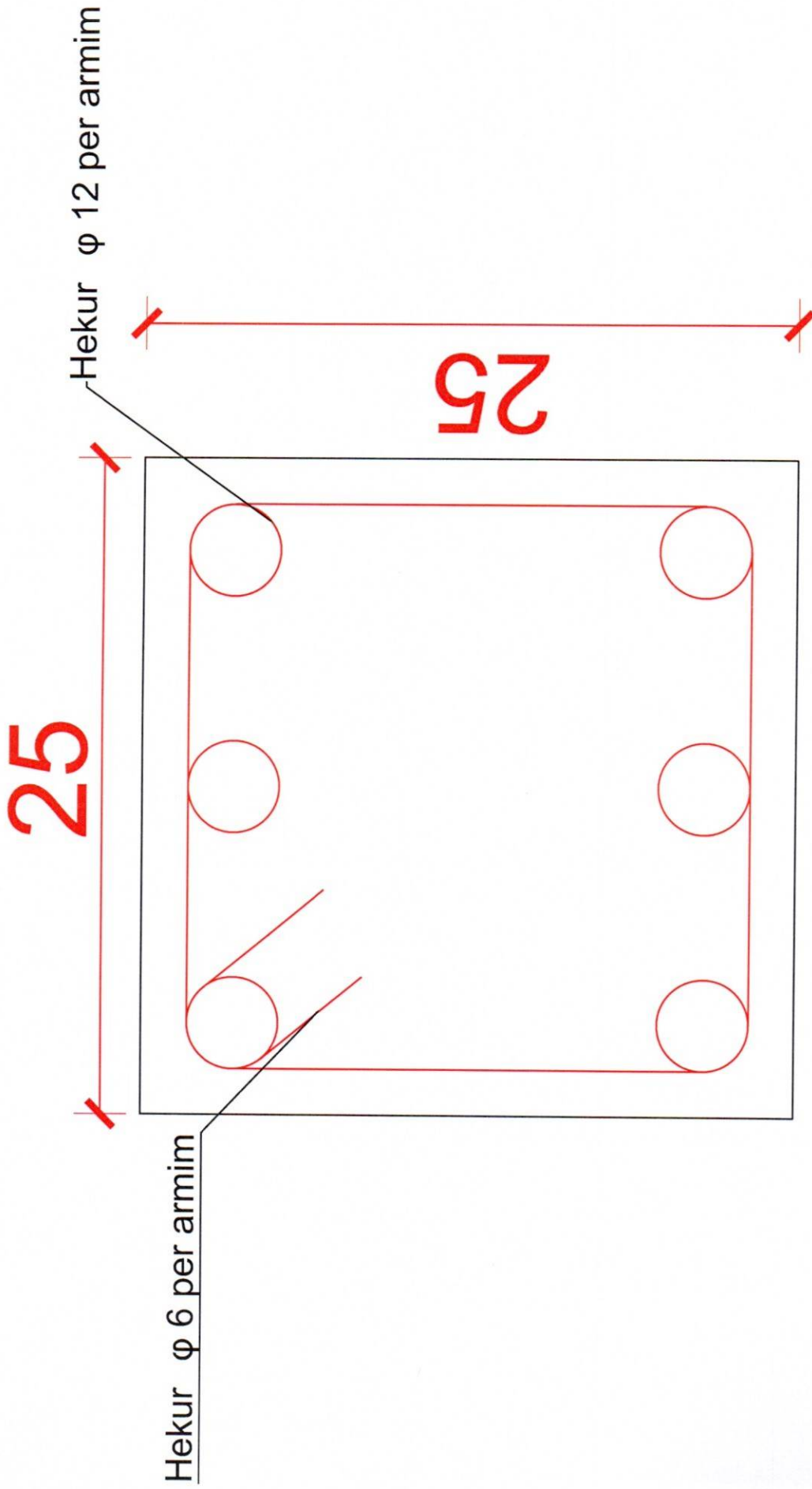

OBJEKTI:

Permiresimi i banesave ekzistuese per komunitet e varfera dhe te paforizuara

PUNOI :
ZYRA E PROJEKTEVE DHE INVESTIMEVE

SHKALLA 1:100

PLANIMETRI E OBJEKTIT TE Z. LIMAN H. BRAHJA

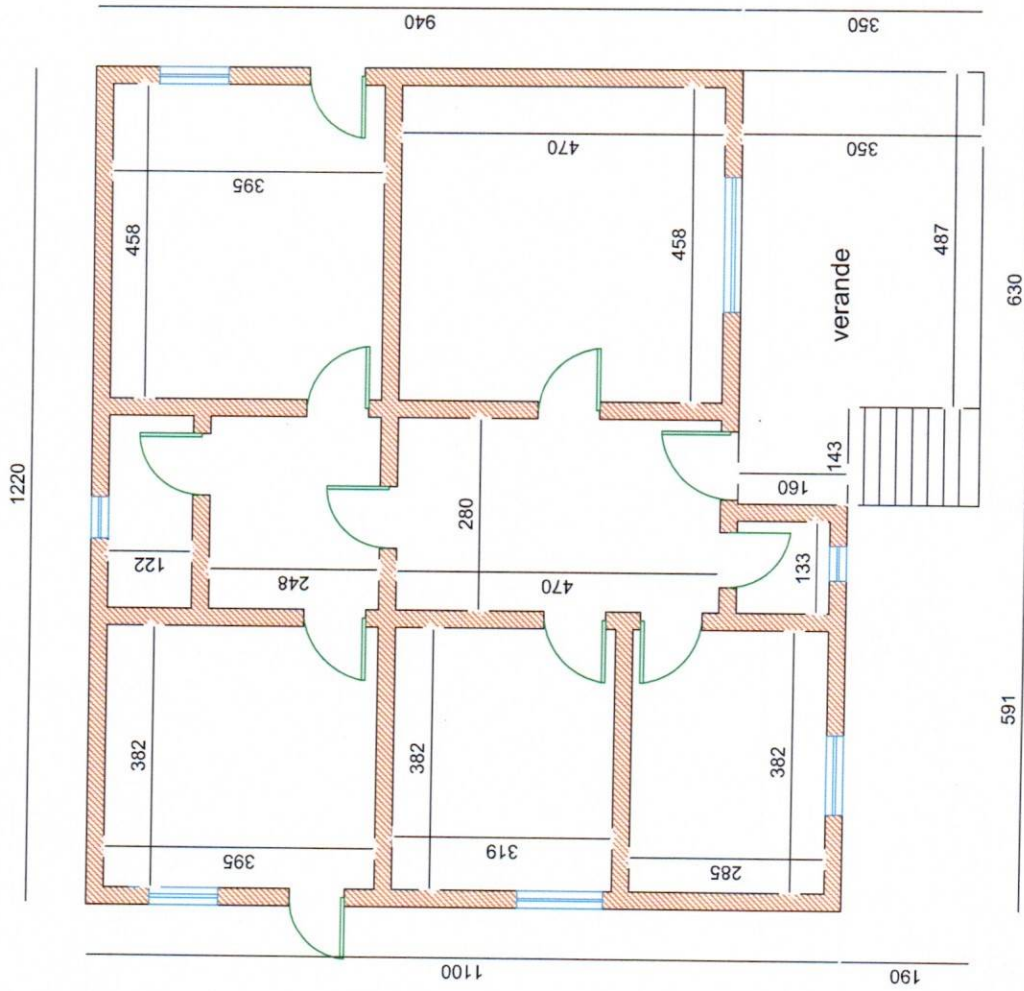

SHENIME TEKNIKE

Sip. banese m²
Sip. solete 142 m²



OBJEKTI:

Permiresimi i kushteve te banimit per komunitet e varfera dhe te pafortizuara

M. Arment Beselis

PLANVENDOSJE

Per objektin "A" ndertese ne pronesi te Z.Liman Brahja
Nr. 2/270 Pasurie, ZK. 2446
Bashkia Librazhd

MIRATOI
KRYETARI I BASHKISE
MARIQLEN DISHA

SH 1:1000



OBJEKTI "A" NE PLANVENDOSJE

PERGATITI
ZYRA E PROJEKTEVE

PLANIMETRIA E BANESES SE Z.QEMAL QOSHKU, FSHATI ARREZ,
NJ.AD.QENDER,BASHKIA LIBRAZHID

SH 1:100

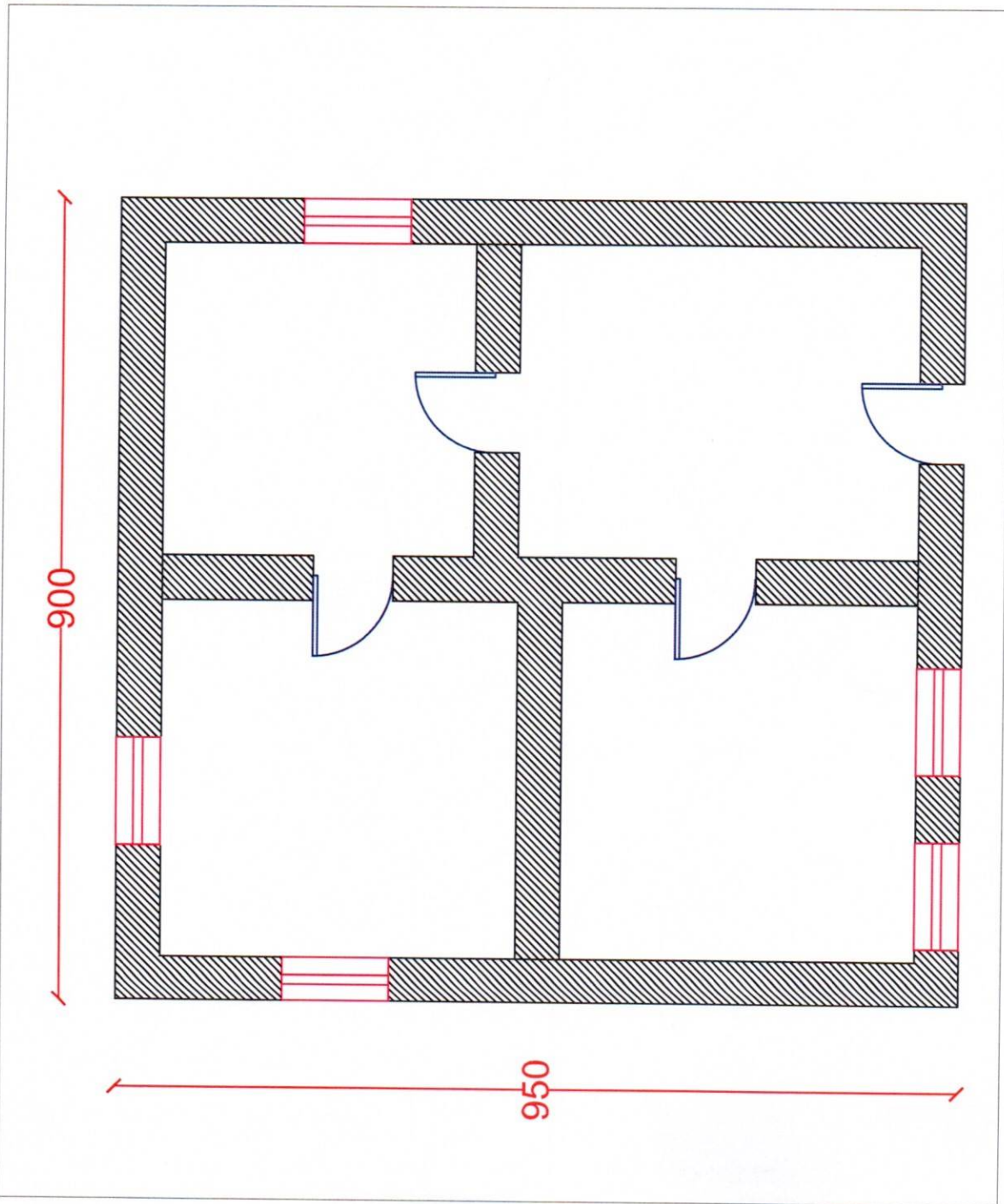

MIRATOI
KRYETARI I BASHKISE
MARIGLEN DISHA

GRUPI I PUNES:

- 1.XHEMAL BOZHIQI
- 2.ERVIN QATJA
- 3.ISLAM MURRASHI

PLANVENDOSJE

Per objektin "A" ndertese ne pronesi te Z. Qemal Qoshku
Nr. 40/123 Pasurie, ZK. 1046
Fshati Arrez, Njesia Administrative Qender, Bashkia Librazhd

SH 1:1000

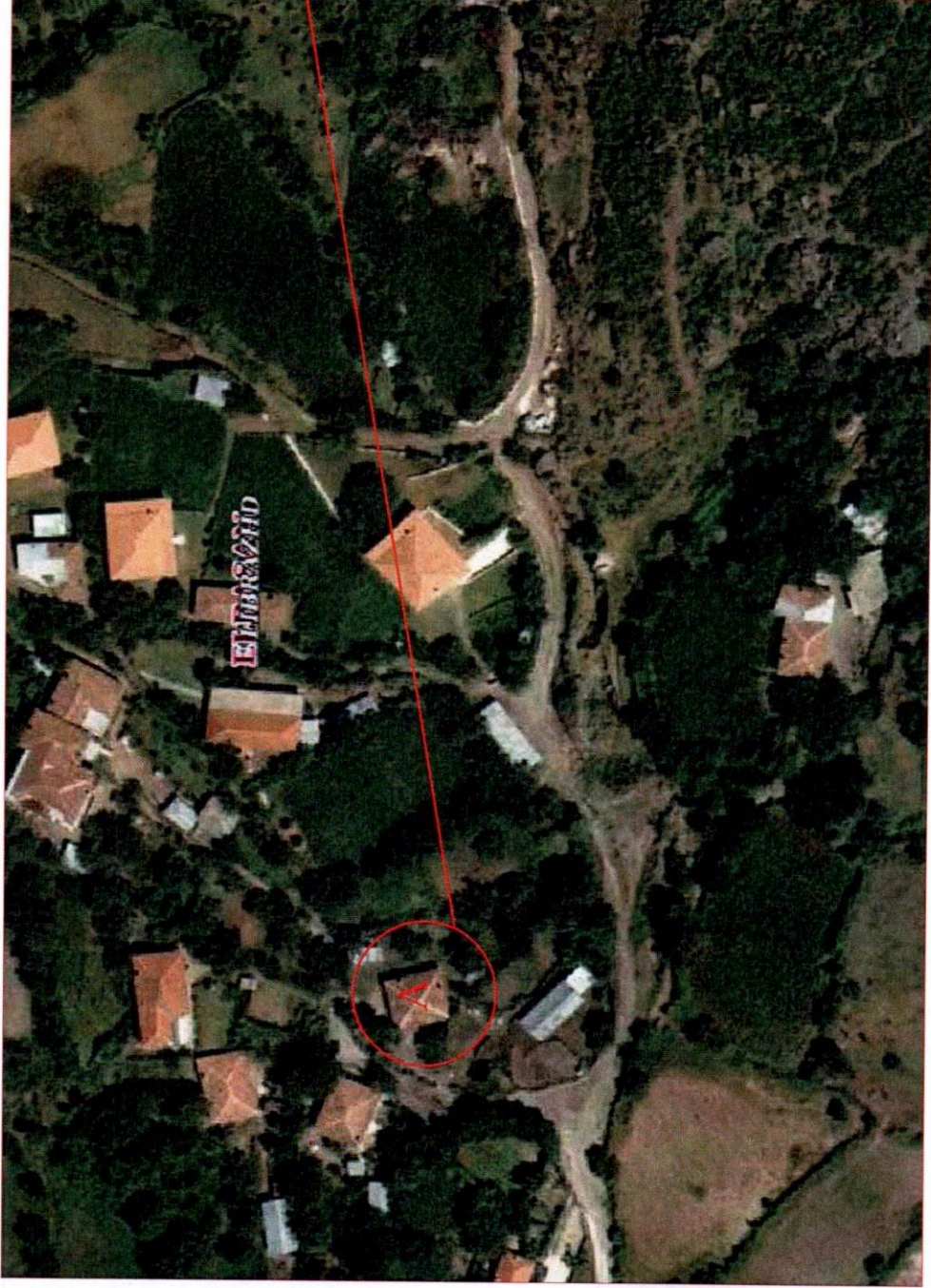

MIRATOI
KRYETARI I BASHKISE
MARIQLENE DISHA

OBJEKTI "A" NE PLANVENDOSJE

KONFIRMOI:
ADMINISTRATORI I NJEISE ADMINISTRATIVE
Qender
Roland Çota

PERGATITI
ZYRA E PROJEKTEVE

PLANIMETRIA E BANESES TE Z.URIM GJOKOLA FSH. KUTURMAN NJA QENDER

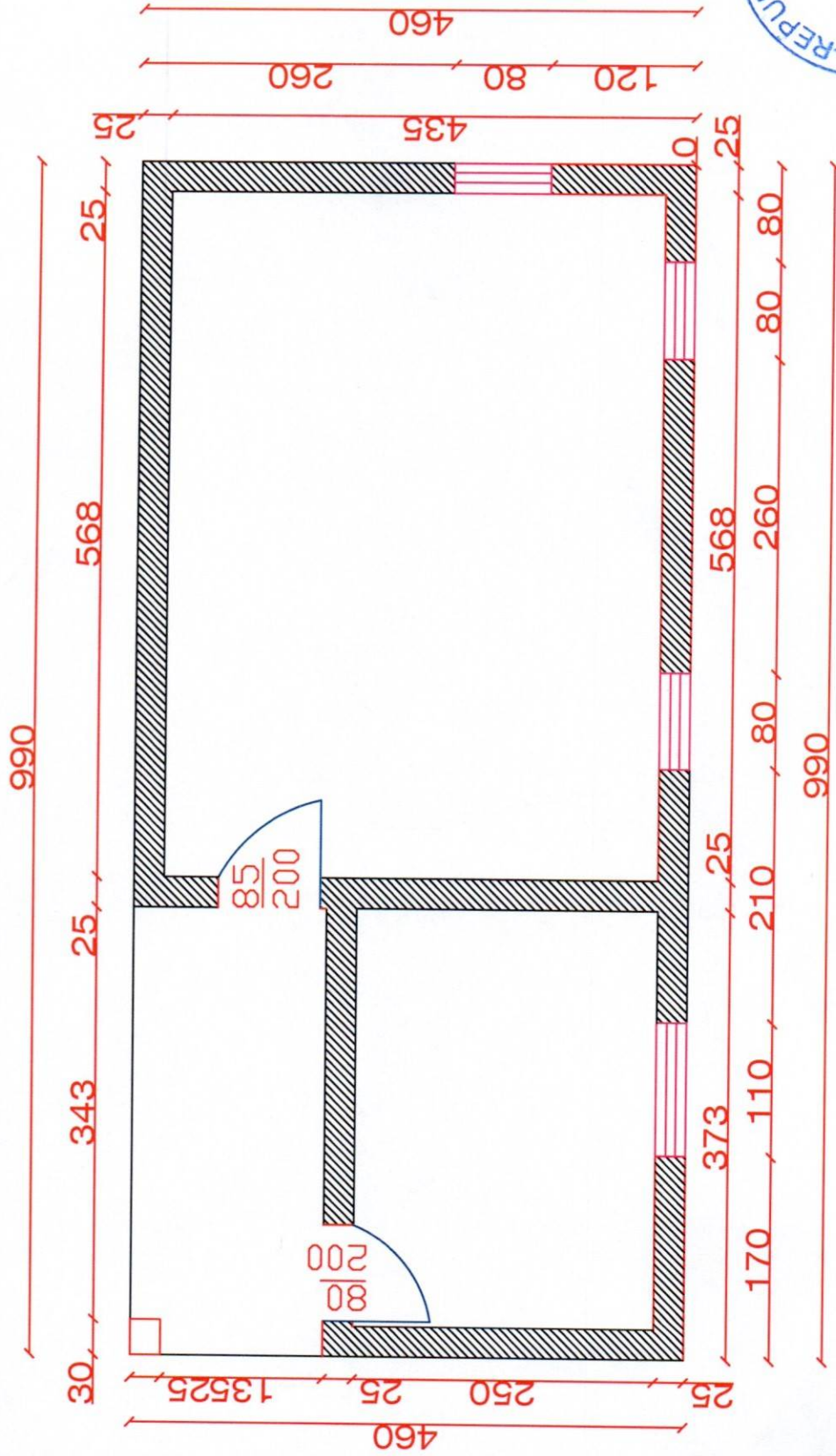

SHKALLA 1:250

GRUPI TEKNIK I MATJEVE:

Ing. Afërdita KOÇI Ing. Julgerta BALLA Ing. Jurgjen MEMA

[Handwritten signatures]

OBJEKTI:

Permiresimi i kushteve te banimit per komunitet e varfëra dhe te paforizuara

PLANVENDOSJE

Per objektin "A" ndertese ne pronesi te Z. Urim Gjokola
Nr. 1255 Pasurie, ZK. 2351
Fshati Kuturman, Njesia Administrative Qender, Bashkia Librazhd

SH 1:1000



OBJEKTI "A" NE PLANVENDOSJE

KONFIRMOI:
ADMINISTRATORI I NJESISE ADMINISTRATIVE
Qender
Roland Çota

PERGATITI
ZYRA E PROJEKTEVE

PLANIMETRIA E BANESES SE Z.GEZIM BUZANI, FSHATI SPATHAR,
NJ.AD.QENDER,BASHKIA LIBRAZHID

SH 1:100

MIRATOI
KRYETARI I BASHKISE
MARIGLEN DISHA

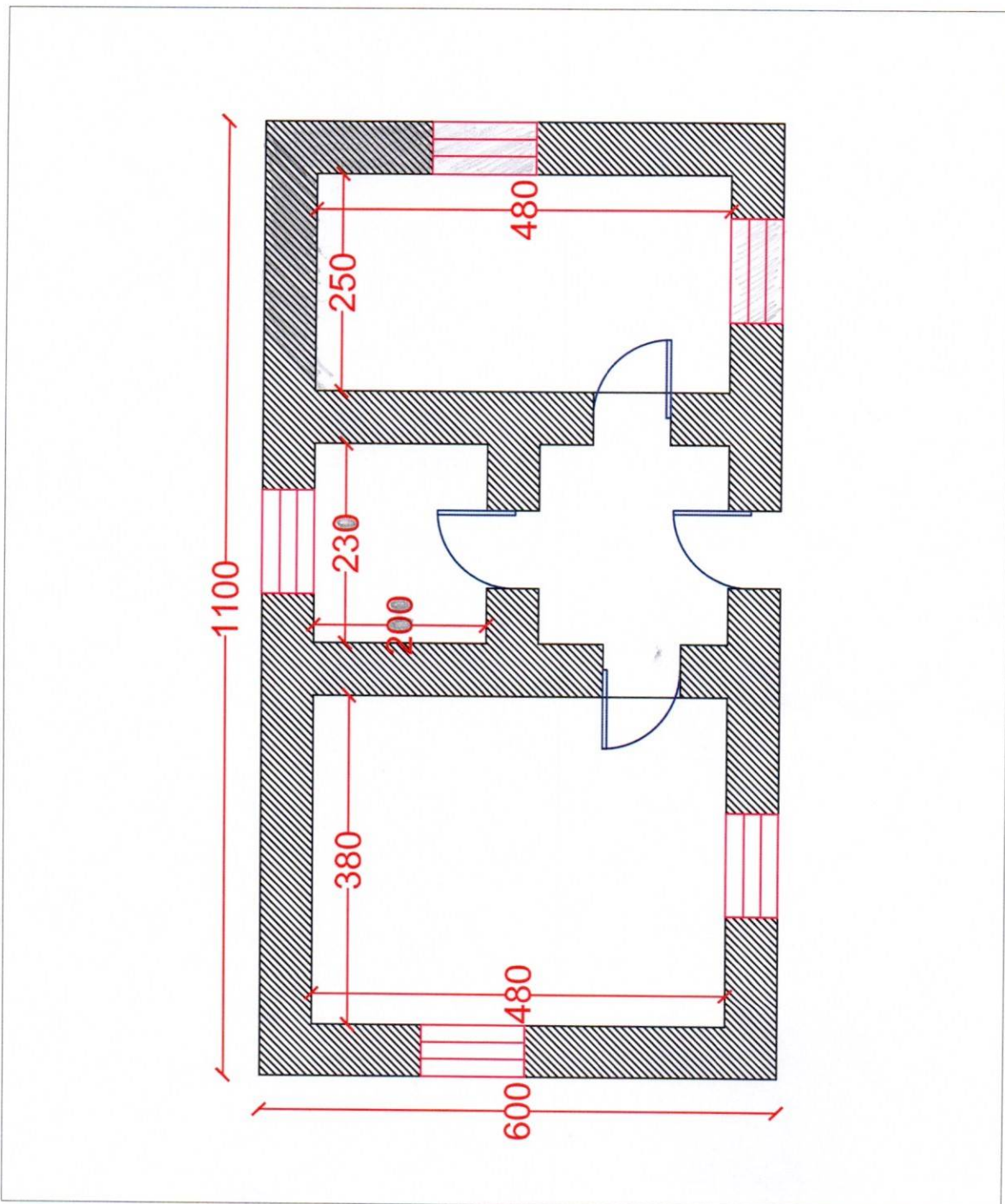

GRUPI I PUNES:

1.XHEMAL BOZHIQI

2.JETMIR VRETO

3.DORIAN HASULAI

PLANVENDOSJE

Per objektin "A" ndertese ne pronesi te Z. Gezim Buzani
Nr. 309/2 Pasurie, ZK. 3499
Fshati Spathar, Njesia Administrative Qender, Bashkia Librazhd

MIRATOI
KRYETARI I BASHKISE
MARIQLENE DISHA

SH 1:1000



OBJEKTI "A" NE PLANVENDOSJE

KONFIRMOI:
ADMINISTRATORI I NJESISE ADMINISTRATIVE
Qender
Roland Çota

PERGATITI
ZYRA E PROJEKTEVE

PLANVENDOSJE

Per objektin "A" ndertese ne pronesi te Z.Ndricim Koka
Nr. 117/1 Pasurie, ZK. 1517
Fshati Dorez, Njesia Administrative Qender, Bashkia Librazhd

SH 1:1000

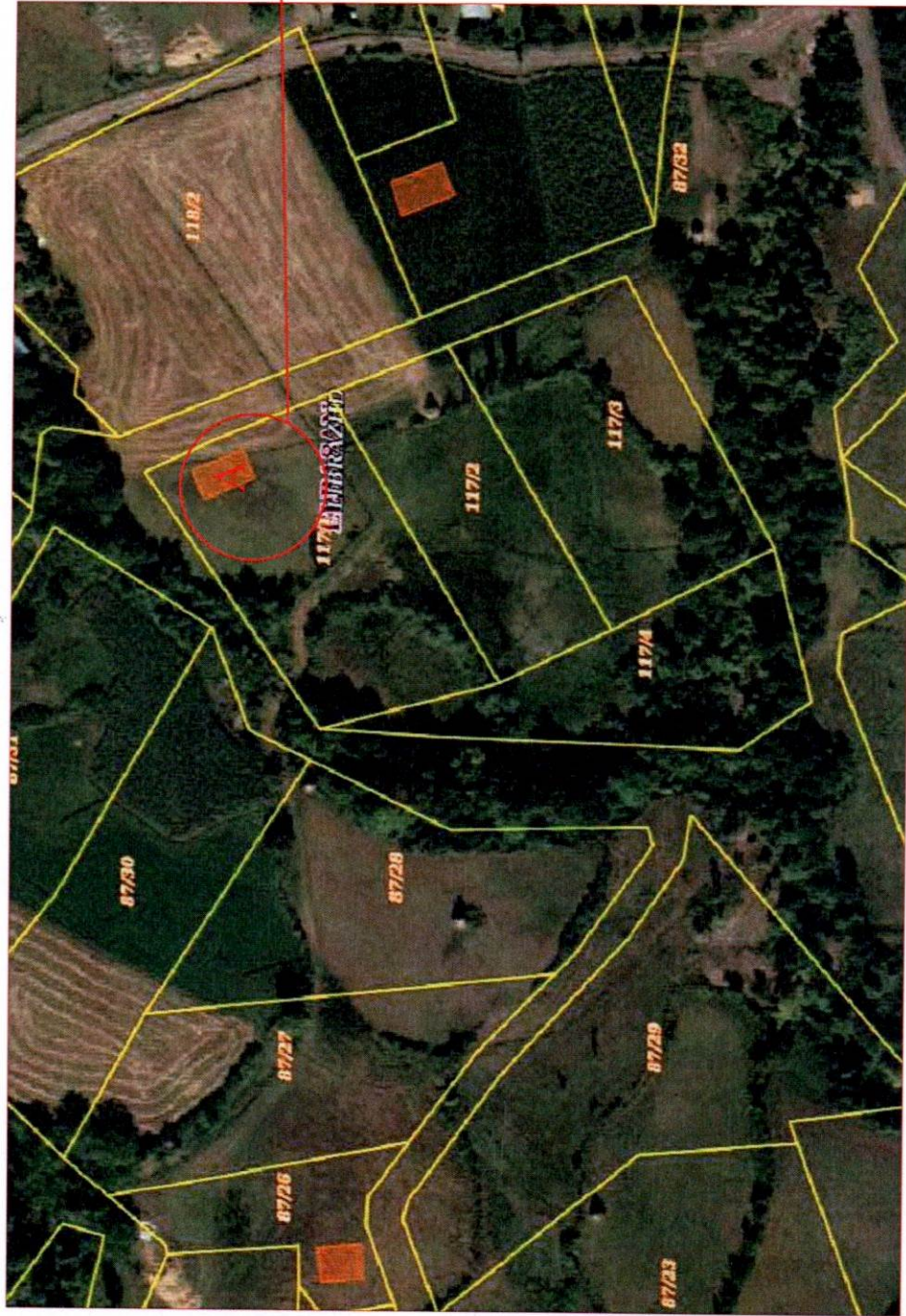

OBJEKTI "A" NE PLANVENDOSJE

KONFIRMOI:

ADMINISTRATORI I NJESIE ADMINISTRATIVE
Qender

Roland Çota

PERGATITI

ZYRA E PROJEKTEVE

PLANIMETRIA E BANESES SE Z.BEHLUL COTA

Njesia Adm. Hotolisht

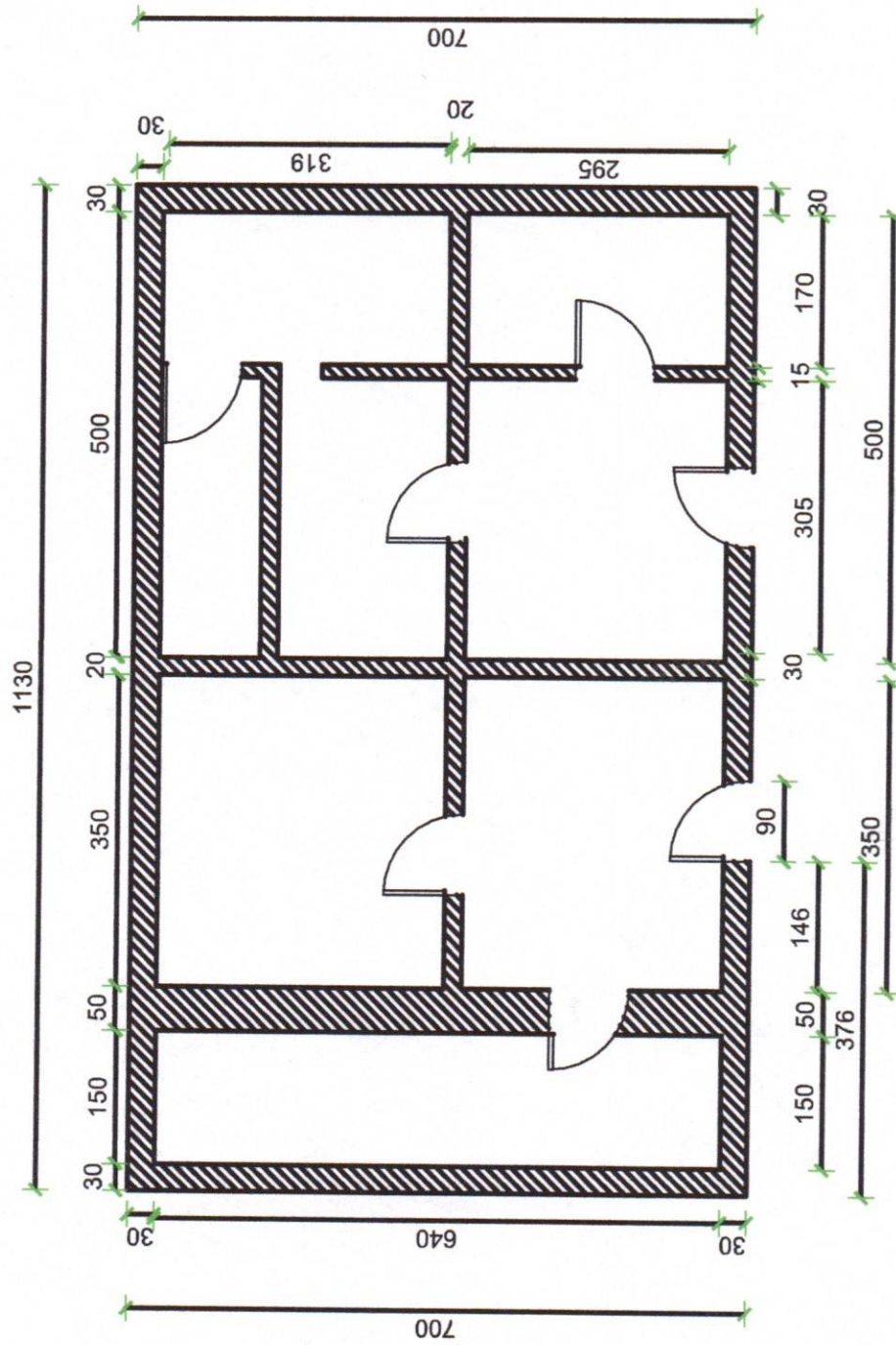

OBJEKTI:

Permiresimi i kushteve te banesave ekzistuese

PERGATITI:

Ing. Julgerta Balla Ing. Xhemal Bozhiciq Ing. Adela Haskullari

SHKALLA 1:100

PLANIMETRIA E CATISE SE Z.BEHLUL COTA
Njesia Adm. Hotolisht

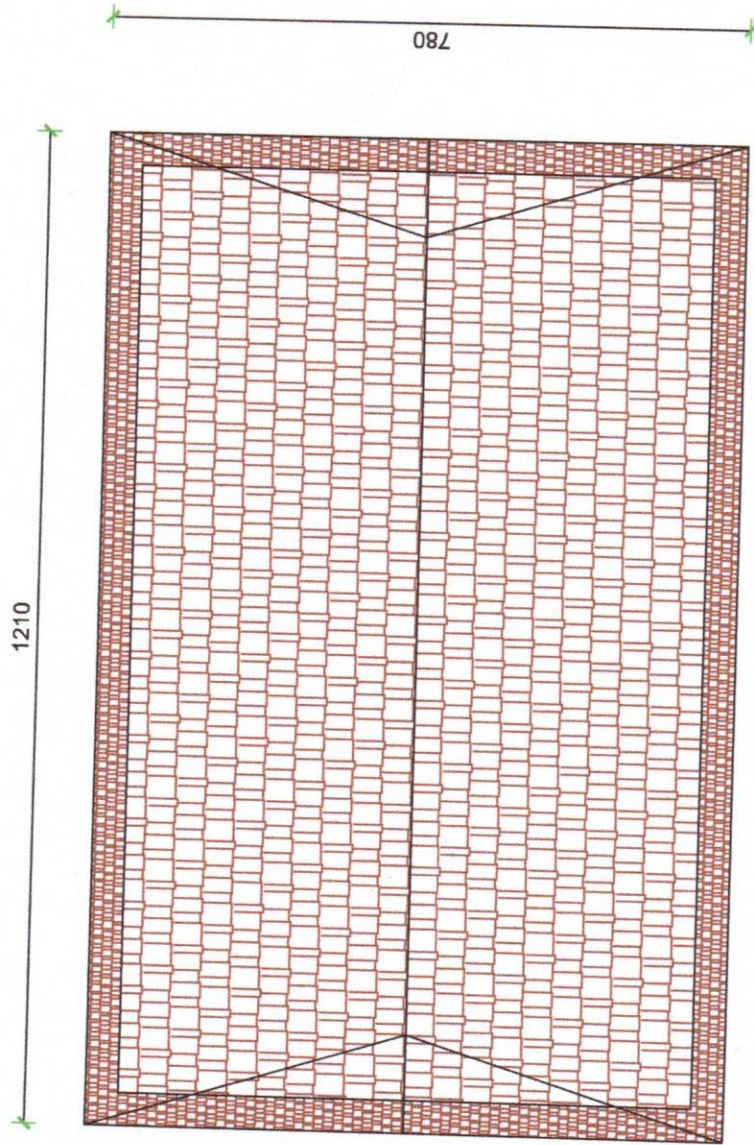

OBJEKTI:

Permiresimi i kushteve te banesave ekzistuese

PERGATITI:

Ing. Julgerta Balla Ing. Xhemal Bozhiqi Ing. Adela Haskurti

SHKALLA 1:100

PLAN VENDOSJE

Per objektin "A" ndertese ne pronesi te Z.Behlul Cota
Nr. 579/ 3 Pasuri, ZK 1967
Njësia Administrative Hotolisht, Bashkia Librazhd

SH 1: 1000

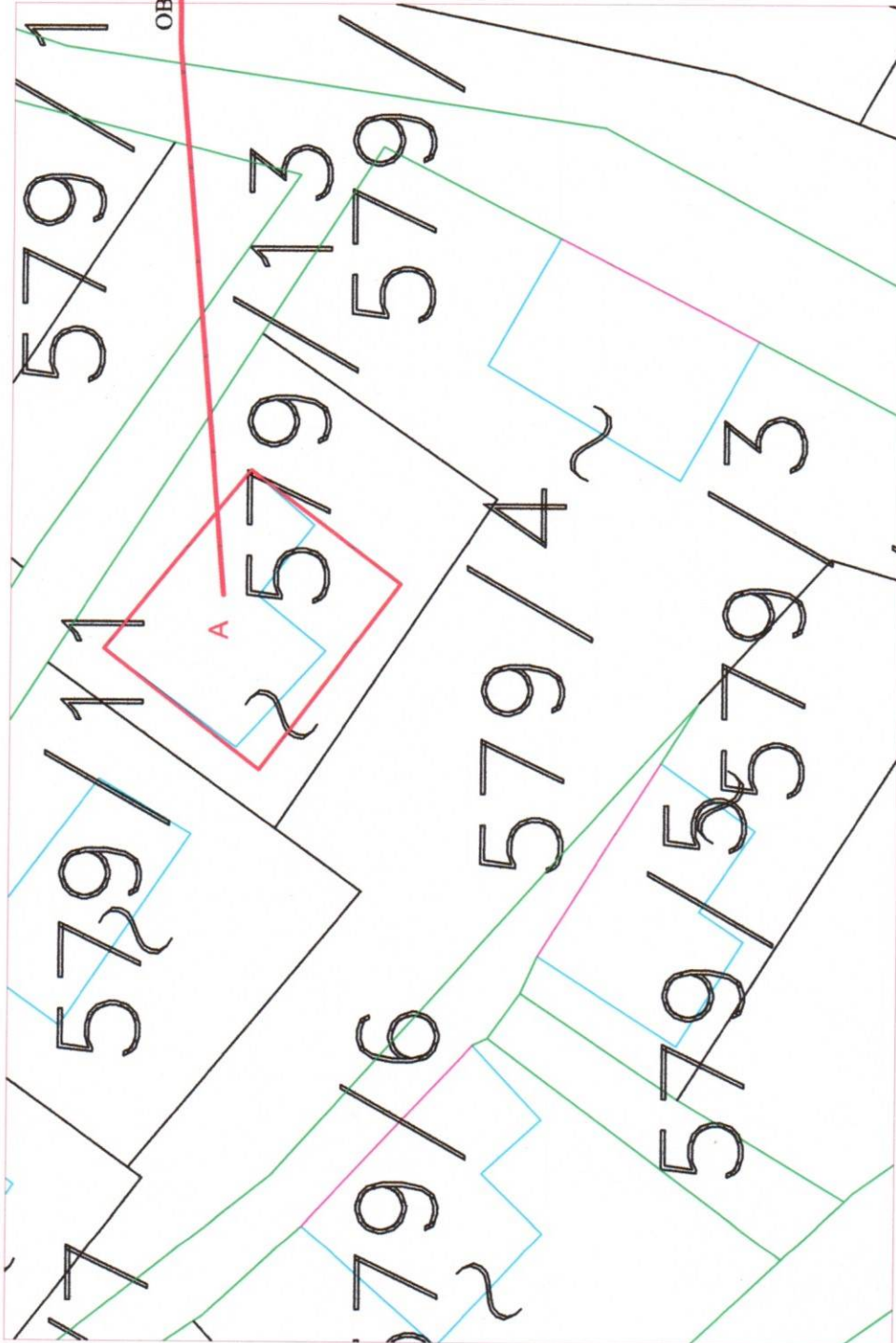

OBJEKTI " A " NE PLAN VENDOSJE

MIRATOI
KRYETARI I BASHKISE
KASTRIOT GURRA

KONFIRMOI
ADMINISTRATORI I NJESISE
ADMINISTRATIVE HOTOLISHT
Florian Mhalla

PERGATITI
ZYRA E PROJEKTEVE

J.Balla

Xh.Bozhiqi

A.Haskurti

PRONARI: Behlul Cota

PLANIMETRIA E KATIT PERDHE Sh. 1 : 100

Pronari : Sami Idriz Gançi Fshati Dardhe

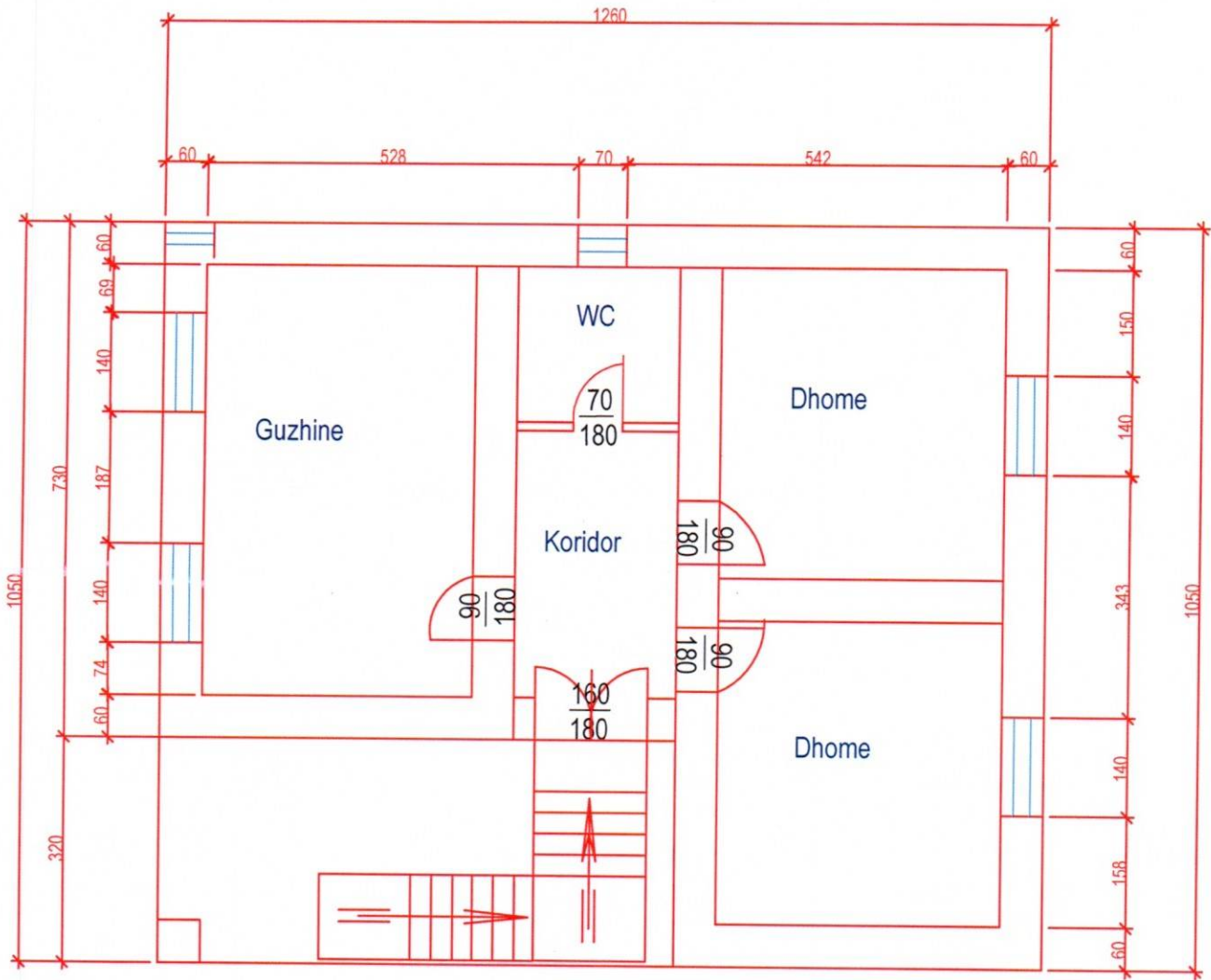

Sip. ndertimi 132.3 m²
Sip. Banese 132.3 m²

Shenim : Banesa eshte e formes 1 K.G.
mbuluar me çati me tjegulla vendi.

Punuan :

Ing. Xhemal Bozhiqi
Ing. Ervin Qatja

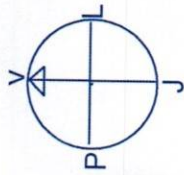

PLAN VENDOSJE

Per Objektiv Shtepi Banimi te z. Sami Idriz Gançi ne zk. 1443

Fshati Dardhe Nj. A. Hotolisht Bashkia Librazhd.

MIRATOI
KRYETARI BASHKISE
MARIGLEN DISHA

SH 1:1000

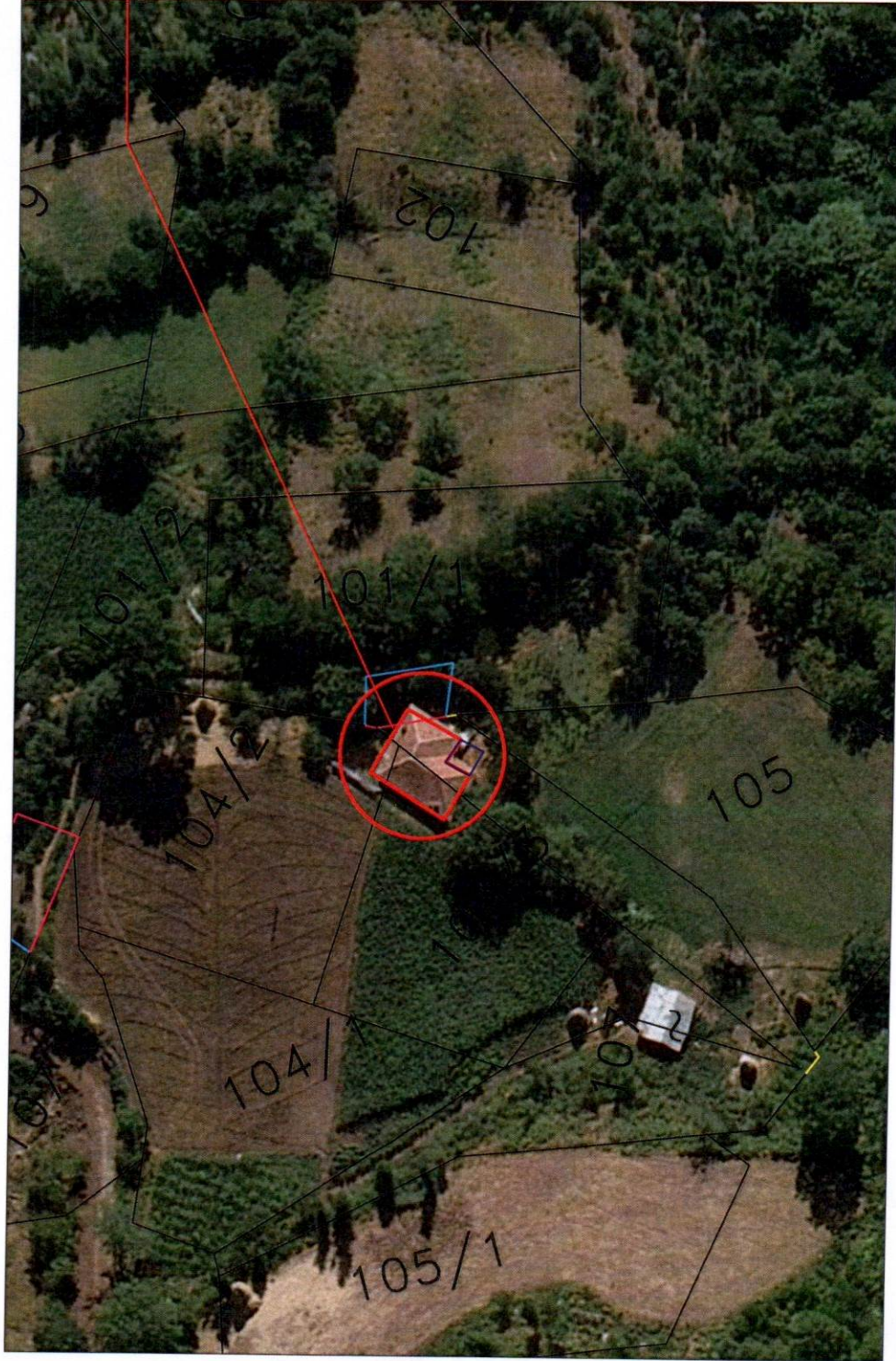

Objekti ne plan vendosje.

PERGATITI :

Ing. Xhemal BOZHIQI

Ing. Astrit POPJA

PLANIMETRIA E BANESES TE Z.GEZIM SINA
 FSH.VEHCAN NJA. HOTOLISHT

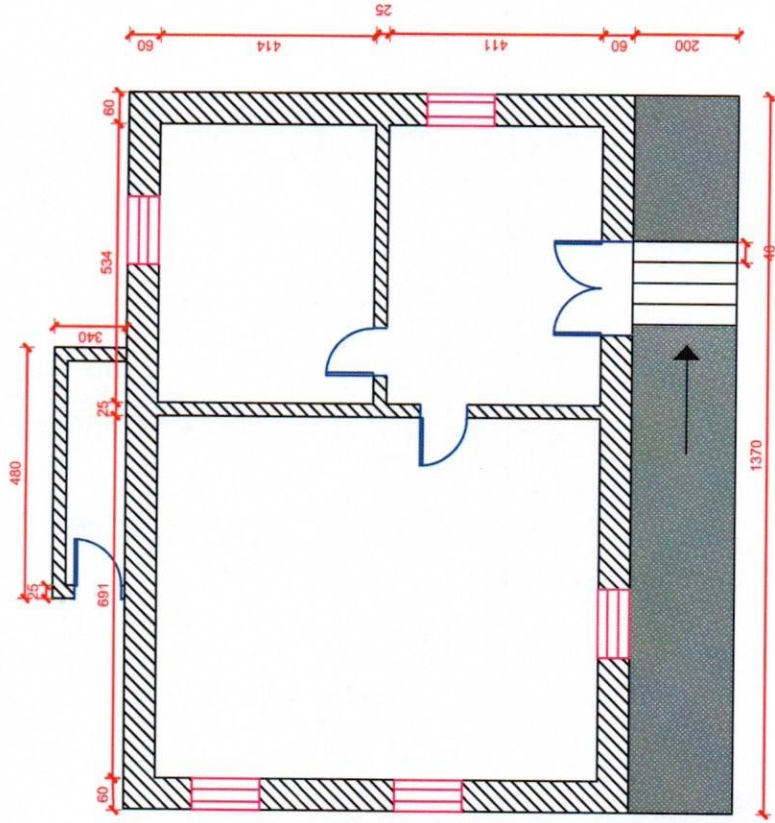

OBJEKTI:

Permitimi i kushteve te banimit per komunitet e varfera dhe te paforizuara

GRUPI TEKNIK I MATJEVE:

Ing. Aferdita KOÇI
 Ing. Julgerta BALLA
 Ing. Jurgjen MEMA

(Handwritten signatures)

SHKALLA 1:100

PLANIMETRIA E CATISE TE Z.GEZIM SINA
FSH.VEHCAN NJA. HOTOLISHT

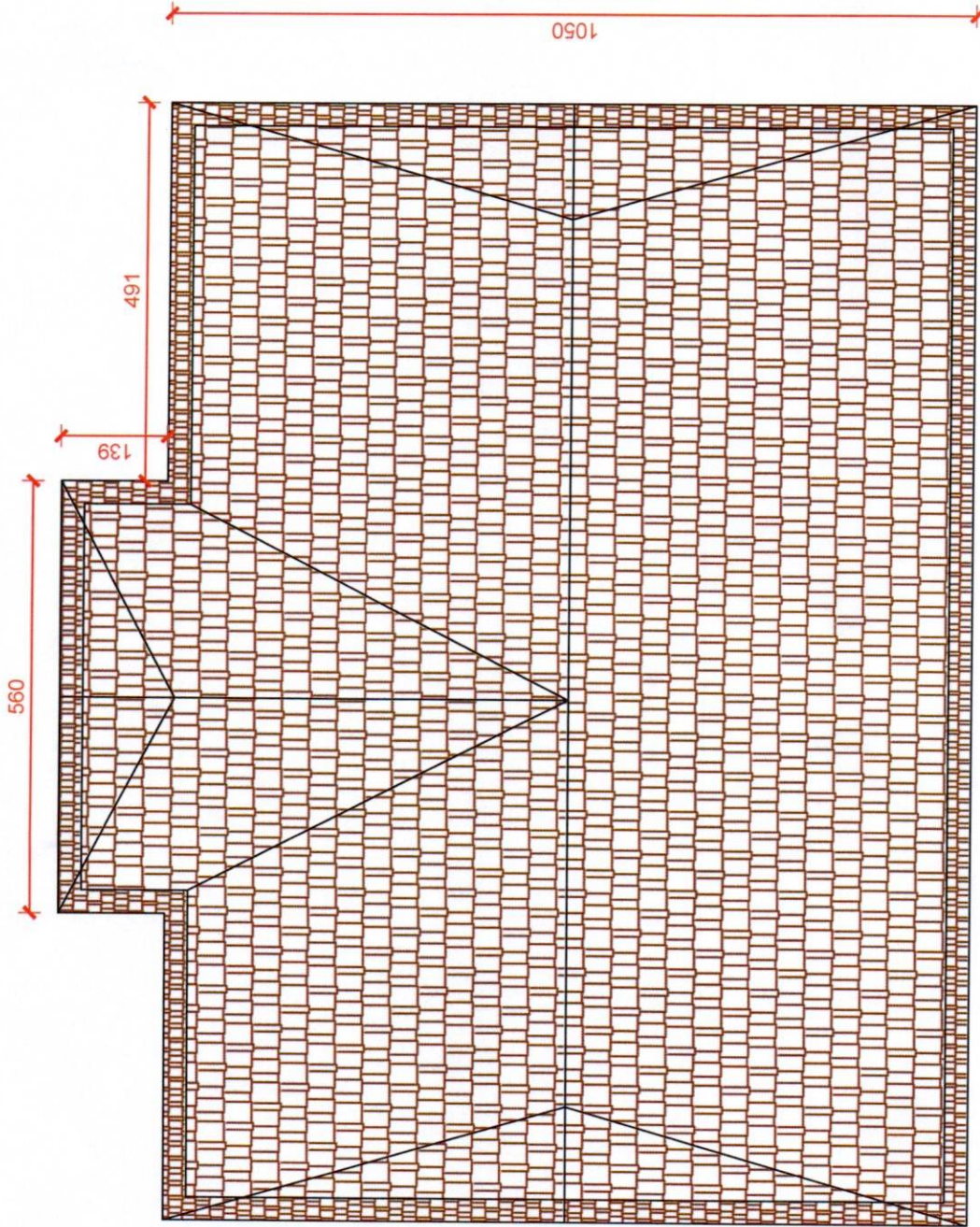

SHKALLA 1:100

GRUPI TEKNIK I MATJEVE:

Ing. Afërdita KOÇI Ing. Julgerta BALLA Ing. Jurgjen MEMA

OBJEKTI:

Përmirësimi i kushteve të banimit për komunitet e varfëra dhe të paforizuara

1450

PLANIMETRIA E BANESES TE Z.HALIL KOCI NJA.POLIS

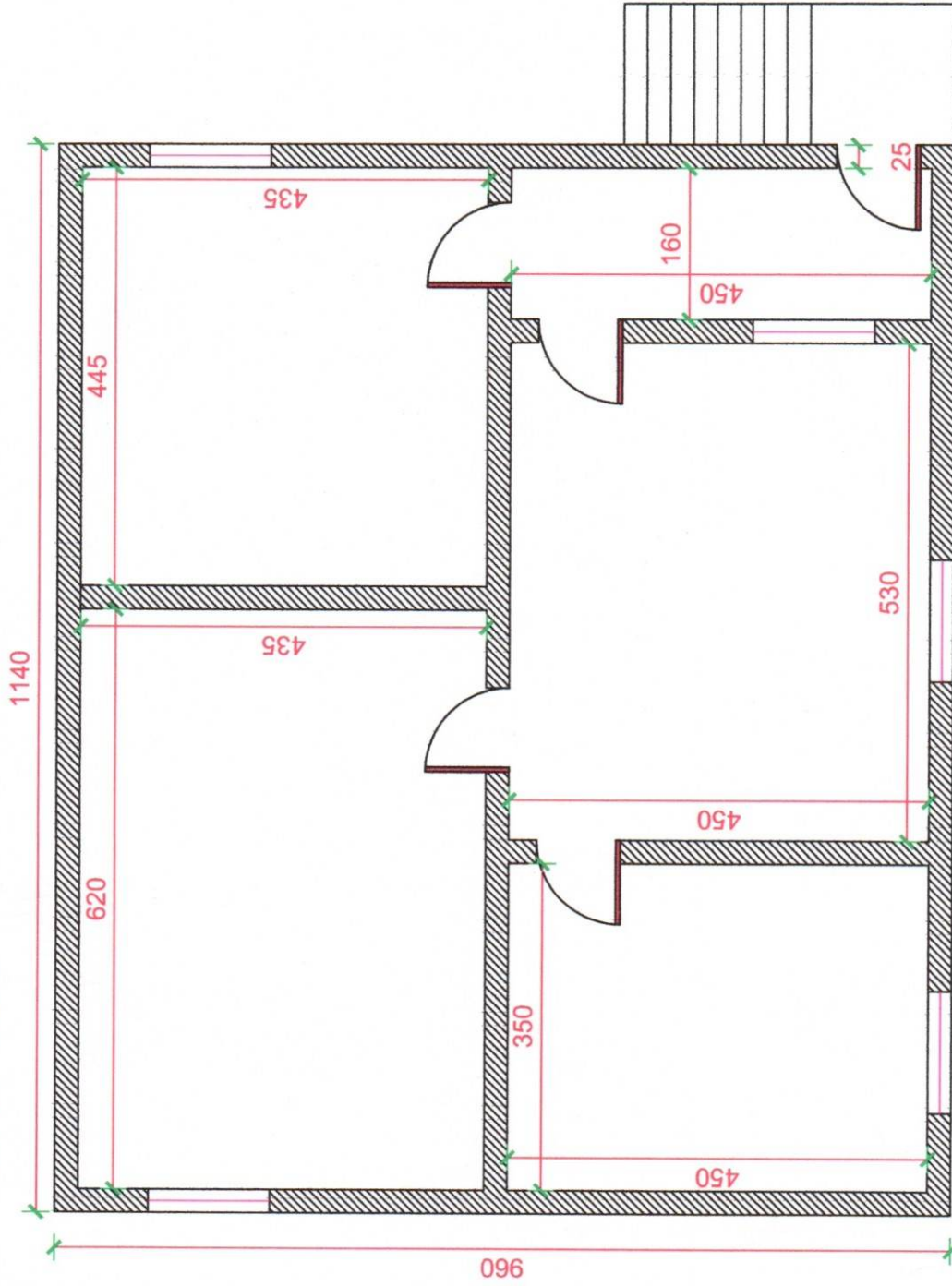

OBJEKTI:

Permirsimi i kushteve te banesave ekzistuese

PERGATITI:

Ing. Julgerta Balla Ing. Xhema Bozhqi Ing. Adela Haskurti

SHKALLA 1:100

PLANIMETRIA E CATISE TE Z.HALIL KOÇI
NJA.POLIS

1220

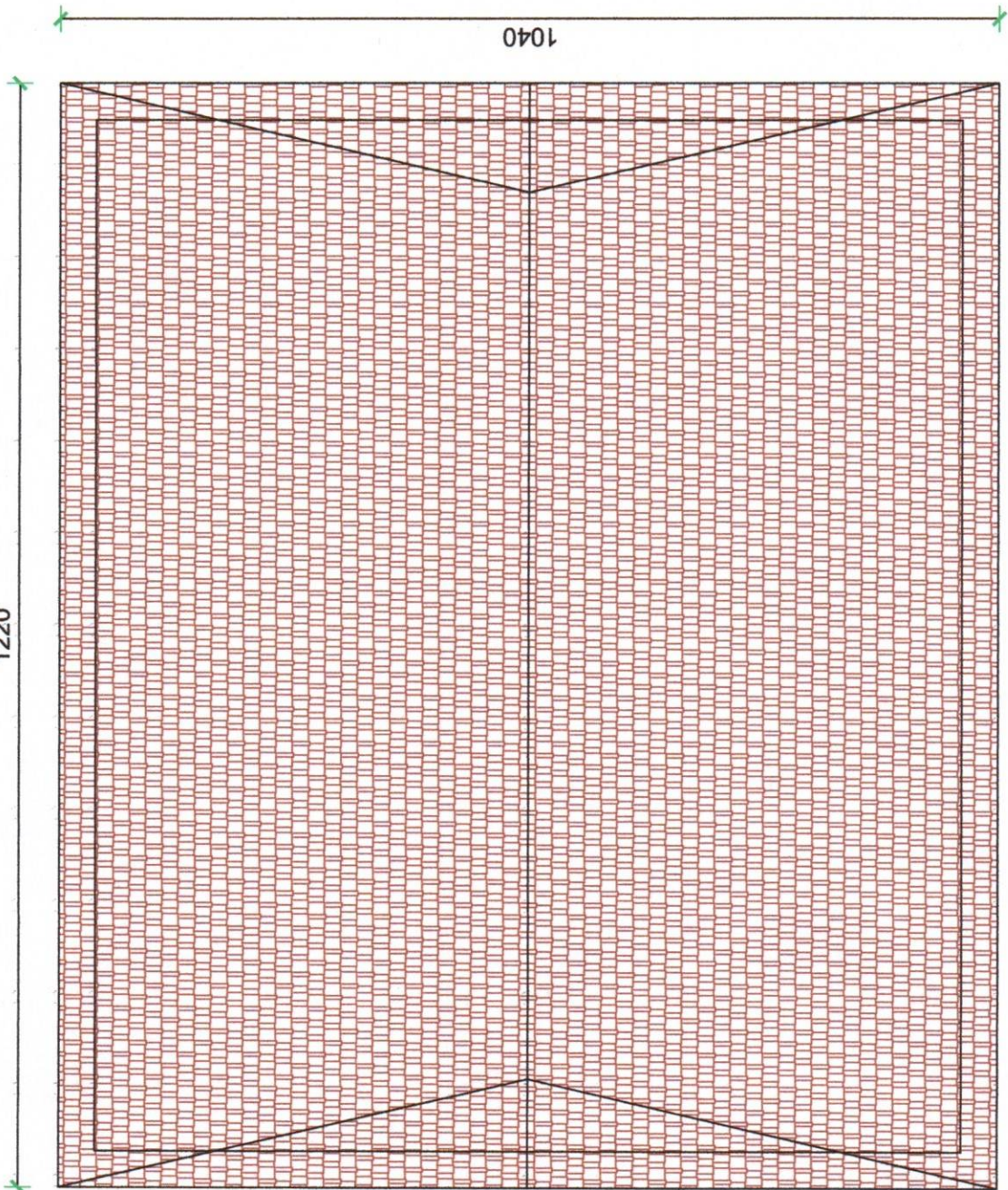

OBJEKTI:

Permiresimi i kushteve te banesave ekzistuese

PERGATITI:

Ing. Julgerta Balla Ing. Xhernal Bozhiqi Ing. Adela Haskurti

SHKALLA 1:100

PLANIMETRIA E KATIT TE PARE Sh. 1 : 100

Pronari :Ibrahim M. Shalla Fshati Mirake

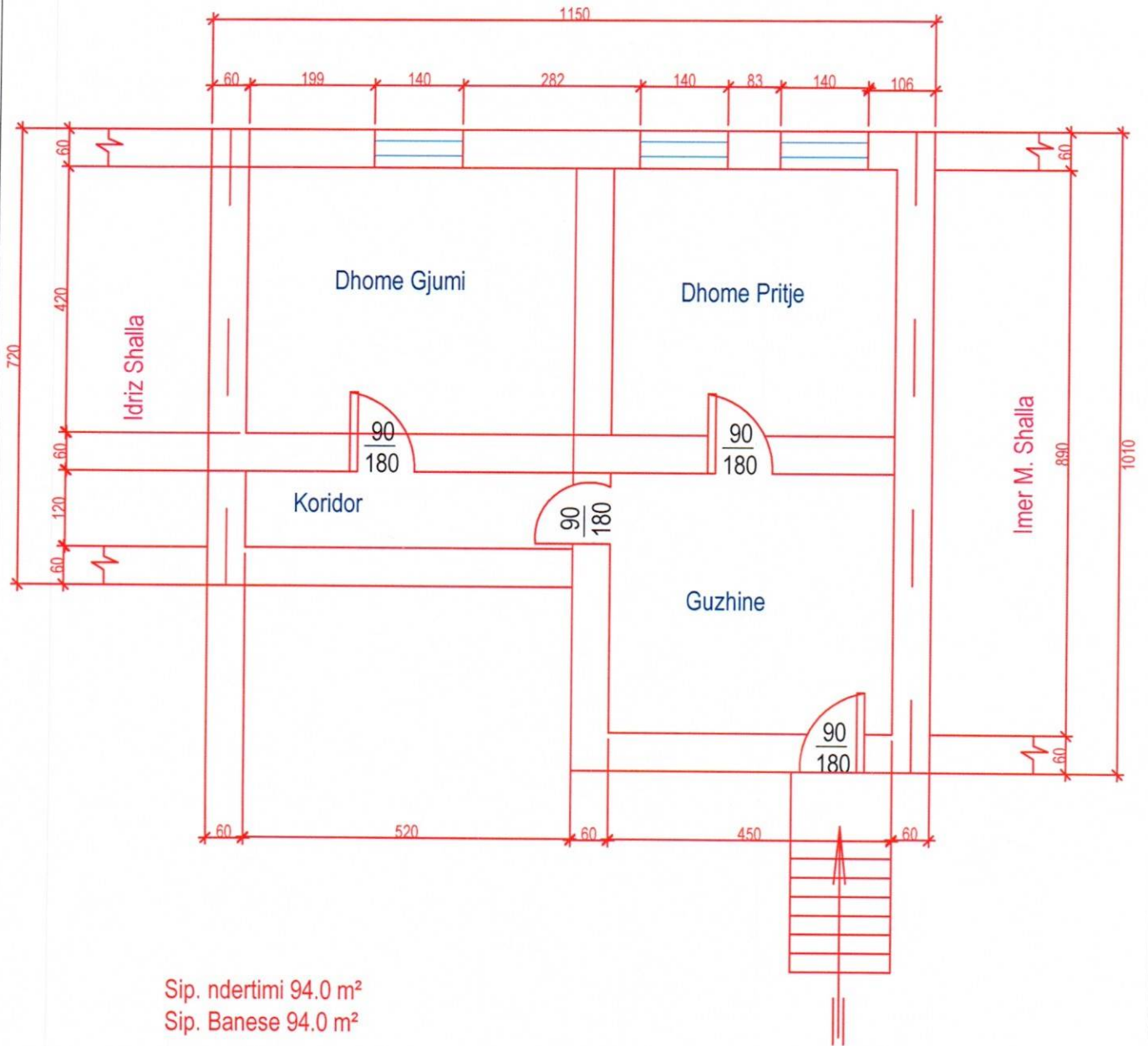

Shenim : Banesa eshte e formes 2 K.G.
mbuluar me çati me tjegulla vendi.

Punuan :

Ing. Xhemal Bozhici
Ing. Ervin Qatja

PLANIMETRI E OBJEKTIT TE Z. XHEMAL POCI
 NJ. A. POLIS, FSHATI GURSHPATE

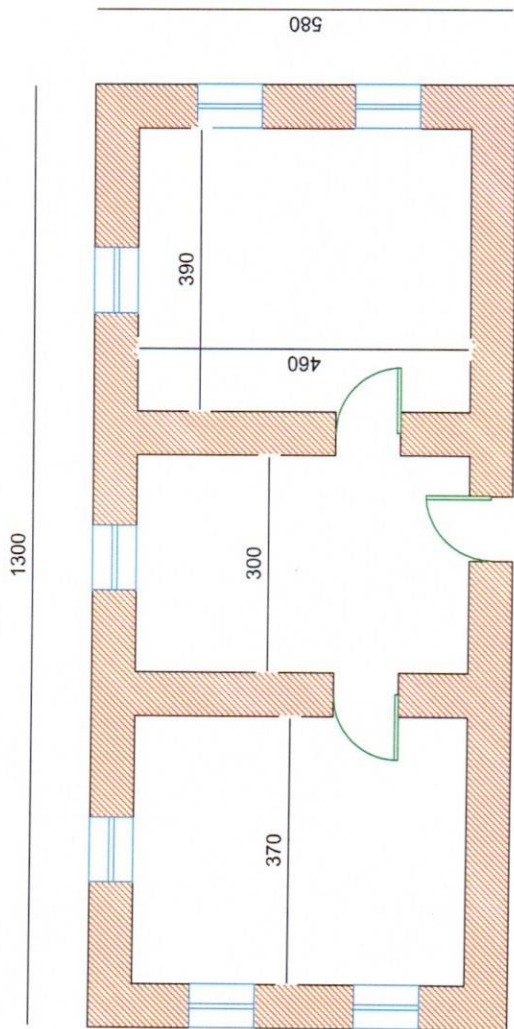

BASHNIA LIBRAZID



MIRATOHET
 KRYETARI BASHKISE
 MARIQLEN DISHA

OBJEKTI:

Permiresimi i kushteve te banimit per komunitet e varfera dhe te paforizuara

Partizan Ballolli

PUNOI:
 Robert Alla

Bujar Koci

PLANVENDOSJE

Per objektin "A" ndertese ne pronesi te Z.Xhemal Poçi
Nr. 993 Pasurie, ZK. 1910
Fshati Gurshpat, Njesia Administrative Polis, Bashkia Librazhd

MIRATOI
KRYETARI I BASHKISE
MARIGLEN DISHA

SH 1:1000



OBJEKTI "A" NE PLANVENDOSJE

KONFIRMOI:
ADMINISTRATORI I NJESISE ADMINISTRATIVE
Polis
Partizan Ballolli

PERGATITI
ZYRA E PROJEKTEVE

PLANIMETRI E OBJEKTIT TE Z. GANI STERMUGU
NJ. A. POLIS, FSHATI POLIS-GOSTIME

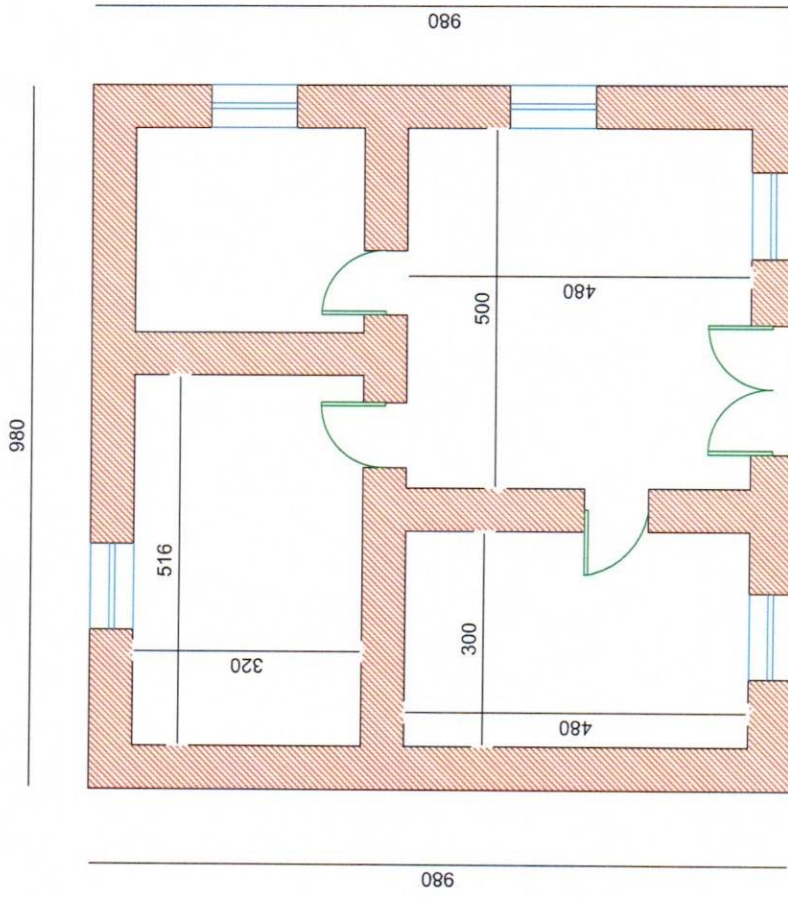

OBJEKTI:

Permiresimi i kushteve te banimit per komunitet e varfera dhe te pafortezuara

PUNOI:

Partizan Ballolli Robert Alla Bujar Koci

PLANVENDOSJE

Per objektin "A" ndertese ne pronesi te Z.Gani Stermuku
Nr. 650/1 Pasurie, ZK. 1821
Fshati Gostime, Njesia Administrative Polis, Bashkia Librazhd

MIRATOI
KRYETARI I BASHKISE
MARIQLENE DISHA

SH 1:1000



OBJEKTI "A" NE PLANVENDOSJE

KONFIRMOI:
ADMINISTRATORI I NJESISE ADMINISTRATIVE
Polis
Partizan Ballolli

PERGATITI
ZYRA E PROJEKTEVE

PLANIMETRI E OBJEKTIT TE Z. IMER BALLOLLI dhe LAHE BALLOLLI
 NJ. A. POLIS, FSHATI POLIS-QENDER

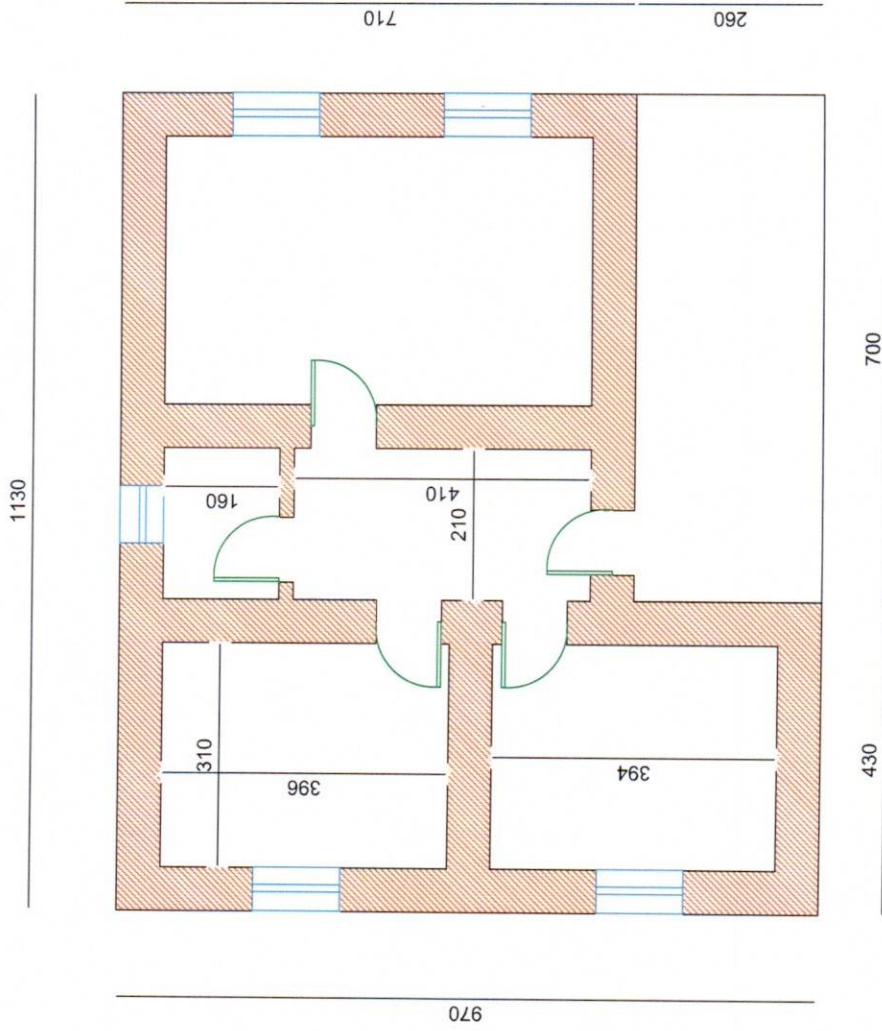

BASHKIA LIBRAZHD



MIRATOHET
 KRYETARI BASHKISE
 MARIIGLEN DISHA

OBJEKTI:

Permitresimi i kushteve te banimit per komunitet e varfere dhe te paforizuara

PUNOI:

Partizan Ballolli Robert Alla Bujar Koci

PLANVENDOSJE

Per objektin "A" ndertese ne pronesi te Z.Imer Ballolli
Nr. 540 Pasurie, ZK. 3020
Fshati Polis-Qender, Njesia Administrative Polis, Bashkia Librazhd

MIRATOI
KRYETARI I BASHKISE
MARIQLENE DISHA

SH 1:1000

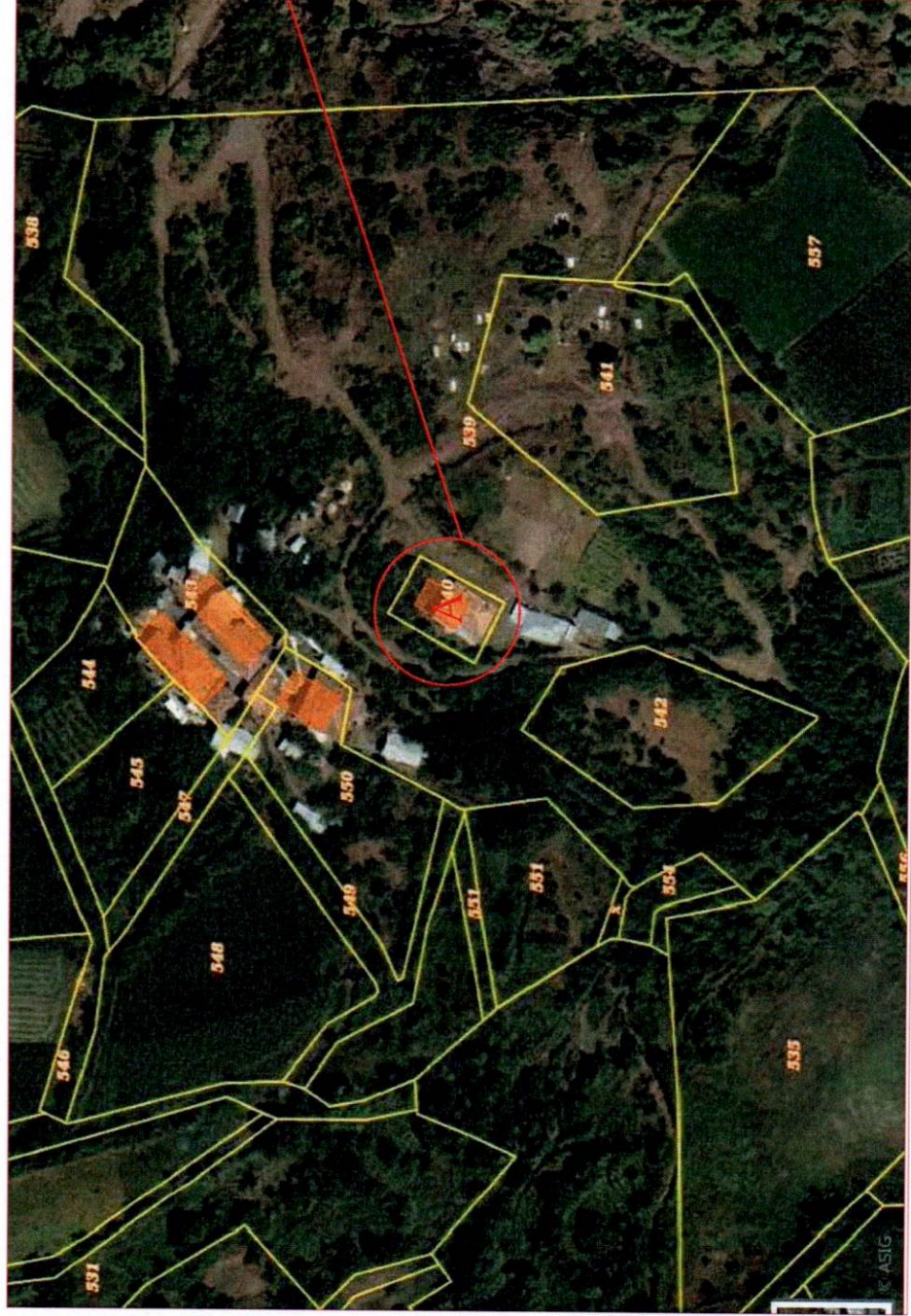

OBJEKTI "A" NE PLANVENDOSJE

KONFIRMOI:
ADMINISTRATORI I NJESISE ADMINISTRATIVE
Polis
Partizan Ballolli

PERGATITI
ZYRA E PROJEKTEVE

PLANIMETRI E OBJEKTIT TE Z. ALTIN LLESHI
 NJ. A. POLIS, FSHATI POLIS-GOSTIME

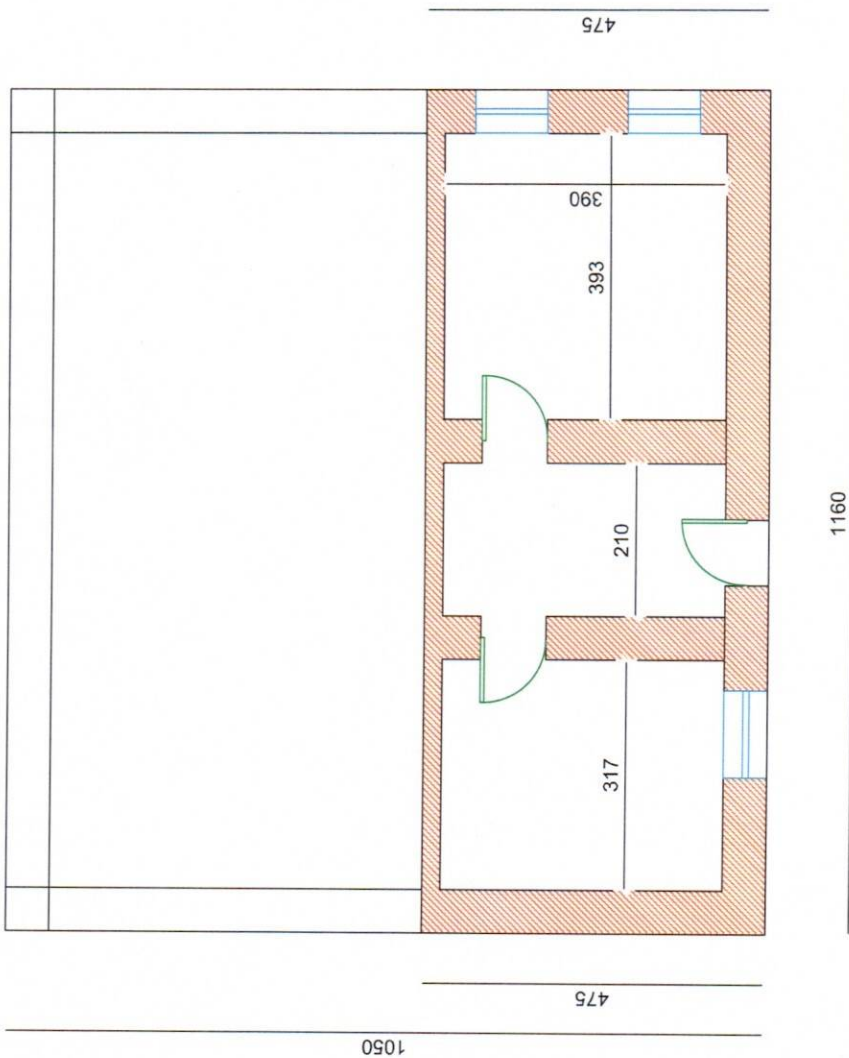

MIRATOHET
 KRYETARI BASHKISE
 MARIIGLEN DISHA

OBJEKTI:

Permitresimi i kushteve te banimit per komunitet e varfera dhe te paforizuara

PUNOI:

Partizan Ballolli Robert Alla Bujar Koci

PLANIMETRI E OBJEKTIT TE ZNJ. HATIXHE BALLAGAJ
NJ. A. POLIS, FSHATI POLIS-QENDER

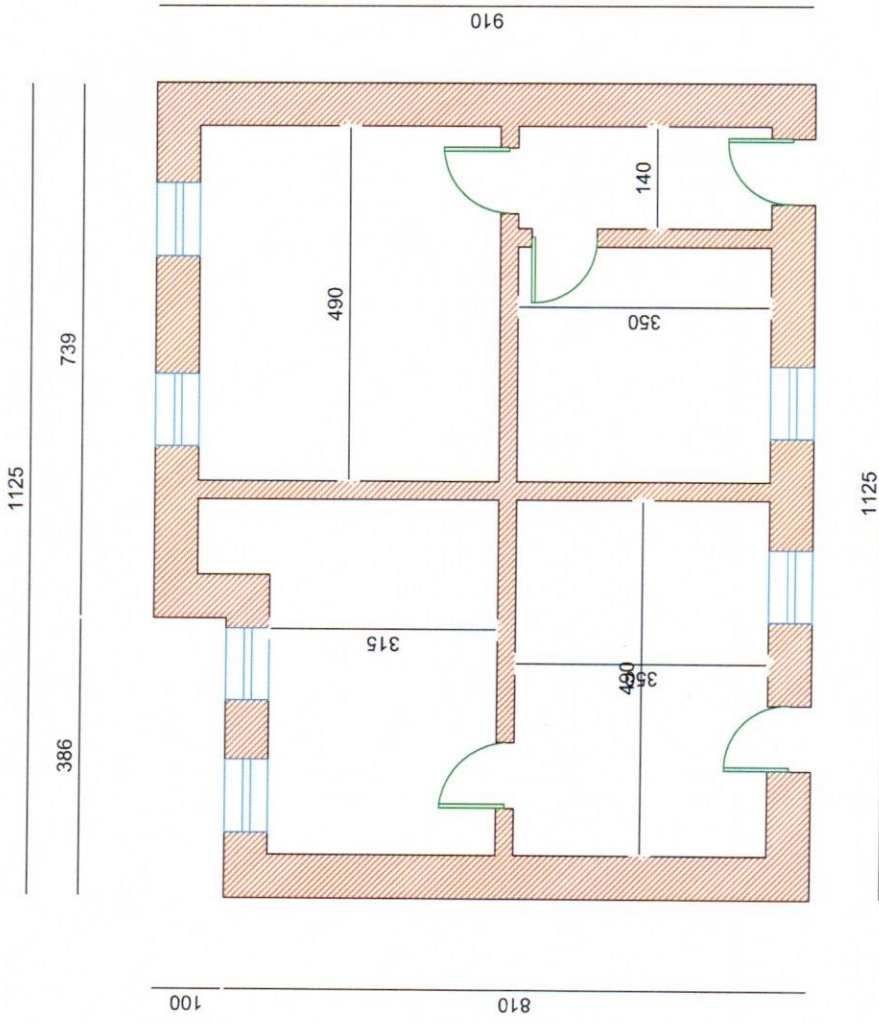

SHKALLA 1:100

BASHKIA LIBRAZHD



MIRATOHET
KRYETARI BASHKISE
MARIGLEN DISHA

OBJEKTI:

Permiresimi i kushteve te banimit per komunitet e varfera dhe te paforzuar

PUNOI:

Partizan Ballolli Robert Alla

Bujar Koci

PLANVENDOSJE

Per objektin "A" ndertese ne pronesi te Z.Hatixhe Ballagaj
Nr. 686 Pasurie, ZK. 3020
Fshati Polis-Qender, Njesia Administrative Polis, Bashkia Librazhd

MIRATOI
KRYETARI I BASHKISE
MARIGLEN DISHA

SH 1:1000

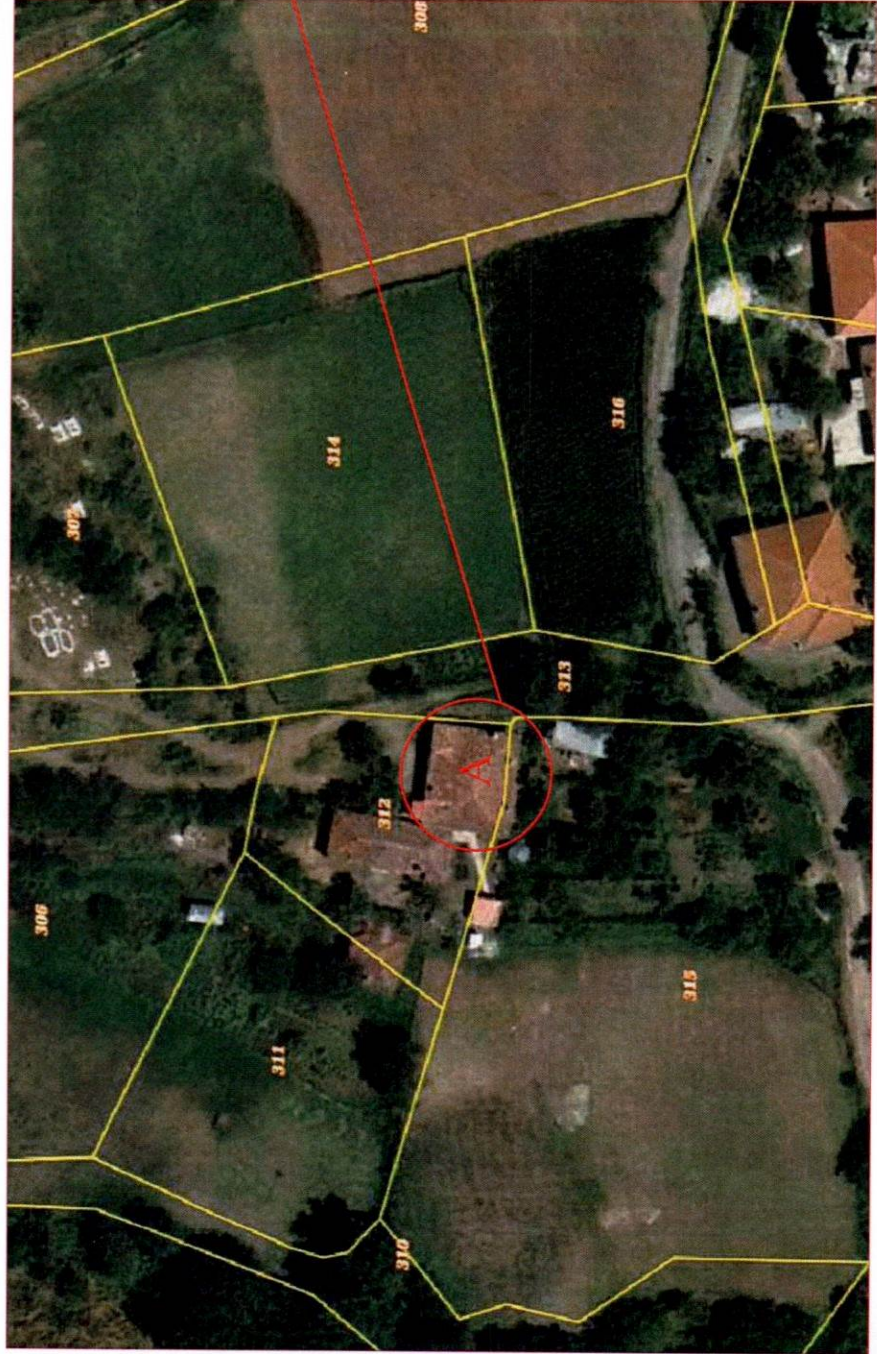

OBJEKTI "A" NE PLANVENDOSJE

KONFIRMOI:
ADMINISTRATORI I NJEISE ADMINISTRATIVE
Polis
Partizan Ballolli

PERGATITI
ZYRA E PROJEKTEVE

BANESA SHEFQET SHKALLA

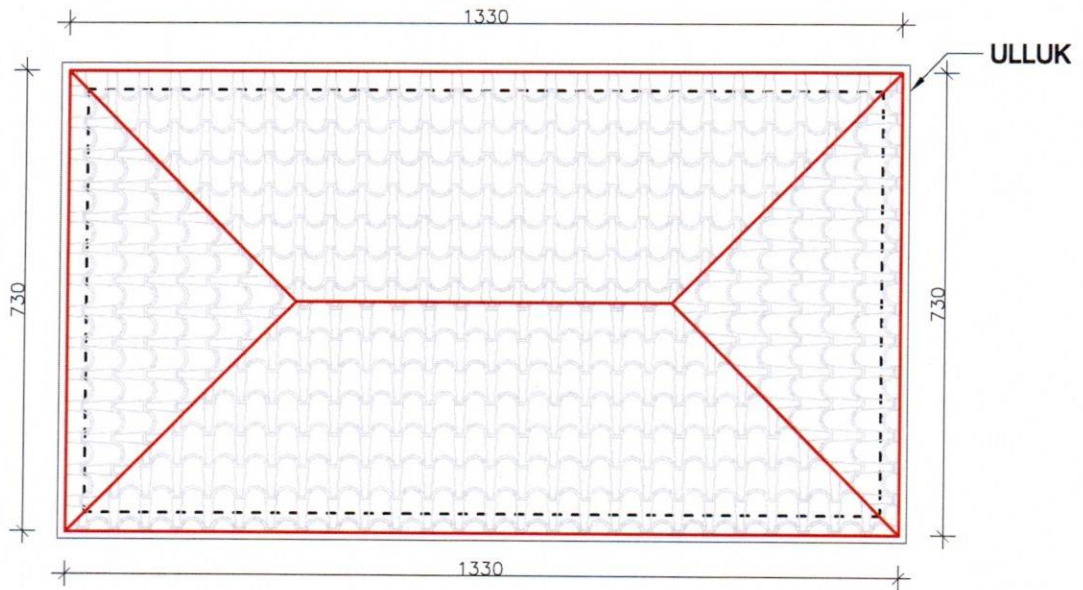

SIPERFAQE SIPAS PROJEKSIONIT 97M2

PLANIMETRIA PERKATESE

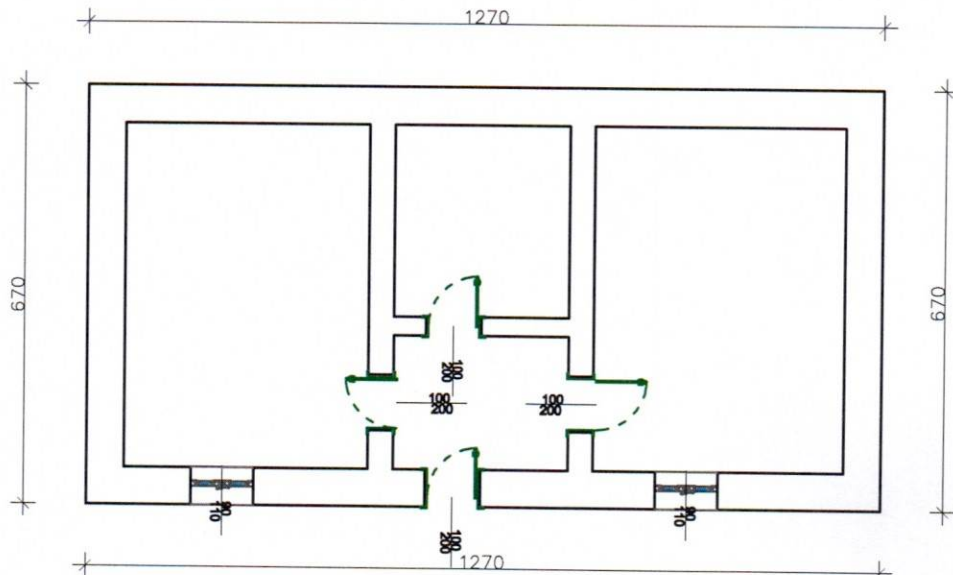

Handwritten signature

BANESA MYZAFER SHPATA

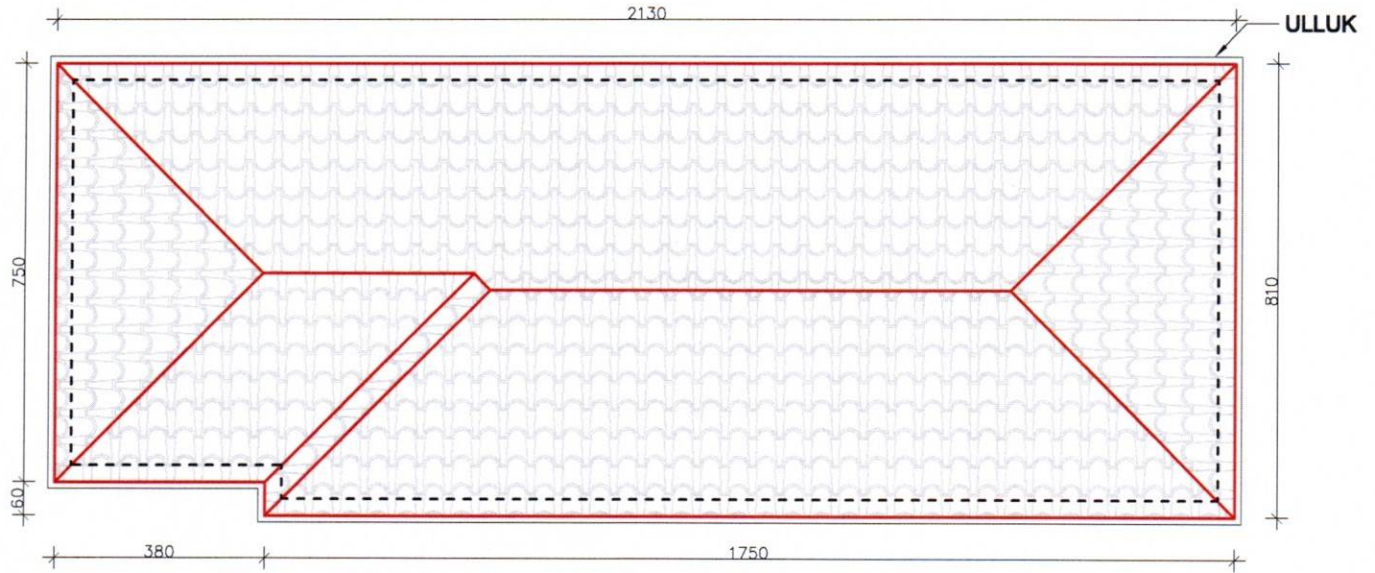

SIPERFAQE SIPAS PROJEKSIONIT 170M²

PLANIMETRIA PERKATESE

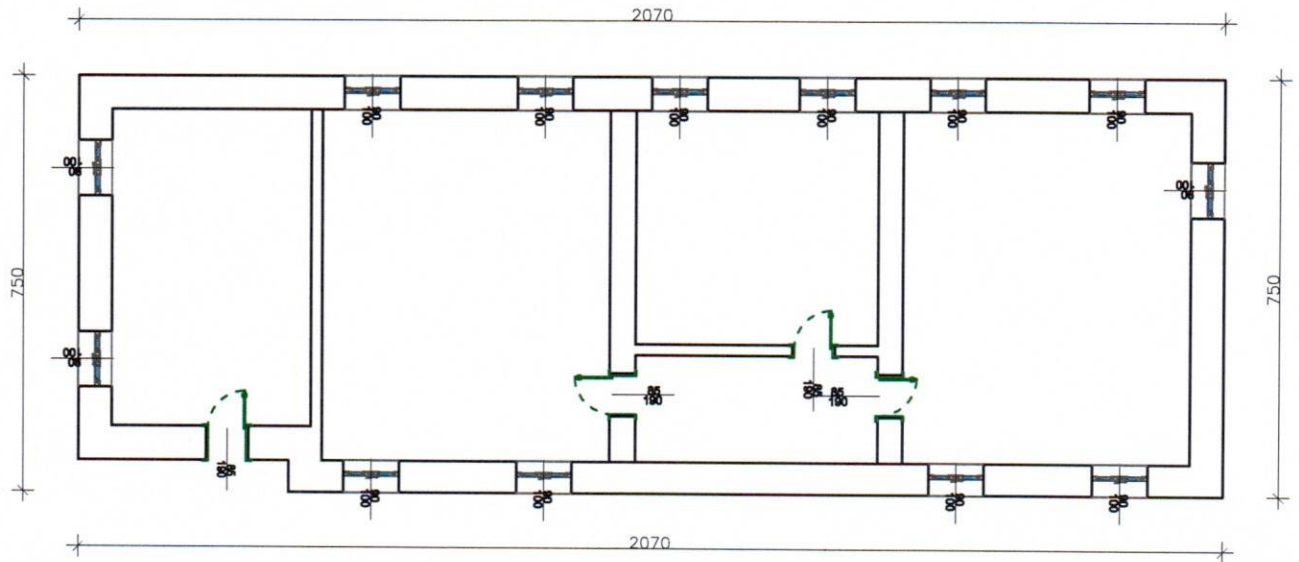

Handwritten signature

BANESA SYRI COKU

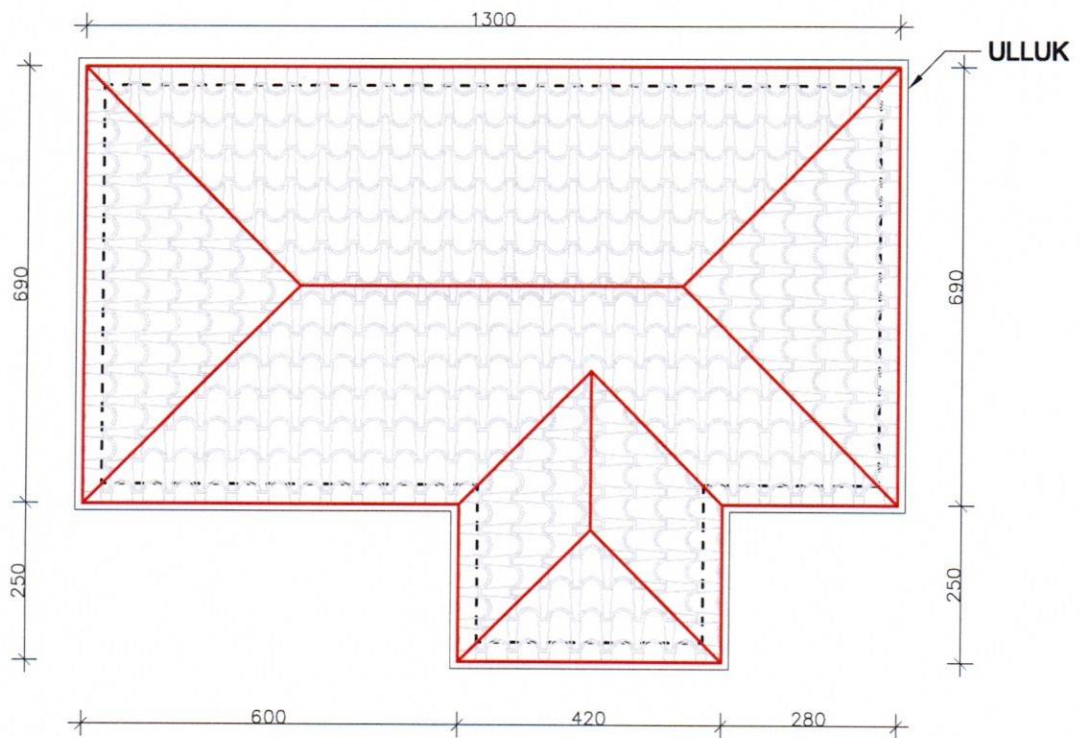

SIPERFAQE SIPAS PROJEKSIONIT 100M2

PLANIMETRIA PERKATESE

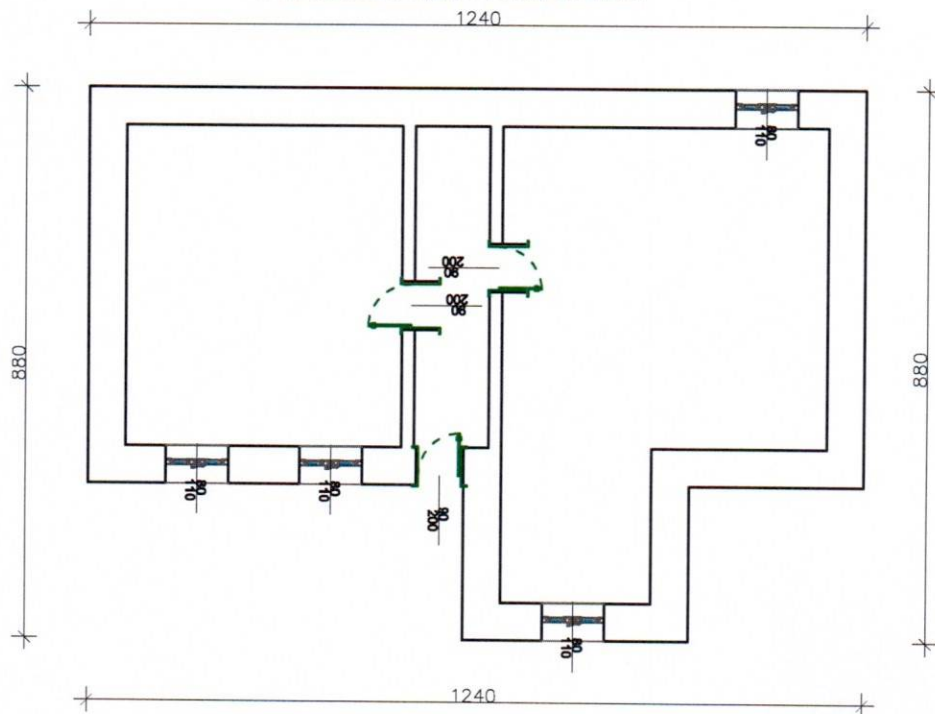

Handwritten signature

BANESA ISUF BALLA

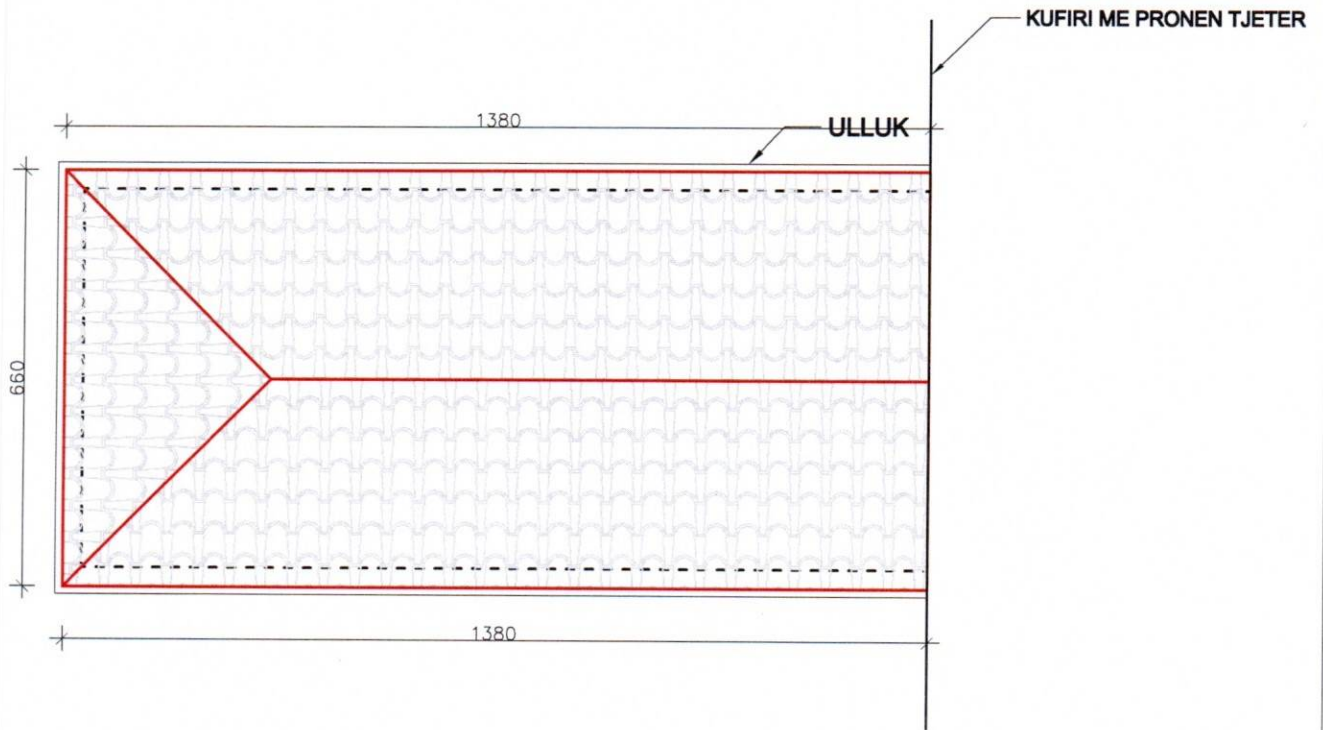

SIPERFAQE SIPAS PROJEKSIONIT 91M²

PLANIMETRIA PERKATESE

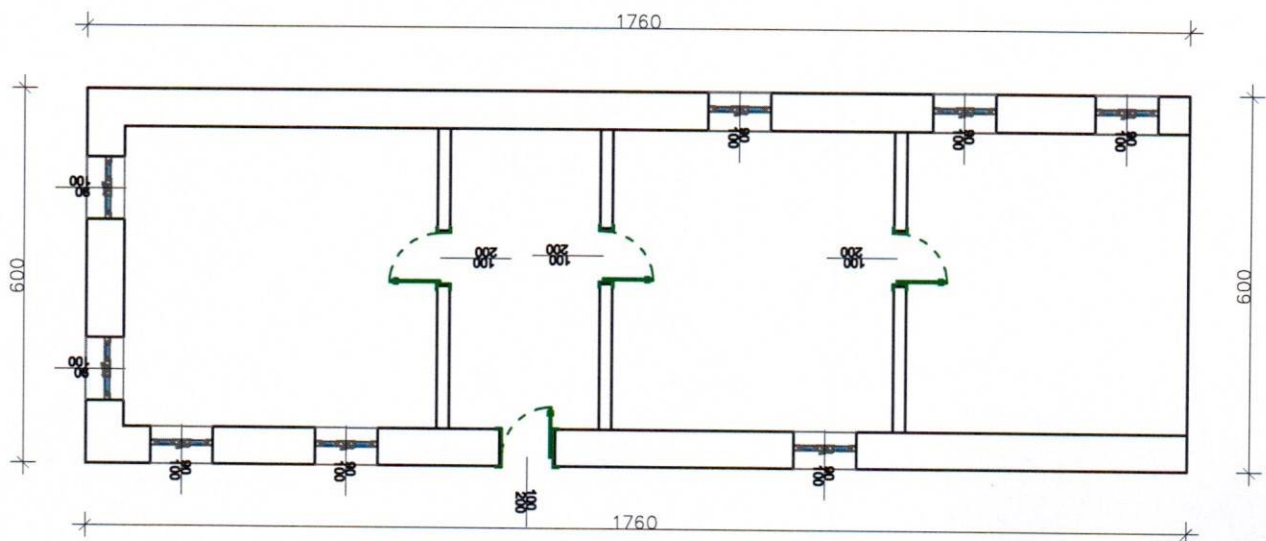

BANESA S.BORUFI

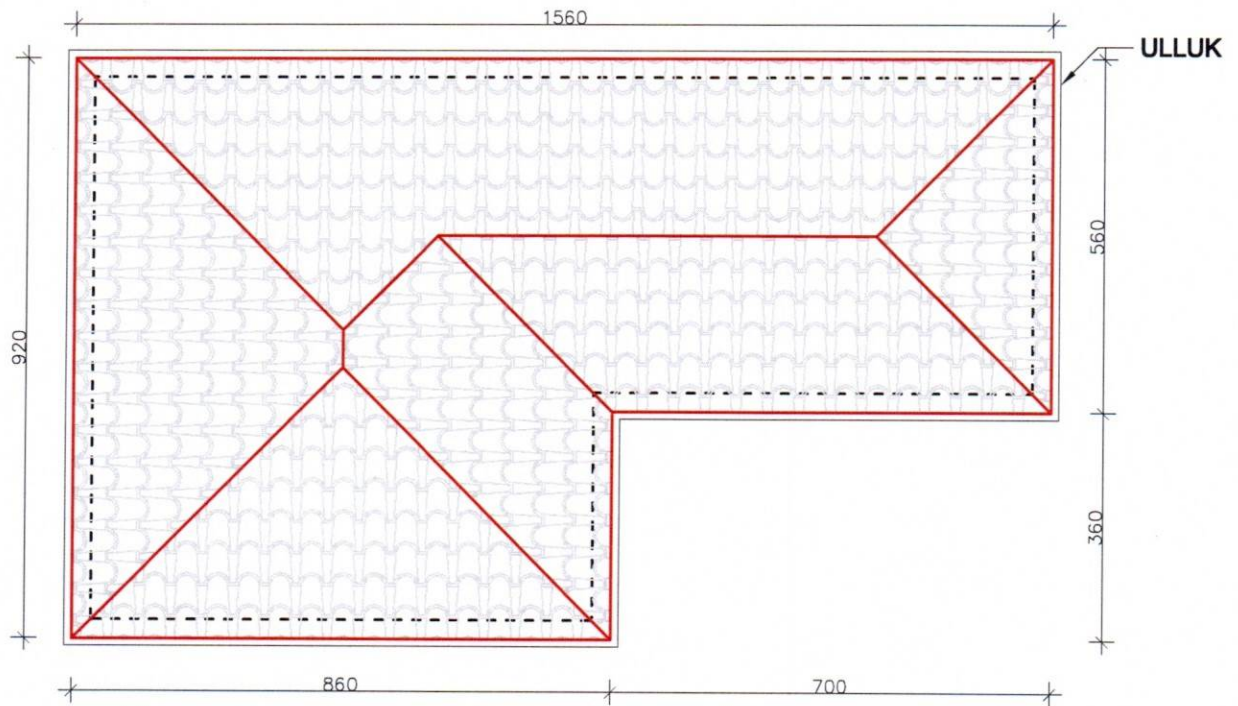

SIPERFAQE SIPAS PROJEKSIONIT 118M2

PLANIMETRIA PERKATESE

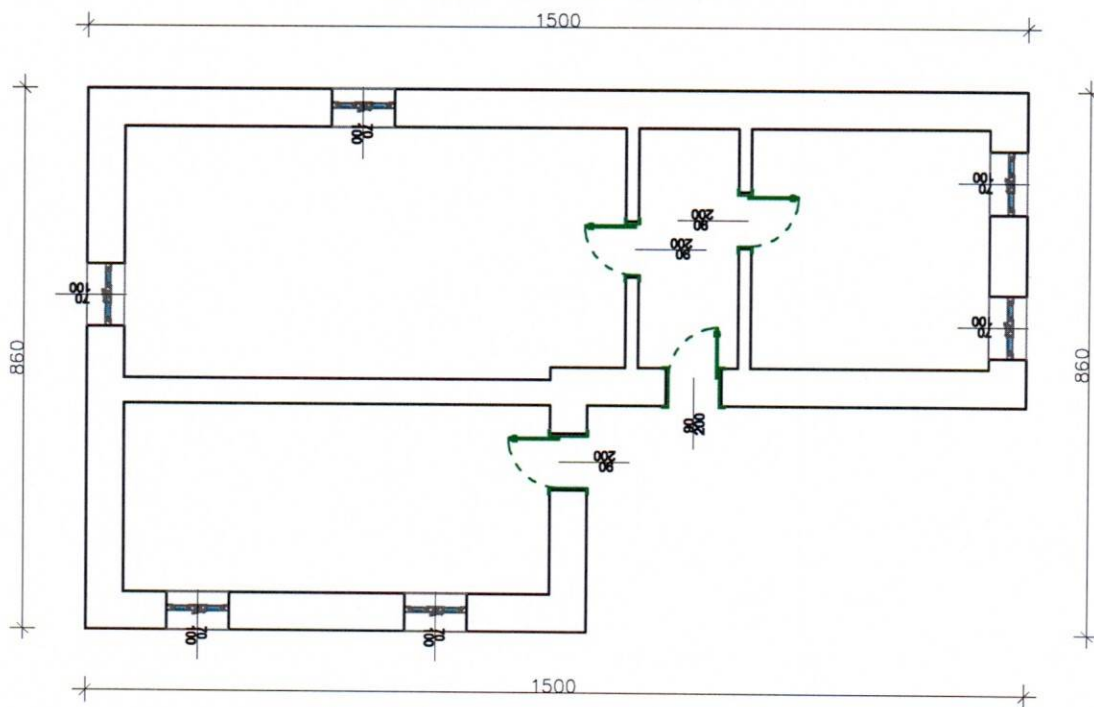

[Handwritten signature]

BANESA BELUL SALLAKU

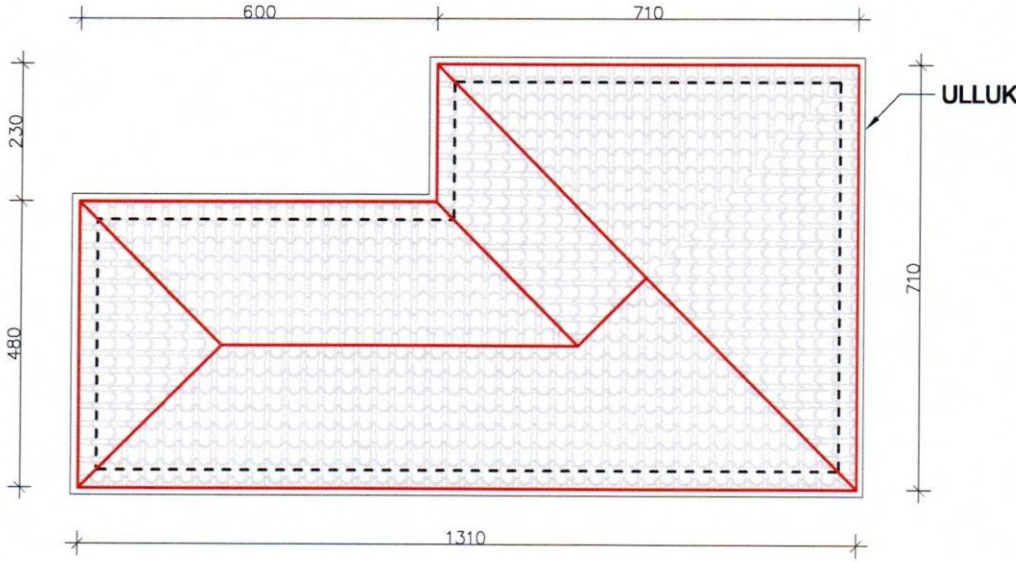

SIPERFAQE SIPAS PROJEKSIONIT 80M2

PLANIMETRIA PERKATESE

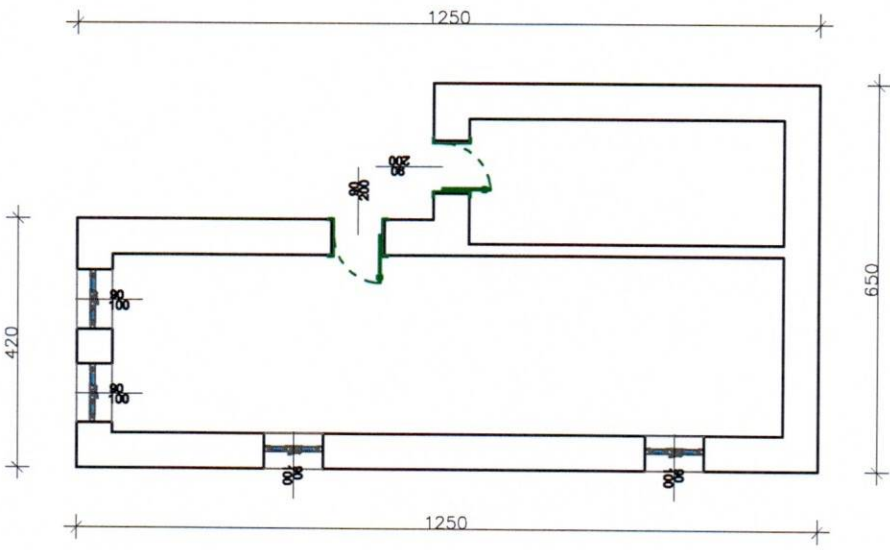

BANESA ALTIN KULLAFI

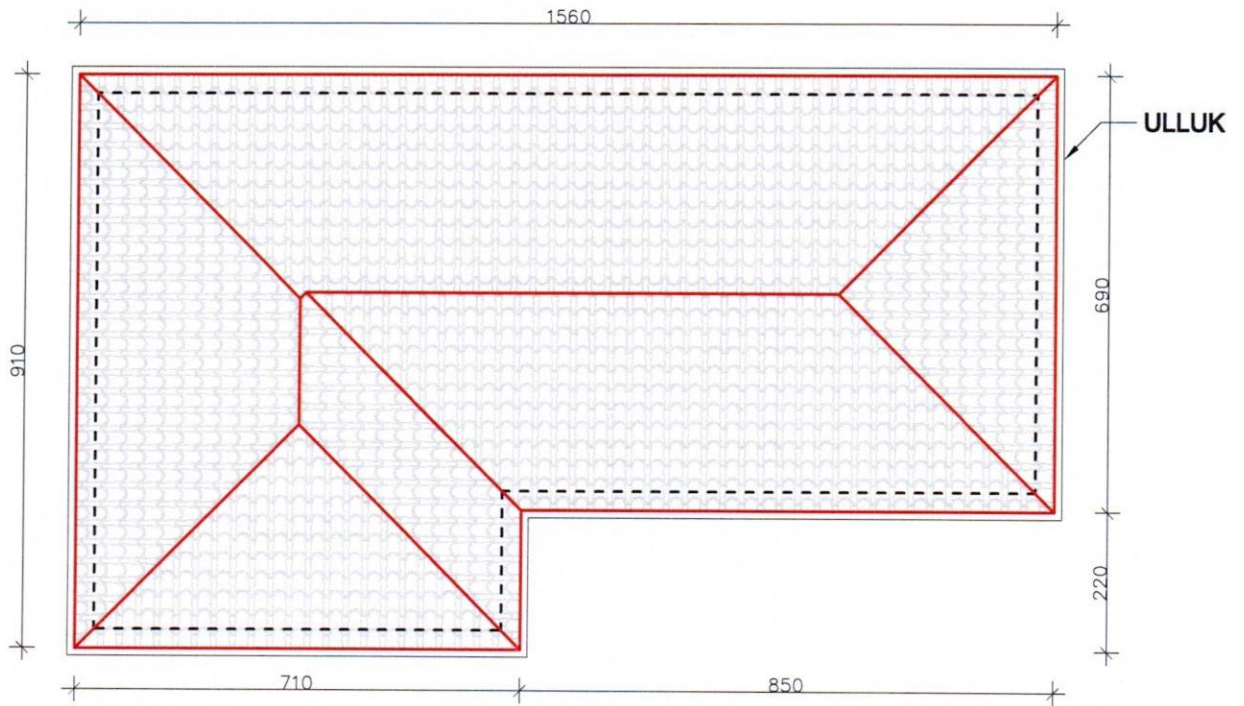

SIPERFAQE SIPAS PROJEKSIONIT 123M²

PLANIMETRIA PERKATESE

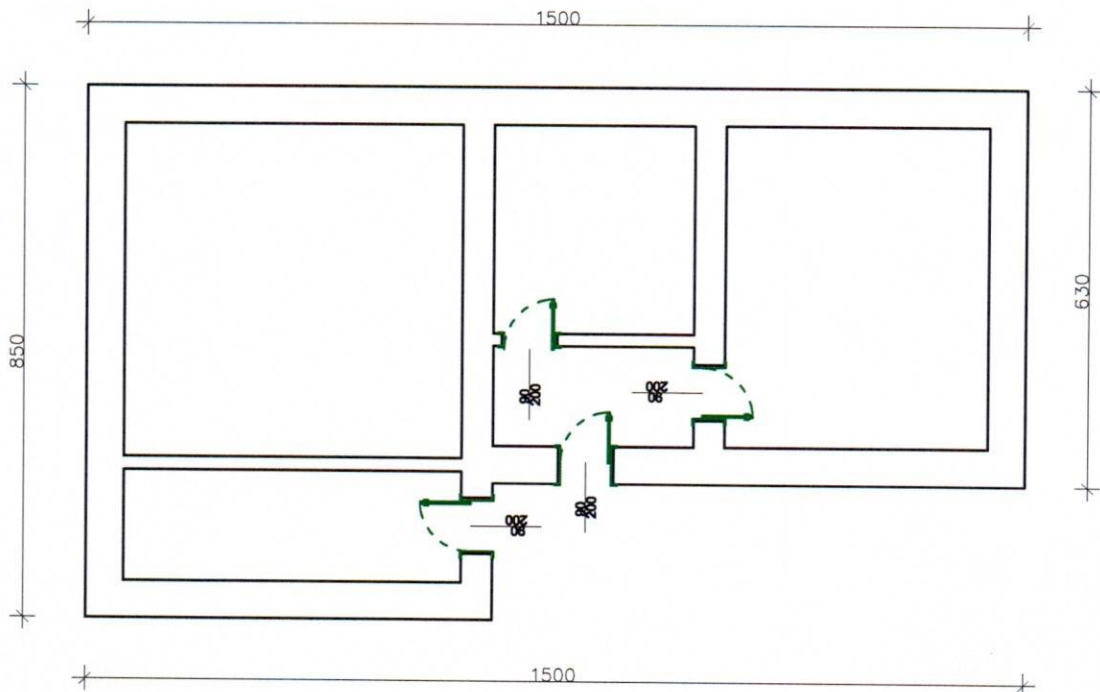

[Handwritten signature]

BANESA NASIF PESHKU

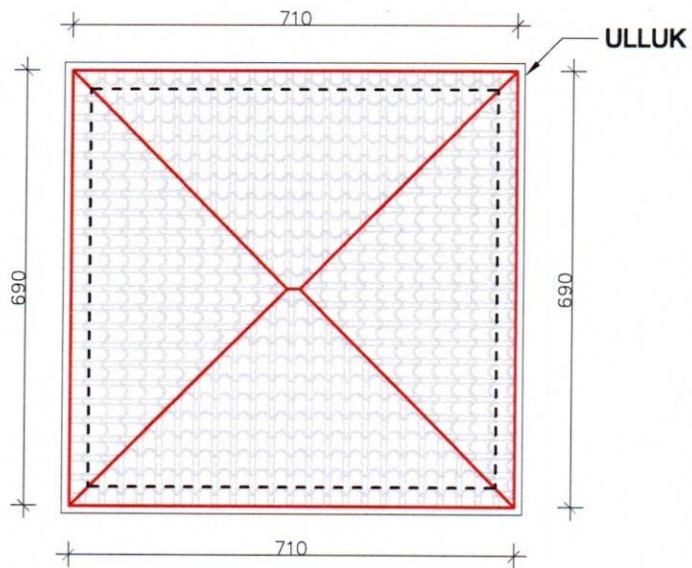

SIPERFAQE SIPAS PROJEKSIONIT 49M2

PLANIMETRIA PERKATESE

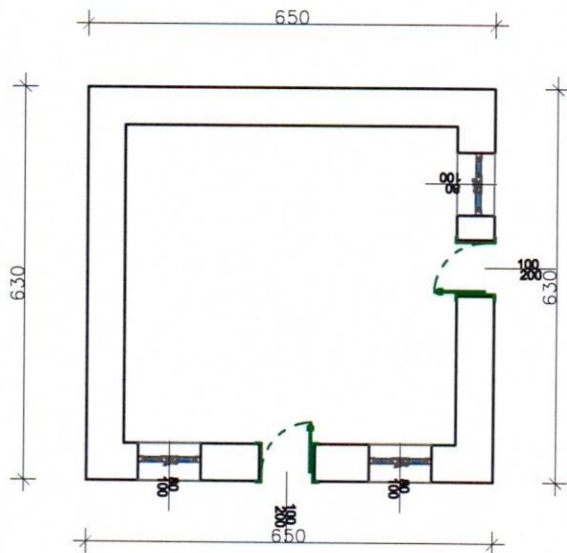

Handwritten signature

BANESA GAZMIR HEKURI

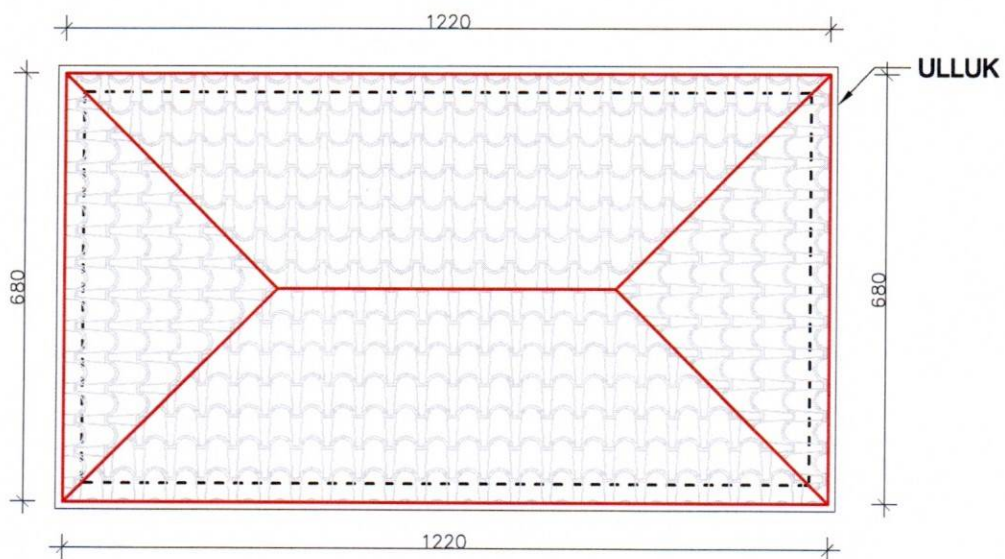

SIPERFAQE SIPAS PROJEKSIONIT 83M2

PLANIMETRIA PERKATESE

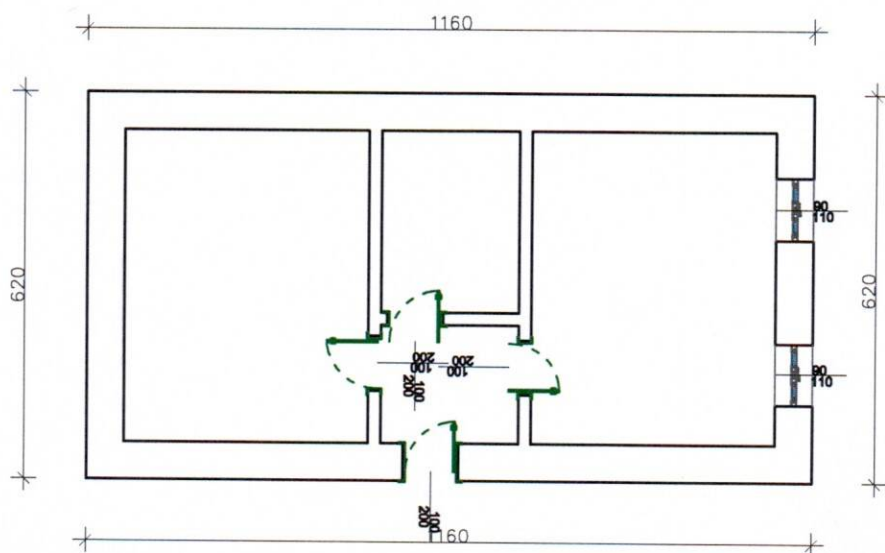

BANESA SADIK TUSKU

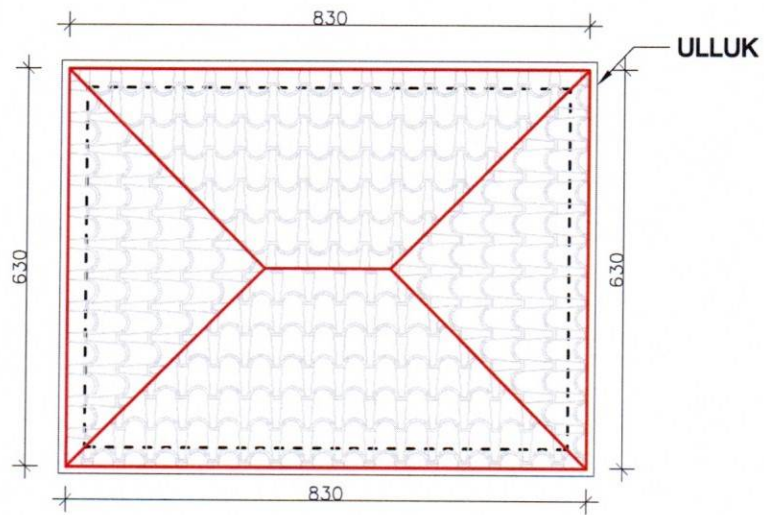

SIPERFAQE SIPAS PROJEKSIONIT 53M2

PLANIMETRIA PERKATESE

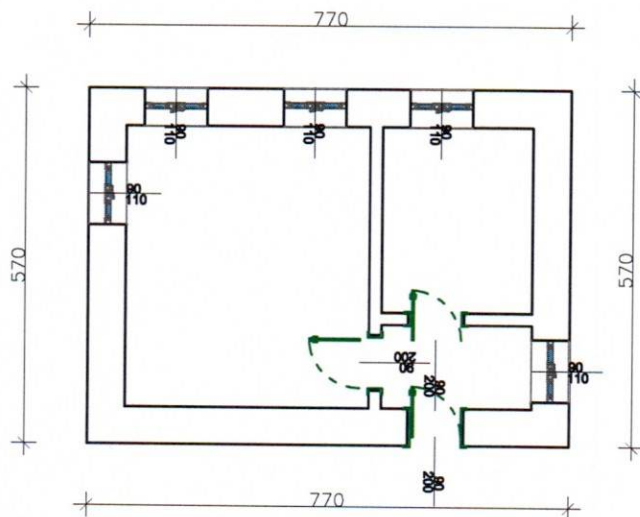

PLANIMETRI E OBJEKTIT 2 KAT TE Z. ISMAIL QOSHI
NJ. A. LUNIK FSHATI ZGOSHT.

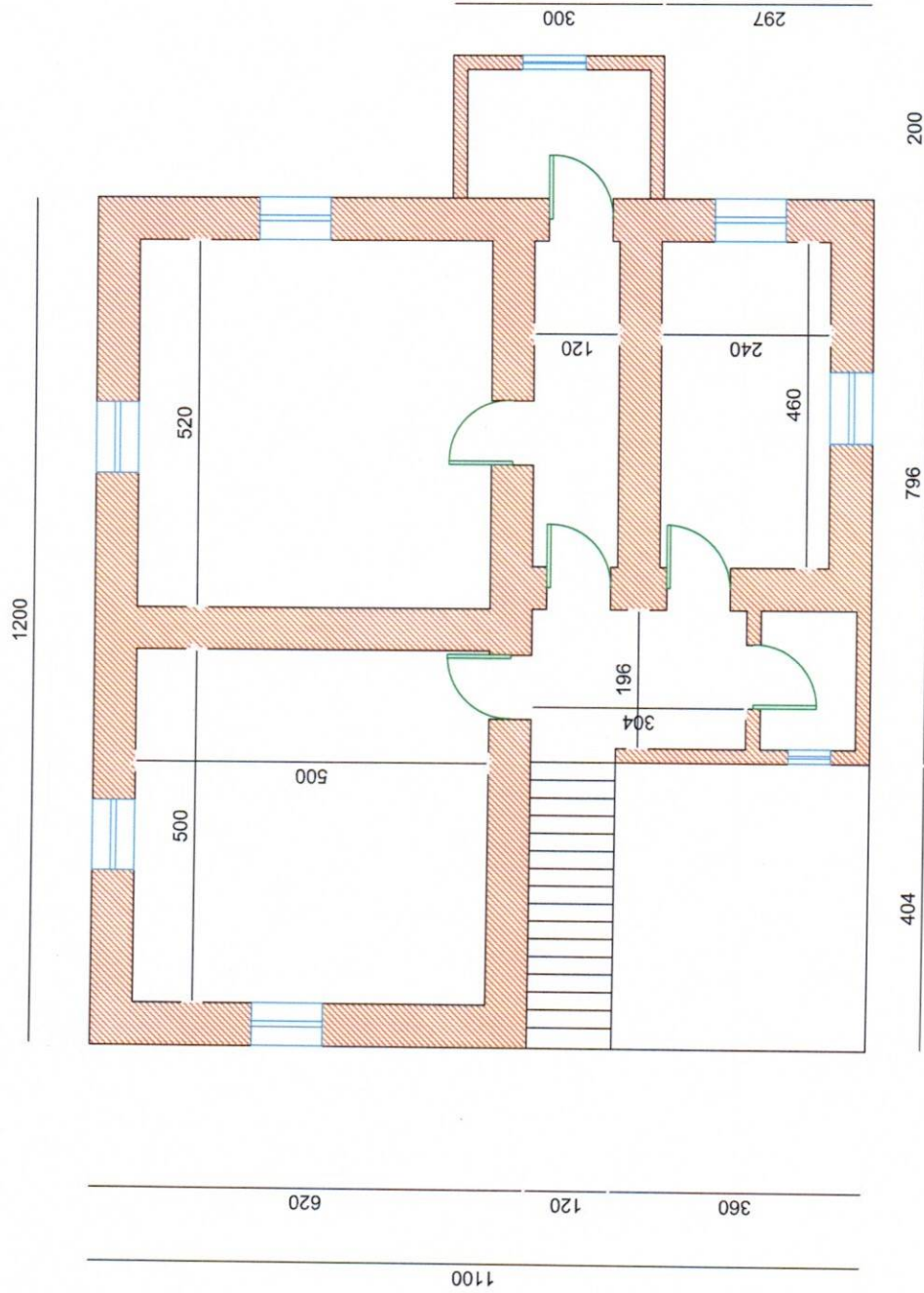

BASHKIA LIBRAZHD
MIRATO:
KRYETARI BASHKISE
MARIGLEN DISHA



OBJEKTI:

Permiresimi i kushteve te banimit per komunitet e varfera dhe te pafortizuara

PUNOI:

XHEMAL BOZHIQI, DORIAN HASULA, ERVIN QATJA

PLANVENDOSJE

Per objektin "A" ndertese ne pronesi te Z. Ismail Qoshi
Nr. 474 Pasurie, ZK. 3913
Fshati Zgosht, Njesia Administrative Lunik, Bashkia Librazhd

MIRATOI
KRYETARI I BASHKISE
MARIGLEN DISHA

SH 1:1000



OBJEKTI "A" NE PLANVENDOSJE

KONFIRMOI:
ADMINISTRATORI I NJESISE ADMINISTRATIVE
Lunik
Andon Kodraliu

PERGATITI
ZYRA E PROJEKTEVE

PLANIMETRI E OBJEKTIT TE Z. ARDIAN KALECI
NJ. A. STEBLEVE, FSHATI ZABZUN.

1420

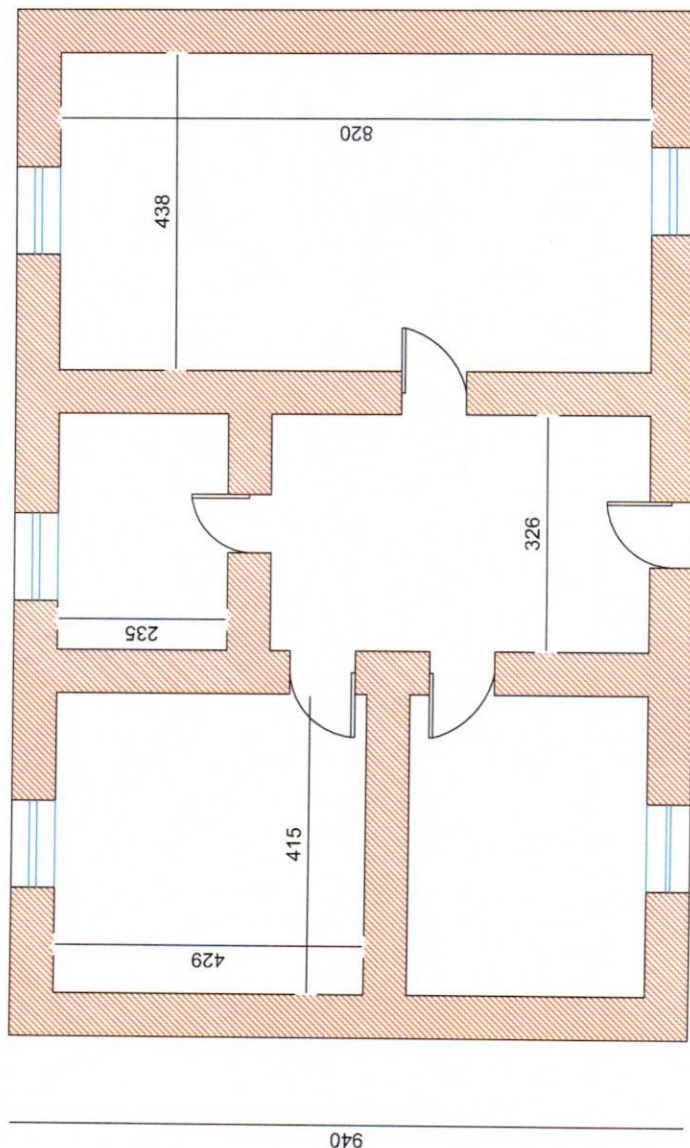

940

BASHKIA LIBRAZHD



MIRATOHET
KRYETARI BASHKISE
MARIGLEN DISHA

OBJEKTI:

Permitimi i kushteve te banimit per komunitet e varfera dhe te paforizuara

PUNOI:

Enri Gjura

PLANVENDOSJE

Per objektin "A" ndertese ne pronesi te Z.Ardian Kaleci
Nr. 5 Pasurie, ZK. 2478
Fshati Llange, Njesia Administrative Stebleve, Bashkia Librazhd

SH 1:1000



MIRATOI
KRYETARI I BASHKISE
MARI GLEN DISHA

OBJEKTI "A" NE PLANVENDOSJE

KONFIRMOI:
ADMINISTRATORI I NJESISE ADMINISTRATIVE
Stebleve
Albert Kaleci

PERGATITI
ZYRA E PROJEKTEVE

PLANIMETRI E OBJEKTIT TE Z. HEKURAN GJINI
N.J. A. STEBLEVE, FSHATI ZABZUN.

1670

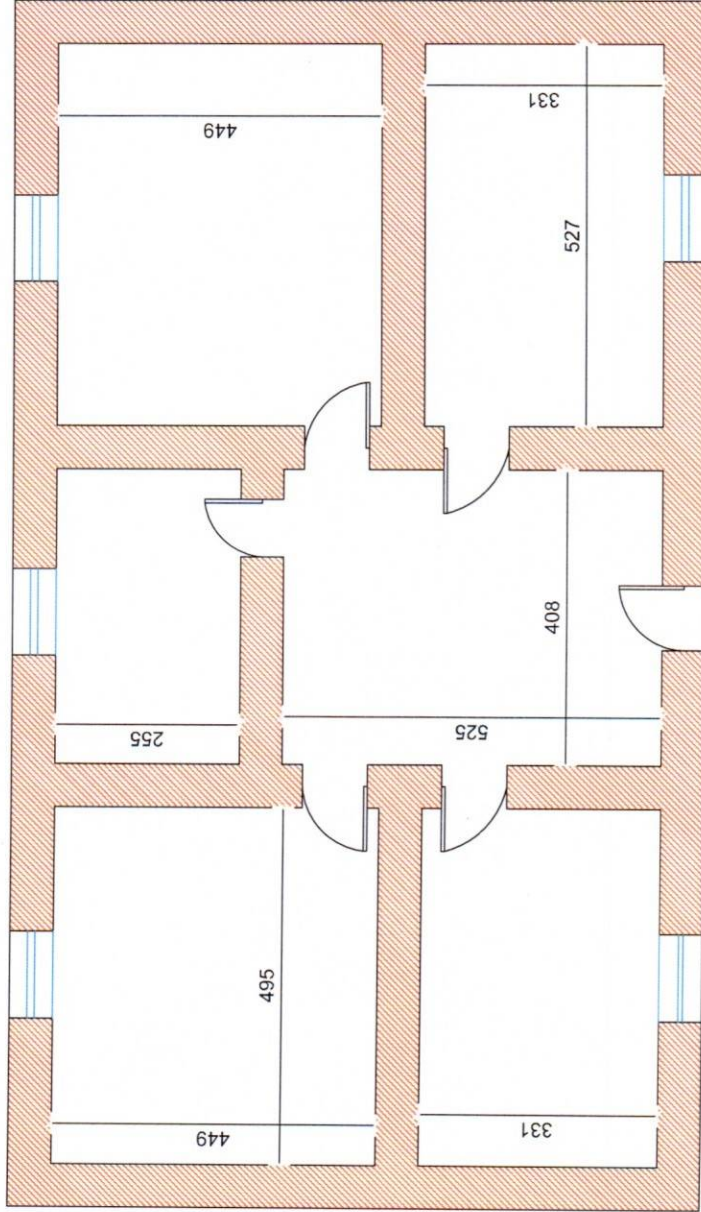

960

BASHKIA LIBRACHIO



MIRATOHET
KRYETARI BASHKISE
MARGLEN DISHA

OBJEKTI:

Permiresimi i kushteve te banimit per komunitet e varfera dhe te paforizuara

PUNOI:

Enri GJURA

PLANVENDOSJE

Per objektin "A" ndertese ne pronesi te Z.Hekuran Gjini
Nr. 23 Pasurie, ZK. 2477
Fshati Lllange, Njesia Administrative Stebleve, Bashkia Librazhd

SH 1:1000



MIRATOI
KRYETARI I BASHKISE
MARI GLEN DISHA

OBJEKTI "A" NE PLANVENDOSJE

KONFIRMOI:
ADMINISTRATORI I NJESISE ADMINISTRATIVE
Stebleve
Albert Kalceci

PERGATITI
ZYRA E PROJEKTEVE

PLANIMETRIA E BANESES SE Z.ASLLAN GJOKOLA, FSHATI ZDRAJSH VERRI,
NJ.AD.ORENJE,BASHKIA LIBRAZH

SH 1:100

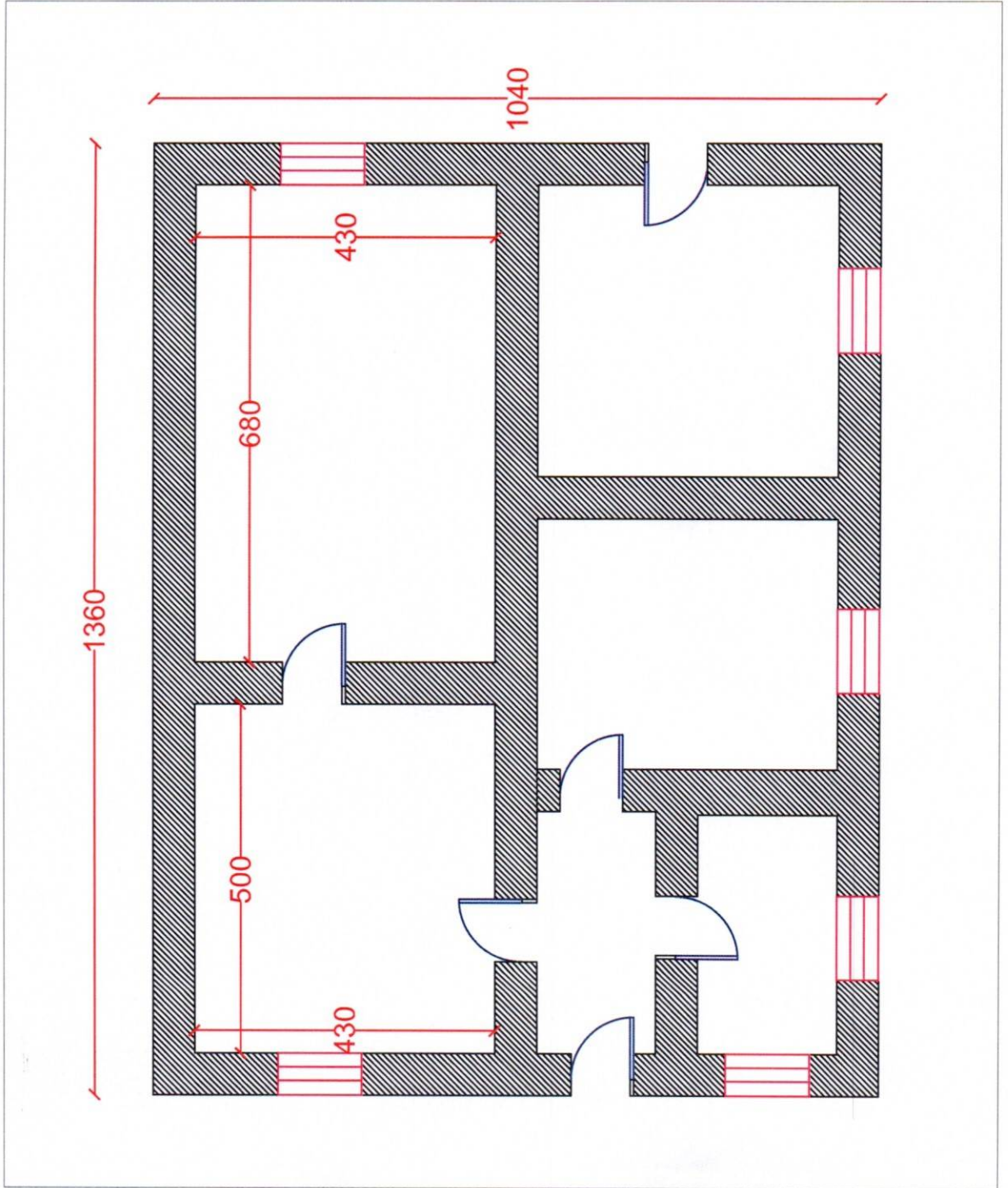

MIRATOI
KRYETARI I BASHKISE
MARI GLEN DISHA

GRUPI I PUNES:

- 1.XHEMAL BOZHIQI
- 2.SADI DOKA
- 3.ZYDI DUKA

PLANVENDOSJE

Per objektin "A" ndertese ne pronesi te Z.Asllan Gjokola
Nr. 204/7 Pasurie, ZK. 3900
Fshati Zdrajsh Verri , Njesia Administrative Orenje , Bashkia Librazhd

MIRATOI
KRYETARI I BASHKISE
MARIGLEN DISHA

SH 1:1000



OBJEKTI "A" NE PLANVENDOS.

KONFIRMOI:
ADMINISTRATORI I NJESISE ADMINISTRATIVE
ORENJE
ZYDI DUKA

PERGATITI
ZYRA E PROJEKTEVE

PLANIMETRIA E BANESES SE Z. FATMIR, AGIM, BESIM DOKA, FSHATI
GURAKUQ, NJ.AD.ORENJE,BASHKIA LIBRAZHID

SH 1:100

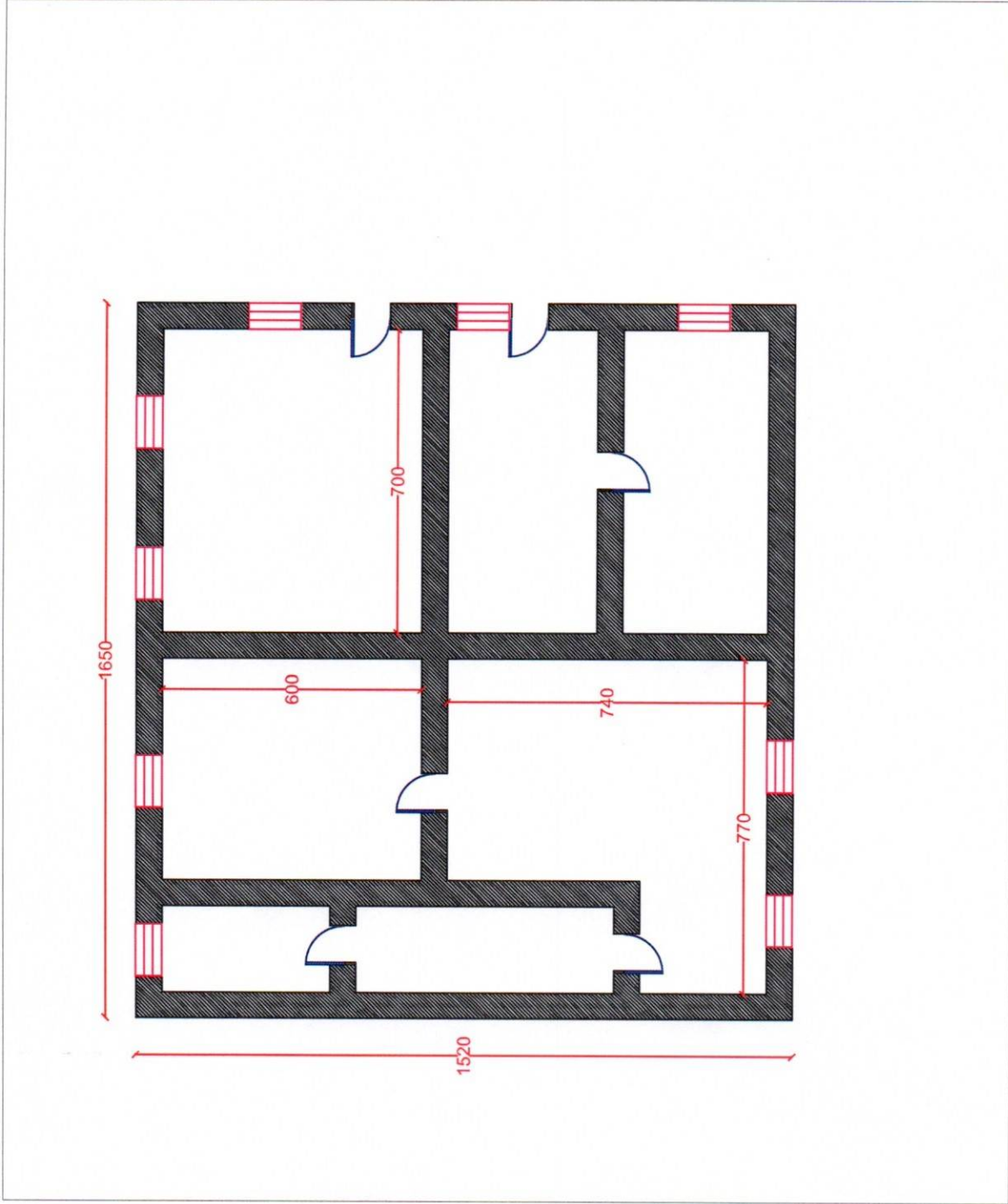

MIRATOI
KRYETARI I BASHKISE
MARIGLEN DISHA

GRUPI I PUNES:

- 1.XHEMAL BOZHIQI
- 2.DORIAN HASULA
- 3.SADI DOKA

PLANVENDOSJE

Per objektin "A" ndertese ne pronesi te Z. Agim Doka, Besim Doka, Fatmir Doka
Nr.593 Pasurie, ZK. 1887
Fshati Gurakuq , Njesia Administrative Orenje, Bashkia Librazhd

MIRATOI
KRYETARI I BASHKISE
MARGLEN DISHA

SH 1:1000

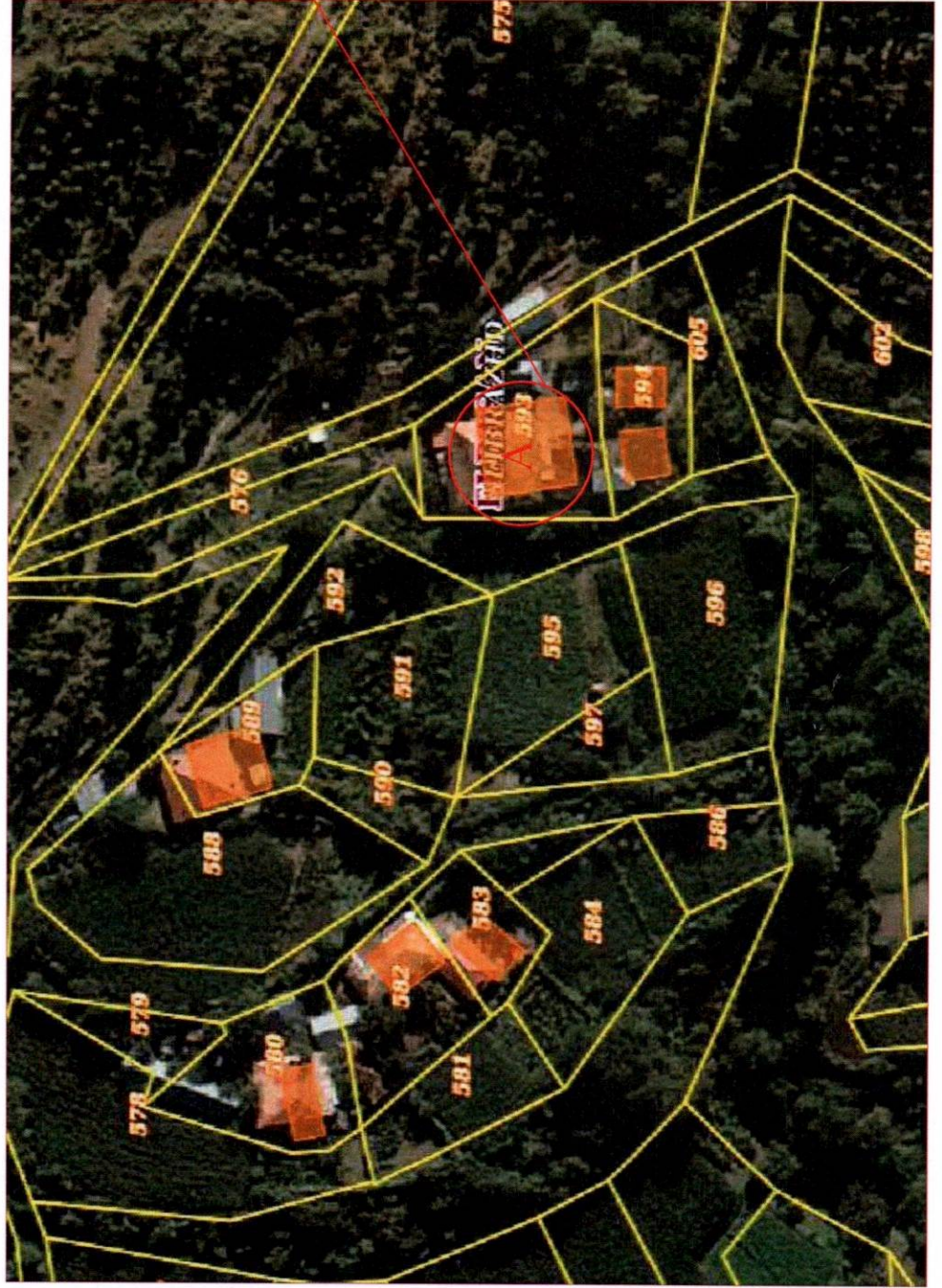

OBJEKTI "A" NE PLANVENDOSJE

KONFIRMOI:
ADMINISTRATORI I NJESISE ADMINISTRATIVE
ORENJE
ZYDI DUKA

PERGATITI
ZYRA E PROJEKTEVE

PLANIMETRIA E BANESES SE ZNJ.HATIXHE COTA, FSHATI FUNARES,
NJ.AD.ORENJE,BASHKIA LIBRAZH

SH 1:100

MIRATOI
KRYETARI I BASHKISE
MARI GLEN DISHA

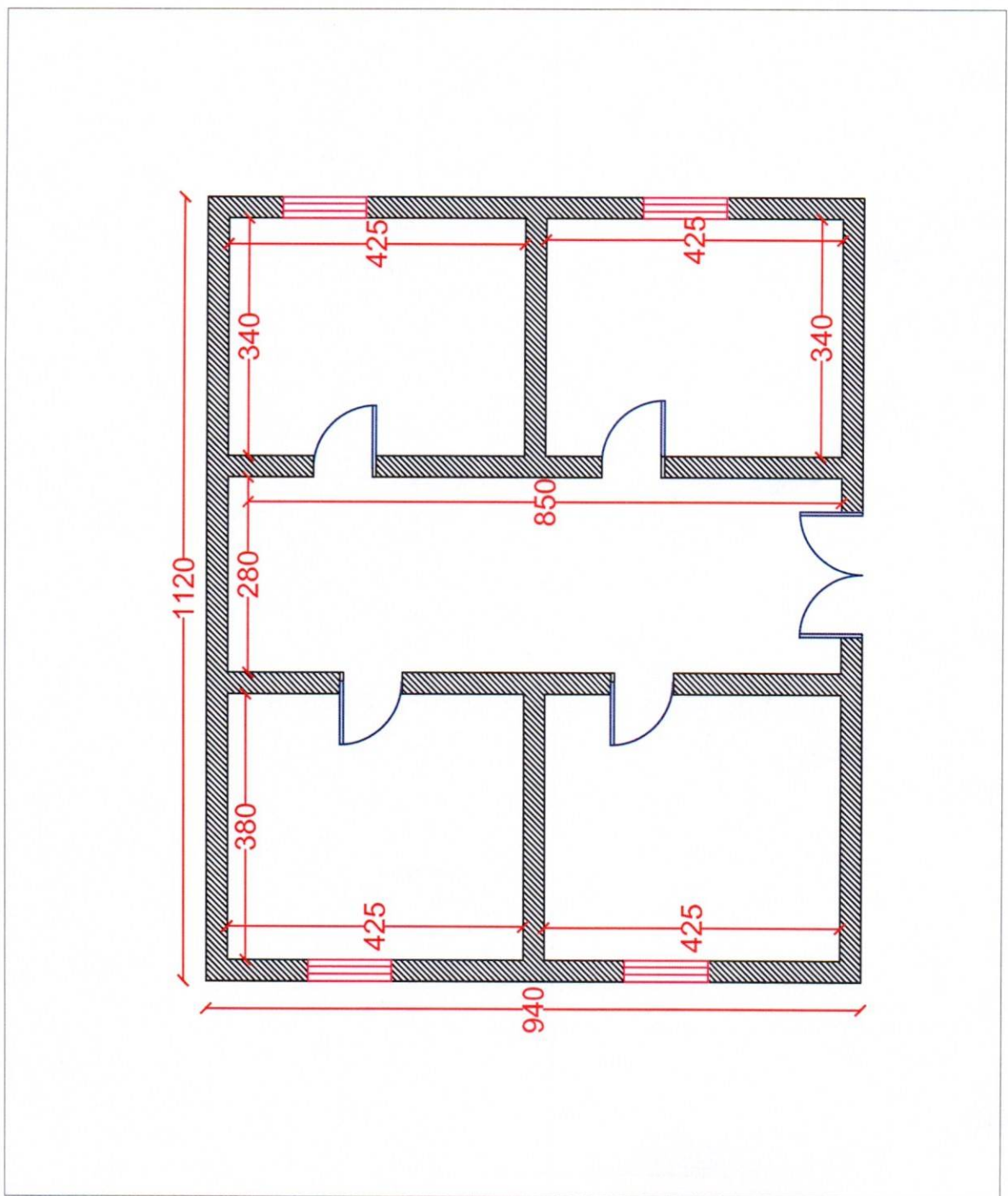

GRUPI I PUNES:

- 1.XHEMAL BOZHIQI
- 2.SADI DOKA
- 3.DORIAN HASULA

PLANVENDOSJE

Per objektin "A" ndertese ne pronesi te Znj.Hatixhe Çota
Nr. 282/1 Pasurie, ZK. 1662
Fshati Funares , Njesia Administrative Orenje, Bashkia Librazhd

MIRATOI
KRYETARI I BASHKISE
MARGLEN DISHA

SH 1:1000

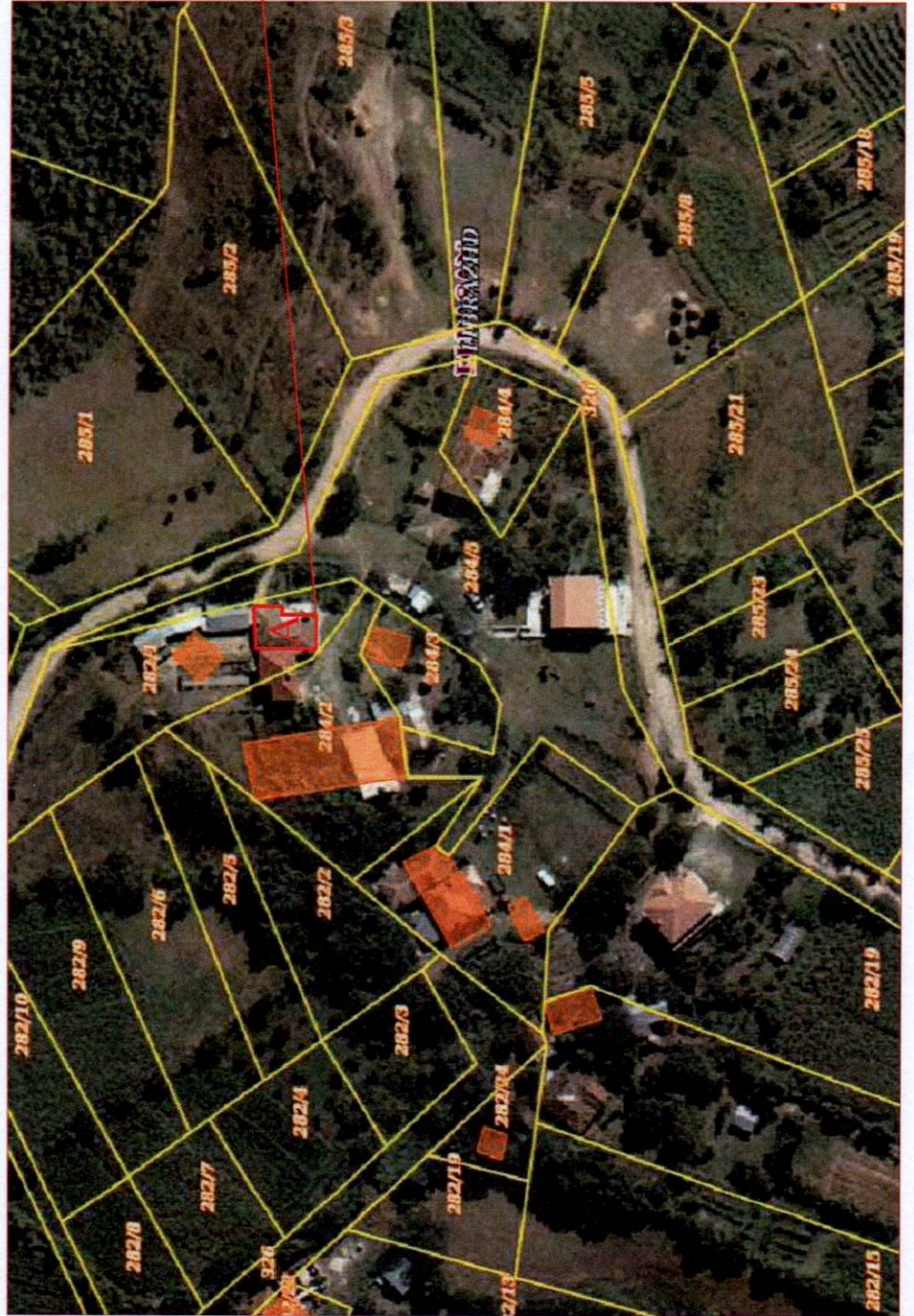

OBJEKTI "A" NE PLANVENDOSJE

KONFIRMOI:
ADMINISTRATORI I NJESISE ADMINISTRATIVE
ORENJE
ZYDI DUKA

PERGATITI
ZYRA E PROJEKTEVE

PLANIMETRIA E BANESES SE Z.JERI ALLUSHI, FSHATI ZDRAJSH KATUND,
NJ.AD.ORENJE,BASHKIA LIBRAZH

SH 1:100

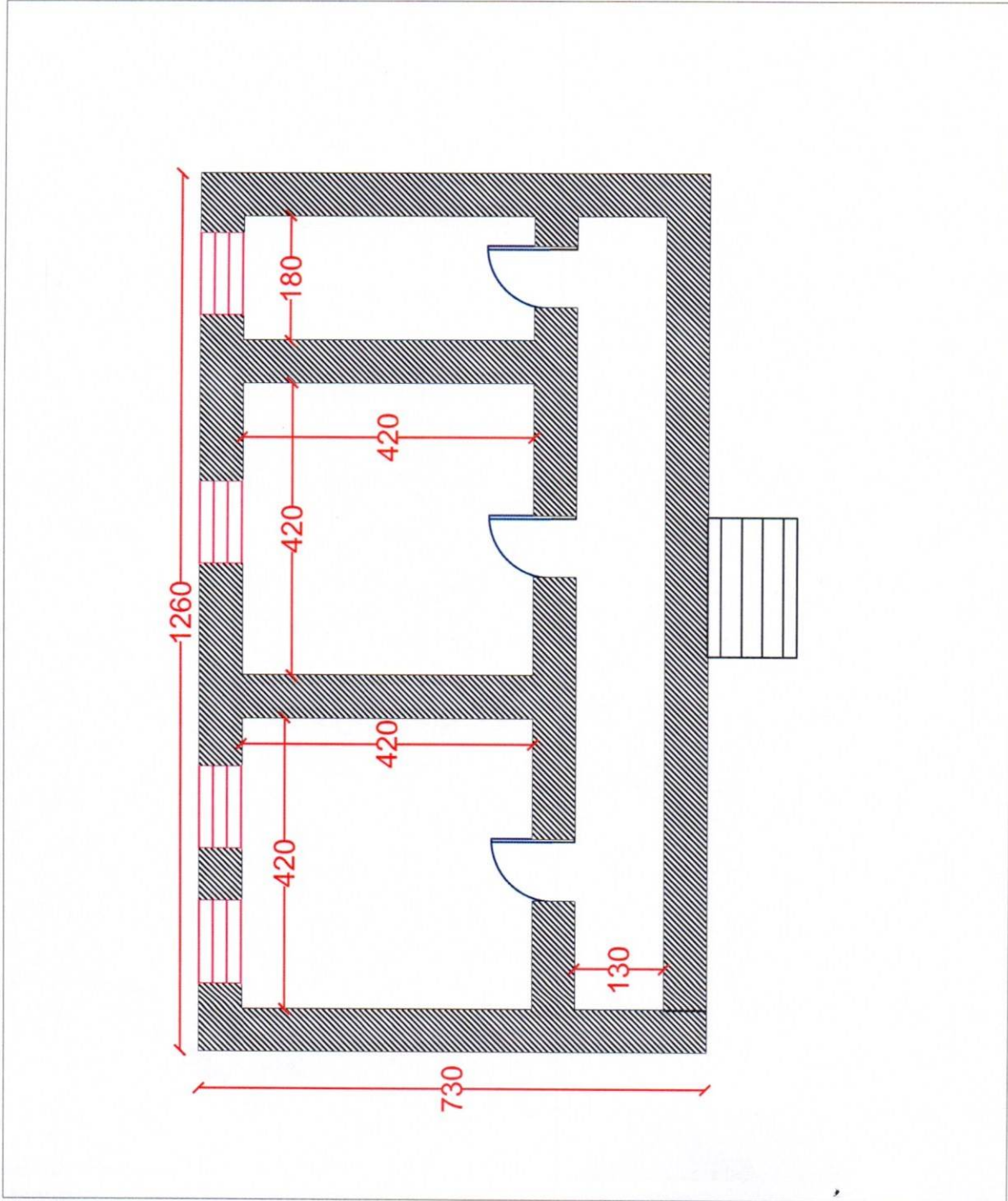

MIRATOI
KRYETARI I BASHKISE
MARI GLEN DISHA

GRUPI I PUNES:

- 1.XHEMAL BOZHIQI
- 2.SADI DOKA
- 3.DORIAN HASULA

PLANVENDOSJE

Per objektin "A" ndertese ne pronesi te Z.Jeri Allushi
Nr. 130/2 Pasurie, ZK. 3899
Fshati Zdrajsh Katund , Njesia Administrative Orenje , Bashkia Librazhd

MIRATOI
KRYETARI I BASHKISE
MARGLEN DISHA

SH 1:1000

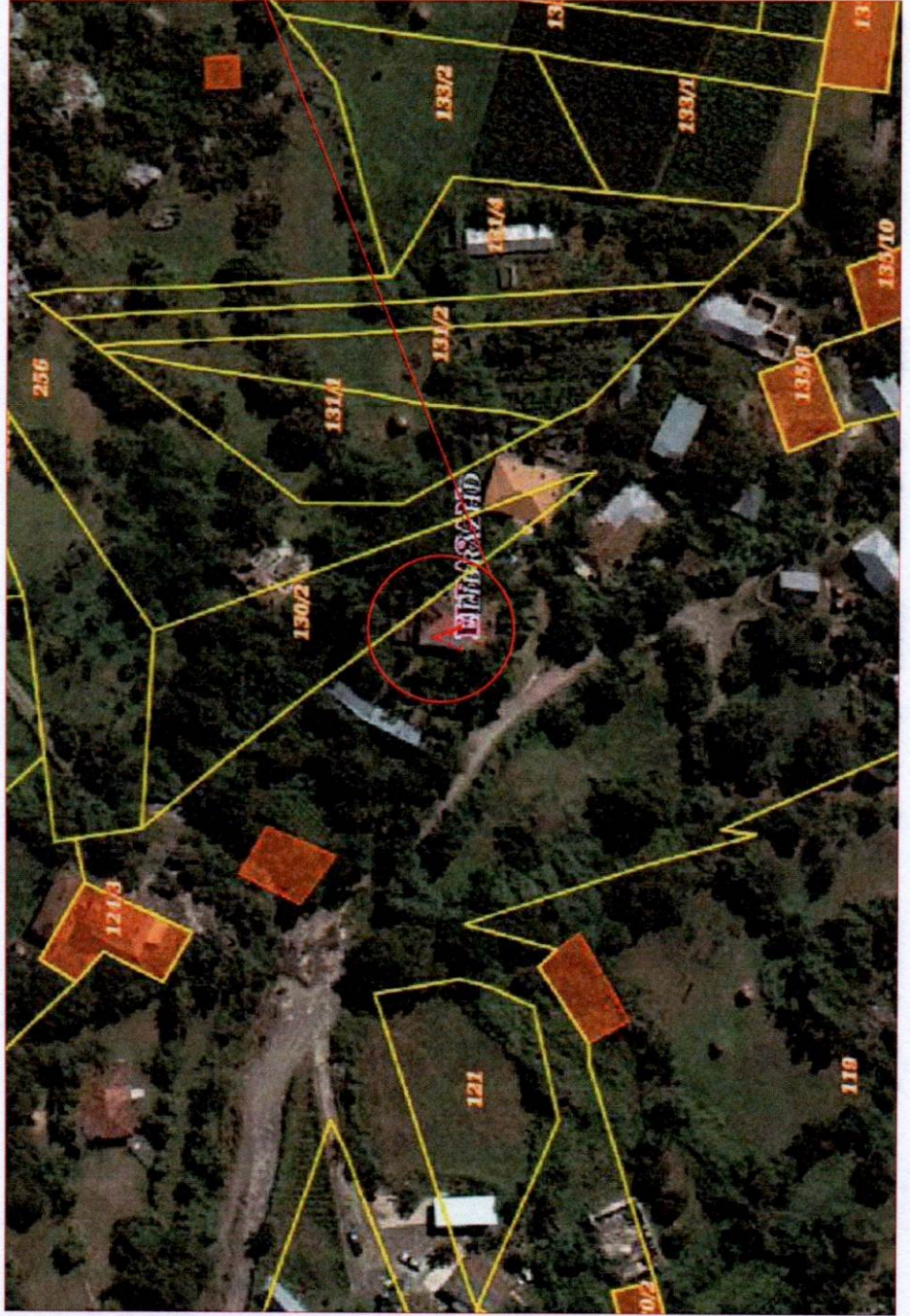

OBJEKTI "A" NE PLANVENDOSJE

KONFIRMOI:
ADMINISTRATORI I NJESISE ADMINISTRATIVE
ORENJE
ZYDI DUKA

PERGATITI
ZYRA E PROJEKTEVE

PLANIMETRIA E BANESES SE Z.KUJTIM HASKURTI, FSHATI ZDRAJSH VERRI,
NJ.AD.ORENJE,BASHKIA LIBRAZH

SH 1:100

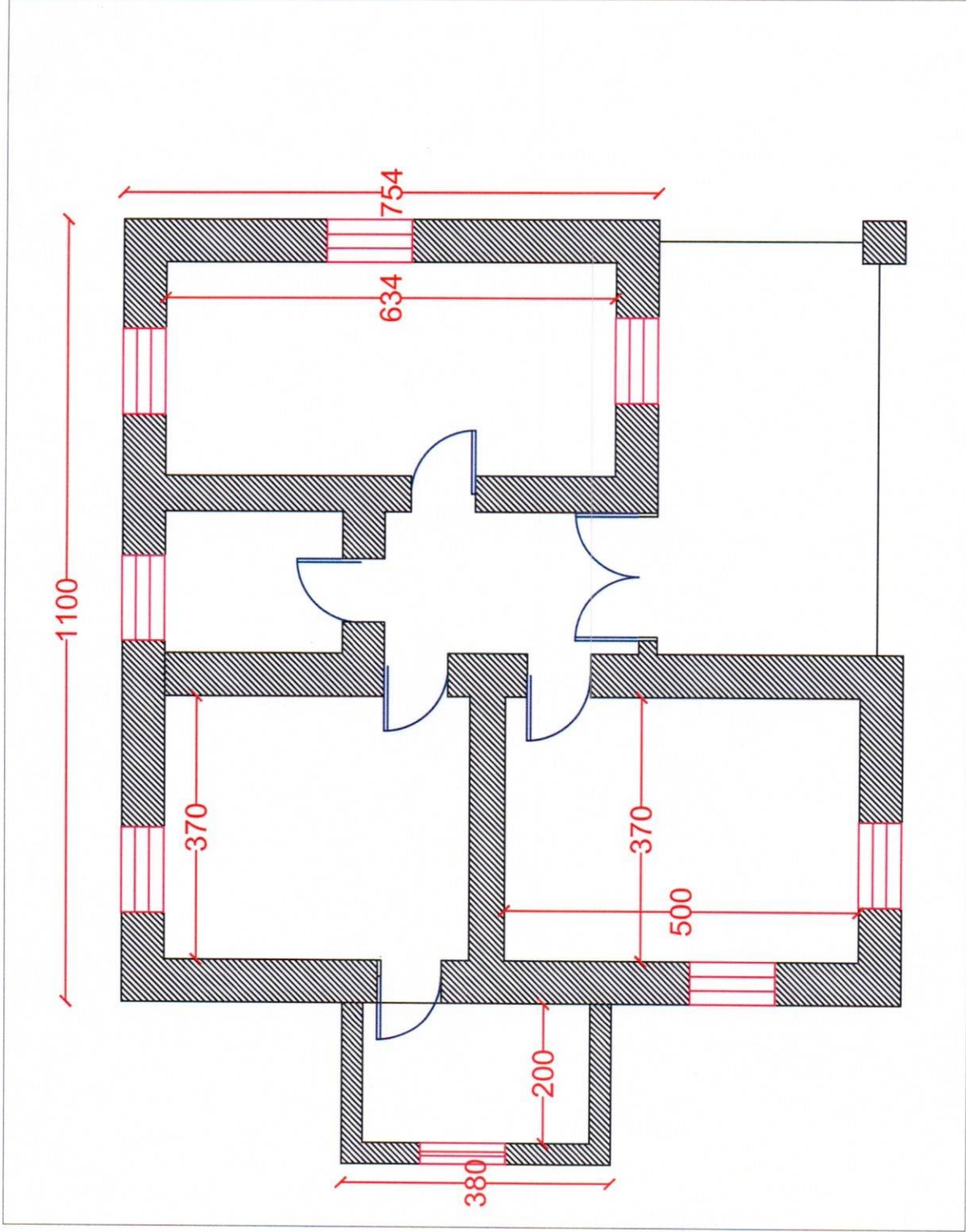

MIRATOI

KRYETARI I BASHKISE
MARGLEN DISHA

GRUPI I PUNES:

- 1.XHEMAL BOZHIQI
- 2.SADI DOKA
- 3.ZYDI DUKA

PLANVENDOSJE

Per objektin "A" ndertese ne pronesi te Z.Kujtim Haskurti
Nr. 159/17 Pasurie, ZK. 3900
Fshati Zdrajsh Verri , Njesia Administrative Orenje , Bashkia Librazhd

MIRATOI
KRYETARI I BASHKISE
MARGLEN DISHA

SH 1:1000



OBJEKTI "A" NE PLANVENDOSJE

KONFIRMOI:
ADMINISTRATORI I NJESISE ADMINISTRATIVE
ORENJE
ZYDI DUKA

PERGATITI
ZYRA E PROJEKTEVE

PLANIMETRIA E BANESES SE ZNJ.NASIPE LEKA, FSHATI ZDRAJSH KATUND,
NJ.AD.ORENJE,BASHKIA LIBRAZH

SH 1:100

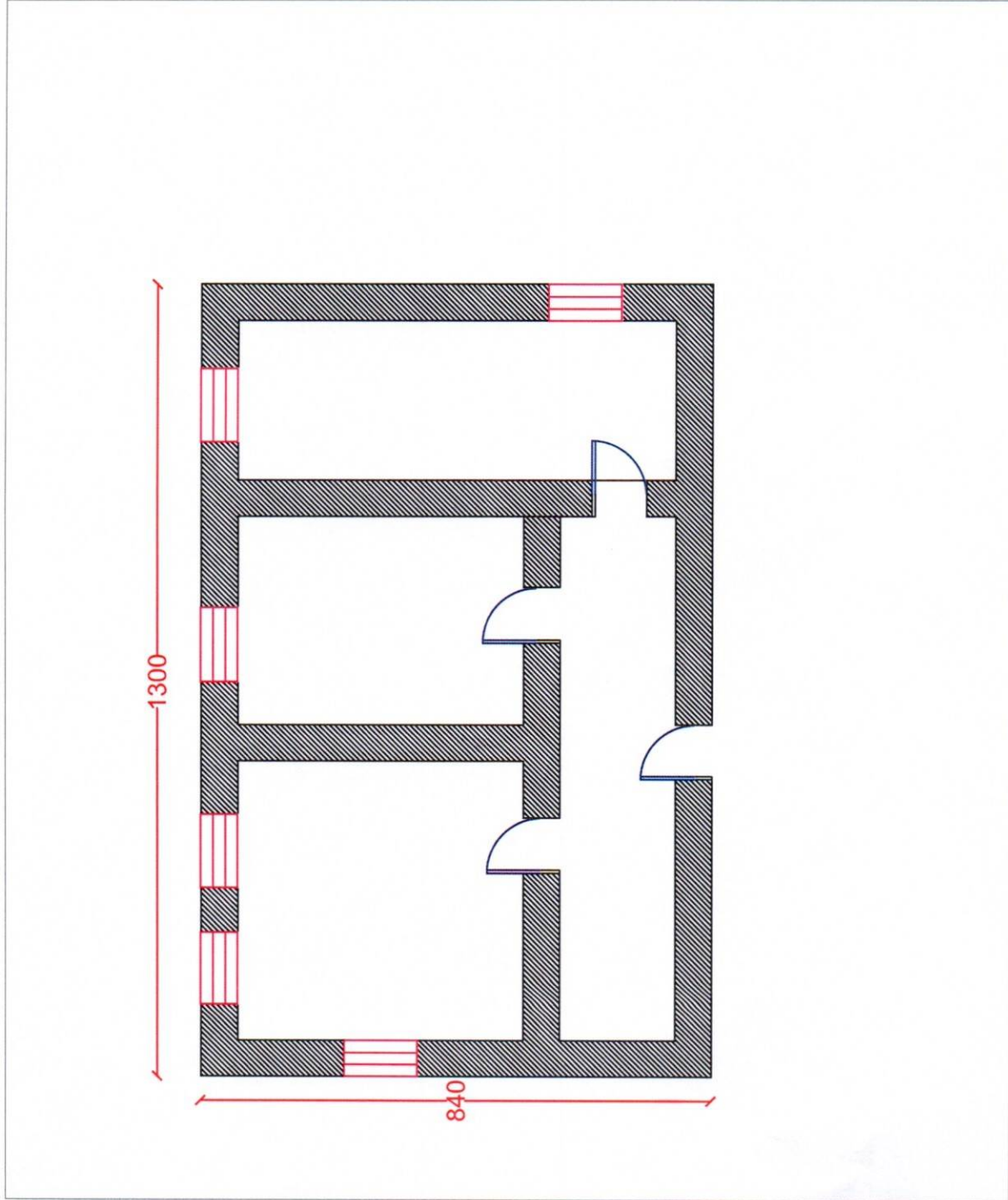

MIRATOI
KRYETARI I BASHKISE
MARGLEN DISHA

GRUPI IPUNES:

- 1.XHEMAL BOZHIQI
- 2.DORIAN HASULA
- 3.SADI DOKA

PLANVENDOSJE

Per objektin "A" ndertese ne pronesi te Znj.Nasipe Leka
Nr. 139/10 Pasurie, ZK. 3899
Fshati Zdrajsh Katund, Njesia Administrative Orenje, Bashkia Librazhd

SH 1:1000

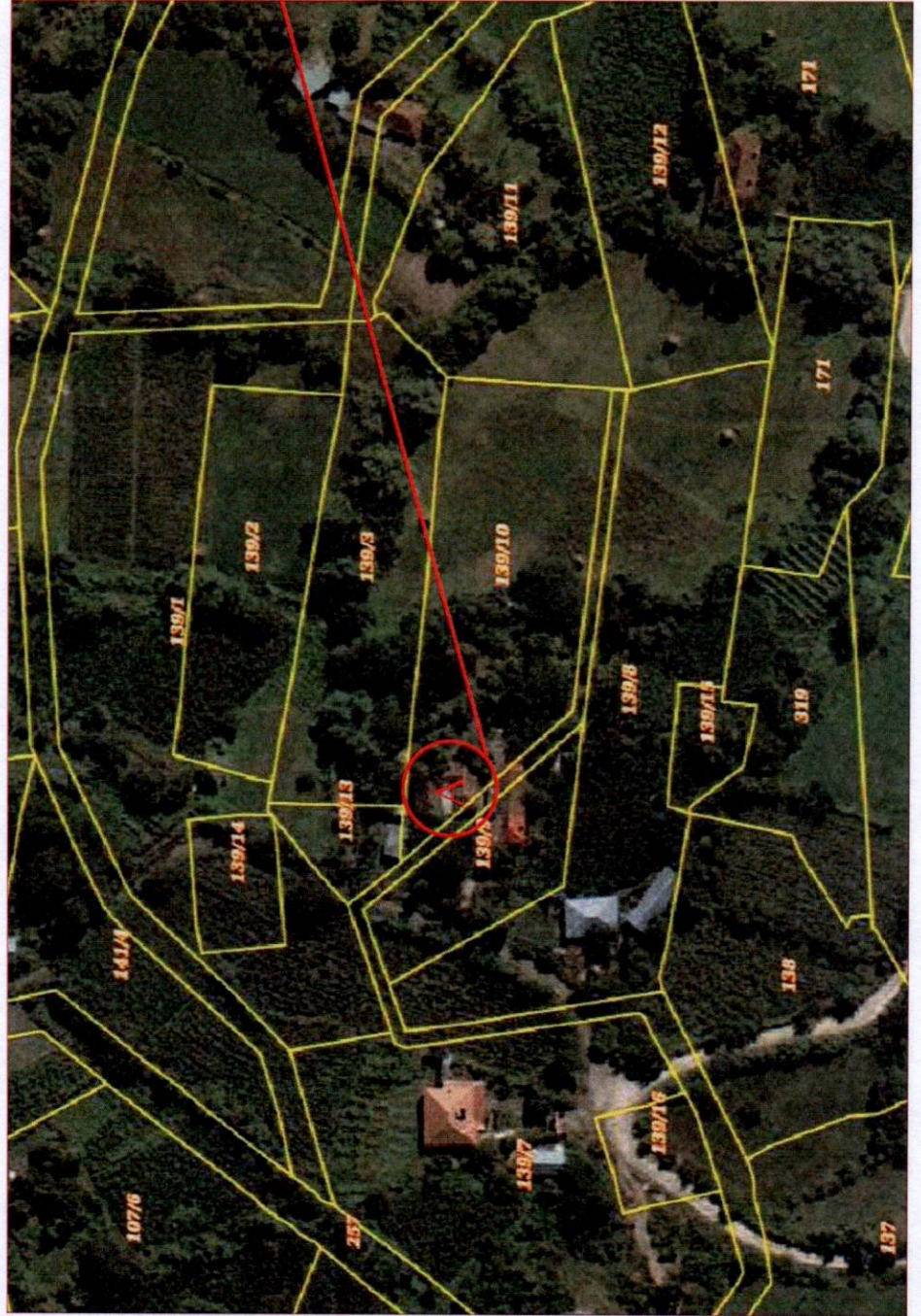

OBJEKTI "A" NE PLANVENDOSJE

KONFIRMOI:
ADMINISTRATORI I NJEISE ADMINISTRATIVE
Orenje
Zydi Doka

PERGATITI
ZYRA E PROJEKTEVE

Planimetri e shtëpise
Z. Hyqmet Isaku
Fshati Neshte, Nj.A.Drenje

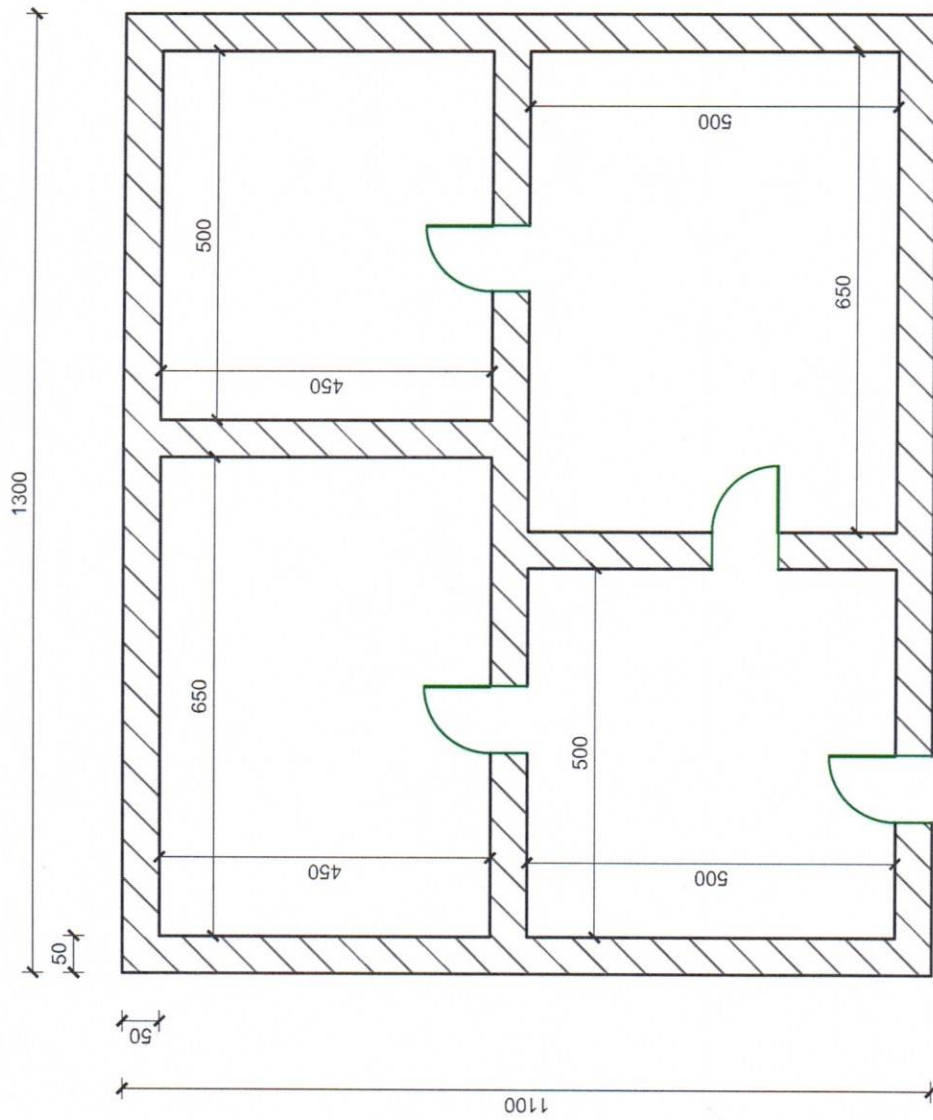

Objekti:

Permiresimi i kushteve te banimit per komunitetet e varfera dhe te pafavorizuara

Grupi teknik i matjeve:

Ing. Xhemal Bozhichi Dorian Hasula Sadi Doka

Shkalla 1:250

PLANVENDOSJE

Per objektin "A" ndertese ne pronesi te Z.Hyqmet Isaku
Nr. 188 Pasurie, ZK. 2728
Fshati Neshte, Njesia Administrative Orenje, Bashkia Librazhd

MIRATOI
KRYETARI I BASHKISE
MARIIGLEN DISHA

SH 1:1000

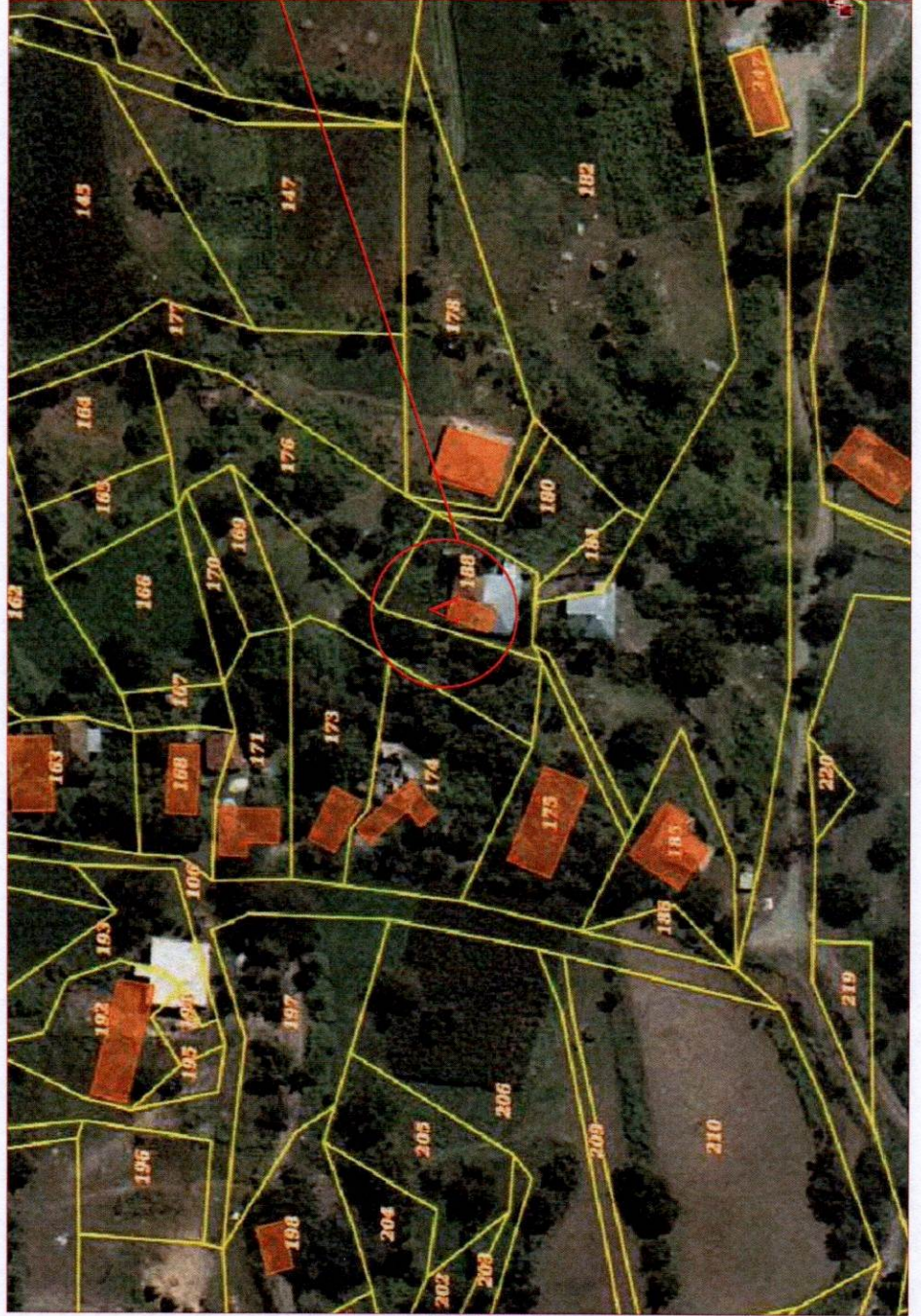

OBJEKTI "A" NE PLANVENDOSJE

KONFIRMOI:
ADMINISTRATORI I NJESISE ADMINISTRATIVE
Orenje
Zydi Duka

PERGATITI
ZYRA E PROJEKTEVE

PLANIMETRIA E BANESES SE ZNJ.ZENEPE MJESHTRI, FSHATI ZDRAJSH
KATUND, NJ.AD.ORENJE,BASHKIA LIBRAZH

SH 1:100

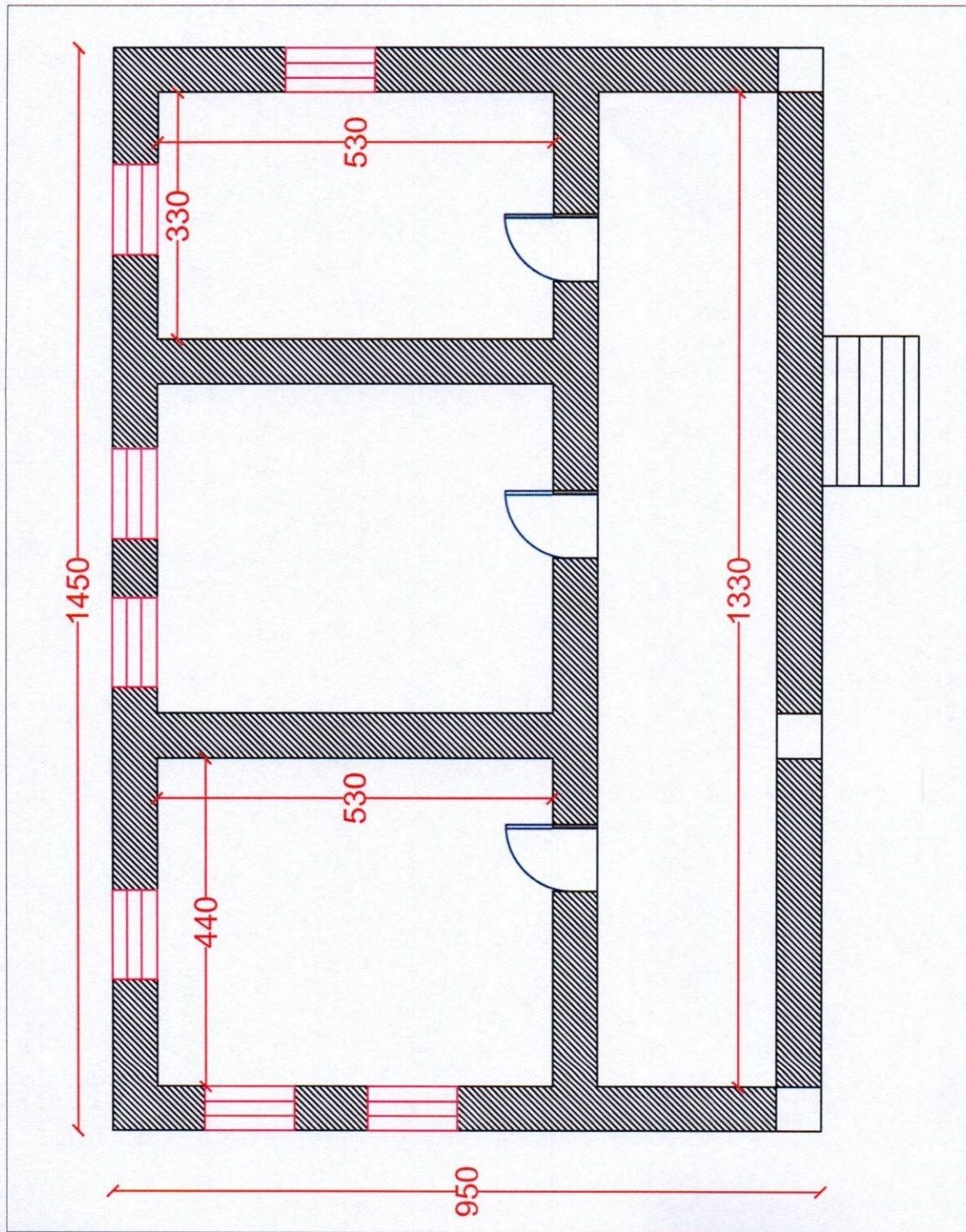

MIRATOI
KRYETARI I BASHKISE
MARGLEN DISHA

GRUPI PUNES:

- 1.XHEMAL BOZHIQI
- 2.SADI DOKA
- 3.ZYDI DUKA

PLANIMETRIA E BANESES SE Z. TAHIR XHERRI, FSHATI ZDRAJSH KATUND,
NJ.AD.ORENJE,BASHKIA LIBRAZH

SH 1:100

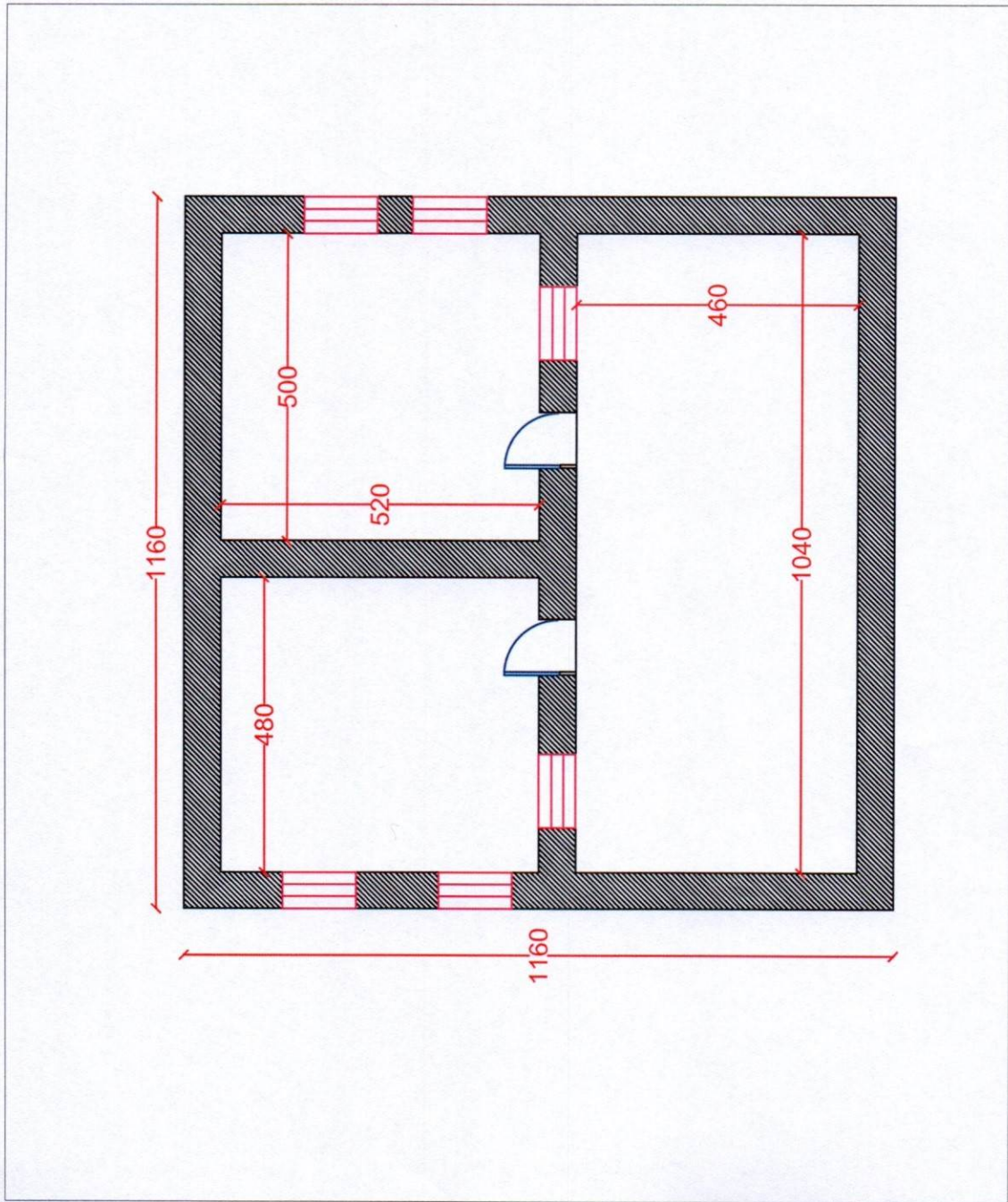

MIRATOI
KRYETARI I BASHKISE
MARIGLEN DISHA

GRUPI I PUNES:

- 1.XHEMAL BOZHIQI
- 2.DORIAN HASULA
- 3.SADI DOKA

PLANIMETRIA E BANESES SE Z. RUZHDI ALBAJRAMI, FSHATI ZDRAJSH VERRI,
NJ.AD.ORENJE,BASHKIA LIBRAZHID

SH 1:100

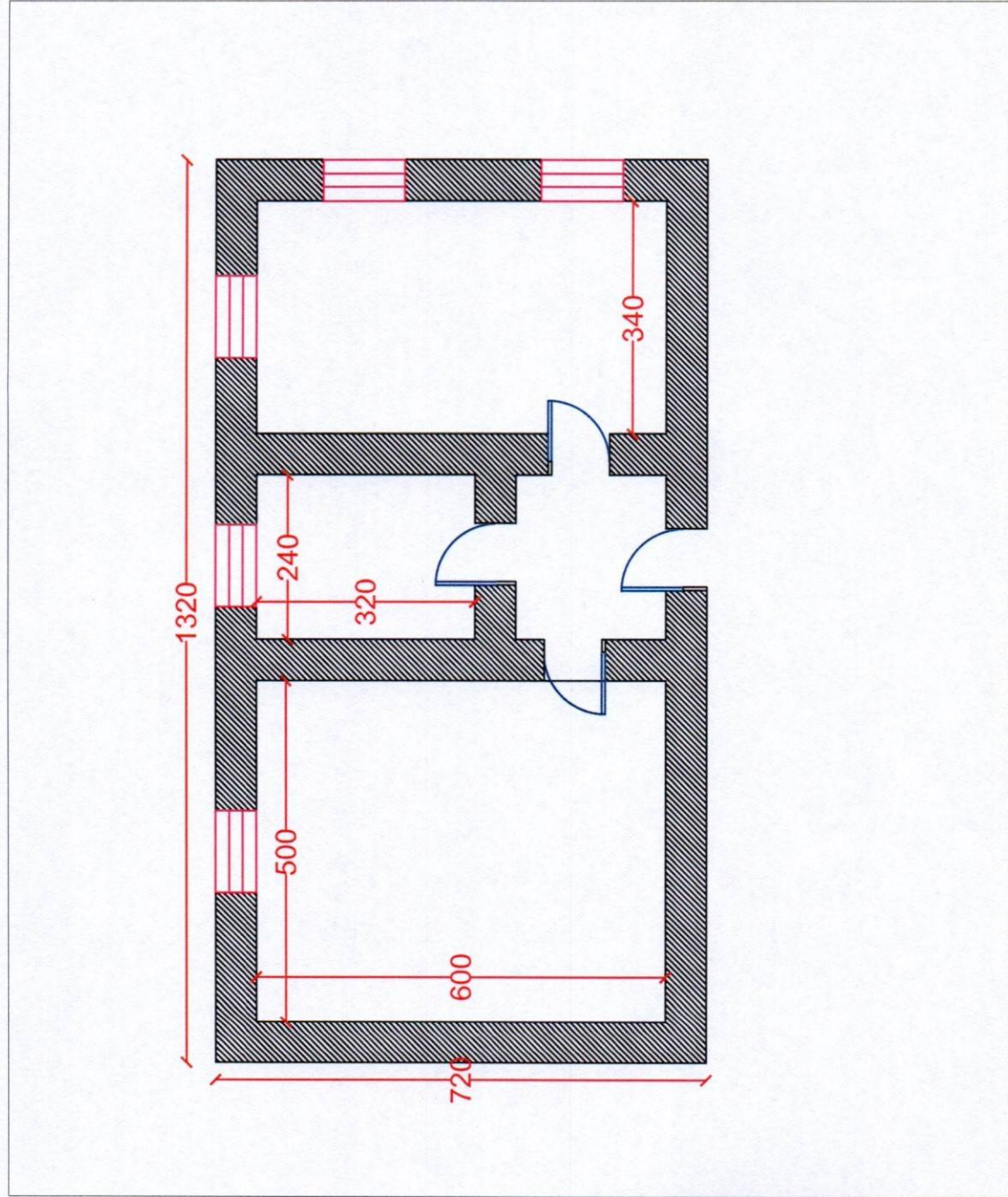

MIRATOI
KRYETARI I BASHKISE
MARGLEN DISHA

GRUPI I PUNES:

- 1.XHEMAL BOZHIQI
- 2.DORIAN HASULA
- 3.SADI DOKA

PLANIMETRIA E BANESES TE Z.XHABIR BOBOCI
 FSH FLOQ NJA.ORENJE

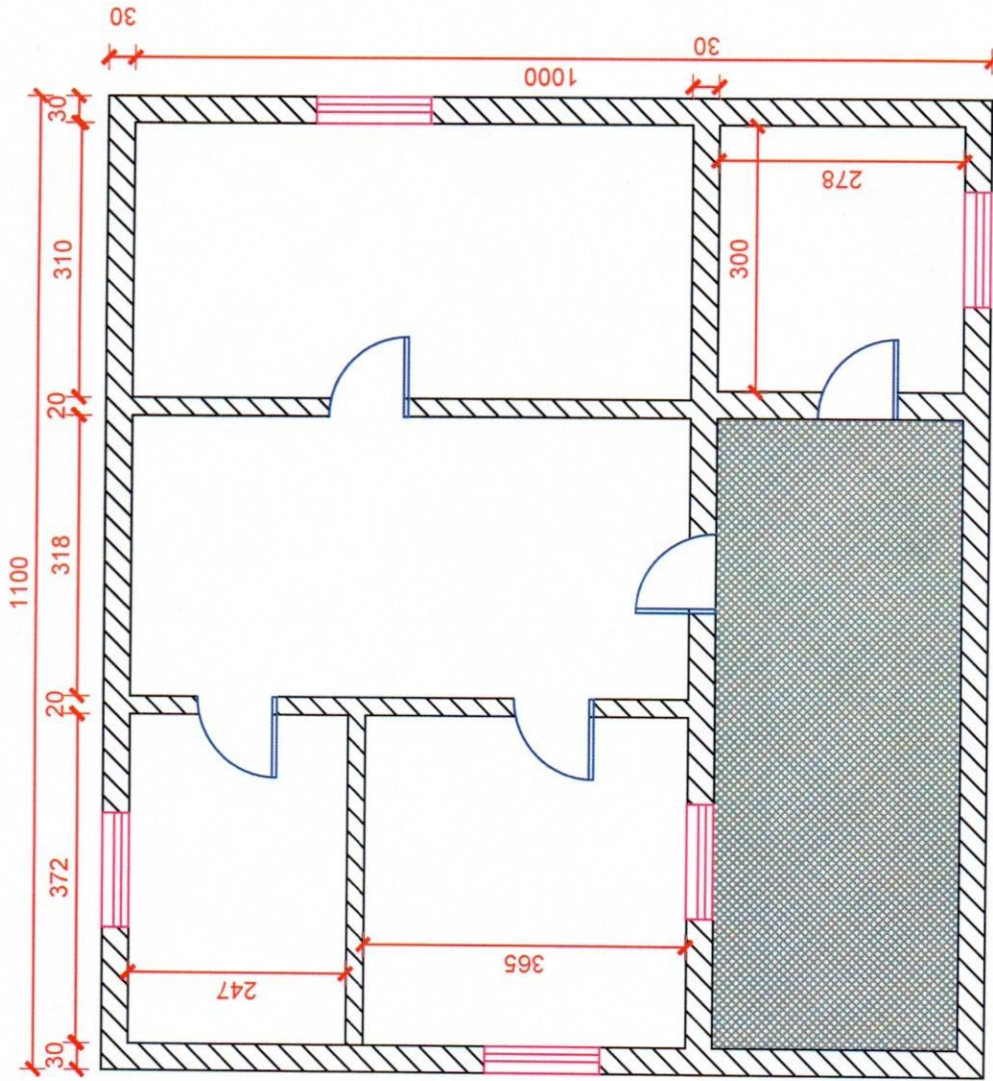

OBJEKTI:

Permirësimi i kushteve të banimit për komunitet e varfëra dhe të pafavorizuara

GRUPI TEKNIK I MATJEVE:

Ing. Aferdita KOÇI Ing. Julgerta BALLA Ing. Jurgjen MEMA

(Handwritten signatures of the technical group members)

SHKALLA 1:100

PLANIMETRIA E CATISE TE Z.XHABIR BOBOCI
FSH FLOQ NJA.ORENJE

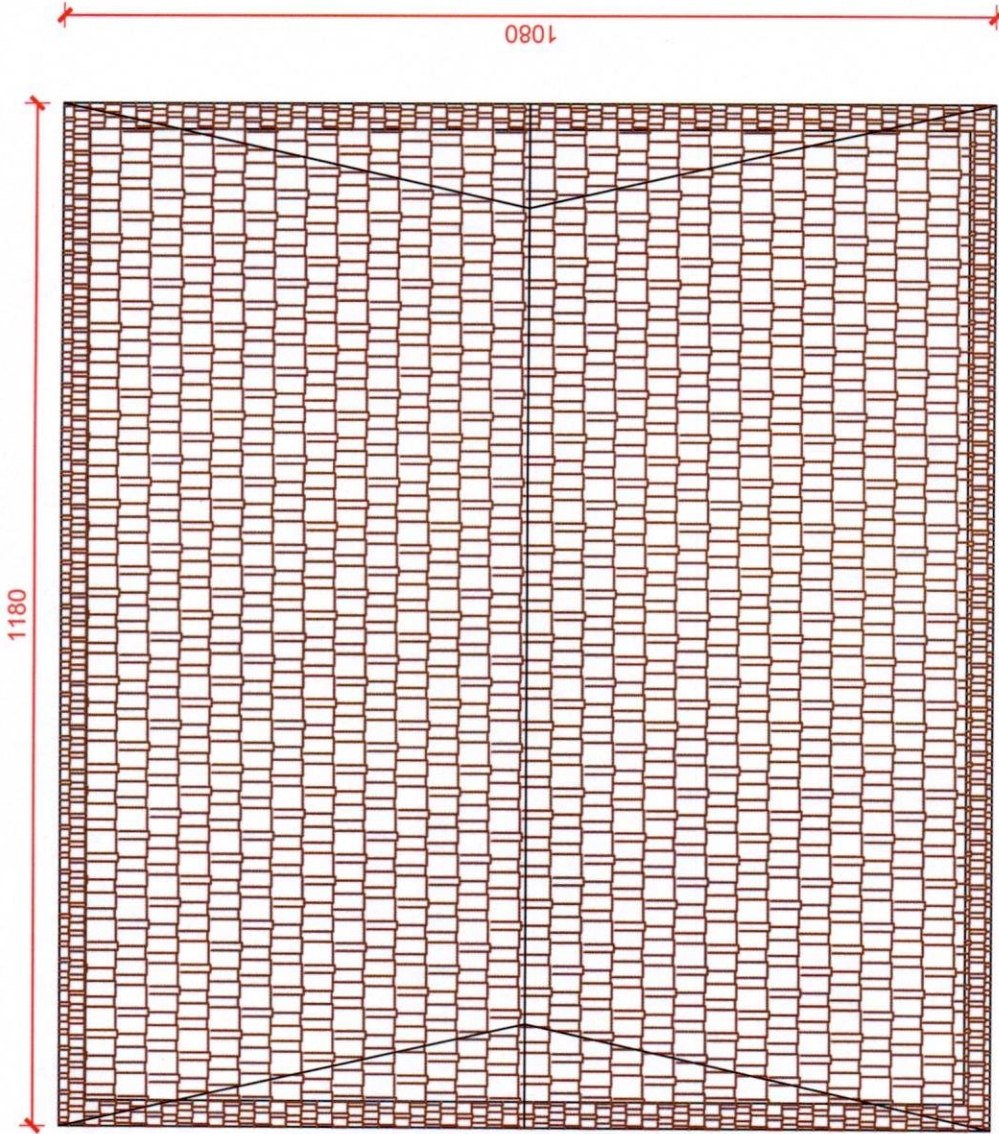

OBJEKTI:

Permiresimi i kushteve te banimit per komunitet e varfera dhe te paforizuarra

GRUPI TEKNIK I MATJEVE:

Ing.Aferdita KOÇI Ing. Julgerta BALLA Ing. Jurgjen MEMA

SHKALLA 1:100