



MIRATOHET
KRYETAR
Z.MARIGLEN DISHA

REPUBLIKA E SHQIPËRISË
BASHKIA LIBRAZH'D

PROJEKT ZBATIMI

OBJEKTI: "RIKONSTRUKSIONI I KANALIT VADITES TE ALLANIT (LOTI II-te), FSHATRAT GIZAVESH ,
DOREZ DHE LIBRAZH'D QENDER
(NJESIA ADMINISTRATIVE QENDER)
BASHKIA LIBRAZH'D



Projektues: **Zenit&Co sh.p.k**

Address: Rr. "Myrteza Topi", Nd 18, Hyrja 7, Ap 38, TIRANE
Cel: +355 (0)69 51 25 523
e-mail: zenit06@live.com

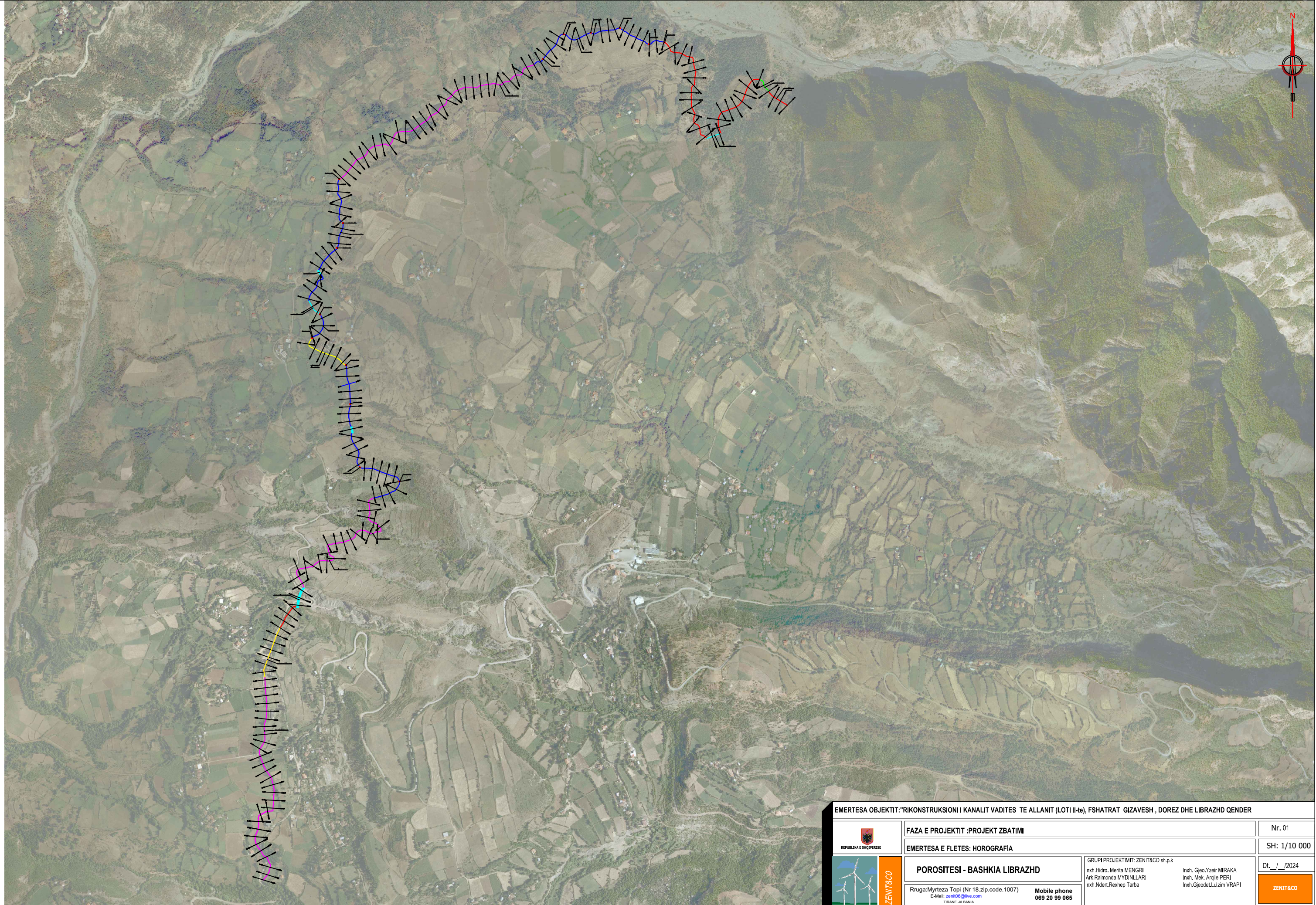

EMERTESA OBJEKTIT: "RIKONSTRUKSIONI I KANALIT VADITES TE ALLANIT (LOTI II-te), FSHATRAT GIZAVESH , DOREZ DHE LIBRAZHD QENDER			
 REPUBLIKA E SHQIPERISE	FAZA E PROJEKTIT : PROJEKT ZBATIMI	Nr. 01	
	EMERTESA E FLETES: HOROGRAFIA	SH: 1/10 000	
 ZENIT&CO	POROSITESI - BASHKIA LIBRAZHD	GRUPI PROJEKTIMIT: ZENIT&CO sh.p.k	DT. _/ _/2024
	Rruga: Myrteza Topi (Nr 18.zip.code.1007) E-Mail: zenit06@live.com TIRANE-ALBANIA	Mobile phone 069 20 99 065	Inxh. Hidro. Merita MENGRI Ark. Raimonda MYDINLLARI Inxh. Nderi Rexhep Tarba

PLANIMETRIA SH 1:1000

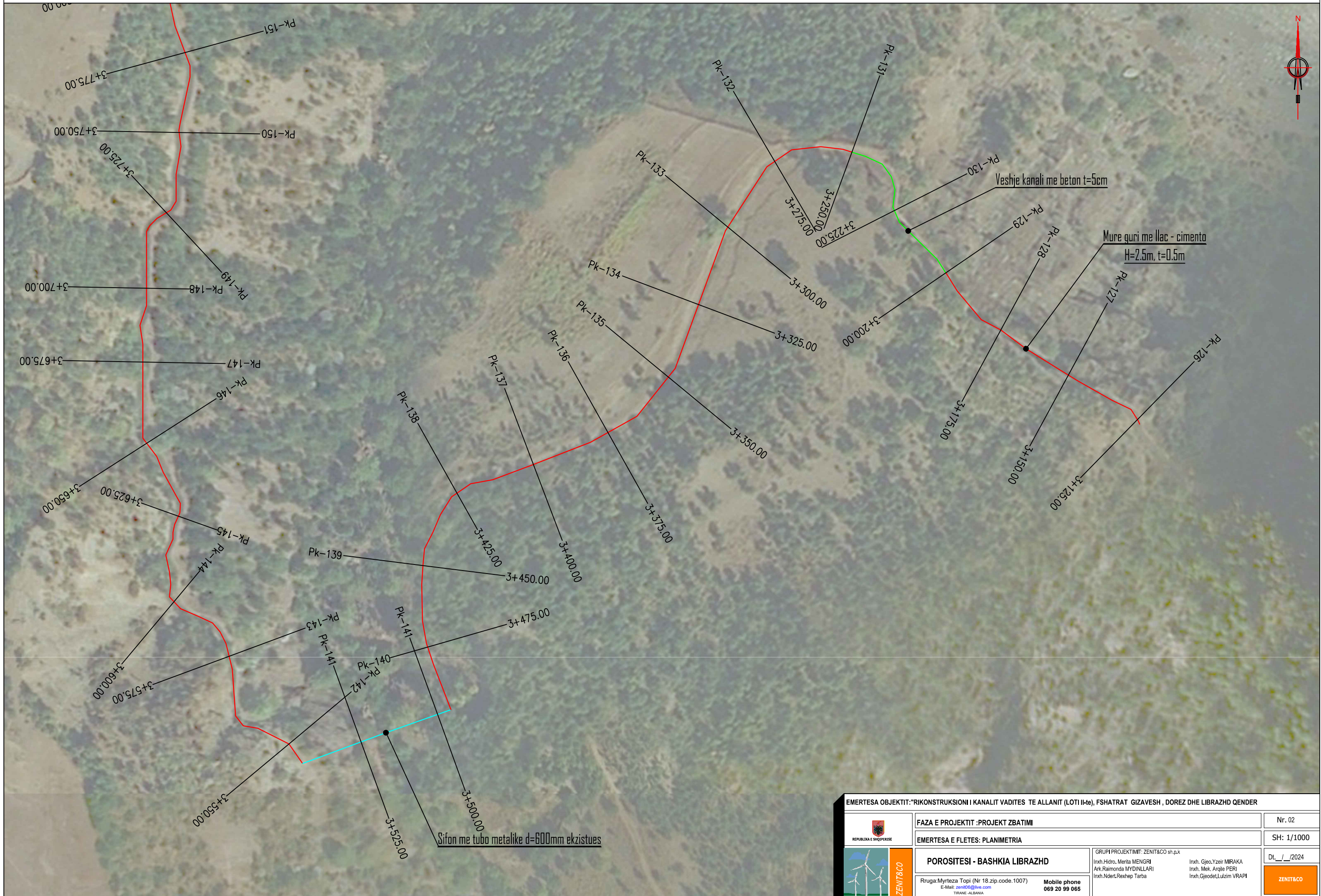

EMERTESA OBJEKTIT: "RIKONSTRUKSIONI I KANALIT VADITES TE ALLANIT (LOTI II-te), FSHATRAT GIZAVESH , DOREZ DHE LIBRAZHD QENDER				
 REPUBLIKA E SHQIPERISE	FAZA E PROJEKTIT :PROJEKT ZBATIMI	Nr. 02		
	EMERTESA E FLETES: PLANIMETRIA	SH: 1/1000		
 GRUPI PROJEKTIMIT: ZENIT&CO sh.p.k Inxh. Hidro. Merita MENGRI Ark. Raimonda MYDINLLARI Inxh. Nderi Rexhep Tarba	POROSITESI - BASHKIA LIBRAZHD	Inxh. Gjeo. Yzeir MIRAKA	Inxh. Mek. Arqje PERI	
	Rruga: Myrteza Topi (Nr 18.zip.code.1007) E-Mail: zenit06@live.com TIRANE - ALBANIA	Mobile phone 069 20 99 065	Dt. _/ _/2024 ZENIT&CO	

PLANIMETRIA SH 1:1000



600mm

EMERTESA OBJEKTIT: "RIKONSTRUKSIONI I KANALIT VADITES TE ALLANIT (LOTI II-te), FSHATRAT GIZAVESH, DOREZ DHE LIBRAZHD QENDER				
 REPUBLIKA E SHQIPERISE	FAZA E PROJEKTIT : PROJEKT ZBATIMI	Nr. 03		
	EMERTESA E FLETES: PLANIMETRIA	SH: 1/1000		
 ZENIT&CO	POROSITESI - BASHKIA LIBRAZHD	GRUPI PROJEKTIMIT: ZENIT&CO sh.p.k		
	Rruga: Myrteza Topi (Nr 18.zip.code.1007) E-Mail: zenit06@live.com TIRANE-ALBANIA	Mobile phone 069 20 99 065	Inzh.Hidro. Merita MENGRI Ark.Raimonda MYDINLLARI Inzh.Ndert.Rexhep Tarba	Inzh. Gjeo.Yzeir MIRAKA Inzh. Mek. Arqije PERI Inzh.Gjeodet.Lulzim VRAPI
			DT. _/ _/ 2024	ZENIT&CO

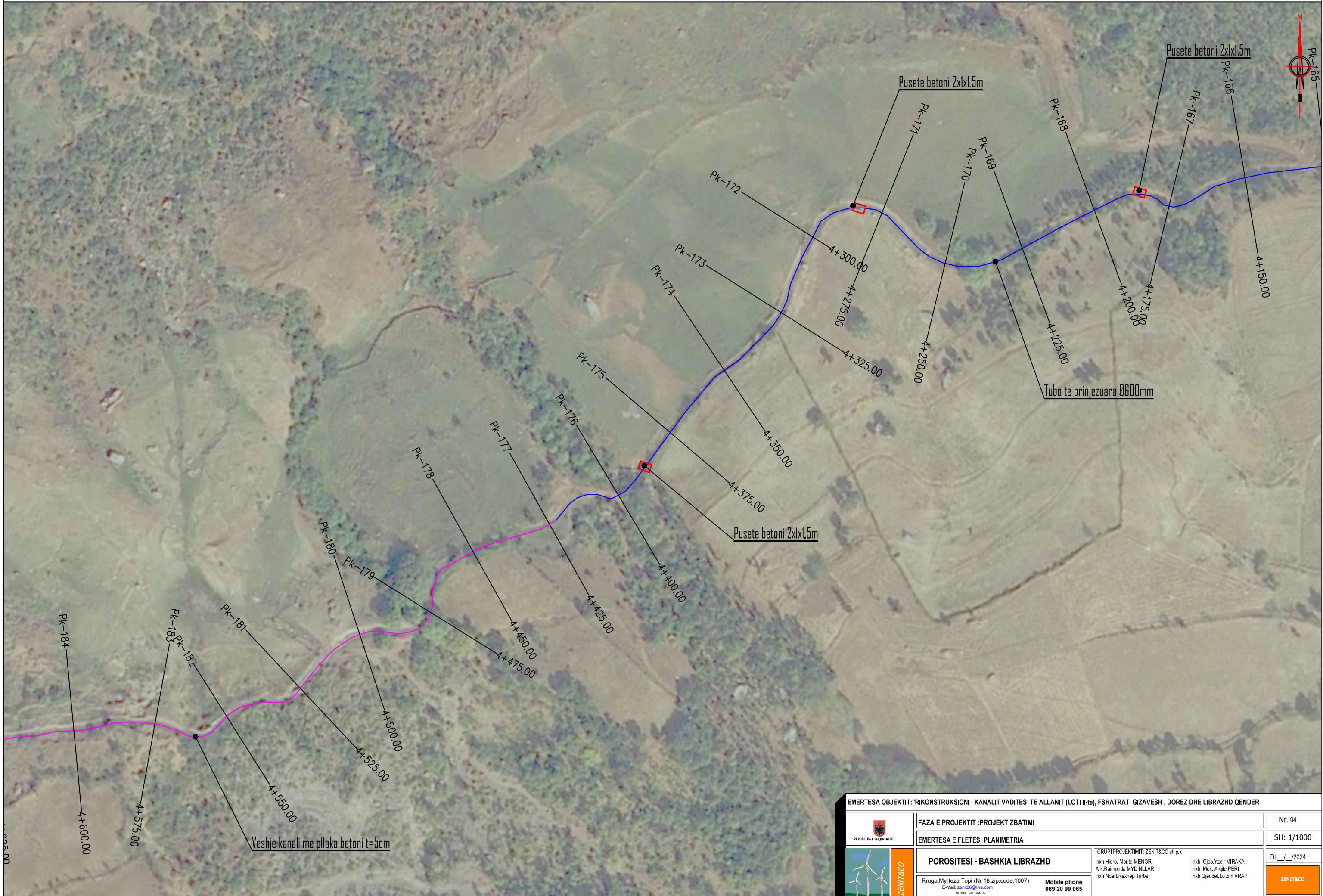

EMERTESA OBJEKTIT: "RIKONSTRUKSIONI I KANALIT VADITES TE ALLANIT (LOTI II-te), FSHATRAT GIZAVESH, DOREZ DHE LIBRAZHD QENDER			
 REPUBLIKA E SHQIPERISE		FAZA E PROJEKTIT : PROJEKT ZBATIMI	Nr. 04
 ZENIT&CO		EMERTESA E FLETES: PLANIMETRIA	SH: 1/1000
POROSITESI - BASHKIA LIBRAZHD		GRUPI PROJEKTIMIT: ZENIT&CO sh.p.k Inxh. Hidro. Merita MENGRI Ark. Raimonda MYDINLLARI Inxh. Ndert. Rexhep Tarba	
Rruga: Myrteza Topi (Nr 18.zip.code.1007) E-Mail: zenit06@live.com TIRANE - ALBANIA		Mobile phone 069 20 99 065	Inxh. Gjeo. Yzeir MIRAKA Inxh. Mek. Arqje PERI Inxh. Gjeodet. Lulzim VRAPI
		Dt. _/ _/ 2024	
		ZENIT&CO	

PLANIMETRIA SH 1:1000

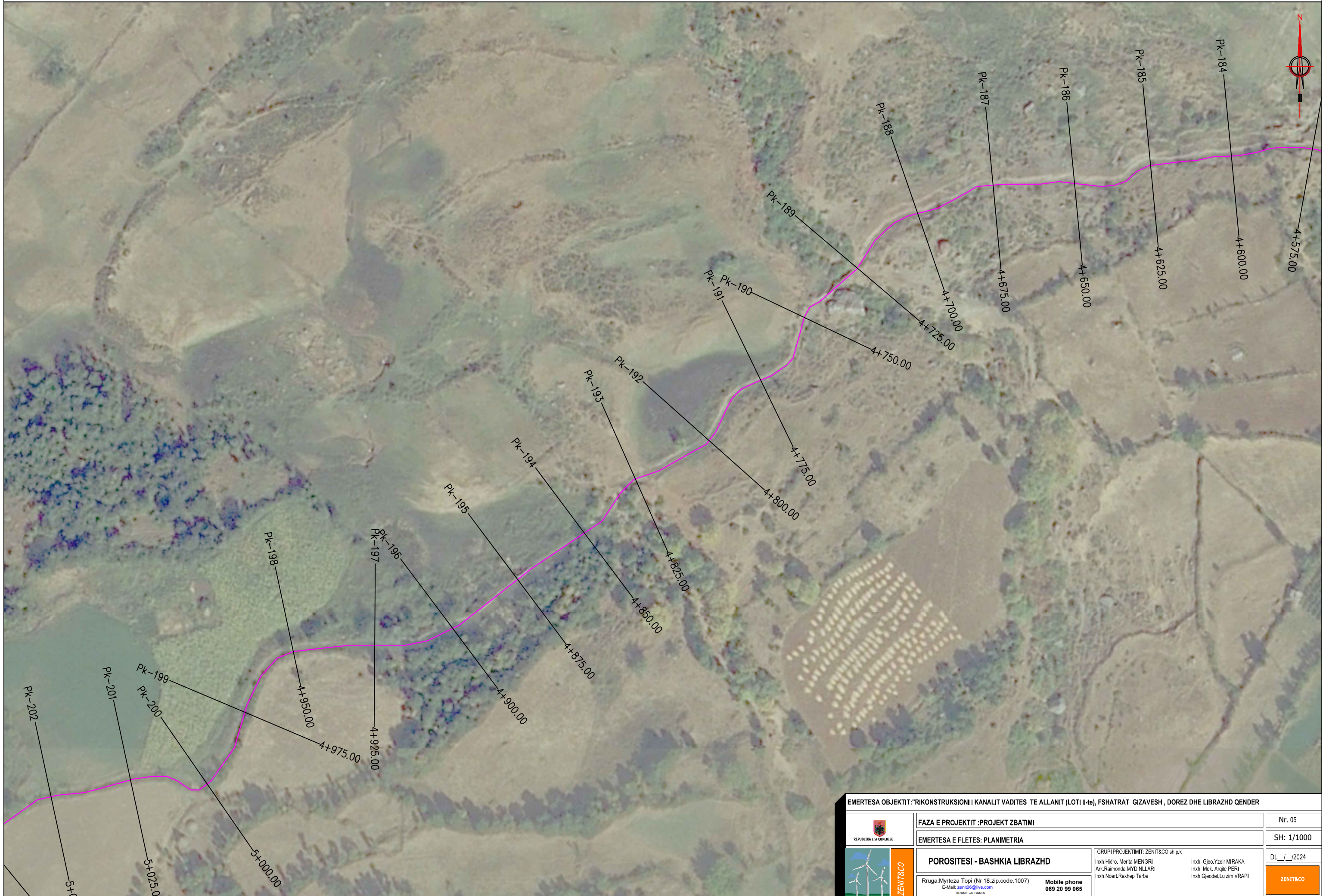

EMERTESA OBJEKTIT: "RIKONSTRUKSIONI I KANALIT VADITES TE ALLANIT (LOTI II-te), FSHATRAT GIZAVESH, DOREZ DHE LIBRAZHD QENDER				
 REPUBLIKA E SHQIPERISE	FAZA E PROJEKTIT :PROJEKT ZBATIMI	Nr. 05		
	EMERTESA E FLETES: PLANIMETRIA	SH: 1/1000		
 ZENIT&CO	POROSITESI - BASHKIA LIBRAZHD	GRUPI PROJEKTIMIT: ZENIT&CO sh.p.k		
	Rruga: Myrteza Topi (Nr 18.zip.code.1007) E-Mail: zenit06@live.com TIRANE -ALBANIA	Mobile phone 069 20 99 065	Inxh. Hidro. Merita MENGRI Ark. Raimonda MYDINLLARI Inxh. Ndert. Rexhep Tarba	Inxh. Gjeo. Yzeir MIRAKA Inxh. Mek. Arqje PERI Inxh. Gjeodet. Lulzim VRAPI
			DT. _/ _/2024	ZENIT&CO

PLANIMETRIA SH 1:1000

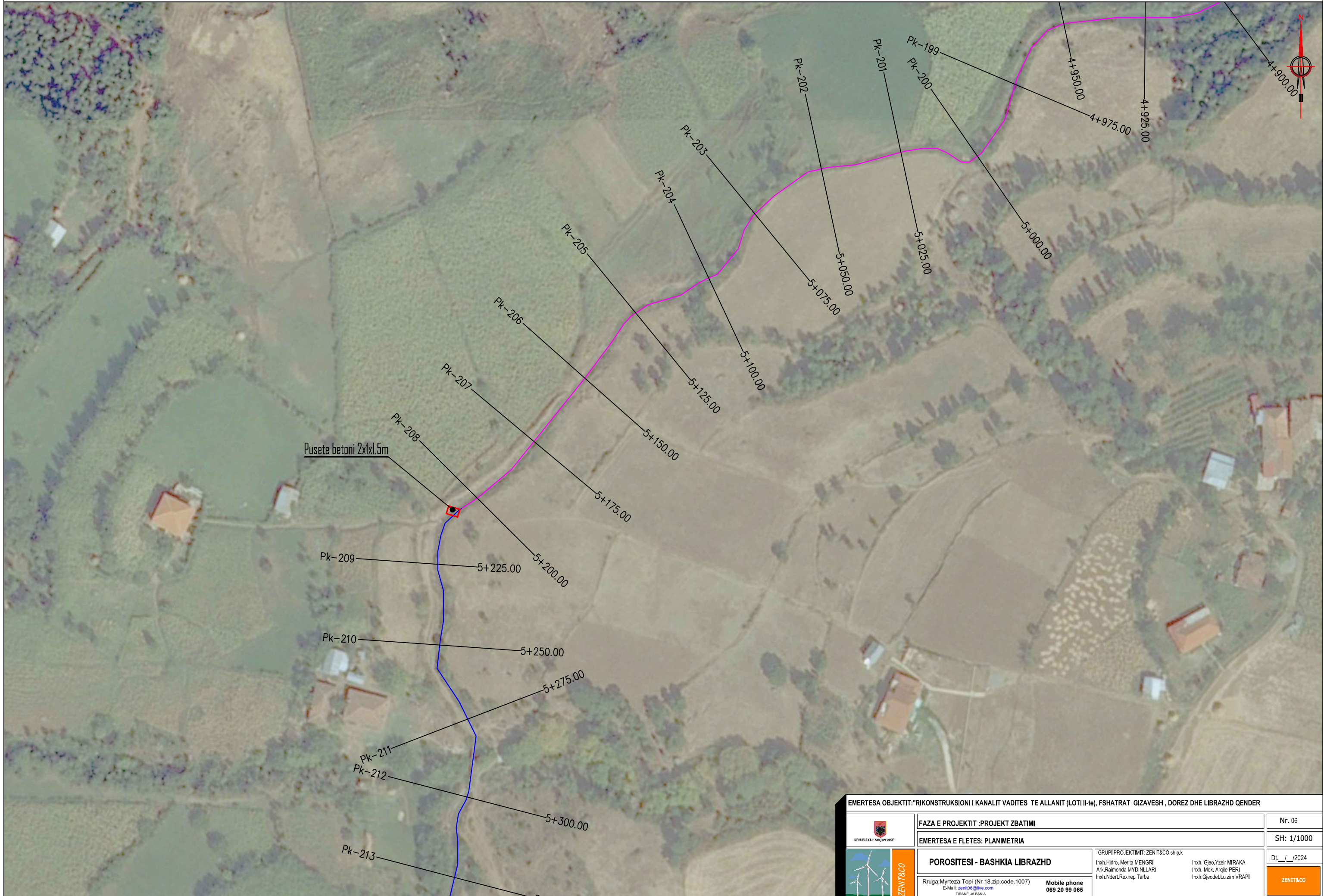

EMERTESA OBJEKTIT: "RIKONSTRUKSIONI I KANALIT VADITES TE ALLANIT (LOTI II-te), FSHATRAT GIZAVESH , DOREZ DHE LIBRAZHD QENDER			
FAZA E PROJEKTIT :PROJEKT ZBATIMI		Nr. 06	
EMERTESA E FLETES: PLANIMETRIA		SH: 1/1000	
 REPUBLIKA E SHQIPERISE		GRUPI PROJEKTIMIT: ZENIT&CO sh.p.k Inxh. Hidro. Merita MENGRI Ark. Raimonda MYDINLLARI Inxh. Ndert. Rexhep Tarba	
 ZENIT&CO		Inxh. Gjeo. Yzeir MIRAKA Inxh. Mek. Arqile PERI Inxh. Gjeodet. Lulzim VRAPI	
POROSITESI - BASHKIA LIBRAZHD Rruga: Myrteza Topi (Nr 18.zip.code.1007) E-Mail: zenit06@live.com TIRANE-ALBANIA		Mobile phone 069 20 99 065	
		Dt. _/ _/2024	
			

PLANIMETRIA SH 1:1000

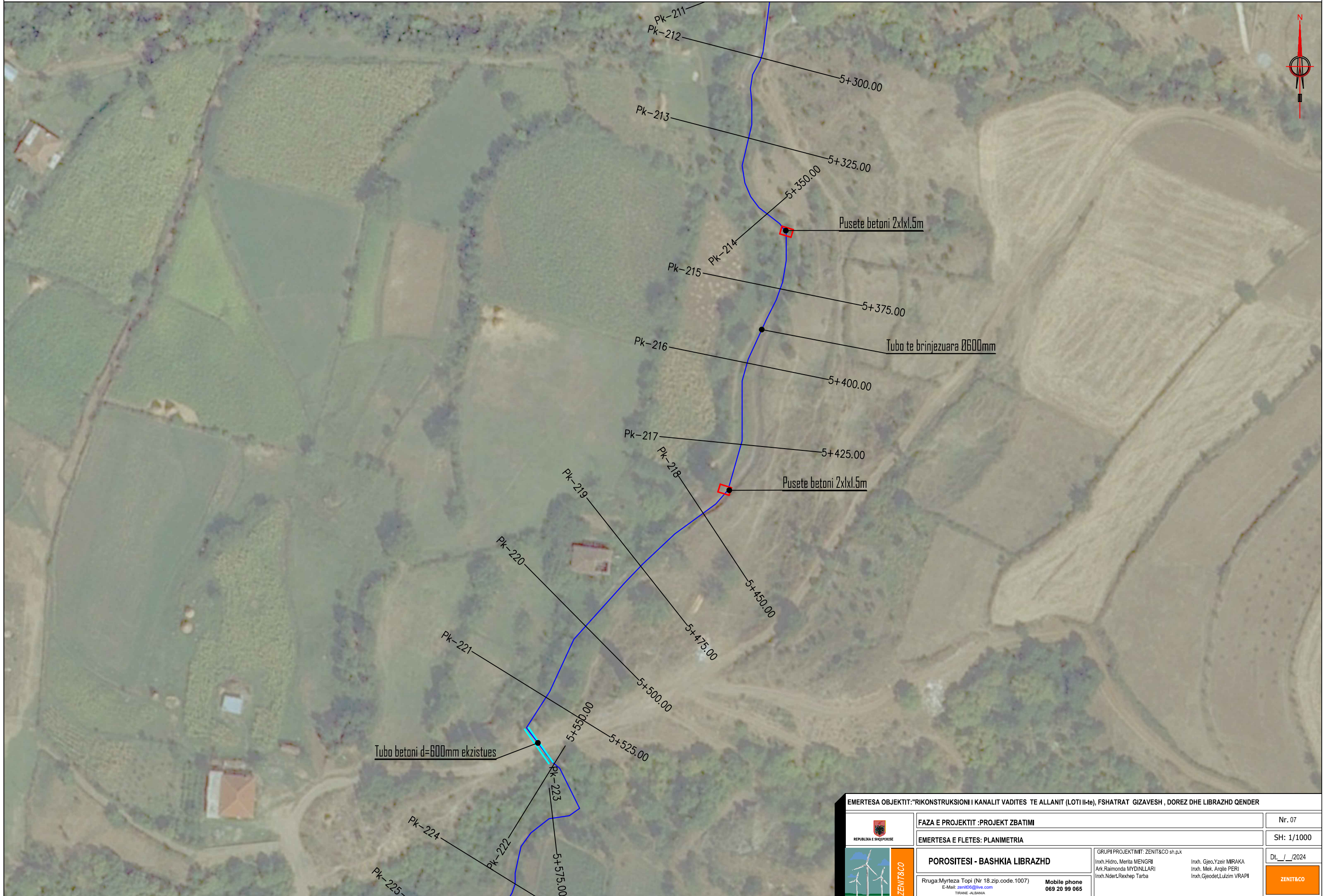

EMERTESA OBJEKTIT: "RIKONSTRUKSIONI I KANALIT VADITES TE ALLANIT (LOTI II-te), FSHATRAT GIZAVESH, DOREZ DHE LIBRAZHD QENDER				
 REPUBLIKA E SHQIPERISE	FAZA E PROJEKTIT : PROJEKT ZBATIMI	Nr. 07		
	EMERTESA E FLETES: PLANIMETRIA	SH: 1/1000		
 GRUPI PROJEKTIMIT: ZENIT&CO sh.p.k Inxh. Hidro. Merita MENGRI Ark. Raimonda MYDINLLARI Inxh. Nderi Rexhep Tarba	POROSITESI - BASHKIA LIBRAZHD	Inxh. Gjeo. Yzeir MIRAKA	DI. _/ _/2024	
	Rruga: Myrteza Topi (Nr 18.zip.code.1007) E-Mail: zenit06@live.com TIRANE - ALBANIA	Mobile phone 069 20 99 065	Inxh. Mek. Arqle PERI Inxh. Gjeodet. Lulzim VRAPI	

PLANIMETRIA SH 1:1000

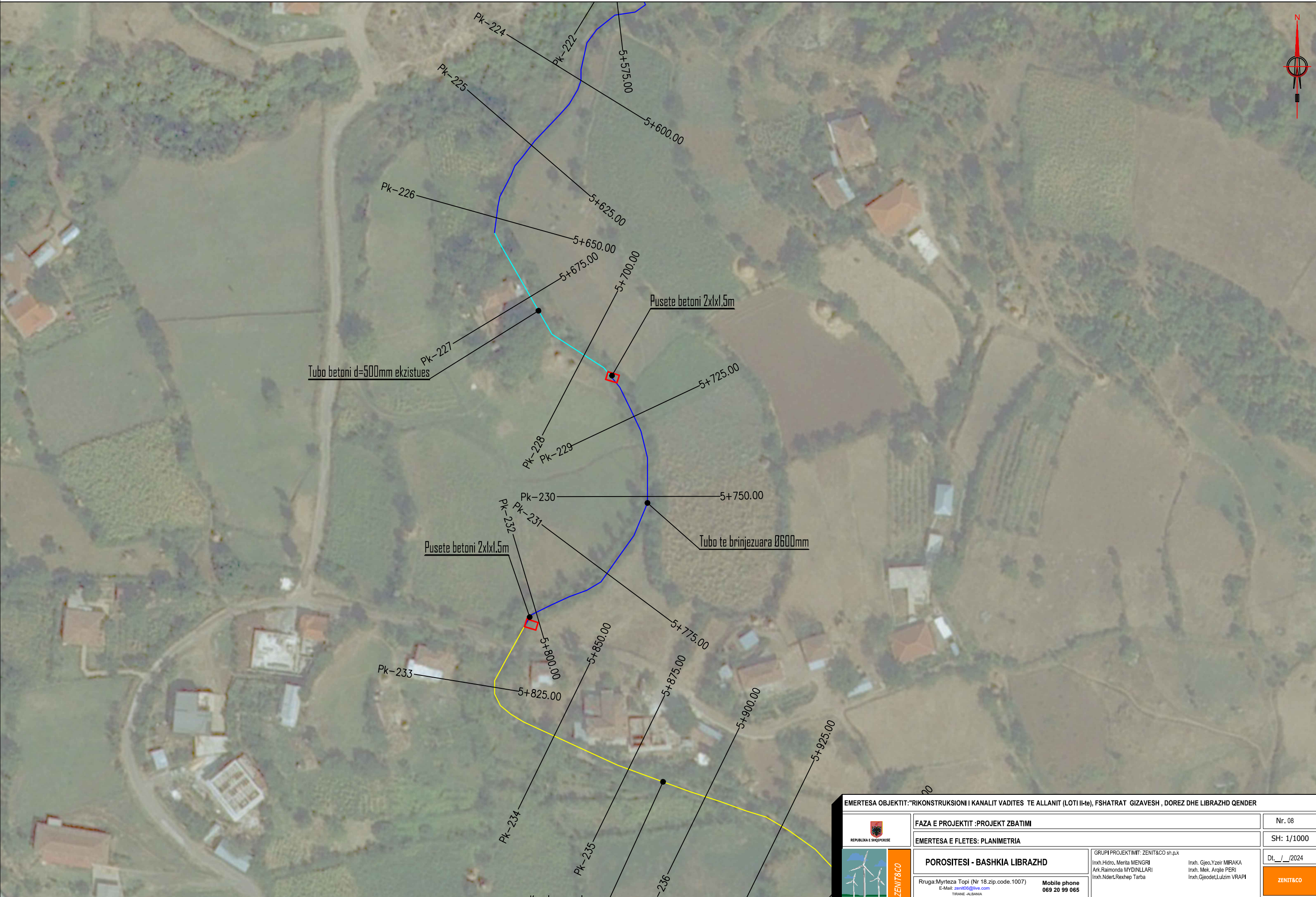

PLANIMETRIA SH 1:1000

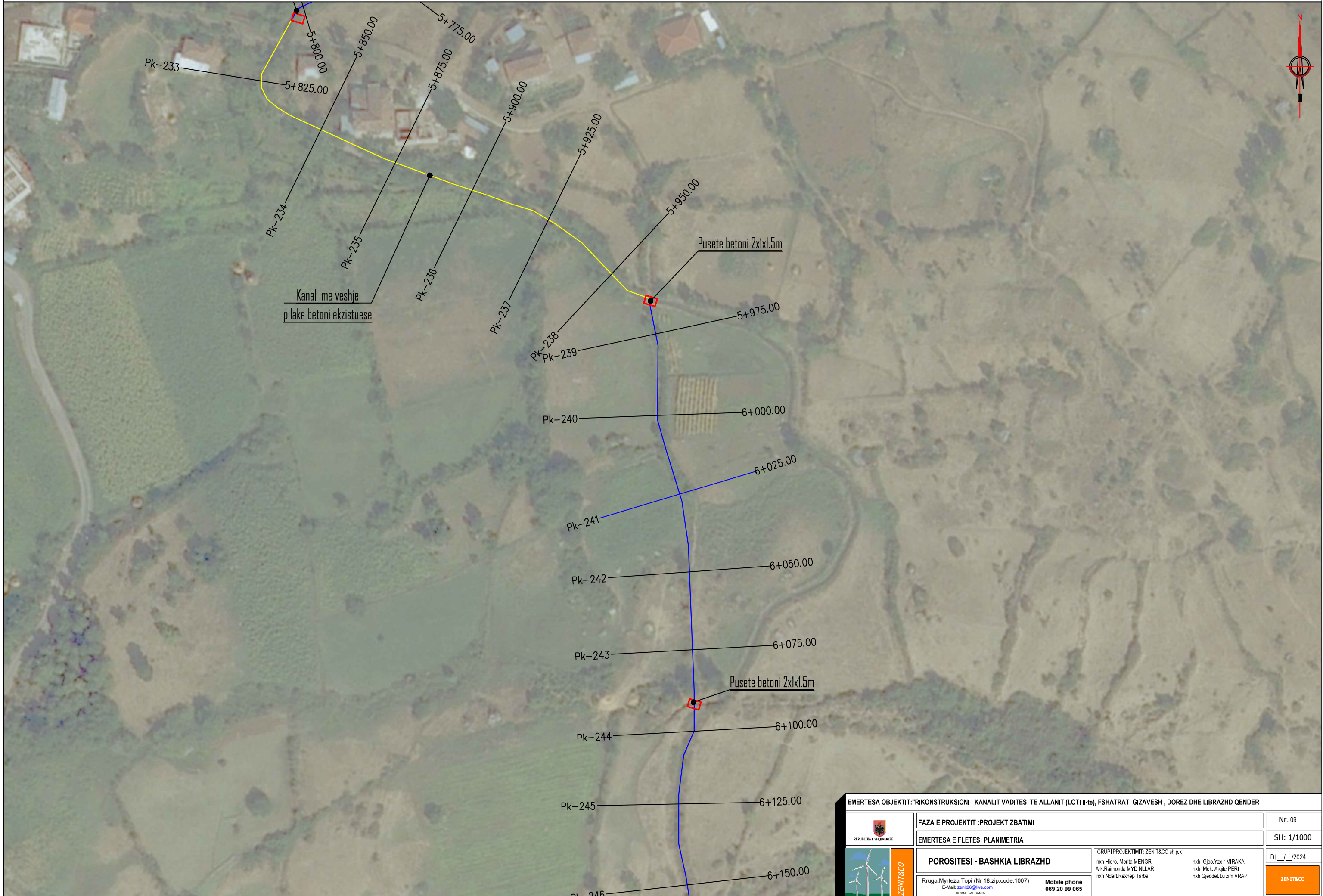

EMERTESA OBJEKTIT: "RIKONSTRUKSIONI I KANALIT VADITES TE ALLANIT (LOTI II-te), FSHATRAT GIZAVESH, DOREZ DHE LIBRAZHD QENDER			
 REPUBLIKA E SHQIPERISE	FAZA E PROJEKTIT :PROJEKT ZBATIMI	Nr. 09	
	EMERTESA E FLETES: PLANIMETRIA	SH: 1/1000	
 ZENIT&CO	POROSITESI - BASHKIA LIBRAZHD Rruga: Myrteza Topi (Nr 18.zip.code.1007) E-Mail: zenit06@live.com TIRANE-ALBANIA	GRUPI PROJEKTIMIT: ZENIT&CO sh.p.k Inxh. Hidro. Merita MENGRI Ark. Raimonda MYDINLLARI Inxh. Nderi Rexhep Tarba	Inxh. Gjeo. Yzeir MIRAKA Inxh. Mek. Arqje PERI Inxh. Gjeodet. Lulzim VRAPI
	Mobile phone 069 20 99 065	Dt. _/ _/2024	
	ZENIT&CO		ZENIT&CO

PLANIMETRIA SH 1:1000

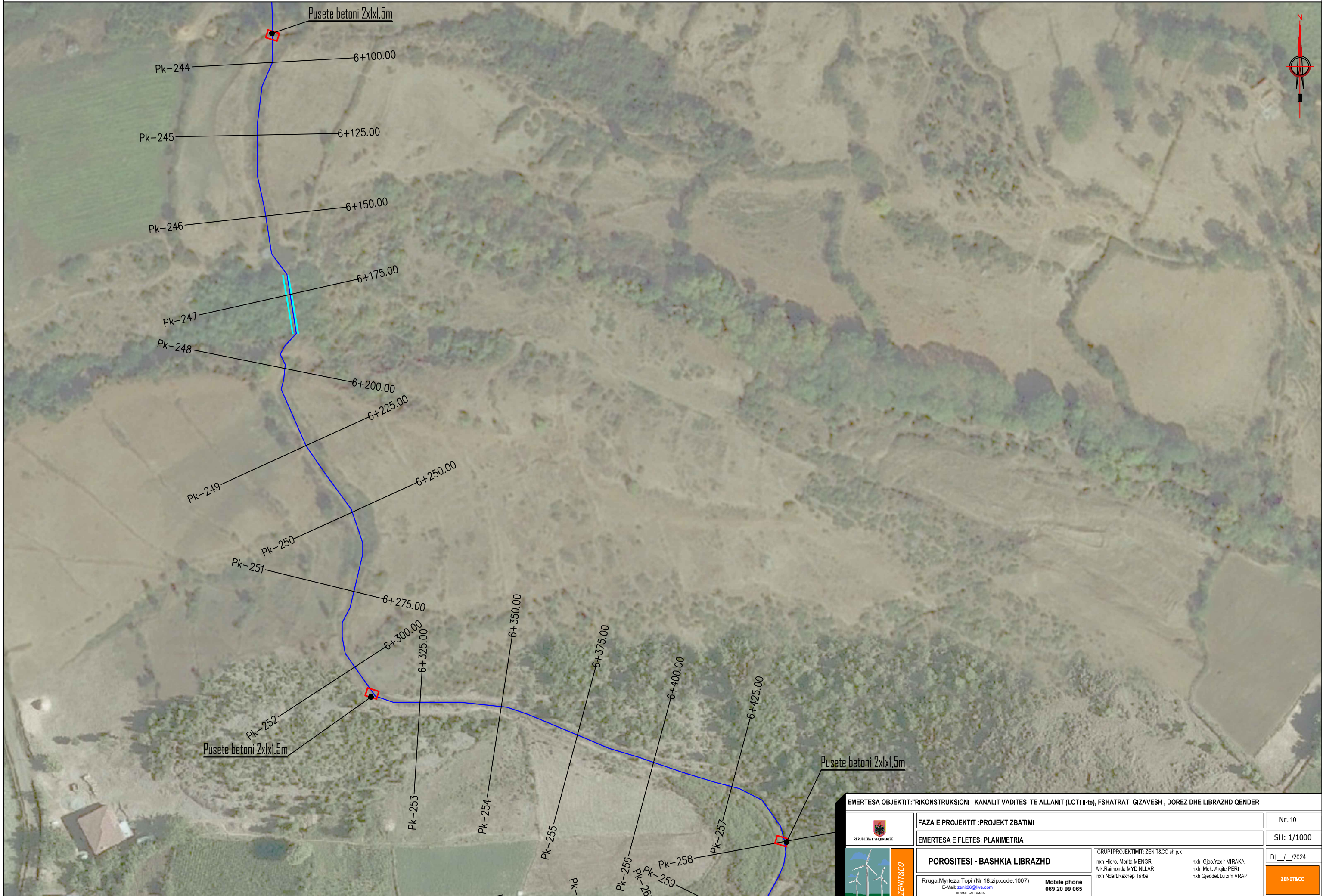

EMERTESA OBJEKTIT: "RIKONSTRUKSIONI I KANALIT VADITES TE ALLANIT (LOTI II-te), FSHATRAT GIZAVESH , DOREZ DHE LIBRAZHD QENDER			
FAZA E PROJEKTIT :PROJEKT ZBATIMI			Nr. 10
EMERTESA E FLETES: PLANIMETRIA			SH: 1/1000
 REPUBLIKA E SHQIPERISE		GRUPI PROJEKTIMIT: ZENIT&CO sh.p.k Inxh. Hidro. Merita MENGRI Ark. Raimonda MYDINLLARI Inxh. Ndert. Rexhep Tarba	
 POROSITESI - BASHKIA LIBRAZHD		Inxh. Gjeo. Yzeir MIRAKA Inxh. Mek. Arqje PERI Inxh. Gjeodet. Lulzim VRAPI	
Rruga: Myrteza Topi (Nr 18.zip.code.1007) E-Mail: zenit06@live.com TIRANE-ALBANIA		Mobile phone 069 20 99 065	
			Dt. _/ _/2024 

PLANIMETRIA SH 1:1000

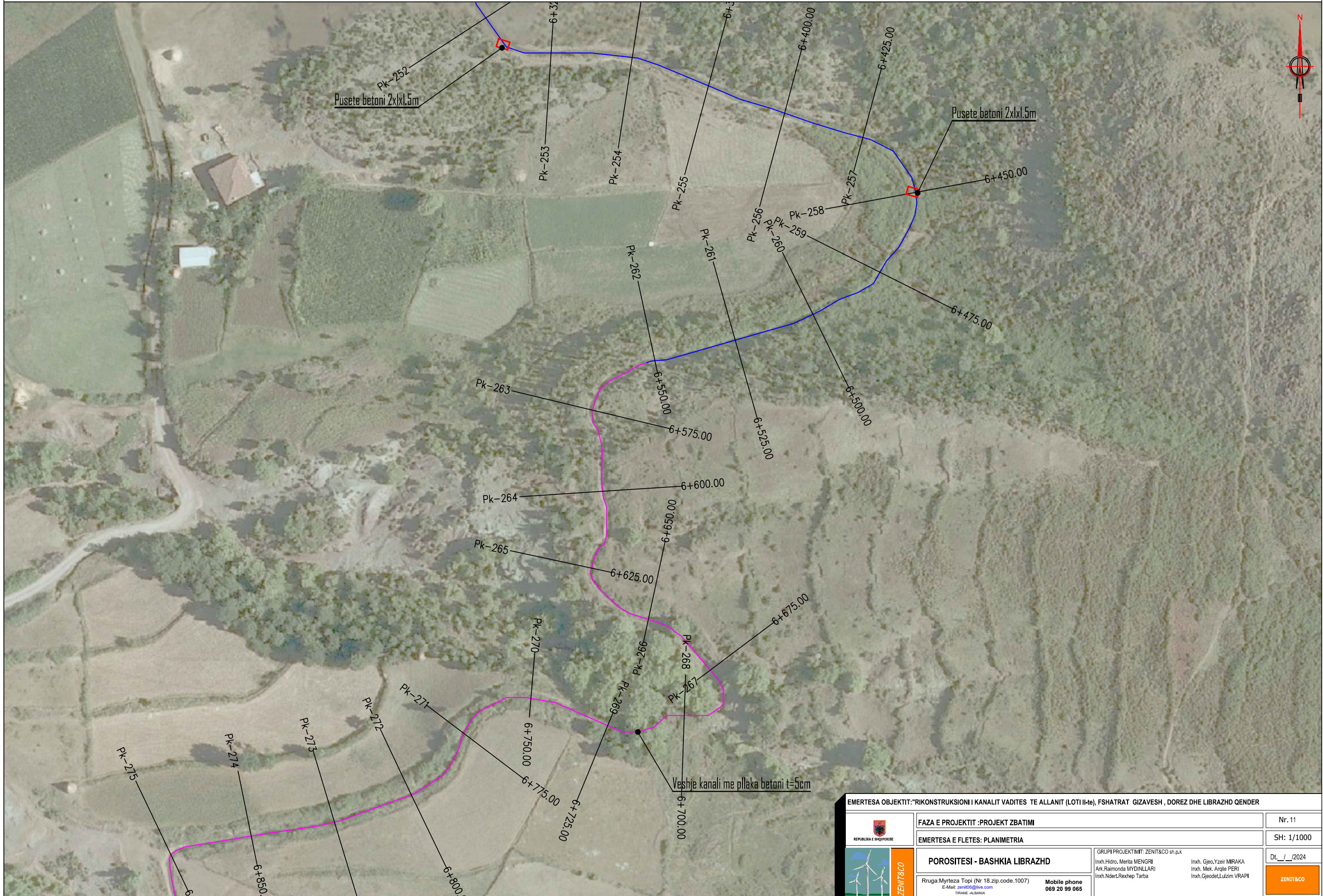

EMERTESA OBJEKTIT: "RIKONSTRUKSIONI I KANALIT VADITES TE ALLANIT (LOTI II-te), FSHATRAT GIZAVESH , DOREZ DHE LIBRAZHD QENDER		
	FAZA E PROJEKTIT : PROJEKT ZBATIMI	Nr. 11
	EMERTESA E FLETES: PLANIMETRIA	SH: 1/1000
	POROSITESI - BASHKIA LIBRAZHD	GRUPI PROJEKTIMIT: ZENIT&CO sh.p.k
Rruga: Myrteza Topi (Nr 18.zip.code.1007) E-Mail: zenit06@live.com TIRANE - ALBANIA	Mobile phone 069 20 99 065	Inxh. Hidro. Merita MENGRI Ark. Raimonda MYDINLLARI Inxh. Nderi Rexhep Tarba Inxh. Gjeo. Yzeir MIRAKA Inxh. Mek. Arqole PERI Inxh. Gjeodet. Lulzim VRAPI
		DI: _/ _/ 2024
		ZENIT&CO

PLANIMETRIA SH 1:1000

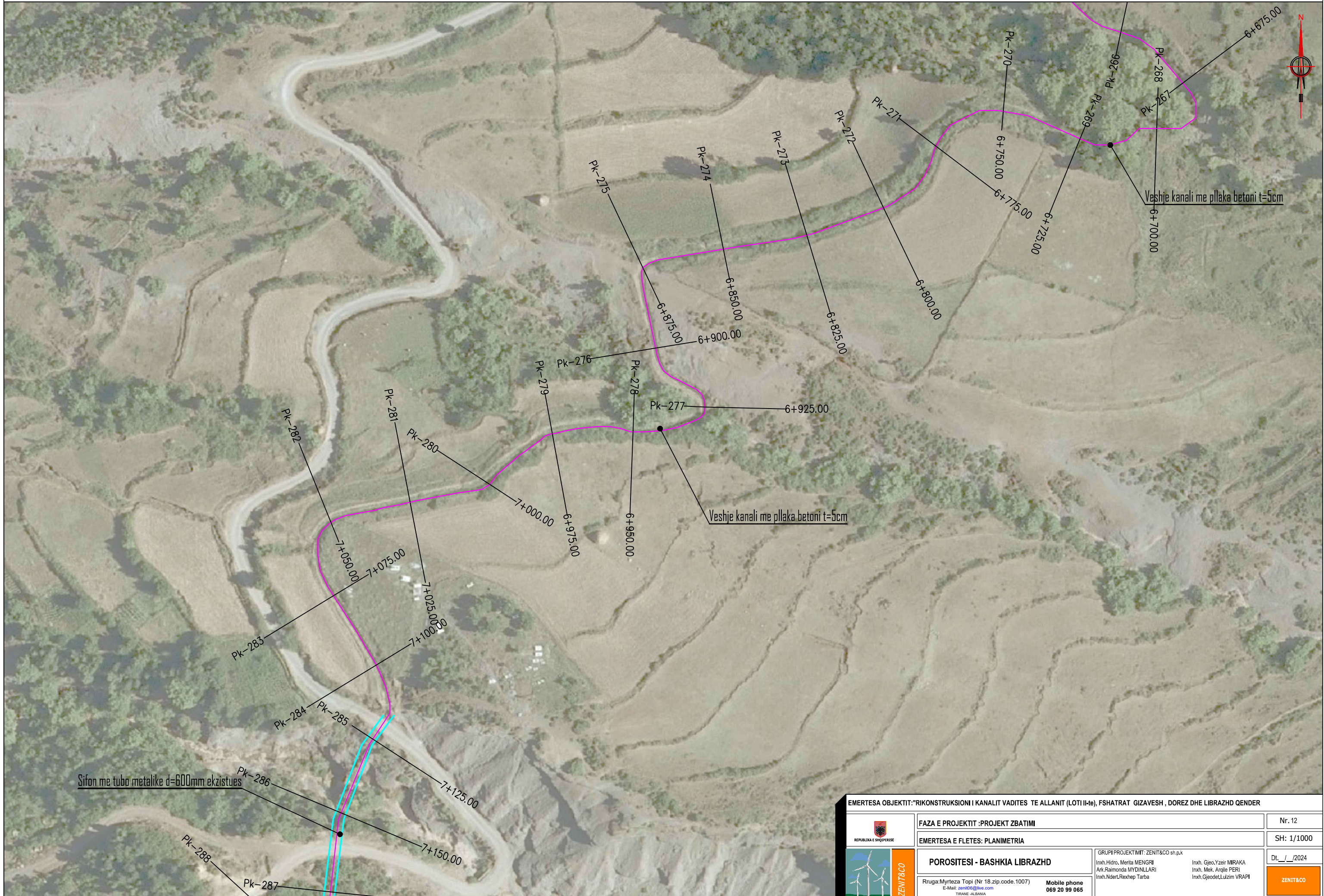

EMERTESA OBJEKTIT: "RIKONSTRUKSIONI I KANALIT VADITES TE ALLANIT (LOTI II-te), FSHATRAT GIZAVESH , DOREZ DHE LIBRAZHD QENDER			
 REPUBLIKA E SHQIPERISE		FAZA E PROJEKTIT : PROJEKT ZBATIMI	Nr. 12
 ZENIT&CO		EMERTESA E FLETES: PLANIMETRIA	SH: 1/1000
POROSITESI - BASHKIA LIBRAZHD Rruga: Myrteza Topi (Nr 18.zip.code.1007) E-Mail: zenit06@live.com TIRANE - ALBANIA		GRUPI PROJEKTIMIT: ZENIT&CO sh.p.k Inxh. Hidro. Merita MENGRI Ark. Raimonda MYDINLLARI Inxh. Ndert. Rexhep Tarba	Inxh. Gjeo. Yzeir MIRAKA Inxh. Mek. Arqije PERI Inxh. Gjeodet. Lulzim VRAPI
		Mobile phone 069 20 99 065	Dt. _/ _/ 2024  ZENIT&CO

PLANIMETRIA SH 1:1000

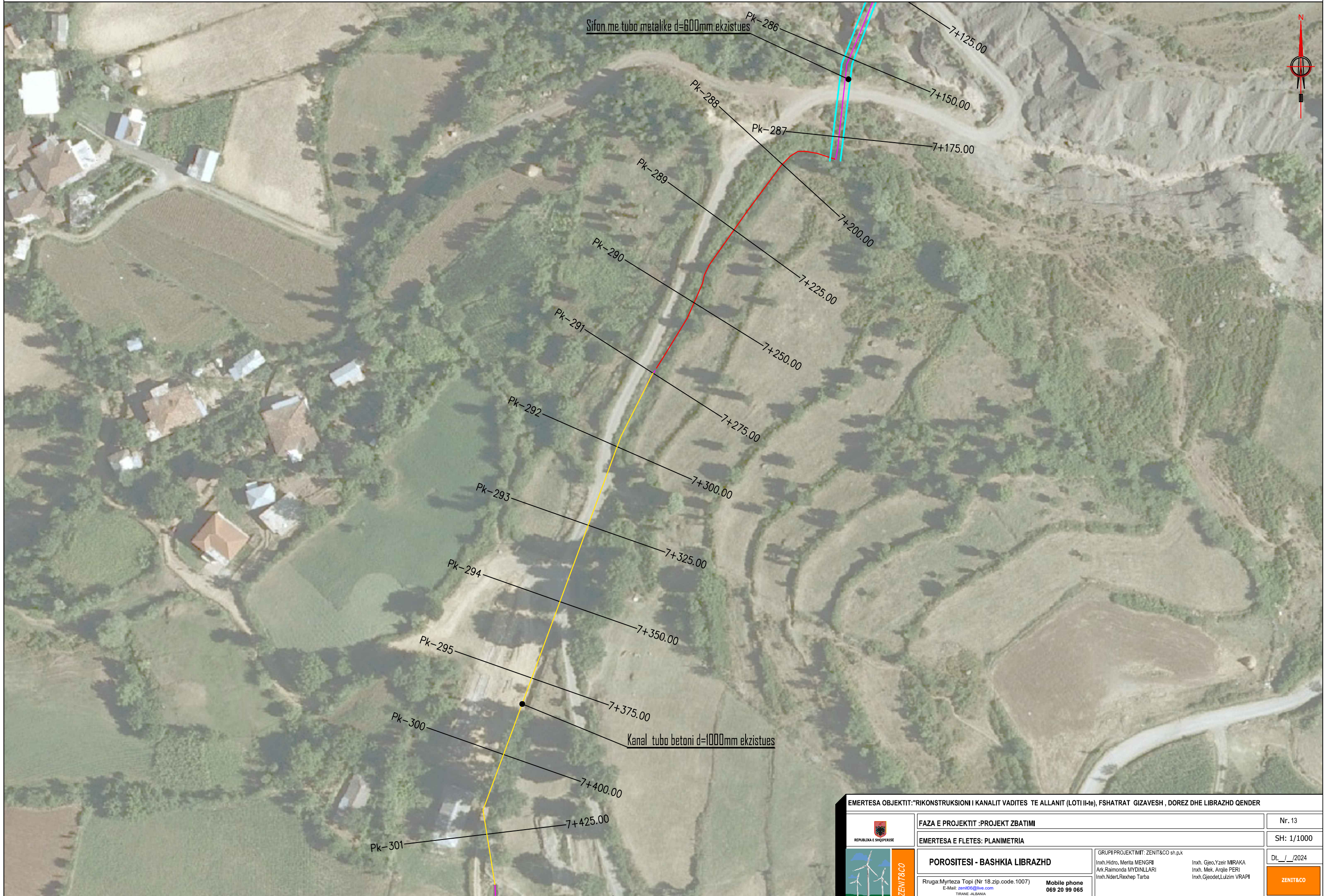

EMERTESA OBJEKTIT: "RIKONSTRUKSIONI I KANALIT VADITES TE ALLANIT (LOTI II-te), FSHATRAT GIZAVESH, DOREZ DHE LIBRAZHD QENDER			
 REPUBLIKA E SHQIPERISE	FAZA E PROJEKTIT : PROJEKT ZBATIMI	Nr. 13	
	EMERTESA E FLETES: PLANIMETRIA	SH: 1/1000	
 ZENIT&CO	POROSITESI - BASHKIA LIBRAZHD Rruga: Myrteza Topi (Nr 18.zip.code.1007) E-Mail: zenit06@live.com TIRANE-ALBANIA	GRUPI PROJEKTIMIT: ZENIT&CO sh.p.k Inxh. Hidro. Merita MENGRI Ark. Raimonda MYDINLLARI Inxh. Nderi Rexhep Tarba	Inxh. Gjeo. Yzeir MIRAKA Inxh. Mek. Arqje PERI Inxh. Gjeodet. Lulzim VRAPI
	Mobile phone 069 20 99 065	Dt. _/ _/2024	
			

PLANIMETRIA SH 1:1000



EMERTESA OBJEKTIT: "RIKONSTRUKSIONI I KANALIT VADITES TE ALLANIT (LOTI II-te), FSHATRAT GIZAVESH, DOREZ DHE LIBRAZHD QENDER			
FAZA E PROJEKTIT : PROJEKT ZBATIMI			Nr. 14
EMERTESA E FLETES: PLANIMETRIA			SH: 1/1000
 REPUBLIKA E SHQIPERISE	POROSITESI - BASHKIA LIBRAZHD		GRUPI PROJEKTIMIT: ZENIT&CO sh.p.k Inxh. Hidro. Merita MENGRI Ark. Raimonda MYDINLLARI Inxh. Nderi Rexhep Tarba
	Rruga: Myrteza Topi (Nr 18.zip.code.1007) E-Mail: zenit06@live.com TIRANE-ALBANIA		Inxh. Gjeo. Yzeir MIRAKA Inxh. Mek. Arqje PERI Inxh. Gjeodet. Lulzim VRAPI
Mobile phone 069 20 99 065			

PLANIMETRIA SH 1:1000

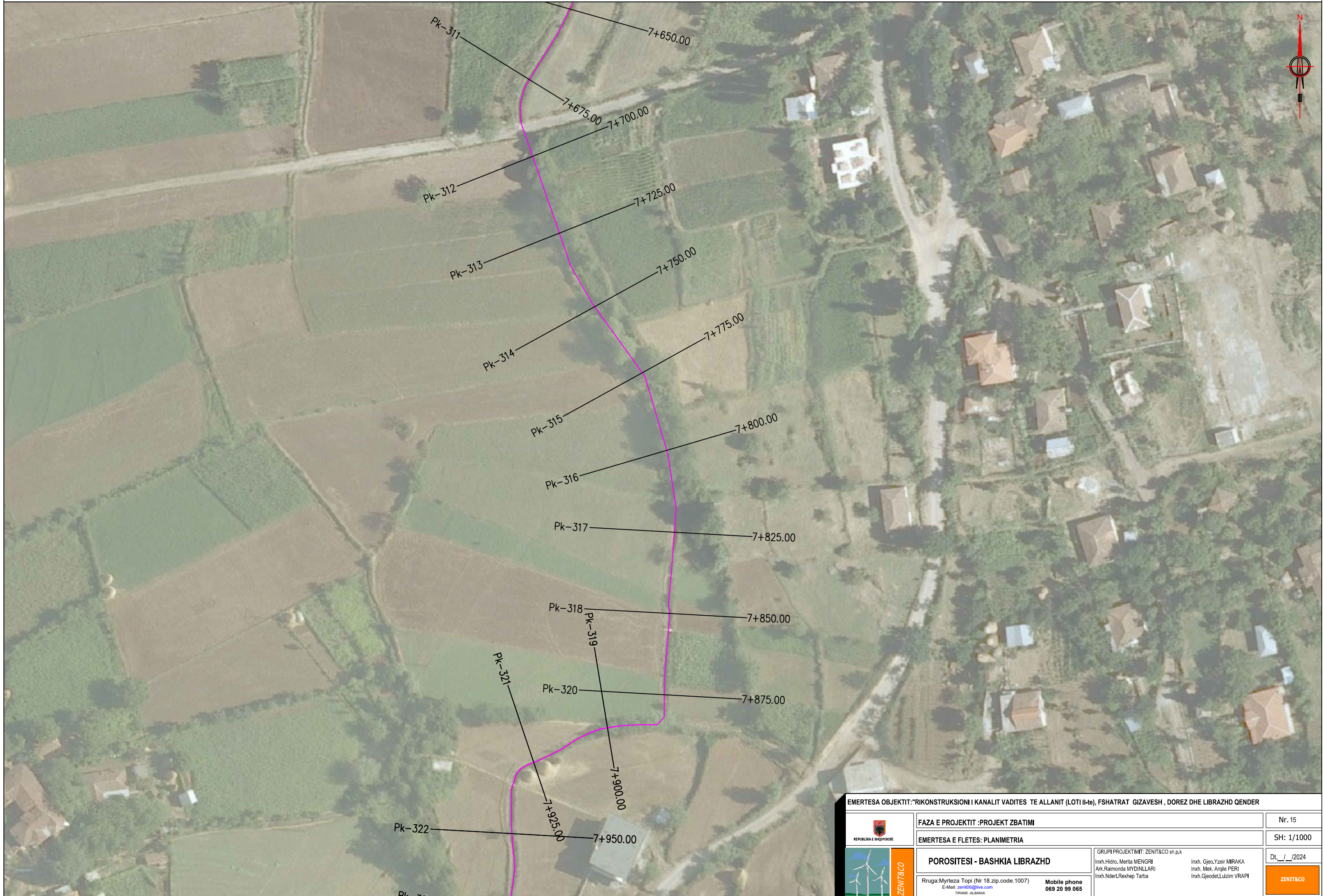

EMERTESA OBJEKTIT: "RIKONSTRUKSIONI I KANALIT VADITES TE ALLANIT (LOTI II-te), FSHATRAT GIZAVESH, DOREZ DHE LIBRAZHD QENDER			
FAZA E PROJEKTIT : PROJEKT ZBATIMI			Nr. 15
EMERTESA E FLETES: PLANIMETRIA			SH: 1/1000
 REPUBLIKA E SHQIPERISE 	POROSITESI - BASHKIA LIBRAZHD Rruga: Myrteza Topi (Nr 18.zip.code.1007) E-Mail: zenit06@live.com TIRANE-ALBANIA		GRUPI PROJEKTIMIT: ZENIT&CO sh.p.k Inxh. Hidro. Merita MENGRI Ark. Raimonda MYDINLLARI Inxh. Nderi Rexhep Tarba Inxh. Gjeo. Yzeir MIRAKA Inxh. Mek. Arqle PERI Inxh. Gjeodet. Lulzim VRAPI
	Mobile phone 069 20 99 065		Dt. _/ _/2024 

PLANIMETRIA SH 1:1000

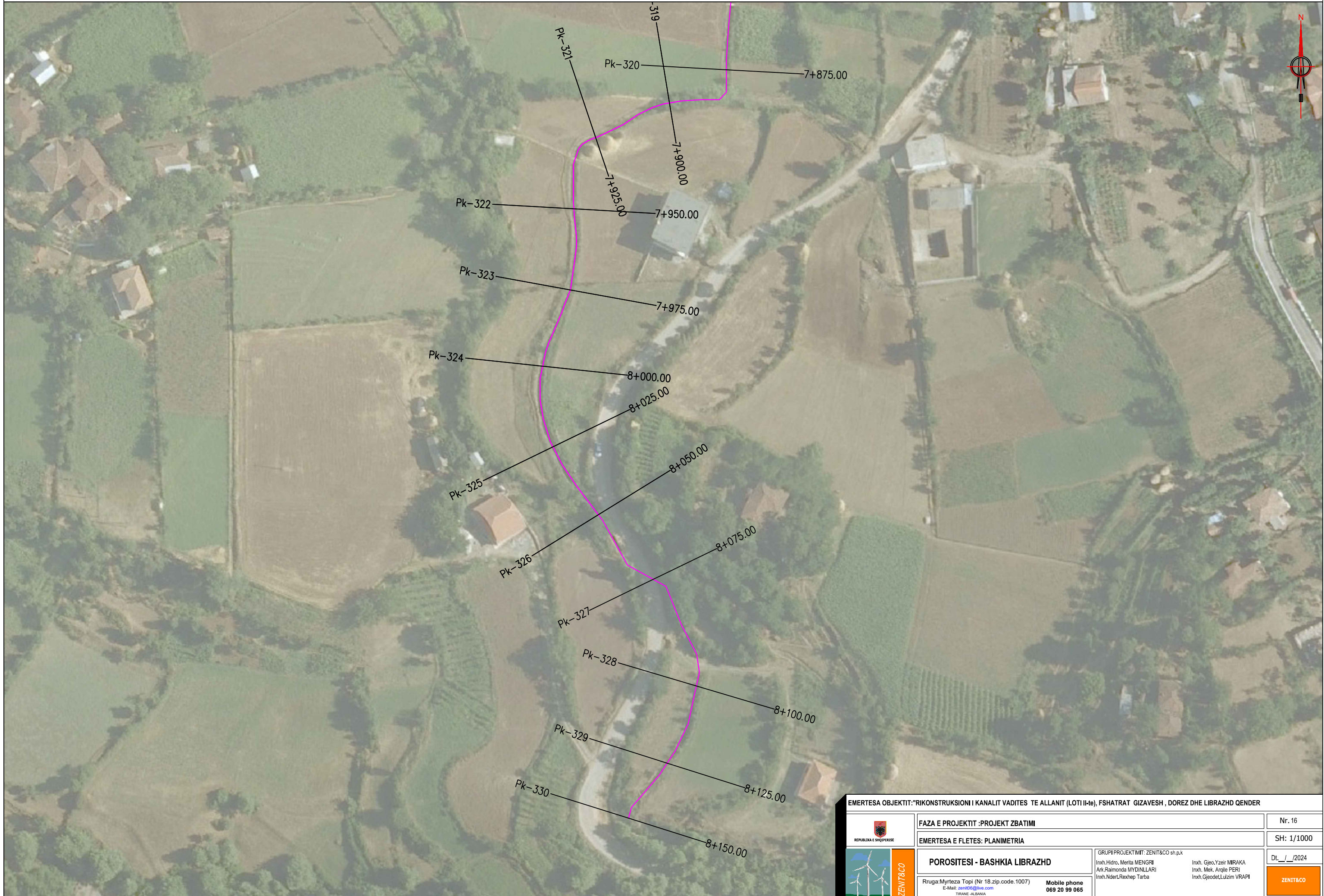

EMERTESA OBJEKTIT: "RIKONSTRUKSIONI I KANALIT VADITES TE ALLANIT (LOTI II-te), FSHATRAT GIZAVESH , DOREZ DHE LIBRAZHD QENDER			
FAZA E PROJEKTIT : PROJEKT ZBATIMI			Nr. 16
EMERTESA E FLETES: PLANIMETRIA			SH: 1/1000
 REPUBLIKA E SHQIPERISE		GRUPI PROJEKTIMIT: ZENIT&CO sh.p.k Inxh. Hidro. Merita MENGRI Ark. Raimonda MYDINLLARI Inxh. Nderi Rexhep Tarba	
 ZENIT&CO		Inxh. Gjeo. Yzeir MIRAKA Inxh. Mek. Arqije PERI Inxh. Gjeodet. Lulzim VRAPI	
Rruga: Myrteza Topi (Nr 18.zip.code.1007) E-Mail: zenit06@live.com TIRANE-ALBANIA		Mobile phone 069 20 99 065	
POROSITESI - BASHKIA LIBRAZHD			Dt. _/ _/2024
			

PROFILI TERTHOR TIP GERMIMI

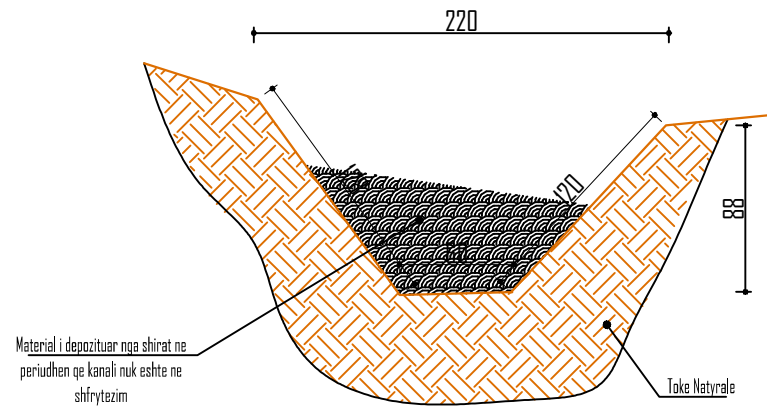

PROFILI TERTHOR TIP I KANALIT ME PLLAKA

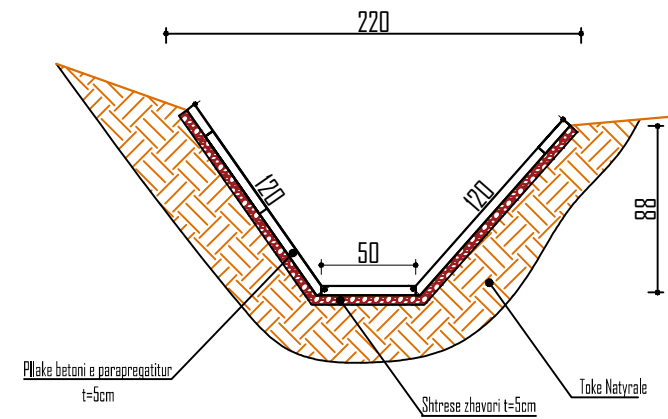

PROFILI TERTHOR TIP GERMIMI

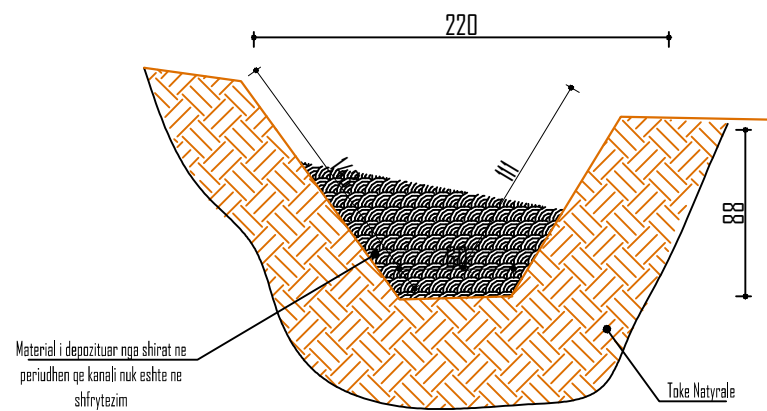

PROFILI TERTHOR TIP GERMIMI

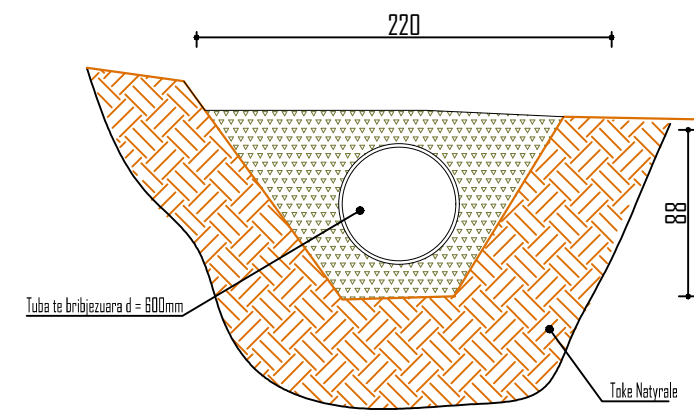

EMERTESA OBJEKTIT: "RIKONSTRUKSIONI I KANALIT VADITES TE ALLANIT (LOTI II-te), FSHATRAT GIZAVESH , DOREZ DHE LIBRAZHD QENDER			
 REPUBLIKA E SHQIPERISE	FAZA E PROJEKTIT : PROJEKT ZBATIMI		Nr. 17
	EMERTESA E FLETES: PROFILAT TIP TE KANALIT		SH: 1/50
 ZENIT&CO Rruga: Myrteza Topi (Nr 18.zip.code.1007) E-Mail: zenit06@live.com TIRANE-ALBANIA	POROSITESI - BASHKIA LIBRAZHD Mobile phone 069 20 99 065		DT. _/ _/2024 ZENIT&CO
	GRUPI PROJEKTIMIT: ZENIT&CO sh.p.k Inxh. Hidro. Merita MENGRI Ark. Raimonda MYDINLLARI Inxh. Ndert. Rexhep Tarba		Inxh. Gjeo. Yzeir MIRAKA Inxh. Mek. Arqje PERI Inxh. Gjeodet. Lulzim VRAPI

PROFILI TERTHOR TIP GERMIMI

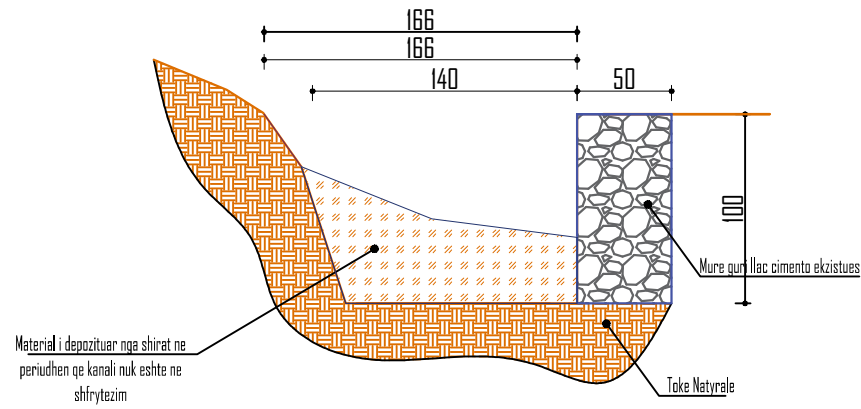

PROFILI TERTHOR TIP I KANALIT ME VESHJE BETONI

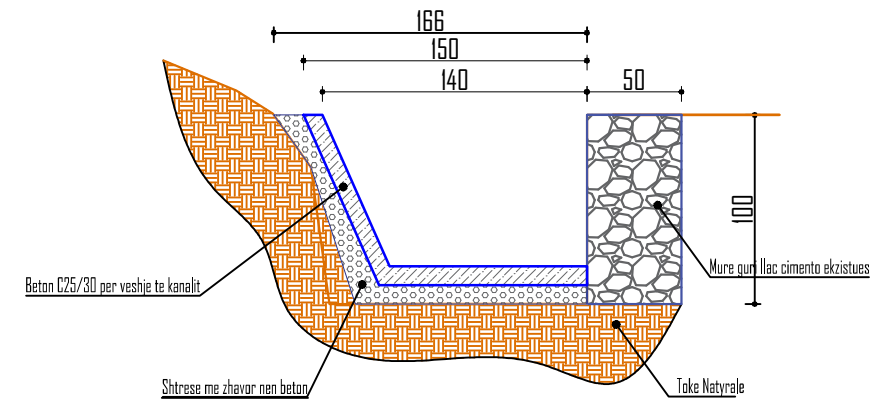

PROFILI TERTHOR TIP I KANALIT ME BETONI

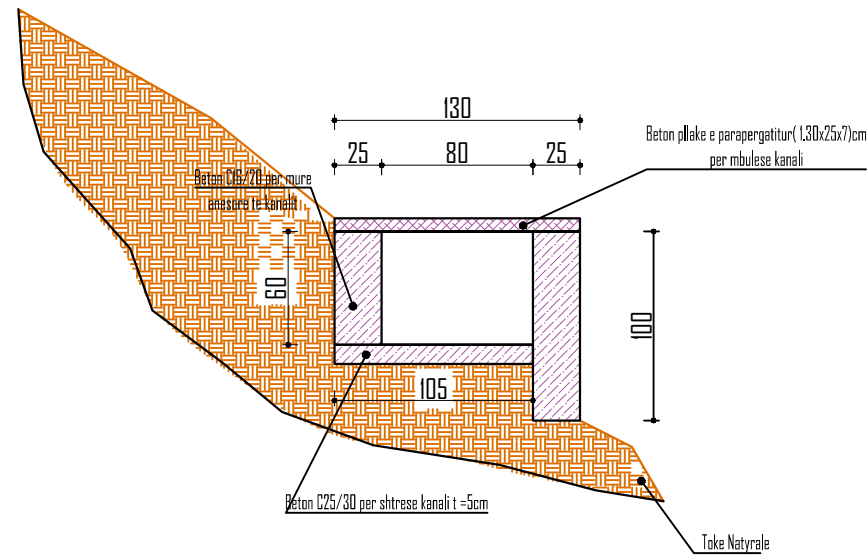

PROFILI TERTHOR TIP MURE MBAJTES

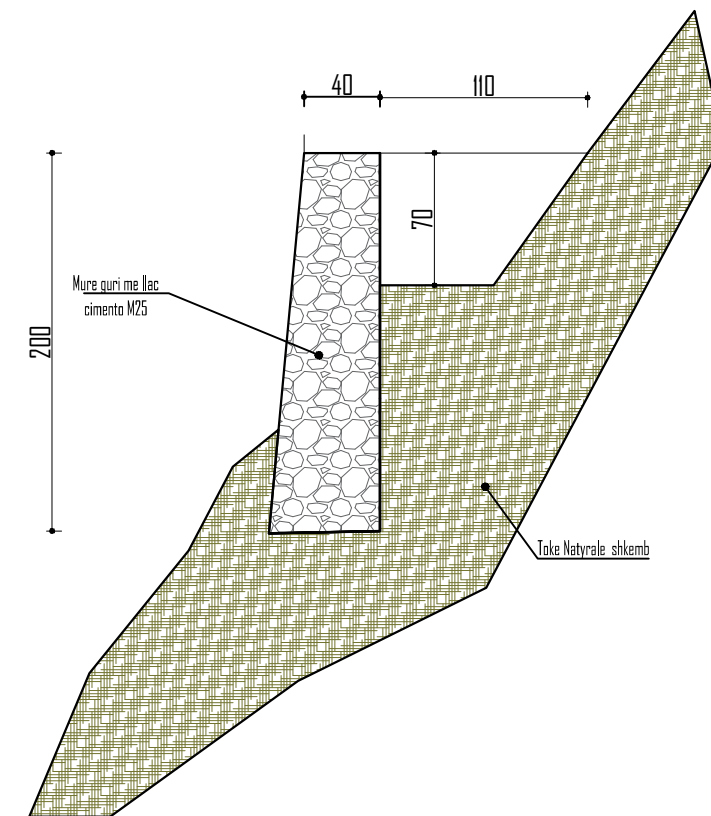

EMERTESA OBJEKTIT: "RIKONSTRUKSIONI I KANALIT VADITES TE ALLANIT (LOTI II-te), FSHATRAT GIZAVESH , DOREZ DHE LIBRAZHD QENDER

 REPUBLIKA E SHQIPERISE	FAZA E PROJEKTIT : PROJEKT ZBATIMI	Nr. 18
	EMERTESA E FLETES: PROFILAT TIP TE KANALIT	SH: 1/50
 POROSITESI - BASHKIA LIBRAZHD Rruga: Myrteza Topi (Nr 18.zip.code.1007) E-Mail: zenit06@live.com TIRANE - ALBANIA	GRUPI PROJEKTIMIT: ZENIT&CO sh.p.k Inxh. Hidro. Merita MENGRI Ark. Raimonda MYDINLLARI Inxh. Ndert. Rexhep Tarba	Inxh. Gjeo. Yzeir MIRAKA Inxh. Mek. Arqje PERI Inxh. Gjeodet. Lulzim VRAPI
	Dt. _/ _/2024 ZENIT&CO	Mobile phone 069 20 99 065

PUSETA TIP KONTROLLI (2X1X1.5) M

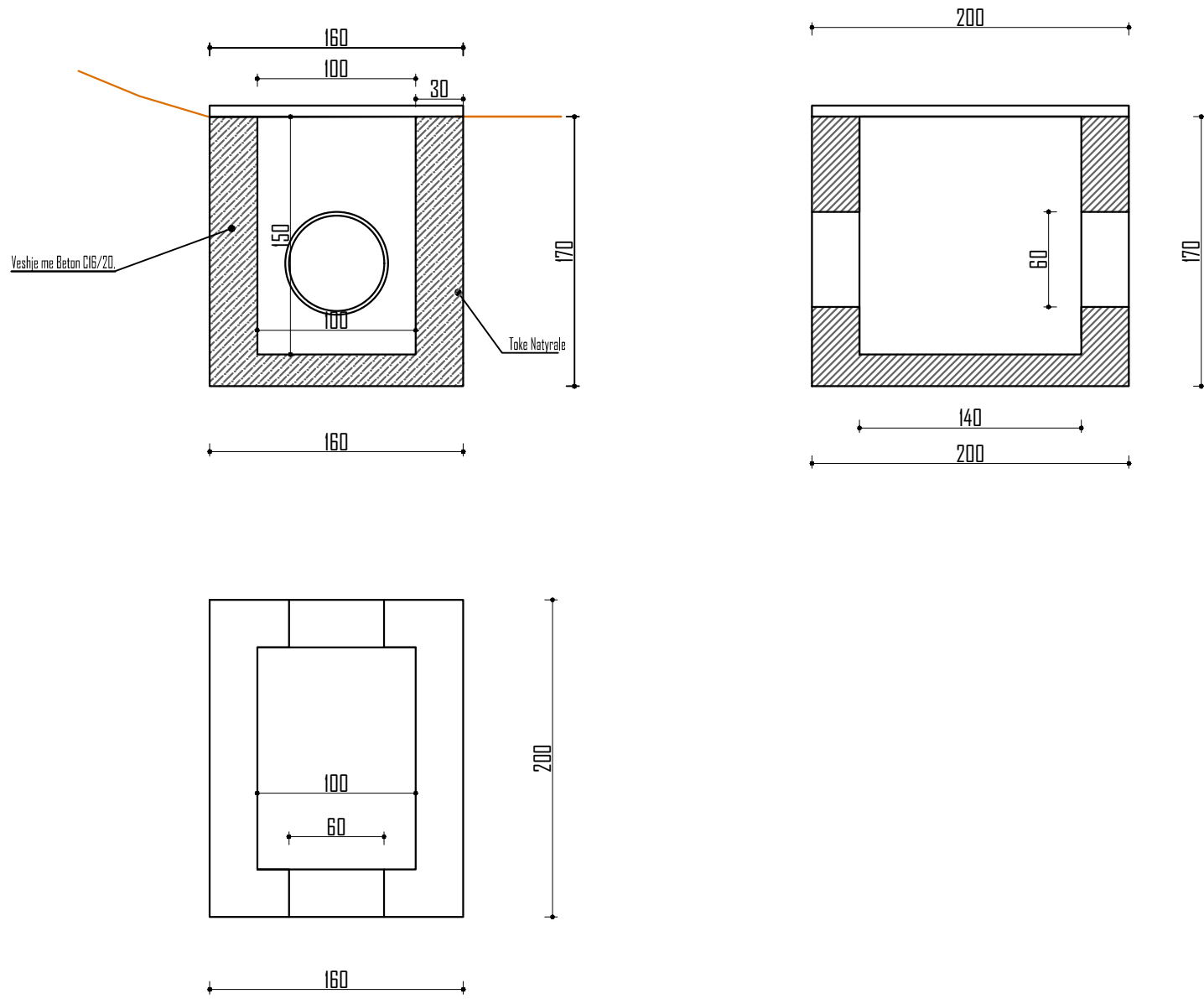

HEKUR PER PUSETE KONTROLLI DHE DEKANTUESI

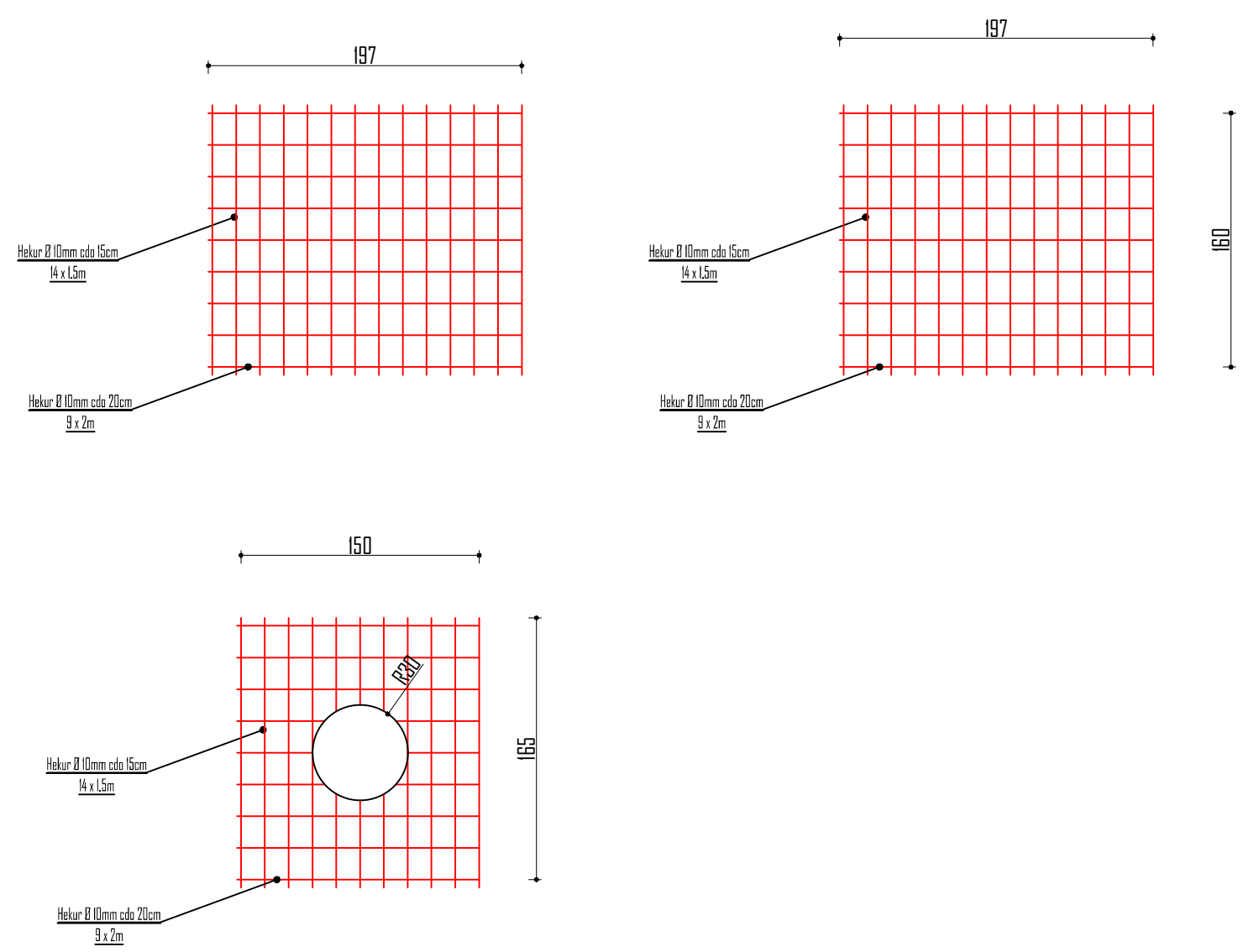

EMERTESA OBJEKTIT: "RIKONSTRUKSIONI I KANALIT VADITES TE ALLANIT (LOTI II-te), FSHATRAT GIZAVESH , DOREZ DHE LIBRAZHD QENDER			
 REPUBLIKA E SHQIPERISE	FAZA E PROJEKTIT : PROJEKT ZBATIMI	Nr. 19	
	EMERTESA E FLETES: PUSETE KONTROLLI DHE DEKANTIMI	SH: 1/50	
 ZENIT&CO	POROSITESI - BASHKIA LIBRAZHD	GRUPI PROJEKTIMIT: ZENIT&CO sh.p.k	
	Rruga: Myrteza Topi (Nr 18.zip.code.1007) E-Mail: zenit06@live.com TIRANE-ALBANIA	Mobile phone 069 20 99 065	Inxh. Hidro. Merita MENGRI Ark. Raimonda MYDINLLARI Inxh. Ndert. Rexhep Tarba
			Dt. ___/___/2024 

PORTAL TIP BETONI PER HYRJE NE TUBACION

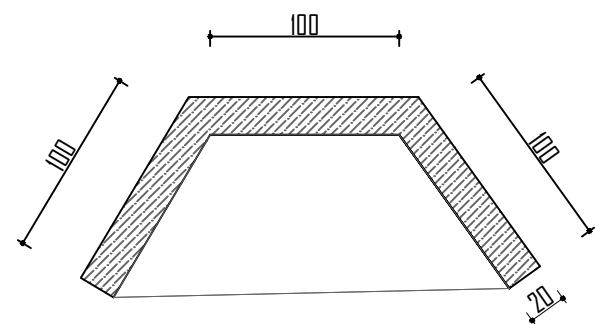
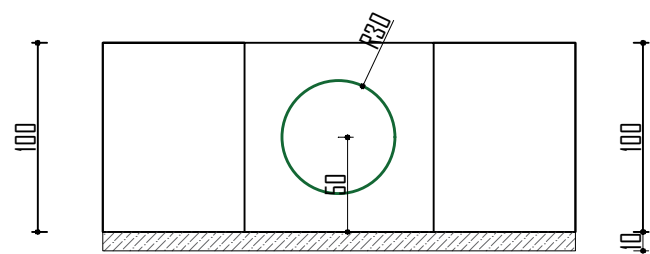

TUBACION I BRINJEZUAR D = 600MM I MBULUAR

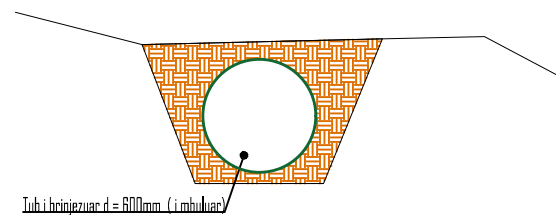

HEKUR PER PORTAT HYRESE TE TUBACIONIT

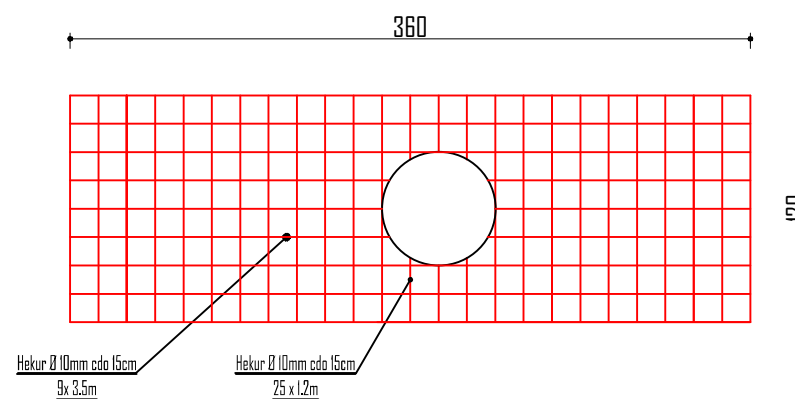

EMERTESA OBJEKTIT: "RIKONSTRUKSIONI I KANALIT VADITES TE ALLANIT (LOTI II-te), FSHATRAT GIZAVESH , DOREZ DHE LIBRAZHD QENDER			
 REPUBLIKA E SHQIPERISE	FAZA E PROJEKTIT :PROJEKT ZBATIMI	Nr. 20	
	EMERTESA E FLETES: PORTAL TIP BETONI PER HYRJE NE TUBACION	SH: 1/50	
 ZENIT&CO	POROSITESI - BASHKIA LIBRAZHD	Dt. _/ _/2024	
	Rruga: Myrteza Topi (Nr 18.zip.code.1007) E-Mail: zenit06@live.com TIRANE-ALBANIA	Mobile phone 069 20 99 065	GRUPI PROJEKTIMIT: ZENIT&CO sh.p.k Inxh.Hidro. Merita MENGRI Ark.Raimonda MYDINLLARI Inxh.Ndert.Rexhep Tarba
		ZENIT&CO	