

**MIRATOHET
BASHKIA DIBËR
KRYETARI**

Z. RAHIM SPAHIU

PROJEKT

Z B A T I M I

OBJEKTI

**SISTEMIM ASFALTIM RRUGA FSHATI BREZHDAN, LAGJA REÇE,
BASHKIA DIBER**

**AUTORITETI
KONTRAKTOR**

BASHKIA DIBËR

KONSULENTI

“ERALD-G” Shpk

VITI 2022

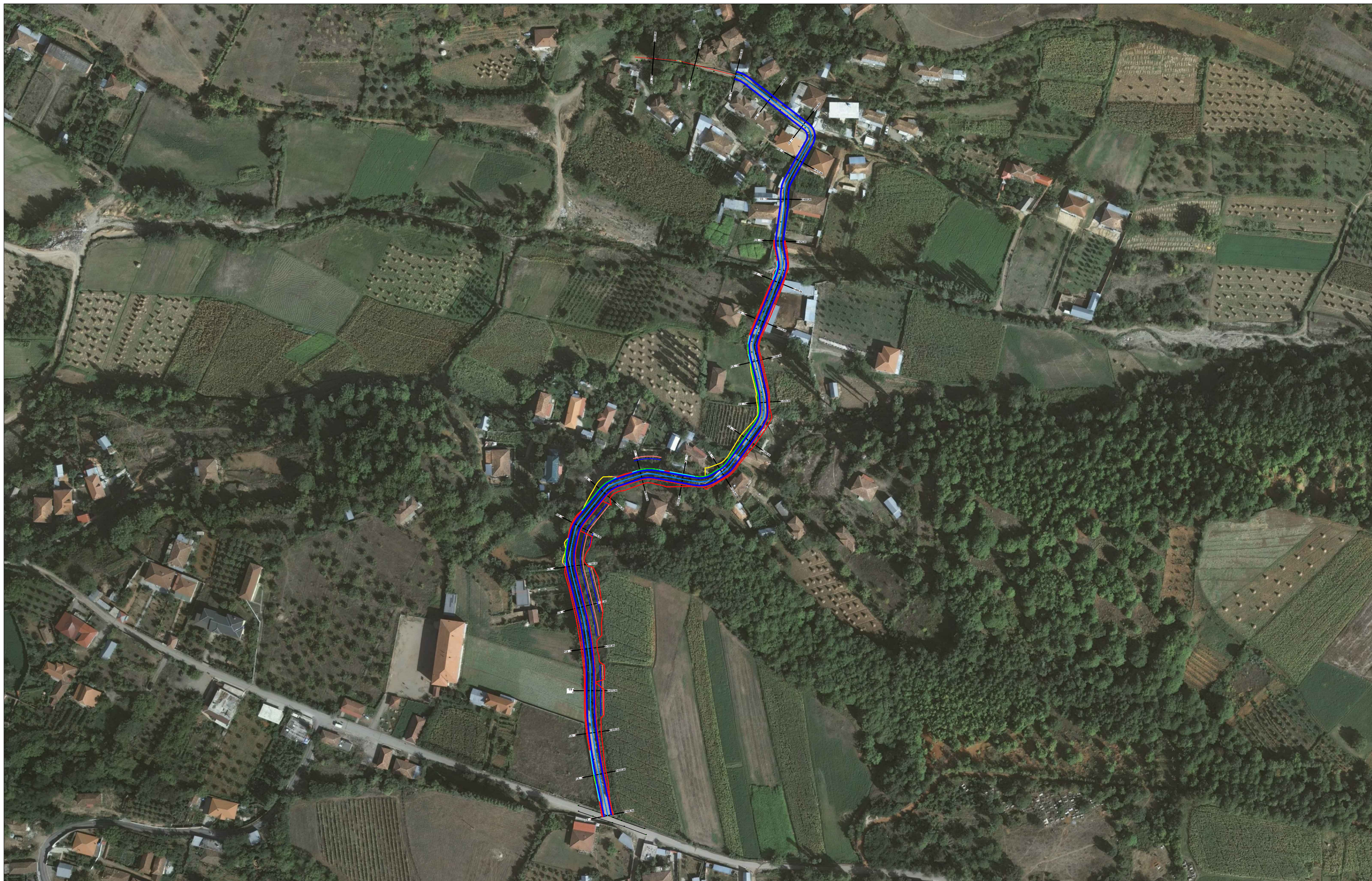

POROSITES : BASHKIA DIBER
SISTEMIM ASFALTIM RRUGA BREZHDAN,LAGJA REÇE

EMERTIMI : HOROGRAFIA

"ERALD-G" sh.p.k
 Rruga "Kongresi i Lushnjes"
 Tirane

DREJTUES PROJEKTI
 Ing.Gezim ISLAMI

PROJEKTUES
 Ing.Erindi GJOKA
 Top.Alfred NDREGJONI
 Top.Kujtim CANAMETI

Hidr.Anisa ZAKA
 Mek.Arben MUHA
 Ing.Eraldo ISLAMI

SHKALLA
 SHK - 1:2000
 TIRANE 2022

FLETA
 1 - 01
 FORMAT A3

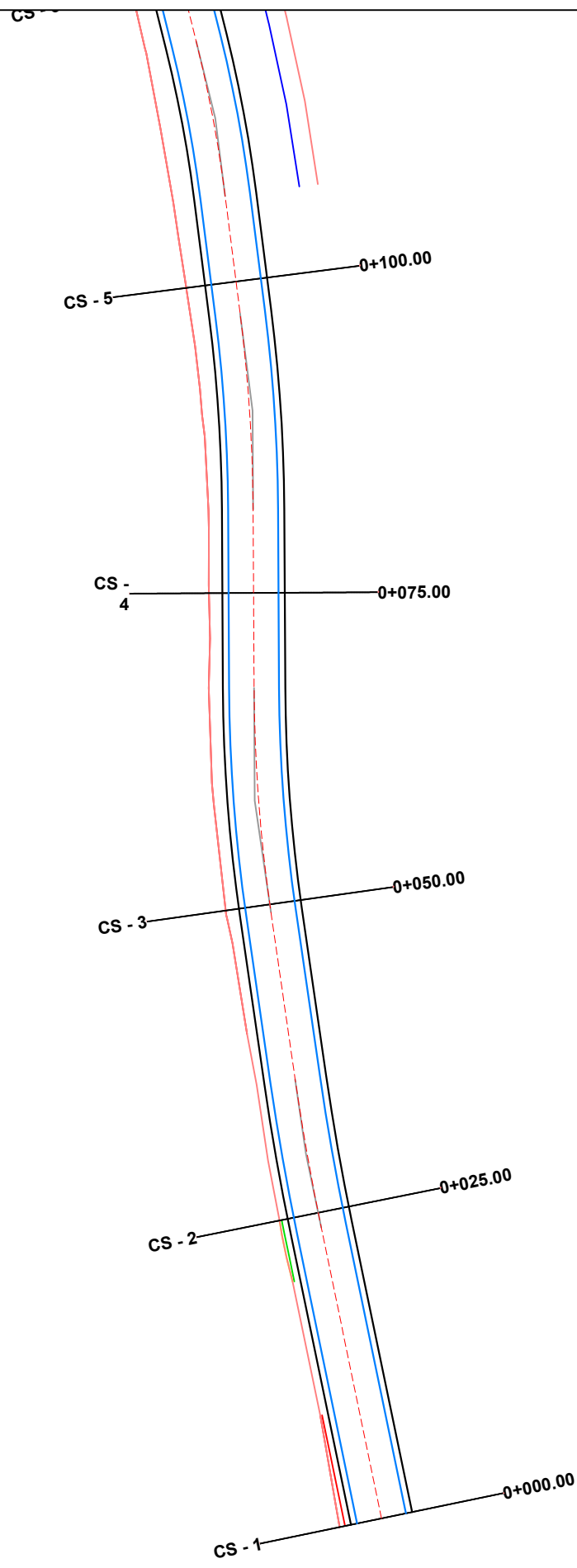

POROSITES : BASHKIA DIBER
SISTEMIM ASFALTIM I RRUGA BREZHDAN, LAGJA REÇE

EMERTIMI : PLANIMETRIA E PËRGJITHSHME



"ERALD-G" sh.p.k
 Rruga "Kongresi i Lushnjes"
 Tirane

DREJTUES PROJEKTI
 Ing.Gezim ISLAMI

PROJEKTUES	
Ing.Erindi GJOKA	Hidr.Anisa ZAKA
Top.Alfred NDREGJONI	Mek.Arben MUHA
Top.Kujtim CANAMETI	Ing.Eraldo ISLAMI

SHKALLA	FLETA
SHK - 1:500	2 - 01
TIRANE 2022	FORMAT A3

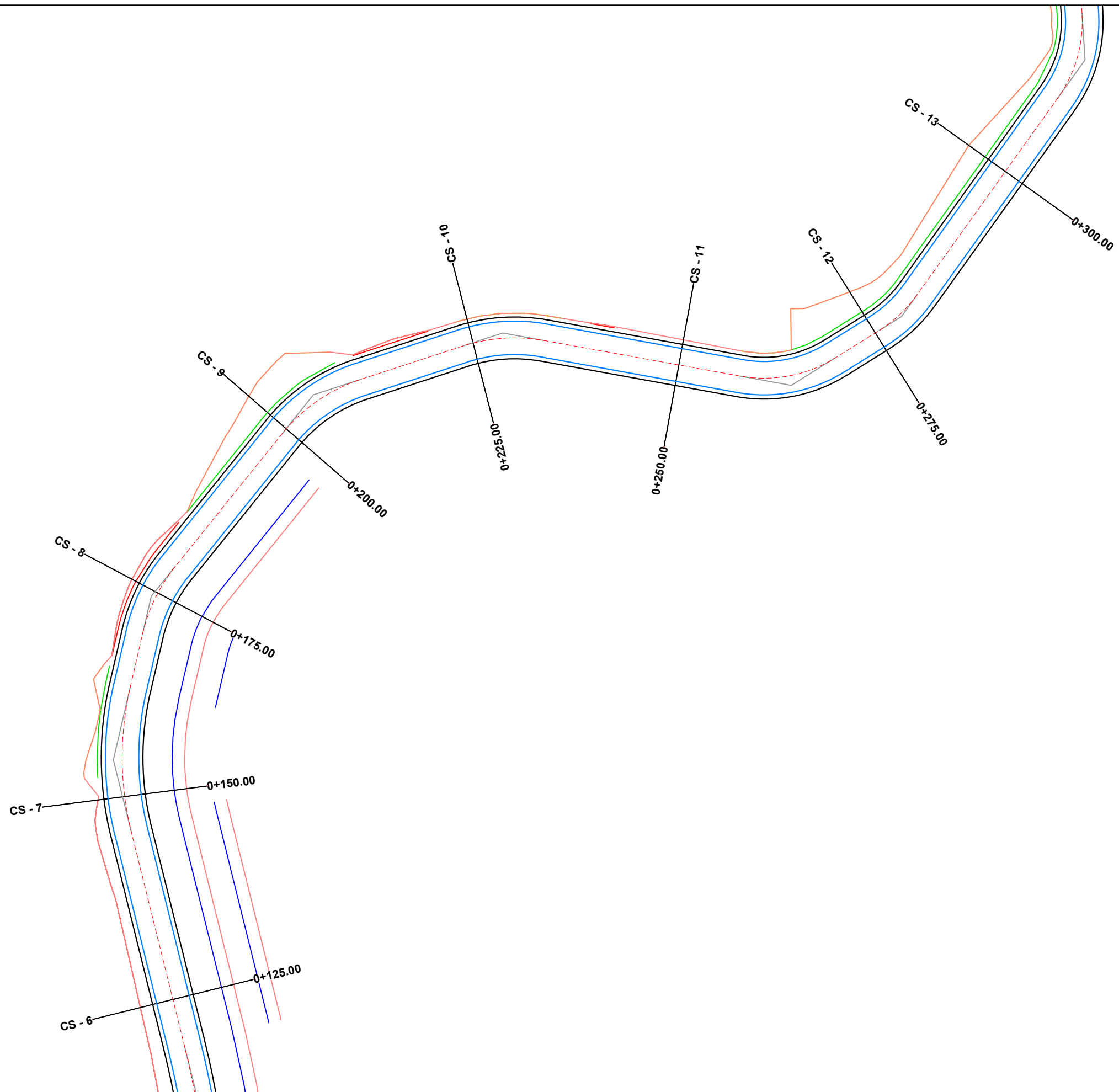

POROSITES : BASHKIA DIBER
 SISTEMIM ASFALTIM I RRUGA BREZHDAN, LAGJA REÇE

EMERTIMI : PLANIMETRIA E PËRGJITHSHME
 "ERALD-G" sh.p.k
 Rruga "Kongresi i Lushnjes"
 Tirane

DREJTUES PROJEKTI
 Ing.Gezim ISLAMI

PROJEKTUES
 Ing.Erindi GJOKA
 Hidr.Anisa ZAKA
 Top.Alfred NDREGJONI
 Mek.Arben MUHA
 Top.Kujtim CANAMETI
 Ing.Eraldo ISLAMI

SHKALLA	FLETA
SHK - 1:500	2 - 02
TIRANE 2022	FORMAT A3

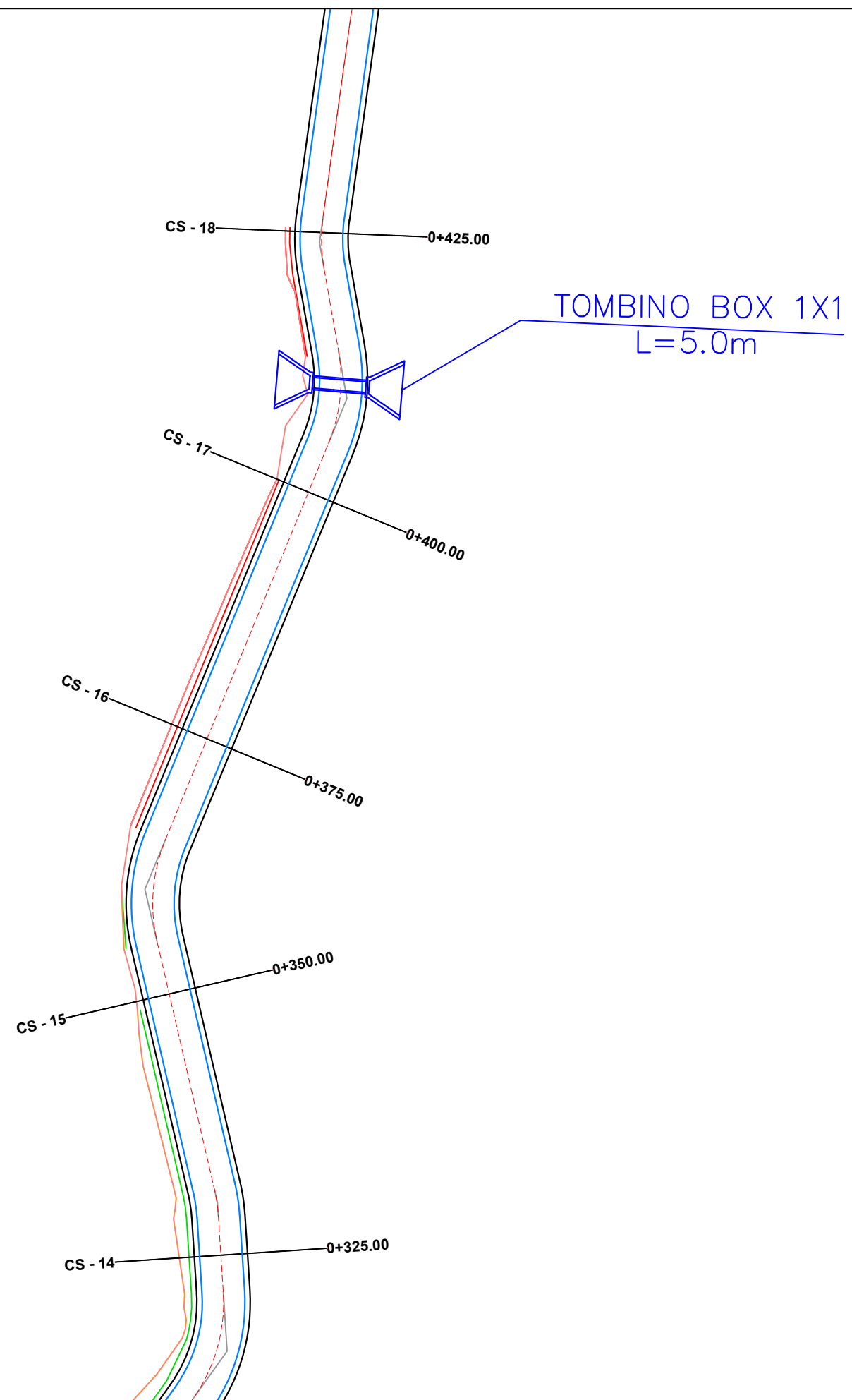

POROSITES : BASHKIA DIBER
 SISTEMIM ASFALTIM I RRUGA BREZHDAN, LAGJA REÇE

EMERTIMI : PLANIMETRIA E PËRGJITHSHME
 "ERALD-G" sh.p.k
 Rruga "Kongresi i Lushnjes"
 Tirane

DREJTUES PROJEKTI
 Ing.Gezim ISLAMI

PROJEKTUES
 Ing.Erindi GJOKA Hidr.Anisa ZAKA
 Top.Alfred NDREGJONI Mek.Arben MUHA
 Top.Kujtim CANAMETI Ing.Eraldo ISLAMI

SHKALLA	FLETA
SHK - 1:500	2 - 03
TIRANE 2022	FORMAT A3

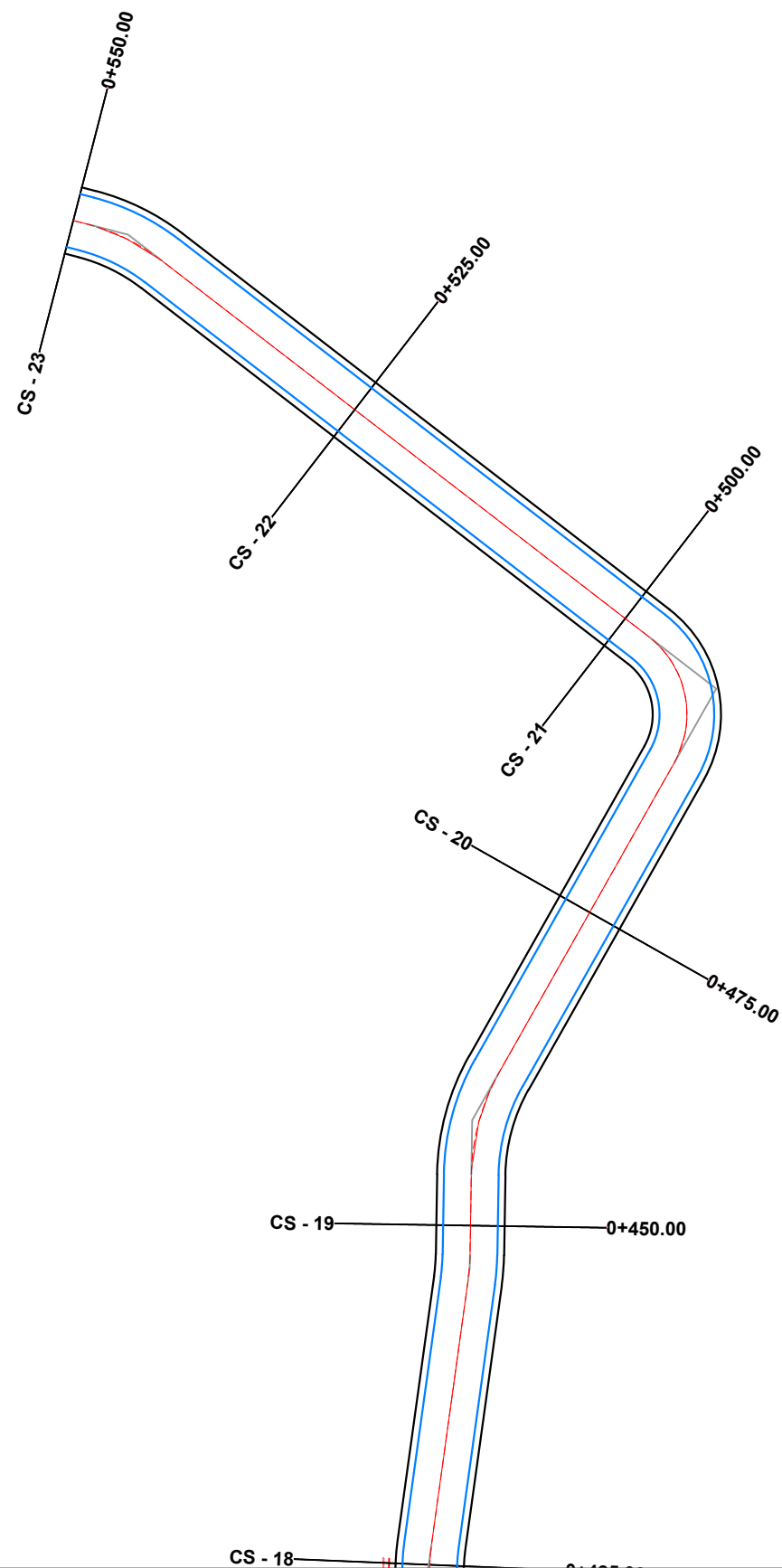

POROSITES : BASHKIA DIBER
 SISTEMIM ASFALTIM I RRUGA BREZHDAN, LAGJA REÇE

EMERTIMI : PLANIMETRIA E PËRGJITHSHME
 "ERALD-G" sh.p.k
 Rruga "Kongresi i Lushnjes"
 Tirane

DREJTUES PROJEKTI
 Ing.Gezim ISLAMI

PROJEKTUES	
Ing.Erindi GJOKA	Hidr.Anisa ZAKA
Top.Alfred NDREGJONI	Mek.Arben MUHA
Top.Kujtim CANAMETI	Ing.Eraldo ISLAMI

SHKALLA	FLETA
SHK - 1:500	2 - 04
TIRANE 2022	FORMAT A3

Gjeometria Horizontale	0+000	0+024	0+056	0+049	0+067	0+082	0+097	0+107	0+120	0+146	0+163	0+170	0+179	0+199	0+224	0+234	0+257
Nr.Verteksi		V-1		V-2		V-3		V-4		V-5		V-6		V-7		V-8	

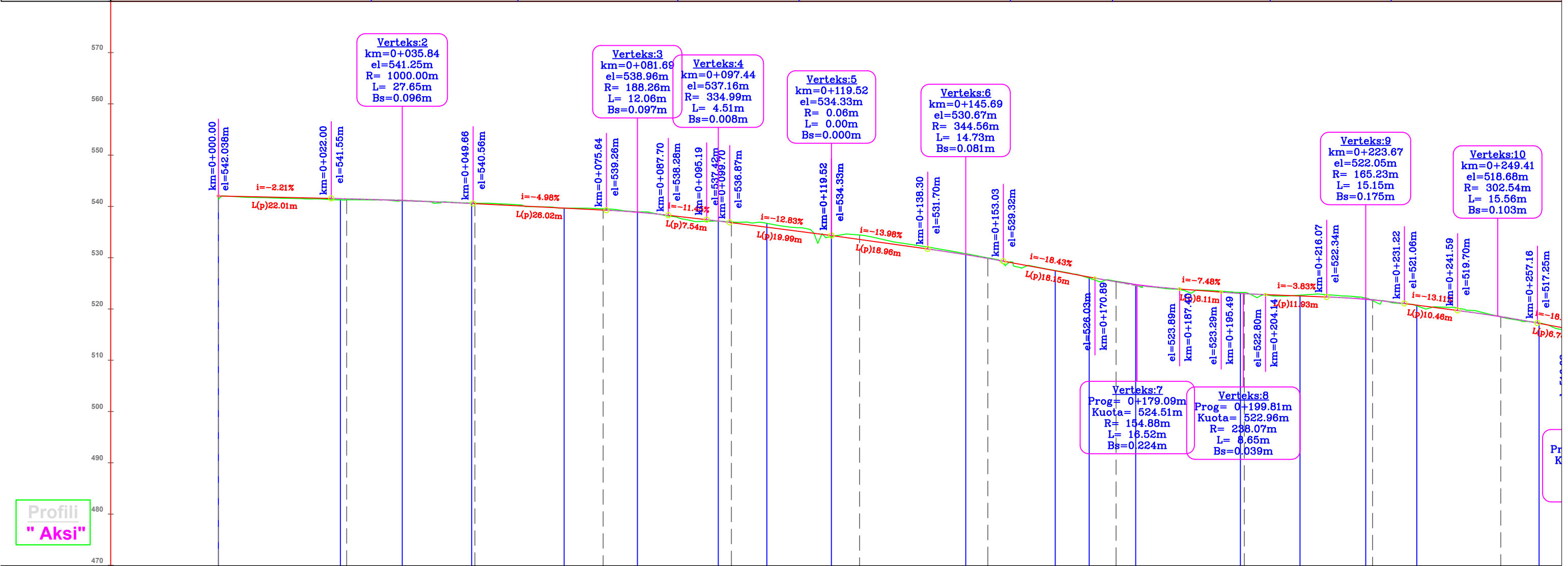

CS-NR.	CS-1	CS-2	CS-3	CS-4	CS-5	CS-6	CS-7	CS-8	CS-9	CS-10	CS-11								
Distanca																			
Pjesore	25	25	25	25	25	25	25	25	25	25	25								
Progresive	0+000	0+025	0+050	0+075	0+100	0+125	0+150	0+175	0+200	0+225	0+250								
Kuota																			
Terreni	-541.38	-541.29	-540.65	-539.54	-536.98	-534.42	-529.96	-525.42	-523.21	-521.63	-518.45								
Projektit	-542.04	-541.48	-540.54	-539.30	-536.83	-533.56	-529.86	-525.32	-522.99	-521.76	-518.48								
Punes	0.66	0.20	-0.11	-0.24	-0.15	-0.86	-0.10	-0.09	-0.22	0.13	0.03								
Gjeometria Vertikale	L=22.00m i=-2.21%	R=1000.0m K=10.0m	L=25.98m i=-4.98%	R=188.3m K=1.9m	L=7.45m i=-11.45%	R=335.0m K=3.3m	L=19.83m i=-12.83%	R=0.1m K=0.0m	L=18.78m i=-13.98%	R=344.6m K=3.3m	L=17.85m i=-18.43%	R=154.9m K=1.5m	L=8.09m i=-7.48%	R=238.1m K=2.4m	L=11.93m i=-3.83%	R=165.2m K=1.6m	L=10.37m i=-13.11%	R=302.5m K=2.9m	L=6.6m i=-18.43%

POROSITES : BASHKIA DIBER
 SISTEMIM ASFALTIM I RRUGA BREZHDAN, LAGJA REÇE

EMERTIMI : PROFILI GJATESOR
 "ERALD-G" sh.p.k
 Rruga "Kongresi i Lushnjes"
 Tirane

DREJTUES PROJEKTI	PROJEKTUES	
Ing.Gezim ISLAMI	Ing.Erindi GJOKA	Hidr.Anisa ZAKA
	Top.Alfred NDREGJONI	Mek.Arben MUHA
	Top.Kujtim CANAMETI	Ing.Eraldo ISLAMI

SHKALLA	FLETA
1 : 750	3 - 01
TIRANE 2022	FORMAT A3

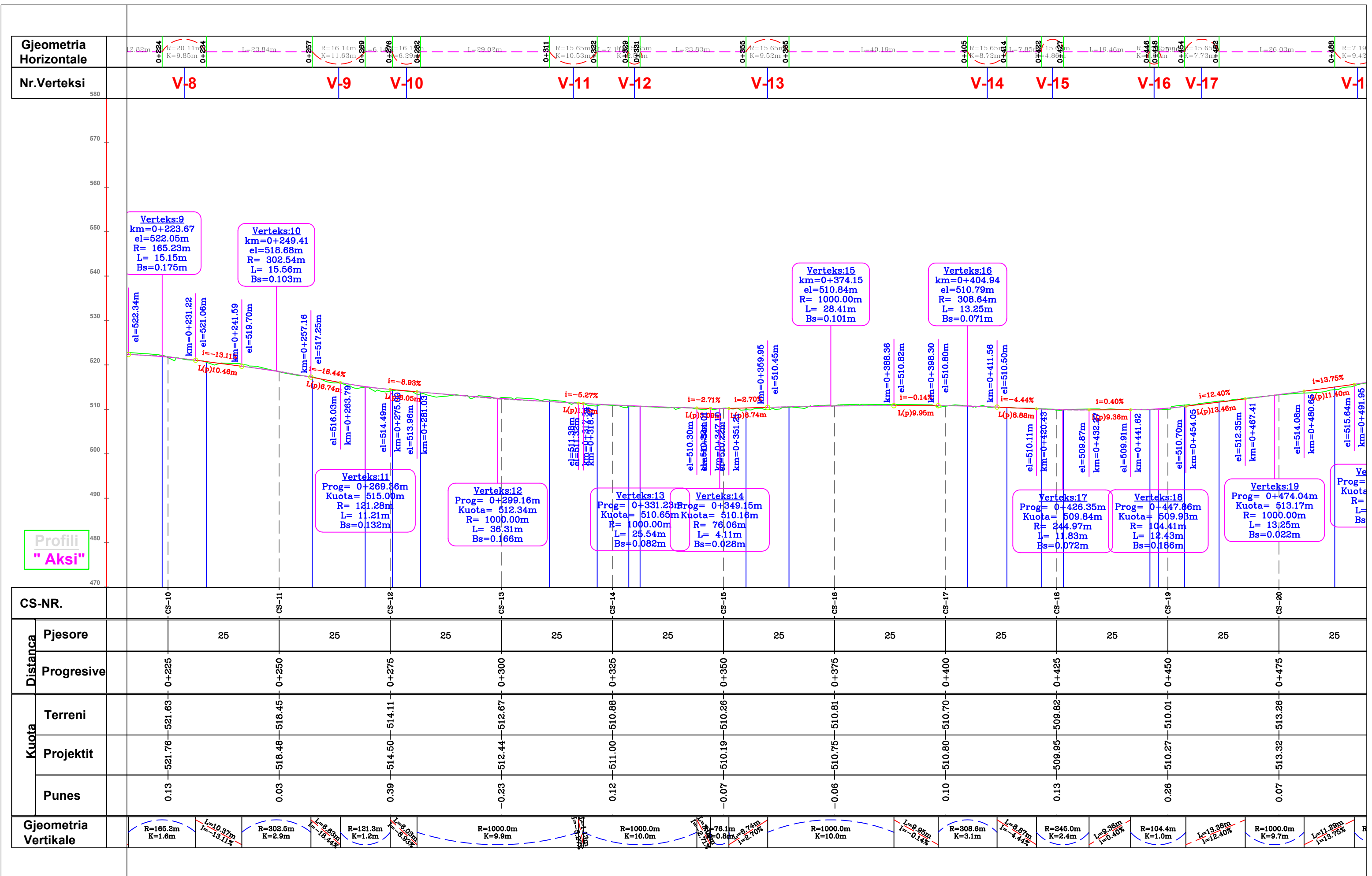

Profili
"Aksi"

POROSITES : BASHKIA DIBER
SISTEMIM ASFALTIM I RRUGA BREZHDAN, LAGJA REÇE

EMERTIMI : PROFILI GJATESOR
"ERALD-G" sh.p.k
Rruga "Kongresi i Lushnjes"
Tirane

DREJTUES PROJEKTI
Ing.Gezim ISLAMI

PROJEKTUES
Ing.Erindi GJOKA
Hidr.Anisa ZAKA
Top.Alfred NDREGJONI
Mek.Arben MUHA
Top.Kujtim CANAMETI
Ing.Eraldo ISLAMI

SHKALLA
1 : 750
TIRANE 2022

FLETA
3 - 02
FORMAT A3

Gjeometria Horizontale														
Nr.Verteksi	V-14		V-15		V-16		V-17		V-18		V-19		V-20	

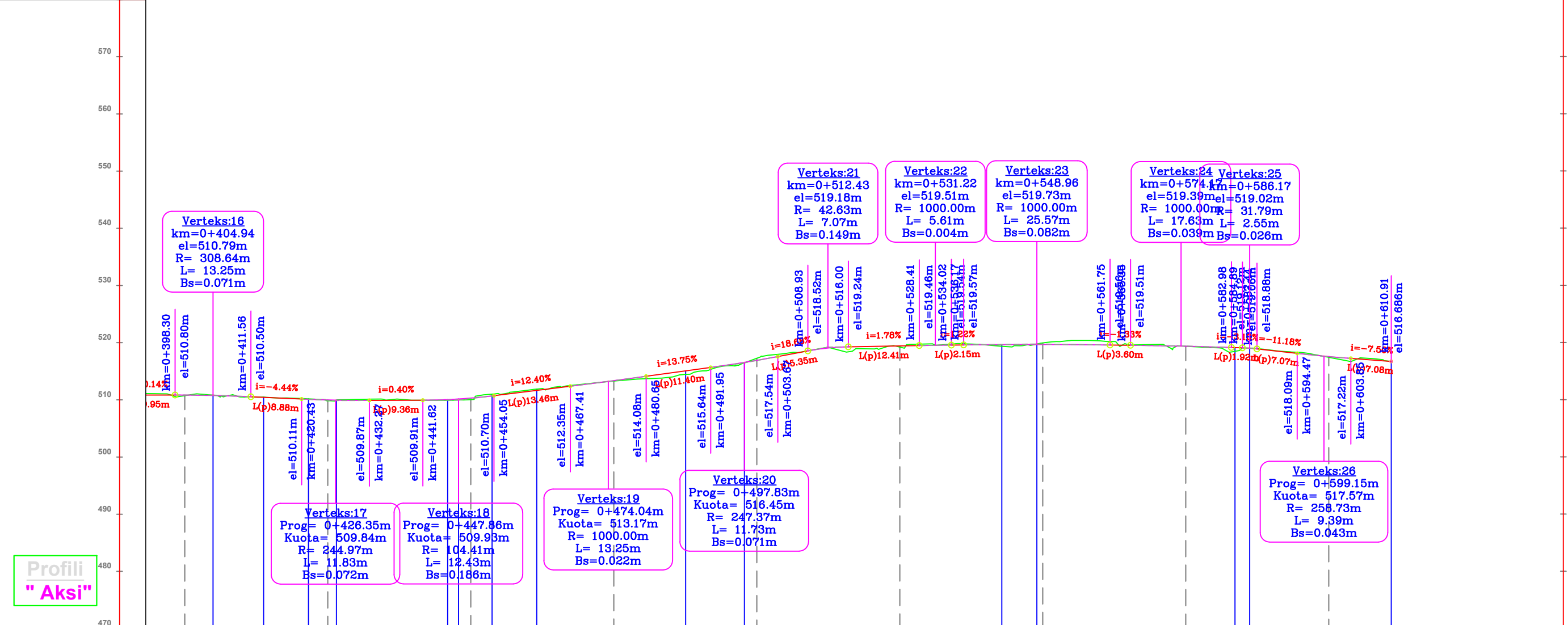

CS-NR.	CS-17	CS-18	CS-19	CS-20	CS-21	CS-22	CS-23	CS-24	CS-25	
Distanca	Pjesore									
Distanca	Progressive									
Kuota	Terreni									
Kuota	Projektit									
Kuota	Punes									

Gjeometria Vertikale										
-----------------------------	--	--	--	--	--	--	--	--	--	--

POROSITES : BASHKIA DIBER

SISTEMIM ASFALTIM I RRUGA BREZH DAN, LAGJA REÇE

EMERTIMI : PROFILI GJATESOR

"ERALD-G" sh.p.k

Rruga "Kongresi i Lushnjes" Tirane

DREJTUES PROJEKTI	PROJEKTUES	
Ing.Gezim ISLAMI	Ing.Erindi GJOKA	Hidr.Anisa ZAKA
	Top.Alfred NDREGJONI	Mek.Arben MUHA
	Top.Kujtim CANAMETI	Ing.Eraldo ISLAMI

SHKALLA	FLETA
1 : 750	3 - 03
TIRANE 2022	FORMAT A3

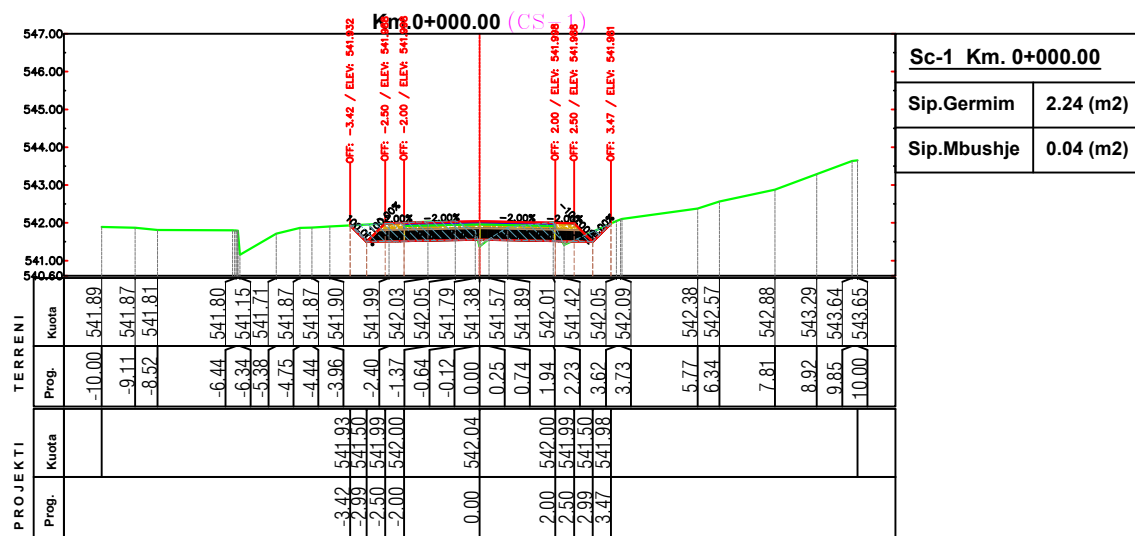

Sc-1 Km. 0+000.00	
Sip.Germim	2.24 (m2)
Sip.Mbushje	0.04 (m2)

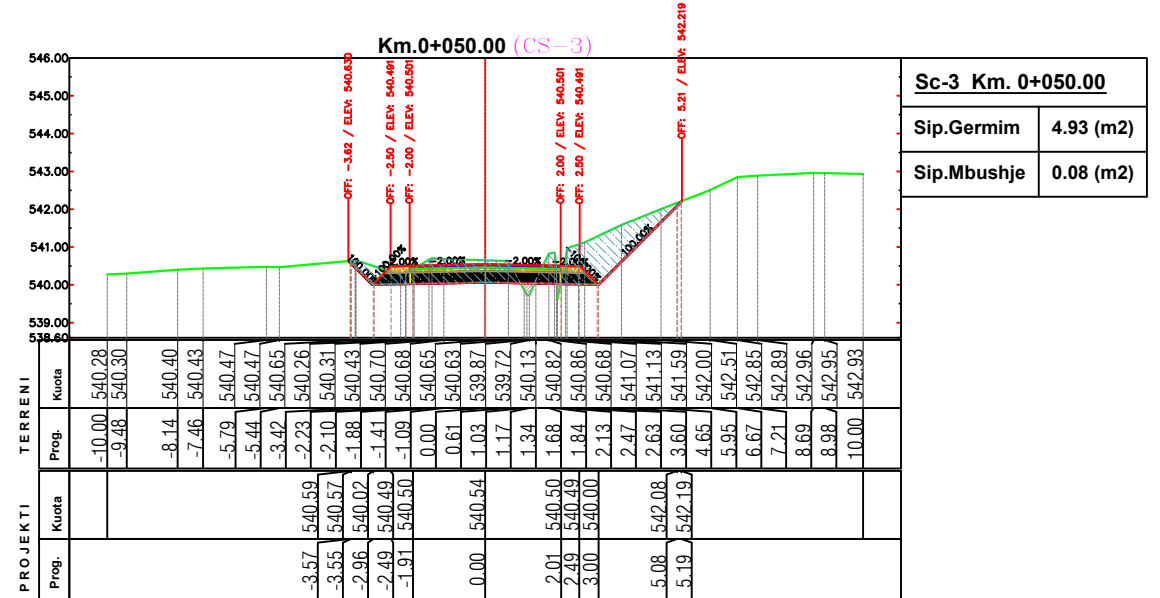

Sc-3 Km. 0+050.00	
Sip.Germim	4.93 (m2)
Sip.Mbushje	0.08 (m2)

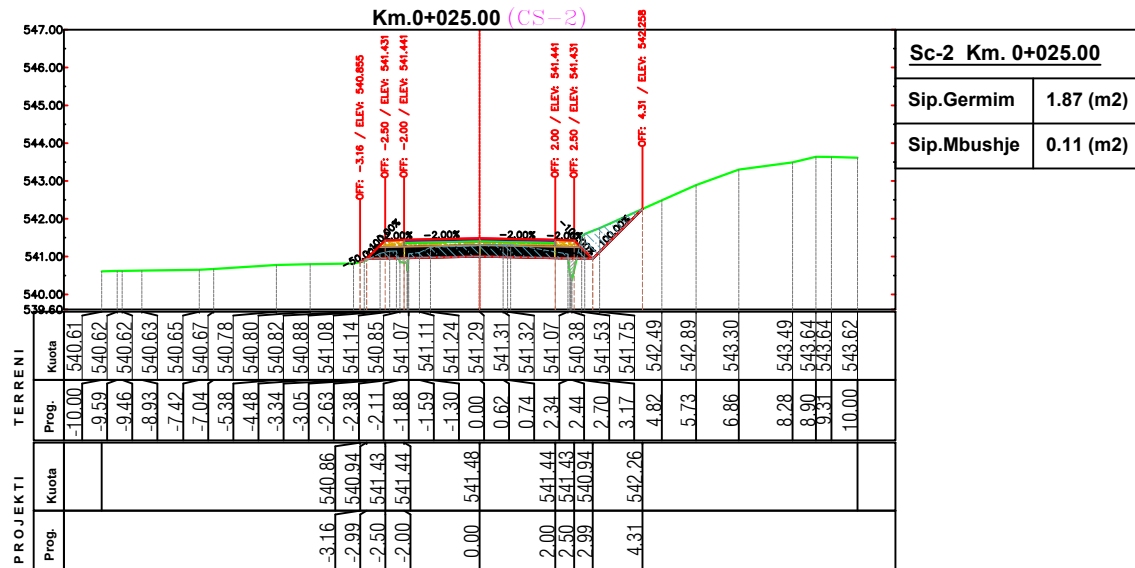

Sc-2 Km. 0+025.00	
Sip.Germim	1.87 (m2)
Sip.Mbushje	0.11 (m2)

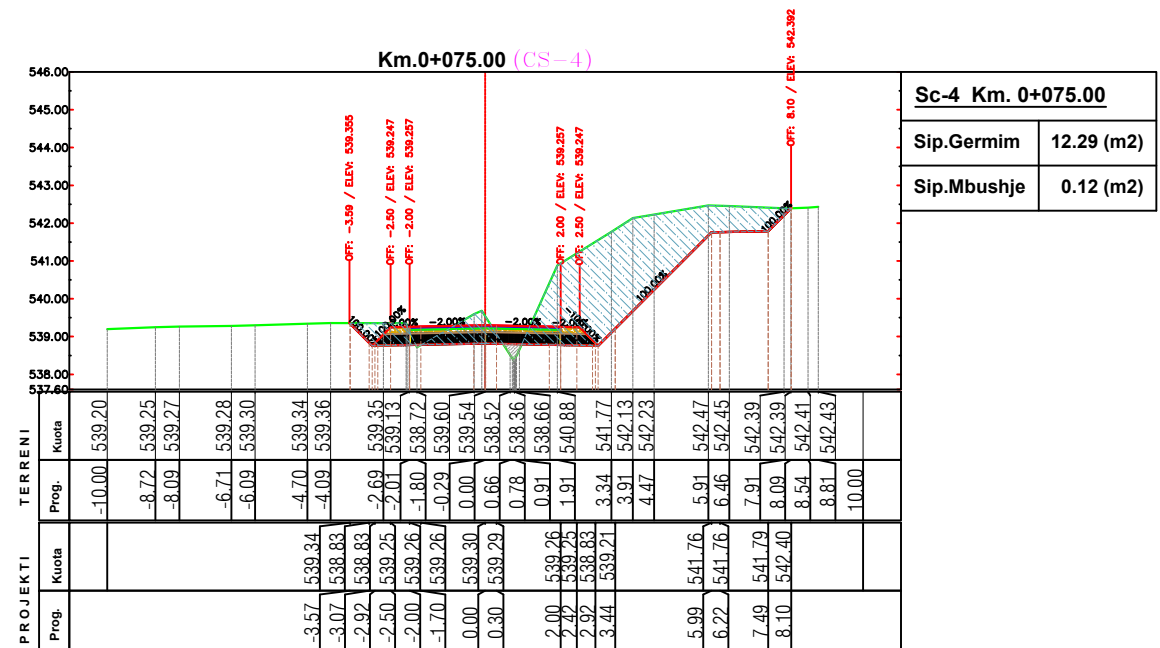

Sc-4 Km. 0+075.00	
Sip.Germim	12.29 (m2)
Sip.Mbushje	0.12 (m2)

POROSITES : BASHKIA DIBER
SISTEMIM ASFALTIM I RRUGA BREZHDAN, LAGJA REÇE

EMERTIMI : PROFILAT TERTHORE
 "ERALD-G" sh.p.k
 Rruga "Kongresi i Lushnjes"
 Tirane



DREJTUES PROJEKTI
 Ing.Gezim ISLAMI

PROJEKTUES
 Ing.Erindi GJOKA
 Hidr.Anisa ZAKA
 Top.Alfred NDREGJONI
 Mek.Arben MUHA
 Top.Kujtim CANAMETI
 Ing.Eraldo ISLAMI

SHKALLA
 SHK - 1:200
 TIRANE 2022

FLETA
 4 - 01
 FORMAT A3

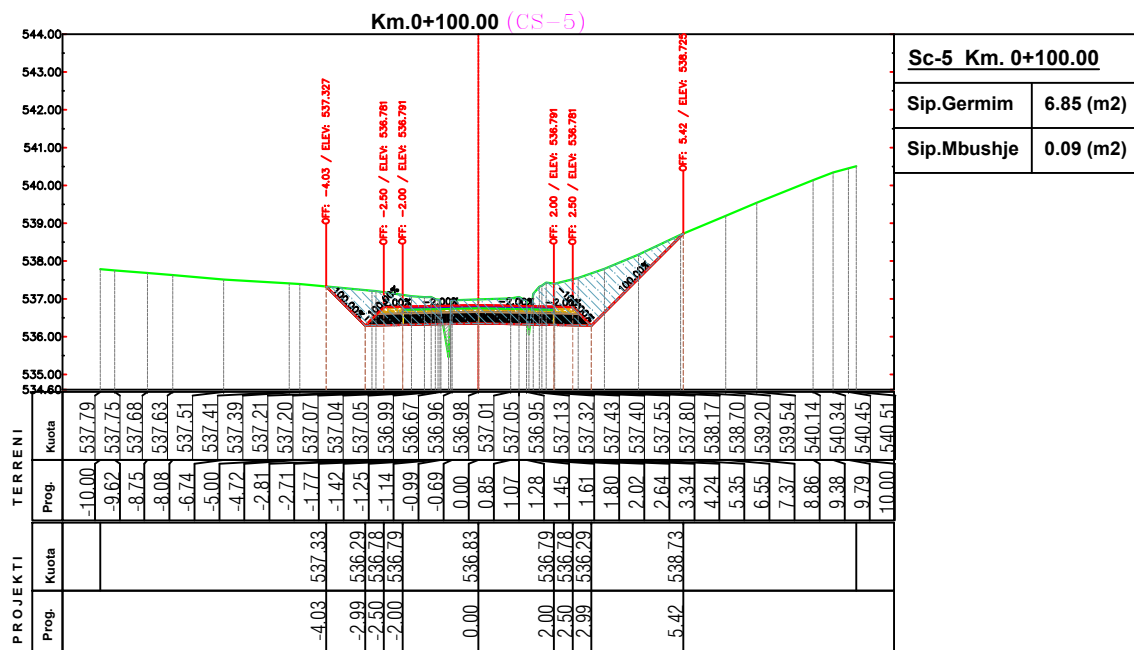

Sc-5 Km. 0+100.00	
Sip.Germim	6.85 (m2)
Sip.Mbushje	0.09 (m2)

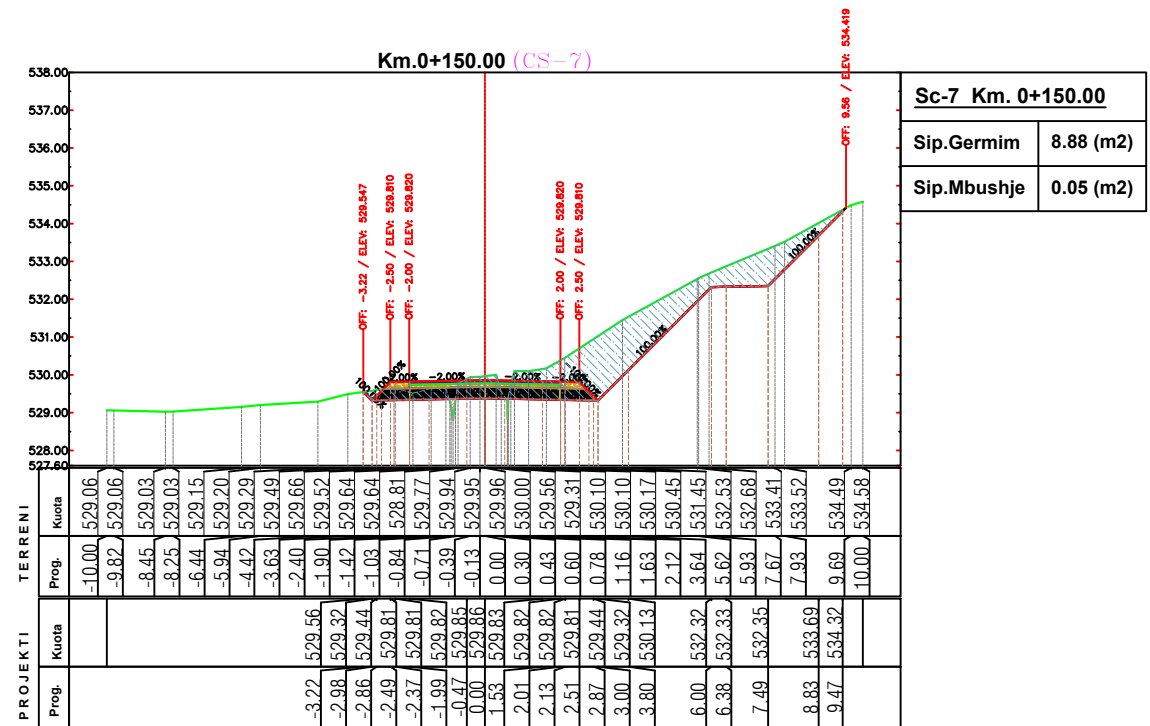

Sc-7 Km. 0+150.00	
Sip.Germim	8.88 (m2)
Sip.Mbushje	0.05 (m2)

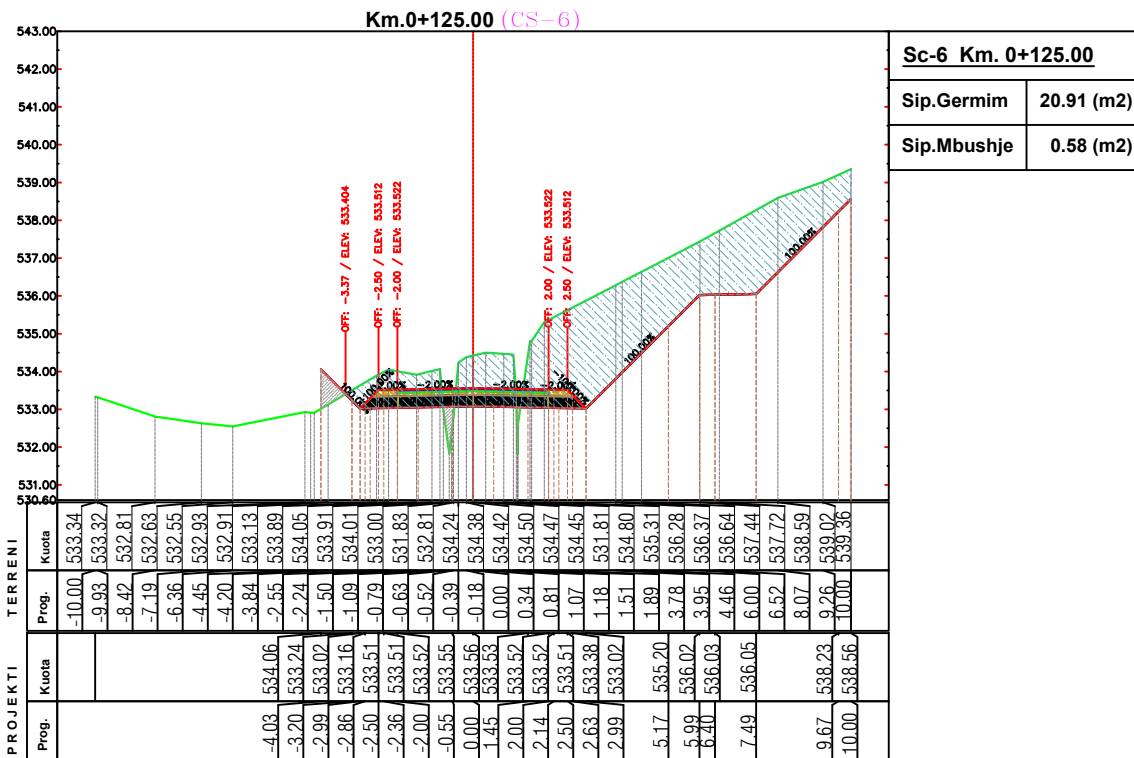

Sc-6 Km. 0+125.00	
Sip.Germim	20.91 (m2)
Sip.Mbushje	0.58 (m2)

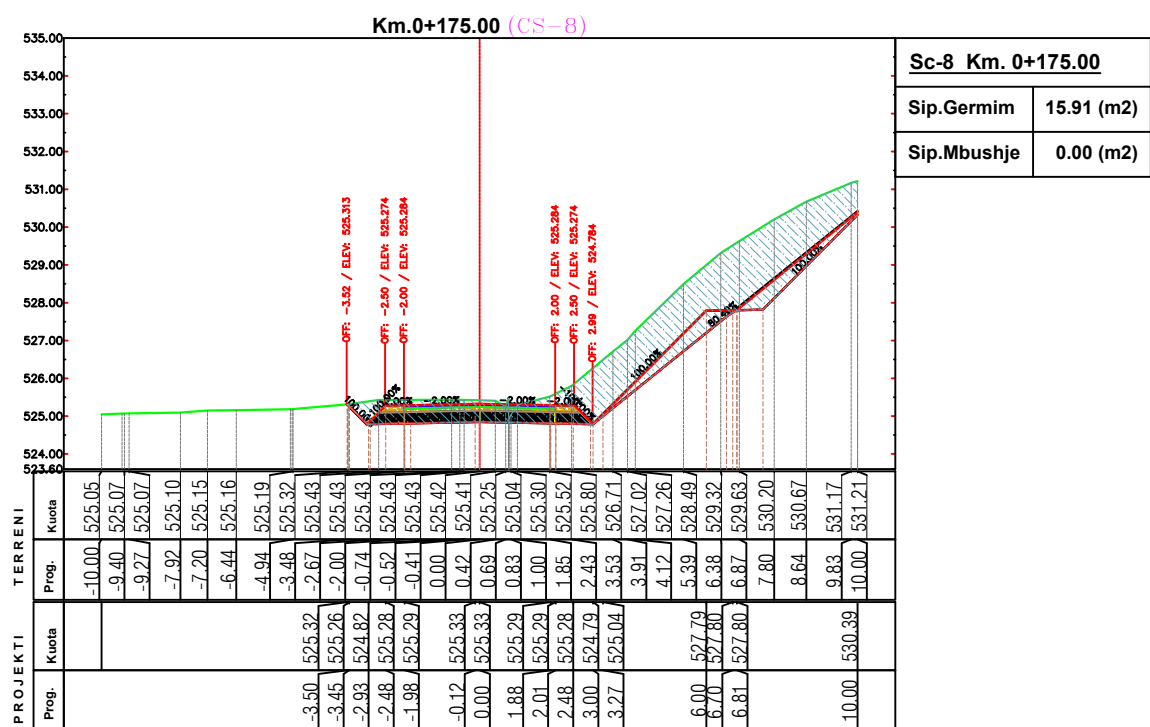

Sc-8 Km. 0+175.00	
Sip.Germim	15.91 (m2)
Sip.Mbushje	0.00 (m2)

POROSITES : BASHKIA DIBER
SISTEMIM ASFALTIM I RRUGA BREZH DAN, LAGJA REÇE

EMERTIMI : PROFILAT TERTHORE
 "ERALD-G" sh.p.k
 Rruga "Kongresi i Lushnjes"
 Tirane

DREJTUES PROJEKTI
 Ing.Gezim ISLAMI

PROJEKTUES
 Ing.Erindi GJOKA
 Hidr.Anisa ZAKA
 Top.Alfred NDREGJONI
 Mek.Arben MUHA
 Top.Kujtim CANAMETI
 Ing.Eraldo ISLAMI

SHKALLA
 SHK - 1:200
 TIRANE 2022

FLETA
 4 - 02
 FORMAT A3

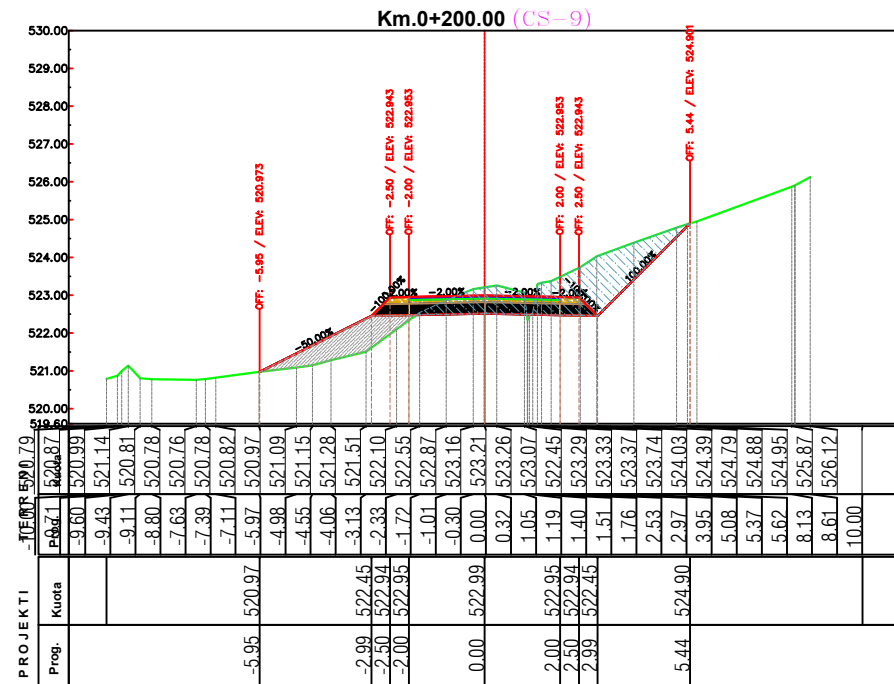

Sc-9 Km. 0+200.00	
Sip.Germim	5.29 (m2)
Sip.Mbushje	1.98 (m2)

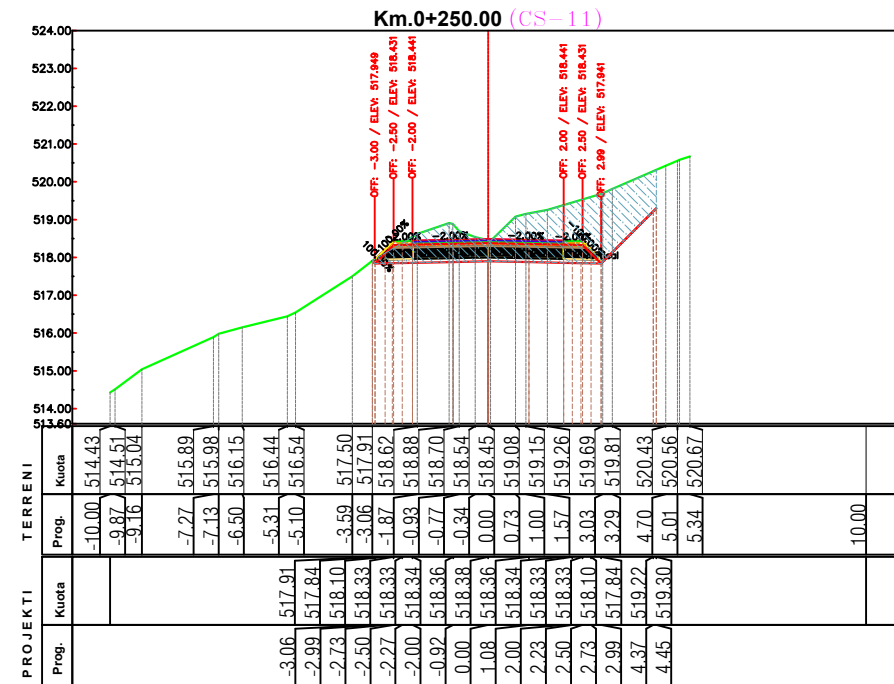

Sc-11 Km. 0+250.00	
Sip.Germim	8.12 (m2)
Sip.Mbushje	0.00 (m2)

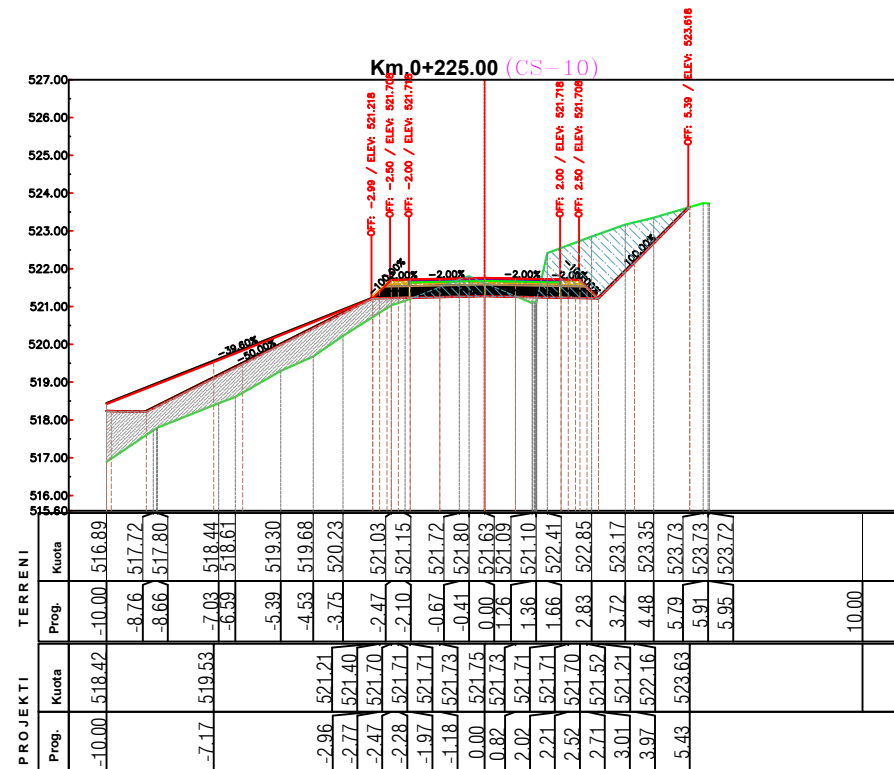

Sc-10 Km. 0+225.00	
Sip.Germim	4.95 (m2)
Sip.Mbushje	5.29 (m2)

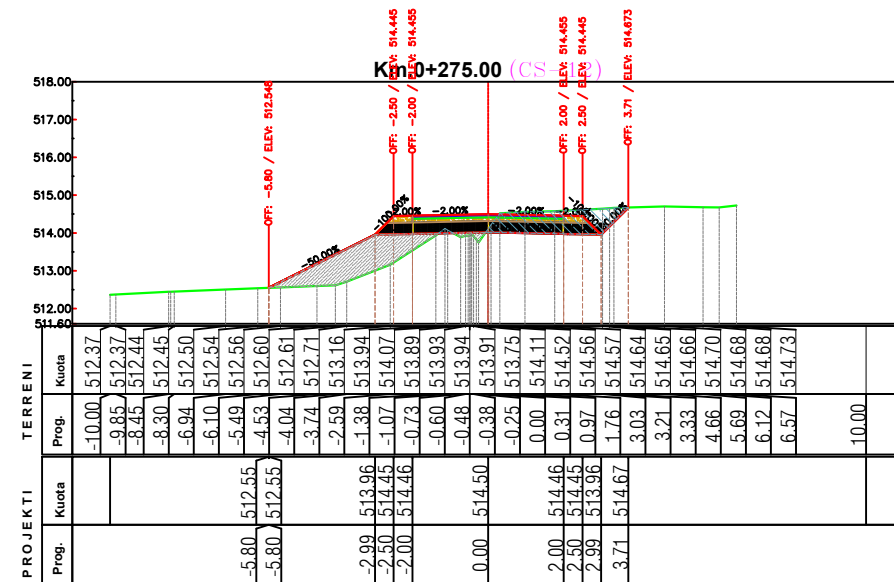

Sc-12 Km. 0+275.00	
Sip.Germim	1.96 (m2)
Sip.Mbushje	2.61 (m2)

POROSITES : BASHKIA DIBER
SISTEMIM ASFALTIM I RRUGA BREZHDAN, LAGJA REÇE

EMERTIMI : PROFILAT TERTHORE
 "ERALD-G" sh.p.k
 Rruga "Kongresi i Lushnjes"
 Tirane



DREJTUES PROJEKTI	PROJEKTUES		SHKALLA	FLETA
Ing.Gezim ISLAMI	Ing.Erindi GJOKA	Hidr.Anisa ZAKA	SHK - 1:200	4 - 03
	Top.Alfred NDREGJONI	Mek.Arben MUHA		
	Top.Kujtim CANAMETI	Ing.Eraldo ISLAMI	TIRANE 2022	FORMAT A3

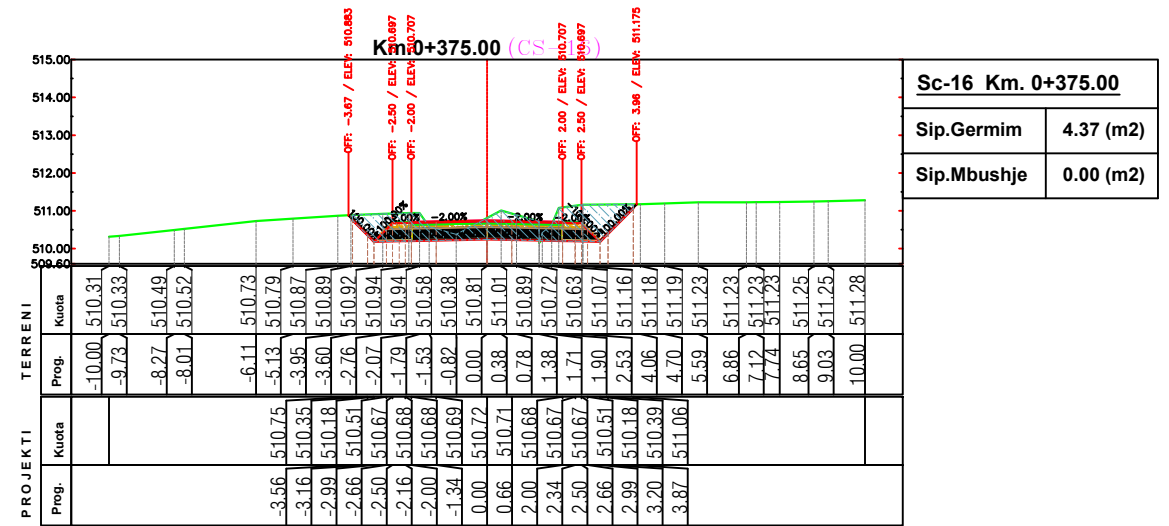
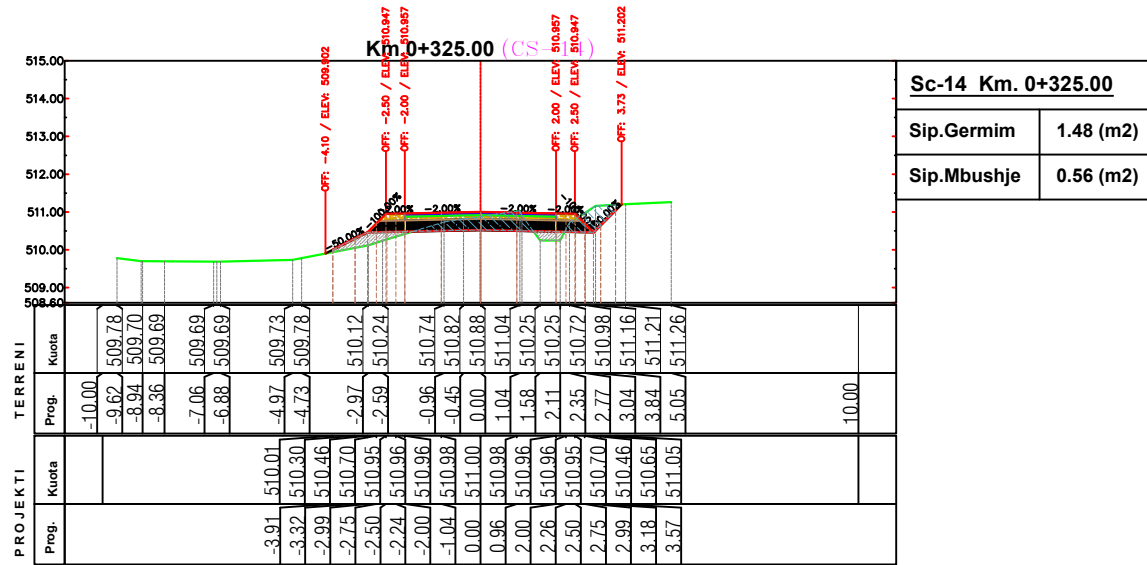
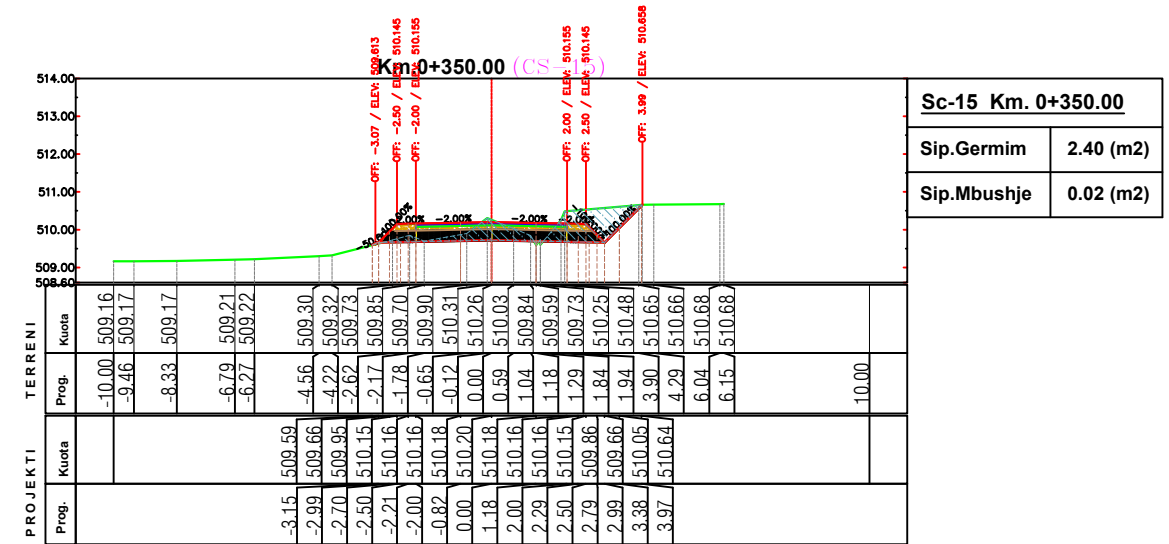
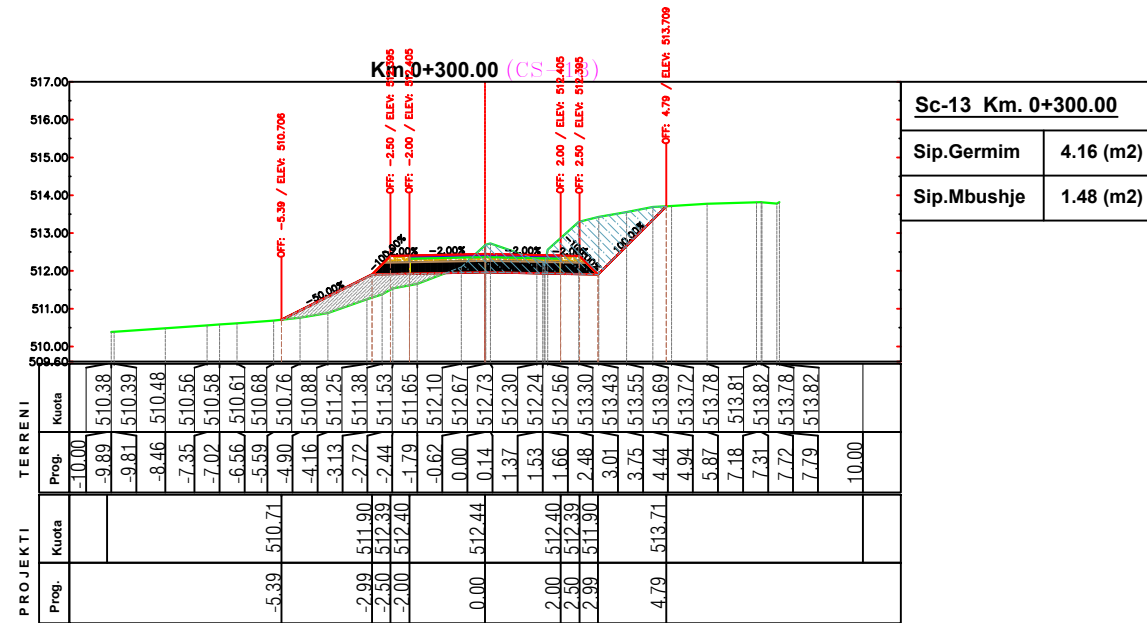

POROSITES : BASHKIA DIBER
 SISTEMIM ASFALTIM I RRUGA BREZHDAN, LAGJA REÇE

EMERTIMI : PROFILAT TERTHORE

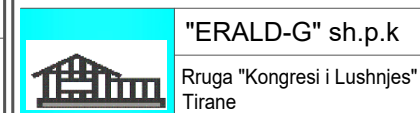

DREJTUES PROJEKTI

Ing.Gezim ISLAMI

PROJEKTUES

Ing.Erindi GJOKA
 Hidr.Anisa ZAKA
 Top.Alfred NDREGJONI
 Mek.Arben MUHA
 Top.Kujtim CANAMETI
 Ing.Eraldo ISLAMI

SHKALLA

SHK - 1:200

TIRANE 2022

FLETA

4 - 04

FORMAT A3

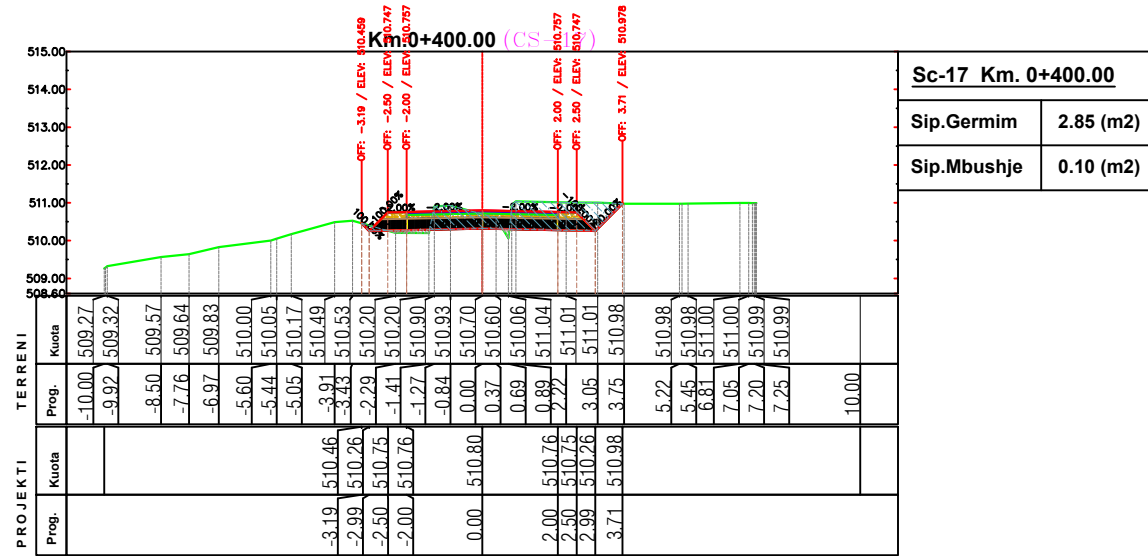

Sc-17 Km. 0+400.00	
Sip.Germim	2.85 (m2)
Sip.Mbushje	0.10 (m2)

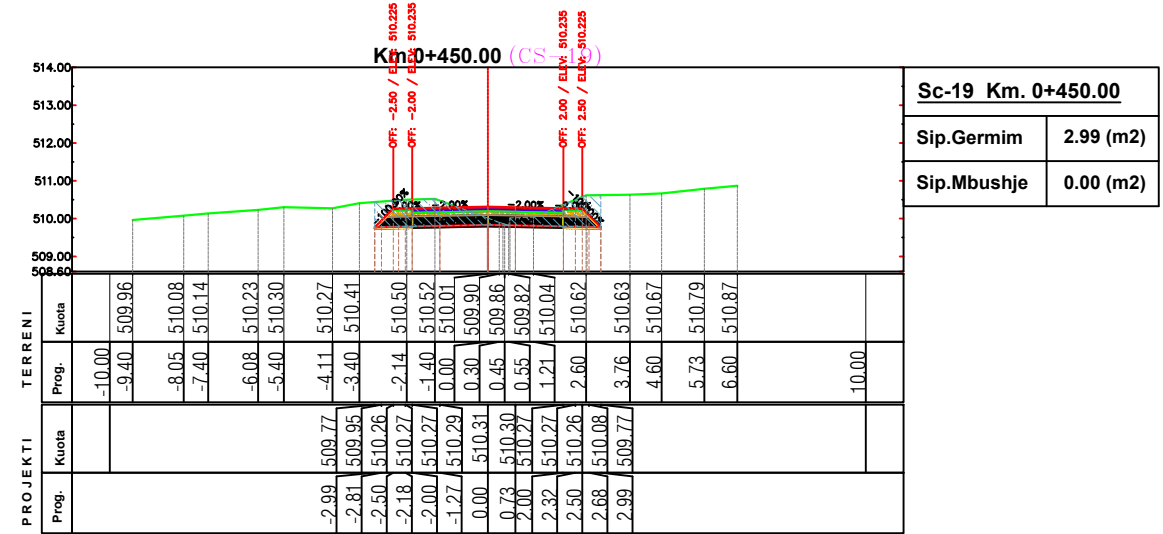

Sc-19 Km. 0+450.00	
Sip.Germim	2.99 (m2)
Sip.Mbushje	0.00 (m2)

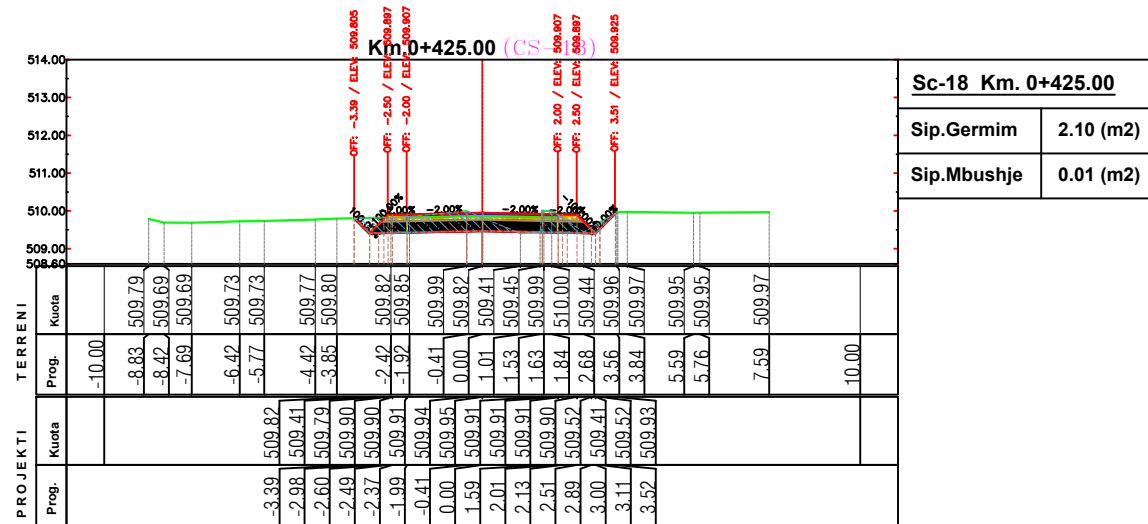

Sc-18 Km. 0+425.00	
Sip.Germim	2.10 (m2)
Sip.Mbushje	0.01 (m2)

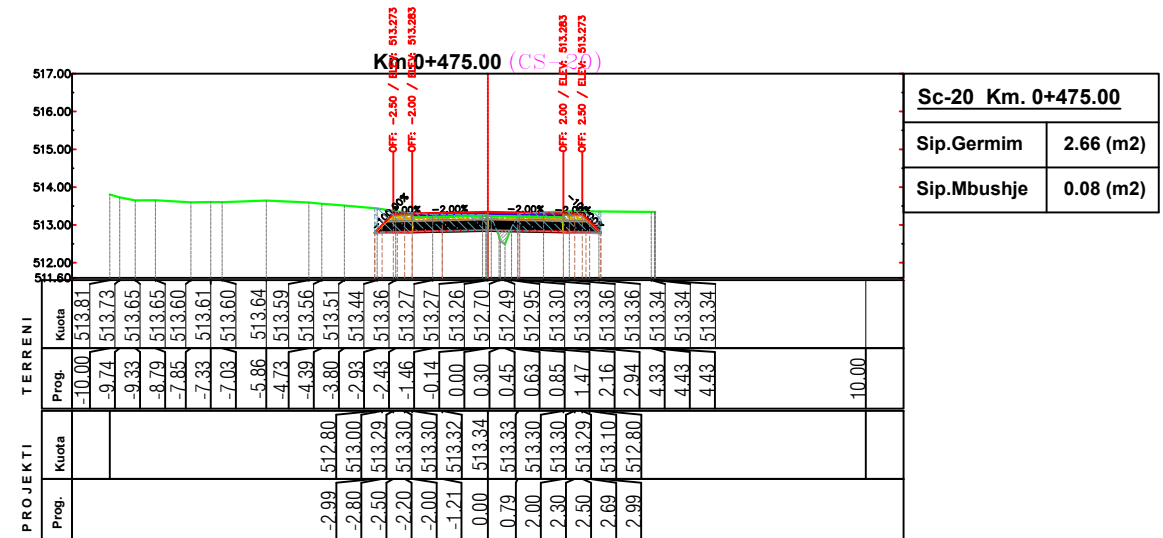

Sc-20 Km. 0+475.00	
Sip.Germim	2.66 (m2)
Sip.Mbushje	0.08 (m2)

POROSITES : BASHKIA DIBER
 SISTEMIM ASFALTIM I RRUGA BREZHDAN, LAGJA REÇE

EMERTIMI : PROFILAT TERTHORE
 "ERALD-G" sh.p.k
 Rruga "Kongresi i Lushnjes"
 Tirane

DREJTUES PROJEKTI	PROJEKTUES	
Ing.Gezim ISLAMI	Ing.Erindi GJOKA	Hidr.Anisa ZAKA
	Top.Alfred NDREGJONI	Mek.Arben MUHA
	Top.Kujtim CANAMETI	Ing.Eraldo ISLAMI

SHKALLA	FLETA
SHK - 1:200	4 - 05
TIRANE 2022	FORMAT A3

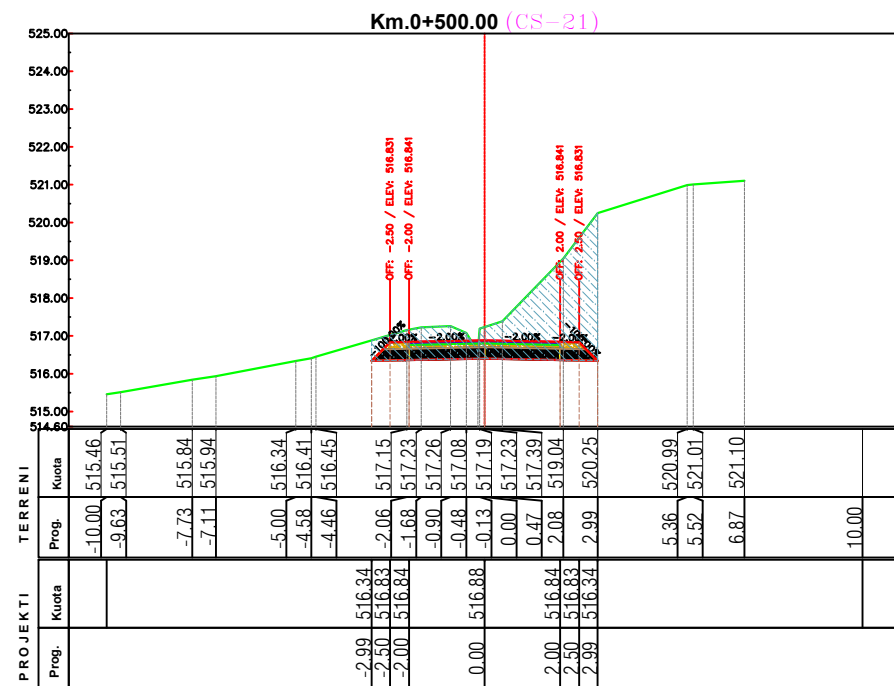

Sc-21 Km. 0+500.00	
Sip.Germim	8.59 (m2)
Sip.Mbushje	0.00 (m2)

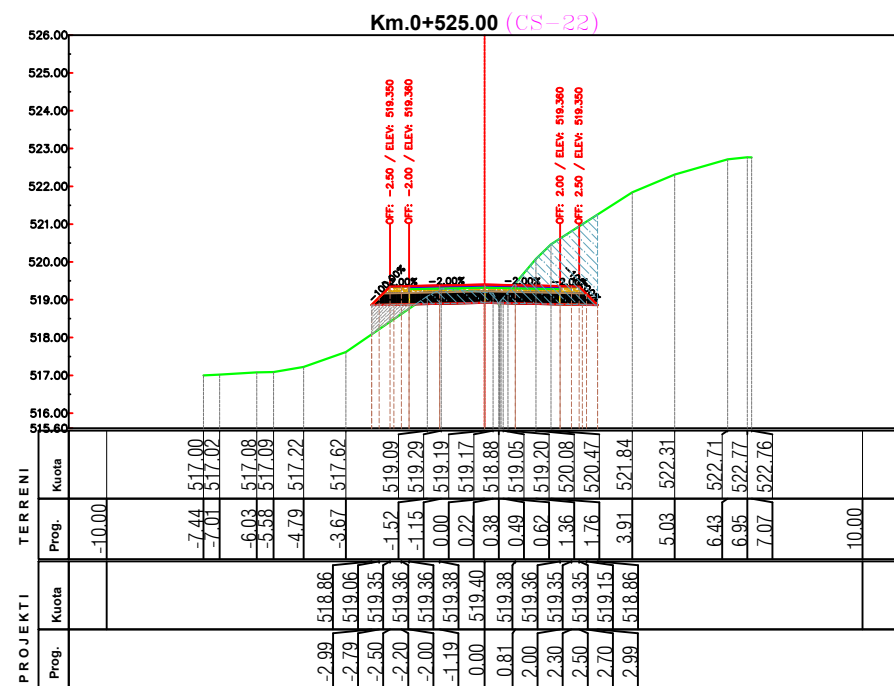

Sc-22 Km. 0+525.00	
Sip.Germim	4.19 (m2)
Sip.Mbushje	0.45 (m2)

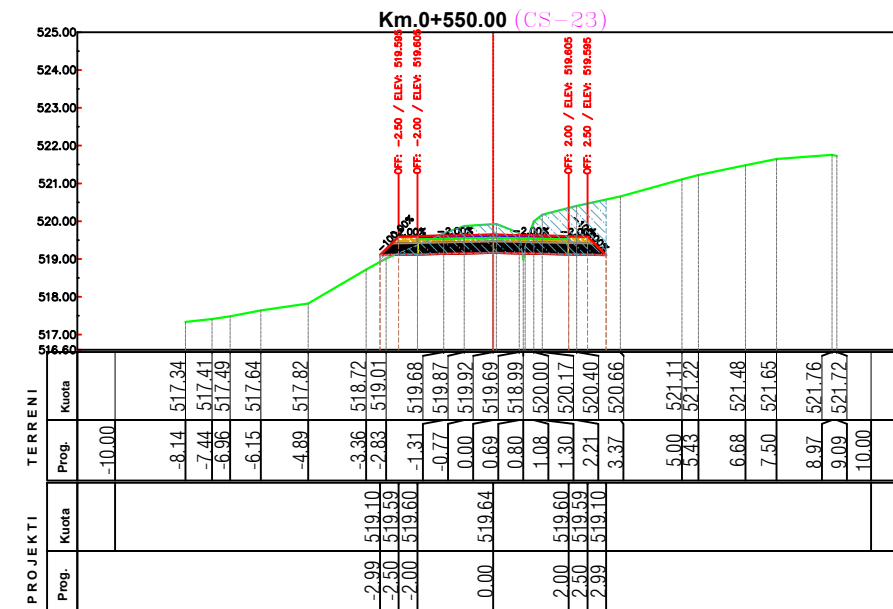

Sc-23 Km. 0+550.00	
Sip.Germim	4.20 (m2)
Sip.Mbushje	0.04 (m2)

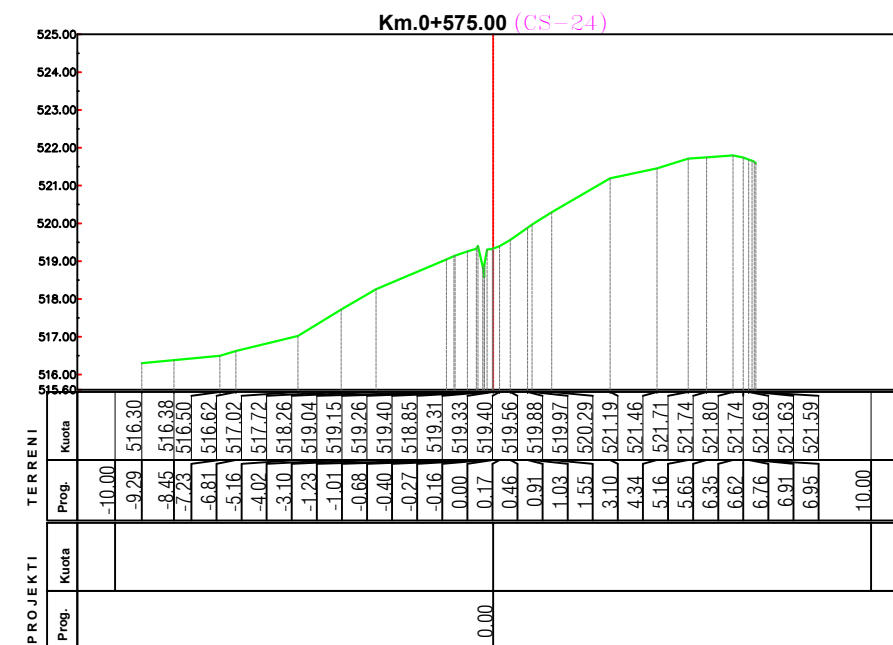

Sc-24 Km. 0+575.00	
Sip.Germim	0.00 (m2)
Sip.Mbushje	0.00 (m2)

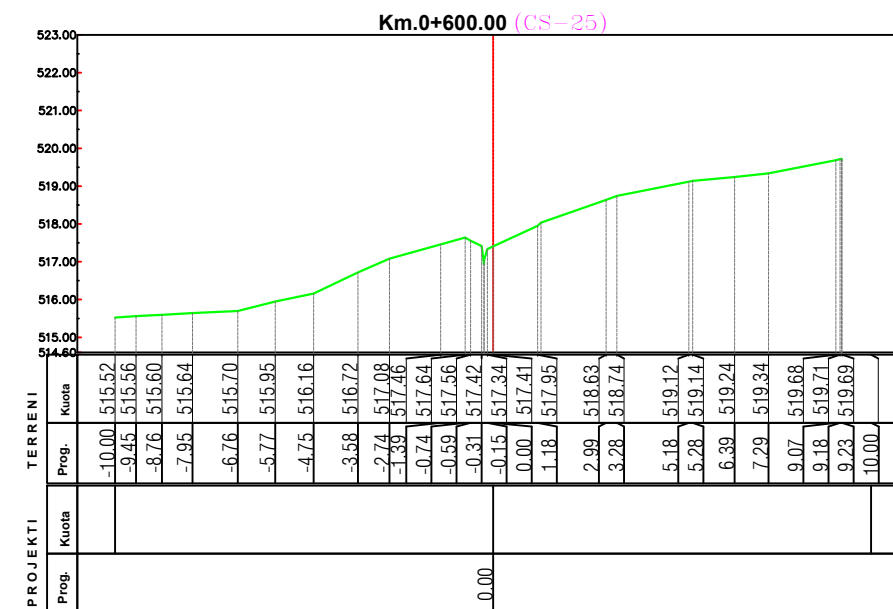

Sc-25 Km. 0+600.00	
Sip.Germim	0.00 (m2)
Sip.Mbushje	0.00 (m2)

POROSITES : BASHKIA DIBER
SISTEMIM ASFALTIM I RRUGA BREZHDAN, LAGJA REÇE

EMERTIMI : PROFILAT TERTHORE
 "ERALD-G" sh.p.k
 Rruga "Kongresi i Lushnjes"
 Tirane



DREJTUES PROJEKTI
 Ing.Gezim ISLAMI

PROJEKTUES
 Ing.Erindi GJOKA
 Hidr.Anisa ZAKA
 Top.Alfred NDREGJONI
 Mek.Arben MUHA
 Top.Kujtim CANAMETI
 Ing.Eraldo ISLAMI

SHKALLA
 SHK - 1:200
 TIRANE 2022

FLETA
 4 - 05
 FORMAT A3

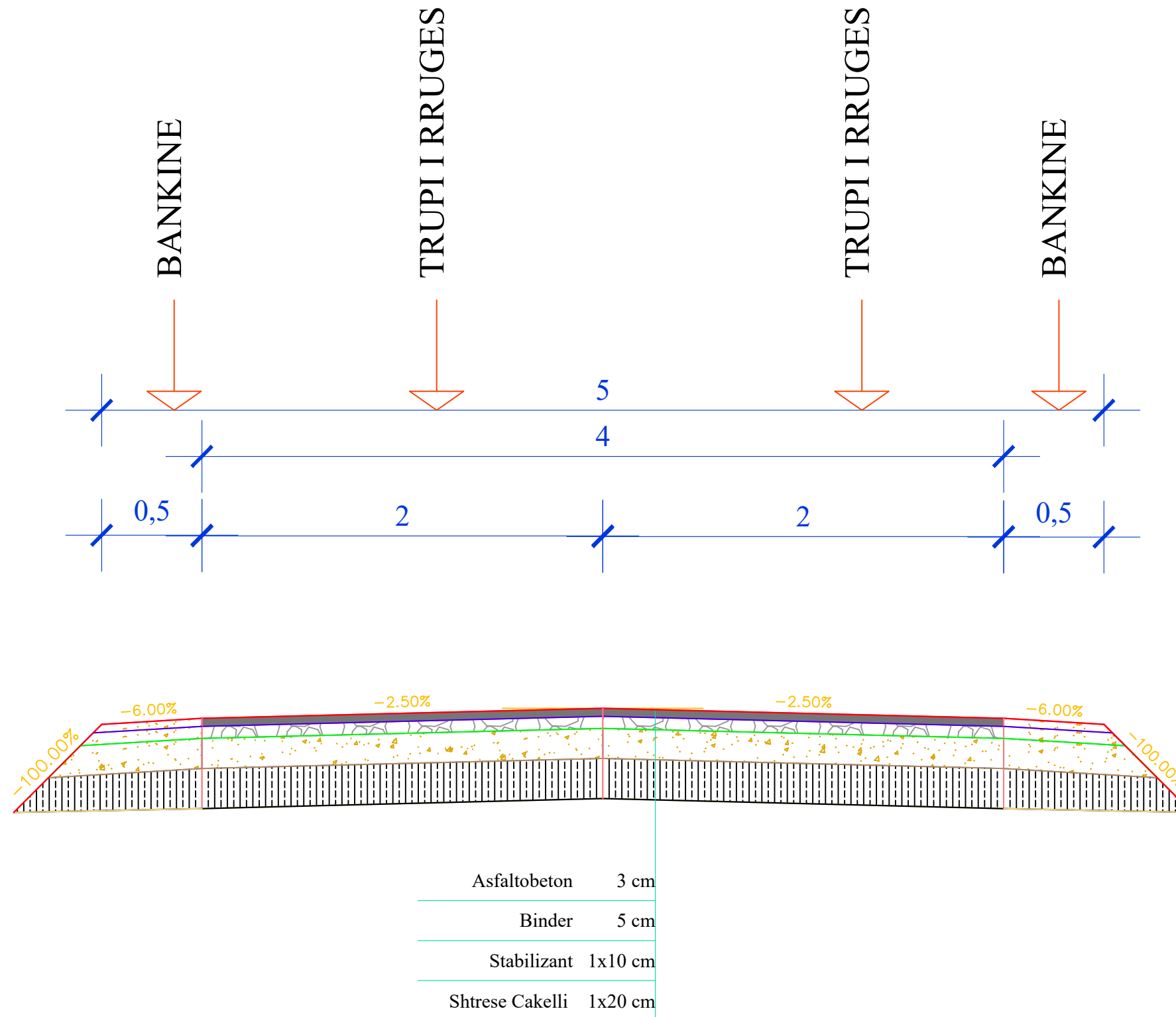

POROSITES : BASHKIA DIBER
 SISTEMIM ASFALTIM I RRUGA BREZHDAN, LAGJA REÇE

EMERTIMI : PROFILI TERTHORE TIP
 "ERALD-G" sh.p.k
 Rruga "Kongresi i Lushnjes"
 Tirane

DREJTUES PROJEKTI	PROJEKTUES	
Ing.Gezim ISLAMI	Ing.Erindi GJOKA	Hidr.Anisa ZAKA
	Top.Alfred NDREGJONI	Mek.Arben MUHA
	Top.Kujtim CANAMETI	Ing.Eraldo ISLAMI

SHKALLA	FLETA
1 : 25	5 : 01
TIRANE 2022	FORMAT A3

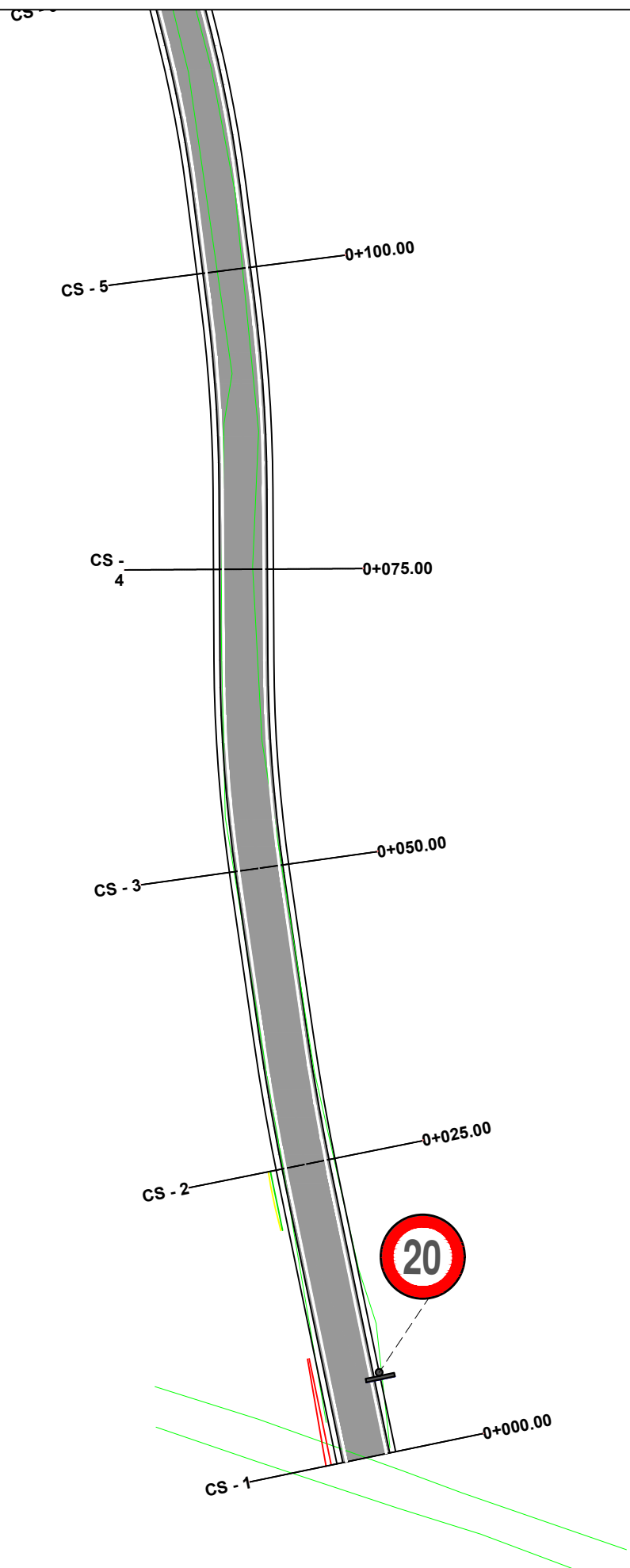

POROSITES : BASHKIA DIBER
 SISTEMIM ASFALTIM I RRUGA BREZHDAN, LAGJA REÇE

EMERTIMI : PLANIMETRIA E SINJALISTIKES
 "ERALD-G" sh.p.k
 Rruga "Kongresi i Lushnjes"
 Tirane

DREJTUES PROJEKTI
 Ing.Gezim ISLAMI

PROJEKTUES
 Ing.Erindi GJOKA Hidr.Anisa ZAKA
 Top.Alfred NDREGJONI Mek.Arben MUHA
 Top.Kujtim CANAMETI Ing.Eraldo ISLAMI

SHKALLA	FLETA
SHK - 1:500	6 - 01
TIRANE 2022	FORMAT A3

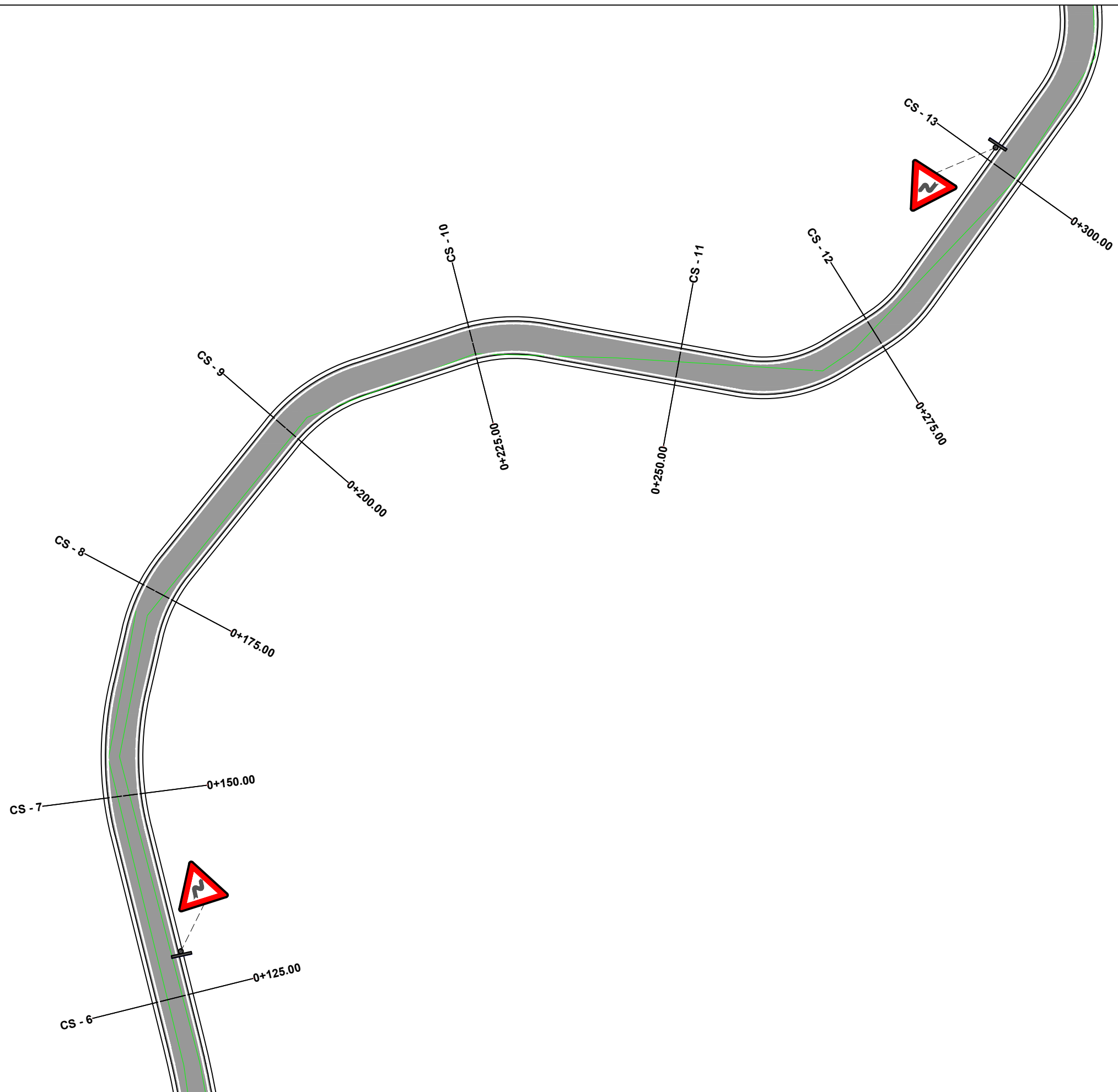

POROSITES : BASHKIA DIBER
SISTEMIM ASFALTIM I RRUGA BREZHDAN, LAGJA REÇE

EMERTIMI : PLANIMETRIA E SINJALISTIKES
 "ERALD-G" sh.p.k
 Rruga "Kongresi i Lushnjes"
 Tirane

DREJTUES PROJEKTI
 Ing.Gezim ISLAMI

PROJEKTUES
 Ing.Erindi GJOKA Hidr.Anisa ZAKA
 Top.Alfred NDREGJONI Mek.Arben MUHA
 Top.Kujtim CANAMETI Ing.Eraldo ISLAMI

SHKALLA	FLETA
SHK - 1:500	6 - 02
TIRANE 2022	FORMAT A3

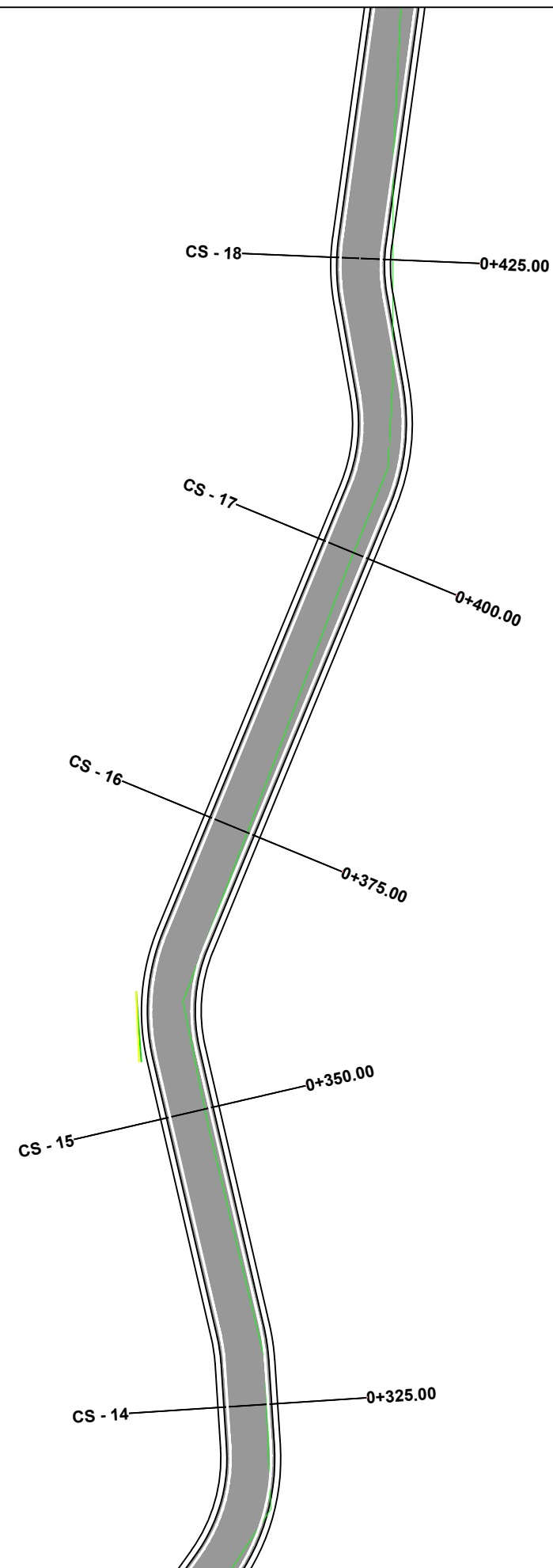

POROSITES : BASHKIA DIBER
 SISTEMIM ASFALTIM I RRUGA BREZHDAN, LAGJA REÇE

EMERTIMI : PLANIMETRIA E SINJALISTIKES
 "ERALD-G" sh.p.k
 Rruga "Kongresi i Lushnjes"
 Tirane

DREJTUES PROJEKTI
 Ing.Gezim ISLAMI

PROJEKTUES
 Ing.Erindi GJOKA Hidr.Anisa ZAKA
 Top.Alfred NDREGJONI Mek.Arben MUHA
 Top.Kujtim CANAMETI Ing.Eraldo ISLAMI

SHKALLA	FLETA
SHK - 1:500	6 - 03
TIRANE 2022	FORMAT A3

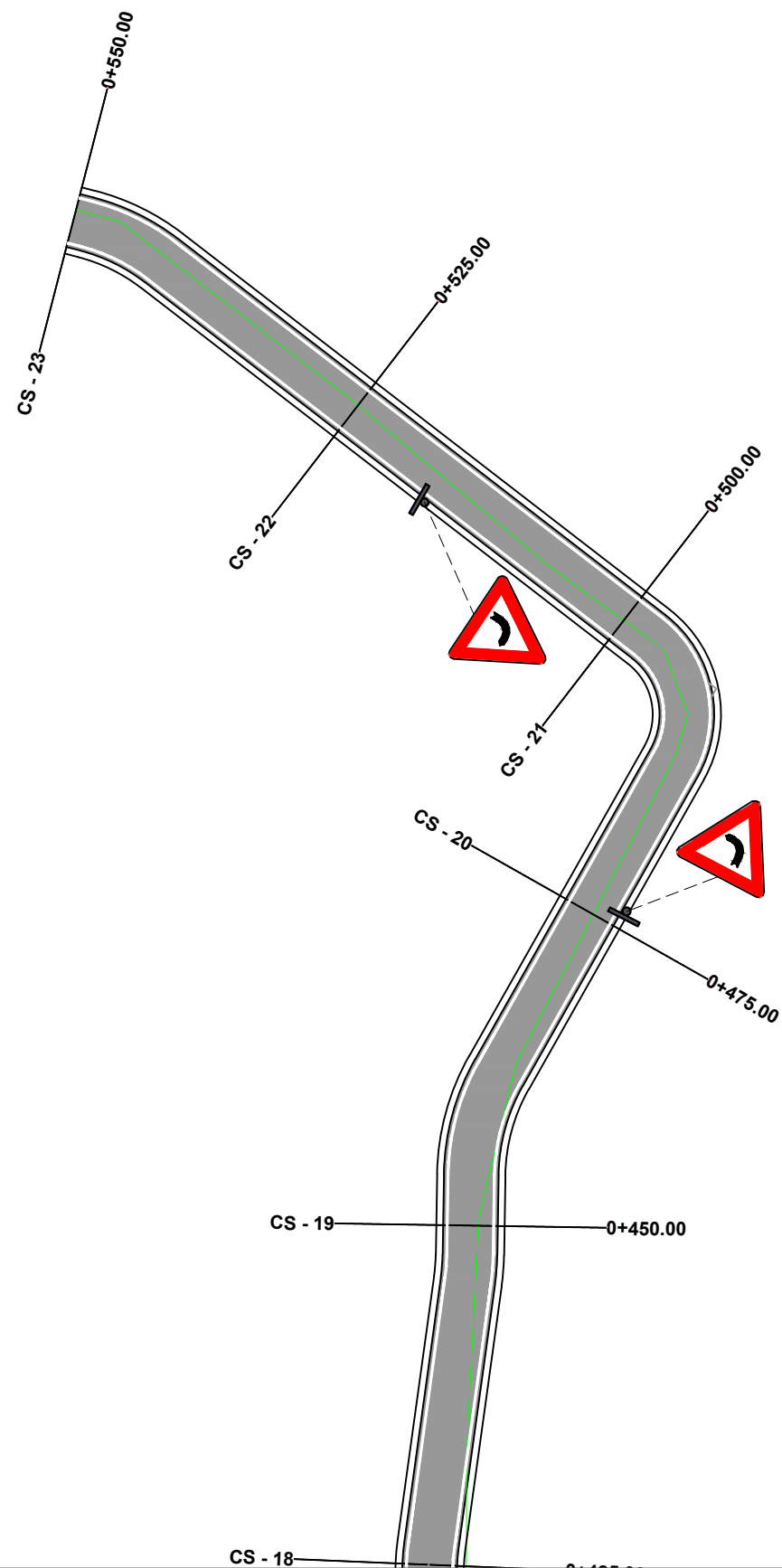

POROSITES : BASHKIA DIBER
 SISTEMIM ASFALTIM I RRUGA BREZHDAN, LAGJA REÇE

EMERTIMI : PLANIMETRIA E SINJALISTIKES
 "ERALD-G" sh.p.k
 Rruga "Kongresi i Lushnjes"
 Tirane

DREJTUES PROJEKTI
 Ing.Gezim ISLAMI

PROJEKTUES
 Ing.Erindi GJOKA Hidr.Anisa ZAKA
 Top.Alfred NDREGJONI Mek.Arben MUHA
 Top.Kujtim CANAMETI Ing.Eraldo ISLAMI

SHKALLA	FLETA
SHK - 1:500	6 - 04
TIRANE 2022	FORMAT A3

DETAJ I PËRGJITHSHËM PËR PRERJEN TËRTHORE TË TOMBINOS (1.0x1.0)m

SH. 1:20

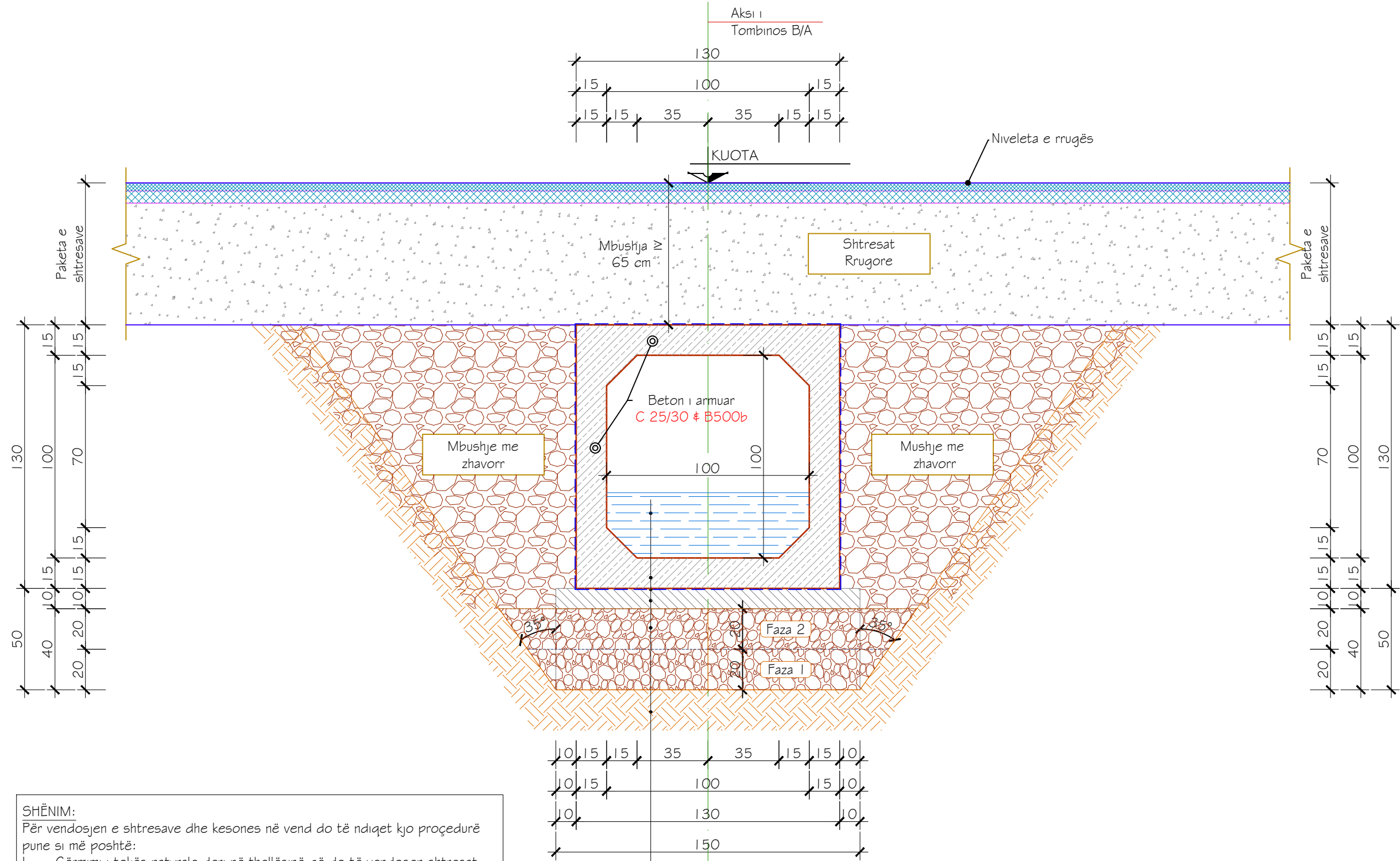

SHËNIM:
 Për vendosjen e shtresave dhe kesones në vend do të ndiqet kjo procedurë pune si më poshtë:
 1. Gërmimi i tokës natyrale deri në thellësinë që do të vendosen shtresat.
 2. Nivelimi i terrenit ekzistues dhe kompaktësimi i tij
 3. Faza e parë - Shtresë zhavorri e ngjeshur me trashësi 20cm dhe me tregues kompaktësie 100%
 4. Faza e dytë - Shtresë zhavorri e ngjeshur me trashësi 20cm dhe me tregues kompaktësie 100%
 5. Shtresë betoni C12/15 nivelues me trashësi 10cm
 6. Vendosja e themelit të tombinos së re.

Ujë në tombino	
Themeli Tombinos	
Shtesë hidroizolimi	1 cm
Shtresë betoni C12/15	10cm
Shtresë zhavorri e ngjeshur, tregues kompaktësie 100%	2x20cm
Tokë natyrale e kompaktësuar	

POROSITES : BASHKIA DIBER SISTEMIM ASFALTIM I RRUGA BREZHDAN, LAGJA REÇE	EMERTIMI : TOMBINO BOX 1X1 "ERALD-G" sh.p.k Rruga "Kongresi i Lushnjes" Tirane	DREJTUES PROJEKTI Ing.Gezim ISLAMI	PROJEKTUES		SHKALLA SHK - 1:20 TIRANE 2022	FLETA 7 - 01 FORMAT A3
			Ing.Erindi GJOKA Top.Alfred NDREGJONI Top.Kujtim CANAMETI	Hidr.Anisa ZAKA Mek.Arben MUHA Ing.Eraldo ISLAMI		

ARMIMI I TOMBINOS KUTI (1.0x1.0)m PËR IML, Sh. 1:20



TABELA E ARMATURËS PËR TOMBINON KUTI (1.0x1.0)m PËR IML

Nr.	Ø (mm)	L (cm)	Sasia (copë)	ΣL (ml)	Përmbledhje e tabelës armaturës				
					Ø (mm)	ΣL (ml)	Pesha njësi (kg/m)	Pesha totale (kg)	
1	8	205	20	41.00	6	2.40	0,2220	0.53	
2	8	155	20	31.00	8	196.00	0.3950	77.42	
3	10	215	10	21.50	10	23.00	0.6170	14.19	
4	8	170	10	17.00					
5	8	115	20	23.00					
6	8	100	84	84.00					
7	6	30	8	2.40					
PËR IML TOMBINO									
Hekuri - B500							Kg	92.14	
Betoni - C25/30							m³	0,7350	

SHËNIME TEKNIKE:

- Tombino Kutit (1.0x1.0)m zbatohet me beton C 25/30;
- Armatura e çelikut është e klasës B me rezistencë karakteristike të rrjedhshme $f_{yk} = 500\text{MPa}$;
- Minimumi i shtresës mbrojtëse nuk duhet të jetë me pak se 3cm;
- Klasa e betonit të varfër është C 12/15;
- Shtresa hidroizoluese është 1cm
- Të gjithë dimensionet jepen në "cm".

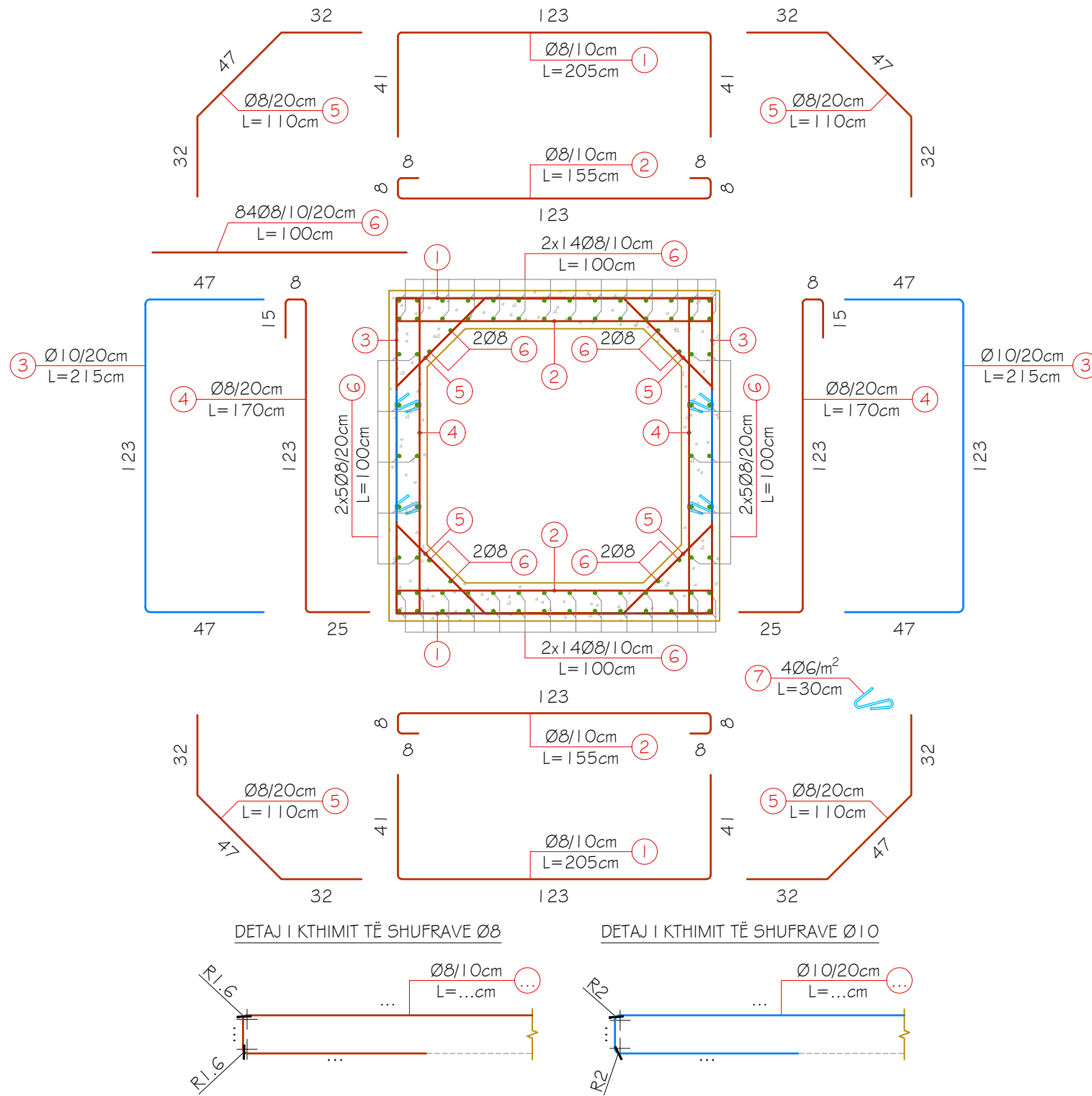
POROSITES : BASHKIA DIBER
SISTEMIM ASFALTIM I RRUGA BREZHDAN, LAGJA REÇE

EMERTIMI : TOMBINO BOX 1X1
"ERALD-G" sh.p.k
Rruga "Kongresi i Lushnjes"
Tirane

DREJTUES PROJEKTI
Ing.Gezim ISLAMI

PROJEKTUES
Ing.Erindi GJOKA Hidr.Anisa ZAKA
Top.Alfred NDREGJONI Mek.Arben MUHA
Top.Kujtim CANAMETI Ing.Eraldo ISLAMI

SHKALLA
SHK - 1:20
TIRANE 2022

FLETA
7 - 01/1
FORMAT A3

SHENJAT PARANDALUESE

Trekendeshi: e kuqe reflektive

Sfondi: e kuqe reflektive

Simboli: zeze

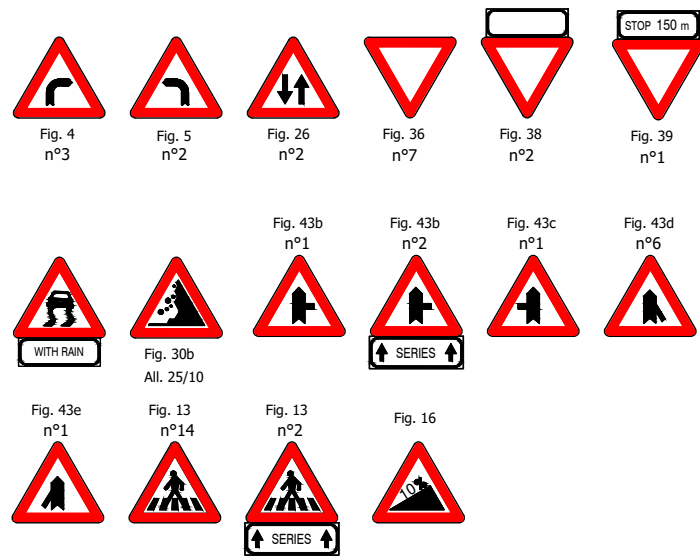

Fig. 317
All. 25/10

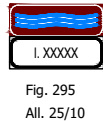
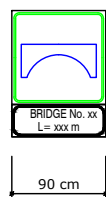

Fig. 295
All. 25/10

TABELAT INFORMUESE

TABELAT POTESUESE

Tabela: e bardhe reflektive

Sfondi : e zeze

TABELAT SHTESE

Sfondi: e bardhe reflektive

TABELAT SHIGJETE

Sfondi: jeshile reflektive

Teksti: e zeze

Pozicioni i shenjave Chevron	
Rrezja e kthese (m)	Distanca (m)
30 - 50	8
50 - 100	12
100 - 200	20
200 - 400	30
>400 (nese duhet)	30-50

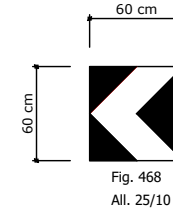

Fig. 468
All. 25/10

Shenja Chevron ne nje drejtim

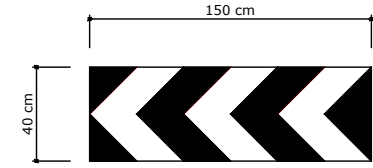

Fig. 468
All. 25/10

Shenja Chevron

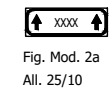

Fig. Mod. 2a
All. 25/10

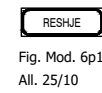

Fig. Mod. 6p1
All. 25/10

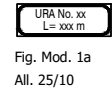
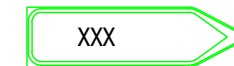

Fig. Mod. 1a
All. 25/10

Fig. 249

All. 25/10



PROHIBIT SIGN SHENJA PARANDALUES

Ndalim parakalimi

Cepi & sfondi: e bardhe reflektive

Rrethi: e kuqe reflektive

Simboli: e zeze dhe kuqe reflektive

Limit shpejtesie

Rreth: e kuqe reflektive

Simboli: e zeze reflektive

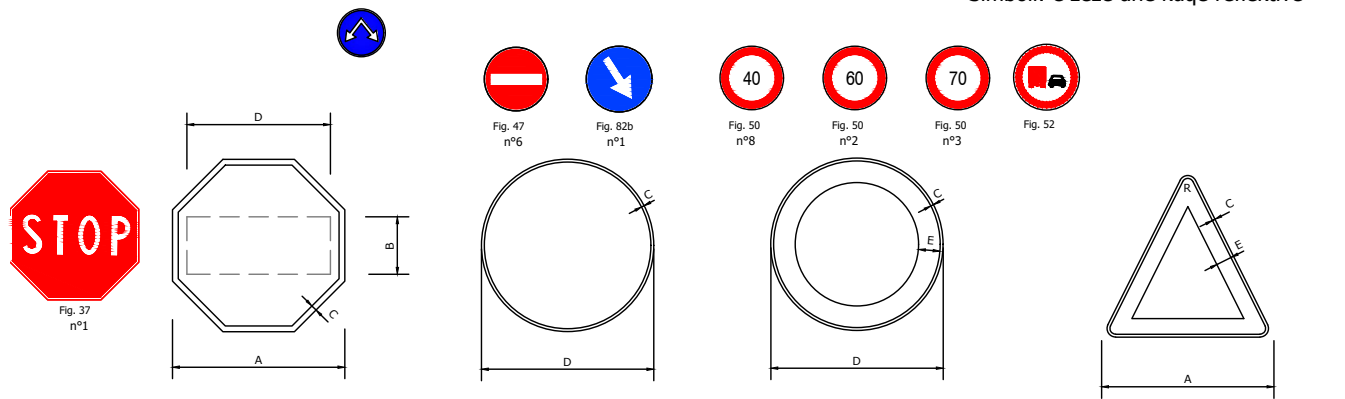

Fig. 37
n°1

TETEKENDESH

	A	B	C	D
Small	60	20	2	50

SHENJAT DETYRUESE

	C	D
Small	0.8	40

SHENJAT PARANDALUESE

	C	D	E
Small	0.8	40	5
Normal	1	60	7.5

TREKENDORE

	A	C	E	R
Small	60	1	5.5	3
Normal	90	1.5	8	4.5

DREJTEKENDESH INFORMUES

	A	B	C	D	R
Small	58	0.3	0.6	18	2

DREJTEKENDESH

	A	B	C	D	R
Normal	90	0.8	1.5	30	5.5

Normal	C	D	E	H	L	M
	1.5	1	22	40	150	18
	N	R1	R2	R3	P	S
	15.5	8	13	2	6.5	38

DREJTEKENDORE

	A	B	C	D	R
Normal	90	135	1.6	0.8	7

POROSITES : BASHKIA DIBËR

SISTEMIM ASFALTIM I RRUGA BREZHDAN, LAGJA REÇE

EMERTIMI : DETAJE SINJALISTIKE

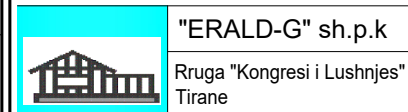

DREJTUES PROJEKTI

Ing.Gezim ISLAMI

PROJEKTUES

Ing.Erindi GJOKA

Ing.Alfred NDREGJONI

Top.Kujtim CANAMETI

Hidr.Anisa ZAKA

Mek.Arben MUHA

Ing. Eraldo Islami

SHKALLA

SHK - 1:50

TIRANE 2022

FLETA

7 - 02

FORMAT A3

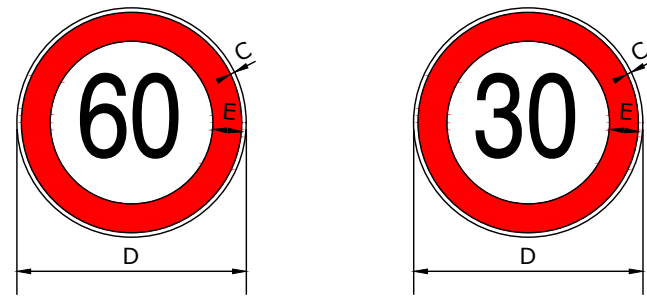

C	D	E
0.8	40	5

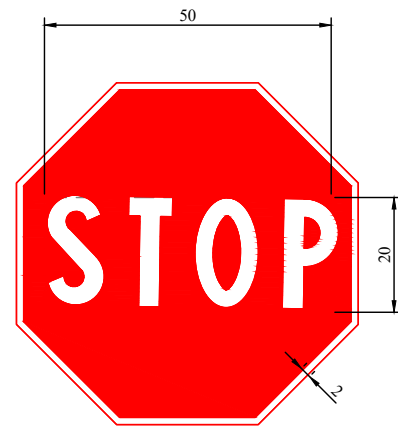

A	B	C	D
60	20	2	50

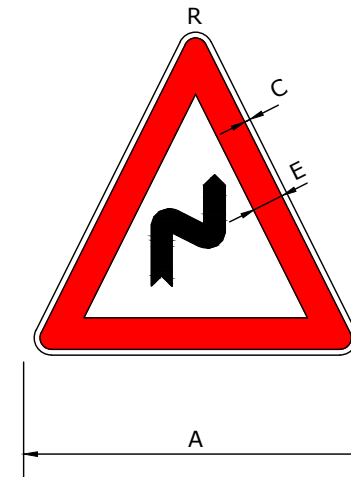

A	C	E	R
60	1	5.5	3

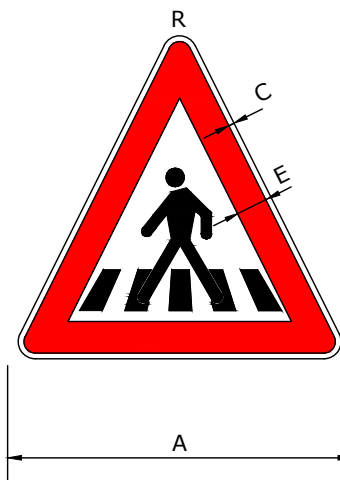

A	C	E	R
60	1	5.5	3



A	C	E	R
60	1	5.5	3

POROSITES : BASHKIA DIBËR

SISTEMIM ASFALTIM I RRUGA BREZHDAN, LAGJA REÇE

EMERTIMI : DETAJE SINJALISTIKE



"ERALD-G" sh.p.k
Rruga "Kongresi i Lushnjes"
Tirane

DREJTUES PROJEKTI

Ing.Gezim ISLAMI

PROJEKTUES

Ing.Erindi GJOKA

Ing.Alfred NDREGJONI

Top.Kujtim CANAMETI

Hidr.Anisa ZAKA

Mek.Arben MUHA

Ing. Eraldo Islami

SHKALLA

SHK - 1:50

TIRANE 2022

FLETA

7 - 03

FORMAT A3

VIJEZIMI I RRUGEVE

VIJEZIMI NE KUFIJETE E RRUGES

Tipi A"vazhduar"

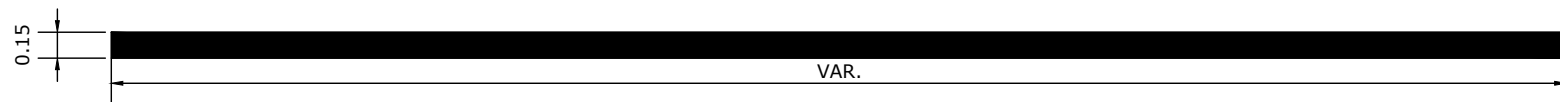

Vijëzimi i aksit qëndror ose vijëzimi i korsisë për shpejtësi <50 km/h

Type D



Linjë paralajmëruese tek nyjet, kthesat dhe pikat e tjera të rrezikshme

Type E

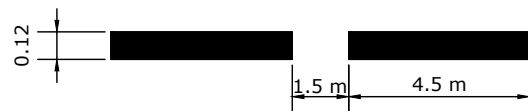

Vijëzimi tek cepi i karrexhatës, tek nyjet ose vendndodhjet anësore.

Type F

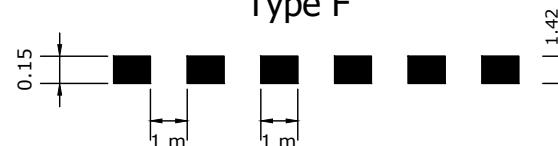

Udhëzuesi për automjetet që duhet të kalojnë nëpër një nyje.
Zakonisht përdoret tek nyjet komplekse.

Type G

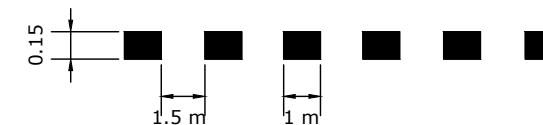

KALIMI KEMBESOREVE

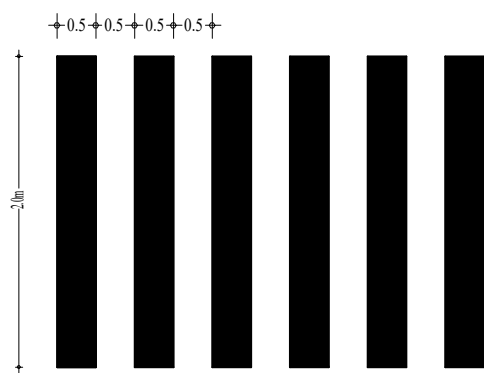

VIJEZIMI NE AKS TE RRUGES

Tipi A"vazhduar"

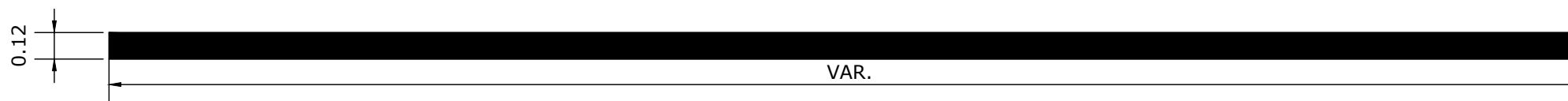

POROSITES : BASHKIA DIBËR

SISTEMIM ASFALTIM I RRUGA BREZHDAN, LAGJA REÇE

EMERTIMI : DETAJE SINJALISTIKE



"ERALD-G" sh.p.k
Rruga "Kongresi i Lushnjes"
Tirane

DREJTUES PROJEKTI

Ing.Gezim ISLAMI

PROJEKTUES

Ing.Erindi GJOKA

Ing.Alfred NDREGJONI

Top.Kujtim CANAMETI

Hidr.Anisa ZAKA

Mek.Arben MUHA

Ing. Eraldo Islami

SHKALLA

SHK - 1:50

TIRANE 2022

FLETA

7 - 04

FORMAT A3

VENDOSJA E TABELAVE

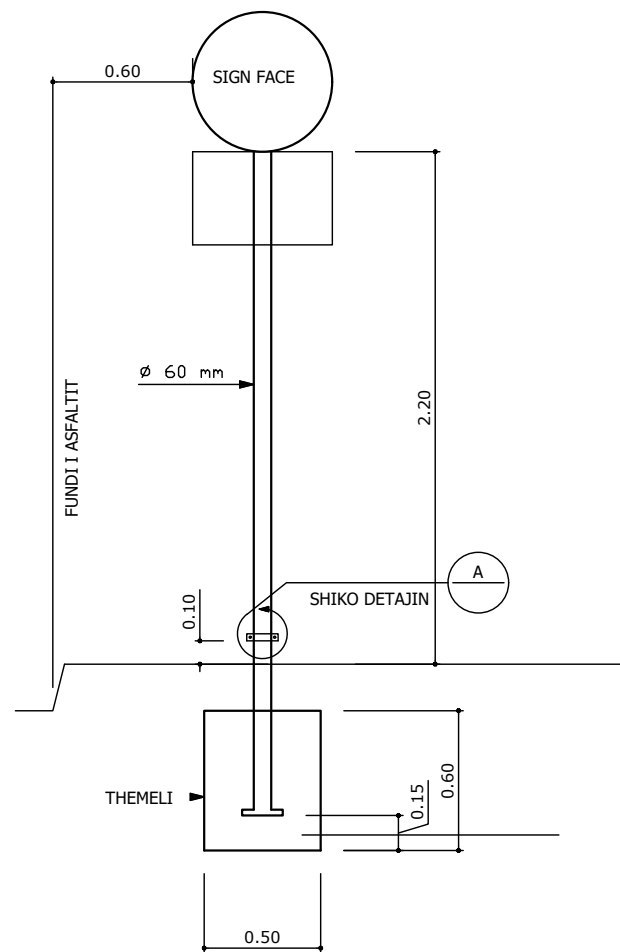

VENDOSJA E NJE TABELE

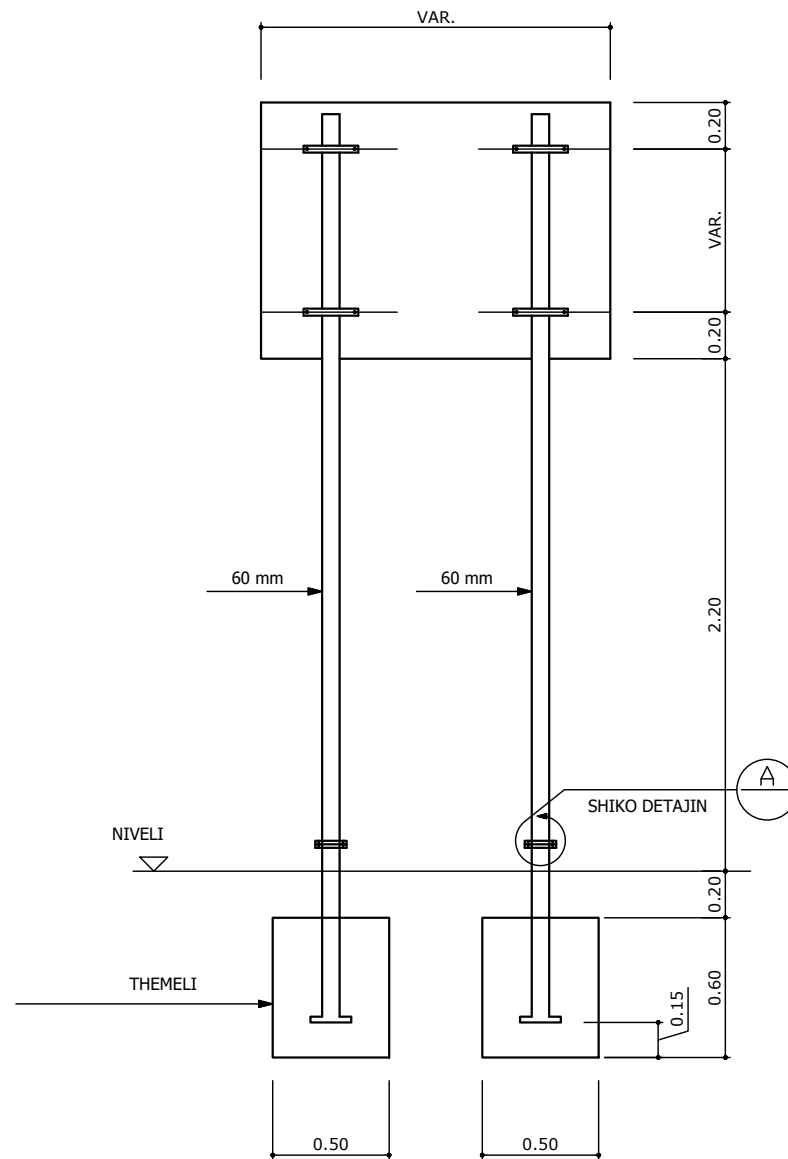

VENDOSJA E E DY TABELAVE

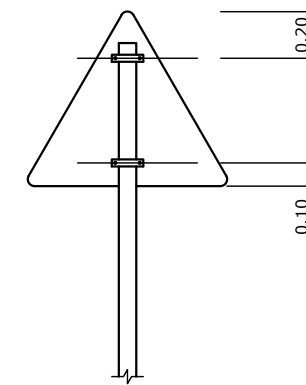
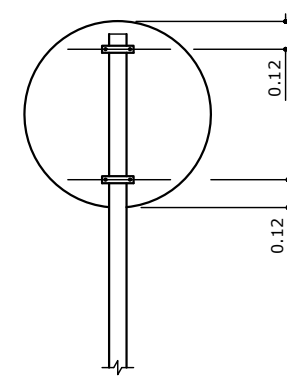

FIKSIMI I TABELES

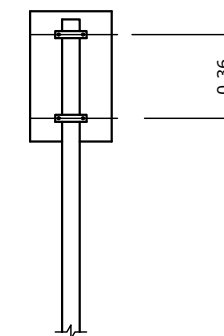
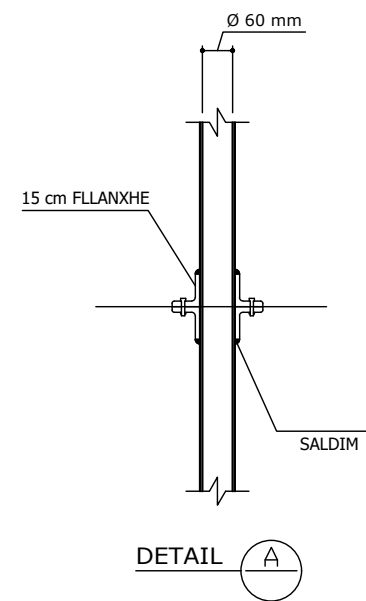

DETAIL A

POROSITES : BASHKIA DIBËR

SISTEMIM ASFALTIM I RRUGA BREZHDAN, LAGJA REÇE

EMERTIMI : DETAJE SINJALISTIKE



"ERALD-G" sh.p.k
Rruga "Kongresi i Lushnjes"
Tirane

DREJTUES PROJEKTI

Ing.Gezim ISLAMI

PROJEKTUES

Ing.Erindi GJOKA

Ing.Alfred NDREGJONI

Top.Kujtim CANAMETI

Hidr.Anisa ZAKA

Mek.Arben MUHA

Ing. Eraldo Islami

SHKALLA

SHK - 1:50

TIRANE 2022

FLETA

7 - 05

FORMAT A3

INDIKATORI I CEPIT TE RRUGES

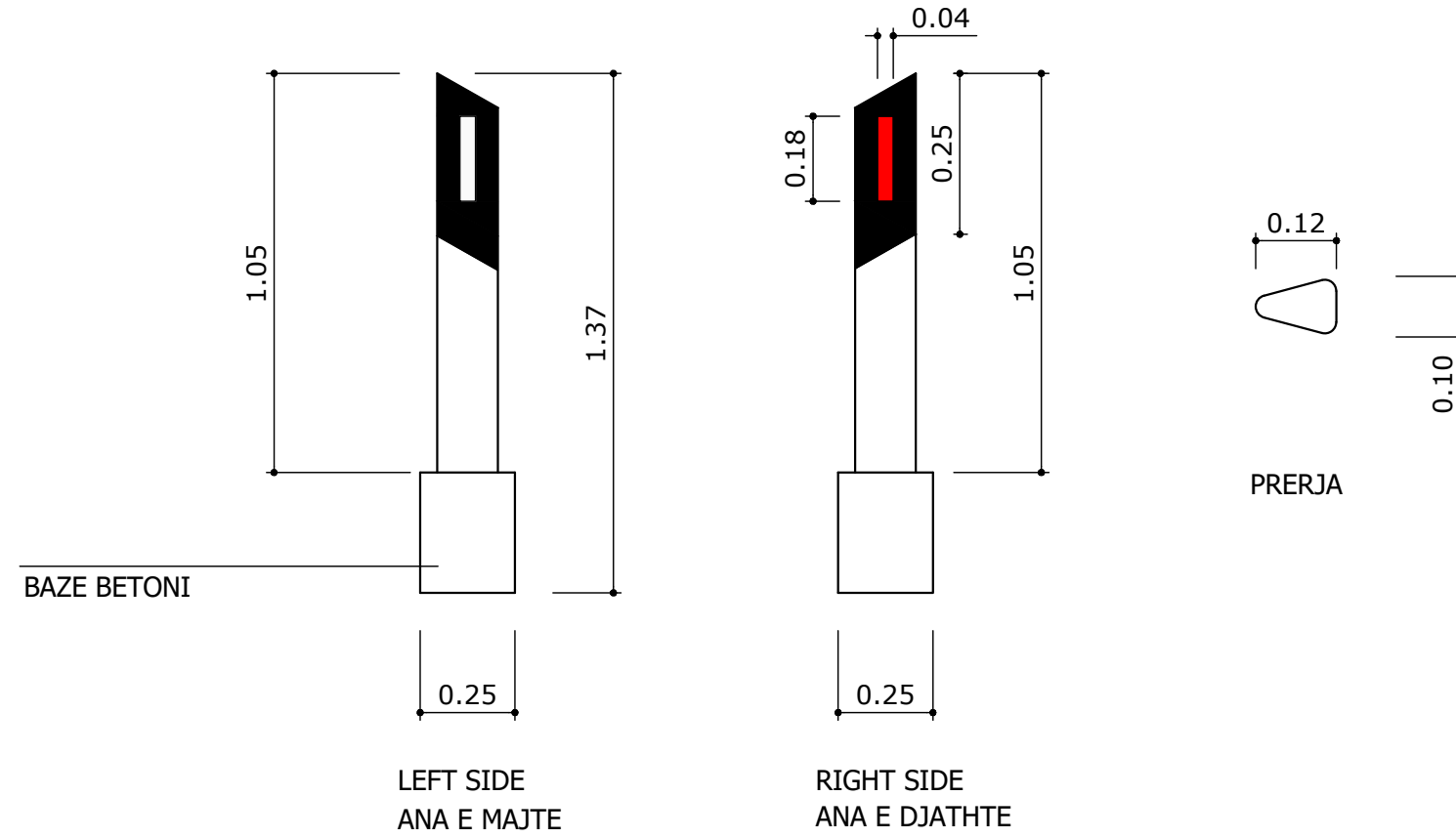

SHENIM: INDIKATORET E FUNDIT TE RRUGES VENDOSEN NE NJE DISTANCE PREJ 50 m.
NE RAST SE VENDOSEN NE GUARDRAIL TE RRUGES ATO FIKSOHEN NE FAQEN E TYRE.

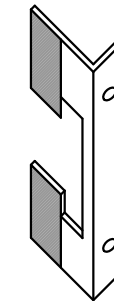

FIKSUES NE CEPAT E MUREVE TE BETONIT

POROSITES : BASHKIA DIBËR

SISTEMIM ASFALTIM I RRUGA BREZHDAN, LAGJA REÇE

EMERTIMI : DETAJE SINJALISTIKE



"ERALD-G" sh.p.k
Rruga "Kongresi i Lushnjes"
Tirane

DREJTUES PROJEKTI

Ing.Gezim ISLAMI

PROJEKTUES

Ing.Erindi GJOKA

Ing.Alfred NDREGJONI

Top.Kujtim CANAMETI

Hidr.Anisa ZAKA

Mek.Arben MUHA

Ing. Eraldo Islami

SHKALLA

SHK - 1:50

TIRANE 2022

FLETA

7 - 06

FORMAT A3

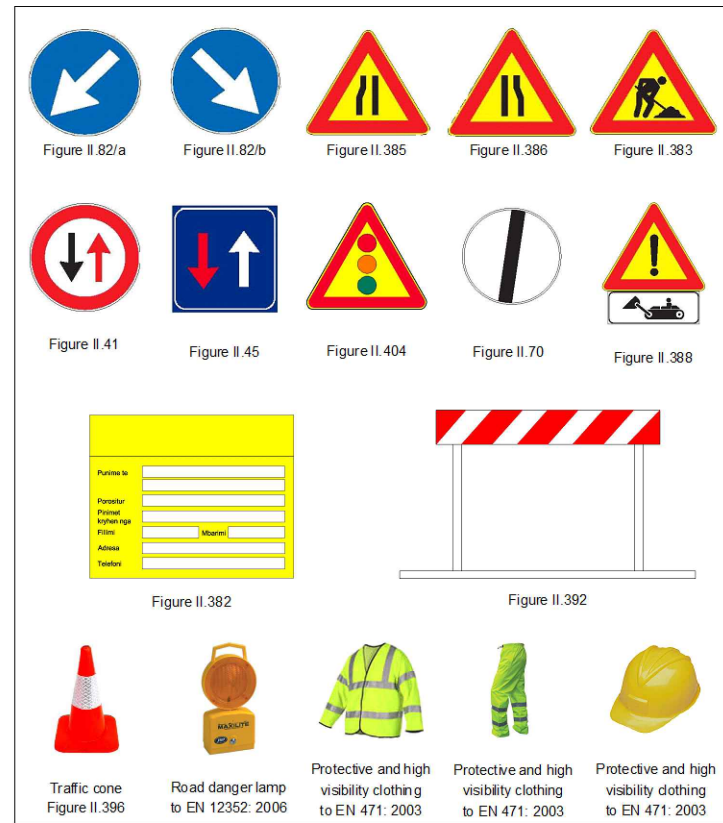

SHIGJETAT DREJTUESE

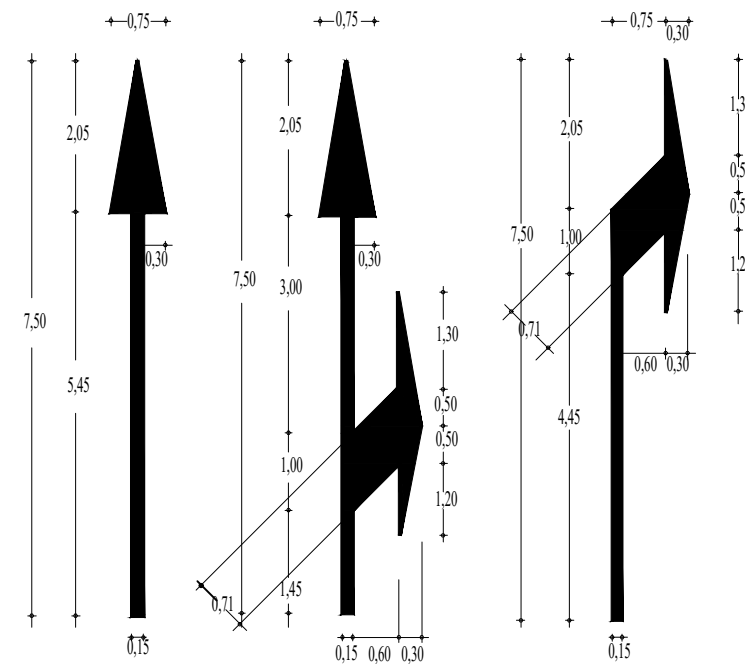

SHKRIMI I FJALES STOP

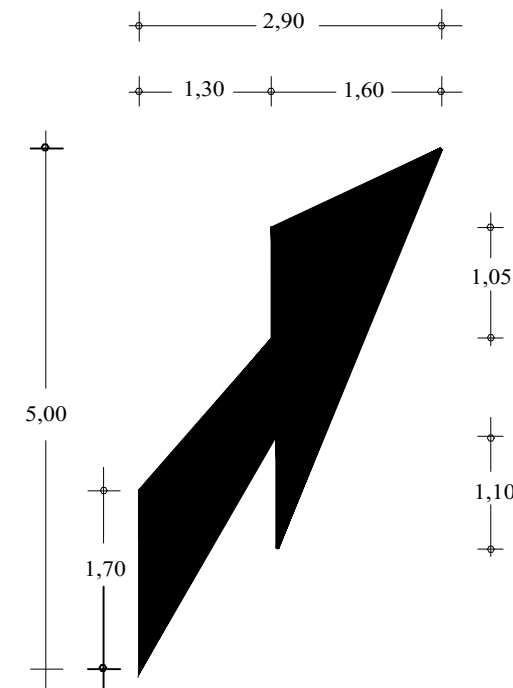
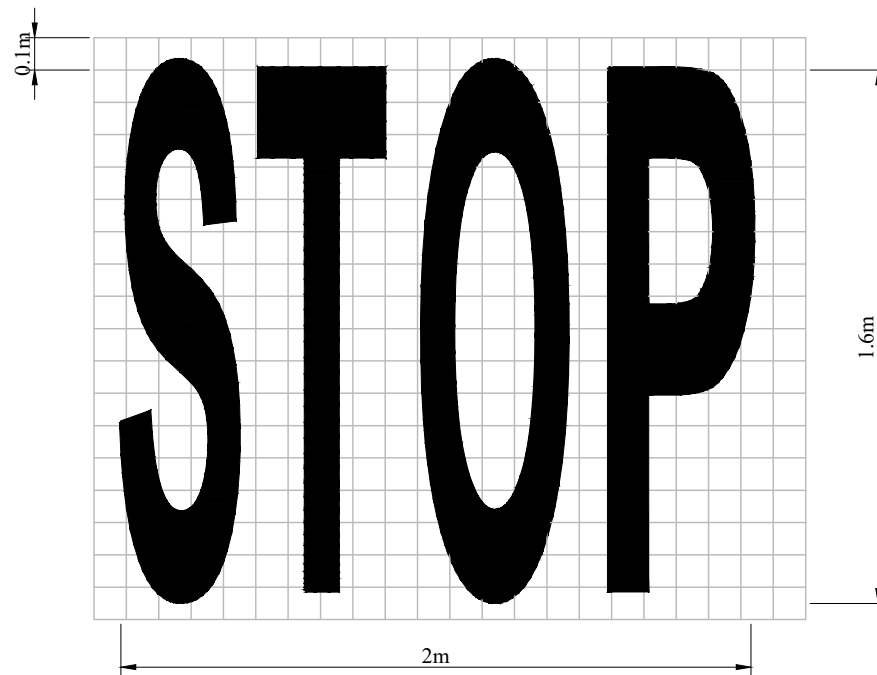

POROSITES : BASHKIA DIBËR

SISTEMIM ASFALTIM I RRUGA BREZHDAN, LAGJA REÇE

EMERTIMI : DETAJE SINJALISTIKE



DREJTUES PROJEKTI

Ing.Gezim ISLAMI

PROJEKTUES

Ing.Erindi GJOKA
Ing.Alfred NDREGJONI
Top.Kujtim CANAMETI

Hidr.Anisa ZAKA
Mek.Arben MUHA
Ing. Eraldo Islami

SHKALLA

SHK - 1:50

TIRANE 2022

FLETA

7 - 07

FORMAT A3