



REPUBLIKA E SHQIPËRISË
BASHKIA CERRIK

MIRATOHET
KRYETAR
z.Andis SALLA

PROJEKT ZBATIMI

OBJEKTI: "NDERTIMI I SHESHIT REKREATIV SHTERMEN, BASHKIA CERRIK



Projektues: ZetaKonsult sh.p.k

Address:Rr."Myrteza Topi",Nd 18, Hyrja 7, Ap 38, TIRANE

Cel:+355 (0)69 33 52 077

e-mail:zetakonsultshpk@gmail.com

Topografia e Objektivit SH 1:500

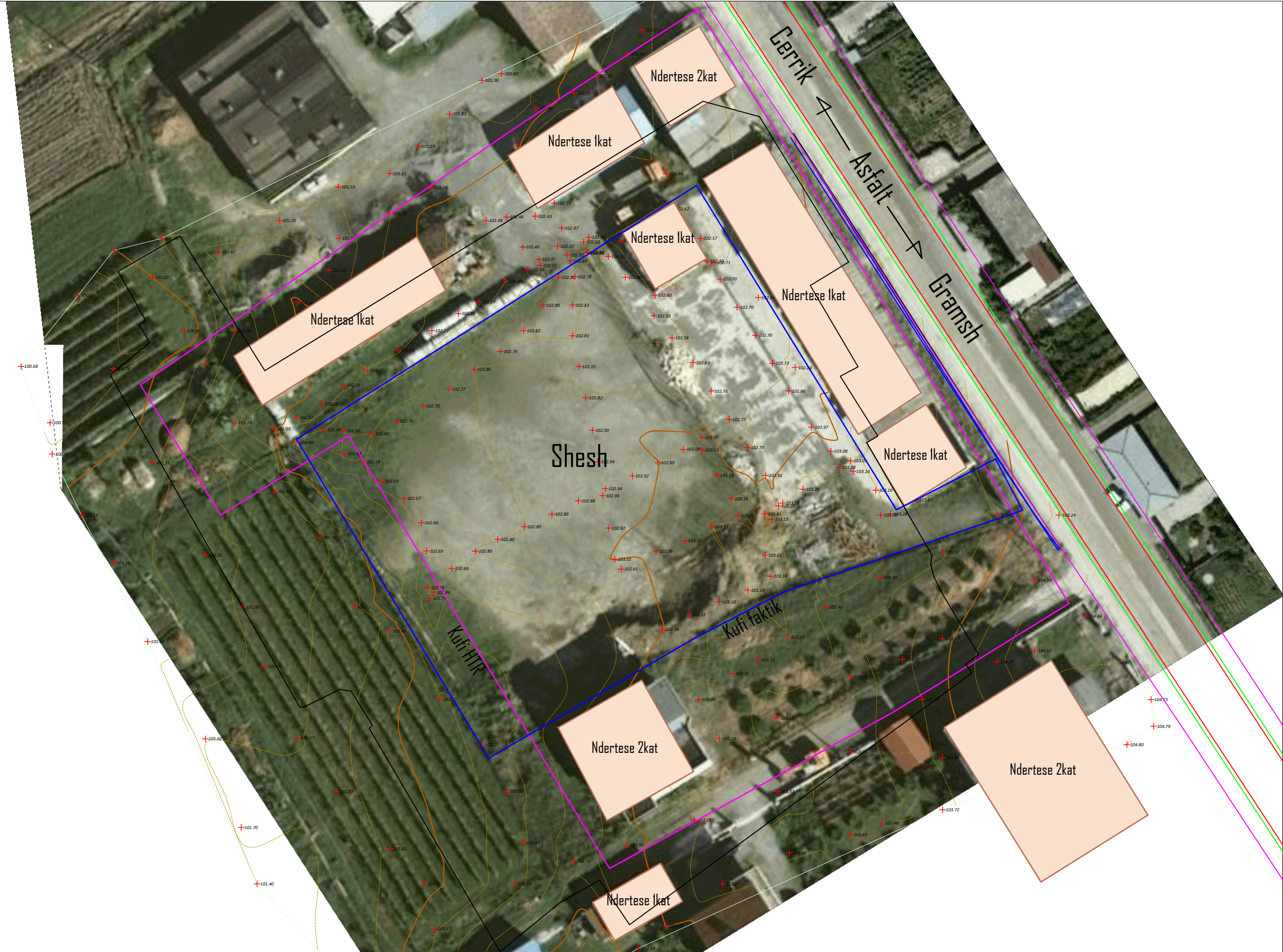

BASHKIA CERRIK



ZetaKonsult sh.p.k

Address: Rr. "Myrteza Topi", Nd 18, Hyrja 7, Ap 38, TIRANE

Cel: +355 (0)69 33 52 077

e-mail: zetakonsultshpk@gmail.com



EMERTIMI I OBJEKTIT:
 NDERTIM I SHESHIT REKREATIV SHTERMEN, BASHKIA CERRIK

FAZA E PROJEKTIT : PROJEKT ZBATIMI

EMERTESA E FLETES TOPOGRAFIA

SHKALLA Shk: 1/500

FLETA 01

GRUPI I PROJEKTIMIT:

Inxh. Ndert. Lorenc HOXHA
 Inxh. Ndert. Flutura Duro

Dt 10/09/2024

FORMATI A3

Planimetria e Pergjithshme SH 1:500



<p>BASHKIA CERRIK</p> 	<p>ZetaKonsult sh.p.k Address:Rr."Myrteza Topi",Nd 18, Hyrja 7, Ap 38, TIRANE Cel:+355 (0)69 33 52 077 e-mail:zetakonsultshpk@gmail.com</p> 	<p>EMERTIMI I OBJEKTIT: NDERTIM I SHESHIT REKREATIV SHTERMEN,BASHKIA CERRIK</p> <p>FAZA E PROJEKTIT :PROJEKT ZBATIMI</p>	<p>EMERTESA E FLETES PLANIMETRIA PERGJITHSHME</p> <p>SHKALLA Shk:1/500 FLETA 02</p>	<p>GRUPI I PROJEKTIMIT:</p> <p>Inxh. Ndert.Lorenc HOXHA Inxh.Ndert.Flutura Duro</p>	<p>Dt10/09/2024</p> <p>FORMATI A3</p>
---	---	--	---	--	---------------------------------------

Planimetria e Ndricimit SH 1:500



BASHKIA CERRIK 	ZetaKonsult sh.p.k Address:Rr."Myrteza Topi",Nd 18, Hyrja 7, Ap 38, TIRANE Cel:+355 (0)69 33 52 077 e-mail:zetakonsultshpk@gmail.com 	EMERTIMI I OBJEKTIT: NDERTIM I SHESHIT REKREATIV SHTERMEN,BASHKIA CERRIK		EMERTESA E FLETES PLANIMETRIA NDRICIMIT		GRUPI I PROJEKTIMIT: Inxh. Ndert.Lorenc HOXHA Inxh.Ndert.Flutura Duro		Dt10/09/2024
		FAZA E PROJEKTIT :PROJEKT ZBATIMI		SHKALLA Shk:1/500	FLETA 03	FORMATI A3		

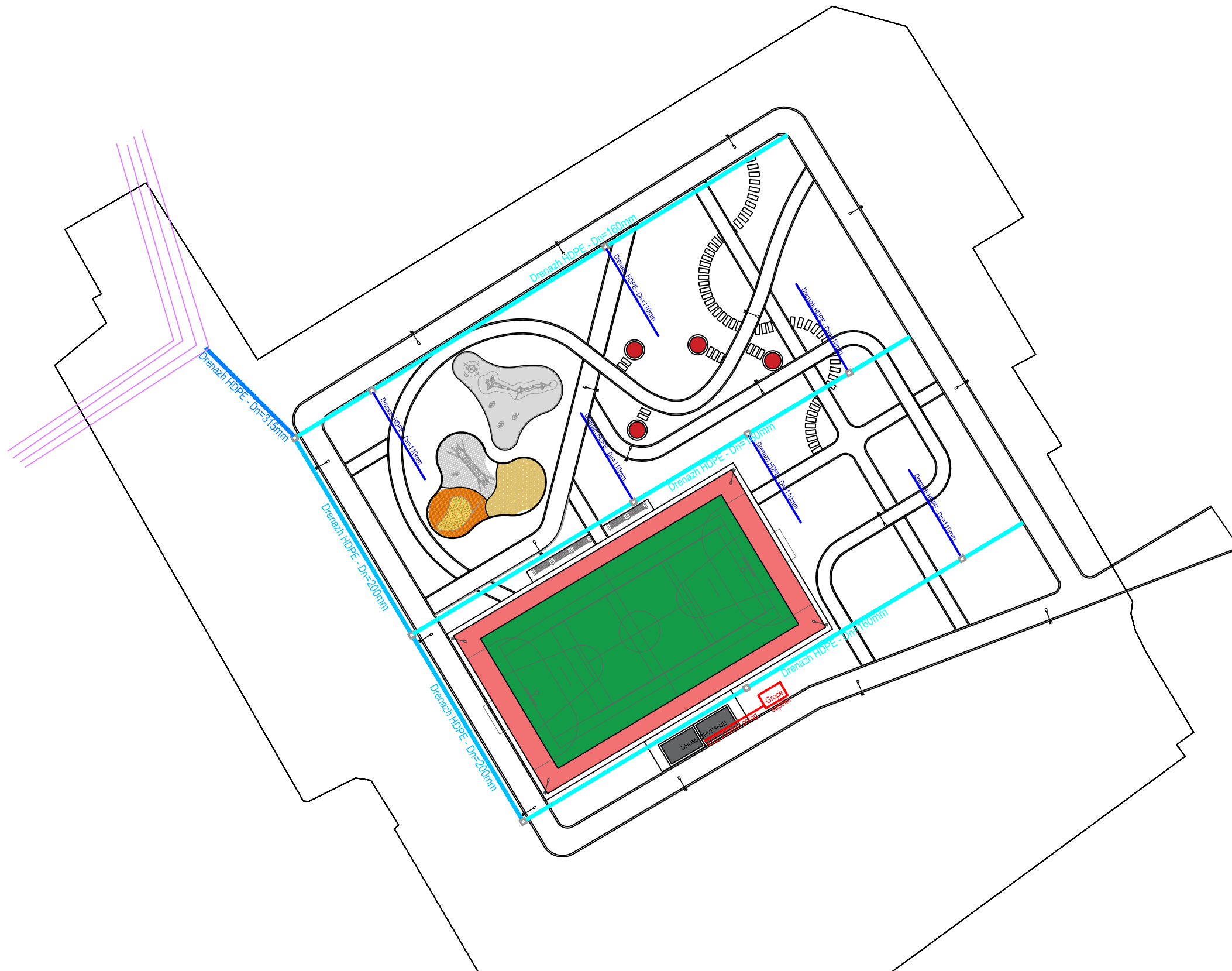

Planimetria e Kullimit SH 1:500



BASHKIA CERRIK 	ZetaKonsult sh.p.k Address:Rr."Myrteza Topi",Nd 18, Hyrja 7, Ap 38, TIRANE Cel:+355 (0)69 33 52 077 e-mail:zetakonsultshpk@gmail.com 	EMERTIMI I OBJEKTIT: NDERTIM I SHESHIT REKREATIV SHTERMEN,BASHKIA CERRIK		EMERTESA E FLETES PLANIMETRIA KULLIMIT		GRUPI I PROJEKTIMIT: Inxh. Ndert.Lorenc HOXHA Inxh.Ndert.Flutura Duro		Dt10/09/2024
		FAZA E PROJEKTIT :PROJEKT ZBATIMI		SHKALLA Shk:1/500	FLETA 04	FORMATI A3		

Planimetria e Volumeve SH 1:500



BASHKIA CERRIK 	ZetaKonsult sh.p.k Address:Rr."Myrteza Topi",Nd 18, Hyrja 7, Ap 38, TIRANE Cel:+355 (0)69 33 52 077 e-mail:zetakonsultshpk@gmail.com 	EMERTIMI I OBJEKTIT: NDERTIM I SHESHIT REKREATIV SHTERMEN,BASHKIA CERRIK		EMERTESA E FLETES PLANIMETRIA VOLUMEVE		GRUPI I PROJEKTIMIT: Inxh. Ndert.Lorenc HOXHA Inxh.Ndert.Flutura Duro		Dt10/09/2024
		FAZA E PROJEKTIT :PROJEKT ZBATIMI		SHKALLA Shk:1/500	FLETA 05	FORMATI A3		

Profillet Tip SH 1:200



PROFIL TIP 1

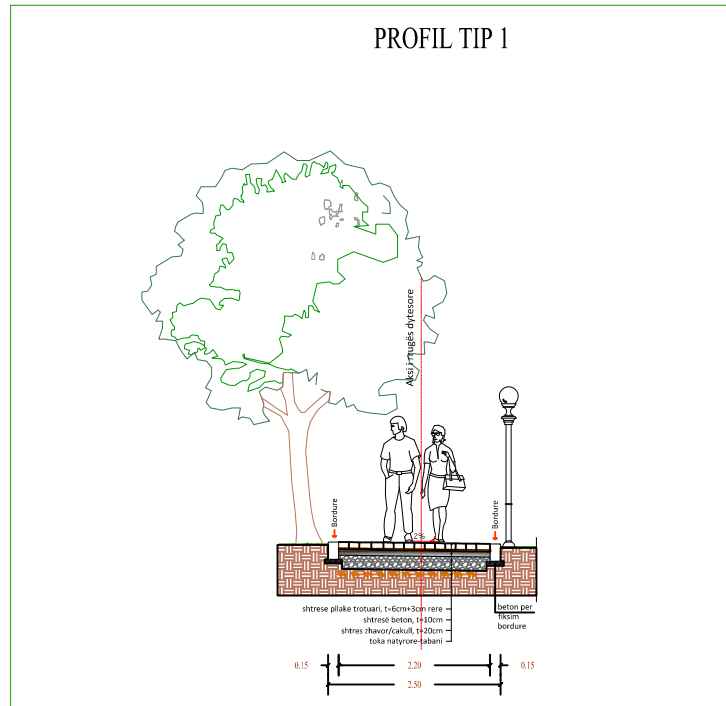

PROFIL TIP 2

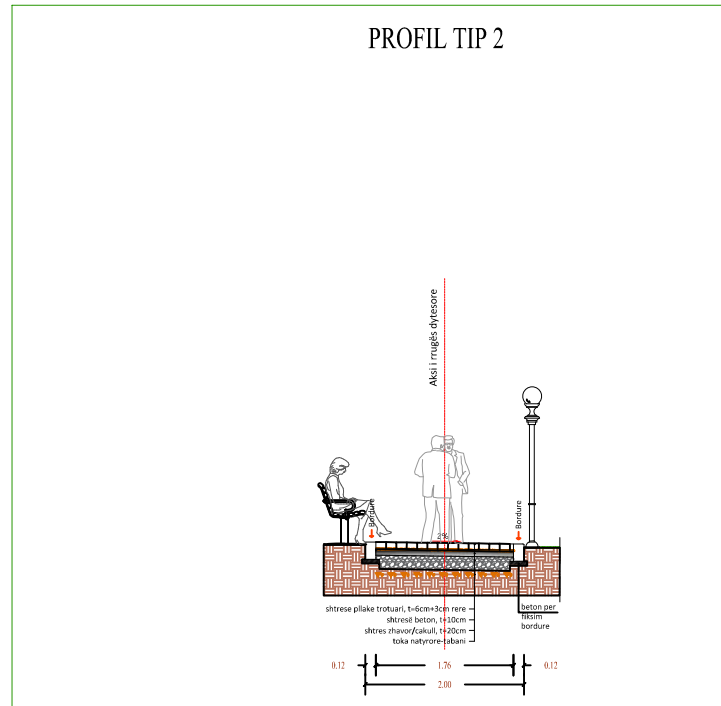

PROFIL TIP 3

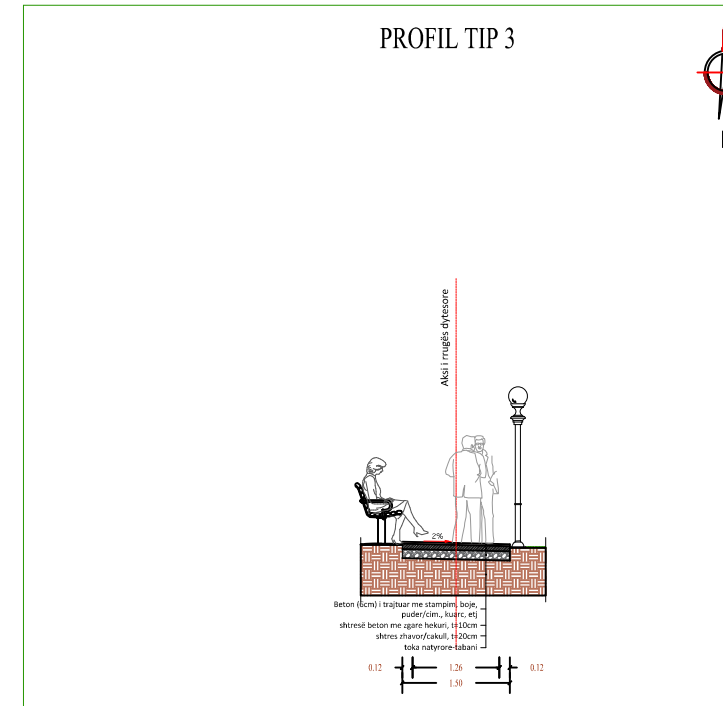

PROFIL TIP 4
(Stola Betoni)

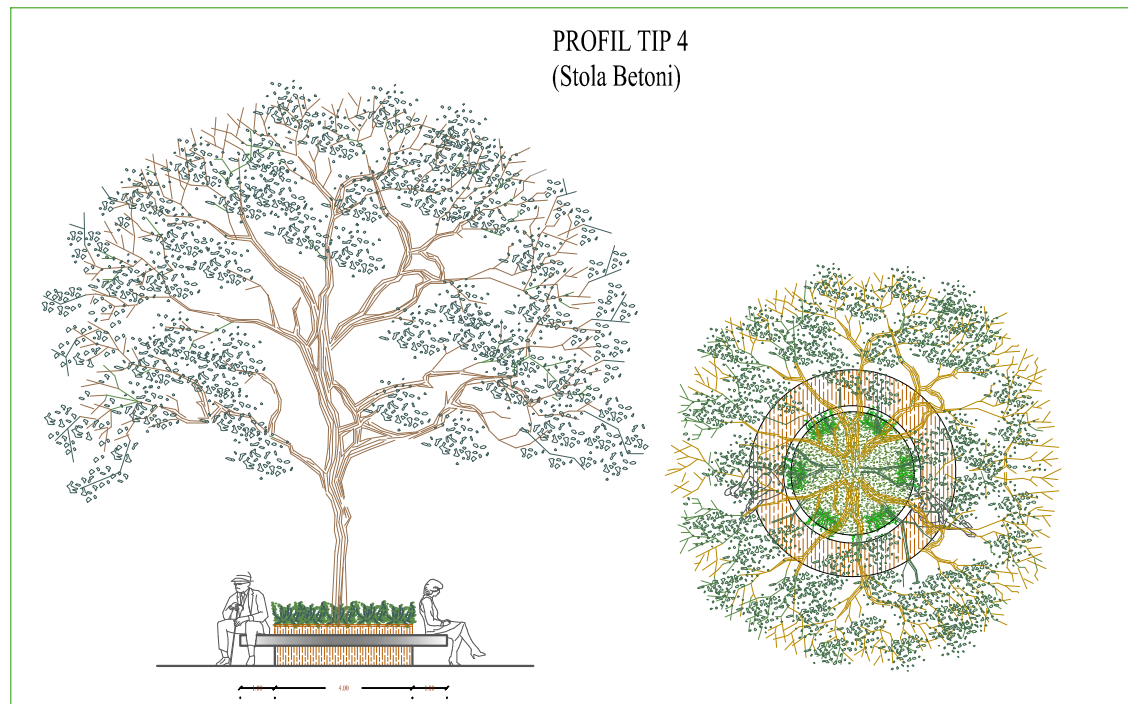

PROFIL TIP 5

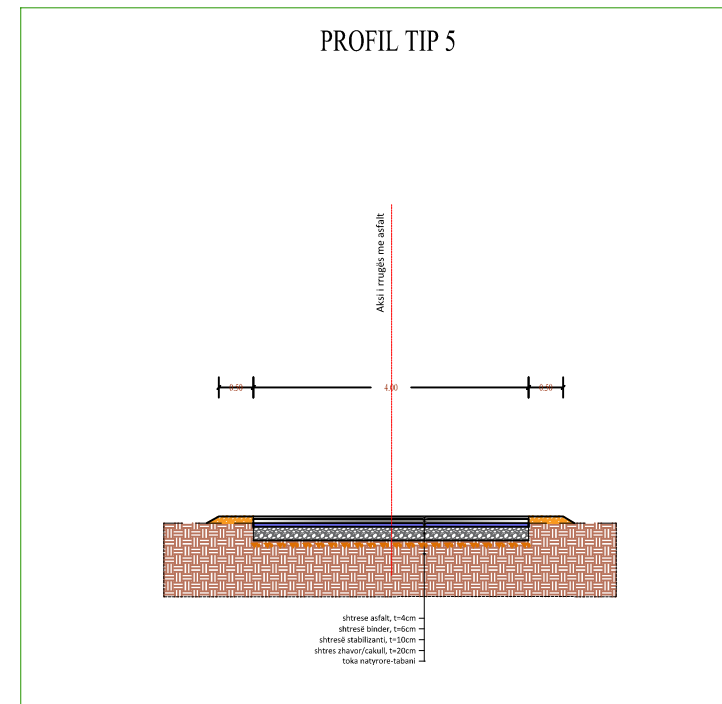

BASHKIA CERRIK



ZetaKonsult sh.p.k

Address:Rr."Myrteza Topi",Nd 18, Hyrja 7, Ap 38, TIRANE
Cel:+355 (0)69 33 52 077
e-mail:zetakonsultshpk@gmail.com



EMERTIMI I OBJEKTIT:
NDERTIM I SHESHIT REKREATIV SHTERMEN,BASHKIA
CERRIK

FAZA E PROJEKTIT :PROJEKT ZBATIMI

EMERTESA E FLETES
PROFILET TIP

SHKALLA Shk:1/200

FLETA 06

GRUPI I PROJEKTIMIT:

Inxh. Ndert.Lorenc HOXHA
Inxh.Ndert.Flutura Duro

Dt10/09/2024

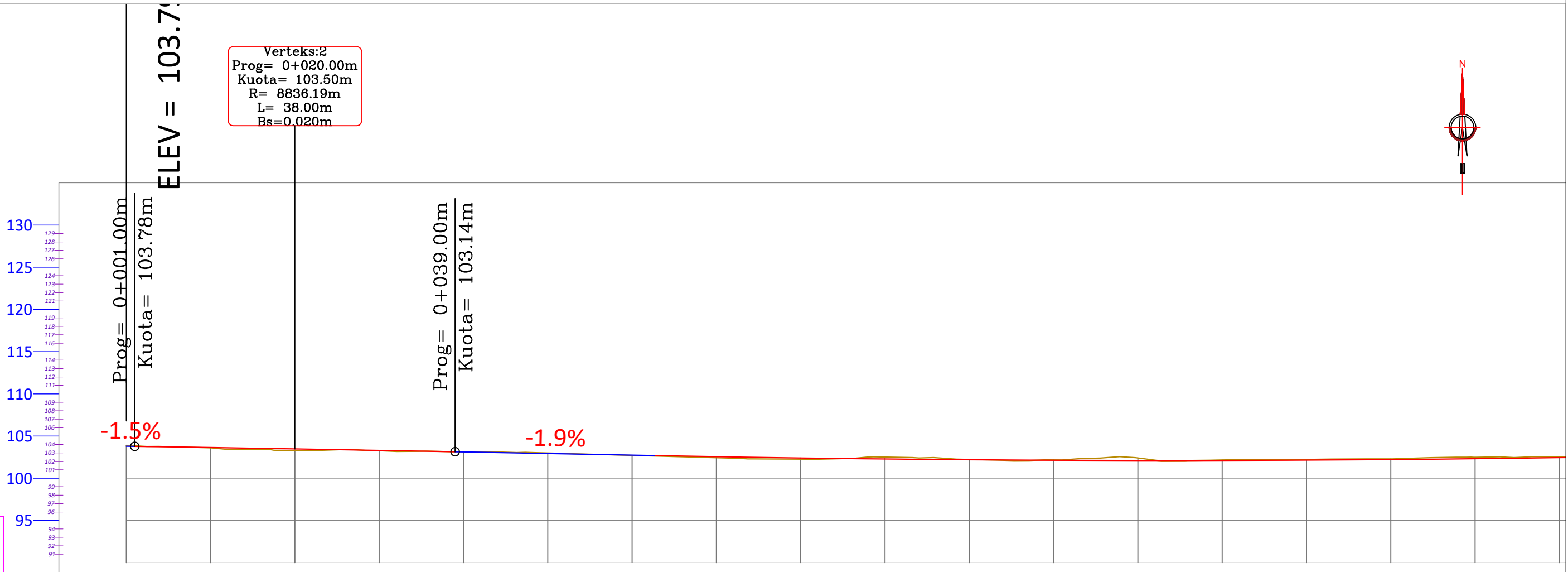

FORMATI A3

Profil Gjatesor SH 1:500



PROFILI GJATESOR
Aks Pedonale Kryesore
SH_H - 1:1000
SH_V - 1:1000



NR I PRERJES	PK - 1	PK - 2	PK - 3	PK - 4	PK - 5	PK - 6	PK - 7	PK - 8	PK - 9	PK - 10	PK - 11	PK - 12	PK - 13	PK - 14	PK - 15	PK - 16	PK - 17	PK - 18		
DIST. PJESORE	10.0 m	10.0 m	10.0 m	10.0 m	10.0 m	10.0 m	10.0 m	10.0 m	10.0 m	10.0 m	10.0 m	10.0 m	10.0 m	10.0 m	10.0 m	10.0 m	10.0 m	10.0 m		
DIST. PROGRESIVE	0+000	0+010	0+020	0+030	0+040	0+050	0+060	0+070	0+080	0+090	0+100	0+110	0+120	0+130	0+140	0+150	0+160	0+170		
KUOTA TOKES	103.91	103.60	103.28	103.27	103.14	102.99	102.71	102.43	102.27	102.51	102.23	102.17	102.40	102.17	102.23	102.30	102.49	102.52		
KUOTA PROJEKTIT	103.80	103.64	103.48	103.30	103.12	102.93	102.74	102.55	102.40	102.28	102.19	102.13	102.11	102.11	102.15	102.21	102.31	102.44		
KUOTA PUNES	0.11	-0.04	-0.20	-0.03	0.02	0.07	-0.03	-0.13	-0.14	0.23	0.04	0.04	0.29	0.06	0.08	0.08	0.18	0.08		
GJEO. HORIZONTALE	L=9.52		$\varphi = 4^{\circ}27'32''$ L=12.69 R=163.11		L=13.17		$\varphi = 9^{\circ}35'46''$ L=17.51 R=104.58		L=19.70			$\varphi = 80^{\circ}1'37''$ L=11.27 R=0.91		L=48.21		$\varphi = 85^{\circ}36'08''$ L=11.22 R=0.82		L=54.86		
GJEO. VERTIKALE	$i = -1.48\%$		R = 8836.19 K = 38.00		$L = 23.80$ $i = -1.91\%$					R = 3189.52 K = 114.03										
KILOMETRAZHI	0.01		0.04		0.06		0.08		0.10		0.12		0.14		0.16					

 <p>BASHKIA CERRIK</p>	<p>ZetaKonsult sh.p.k</p> <p>Address:Rr."Myrteza Topi",Nd 18, Hyrja 7, Ap 38, TIRANE</p> <p>Cel:+355 (0)69 33 52 077</p> <p>e-mail:zetakonsultshpk@gmail.com</p> 	<p>EMERTIMI I OBJEKTIT:</p> <p>NDERTIM I SHESHIT REKREATIV SHTERMEN,BASHKIA CERRIK</p>		<p>EMERTESA E FLETES</p> <p>PROFIL GJATESOR(pedonale kryesore)</p>		<p>GRUPI I PROJEKTIMIT:</p> <p>Inxh. Ndert.Lorenc HOXHA</p> <p>Inxh.Ndert.Flutura Duro</p>		<p>Dt10/09/2024</p>
		<p>FAZA E PROJEKTIT :PROJEKT ZBATIMI</p>		<p>SHKALLA Shk:1/500</p>	<p>FLETA 07</p>	<p>FORMATI A3</p>		

Profil Gjatesor SH 1:500

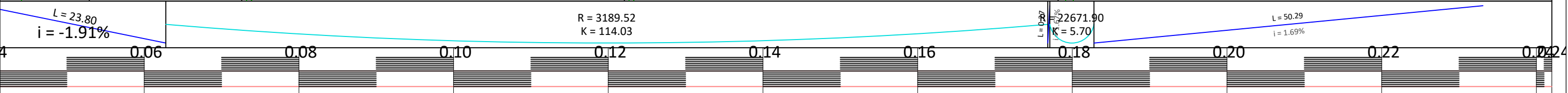
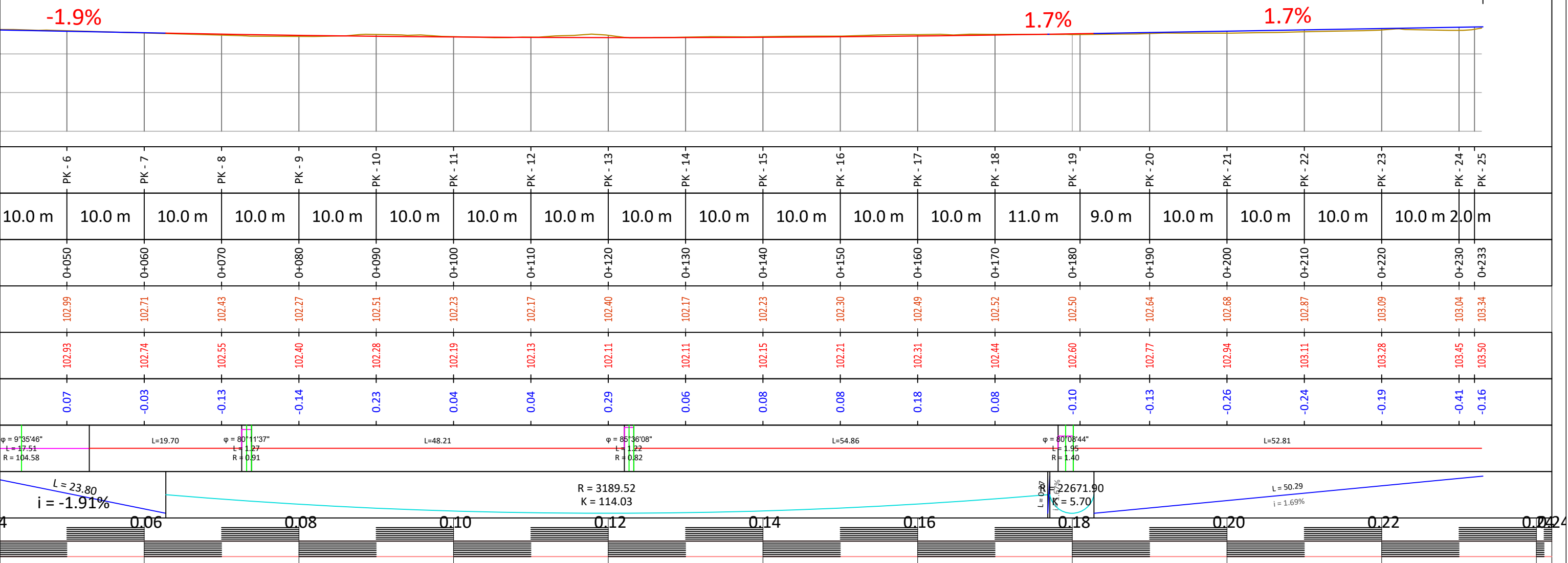
ELEV = 103.50



 <p>BASHKIA CERRIK</p>	<p>ZetaKonsult sh.p.k</p> <p>Address:Rr."Myrteza Topi",Nd 18, Hyrja 7, Ap 38, TIRANE</p> <p>Cel:+355 (0)69 33 52 077</p> <p>e-mail:zetakonsultshpk@gmail.com</p> 	<p>EMERTIMI I OBJEKTIT:</p> <p>NDERTIM I SHESHIT REKREATIV SHTERMEN,BASHKIA CERRIK</p>		<p>EMERTESA E FLETES</p> <p>PROFIL GJATESOR(pedonale kryesore)</p>		<p>GRUPI I PROJEKTIMIT:</p> <p>Inxh. Ndert.Lorenc HOXHA</p> <p>Inxh.Ndert.Flutura Duro</p>		<p>Dt10/09/2024</p>
		<p>FAZA E PROJEKTIT :PROJEKT ZBATIMI</p>		<p>SHKALLA Shk:1/500</p>	<p>FLETA 08</p>	<p>FORMATI A3</p>		

Profilet Terthore SH 1:250

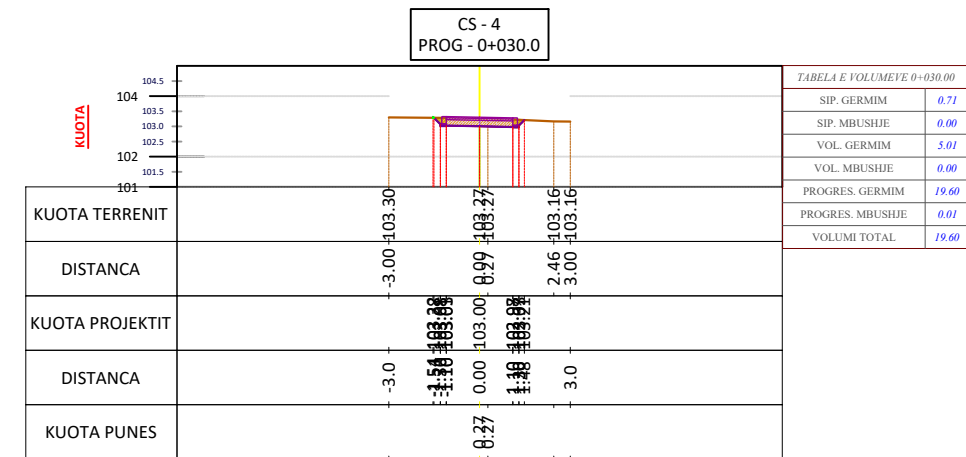
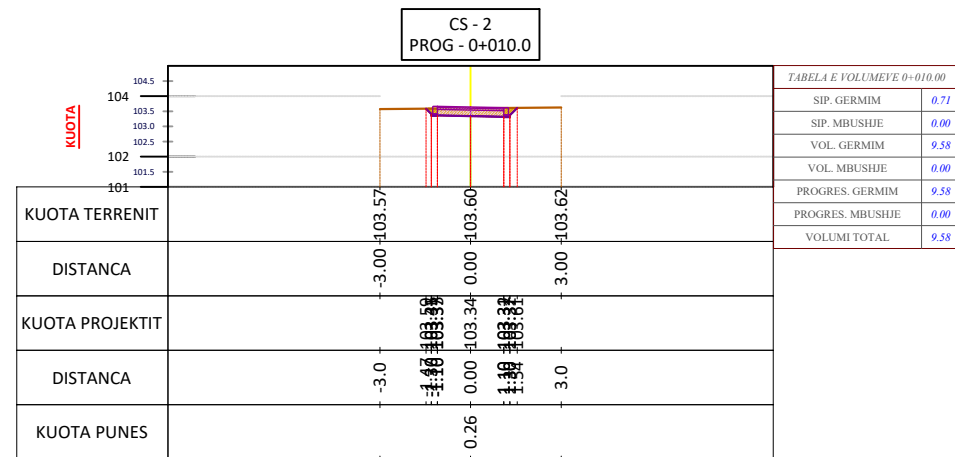
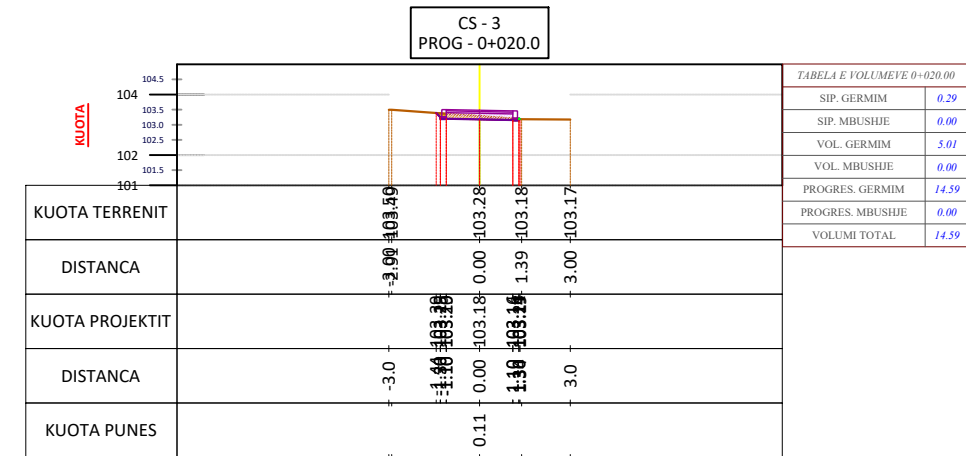
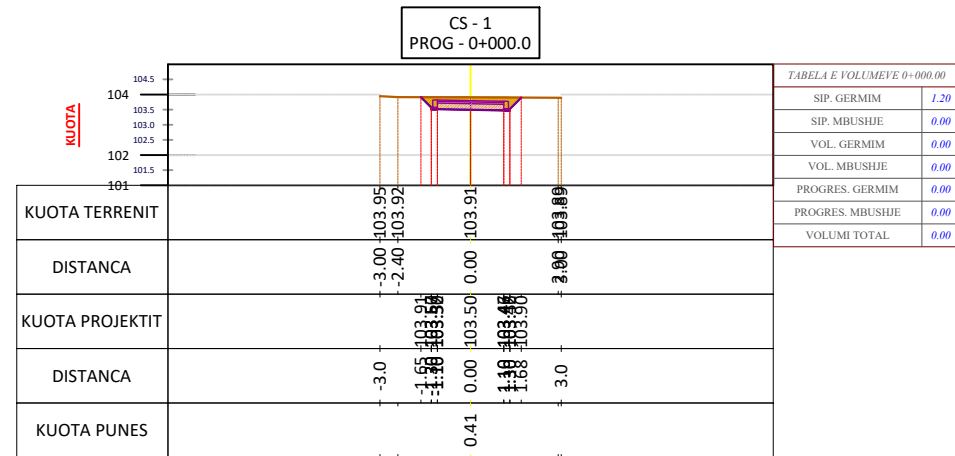

BASHKIA CERRIK



ZetaKonsult sh.p.k

Address: Rr. "Myrteza Topi", Nd 18, Hyrja 7, Ap 38, TIRANE

Cel: +355 (0)69 33 52 077

e-mail: zetakonsultshpk@gmail.com



EMERTIMI I OBJEKTIT:

NDERTIM I SHESHIT REKREATIV SHTERMEN, BASHKIA CERRIK

FAZA E PROJEKTIT : PROJEKT ZBATIMI

EMERTESA E FLETES
PROFLET TERTHORE (pedonale kryesore)

SHKALLA Shk: 1/250

FLETA 09

GRUPI I PROJEKTIMIT:

Inxh. Ndert. Lorenc HOXHA
Inxh. Ndert. Flutura Duro

Dt 10/09/2024

FORMATI A3

Profilet Terthore SH 1:250

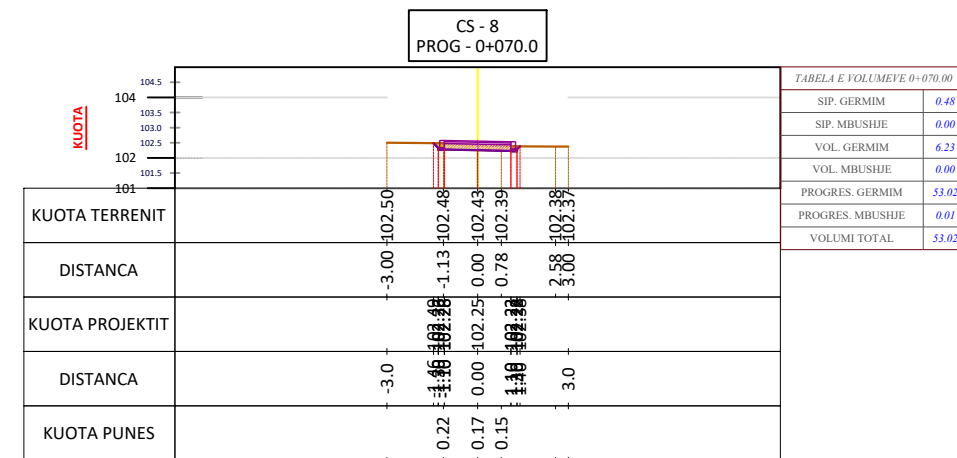
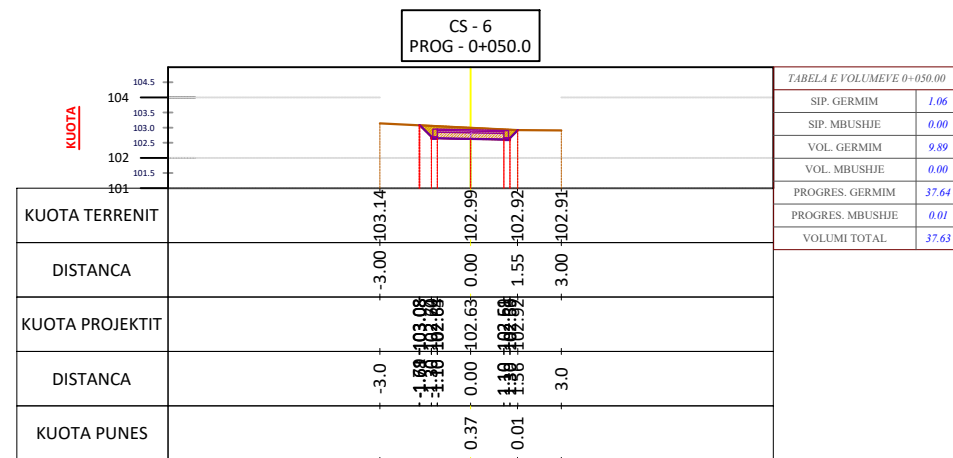
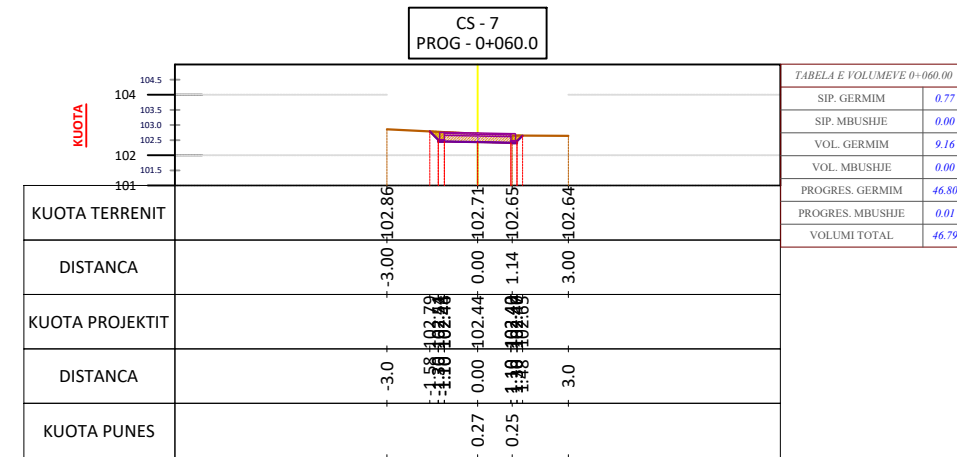
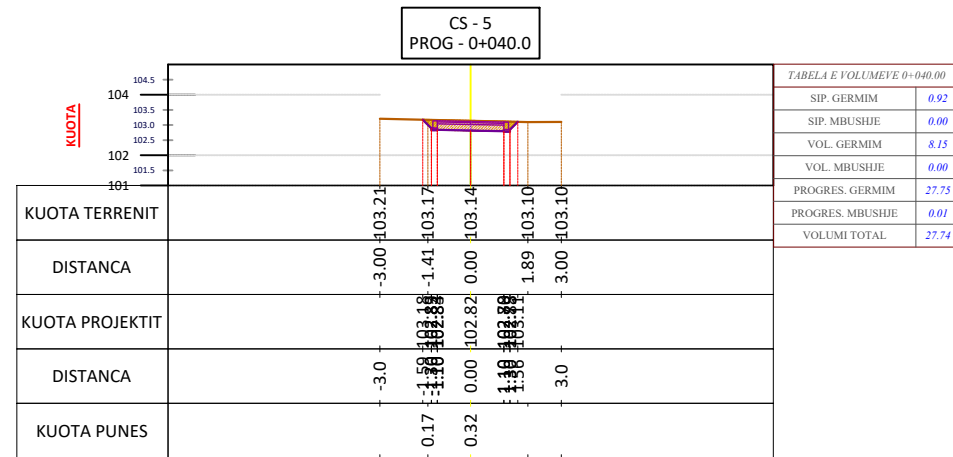

Profilet Terthore SH 1:250

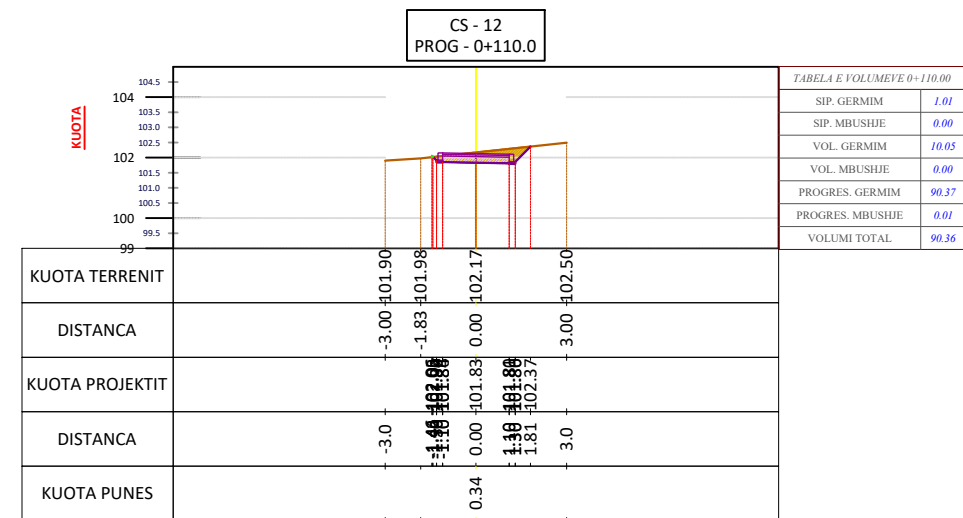
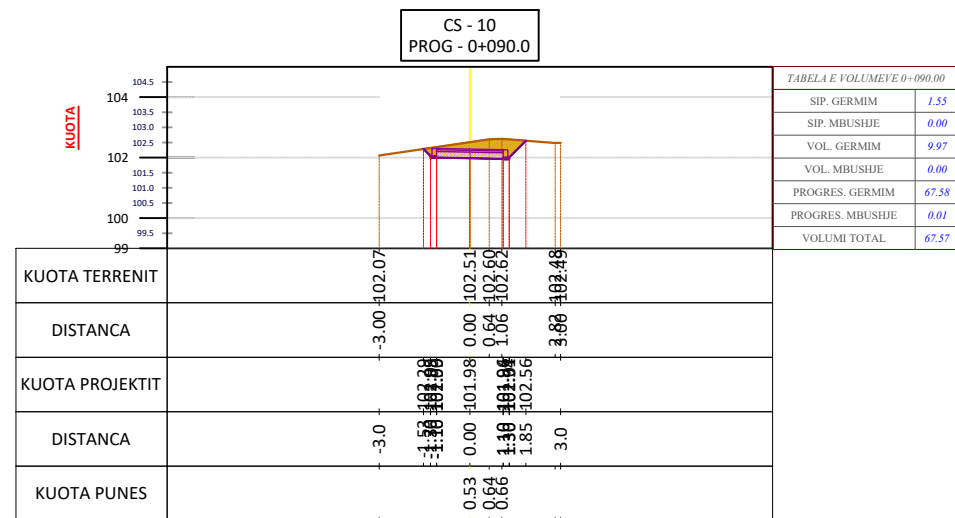
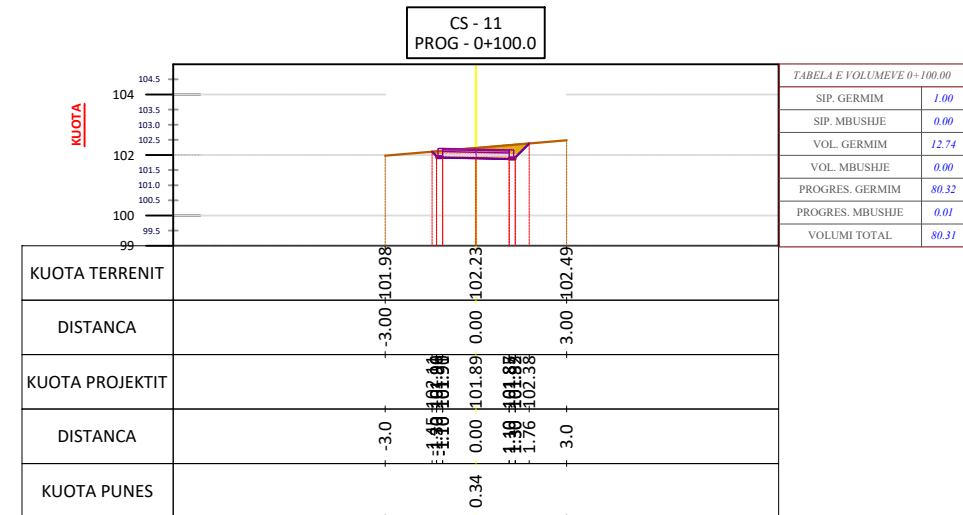
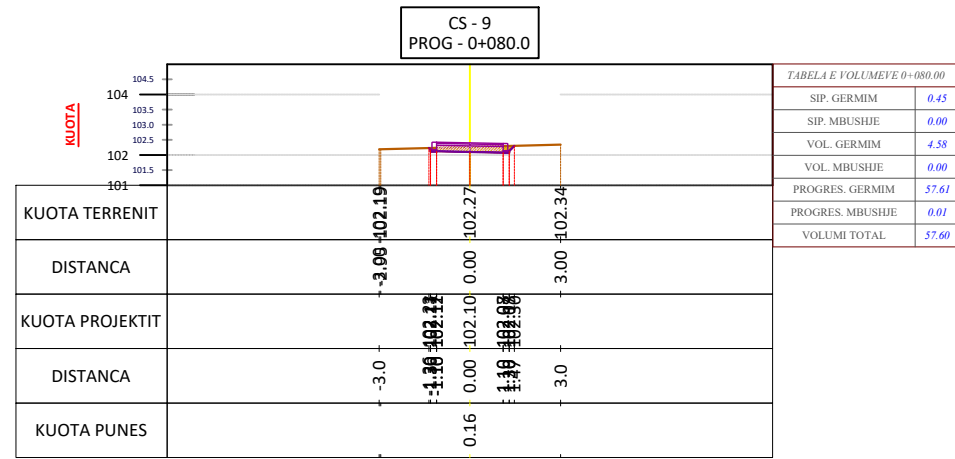

BASHKIA CERRIK



ZetaKonsult sh.p.k

Address: Rr. "Myrteza Topi", Nd 18, Hyrja 7, Ap 38, TIRANE

Cel: +355 (0)69 33 52 077

e-mail: zetakonsultshpk@gmail.com



EMERTIMI I OBJEKTIT:

NDERTIM I SHESHIT REKREATIV SHTERMEN, BASHKIA CERRIK

FAZA E PROJEKTIT : PROJEKT ZBATIMI

EMERTESA E FLETES

PROFLET TERTHORE (pedonale kryesore)

SHKALLA Shk: 1/250

FLETA 11

GRUPI I PROJEKTIMIT:

Inxh. Ndert. Lorenc HOXHA
Inxh. Ndert. Flutura Duro

Dt 10/09/2024

FORMATI A3

Profilet Terthore SH 1:250

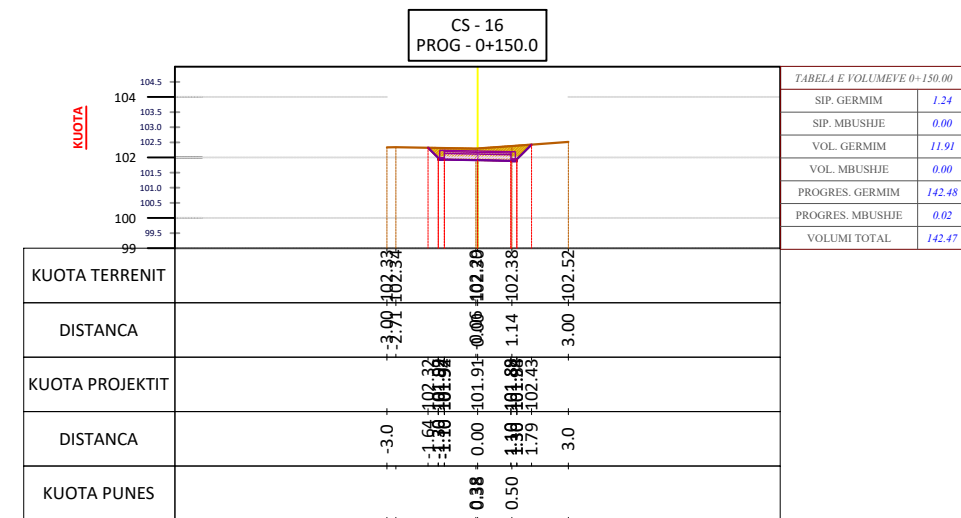
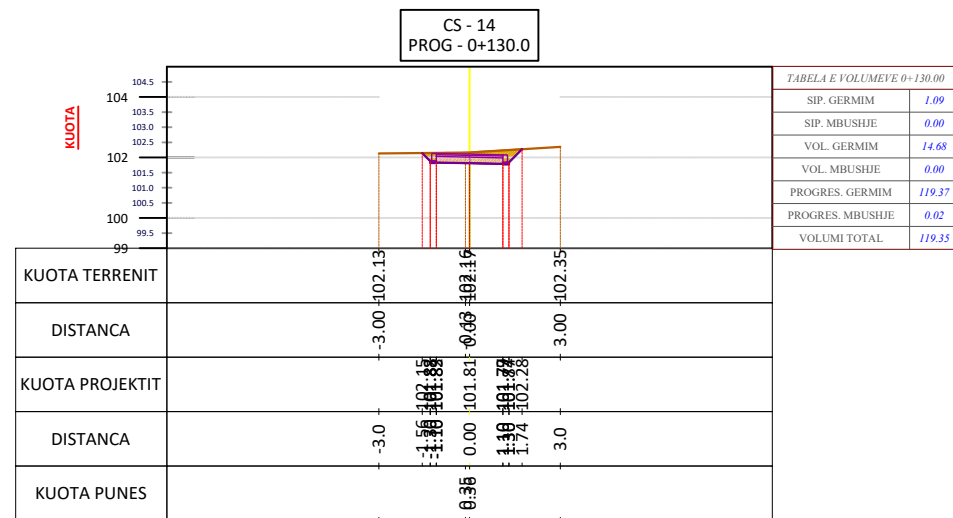
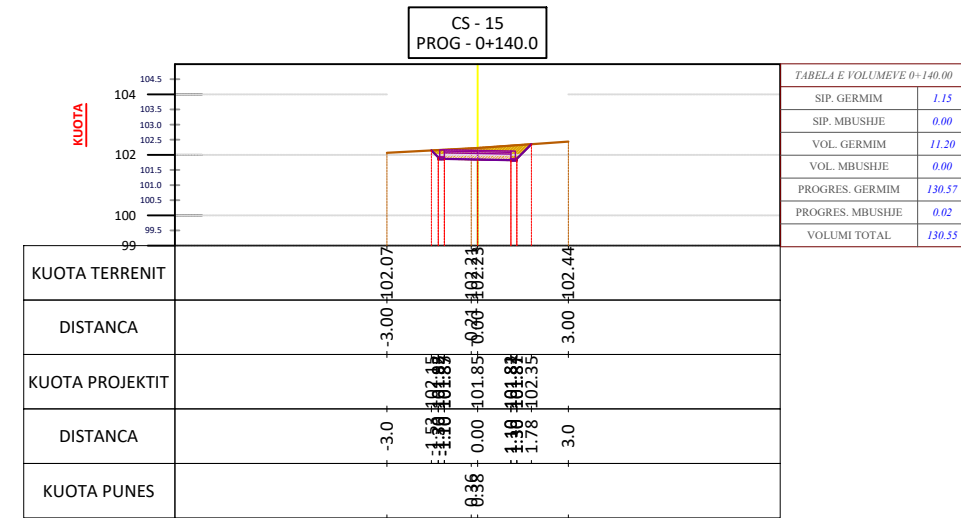
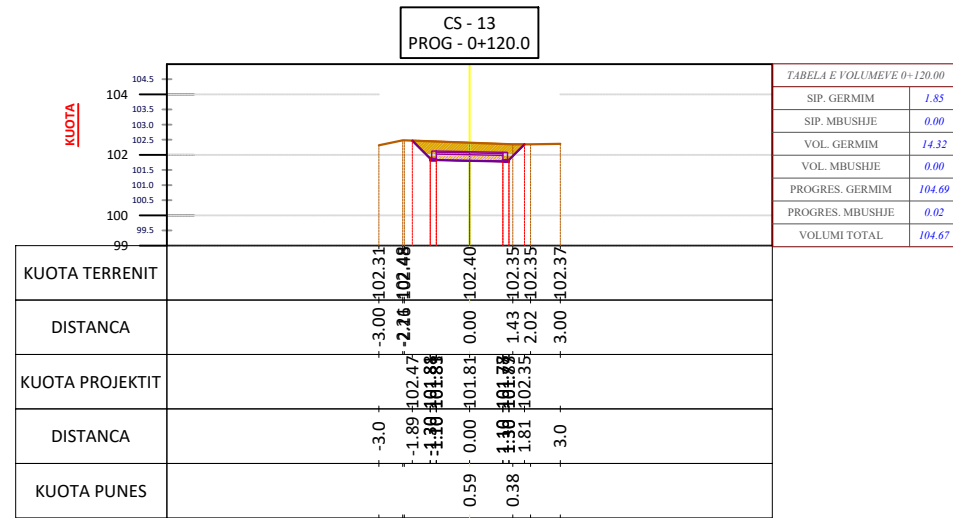

Profilet Terthore SH 1:250

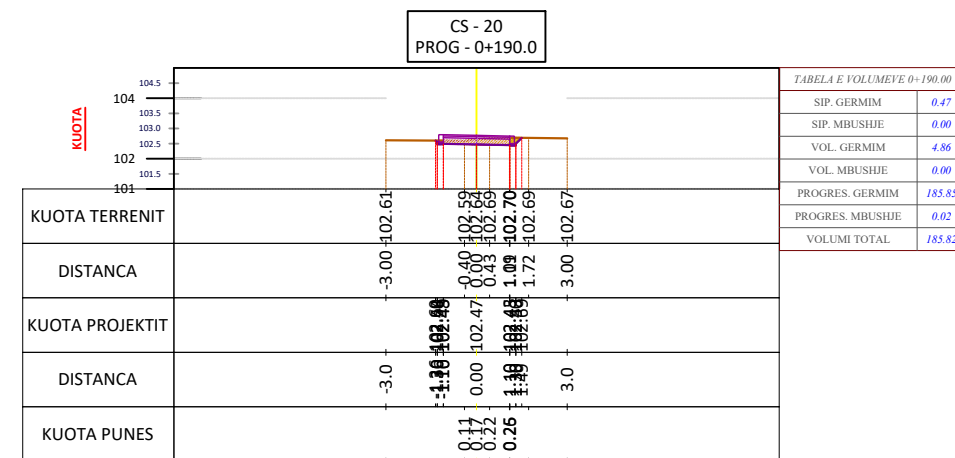
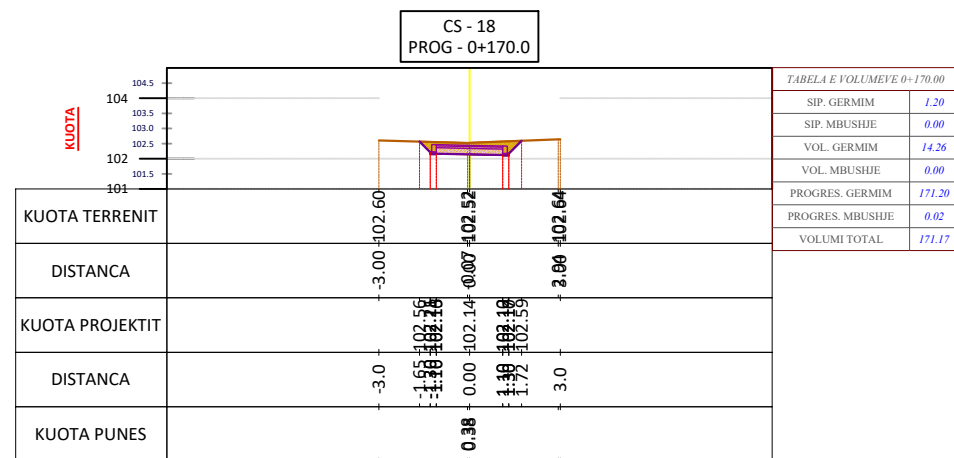
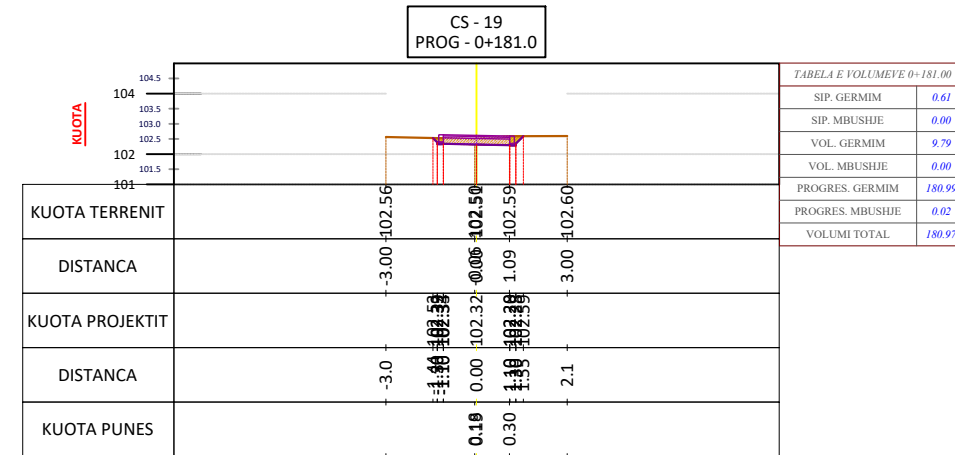
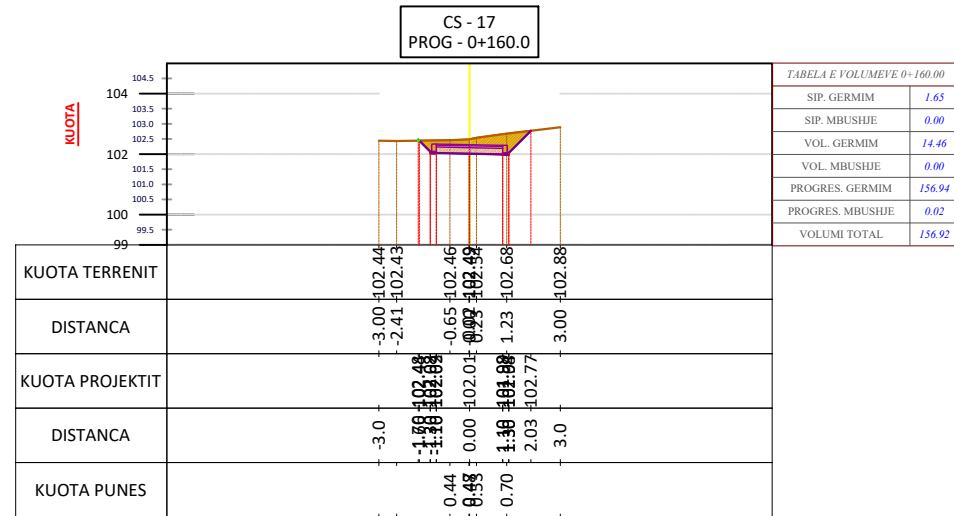

Profilet Terthore SH 1:250

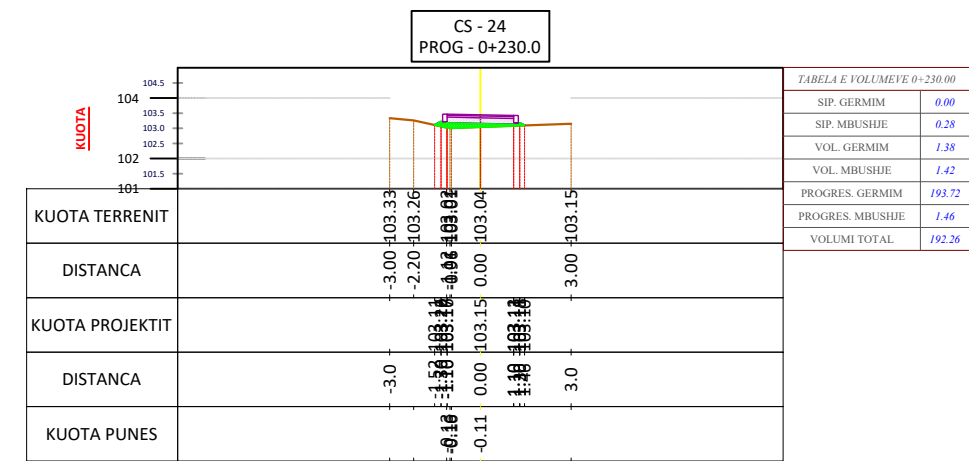
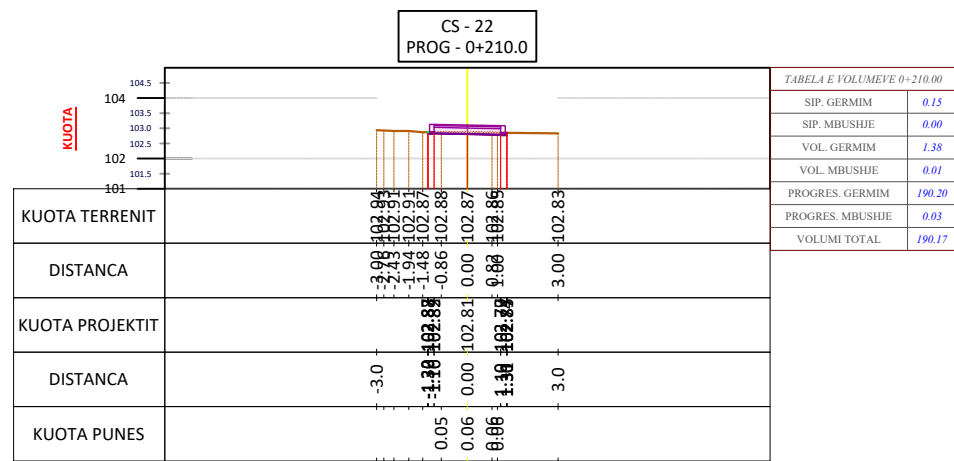
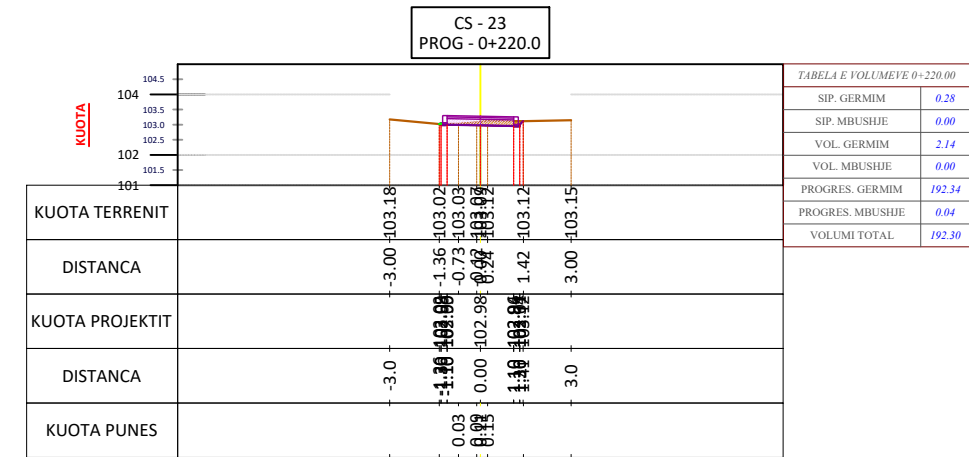
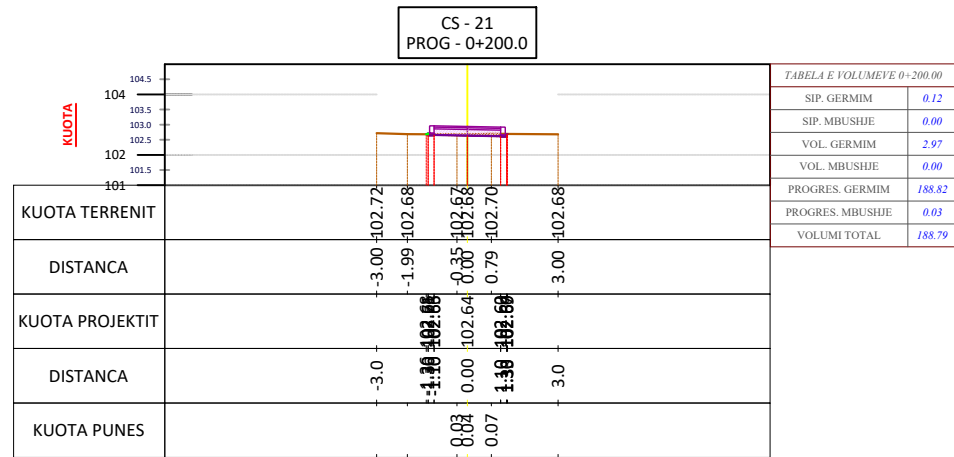

BASHKIA CERRIK



ZetaKonsult sh.p.k

Address:Rr."Myrteza Topi",Nd 18, Hyrja 7, Ap 38, TIRANE

Cel: +355 (0)69 33 52 077

e-mail:zetakonsultshpk@gmail.com



EMERTIMI I OBJEKTIT:
NDERTIM I SHESHIT REKREATIV SHTERMEN, BASHKIA CERRIK

FAZA E PROJEKTIT :PROJEKT ZBATIMI

EMERTESA E FLETES
PROFLET TERTHORE(pedonale kryesore)

SHKALLA Shk:1/250

FLETA 14

GRUPI I PROJEKTIMIT:

Inxh. Ndert.Lorenc HOXHA
Inxh.Ndert.Flutura Duro

Dt10/09/2024

FORMATI A3

Profillet Terthore SH 1:250

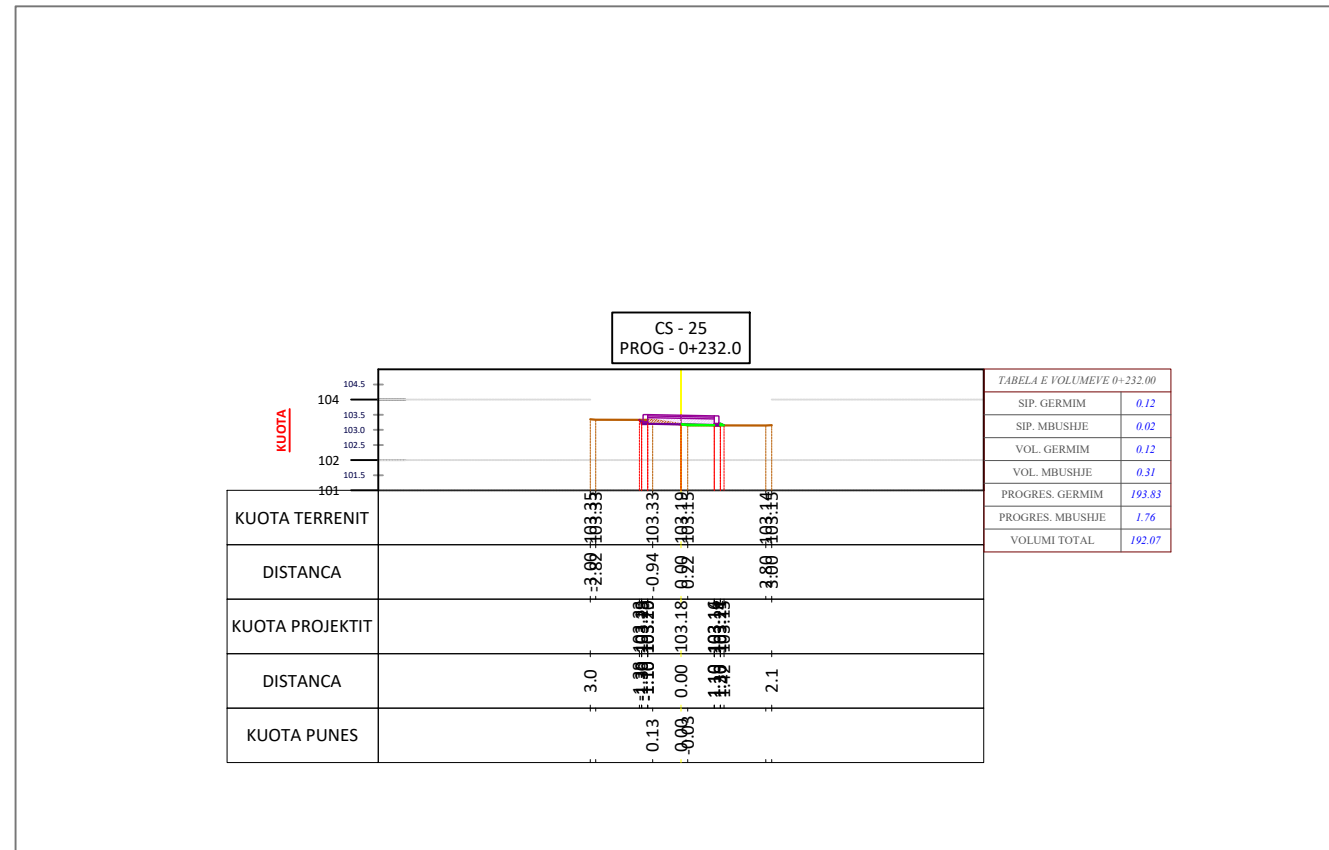

BASHKIA CERRIK



ZetaKonsult sh.p.k

Address: Rr. "Myrteza Topi", Nd 18, Hyrja 7, Ap 38, TIRANE

Cel: +355 (0)69 33 52 077

e-mail: zetakonsultshpk@gmail.com



EMERTIMI I OBJEKTIT:

NDERTIM I SHESHIT REKREATIV SHTERMEN, BASHKIA CERRIK

FAZA E PROJEKTIT : PROJEKT ZBATIMI

EMERTESA E FLETES
PROFILLET TERTHORE (pedonale kryesore)

SHKALLA Shk: 1/250

FLETA 15

GRUPI I PROJEKTIMIT:

Inxh. Ndert. Lorenc HOXHA
Inxh. Ndert. Flutura Duro

Dt 10/09/2024

FORMATI A3

Tabela Volumeve SH 1:250



VOLUMET

Station	Fill Area	Cut Area	Fill Volume	Cut Volume	Cumulative Fill Vol	Cumulative Cut Vol
0+000.00	0.00	1.20	0.00	0.00	0.00	0.00
0+010.00	0.00	0.71	0.00	9.58	0.00	9.58
0+020.00	0.00	0.29	0.00	5.01	0.00	14.59
0+030.00	0.00	0.71	0.00	5.01	0.01	19.60
0+040.00	0.00	0.92	0.00	8.15	0.01	27.75
0+050.00	0.00	1.06	0.00	9.89	0.01	37.64
0+060.00	0.00	0.77	0.00	9.16	0.01	46.80
0+070.00	0.00	0.48	0.00	6.23	0.01	53.02
0+080.00	0.00	0.45	0.00	4.58	0.01	57.61
0+090.00	0.00	1.55	0.00	9.97	0.01	67.58
0+100.00	0.00	1.00	0.00	12.74	0.01	80.32
0+110.00	0.00	1.01	0.00	10.05	0.01	90.37
0+120.00	0.00	1.85	0.00	14.32	0.02	104.69
0+130.00	0.00	1.09	0.00	14.68	0.02	119.37
0+140.00	0.00	1.15	0.00	11.20	0.02	130.57
0+150.00	0.00	1.24	0.00	11.91	0.02	142.48
0+160.00	0.00	1.65	0.00	14.46	0.02	156.94
0+170.00	0.00	1.20	0.00	14.26	0.02	171.20
0+181.00	0.00	0.61	0.00	9.79	0.02	180.99
0+190.00	0.00	0.47	0.00	4.86	0.02	185.85

VOLUMET

Station	Fill Area	Cut Area	Fill Volume	Cut Volume	Cumulative Fill Vol	Cumulative Cut Vol
0+200.00	0.00	0.12	0.00	2.97	0.03	188.82
0+210.00	0.00	0.15	0.01	1.38	0.03	190.20
0+220.00	0.00	0.28	0.00	2.14	0.04	192.34
0+230.00	0.28	0.00	1.42	1.38	1.46	193.72
0+232.00	0.02	0.12	0.31	0.12	1.76	193.83



Profil Gjatesor SH 1:500

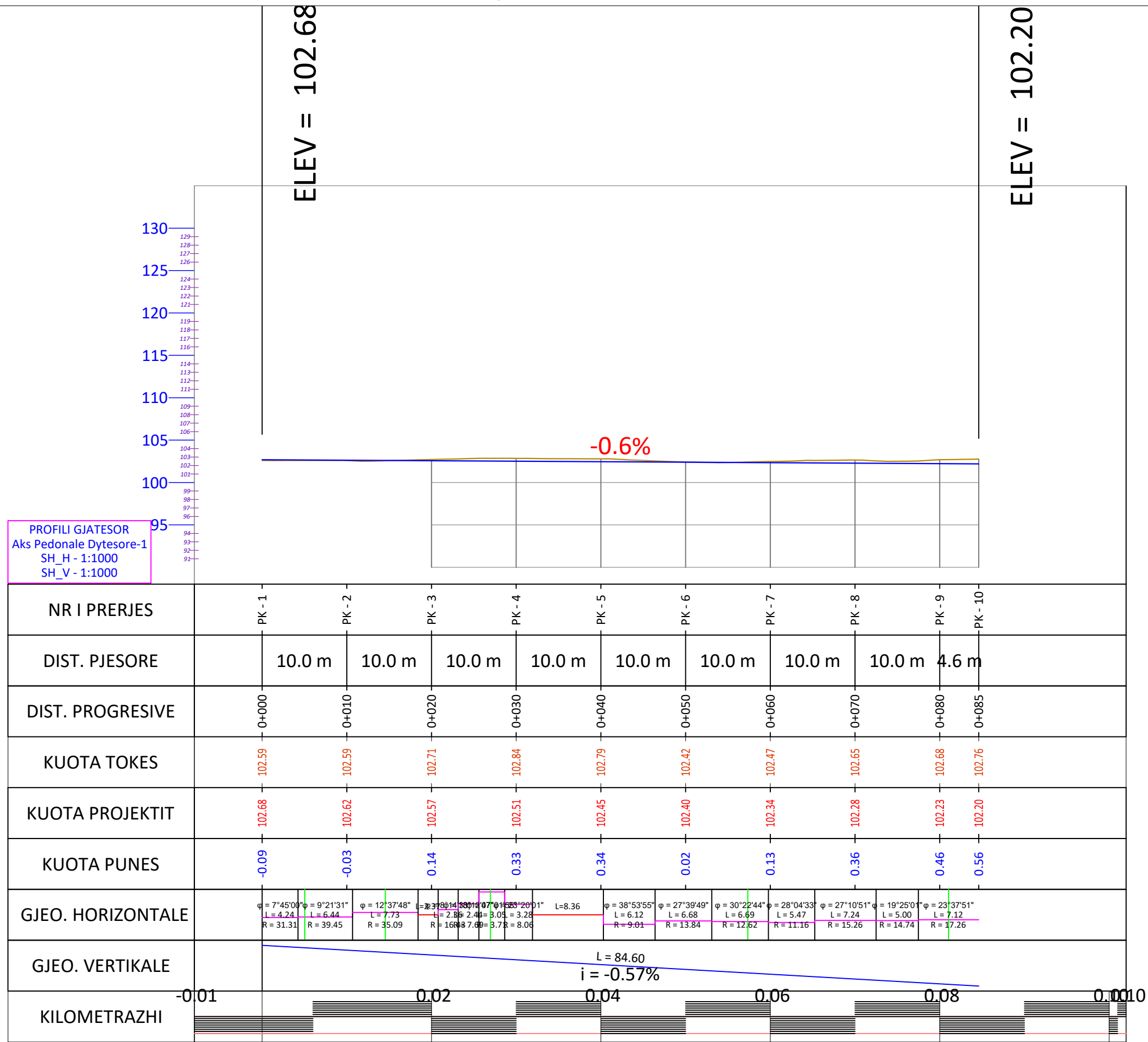

Profillet Terthore SH 1:250

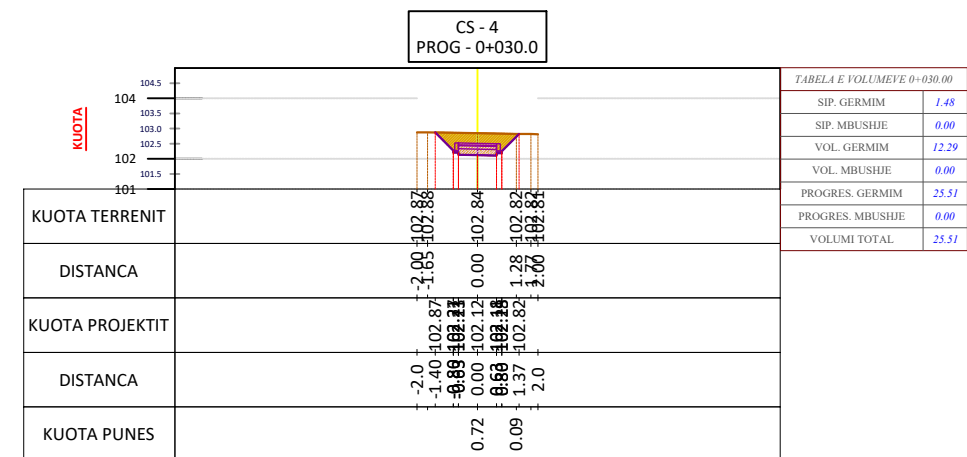
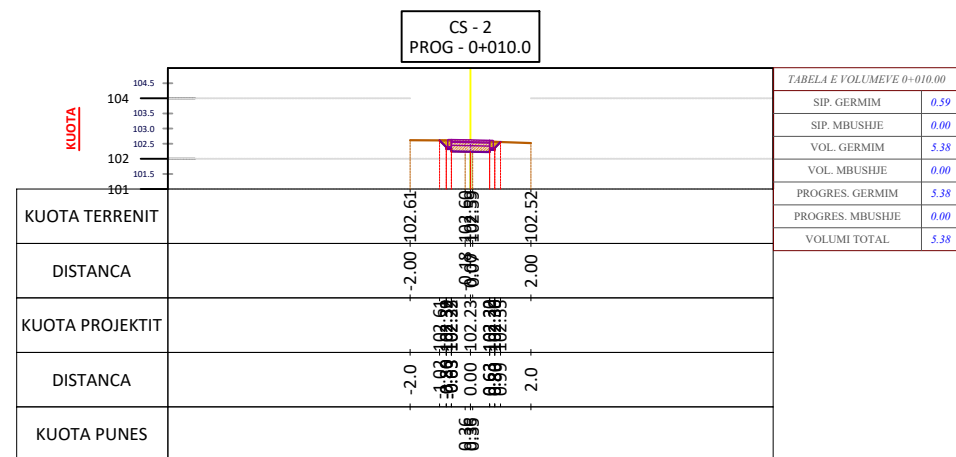
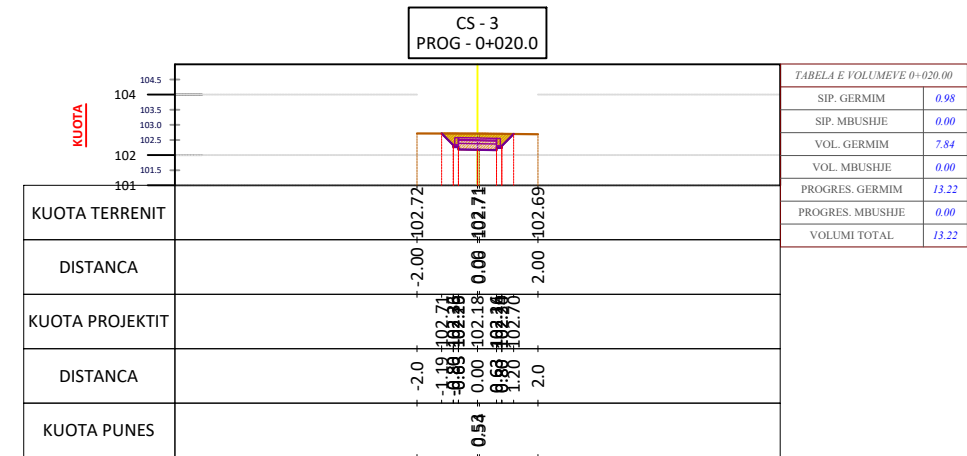
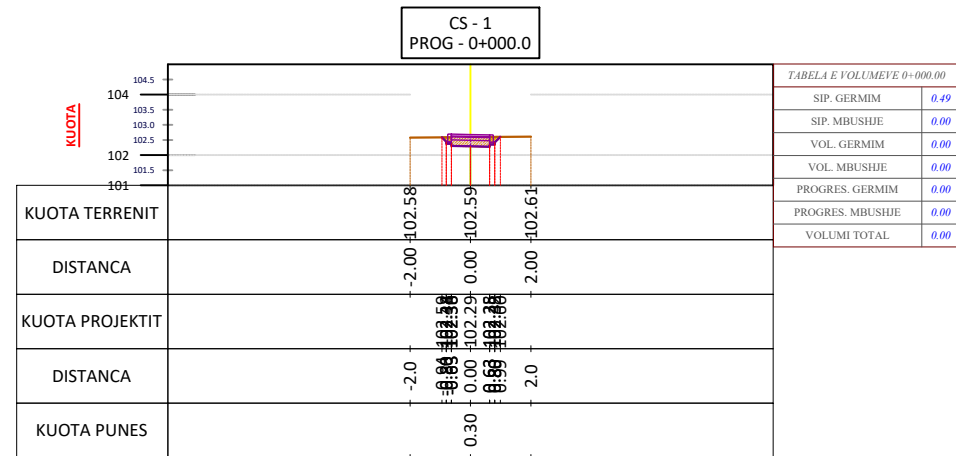

Profillet Terthore SH 1:250

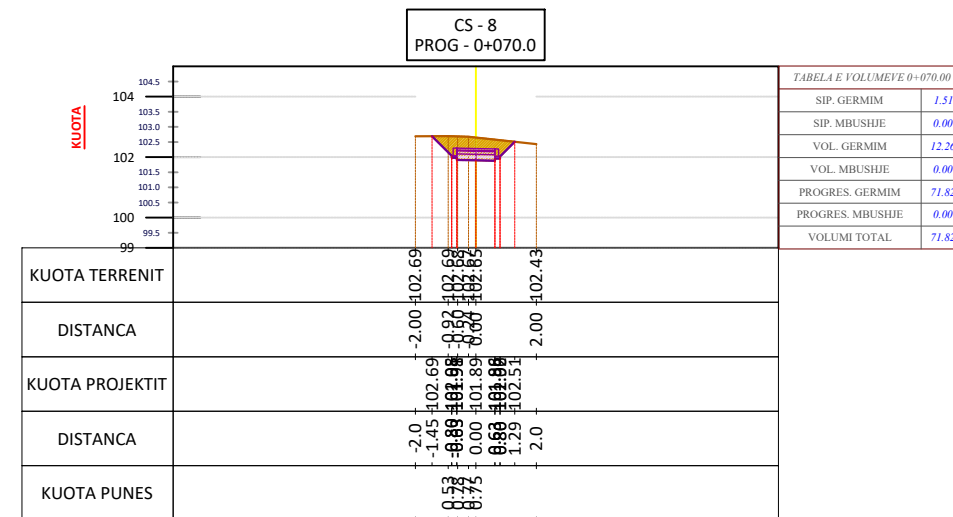
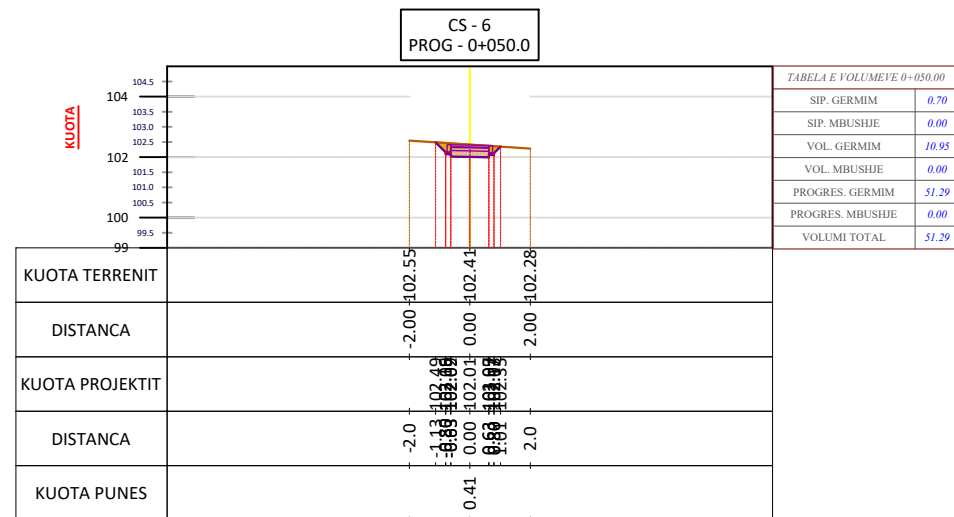
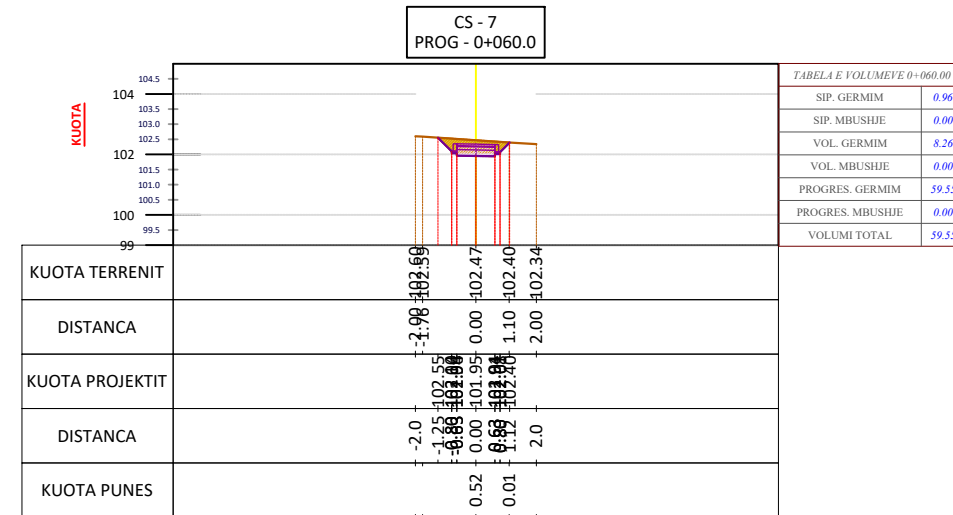
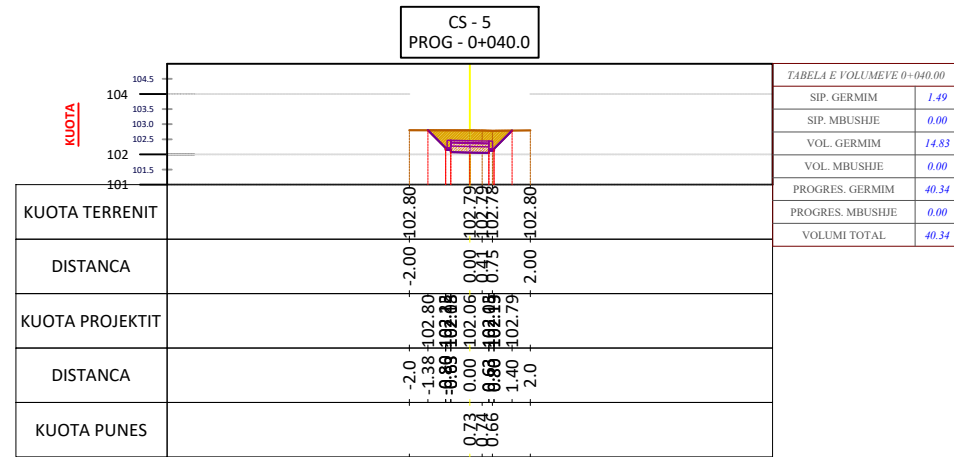

Profillet Terthore SH 1:250



Tabela Volumeve SH 1:250



VOLUMET						
Station	Fill Area	Cut Area	Fill Volume	Cut Volume	Cumulative Fill Vol	Cumulative Cut Vol
0+000.00	0.00	0.49	0.00	0.00	0.00	0.00
0+010.00	0.00	0.59	0.00	5.38	0.00	5.38
0+020.00	0.00	0.98	0.00	7.84	0.00	13.22
0+030.00	0.00	1.48	0.00	12.29	0.00	25.51
0+040.00	0.00	1.49	0.00	14.83	0.00	40.34
0+050.00	0.00	0.70	0.00	10.95	0.00	51.29
0+060.00	0.00	0.96	0.00	8.26	0.00	59.55
0+070.00	0.00	1.51	0.00	12.26	0.00	71.82
0+080.00	0.00	1.79	0.00	16.44	0.00	88.26
0+084.60	0.00	2.11	0.00	8.96	0.00	97.21

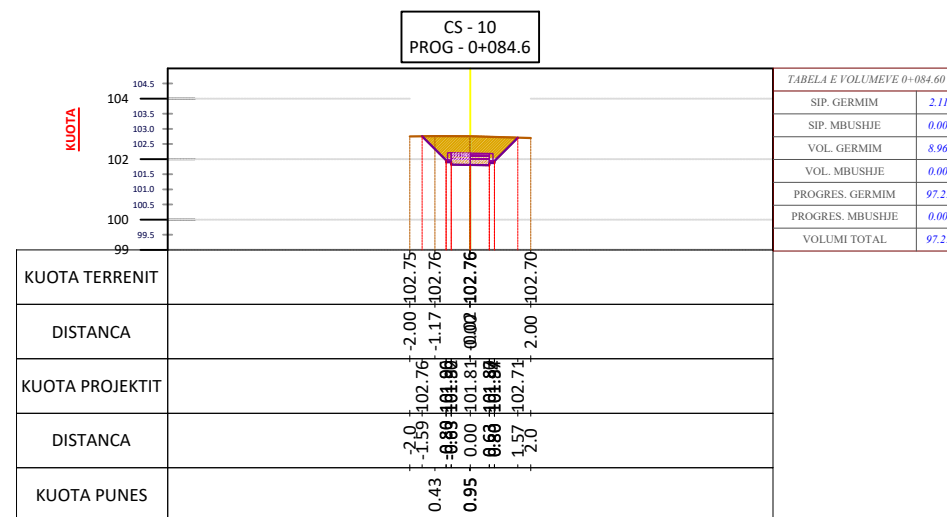
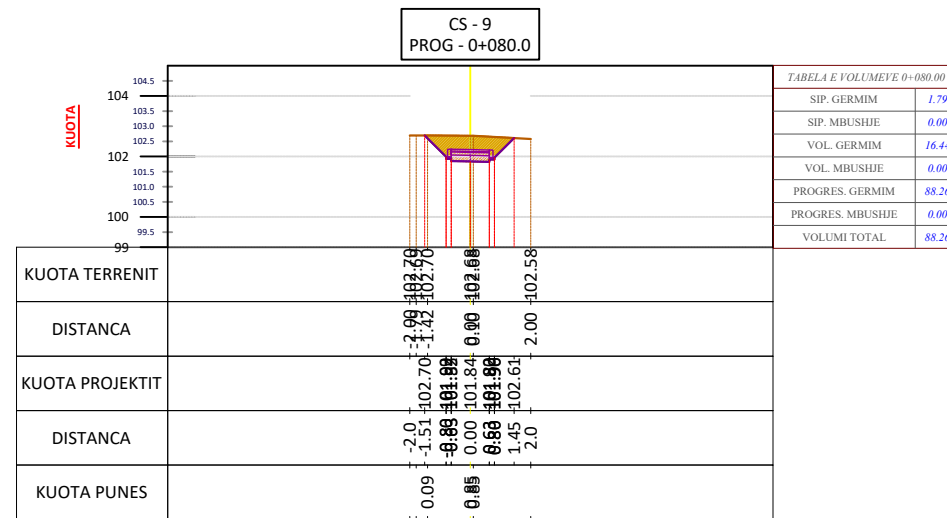

Profil Gjatesor SH 1:500

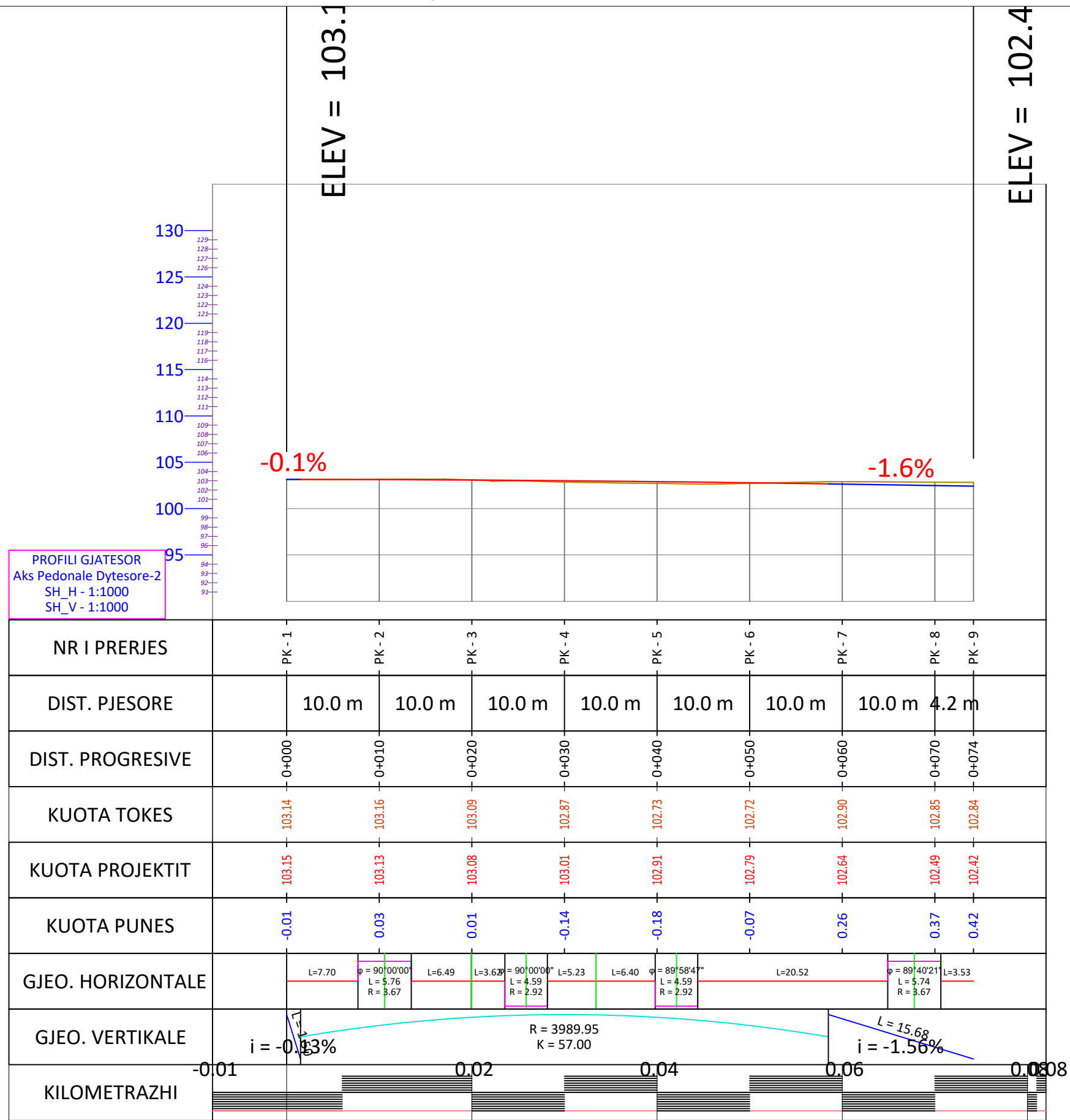

PROFILI GJATESOR
Aks Pedonale Dytesore-2
SH_H - 1:1000
SH_V - 1:1000



Profillet Terthore SH 1:250

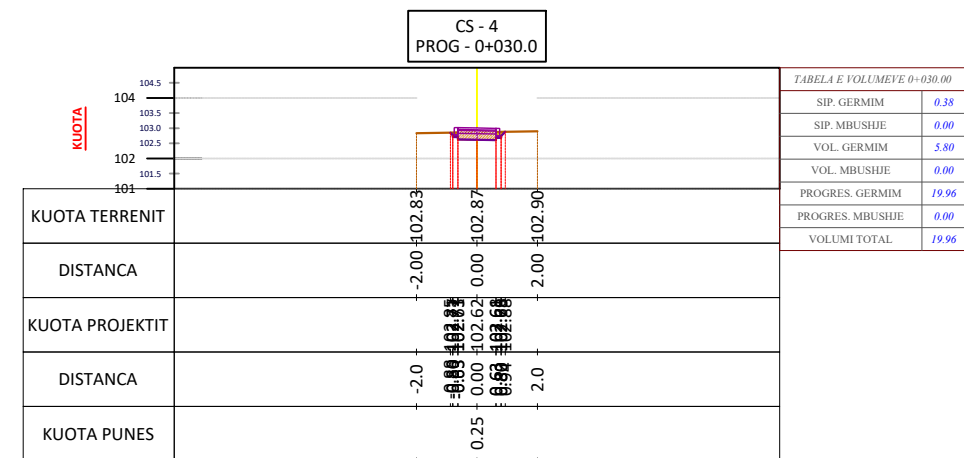
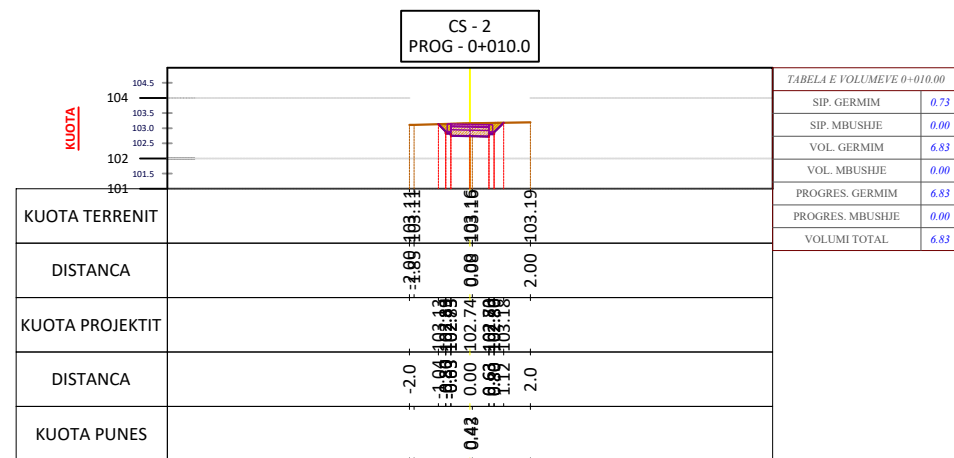
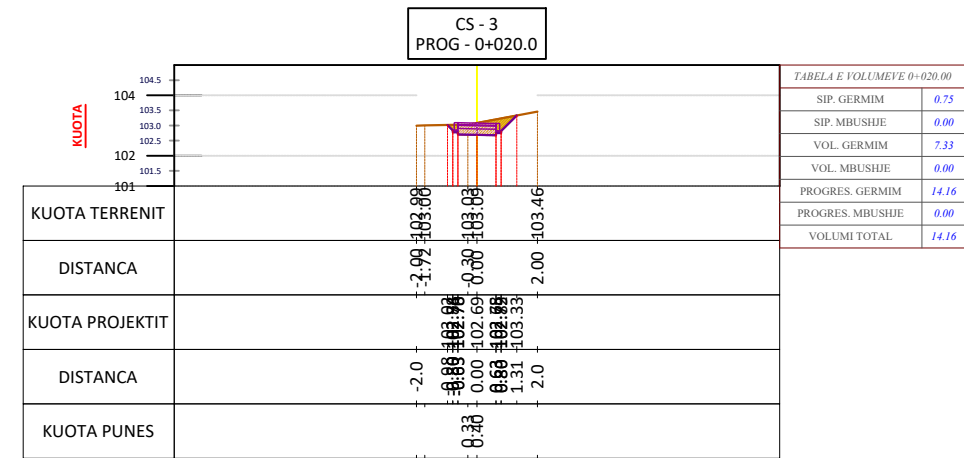
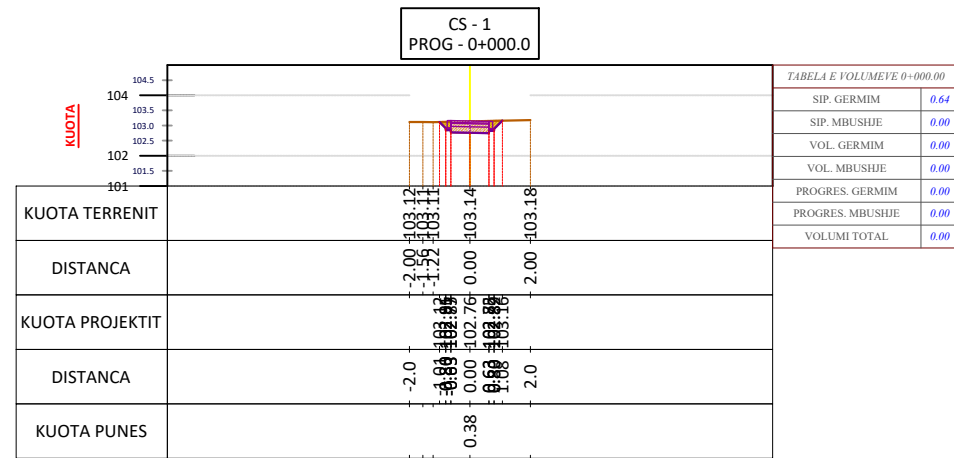

Profillet Terthore SH 1:250

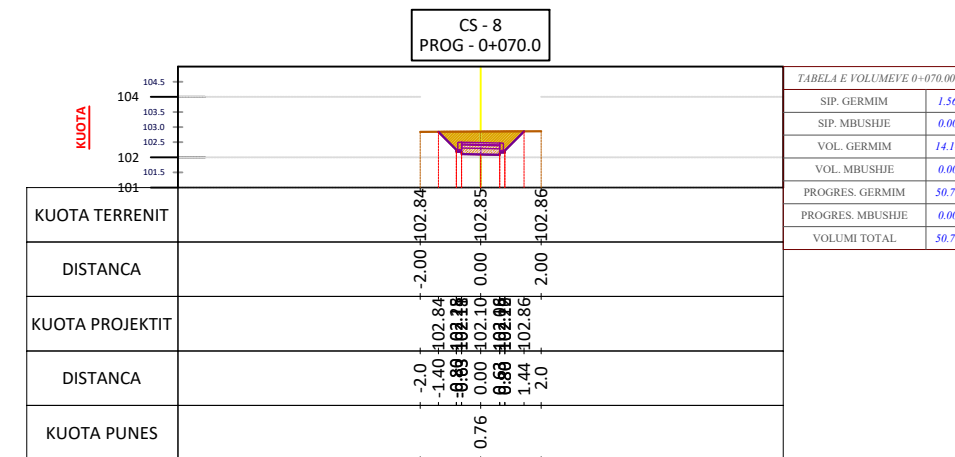
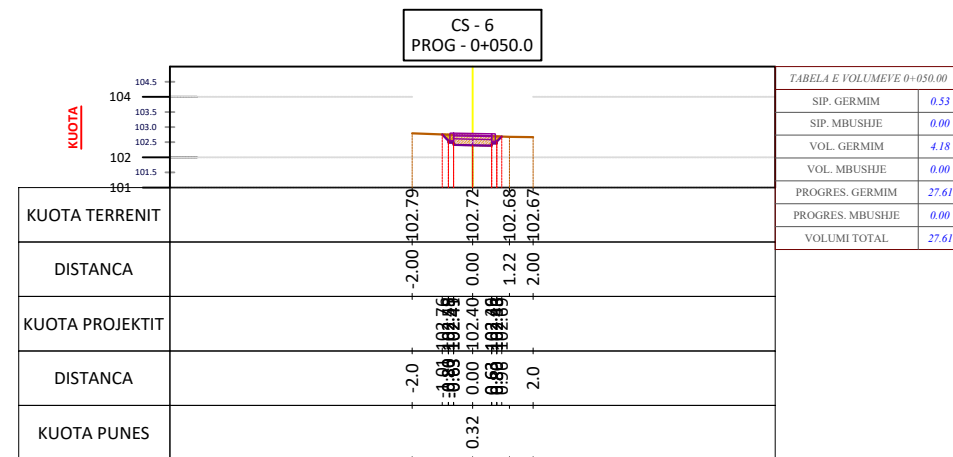
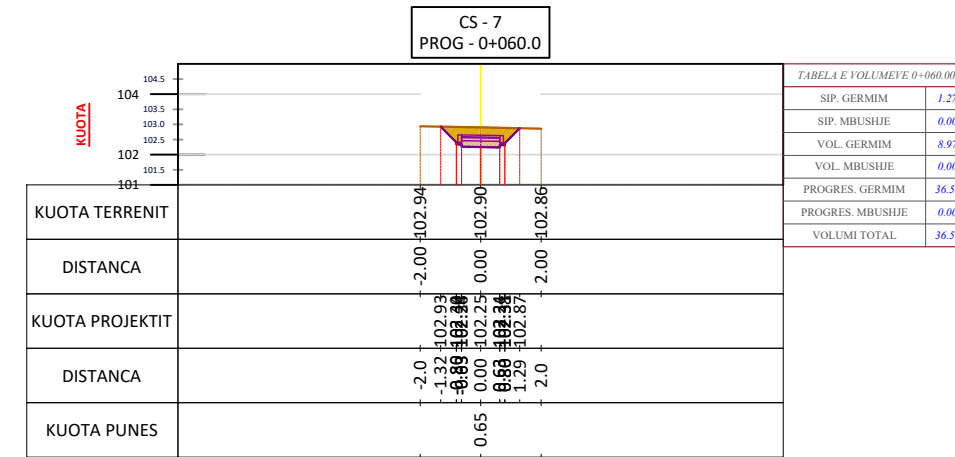
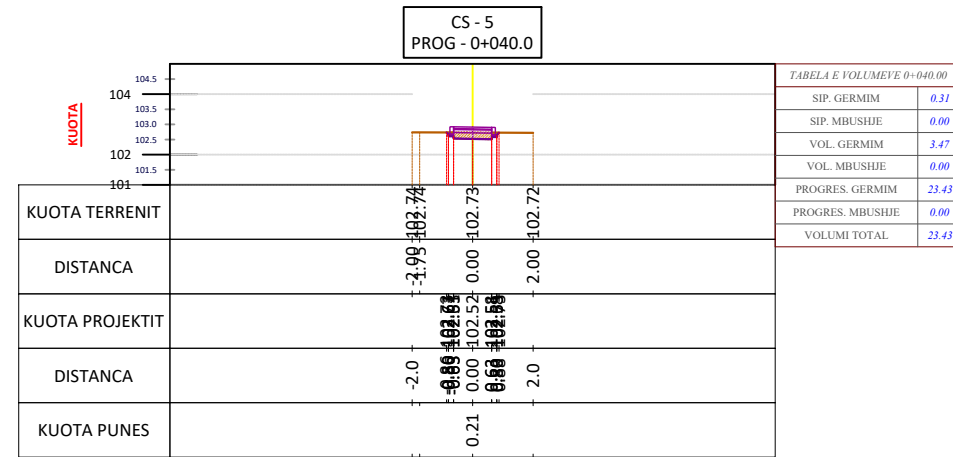

BASHKIA CERRIK



ZetaKonsult sh.p.k

Address: Rr. "Myrteza Topi", Nd 18, Hyrja 7, Ap 38, TIRANE

Cel: +355 (0)69 33 52 077

e-mail: zetakonsultshpk@gmail.com



EMERTIMI I OBJEKTIT:
NDERTIM I SHESHIT REKREATIV SHTERMEN, BASHKIA CERRIK

FAZA E PROJEKTIT : PROJEKT ZBATIMI

EMERTESA E FLETES
PROFLET TERTHORE (pedonale dytesore-2)

SHKALLA Shk: 1/250

FLETA 24

GRUPI I PROJEKTIMIT:

Inxh. Ndert. Lorenc HOXHA
Inxh. Ndert. Flutura Duro

Dt 10/09/2024

FORMATI A3

Profillet Terthore SH 1:250



Tabela Volumeve SH 1:250



VOLUMET						
Station	Fill Area	Cut Area	Fill Volume	Cut Volume	Cumulative Fill Vol	Cumulative Cut Vol
0+000.00	0.00	0.64	0.00	0.00	0.00	0.00
0+010.00	0.00	0.73	0.00	6.83	0.00	6.83
0+020.00	0.00	0.75	0.00	7.33	0.00	14.16
0+030.00	0.00	0.38	0.00	5.80	0.00	19.96
0+040.00	0.00	0.31	0.00	3.47	0.00	23.43
0+050.00	0.00	0.53	0.00	4.18	0.00	27.61
0+060.00	0.00	1.27	0.00	8.97	0.00	36.58
0+070.00	0.00	1.56	0.00	14.14	0.00	50.73
0+074.18	0.00	1.71	0.00	6.83	0.00	57.56

BASHKIA CERRIK

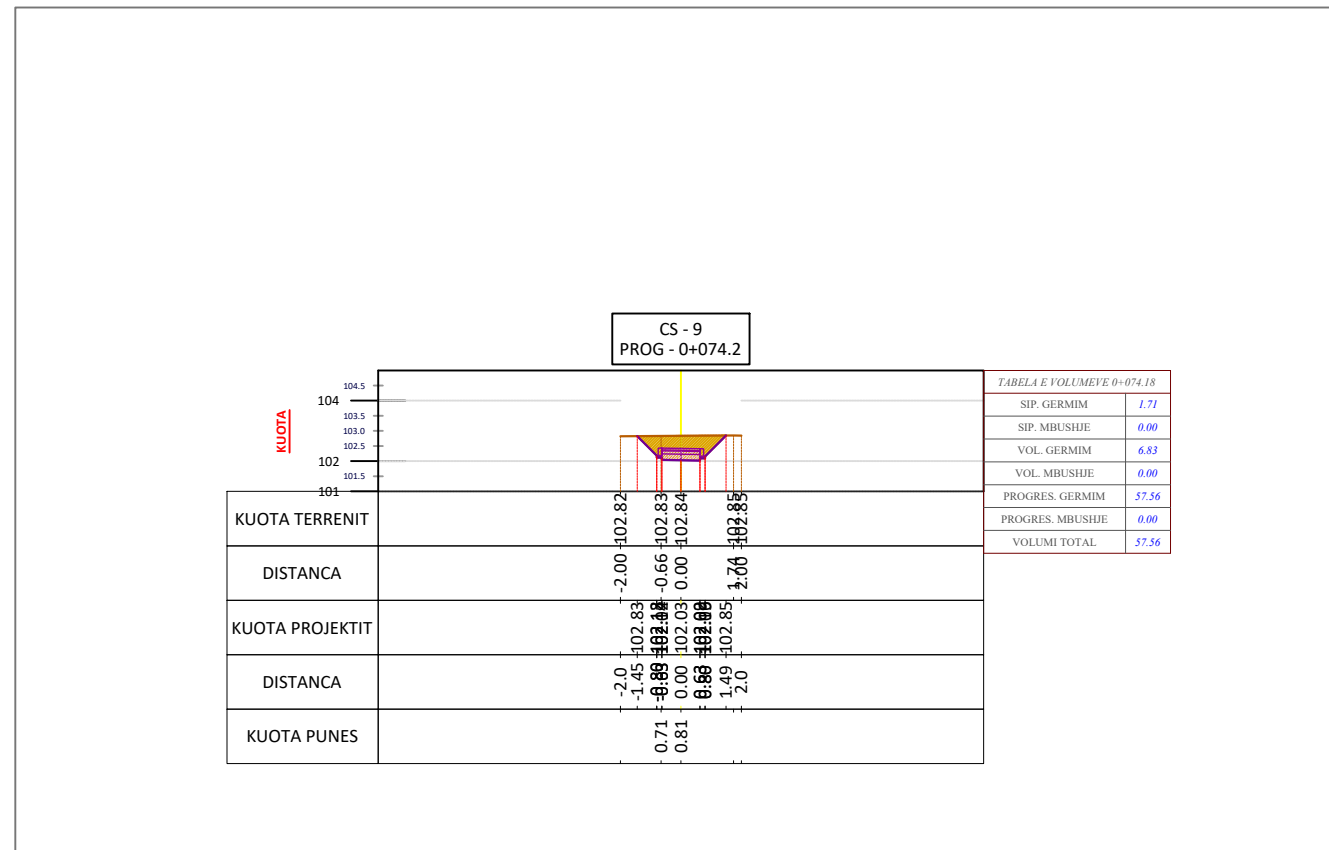

ZetaKonsult sh.p.k

Address:Rr."Myrteza Topi",Nd 18, Hyrja 7, Ap 38, TIRANE

Cel:+355 (0)69 33 52 077

e-mail:zetakonsultshpk@gmail.com



EMERTIMI I OBJEKTIT:

NDERTIM I SHESHIT REKREATIV SHTERMEN,BASHKIA CERRIK

FAZA E PROJEKTIT :PROJEKT ZBATIMI

EMERTESA E FLETES
TABELA VOLUMEVE
(pedonale dytesore-2)

SHKALLA Shk:1/250

FLETA 26

GRUPI I PROJEKTIMIT:

Inxh. Ndert.Lorenc HOXHA
Inxh.Ndert.Flutura Duro

Dt10/09/2024

FORMATI A3

Profil Gjatesor SH 1:500

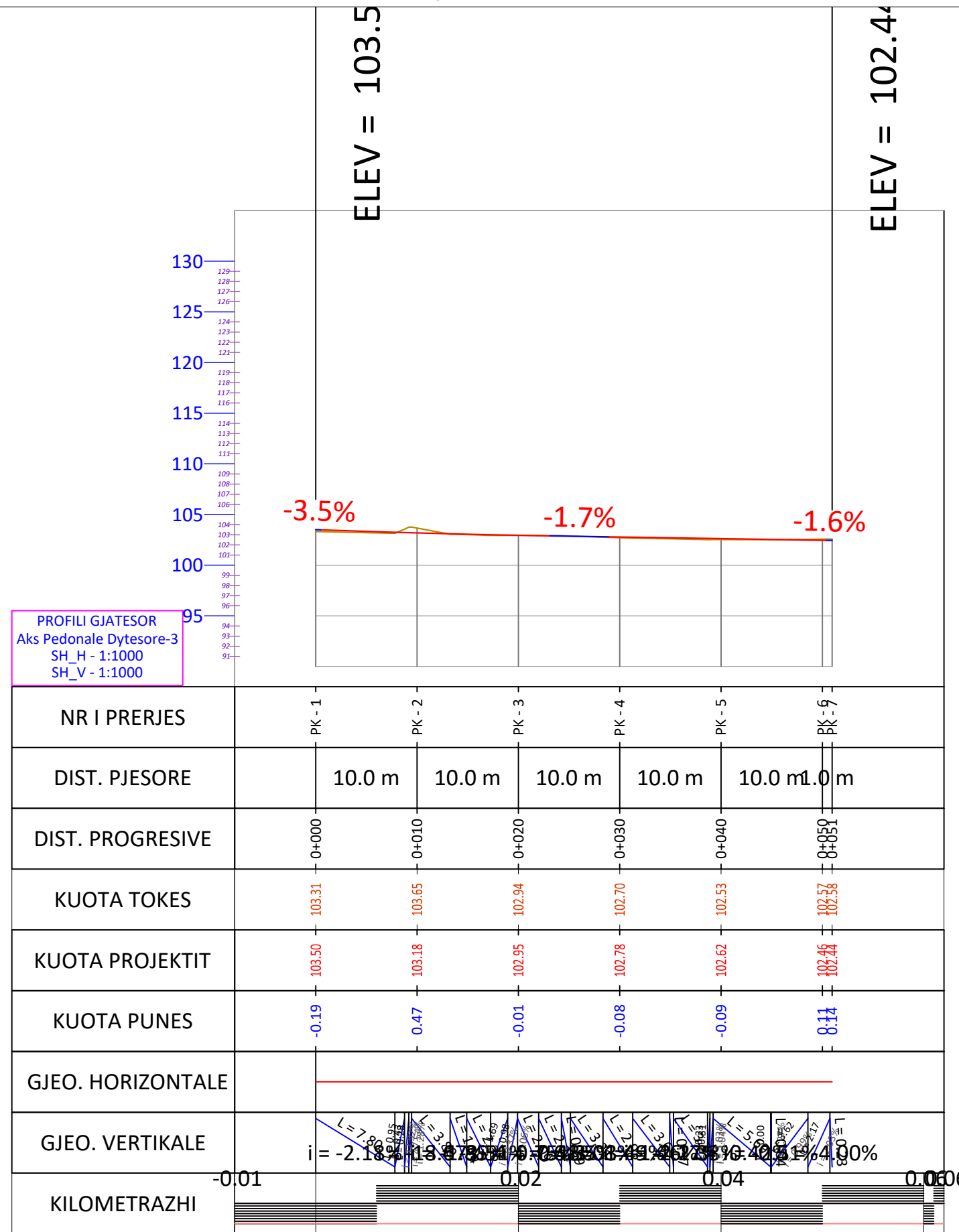

PROFILI GJATESOR
Aks Pedonale Dytesore-3
SH_H - 1:1000
SH_V - 1:1000

BASHKIA CERRIK



ZetaKonsult sh.p.k

Address:Rr."Myrteza Topi",Nd 18, Hyrja 7, Ap 38, TIRANE
Cel:+355 (0)69 33 52 077
e-mail:zetakonsultshpk@gmail.com



EMERTIMI I OBJEKTIT:
NDERTIM I SHESHIT REKREATIV SHTERMEN,BASHKIA CERRIK

FAZA E PROJEKTIT :PROJEKT ZBATIMI

EMERTESA E FLETES
PROFIL GJATESOR(pedonale dytesore-3)

SHKALLA Shk:1/500

FLETA 27

GRUPI I PROJEKTIMIT:

Inxh. Ndert.Lorenc HOXHA
Inxh.Ndert.Flutura Duro

Dt10/09/2024

FORMATI A3

Profillet Terthore SH 1:250

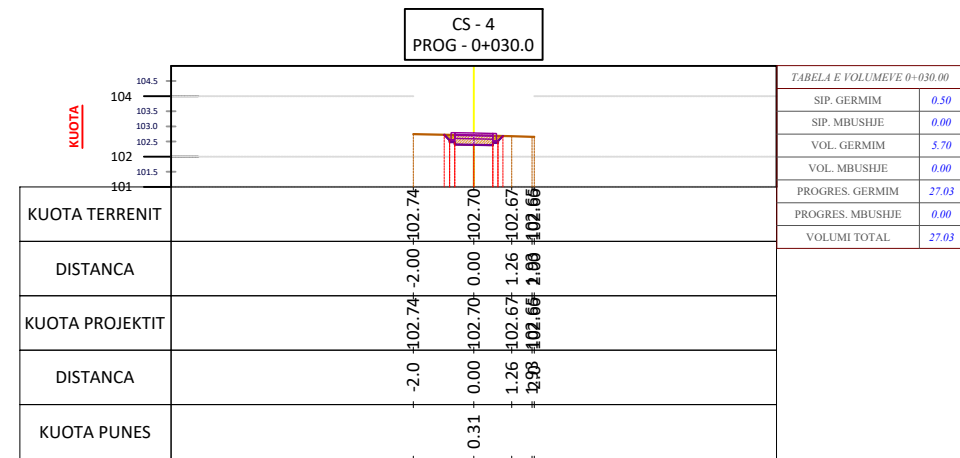
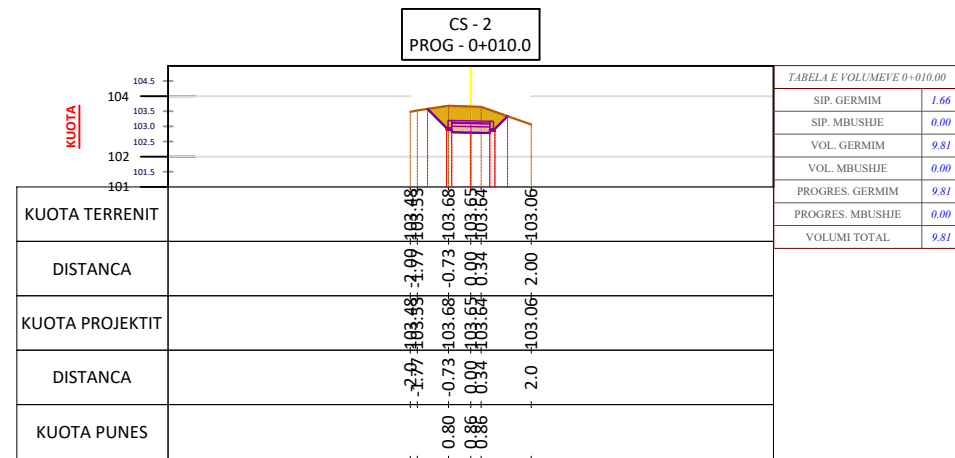
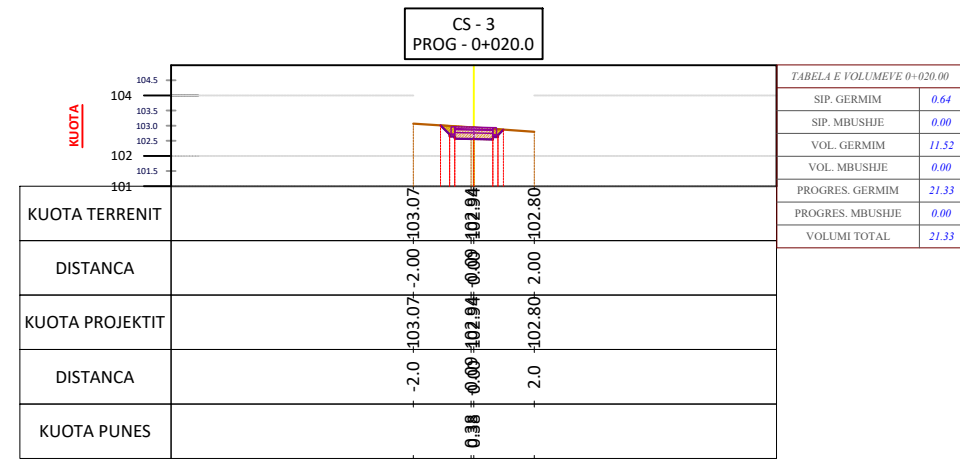
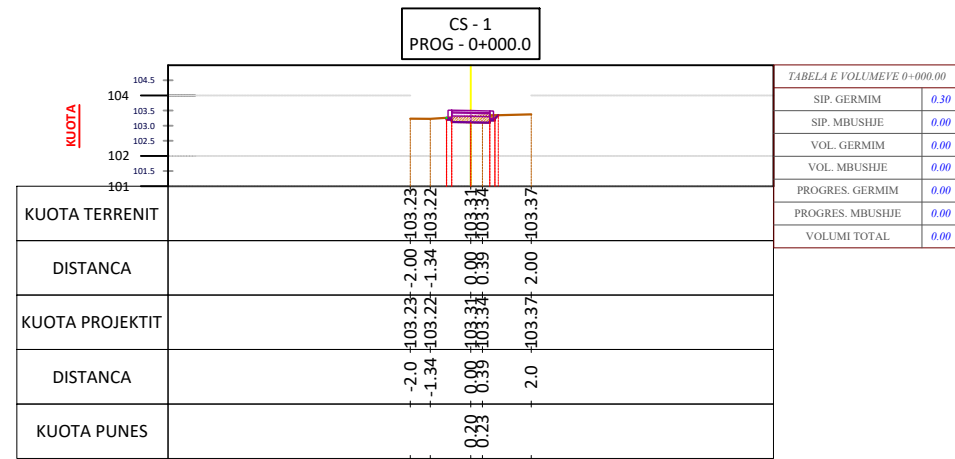

Profilet Terthore SH 1:250



Tabela Volumeve SH 1:250



VOLUMET						
Station	Fill Area	Cut Area	Fill Volume	Cut Volume	Cumulative Fill Vol	Cumulative Cut Vol
0+000.00	0.00	0.30	0.00	0.00	0.00	0.00
0+010.00	0.00	1.66	0.00	9.81	0.00	9.81
0+020.00	0.00	0.64	0.00	11.52	0.00	21.33
0+030.00	0.00	0.50	0.00	5.70	0.00	27.03
0+040.00	0.00	0.49	0.00	4.95	0.00	31.98
0+050.00	0.00	0.92	0.00	7.07	0.00	39.05
0+050.97	0.00	0.95	0.00	0.90	0.00	39.95

BASHKIA CERRIK

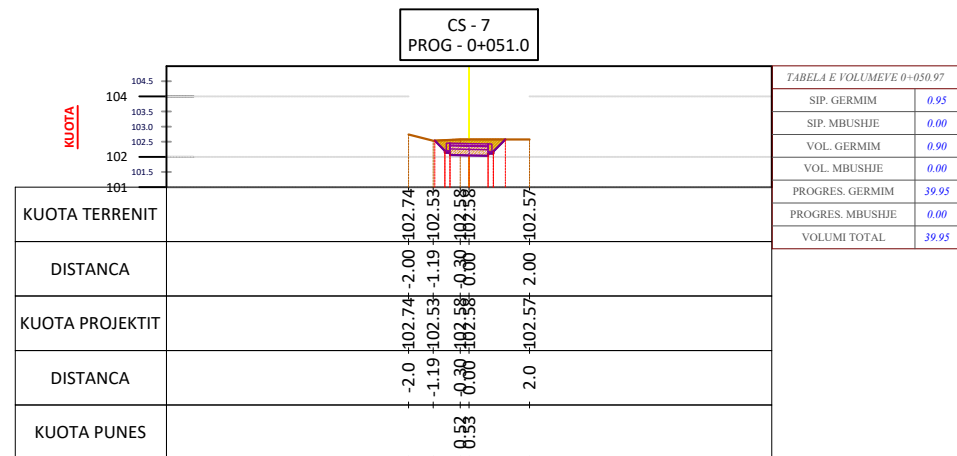
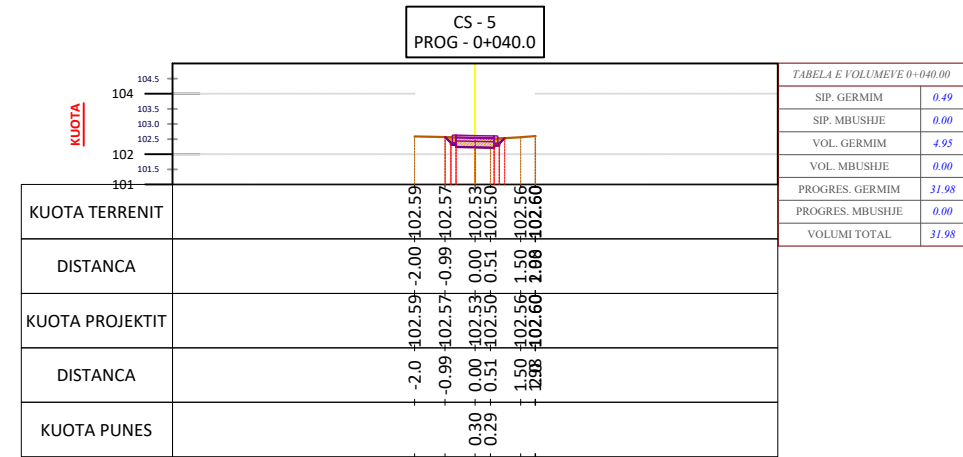
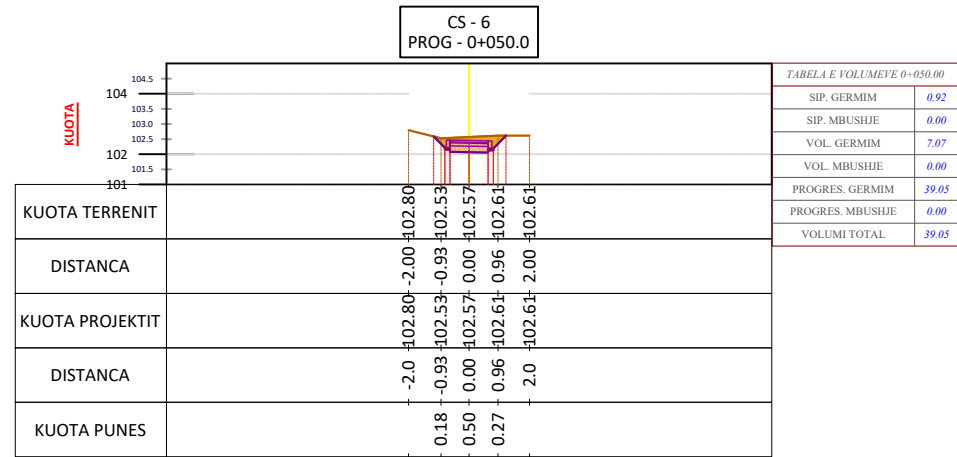

ZetaKonsult sh.p.k

Address:Rr."Myrteza Topi",Nd 18, Hyrja 7, Ap 38, TIRANE

Cel:+355 (0)69 33 52 077

e-mail:zetakonsultshpk@gmail.com



EMERTIMI I OBJEKTIT:

NDERTIM I SHESHIT REKREATIV SHTERMEN,BASHKIA CERRIK

FAZA E PROJEKTIT :PROJEKT ZBATIMI

EMERTESA E FLETES
TABELA VOLUMEVE
(pedonale dytesore-3)

SHKALLA Shk:1/250

FLETA 30

GRUPI I PROJEKTIMIT:

Inxh. Ndert.Lorenc HOXHA
Inxh.Ndert.Flutura Duro

Dt10/09/2024

FORMATI A3

Profil Gjatesor SH 1:500

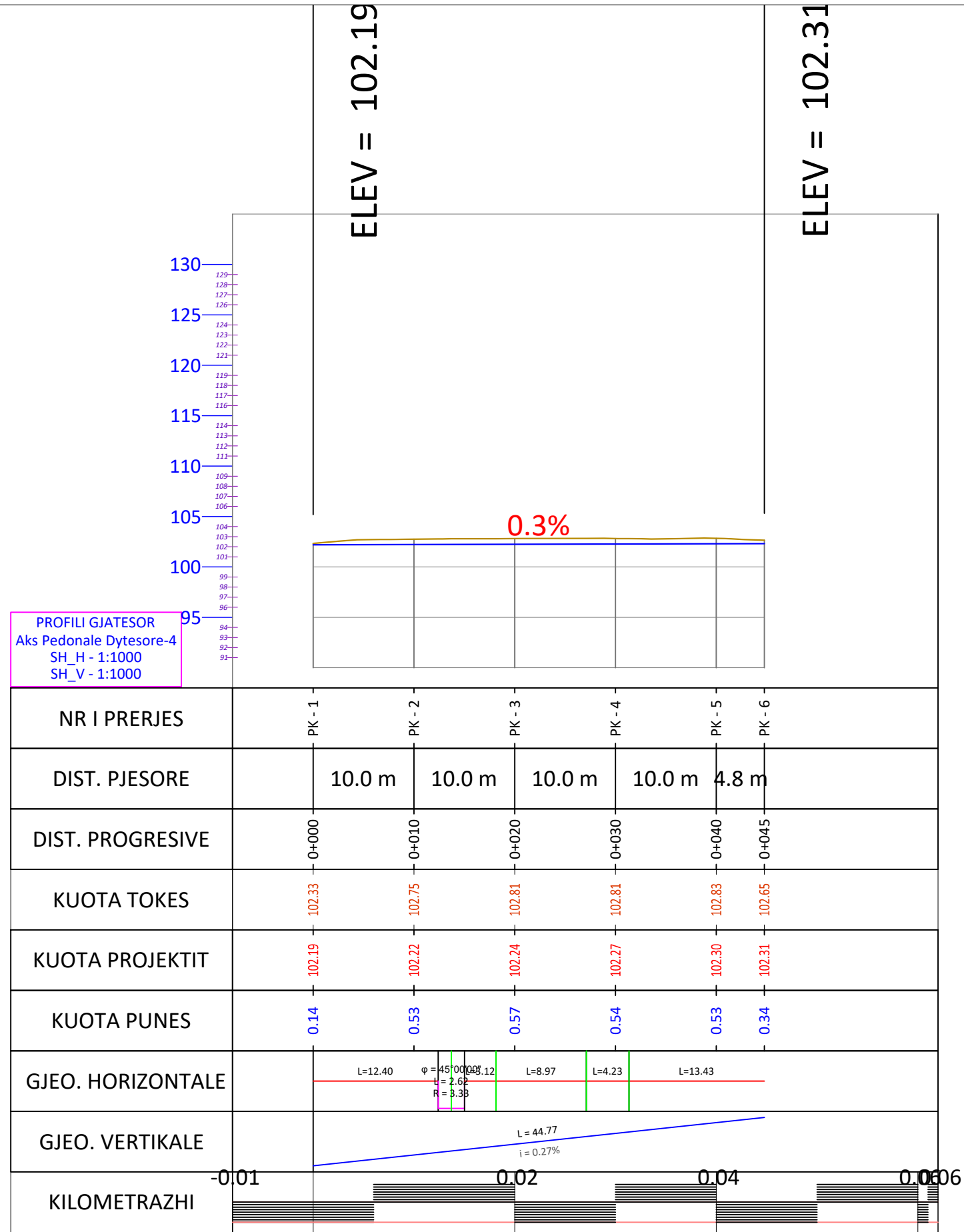

PROFILI GJATESOR
Aks Pedonale Dytesore-4
SH_H - 1:1000
SH_V - 1:1000



ZetaKonsult sh.p.k
 Address:Rr."Myrteza Topi",Nd 18, Hyrja 7, Ap 38, TIRANE
 Cel:+355 (0)69 33 52 077
 e-mail:zetakonsultshpk@gmail.com

EMERTIMI I OBJEKTIT:
 NDERTIM I SHESHIT REKREATIV SHTERMEN,BASHKIA CERRIK

FAZA E PROJEKTIT :PROJEKT ZBATIMI

EMERTESA E FLETES
 PROFIL GJATESOR(pedonale dytesore-4)

SHKALLA Shk:1/500 FLETA 31

GRUPI I PROJEKTIMIT:
 Inxh. Ndert.Lorenc HOXHA
 Inxh.Ndert.Flutura Duro

Dt10/09/2024

FORMATI A3

Profilet Terthore SH 1:250

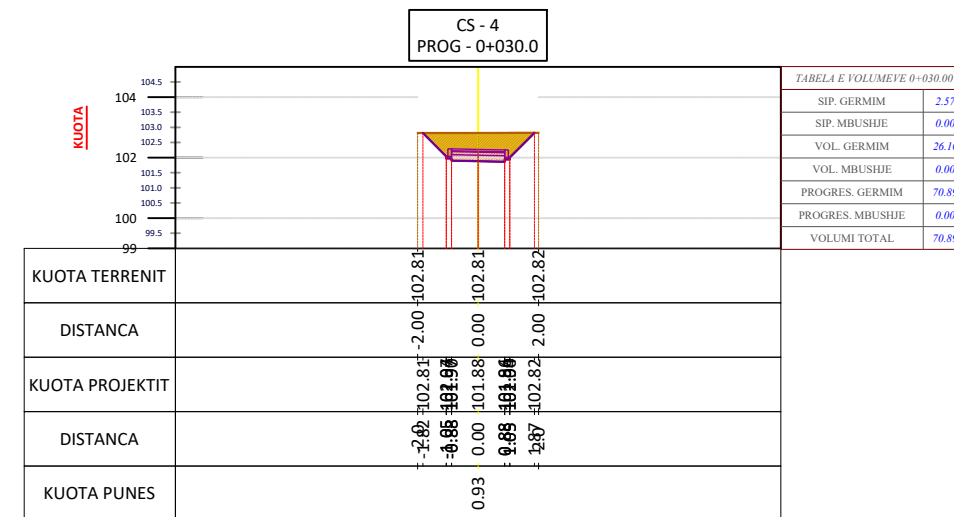
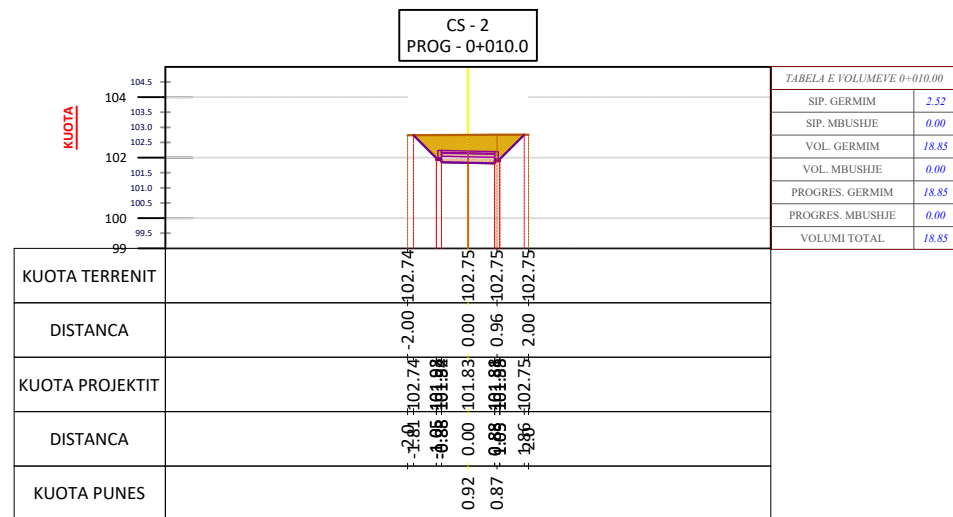
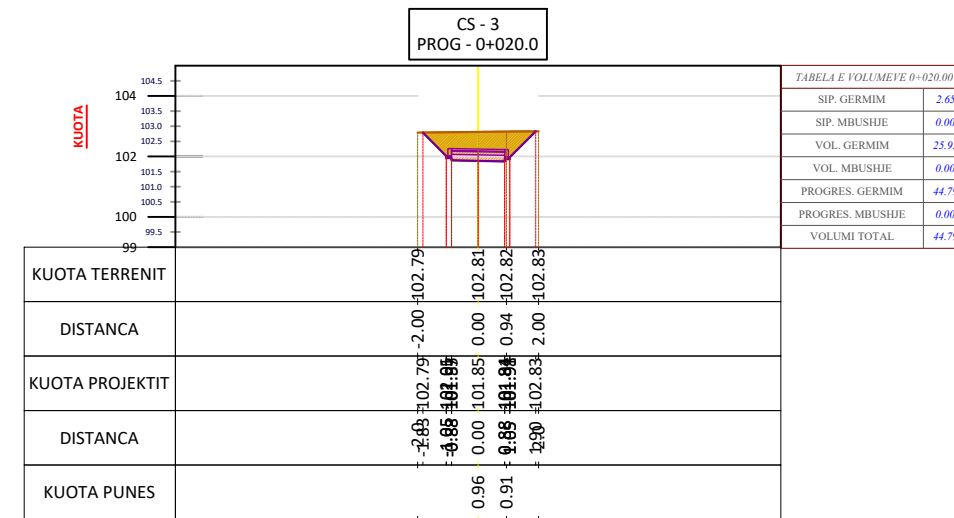
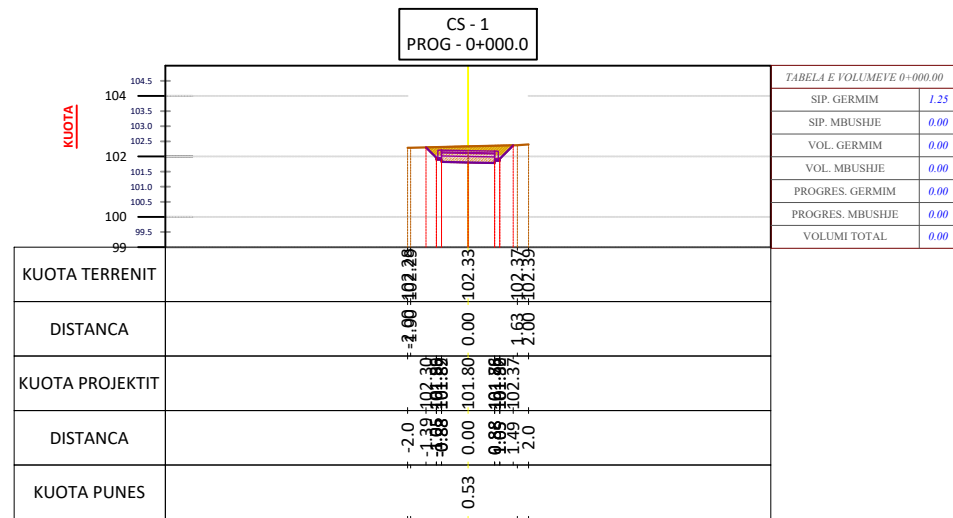

BASHKIA CERRIK



ZetaKonsult sh.p.k

Address:Rr."Myrteza Topi",Nd 18, Hyrja 7, Ap 38, TIRANE

Cel:+355 (0)69 33 52 077

e-mail:zetakonsultshpk@gmail.com



EMERTIMI I OBJEKTIT:
NDERTIM I SHESHIT REKREATIV SHTERMEN,BASHKIA CERRIK

FAZA E PROJEKTIT :PROJEKT ZBATIMI

EMERTESA E FLETES
PROFLET TERTHORE(pedonale dytesore-4)

SHKALLA Shk:1/250

FLETA 32

GRUPI I PROJEKTIMIT:

Inxh. Ndert.Lorenc HOXHA
Inxh.Ndert.Flutura Duro

Dt10/09/2024

FORMATI A3

Profillet Terthore SH 1:250



Tabela Volumeve SH 1:250



VOLUMET						
Station	Fill Area	Cut Area	Fill Volume	Cut Volume	Cumulative Fill Vol	Cumulative Cut Vol
0+000.00	0.00	1.25	0.00	0.00	0.00	0.00
0+010.00	0.00	2.52	0.00	18.85	0.00	18.85
0+020.00	0.00	2.65	0.00	25.95	0.00	44.79
0+030.00	0.00	2.57	0.00	26.10	0.00	70.89
0+040.00	0.00	2.46	0.00	25.15	0.00	96.05
0+044.77	0.00	1.93	0.00	10.47	0.00	106.52

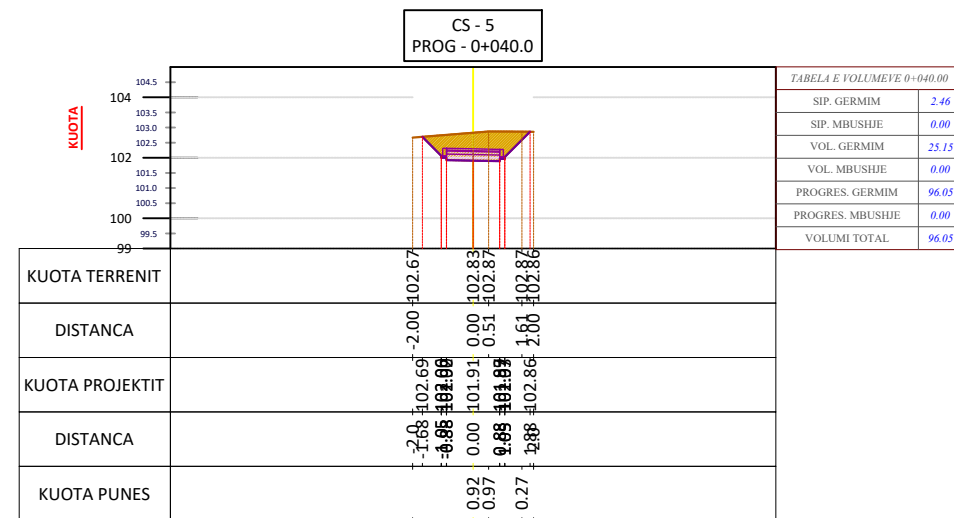
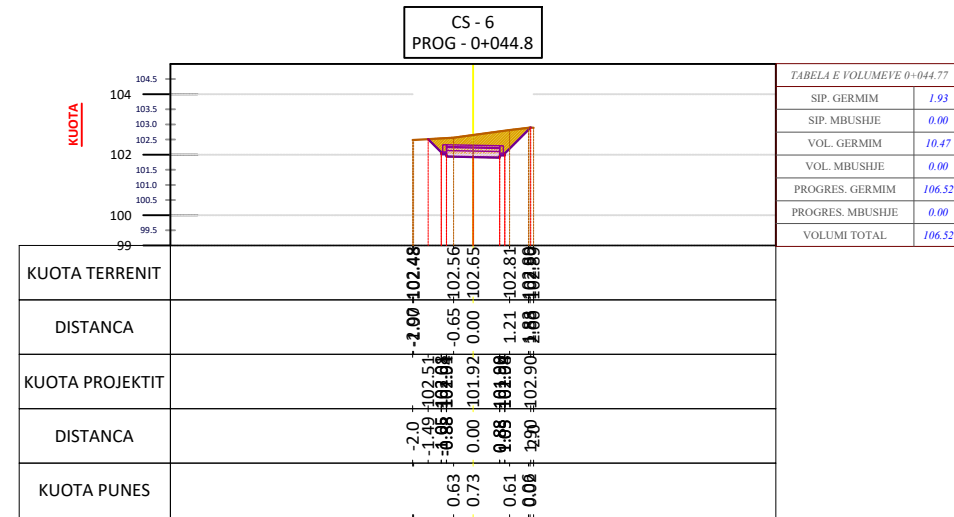

Profil Gjatesor SH 1:500

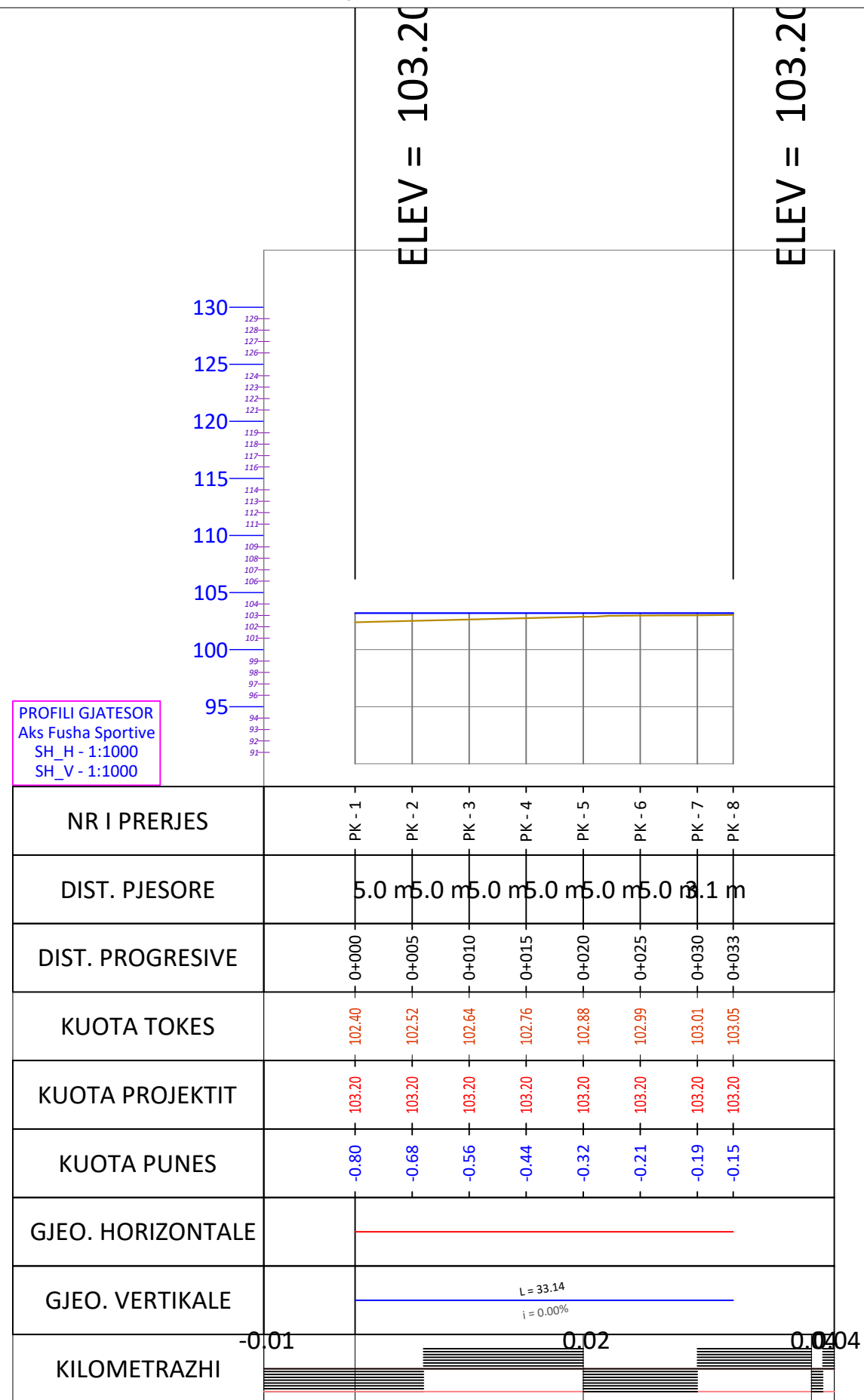

BASHKIA CERRIK



ZetaKonsult sh.p.k

Address: Rr. "Myrteza Topi", Nd 18, Hyrja 7, Ap 38, TIRANE

Cel: +355 (0)69 33 52 077

e-mail: zetakonsultshpk@gmail.com



EMERTIMI I OBJEKTIT:

NDERTIM I SHESHIT REKREATIV SHTERMEN, BASHKIA CERRIK

FAZA E PROJEKTIT : PROJEKT ZBATIMI

EMERTESA E FLETES

PROFIL GJATESOR (fusha sportive)

SHKALLA Shk: 1/500

FLETA 35

GRUPI I PROJEKTIMIT:

Inxh. Ndert. Lorenc HOXHA
Inxh. Ndert. Flutura Duro

Dt 10/09/2024

FORMATI A3

Profillet Terthore SH 1:250

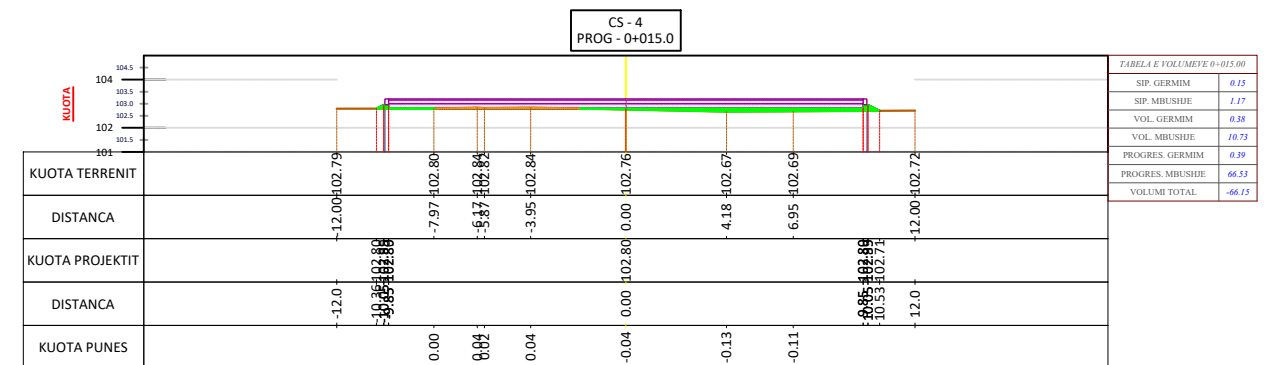
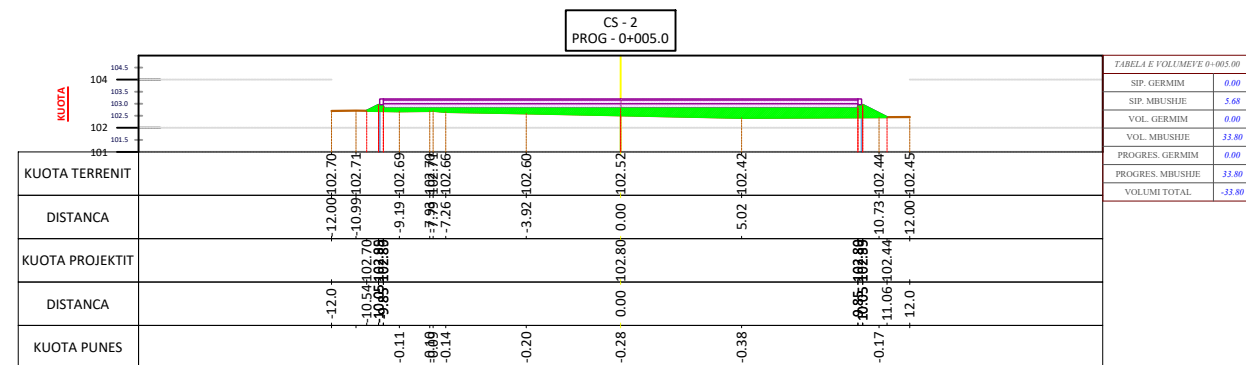
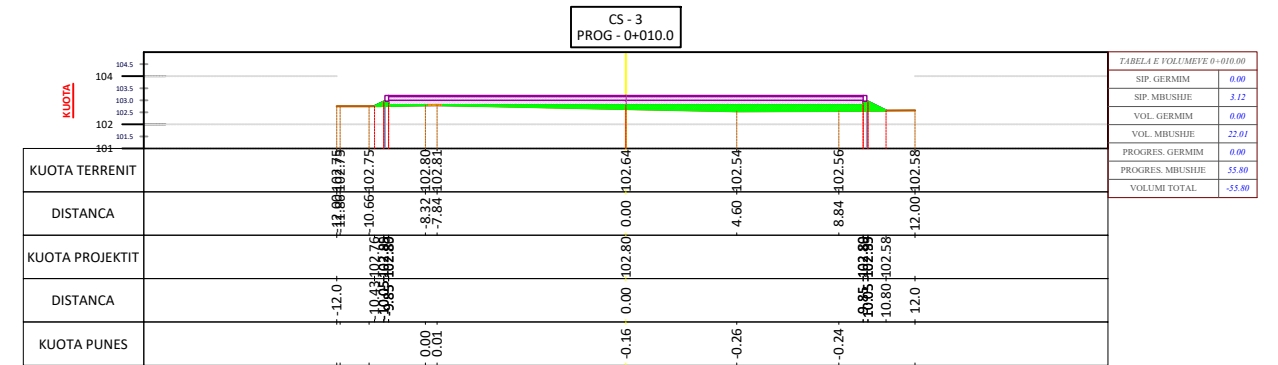
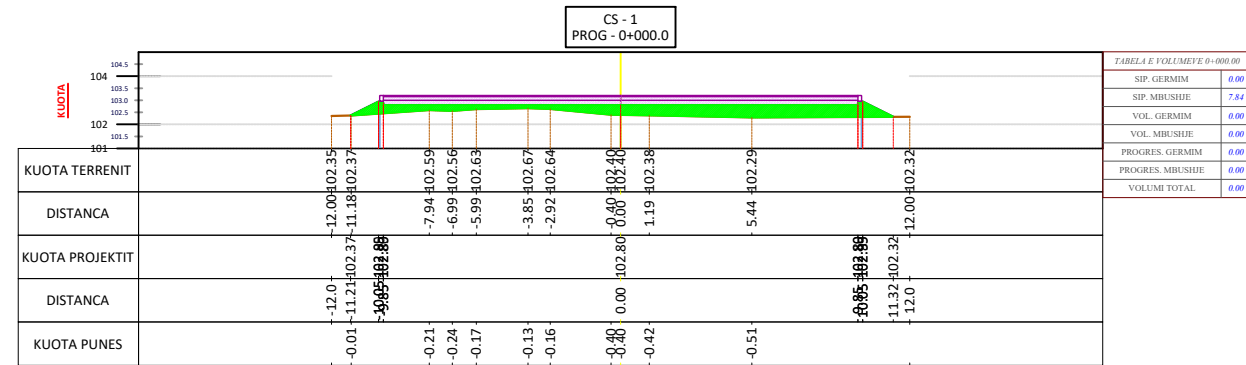

BASHKIA CERRIK



ZetaKonsult sh.p.k

Address: Rr. "Myrteza Topi", Nd 18, Hyrja 7, Ap 38, TIRANE

Cel: +355 (0)69 33 52 077

e-mail: zetakonsultshpk@gmail.com



EMERTIMI I OBJEKTIT:
NDERTIM I SHESHIT REKREATIV SHTERMEN, BASHKIA CERRIK

FAZA E PROJEKTIT : PROJEKT ZBATIMI

EMERTESA E FLETES
PROFILET TERTHORE (fusha sportive)

SHKALLA Shk: 1/250

FLETA 36

GRUPI I PROJEKTIMIT:

Inxh. Ndert. Lorenc HOXHA
Inxh. Ndert. Flutura Duro

Dt 10/09/2024

FORMATI A3

Profillet Terthore SH 1:250

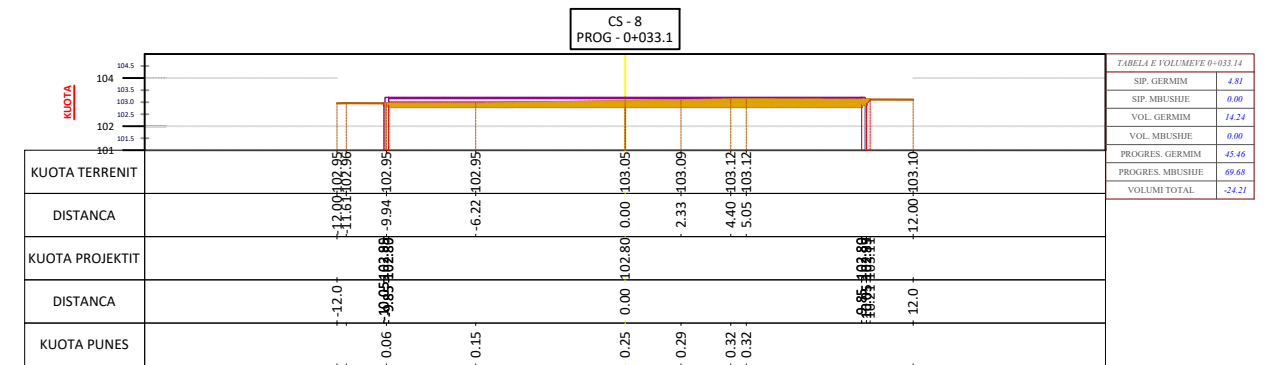
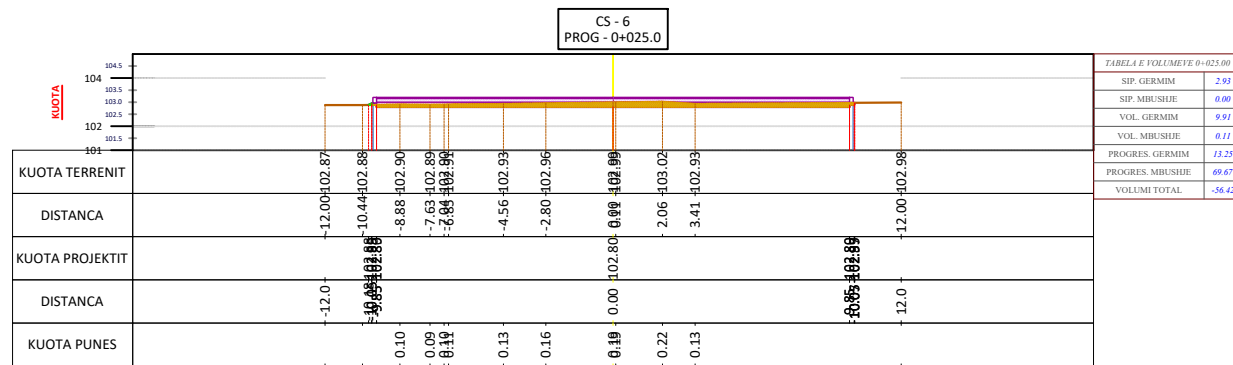
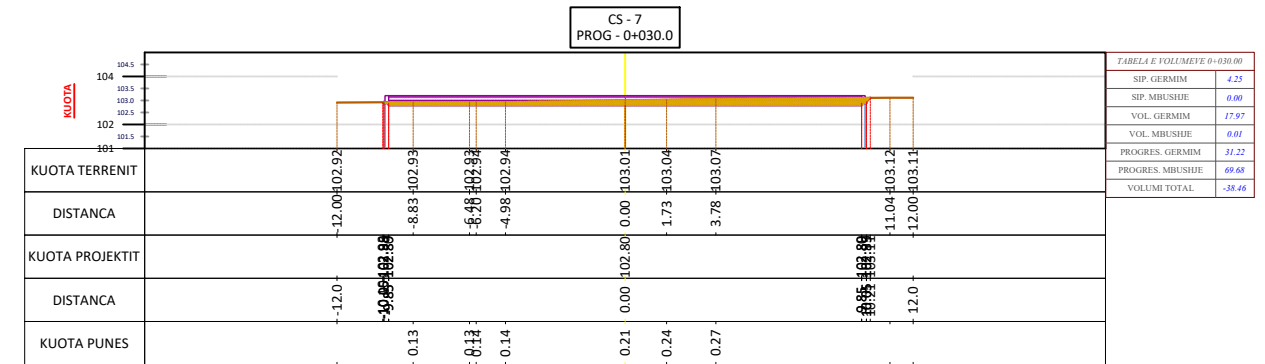
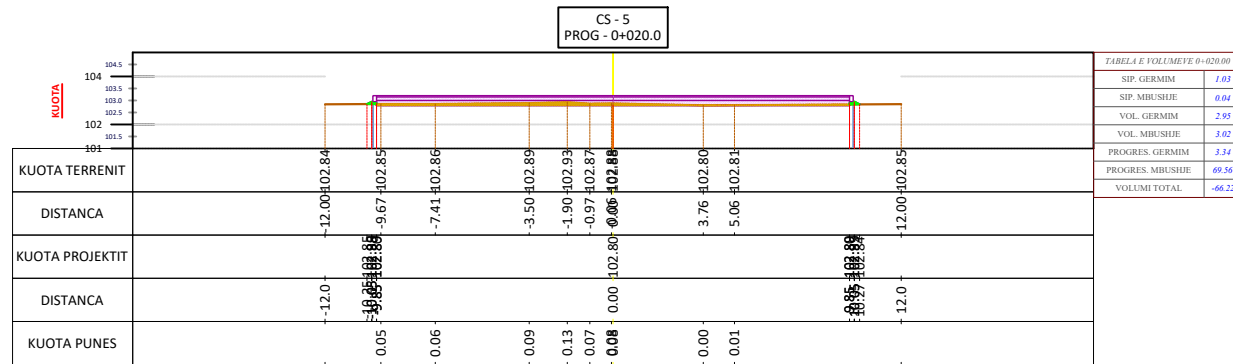

BASHKIA CERRIK



ZetaKonsult sh.p.k

Address: Rr. "Myrteza Topi", Nd 18, Hyrja 7, Ap 38, TIRANE

Cel: +355 (0)69 33 52 077

e-mail: zetakonsultshpk@gmail.com



EMERTIMI I OBJEKTIT:
NDERTIM I SHESHIT REKREATIV SHTERMEN, BASHKIA CERRIK

FAZA E PROJEKTTIT : PROJEKT ZBATIMI

EMERTESA E FLETES
PROFILLET TERTHORE (fusha sportive)

SHKALLA Shk: 1/250

FLETA 37

GRUPI I PROJEKTTIMIT:

Inxh. Ndert. Lorenc HOXHA
Inxh. Ndert. Flutura Duro

Dt 10/09/2024

FORMATI A3

Tabela Volumeve SH 1:250



VOLUMET						
Station	Fill Area	Cut Area	Fill Volume	Cut Volume	Cumulative Fill Vol	Cumulative Cut Vol
0+000.00	7.84	0.00	0.00	0.00	0.00	0.00
0+005.00	5.68	0.00	33.80	0.00	33.80	0.00
0+010.00	3.12	0.00	22.01	0.00	55.80	0.00
0+015.00	1.17	0.15	10.73	0.38	66.53	0.39
0+020.00	0.04	1.03	3.02	2.95	69.56	3.34
0+025.00	0.00	2.93	0.11	9.91	69.67	13.25
0+030.00	0.00	4.25	0.01	17.97	69.68	31.22
0+033.14	0.00	4.81	0.00	14.24	69.68	45.46



Profil Gjatesor SH 1:500

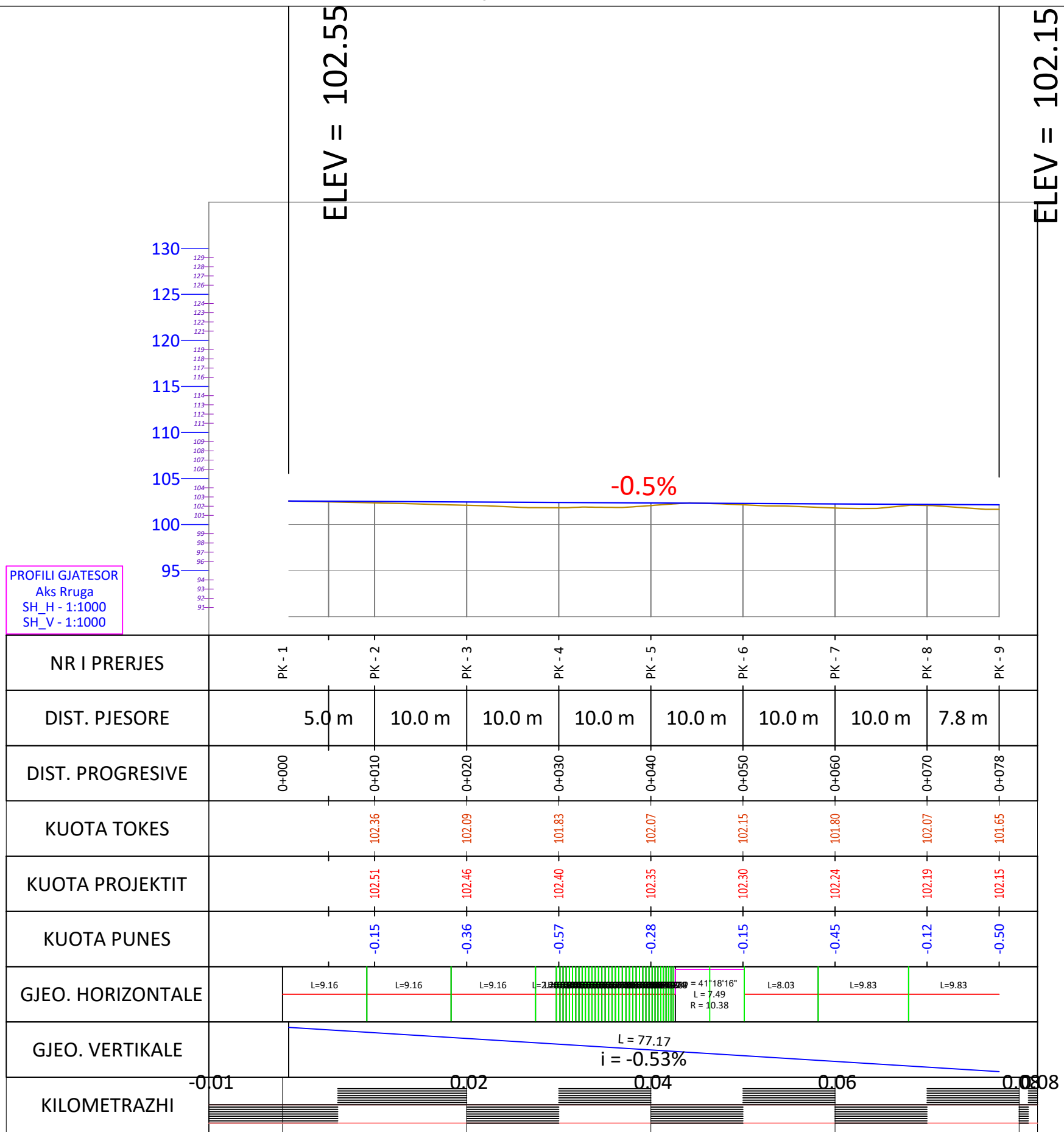

PROFILI GJATESOR
 Aks Rruga
 SH_H - 1:1000
 SH_V - 1:1000



Profilet Terthore SH 1:250

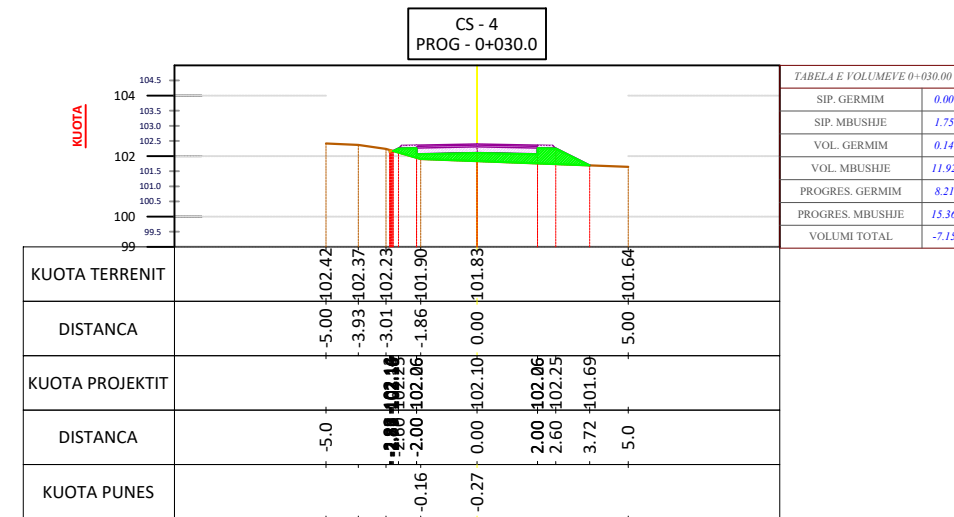
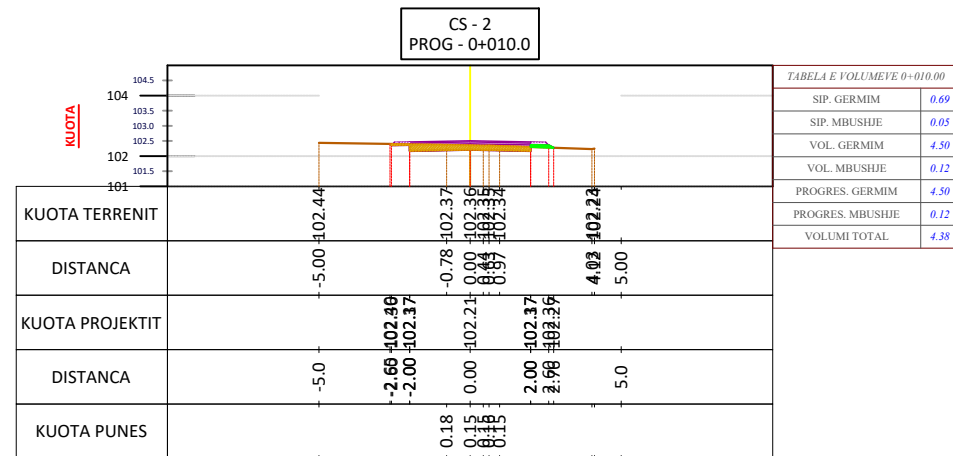
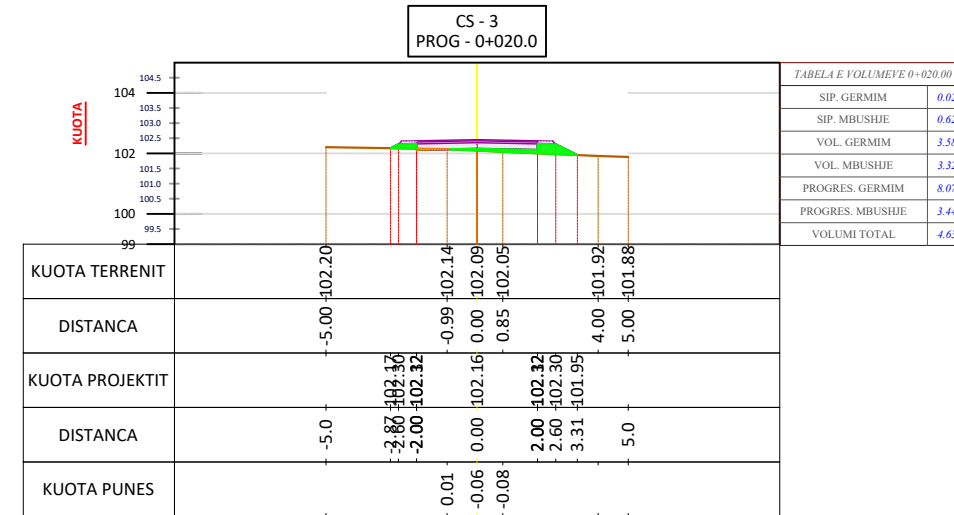
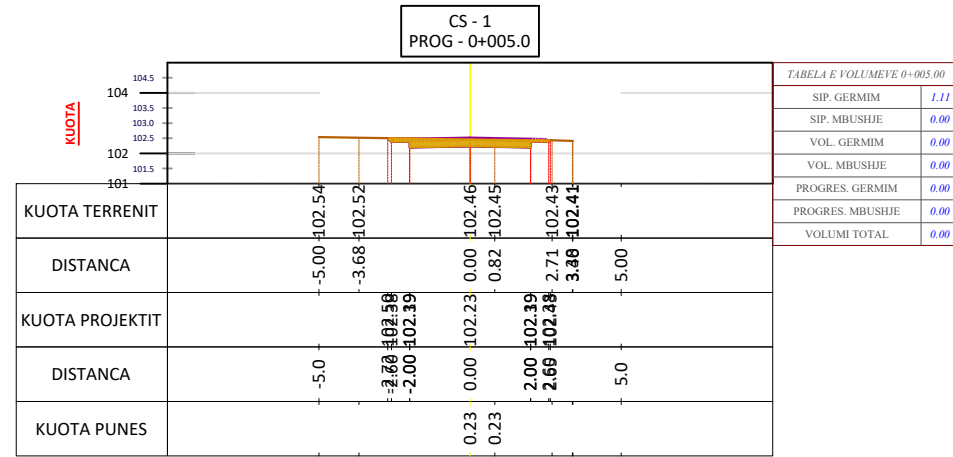

BASHKIA CERRIK



ZetaKonsult sh.p.k

Address: Rr. "Myrteza Topi", Nd 18, Hyrja 7, Ap 38, TIRANE

Cel: +355 (0)69 33 52 077

e-mail: zetakonsultshpk@gmail.com



EMERTIMI I OBJEKTIT:
NDERTIM I SHESHIT REKREATIV SHTERMEN, BASHKIA CERRIK

FAZA E PROJEKTIT : PROJEKT ZBATIMI

EMERTESA E FLETES
PROFLET TERTHORE (rruge me asfalt)

SHKALLA Shk: 1/250

FLETA 40

GRUPI I PROJEKTIMIT:

Inxh. Ndert. Lorenc HOXHA
Inxh. Ndert. Flutura Duro

Dt 10/09/2024

FORMATI A3

Profilet Terthore SH 1:250

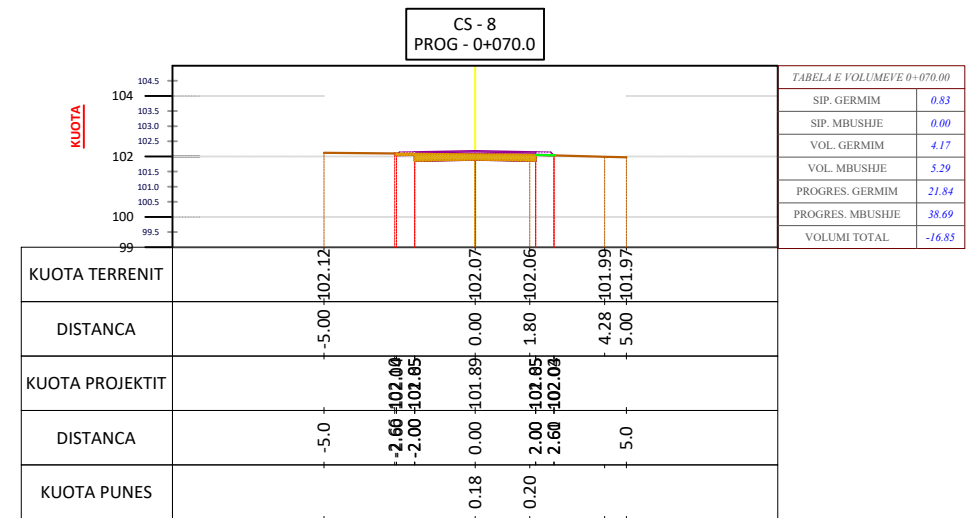
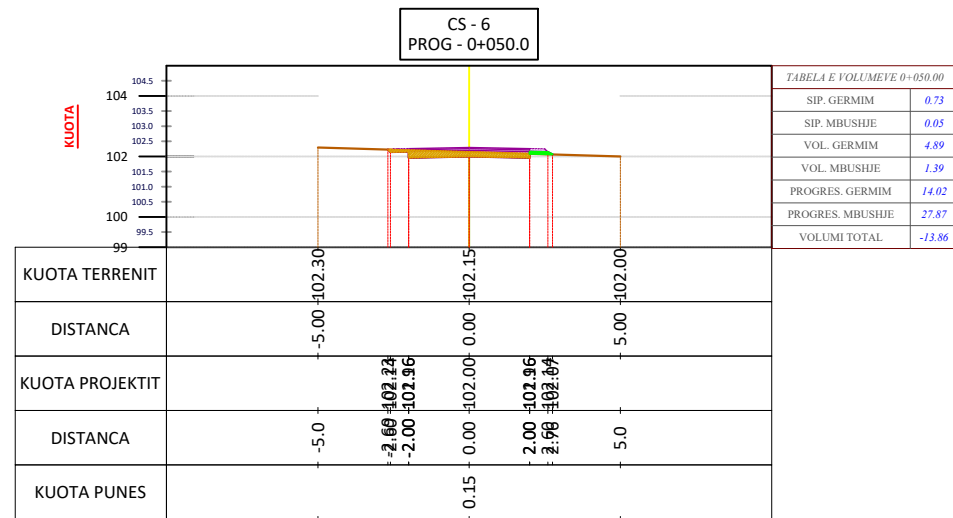
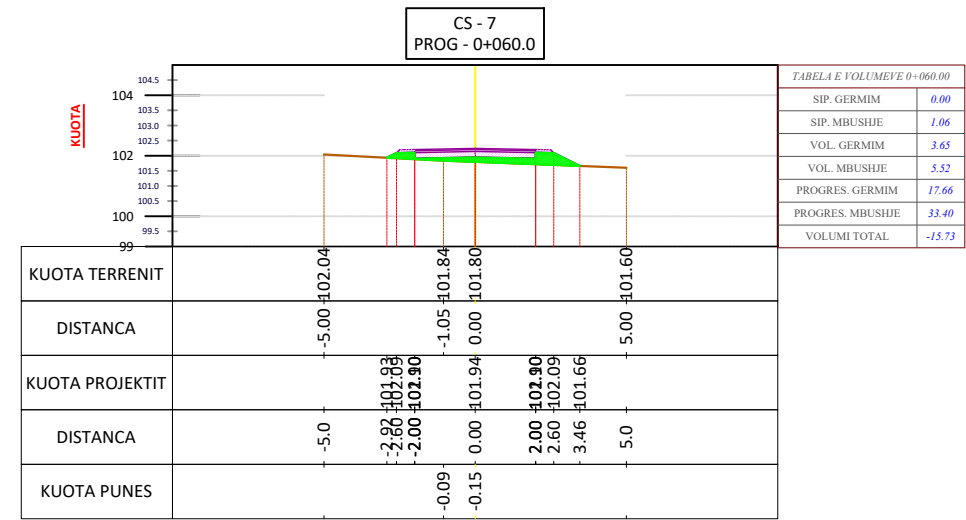
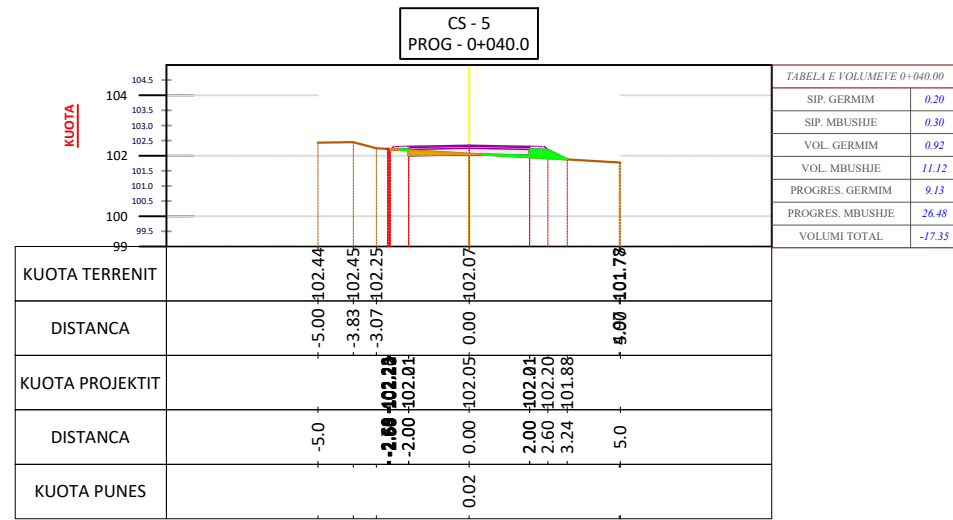

Profillet Terthore SH 1:250



TABELA E VOLUMEVE 0+077.83

SIP. GERMIM	0.00
SIP. MBUSHJE	1.41
VOL. GERMIM	3.27
VOL. MBUSHJE	5.54
PROGRES. GERMIM	25.10
PROGRES. MBUSHJE	44.23
VOLUMI TOTAL	-19.12

BASHKIA CERRIK

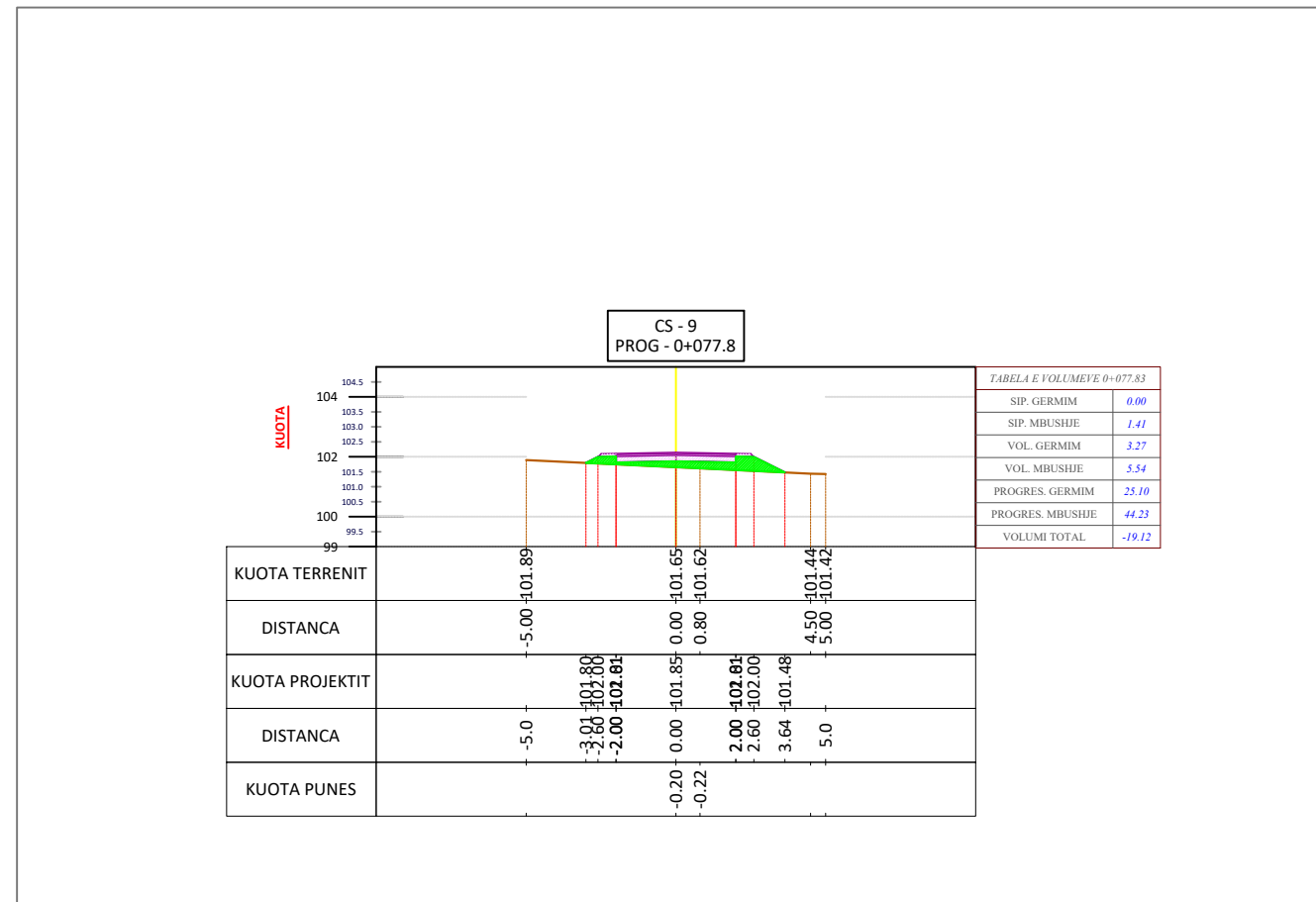

ZetaKonsult sh.p.k

Address: Rr. "Myrteza Topi", Nd 18, Hyrja 7, Ap 38, TIRANE

Cel: +355 (0)69 33 52 077

e-mail: zetakonsultshpk@gmail.com



EMERTIMI I OBJEKTIT:

NDERTIM I SHESHIT REKREATIV SHTERMEN, BASHKIA CERRIK

FAZA E PROJEKTIT : PROJEKT ZBATIMI

EMERTESA E FLETES
PROFLET TERTHORE (rruge me asfalt)

SHKALLA Shk: 1/250

FLETA 42

GRUPI I PROJEKTIMIT:

Inxh. Ndert. Lorenc HOXHA
Inxh. Ndert. Flutura Duro

Dt 10/09/2024

FORMATI A3

Tabela Volumeve SH 1:250



VOLUMET						
Station	Fill Area	Cut Area	Fill Volume	Cut Volume	Cumulative Fill Vol	Cumulative Cut Vol
0+005.00	0.00	1.11	0.00	0.00	0.00	0.00
0+010.00	0.05	0.69	0.12	4.50	0.12	4.50
0+020.00	0.62	0.02	3.32	3.58	3.44	8.07
0+030.00	1.75	0.00	11.92	0.14	15.36	8.21
0+040.00	0.30	0.20	11.12	0.92	26.48	9.13
0+050.00	0.05	0.73	1.39	4.89	27.87	14.02
0+060.00	1.06	0.00	5.52	3.65	33.40	17.66
0+070.00	0.00	0.83	5.29	4.17	38.69	21.84
0+077.83	1.41	0.00	5.54	3.27	44.23	25.10



Planimetria e dhomave te zhveshjes SH 1:50

PLANIMETRIA

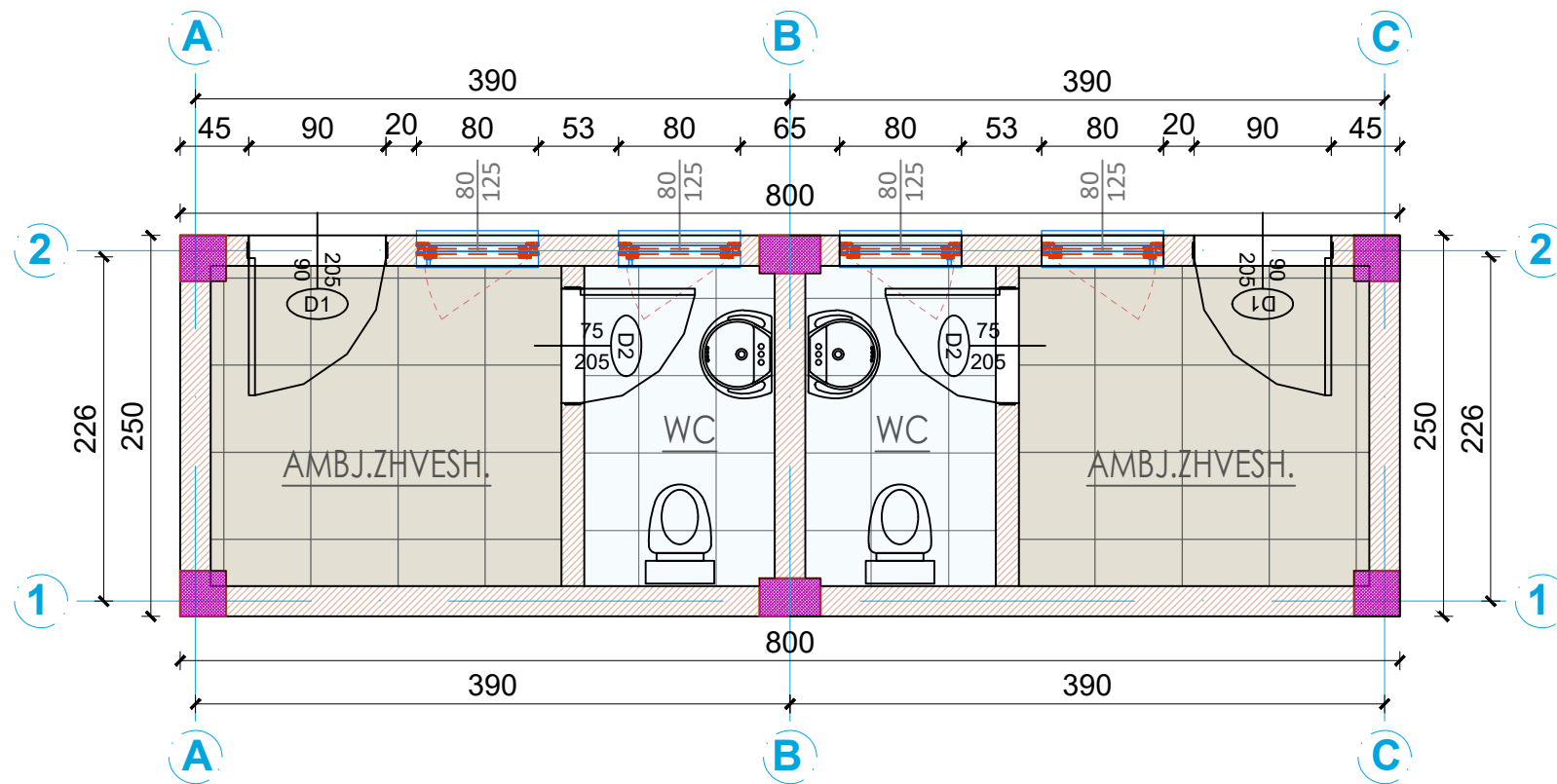

PLANIMETRIA TEKNIKE

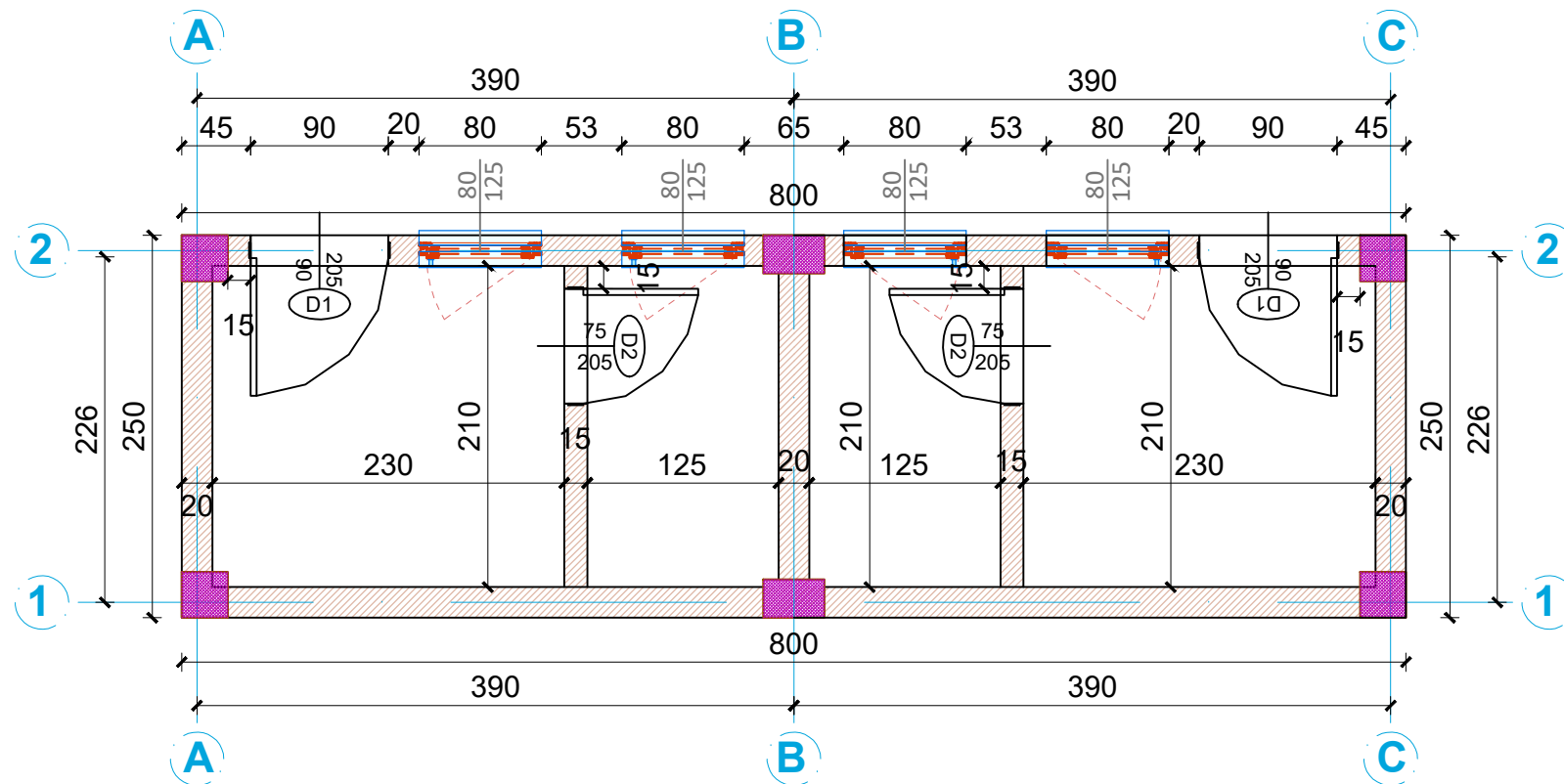

BASHKIA CERRIK



ZetaKonsult sh.p.k

Address:Rr."Myrteza Topi",Nd 18, Hyrja 7, Ap 38, TIRANE
 Cel: +355 (0)69 33 52 077
 e-mail:zetakonsultshpk@gmail.com



EMERTIMI I OBJEKTIT:
 NDERTIM I SHESHIT REKREATIV SHTERMEN, BASHKIA
 CERRIK

FAZA E PROJEKTIT :PROJEKT ZBATIMI

EMERTESA E FLETES
 Planimetria e dhomave te zhveshjes

SHKALLA Shk:1/50

FLETA 44

GRUPI I PROJEKTIMIT:

Inxh. Ndert.Lorenc HOXHA
 Inxh.Ndert.Flutura Duro

Dt10/09/2024

FORMATI A3

Fasada ballore e dhomave te zhveshjes SH 1:50

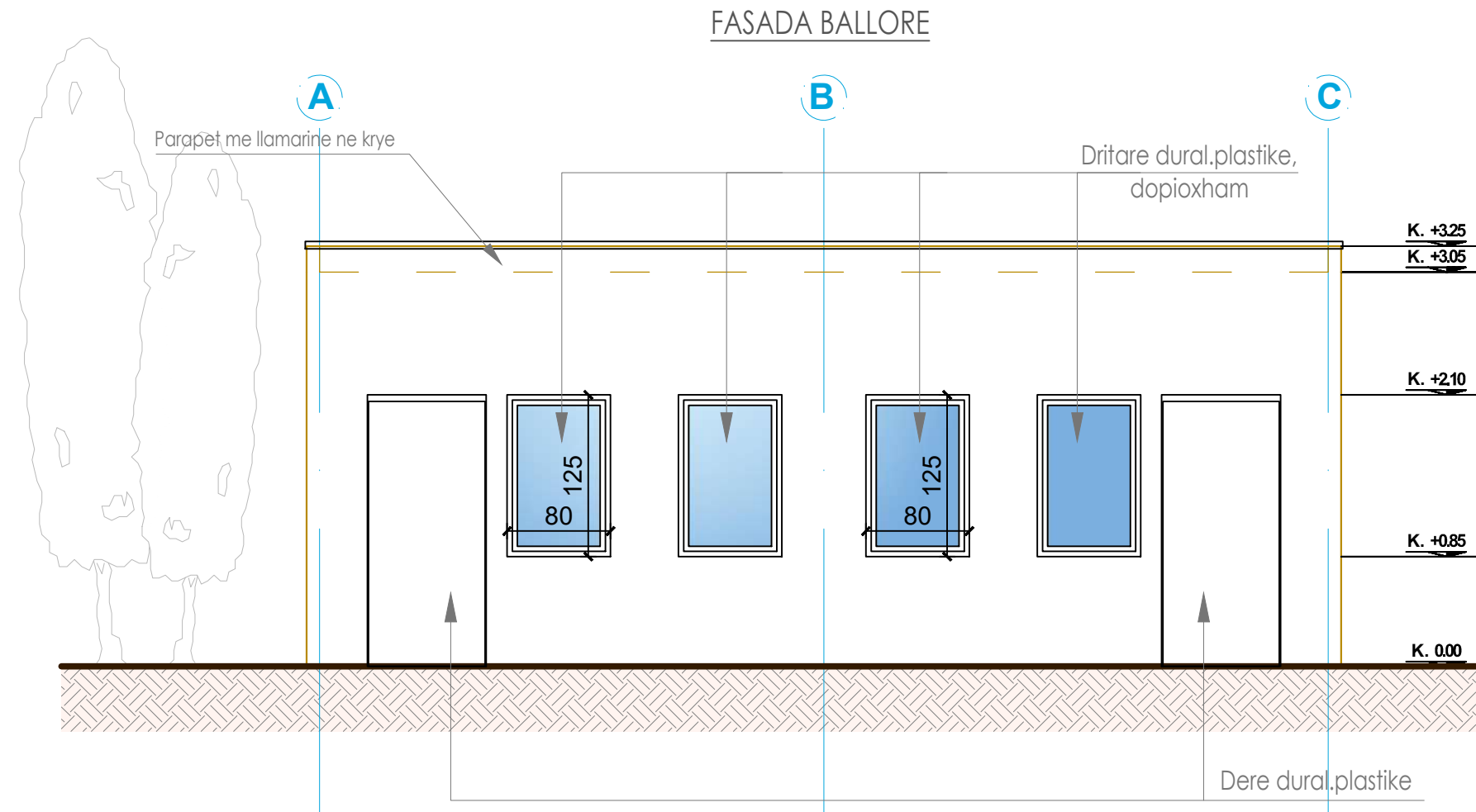

BASHKIA CERRIK



ZetaKonsult sh.p.k

Address:Rr."Myrteza Topi",Nd 18, Hyrja 7, Ap 38, TIRANE

Cel: +355 (0)69 33 52 077

e-mail:zetakonsultshpk@gmail.com



EMERTIMI I OBJEKTIT:
NDERTIM I SHESHIT REKREATIV SHTERMEN, BASHKIA
CERRIK

FAZA E PROJEKTIT :PROJEKT ZBATIMI

EMERTESA E FLETES
Fasada ballore e dhomave te zhveshjes

SHKALLA Shk:1/50

FLETA 45

GRUPI I PROJEKTIMIT:

Inxh. Ndert.Lorenc HOXHA
Inxh.Ndert.Flutura Duro

Dt10/09/2024

FORMATI A3

Plani i shkarkimeve dhe furnizimit me uje per dhomat e zhveshjes SH 1:75

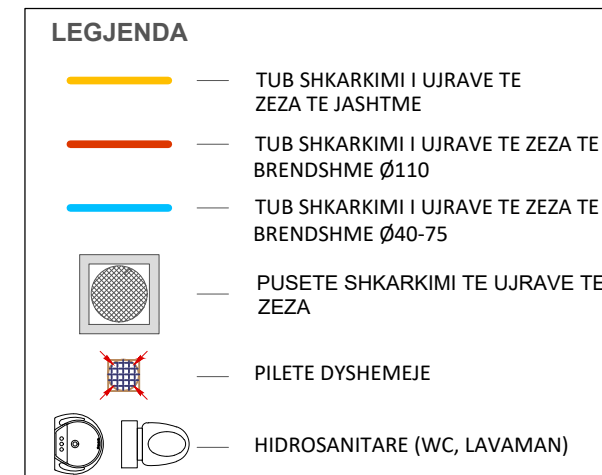
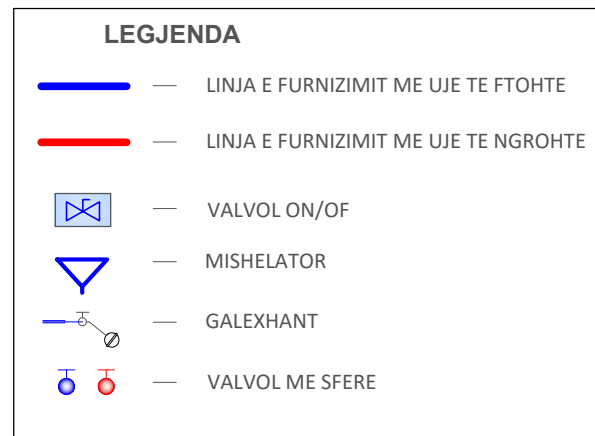
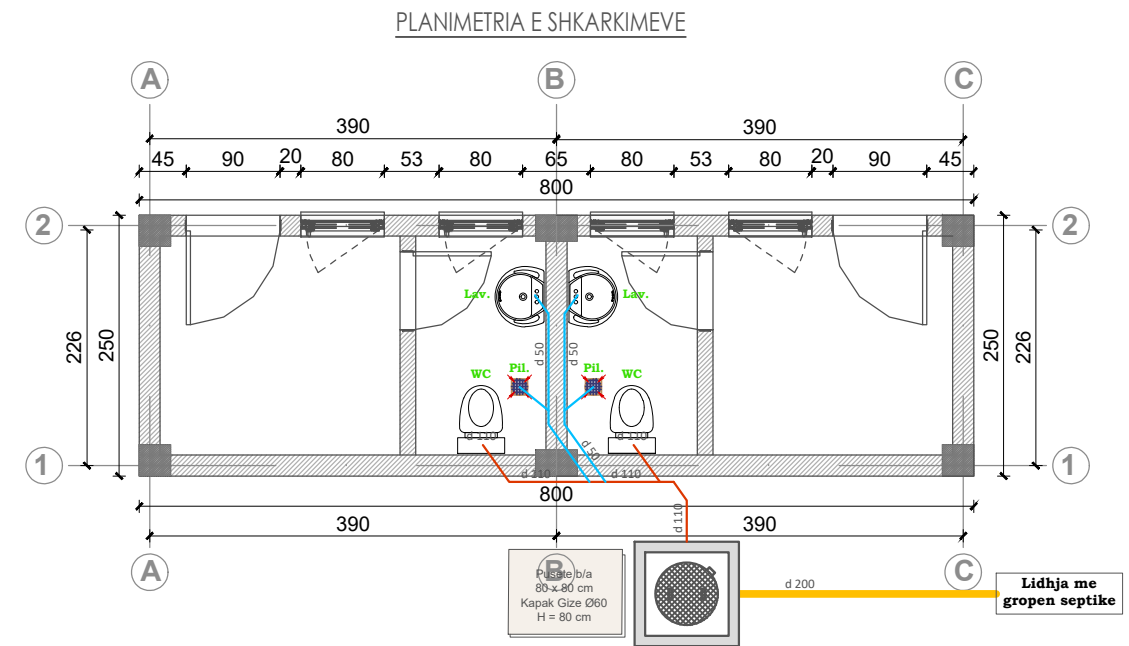
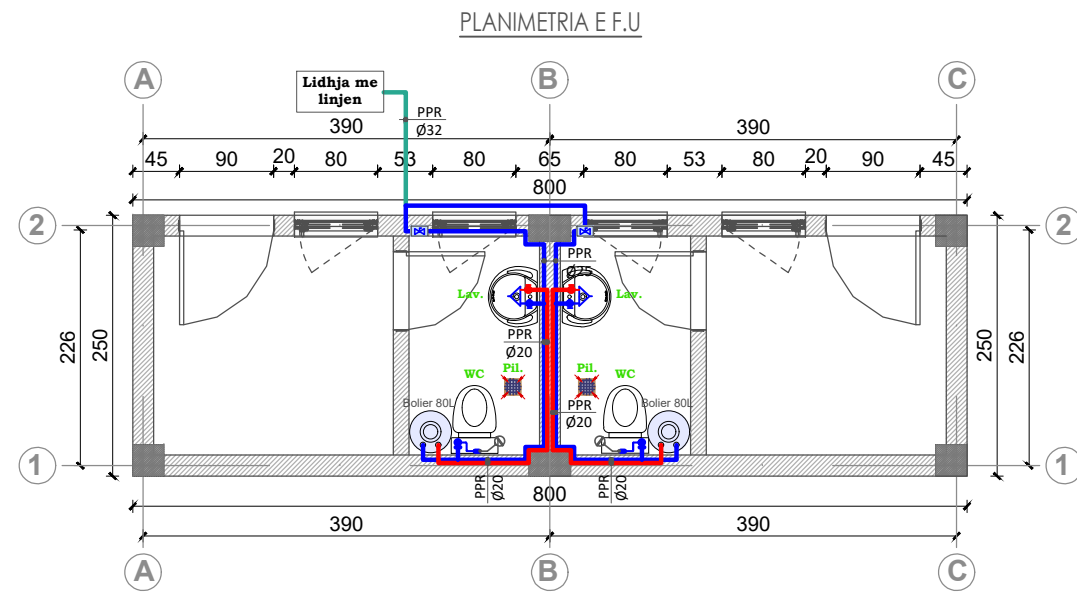

BASHKIA CERRIK



ZetaKonsult sh.p.k

Address: Rr. "Myrteza Topi", Nd 18, Hyrja 7, Ap 38, TIRANE

Cel: +355 (0)69 33 52 077

e-mail: zetakonsultshpk@gmail.com



EMERTIMI I OBJEKTIT:
NDERTIM I SHESHIT REKREATIV SHTERMEN, BASHKIA CERRIK

FAZA E PROJEKTIT : PROJEKT ZBATIMI

EMERTESA E FLETES
Plani i shkarkimeve dhe furnizimit me uje per dhomat e zhveshjes

SHKALLA Shk: 1/75

FLETA 46

GRUPI I PROJEKTIMIT:

Inxh. Ndert. Lorenc HOXHA
Inxh. Ndert. Flutura Duro

Dt 10/09/2024

FORMATI A3

Planimetria e ndricimit dhe prizave per dhomat e zhveshjes SH 1:75



PLANIMETRIA E NDRICIMIT

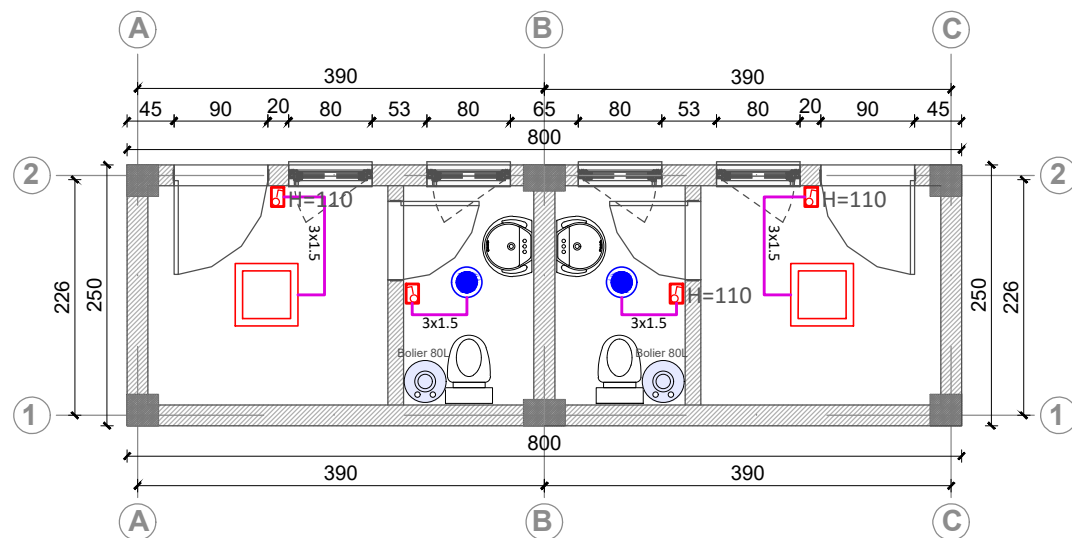

PLANIMETRIA E PRIZAVE/FUQISE

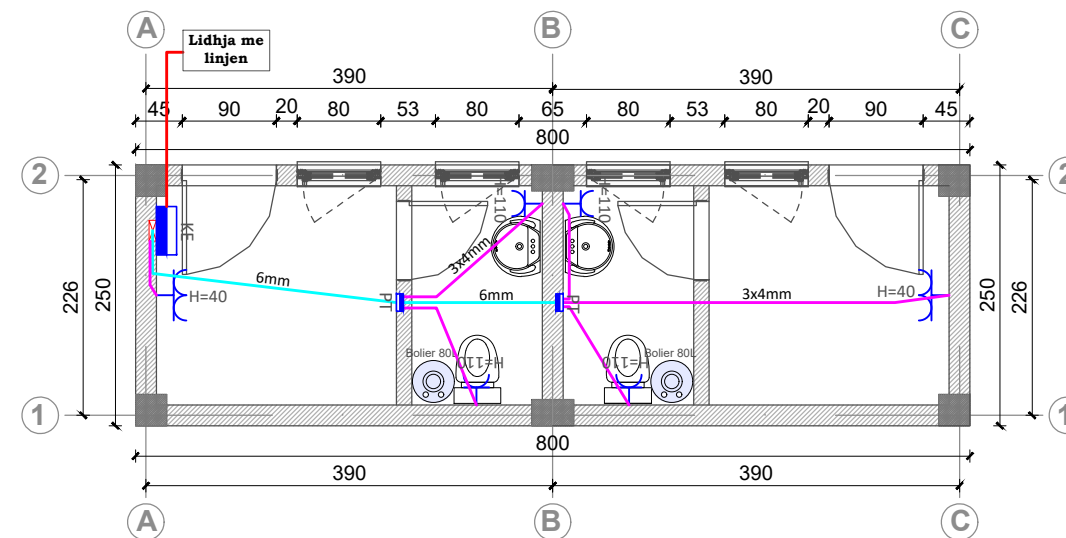

LEGJENDA	
	Celes ndricimi
	Ndricues LED 60x60cm
	Ndricues LED spot
	Percjelles bakri 1.5mm, i instaluar ne tub plastik Ø.25mm
	Percjelles 4 mm i instaluar ne tub plastik Ø.25mm
	Percjelles 6mm i instaluar ne tub plastik Ø.32mm
	Kablo per furnizim nga rrjeti, futur ne toke ne tub

LEGJENDA	
	Prizë shuko universale 16A, 230V, me ushqim nga rrjeti, instaluar ne kuti plastike 3-module
	Prizë shuko dyshe 230V,16A, me ushqim nga rrjeti, instaluar ne kuti plastike 4-module
	Panel/Kuader Elektrik
	Kuti shpendarese PT, brenda murit
	Percjelles bakri 1.5mm, i instaluar ne tub plastik Ø.25mm
	Percjelles 4 mm i instaluar ne tub plastik Ø.25mm
	Percjelles 6mm i instaluar ne tub plastik Ø.32mm
	Kablo per furnizim nga rrjeti, futur ne toke ne tub

BASHKIA CERRIK



ZetaKonsult sh.p.k

Address:Rr."Myrteza Topi",Nd 18, Hyrja 7, Ap 38, TIRANE
 Cel: +355 (0)69 33 52 077
 e-mail:zetakonsultshpk@gmail.com



EMERTIMI I OBJEKTIT:

NDERTIM I SHESHIT REKREATIV SHTERMEN, BASHKIA CERRIK

FAZA E PROJEKTIT :PROJEKT ZBATIMI

EMERTESA E FLETES

Planimetria e ndricimit dhe prizave per dhomat e zhveshjes

SHKALLA Shk:1/75

FLETA 47

GRUPI I PROJEKTIMIT:

Inxh. Ndert.Lorenc HOXHA
 Inxh.Ndert.Flutura Duro

Dt10/09/2024

FORMATI A3

Detaje teknike per dhomat e zhveshjes SH 1:20



MUR I jashtem i tualetit
LARTESIA E HIDROIZOLIMIT BIKOMPONENT 40CM

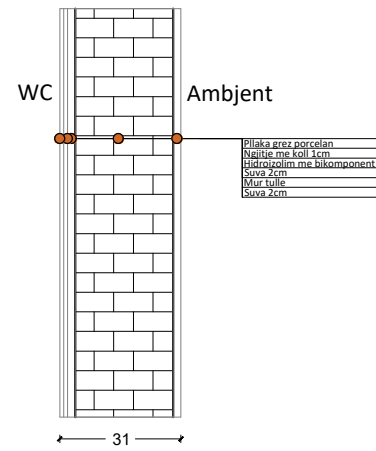

MUR I brendshem i tualetit/interior toilets wall
LARTESIA E HIDROIZOLIMIT MR BIKOMPONENT 120CM

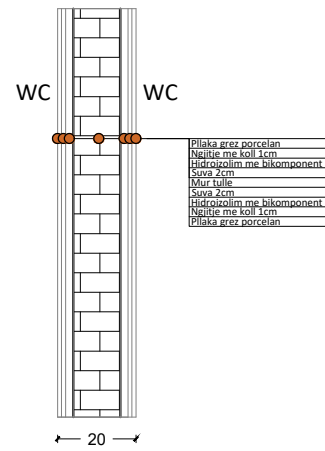

SHTRESAT E SHTRIMIT TE TUALETEVE

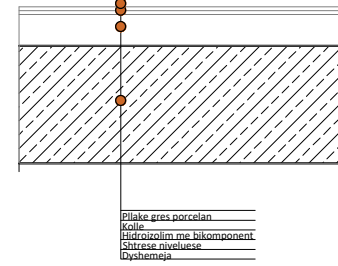

DETAJ DYSHEMEJE AMBIENTESH

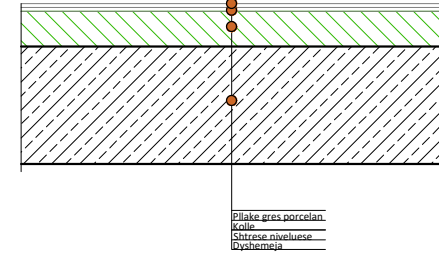

BASHKIA CERRIK



ZetaKonsult sh.p.k

Address:Rr."Myrteza Topi",Nd 18, Hyrja 7, Ap 38, TIRANE

Cel: +355 (0)69 33 52 077

e-mail:zetakonsultshpk@gmail.com



EMERTIMI I OBJEKTIT:
NDERTIM I SHESHIT REKREATIV SHTERMEN, BASHKIA CERRIK

FAZA E PROJEKTIT :PROJEKT ZBATIMI

EMERTESA E FLETES
Detaje teknike per dhomat e zhveshjes

SHKALLA Shk:1/20

FLETA 48

GRUPI I PROJEKTIMIT:

Inxh. Ndert.Lorenc HOXHA
Inxh.Ndert.Flutura Duro

Dt10/09/2024

FORMATI A3

Plani i themeleve per dhomat e zhveshjes SH 1:50



PLANI I THEMELEVE, KUOTE -0.30m

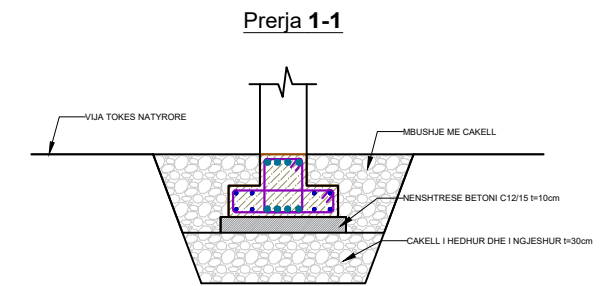
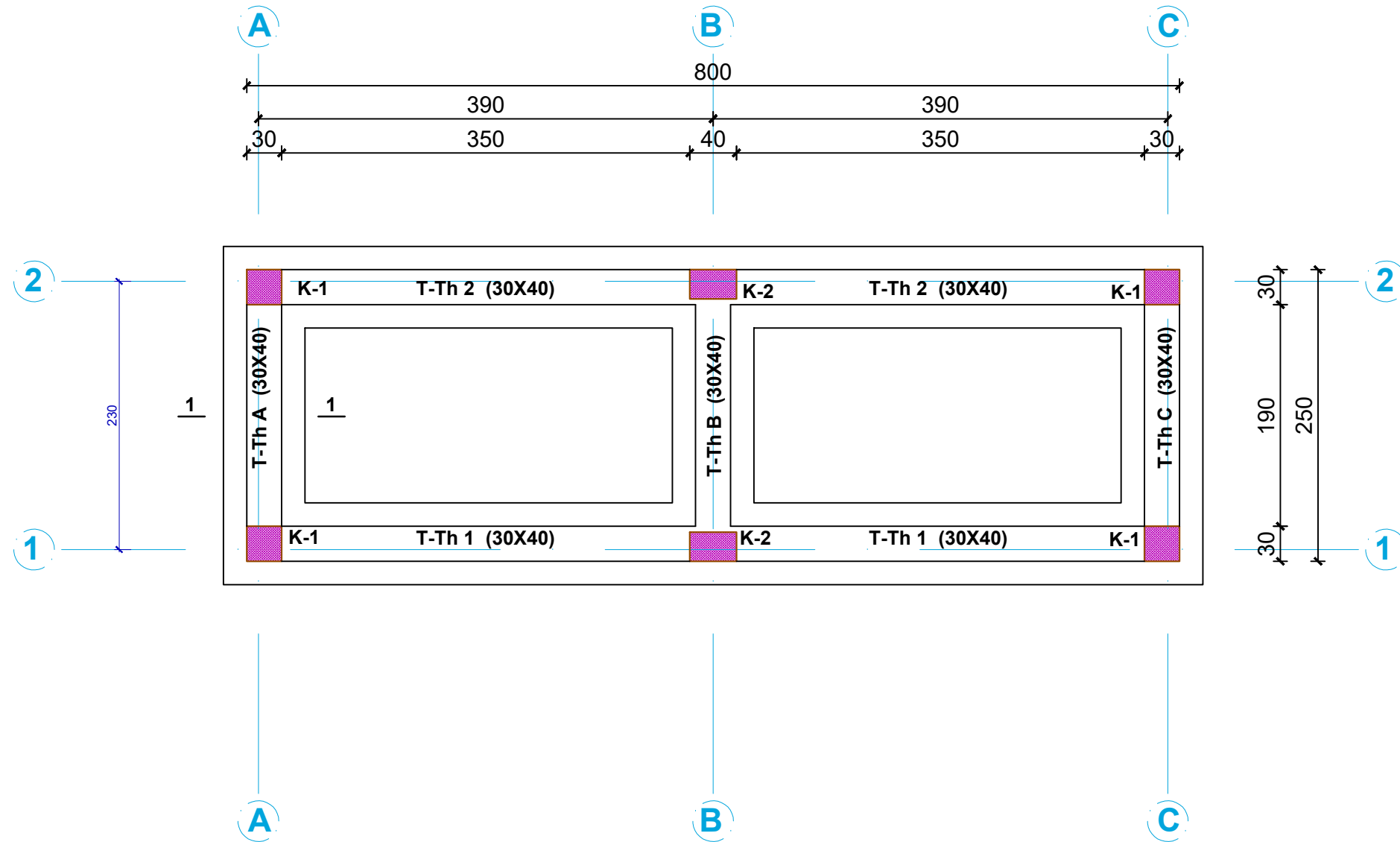

BASHKIA CERRIK



ZetaKonsult sh.p.k

Address: Rr. "Myrteza Topi", Nd 18, Hyrja 7, Ap 38, TIRANE
 Cel: +355 (0)69 33 52 077
 e-mail: zetakonsultshpk@gmail.com



EMERTIMI I OBJEKTIT:

NDERTIM I SHESHIT REKREATIV SHTERMEN, BASHKIA CERRIK

FAZA E PROJEKTIT : PROJEKT ZBATIMI

EMERTESA E FLETES

Plani i themeleve per dhomat e zhveshjes

SHKALLA Shk: 1/50

FLETA 49

GRUPI I PROJEKTIMIT:

Inxh. Ndert. Lorenc HOXHA
 Inxh. Ndert. Flutura Duro

Dt 10/09/2024

FORMATI A3



PLANI I STRUKTURAVE, KUOTE +3.05m

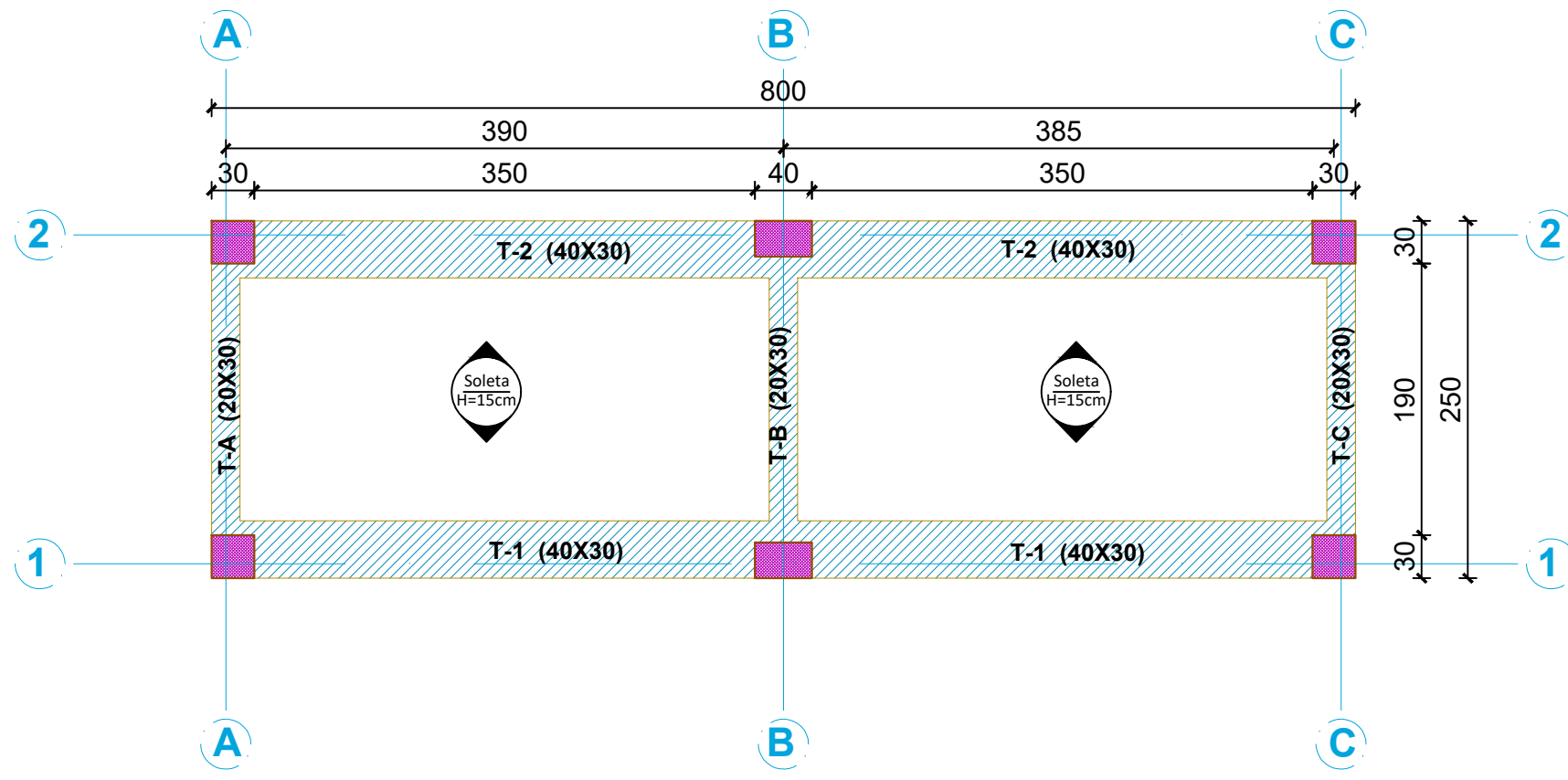

BASHKIA CERRIK



ZetaKonsult sh.p.k

Address:Rr."Myrteza Topi",Nd 18, Hyrja 7, Ap 38, TIRANE
 Cel: +355 (0)69 33 52 077
 e-mail:zetakonsultshpk@gmail.com



EMERTIMI I OBJEKTIT:

NDERTIM I SHESHIT REKREATIV SHTERMEN, BASHKIA CERRIK

FAZA E PROJEKTIT :PROJEKT ZBATIMI

EMERTESA E FLETES

Plani i strukturave per dhomat e zhveshjes

SHKALLA Shk:1/50

FLETA 50

GRUPI I PROJEKTIMIT:

Inxh. Ndert.Lorenc HOXHA
 Inxh.Ndert.Flutura Duro

Dt10/09/2024

FORMATI A3

PRERJE GJATESORE E
TRAUT TE THEMELIT T-TH 1 & T-TH 2

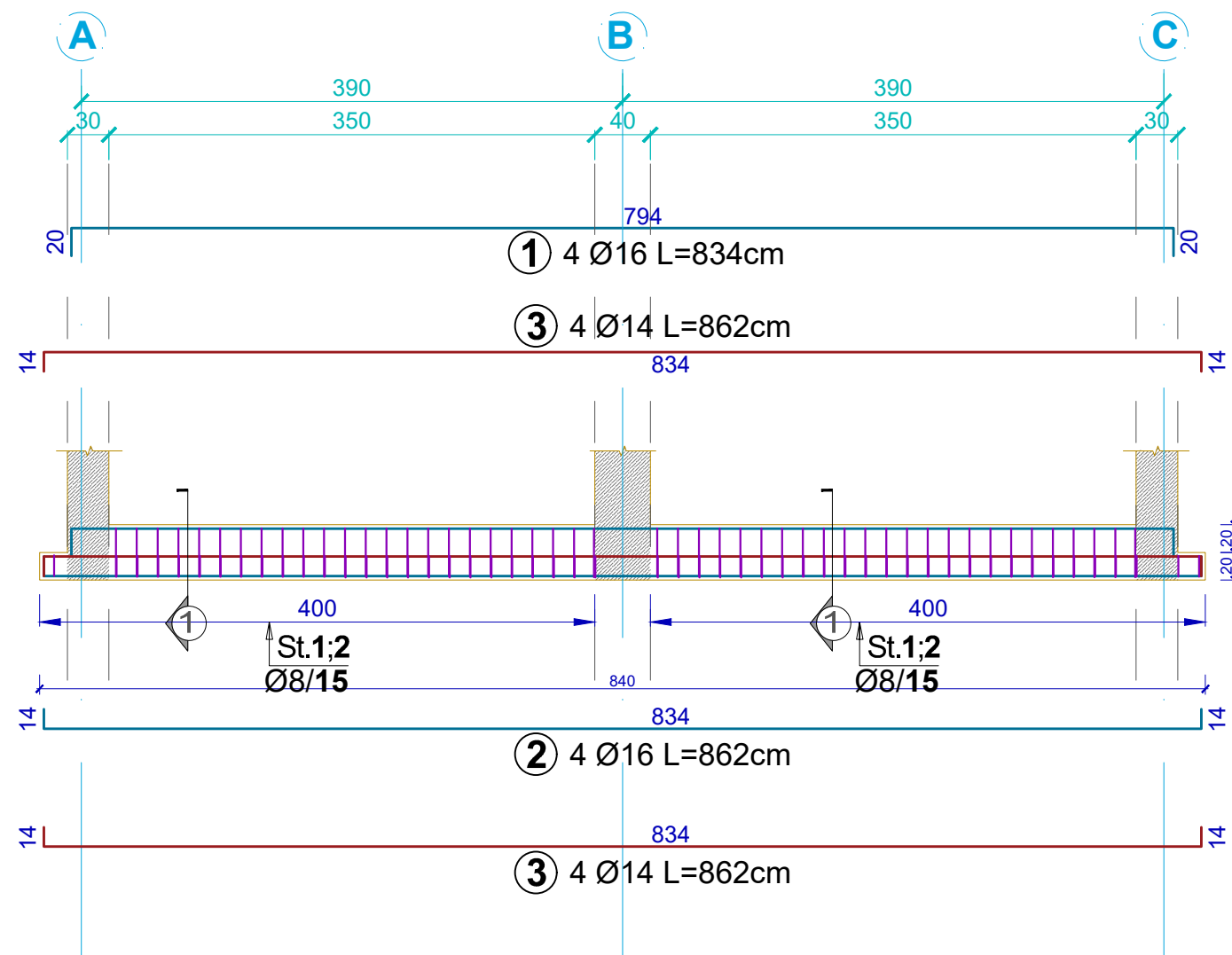

PRERJE TERTHORE

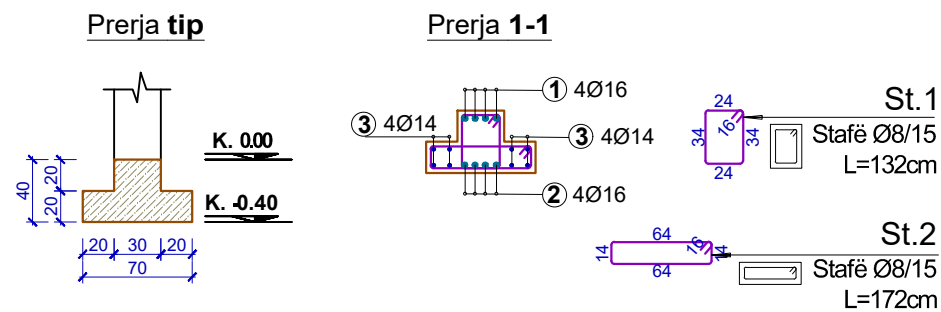

BASHKIA CERRIK



ZetaKonsult sh.p.k

Address:Rr."Myrteza Topi",Nd 18, Hyrja 7, Ap 38, TIRANE
Cel: +355 (0)69 33 52 077
e-mail:zetakonsultshpk@gmail.com



EMERTIMI I OBJEKTIT:
NDERTIM I SHESHIT REKREATIV SHTERMEN, BASHKIA
CERRIK

FAZA E PROJEKTIT :PROJEKT ZBATIMI

EMERTESA E FLETES
Prerja gjatesore e traut te themelit per
dhomat e zhveshjes

SHKALLA Shk:1/50

FLETA 51

GRUPI I PROJEKTIMIT:

Inxh. Ndert.Lorenc HOXHA
Inxh.Ndert.Flutura Duro

Dt10/09/2024

FORMATI A3



PRERJE GJATESORE E TRAUT T-1 & T-2

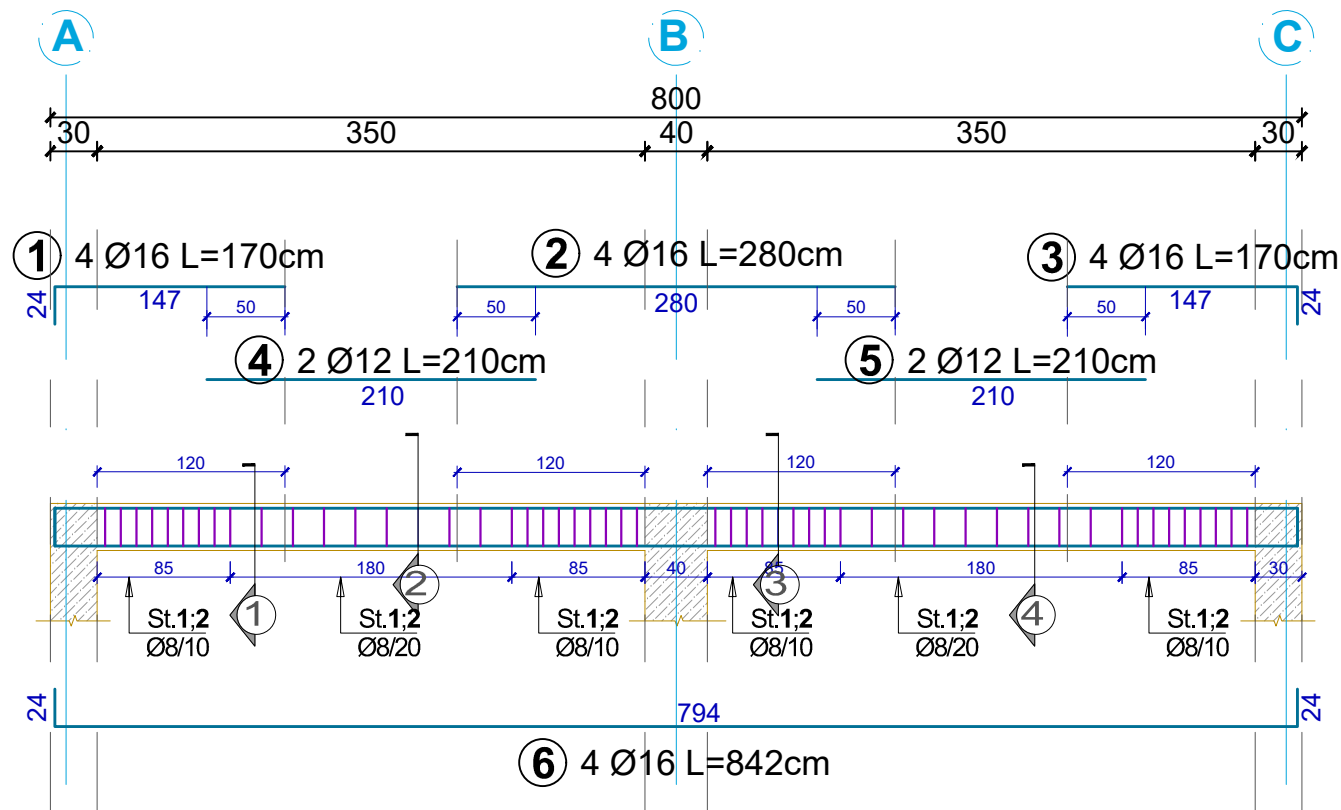

PRERJE GJATESORE E TRAUT T-A, T-B, T-C

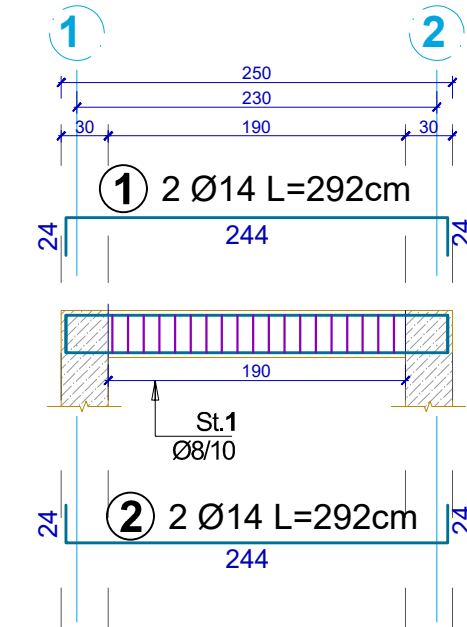

PRERJE TERTHORE

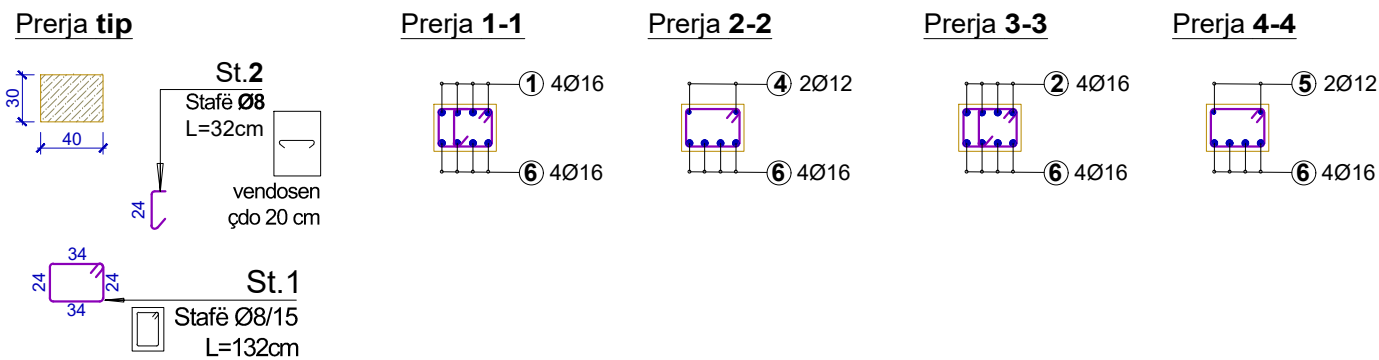

PRERJE TERTHORE





**PRERJE GJATESORE E TRAUT TE THEMELIT
T-TH A & T-TH B & T-TH C**

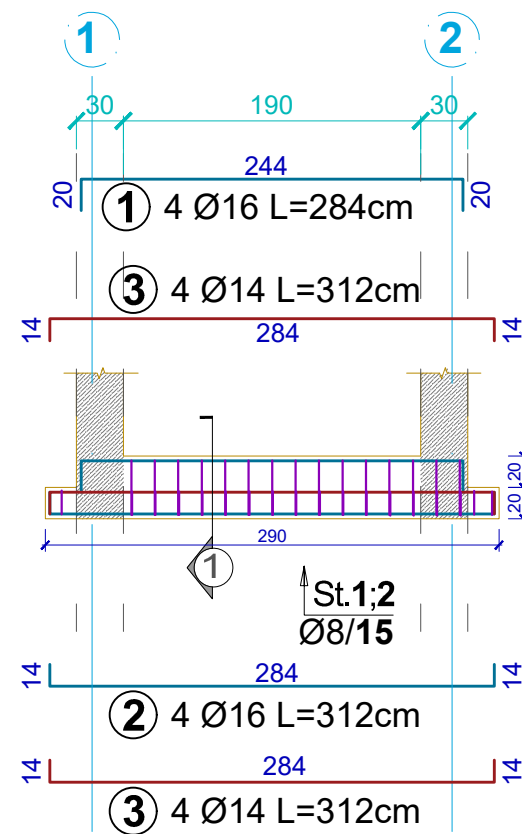

PRERJE TERTHORE

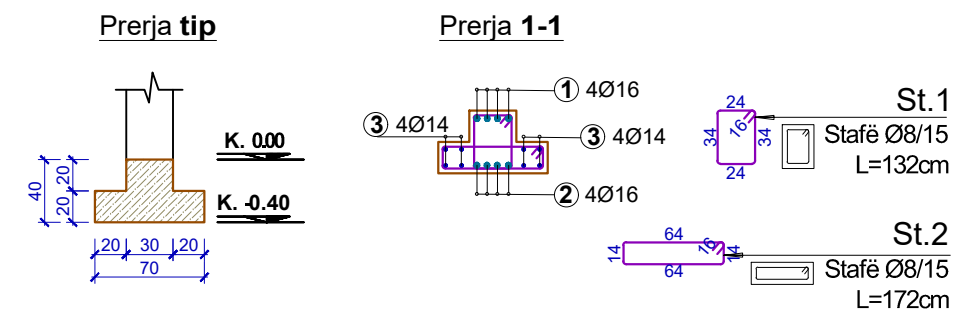



KONSTRUIMI I SOLETES, KUOTE +3.05m

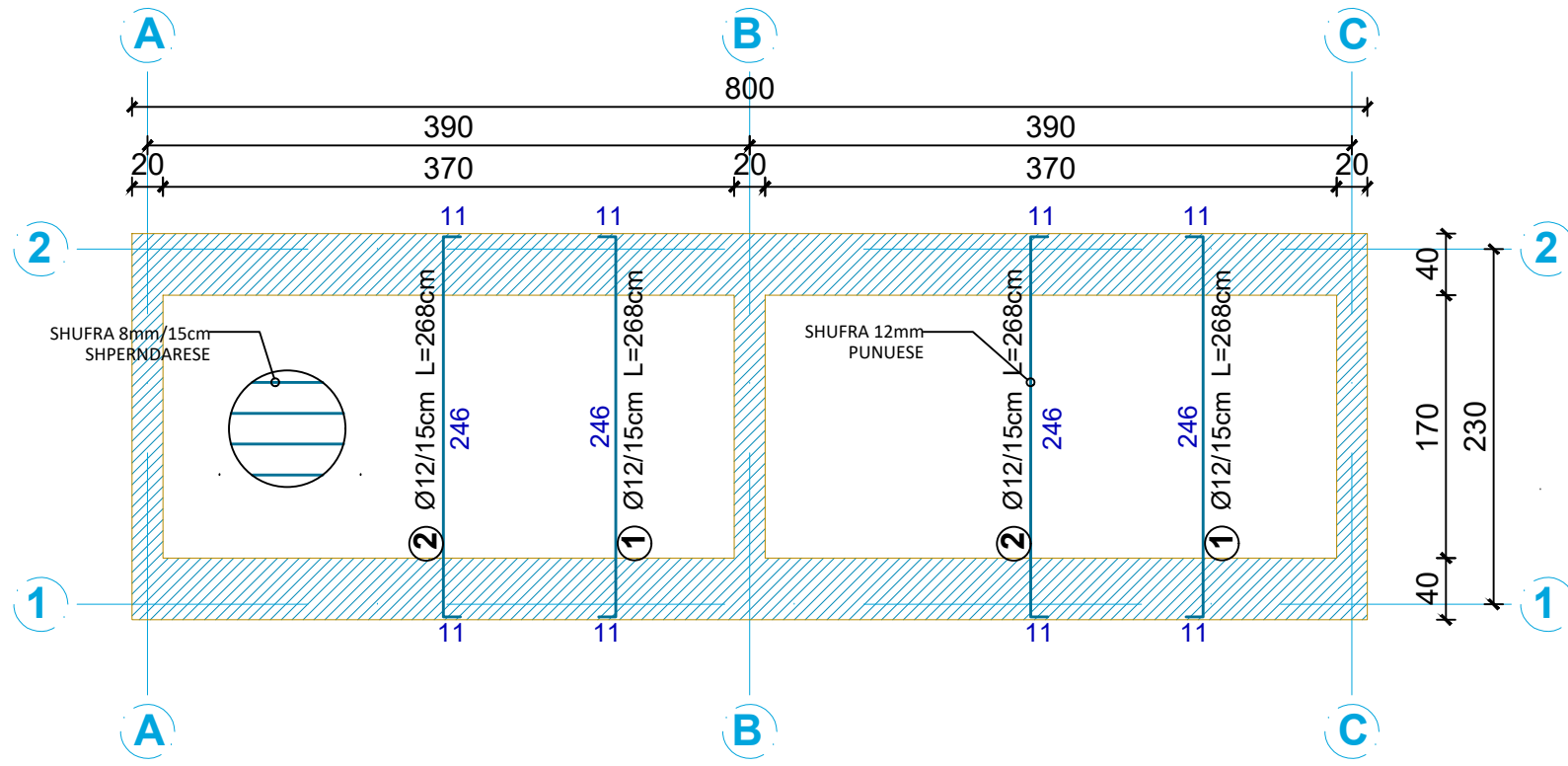

Detaj i elementeve te thelle te planit te shtrukurave

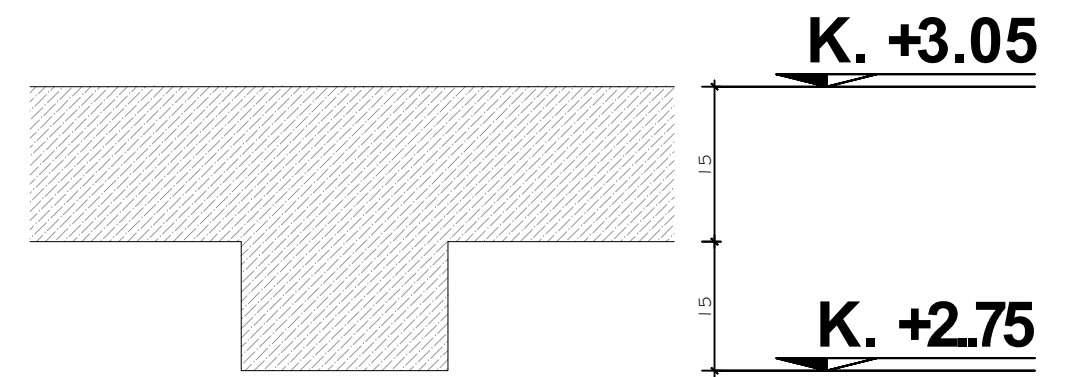

PRERJE E GODINES

<p>BASHKIA CERRIK</p> 	<p>ZetaKonsult sh.p.k Address:Rr."Myrteza Topi",Nd 18, Hyrja 7, Ap 38, TIRANE Cel: +355 (0)69 33 52 077 e-mail:zetakonsultshpk@gmail.com</p> 	<p>EMERTIMI I OBJEKTIT: NDERTIM I SHESHIT REKREATIV SHTERMEN, BASHKIA CERRIK</p>	<p>EMERTESA E FLETES Konstruimi i soletes dhe detaje teknike per dhomat e zhveshjes</p>		<p>GRUPI I PROJEKTIMIT: Inxh. Ndert.Lorenc HOXHA Inxh.Ndert.Flutura Duro</p>	<p>Dt10/09/2024</p>
		<p>FAZA E PROJEKTIT :PROJEKT ZBATIMI</p>	<p>SHKALLA Shk:1/50</p>	<p>FLETA 54</p>	<p>FORMATI A3</p>	



PRERJE E GODINES

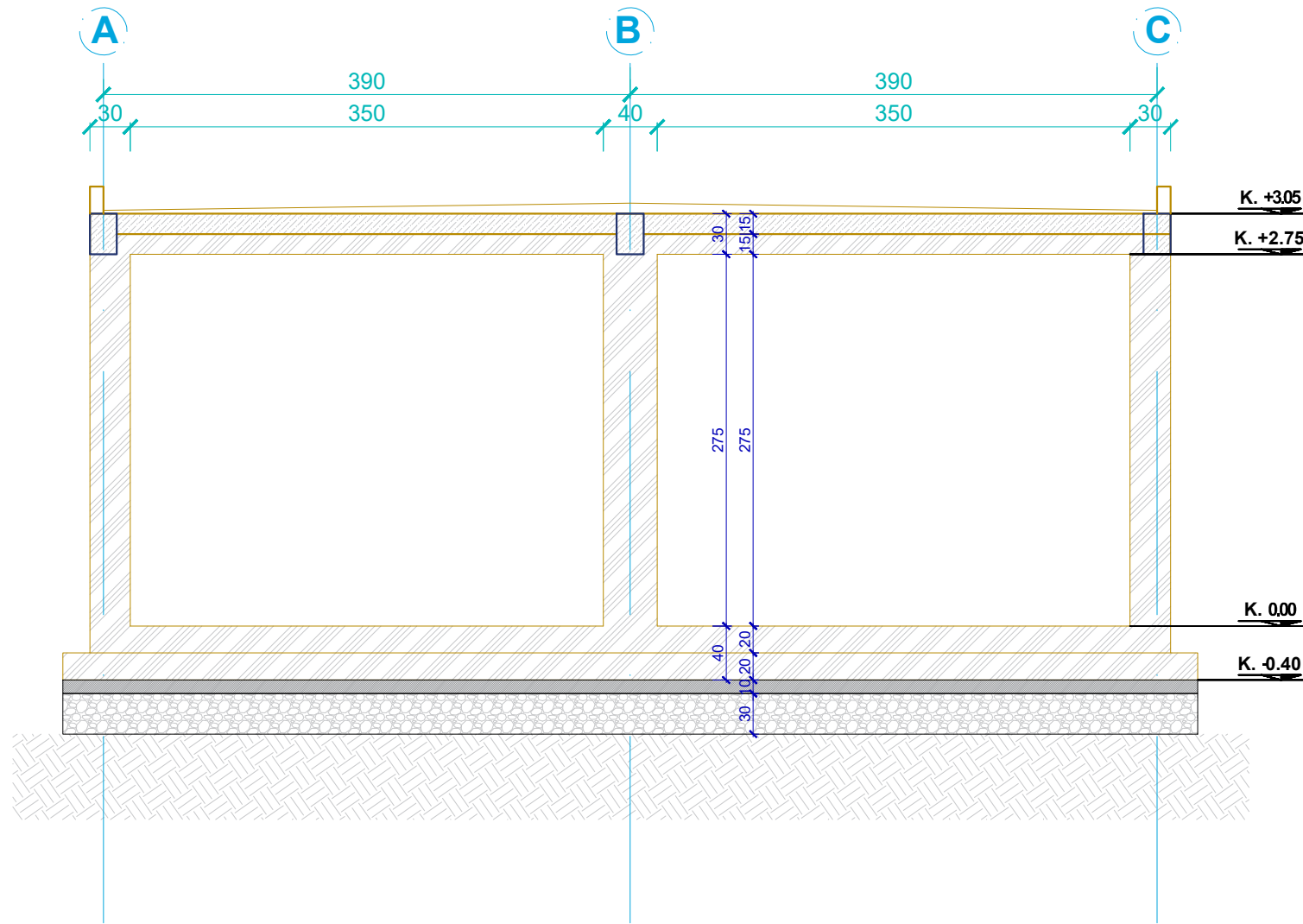

PRERJE E PARAPETIT B/A

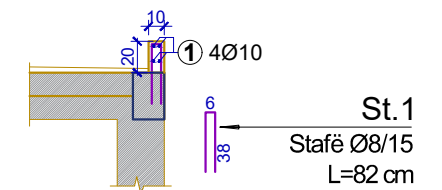



PRERJE E KOLLONES K-1 (30x30) 4 COPE

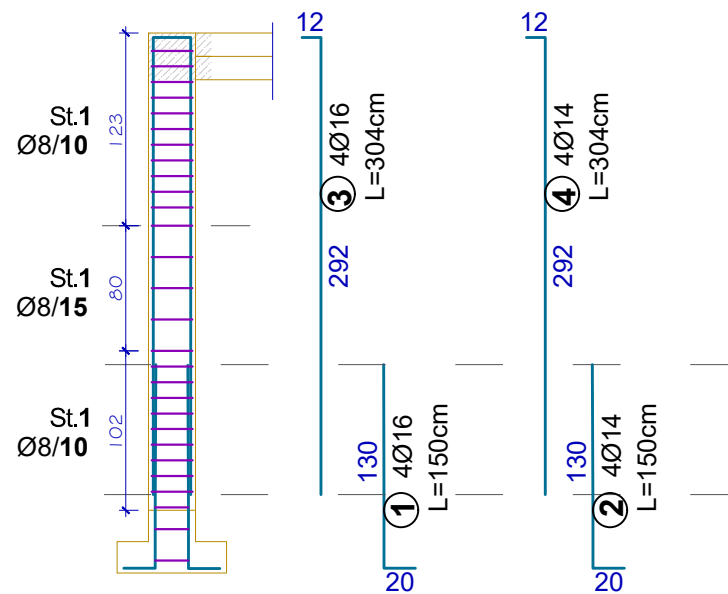

PRERJE E KOLLONES K-2 (25x40) 4 COPE

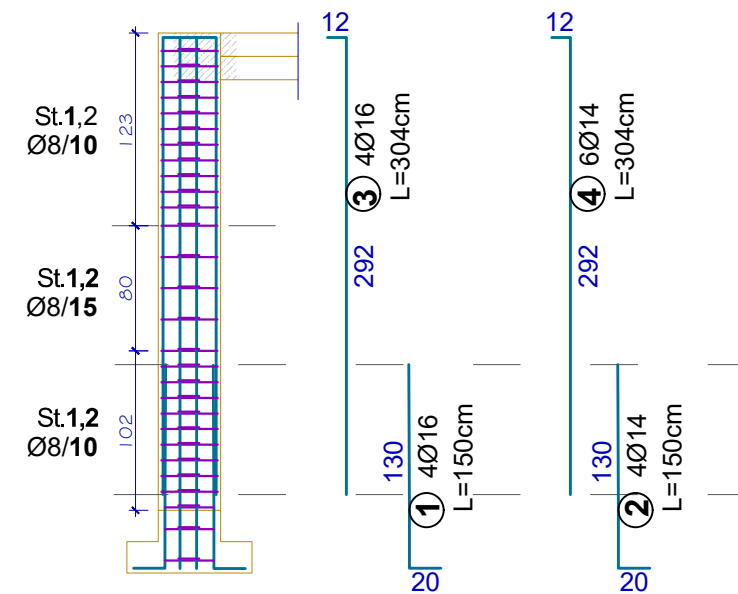

PRERJE TERTHORE

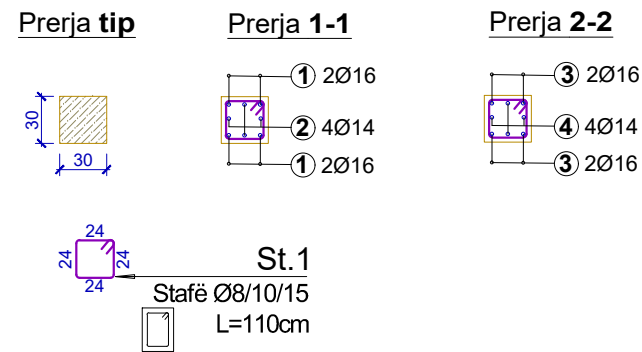

PRERJE TERTHORE

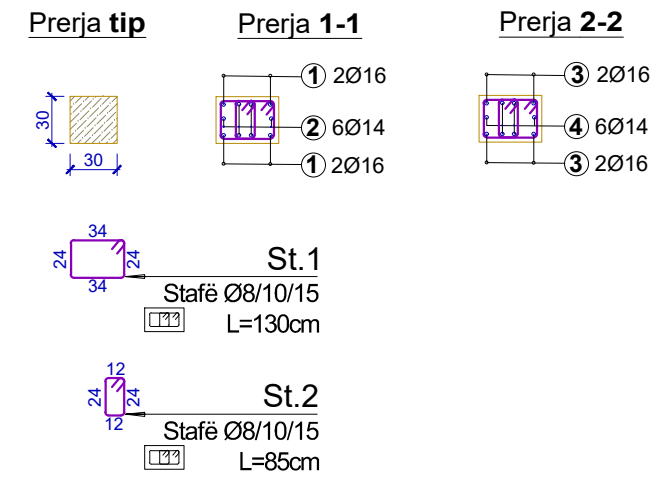

Planimetria e dimensionuar teknike e fushes SH 1:100

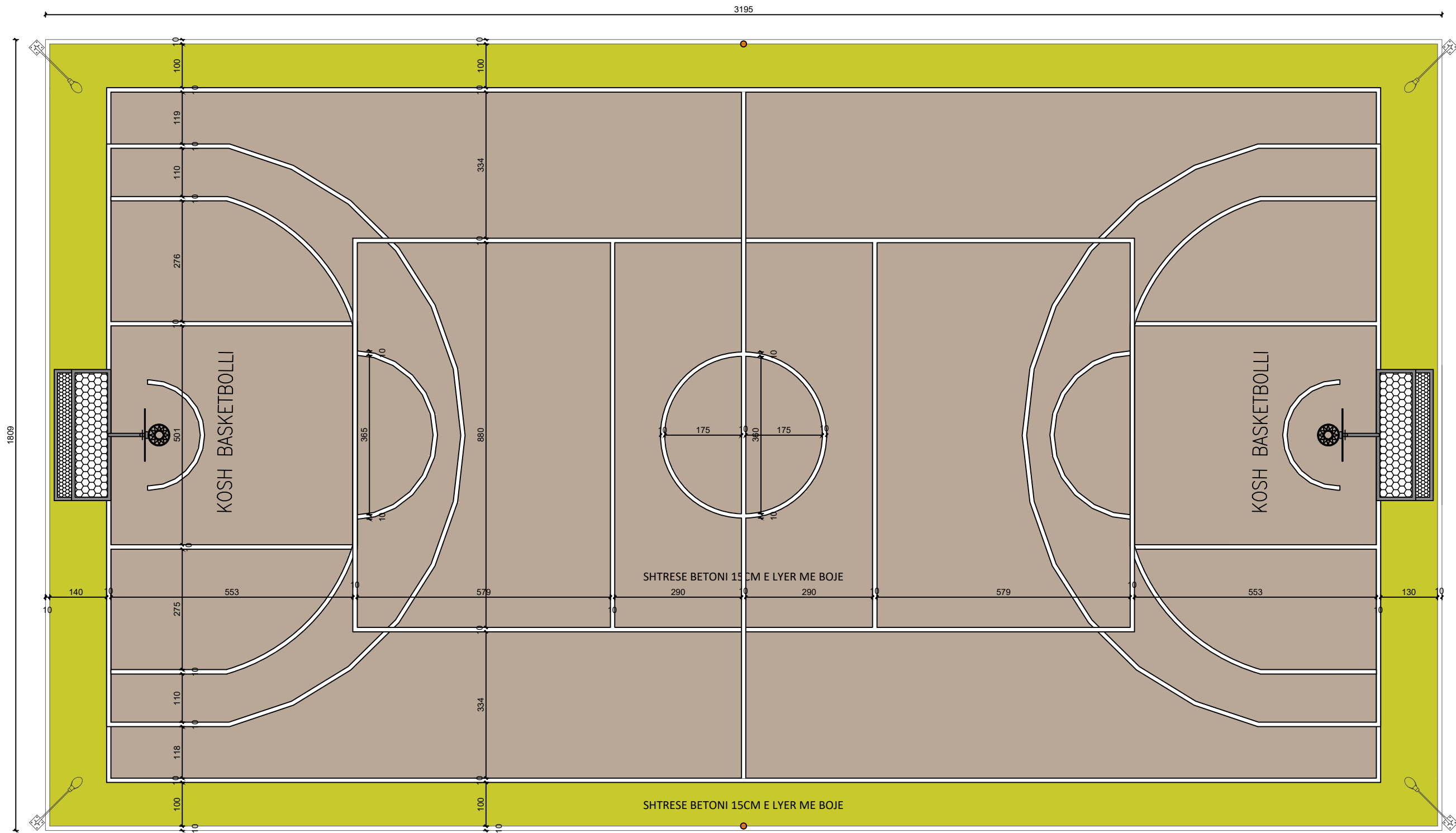

POZICION KU
MUND TE
VENDOSSET
RRJETE

BASHKIA CERRIK



ZetaKonsult sh.p.k

Address:Rr."Myrteza Topi",Nd 18, Hyrja 7, Ap 38, TIRANE
Cel:+355 (0)69 33 52 077
e-mail:zetakonsultshpk@gmail.com



EMERTIMI I OBJEKTIT:
NDERTIM I SHESHIT REKREATIV SHTERMEN,BASHKIA
CERRIK

FAZA E PROJEKTIT :PROJEKT ZBATIMI

EMERTESA E FLETES
Planimetria e dimensionuar teknike e
fushes

SHKALLA Shk:1/100

FLETA 57

GRUPI I PROJEKTIMIT:

Inxh. Ndert.Lorenc HOXHA
Inxh.Ndert.Flutura Duro

Dt10/09/2024

FORMATI A3

Prerja dhe detaje teknike te fushes SH 1:100

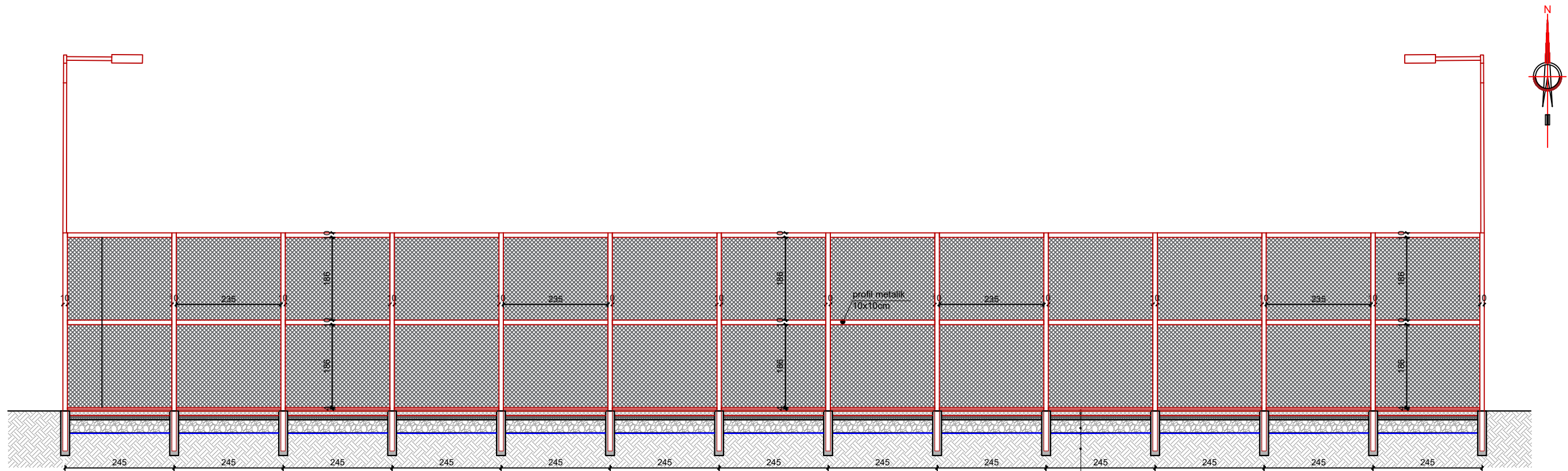

Shtrese betoni industrial me trajtim me
helikopter, boje, puder/cim., kuarc, etj 10cm
Nenshtrese betoni C16/20 me zgare
hekuri (15cm)
stabilizant (10cm)
zhavor/cakell (20cm)
Toke natyrale

DETAJI 1 - RRETHIMI I FUSHES

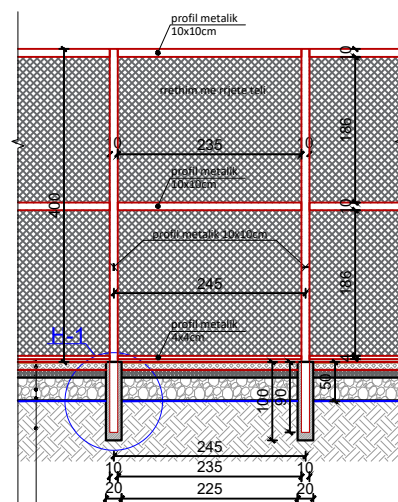

Shtrese betoni industrial me trajtim me
helikopter, boje, puder/cim., kuarc, etj 10cm
Shtrese betoni C20/25 me zgare
hekuri (15cm)
stabilizant (10cm)
zhavor/cakell (20cm)
Toke natyrale

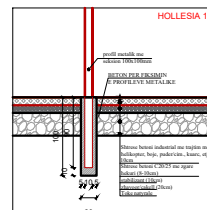
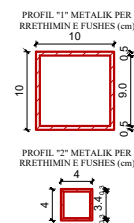

BASHKIA CERRIK



ZetaKonsult sh.p.k

Address: Rr. "Myrteza Topi", Nd 18, Hyrja 7, Ap 38, TIRANE

Cel: +355 (0)69 33 52 077

e-mail: zetakonsultshpk@gmail.com



EMERTIMI I OBJEKTIT:
NDERTIM I SHESHIT REKREATIV SHTERMEN, BASHKIA
CERRIK

FAZA E PROJEKTIT : PROJEKT ZBATIMI

EMERTESA E FLETES
Prerja dhe detaje teknike te te fushes

SHKALLA Shk: 1/100

FLETA 58

GRUPI I PROJEKTIMIT:

Inxh. Ndert. Lorenc HOXHA
Inxh. Ndert. Flutura Duro

Dt 10/09/2024

FORMATI A3

Planimetria e fushes SH 1:100

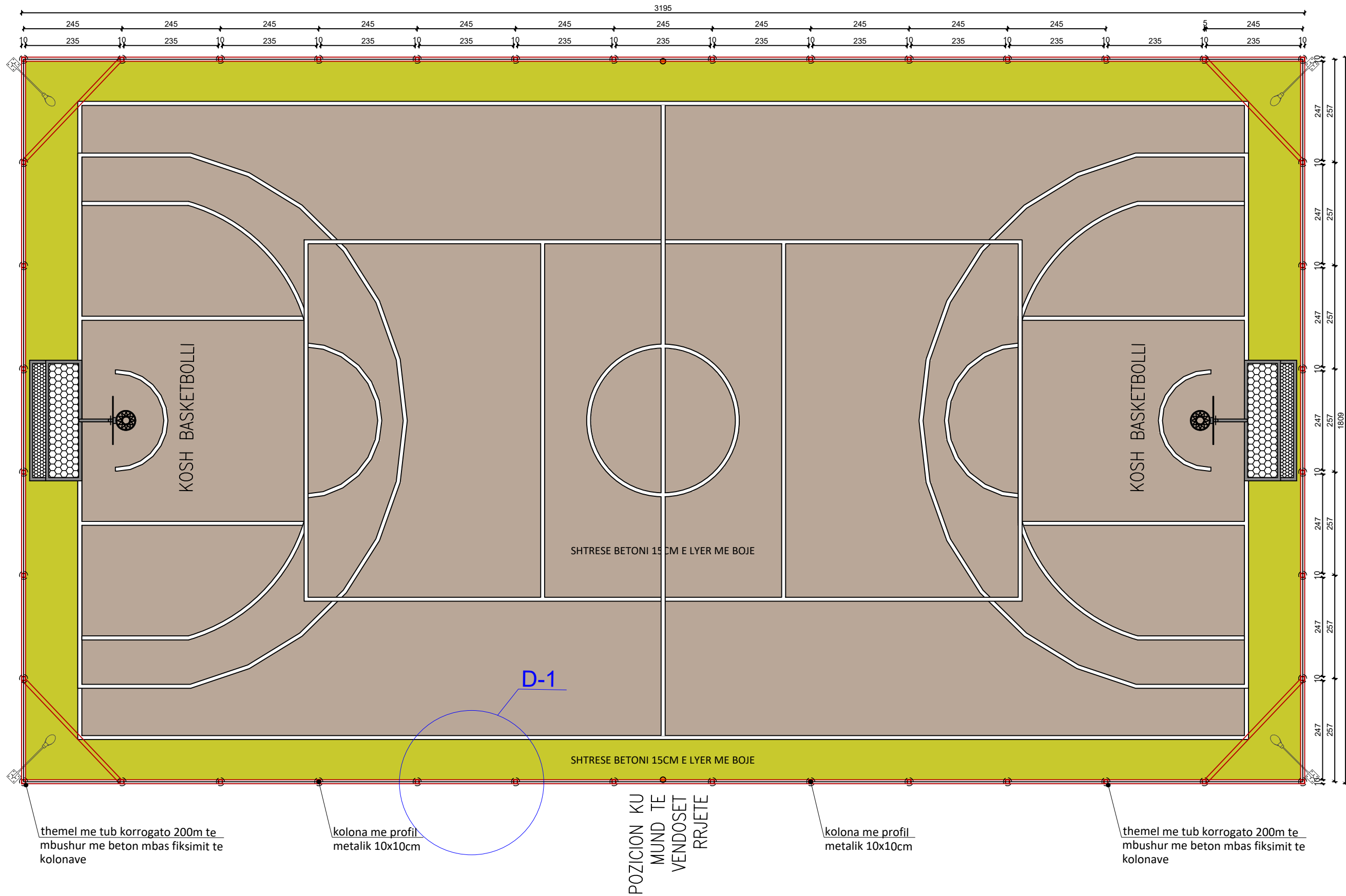

BASHKIA CERRIK 	ZetaKonsult sh.p.k Address:Rr."Myrteza Topi",Nd 18, Hyrja 7, Ap 38, TIRANE Cel:+355 (0)69 33 52 077 e-mail:zetakonsultshpk@gmail.com 	EMERTIMI I OBJEKTIT: NDERTIM I SHESHIT REKREATIV SHTERMEN,BASHKIA CERRIK		EMERTESA E FLETES Planimetria e fushes		GRUPI I PROJEKTIMIT: Inxh. Ndert.Lorenc HOXHA Inxh.Ndert.Flutura Duro		Dt10/09/2024
		FAZA E PROJEKTIT :PROJEKT ZBATIMI		SHKALLA Shk:1/100	FLETA 59	FORMATI A3		

Plani i dyshemese dhe detaje teknike per vendosjen e gabines SH 1:50

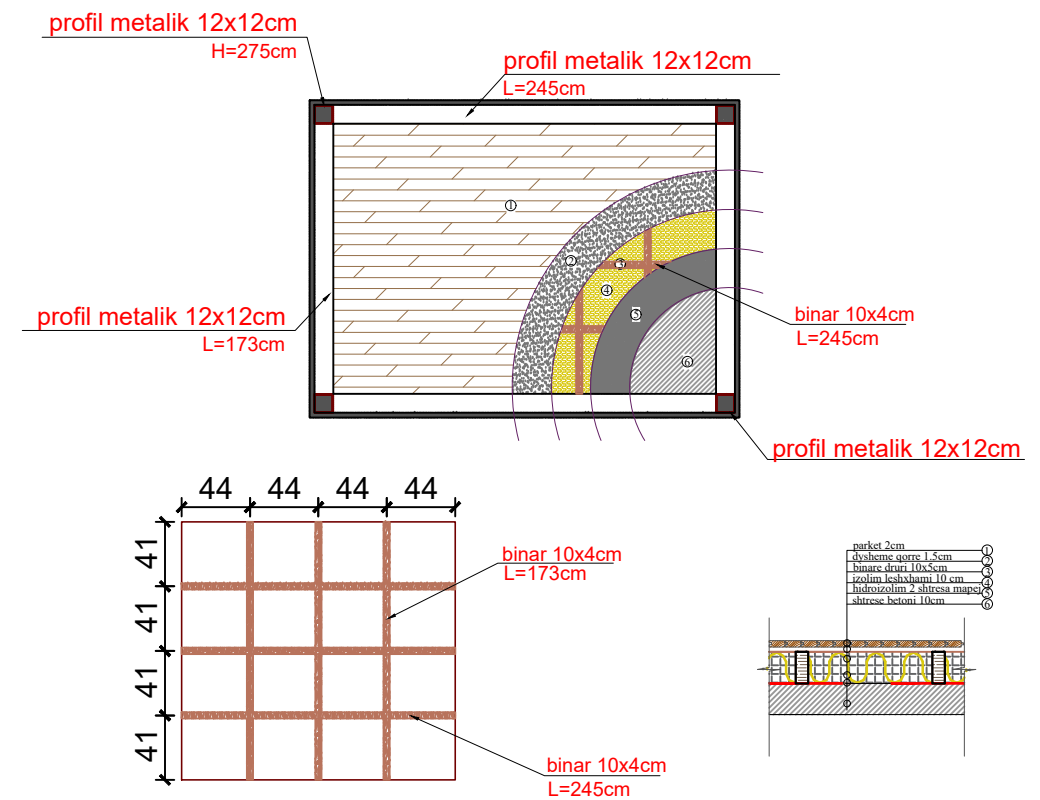
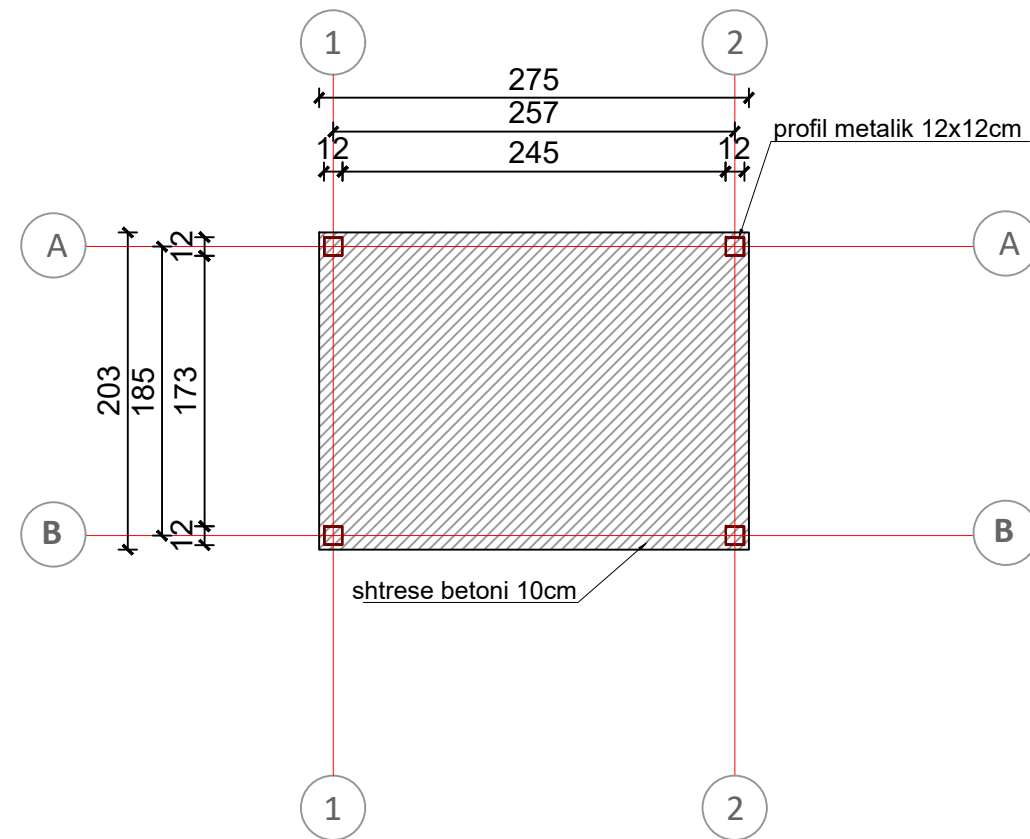

Planimetria e dimensionuar e gabines SH 1:30

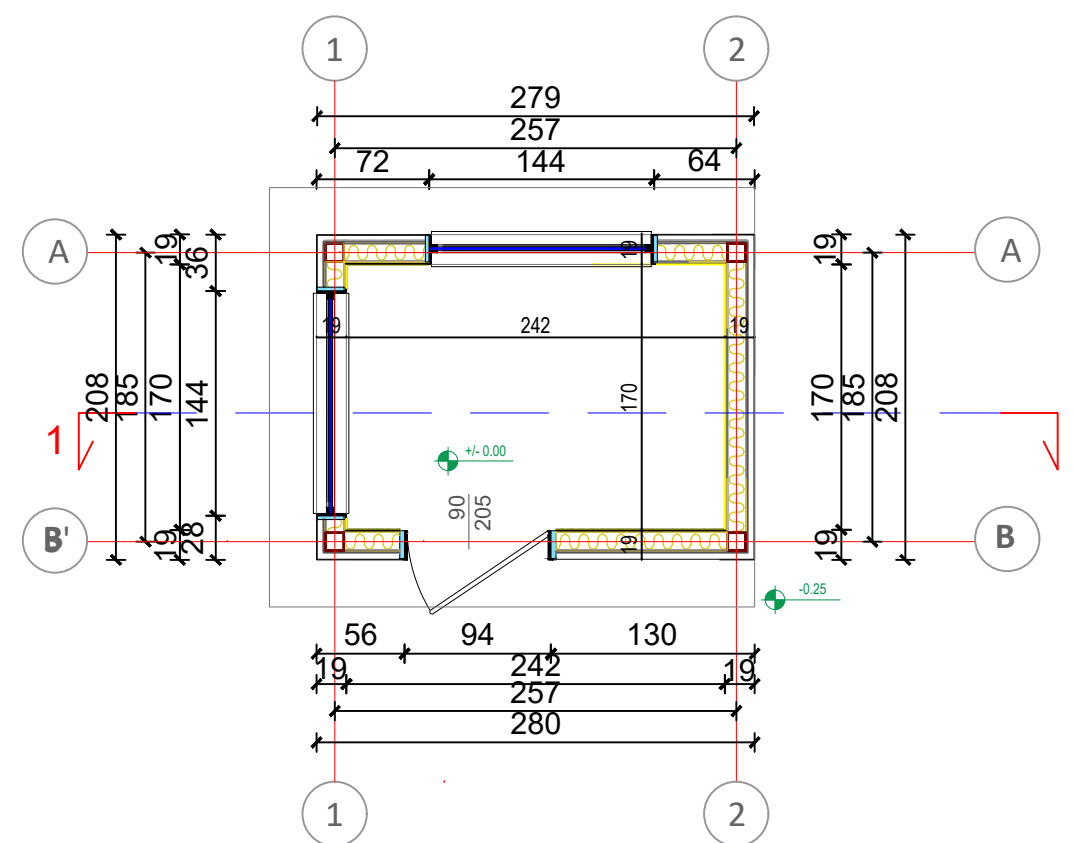
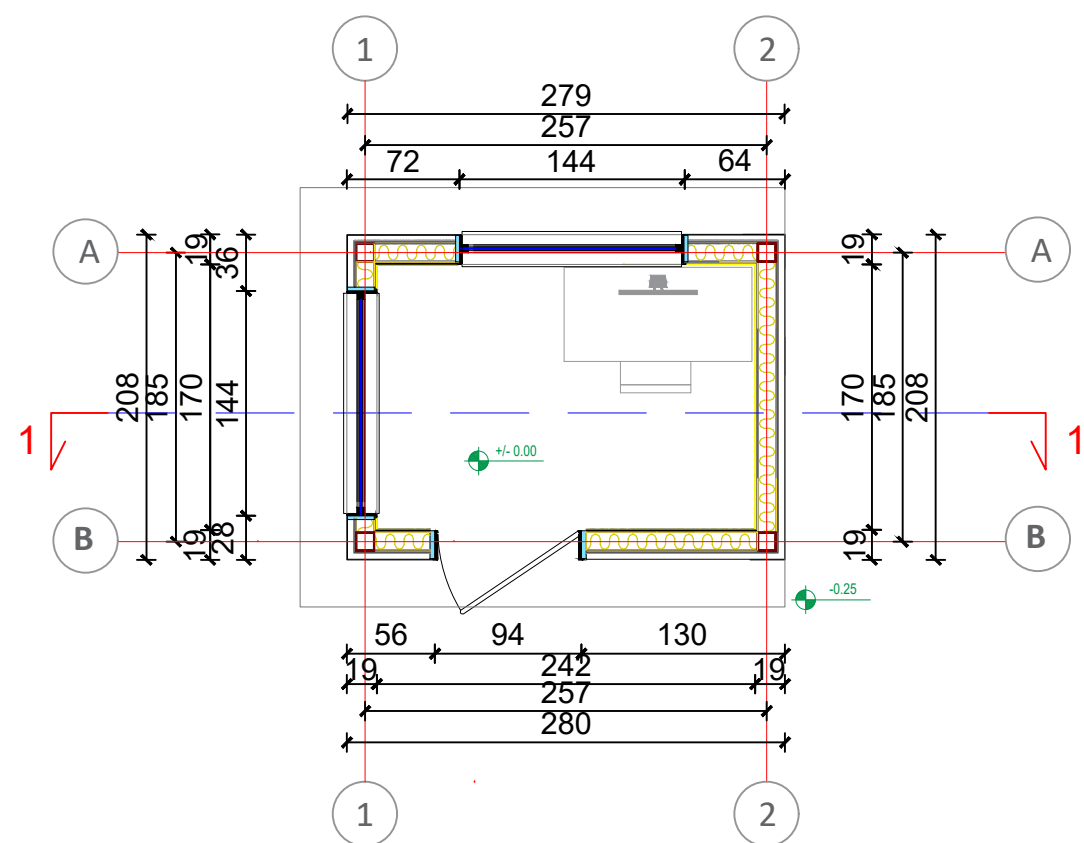

BASHKIA CERRIK



ZetaKonsult sh.p.k

Address: Rr. "Myrteza Topi", Nd 18, Hyrja 7, Ap 38, TIRANE

Cel: +355 (0)69 33 52 077

e-mail: zetakonsultshpk@gmail.com



EMERTIMI I OBJEKTIT:

NDERTIM I SHESHIT REKREATIV SHTERMEN, BASHKIA CERRIK

FAZA E PROJEKTIT : PROJEKT ZBATIMI

EMERTESA E FLETES

Planimetria e dimensionuar e gabines

SHKALLA Shk: 1/50

FLETA 61

GRUPI I PROJEKTIMIT:

Inxh. Ndert. Lorenc HOXHA
Inxh. Ndert. Flutura Duro

Dt 10/09/2024

FORMATI A3

Prerje dhe detaje teknike te gabines SH 1:50

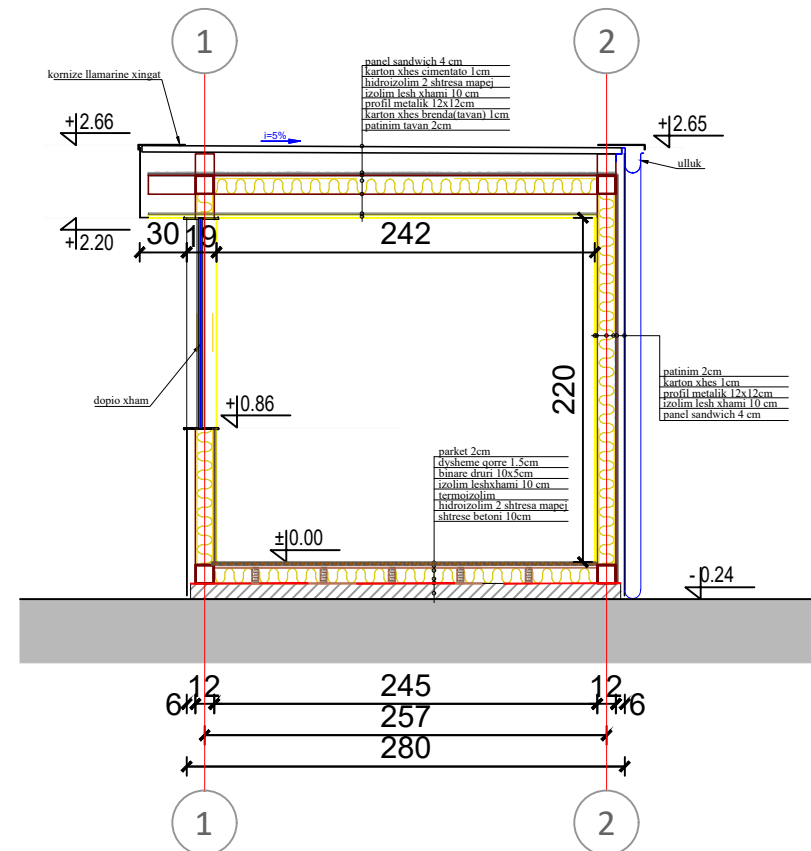
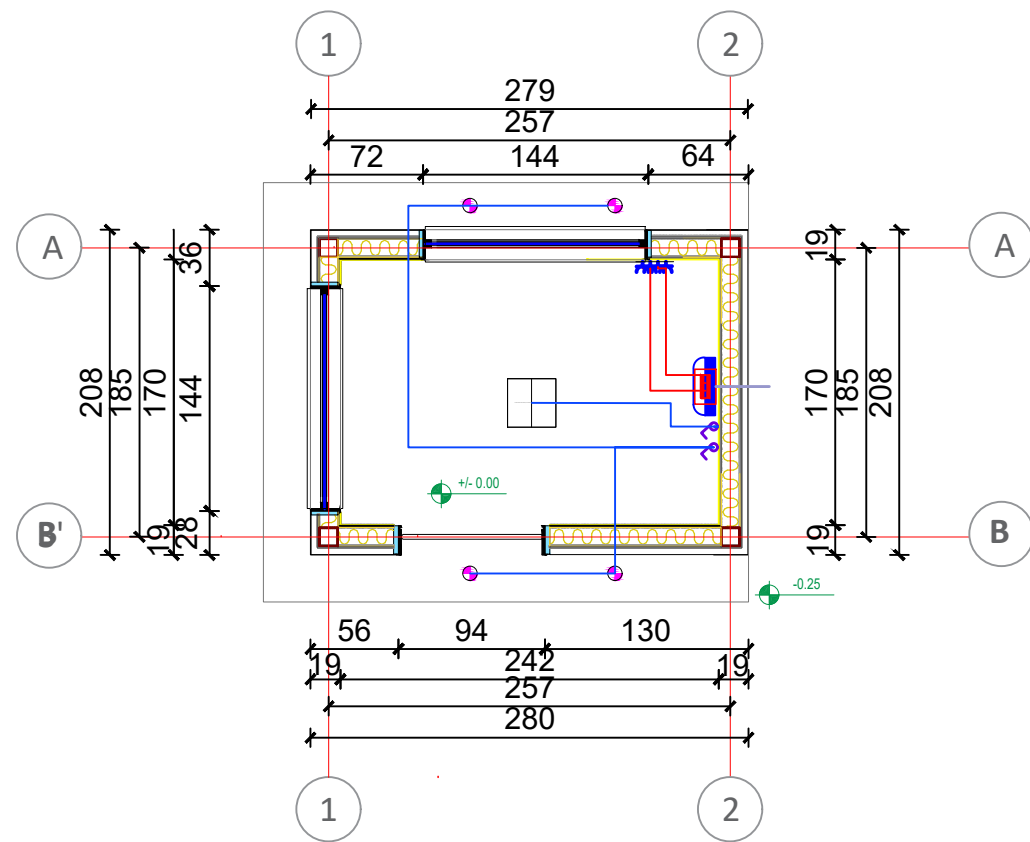

BASHKIA CERRIK



ZetaKonsult sh.p.k

Address: Rr. "Myrteza Topi", Nd 18, Hyrja 7, Ap 38, TIRANE

Cel: +355 (0)69 33 52 077

e-mail: zetakonsultshpk@gmail.com



EMERTIMI I OBJEKTIT:

NDERTIM I SHESHIT REKREATIV SHTERMEN, BASHKIA CERRIK

FAZA E PROJEKTIT : PROJEKT ZBATIMI

EMERTESA E FLETES

Prerje dhe detaje teknike te gabines

SHKALLA Shk: 1/50

FLETA 62

GRUPI I PROJEKTIMIT:

Inxh. Ndert. Lorenc HOXHA
Inxh. Ndert. Flutura Duro

Dt 10/09/2024

FORMATI A3

Plani i mbuleses dhe fasada e gabines SH 1:50

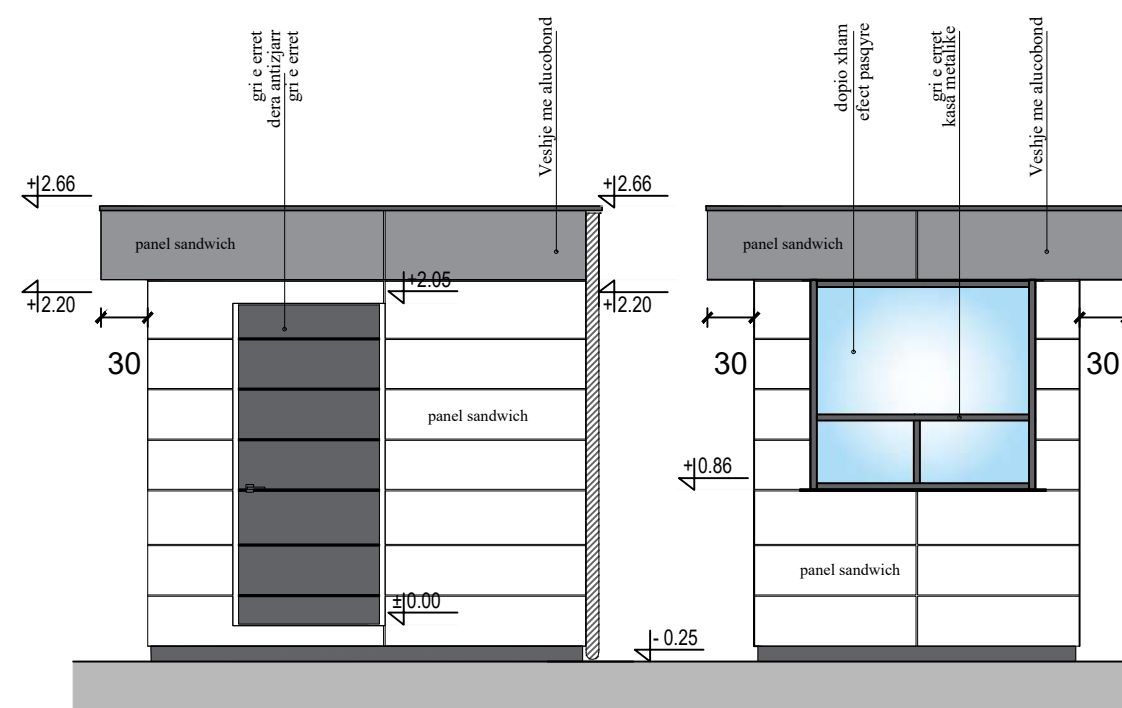
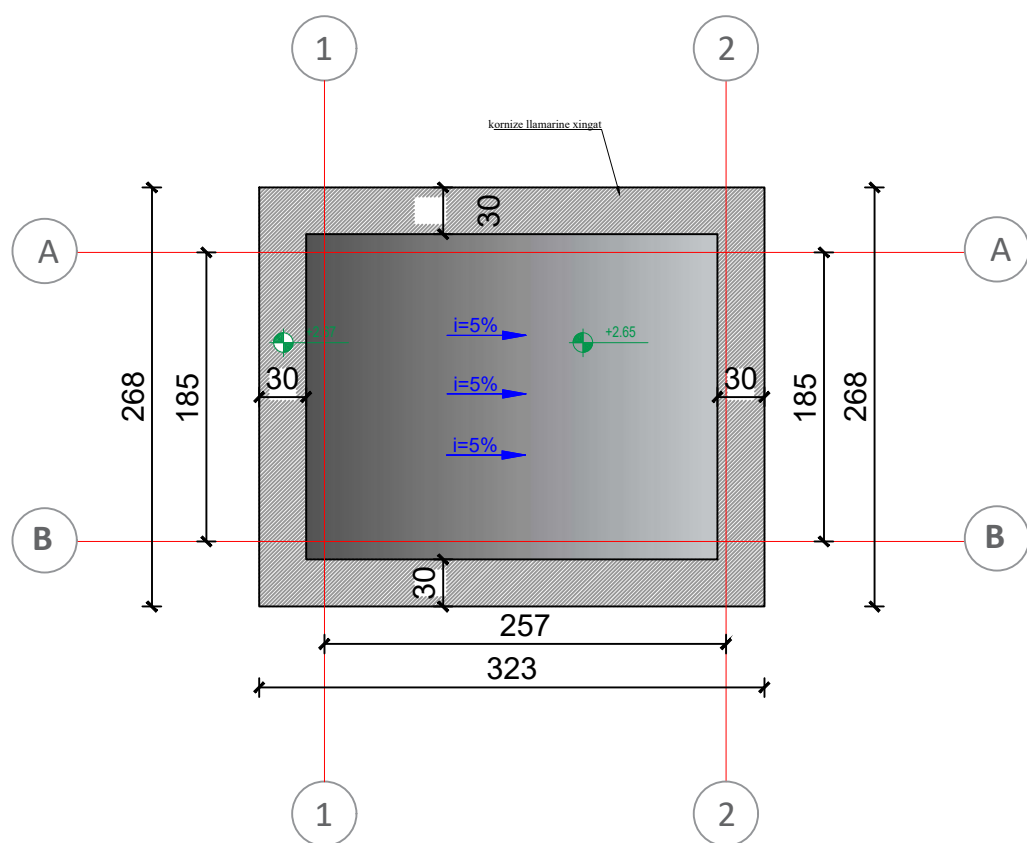

BASHKIA CERRIK



ZetaKonsult sh.p.k

Address:Rr."Myrteza Topi",Nd 18, Hyrja 7, Ap 38, TIRANE

Cel:+355 (0)69 33 52 077

e-mail:zetakonsultshpk@gmail.com



EMERTIMI I OBJEKTIT:

NDERTIM I SHESHIT REKREATIV SHTERMEN,BASHKIA CERRIK

FAZA E PROJEKTIT :PROJEKT ZBATIMI

EMERTESA E FLETES

Plani i mbuleses dhe fasada e gabines

SHKALLA Shk:1/50

FLETA 63

GRUPI I PROJEKTIMIT:

Inxh. Ndert.Lorenc HOXHA
Inxh.Ndert.Flutura Duro

Dt10/09/2024

FORMATI A3