



REPUBLIKA E SHQIPËRISË  
BASHKIA CERRIK

MIRATOHET  
KRYETAR  
z.Andis SALLA

---

# PROJEKT ZBATIMI

OBJEKTI: "NDERTIMI I SHESHIT REKREATIV SHTERMEN, BASHKIA CERRIK



Projektues: ZetaKonsult sh.p.k

Address:Rr."Myrteza Topi",Nd 18, Hyrja 7, Ap 38, TIRANE

Cel:+355 (0)69 33 52 077

e-mail:zetakonsultshpk@gmail.com

# Topografia e Objektivit SH 1:500



BASHKIA CERRIK



**ZetaKonsult sh.p.k**

Address: Rr. "Myrteza Topi", Nd 18, Hyrja 7, Ap 38, TIRANE  
 Cel: +355 (0)69 33 52 077  
 e-mail: zetakonsultshpk@gmail.com



**EMERTIMI I OBJEKTIT:**  
 NDERTIM I SHESHIT REKREATIV SHTERMEN, BASHKIA CERRIK

FAZA E PROJEKTIT : PROJEKT ZBATIMI

EMERTESA E FLETES TOPOGRAFIA

SHKALLA Shk: 1/500

FLETA 01

GRUPI I PROJEKTIMIT:

Inxh. Ndert. Lorenc HOXHA  
 Inxh. Ndert. Flutura DURO

Dt 10/09/2024

FORMATI A3

# Planimetria e Pergjithshme SH 1:500



BASHKIA CERRIK



**ZetaKonsult sh.p.k**

Address: Rr. "Myrteza Topi", Nd 18, Hyrja 7, Ap 38, TIRANE

Cel: +355 (0)69 33 52 077

e-mail: zetakonsultshpk@gmail.com



**EMERTIMI I OBJEKTIT:**  
 NDERTIM I SHESHIT REKREATIV SHTERMEN, BASHKIA CERRIK

FAZA E PROJEKTIT : PROJEKT ZBATIMI

EMERTESA E FLETES  
 PLANIMETRIA PERGJITHSHME

SHKALLA Shk: 1/500

FLETA 02

GRUPI I PROJEKTIMIT:

Inxh. Ndert. Lorenc HOXHA  
 Inxh. Ndert. Flutura Duro

Dt 10/09/2024

FORMATI A3

# Planimetria e Ndricimit SH 1:500



BASHKIA CERRIK



**ZetaKonsult sh.p.k**

Address:Rr."Myrteza Topi",Nd 18, Hyrja 7, Ap 38, TIRANE

Cel:+355 (0)69 33 52 077

e-mail:zetakonsultshpk@gmail.com



**EMERTIMI I OBJEKTIT:**  
 NDERTIM I SHESHIT REKREATIV SHTERMEN,BASHKIA  
 CERRIK

FAZA E PROJEKTIT :PROJEKT ZBATIMI

EMERTESA E FLETES  
 PLANIMETRIA NDRICIMIT

SHKALLA Shk:1/500

FLETA 03

GRUPI I PROJEKTIMIT:

Inxh. Ndert.Lorenc HOXHA  
 Inxh.Ndert.Flutura Duro

Dt10/09/2024

FORMATI A3

# Planimetria e Kullimit SH 1:500

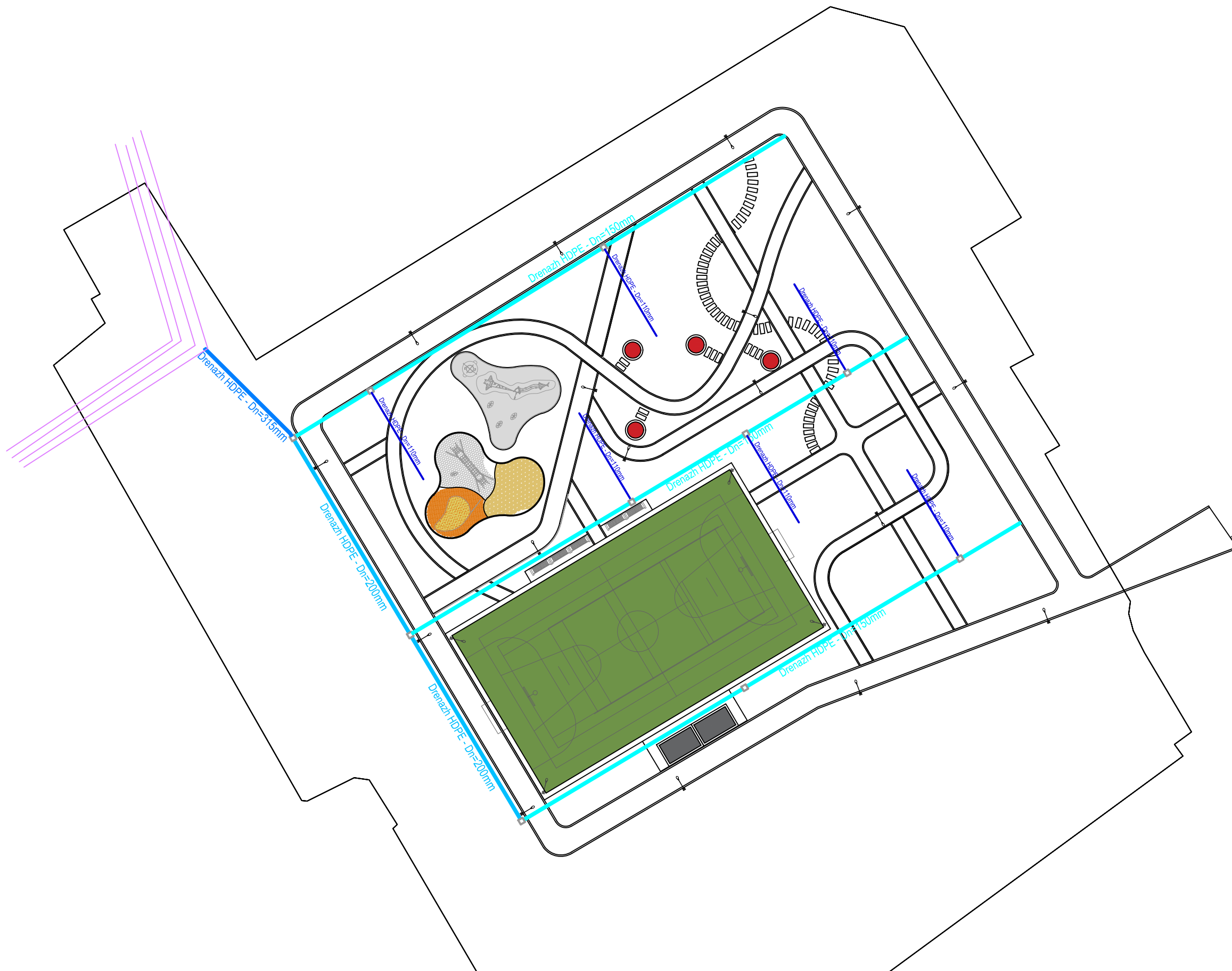

BASHKIA CERRIK



**ZetaKonsult sh.p.k**

Address:Rr."Myrteza Topi",Nd 18, Hyrja 7, Ap 38, TIRANE  
 Cel:+355 (0)69 33 52 077  
 e-mail:zetakonsultshpk@gmail.com



**EMERTIMI I OBJEKTIT:**  
 NDERTIM I SHESHIT REKREATIV SHTERMEN, BASHKIA CERRIK

FAZA E PROJEKTIT :PROJEKT ZBATIMI

EMERTESA E FLETES  
 PLANIMETRIA KULLIMIT

SHKALLA Shk:1/500

FLETA 04

GRUPI I PROJEKTIMIT:



Inxh. Ndert.Lorenc HOXHA  
 Inxh.Ndert.Flutura Duro

Dt10/09/2024

FORMATI A3

# Planimetria e Volumeve SH 1:500



<b>BASHKIA CERRIK</b>  <b>ZetaKonsult sh.p.k</b> Address:Rr."Myrteza Topi",Nd 18, Hyrja 7, Ap 38, TIRANE Cel:+355 (0)69 33 52 077 e-mail:zetakonsultshpk@gmail.com 	<b>EMERTIMI I OBJEKTIT:</b> NDERTIM I SHESHIT REKREATIV SHTERMEN,BASHKIA CERRIK		EMERTESA E FLETES PLANIMETRIA VOLUMEVE		<b>GRUPI I PROJEKTIMIT:</b> Inxh. Ndert.Lorenc HOXHA Inxh.Ndert.Flutura Duro		Dt10/09/2024
	FAZA E PROJEKTIT :PROJEKT ZBATIMI	SHKALLA Shk:1/500	FLETA 05	FORMATI A3			

# Profilet Tip SH 1:200

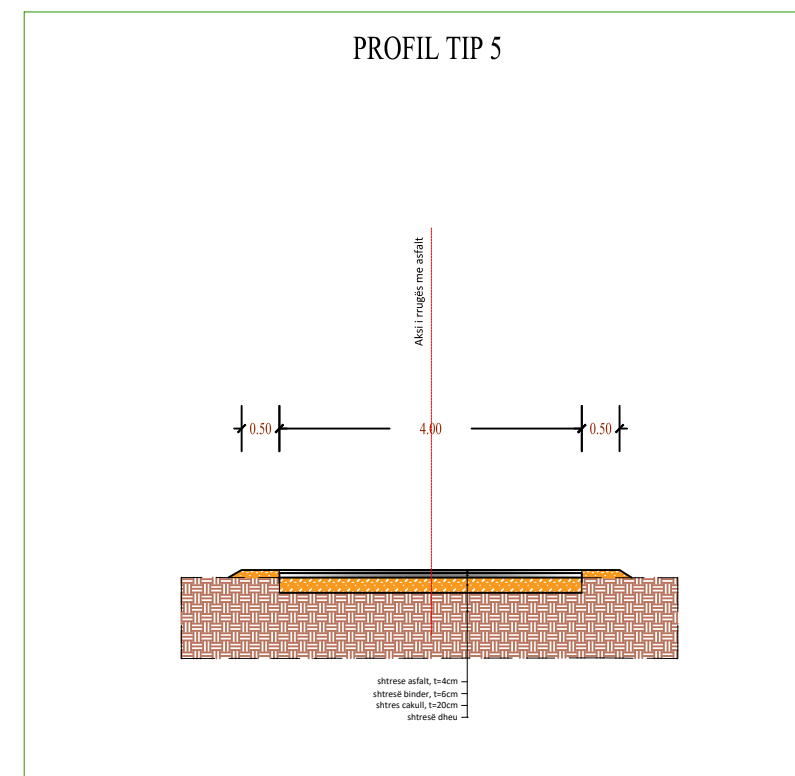
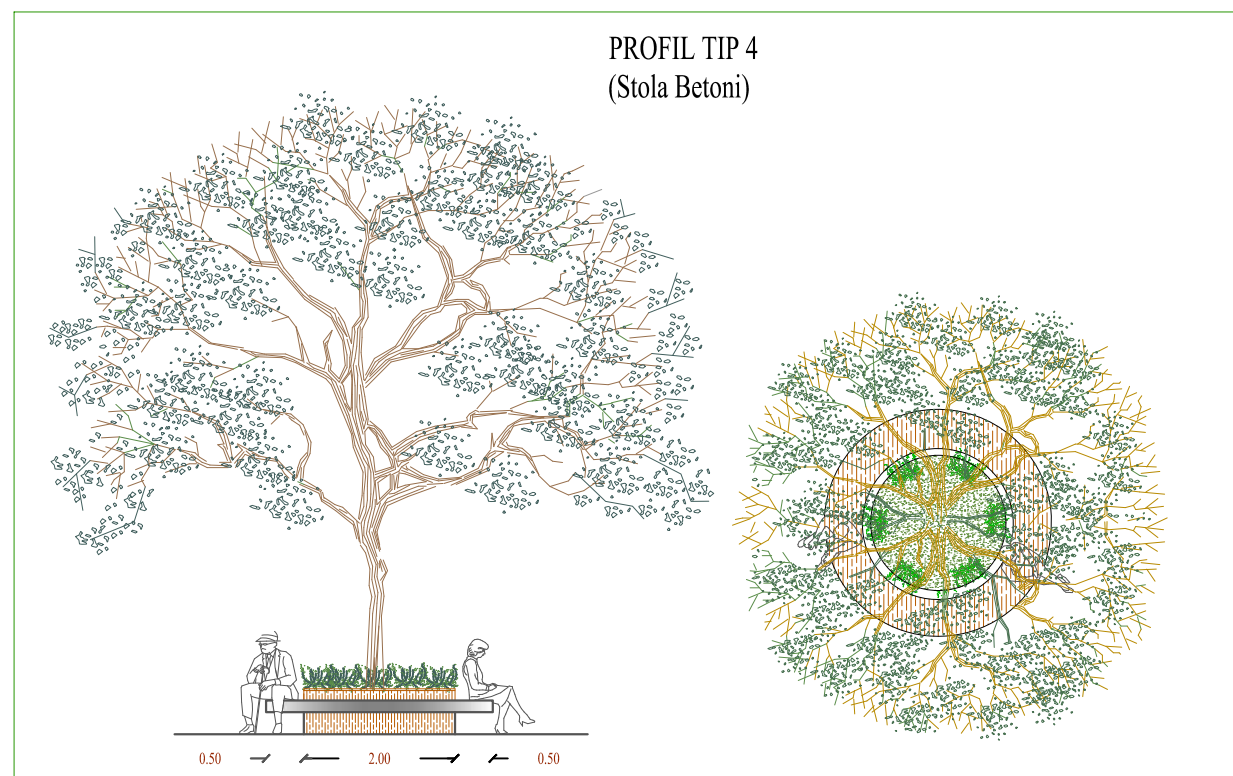
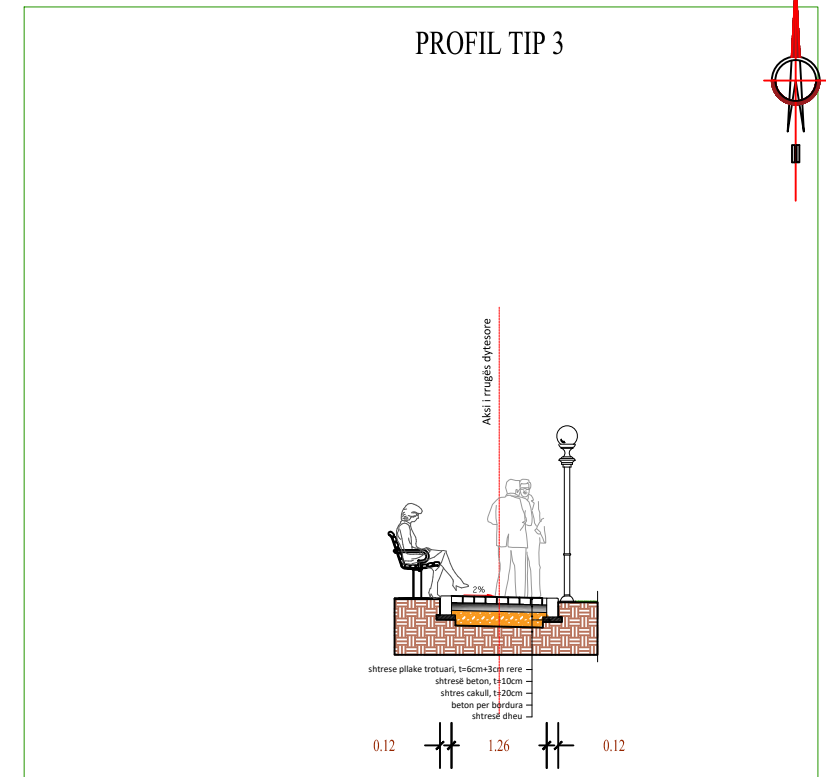
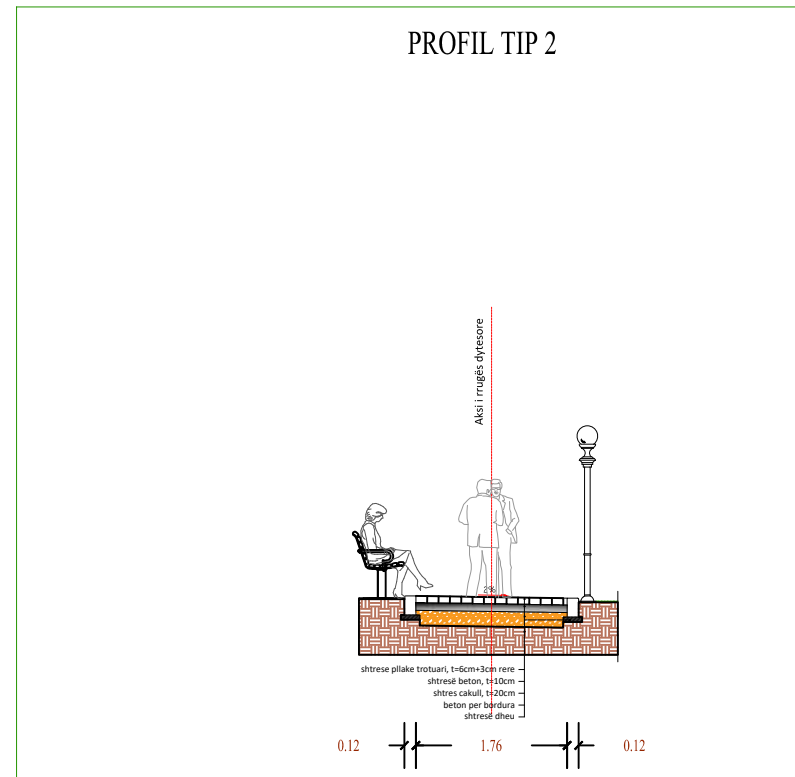
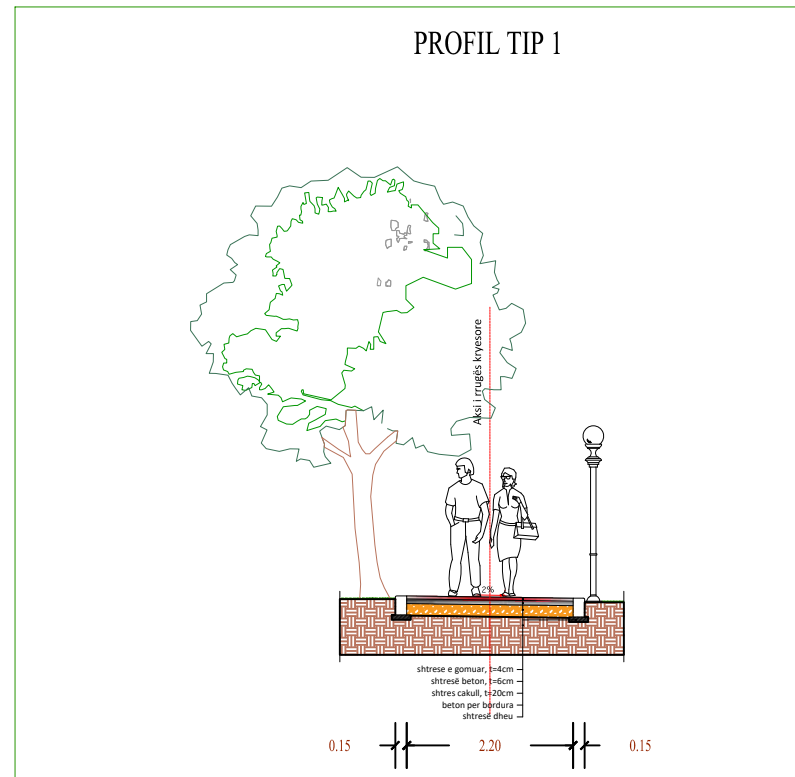

BASHKIA CERRIK



**ZetaKonsult sh.p.k**

Address:Rr."Myrteza Topi",Nd 18, Hyrja 7, Ap 38, TIRANE

Cel:+355 (0)69 33 52 077

e-mail:zetakonsultshpk@gmail.com



**EMERTIMI I OBJEKTIT:**

NDERTIM I SHESHIT REKREATIV SHTERMEN, BASHKIA CERRIK

FAZA E PROJEKTIT :PROJEKT ZBATIMI

EMERTESA E FLETES  
PROFILET TIP

SHKALLA Shk:1/200

FLETA 06

GRUPI I PROJEKTIMIT:

Inxh. Ndert.Lorenc HOXHA  
Inxh.Ndert.Flutura Duro

Dt10/09/2024

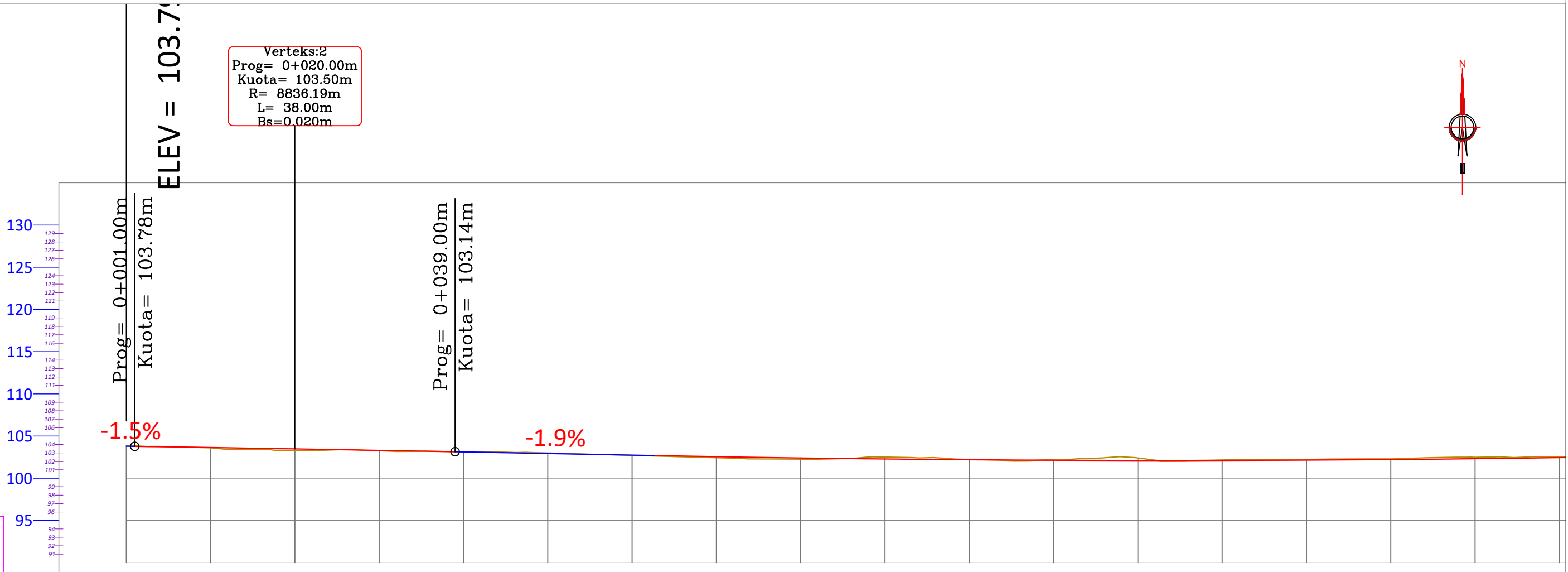

FORMATI A3

# Profil Gjatesor SH 1:500



PROFILI GJATESOR  
Aks Pedonale Kryesore  
SH\_H - 1:1000  
SH\_V - 1:1000

NR I PRERJES	PK - 1	PK - 2	PK - 3	PK - 4	PK - 5	PK - 6	PK - 7	PK - 8	PK - 9	PK - 10	PK - 11	PK - 12	PK - 13	PK - 14	PK - 15	PK - 16	PK - 17	PK - 18		
DIST. PJESORE	10.0 m	10.0 m	10.0 m	10.0 m	10.0 m	10.0 m	10.0 m	10.0 m	10.0 m	10.0 m	10.0 m	10.0 m	10.0 m	10.0 m	10.0 m	10.0 m	10.0 m	10.0 m		
DIST. PROGRESIVE	0+000	0+010	0+020	0+030	0+040	0+050	0+060	0+070	0+080	0+090	0+100	0+110	0+120	0+130	0+140	0+150	0+160	0+170		
KUOTA TOKES	103.91	103.60	103.28	103.27	103.14	102.99	102.71	102.43	102.27	102.51	102.23	102.17	102.40	102.17	102.23	102.30	102.49	102.52		
KUOTA PROJEKTIT	103.80	103.64	103.48	103.30	103.12	102.93	102.74	102.55	102.40	102.28	102.19	102.13	102.11	102.11	102.15	102.21	102.31	102.44		
KUOTA PUNES	0.11	-0.04	-0.20	-0.03	0.02	0.07	-0.03	-0.13	-0.14	0.23	0.04	0.04	0.29	0.06	0.08	0.08	0.18	0.08		
GJEO. HORIZONTALE	L=9.52		φ = 4°27'32" L = 12.69 R = 163.11		L=13.17		φ = 9°35'46" L = 17.51 R = 104.58		L=19.70			φ = 80°11'37" L = 1.27 R = 0.91		L=48.21		φ = 85°36'08" L = 1.22 R = 0.82		L=54.86		
GJEO. VERTIKALE	i = -1.48%		R = 8836.19 K = 38.00		L = 23.80 i = -1.91%					R = 3189.52 K = 114.03										
KILOMETRAZHI	0.01		0.04		0.06		0.08		0.10		0.12		0.14		0.16					

 <p><b>BASHKIA CERRIK</b></p>	<p><b>ZetaKonsult sh.p.k</b></p> <p>Address:Rr."Myrteza Topi",Nd 18, Hyrja 7, Ap 38, TIRANE</p> <p>Cel:+355 (0)69 33 52 077</p> <p>e-mail:zetakonsultshpk@gmail.com</p> 	<p><b>EMERTIMI I OBJEKTIT:</b></p> <p>NDERTIM I SHESHIT REKREATIV SHTERMEN,BASHKIA CERRIK</p>		<p>EMERTESA E FLETES</p> <p>PROFIL GJATESOR(pedonale kryesore)</p>		<p>GRUPI I PROJEKTIMIT:</p> <p>Inxh. Ndert.Lorenc HOXHA Inxh.Ndert.Flutura Duro</p>		<p>Dt10/09/2024</p>
		<p>FAZA E PROJEKTIT :PROJEKT ZBATIMI</p>		<p>SHKALLA Shk:1/500</p>	<p>FLETA 07</p>	<p>FORMATI A3</p>		



# Profil Gjatesor SH 1:500

ELEV = 103.50

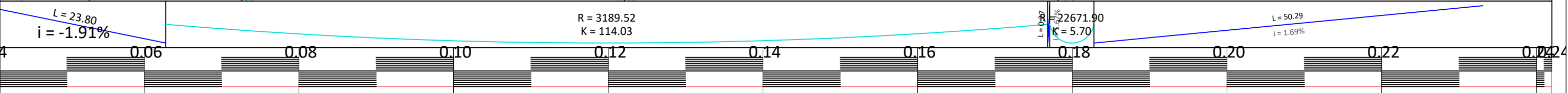
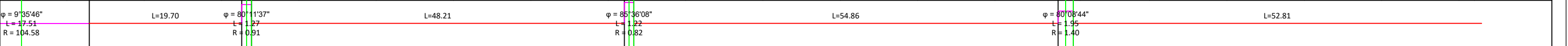
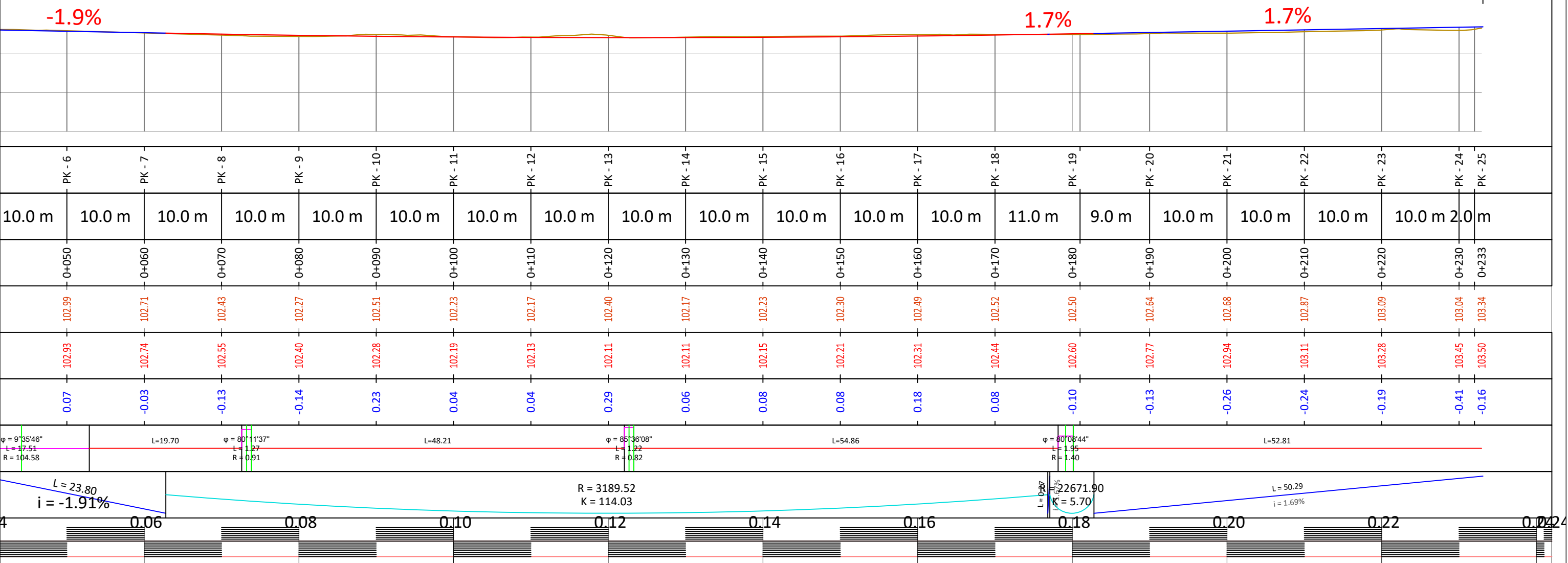

 <p><b>BASHKIA CERRIK</b></p>	<p><b>ZetaKonsult sh.p.k</b></p> <p>Address:Rr."Myrteza Topi",Nd 18, Hyrja 7, Ap 38, TIRANE</p> <p>Cel:+355 (0)69 33 52 077</p> <p>e-mail:zetakonsultshpk@gmail.com</p> 	<p><b>EMERTIMI I OBJEKTIT:</b></p> <p>NDERTIM I SHESHIT REKREATIV SHTERMEN,BASHKIA CERRIK</p>		<p>EMERTESA E FLETES</p> <p>PROFIL GJATESOR(pedonale kryesore)</p>		<p><b>GRUPI I PROJEKTIMIT:</b></p> <p>Inxh. Ndert.Lorenc HOXHA</p> <p>Inxh.Ndert.Flutura Duro</p>		<p>Dt10/09/2024</p>
		<p>FAZA E PROJEKTIT :PROJEKT ZBATIMI</p>		<p>SHKALLA Shk:1/500</p>	<p>FLETA 08</p>	<p>FORMATI A3</p>		

# Profilet Terthore SH 1:250

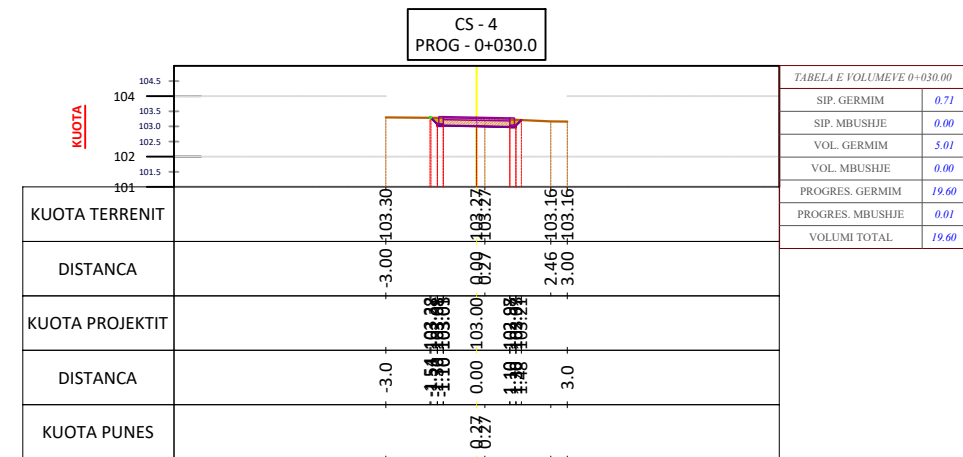
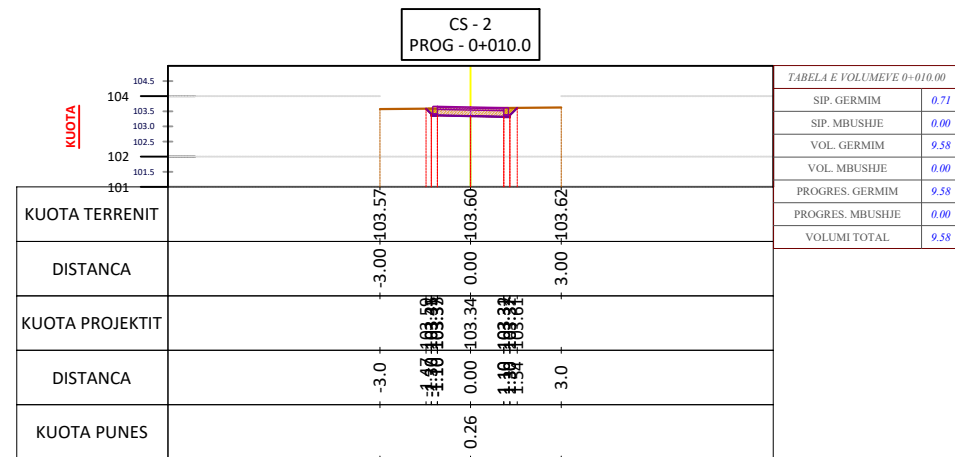
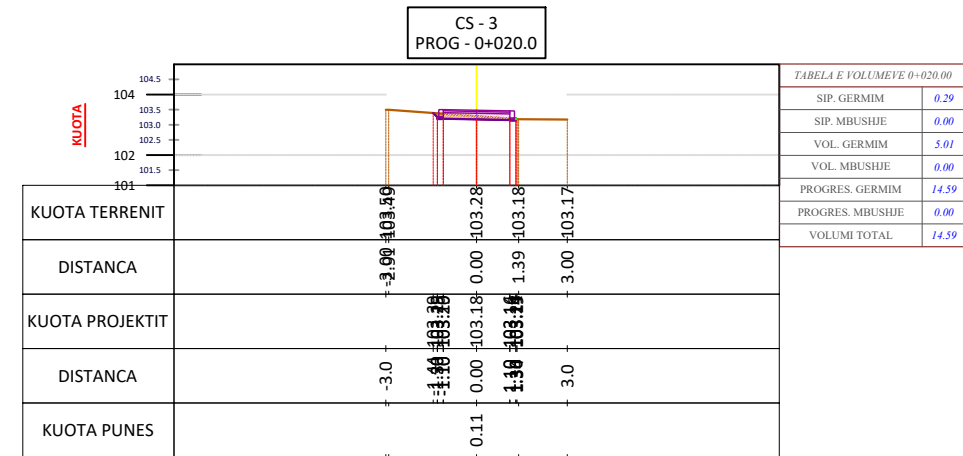
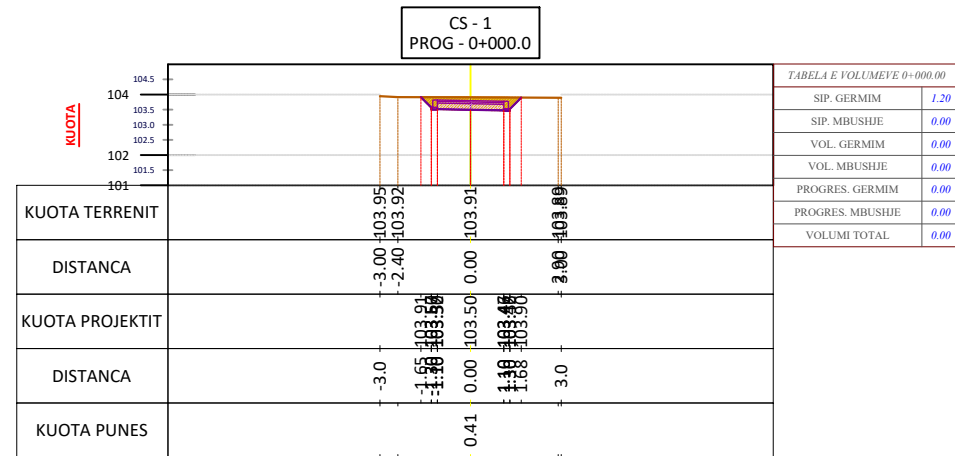

BASHKIA CERRIK



**ZetaKonsult sh.p.k**

Address: Rr. "Myrteza Topi", Nd 18, Hyrja 7, Ap 38, TIRANE

Cel: +355 (0)69 33 52 077

e-mail: zetakonsultshpk@gmail.com



**EMERTIMI I OBJEKTIT:**

NDERTIM I SHESHIT REKREATIV SHTERMEN, BASHKIA CERRIK

FAZA E PROJEKTIT : PROJEKT ZBATIMI

**EMERTESA E FLETES**  
PROFLET TERTHORE (pedonale kryesore)

SHKALLA Shk: 1/250

FLETA 09

**GRUPI I PROJEKTIMIT:**

Inxh. Ndert. Lorenc HOXHA  
Inxh. Ndert. Flutura Duro

Dt 10/09/2024

FORMATI A3

# Profilet Terthore SH 1:250

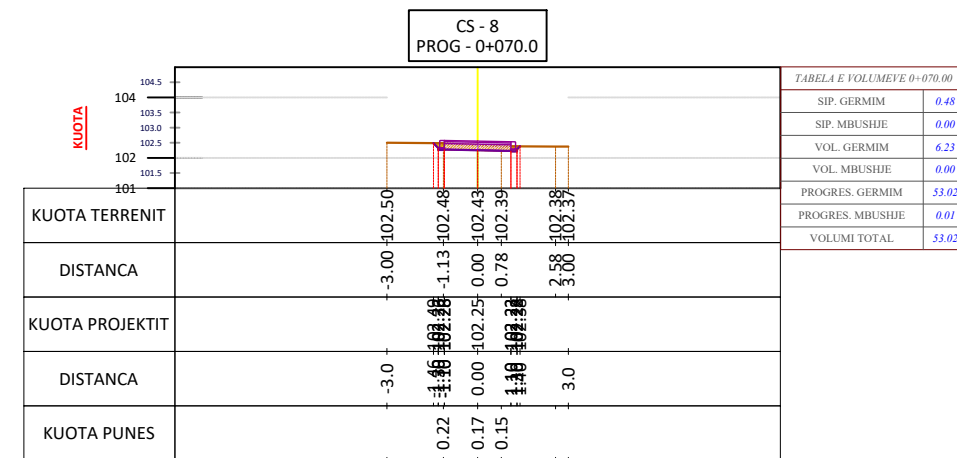
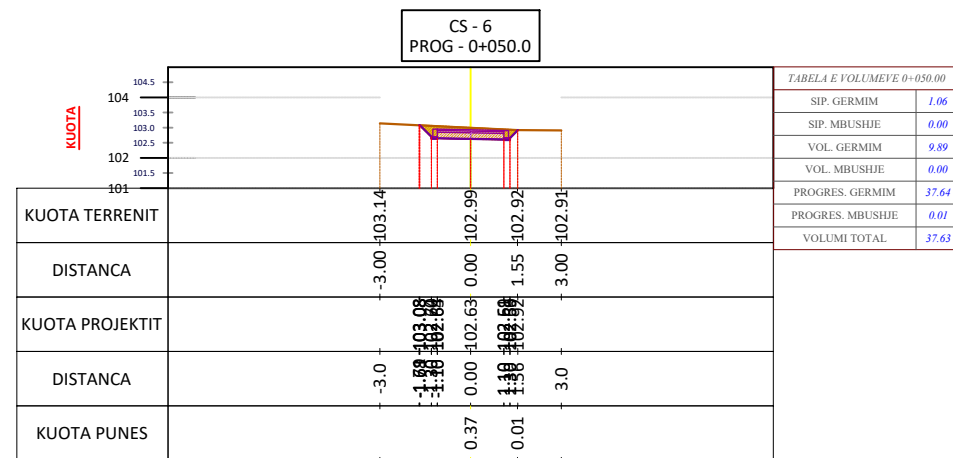
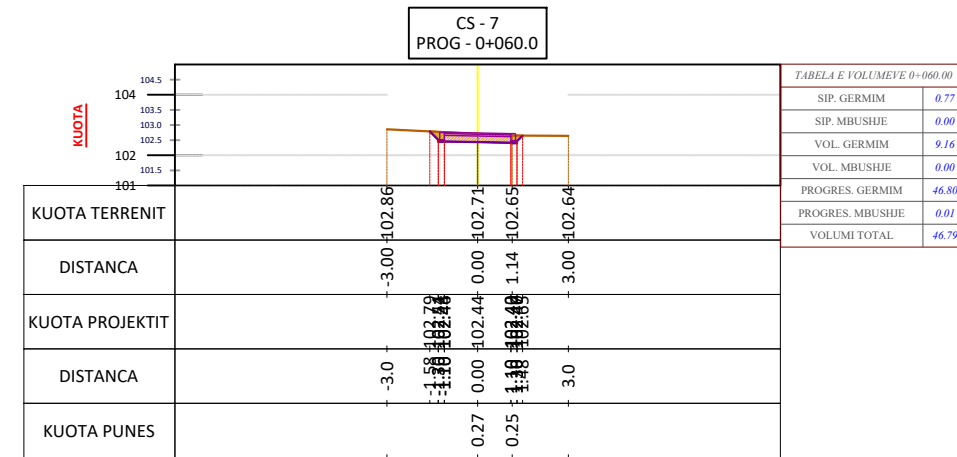
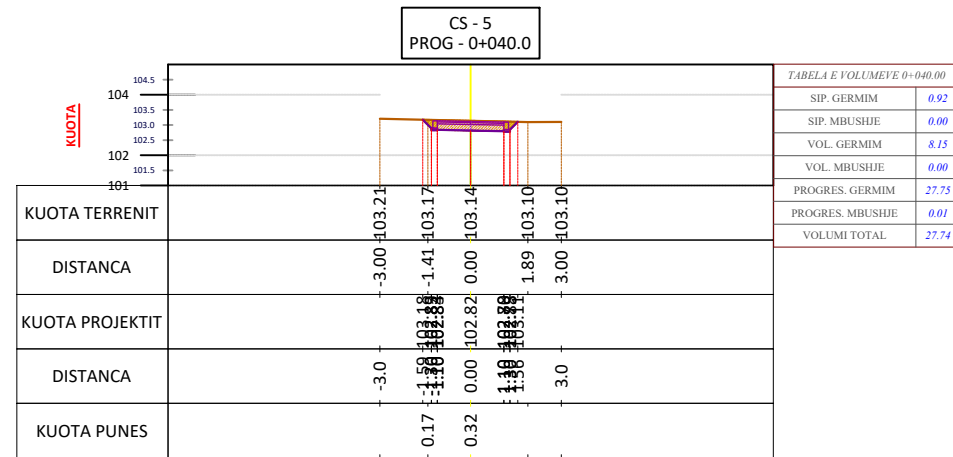

# Profilet Terthore SH 1:250

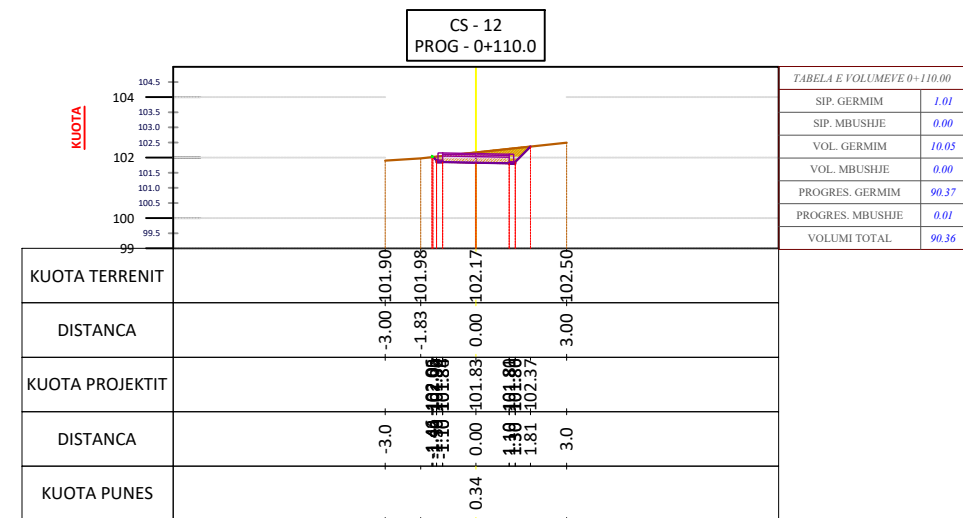
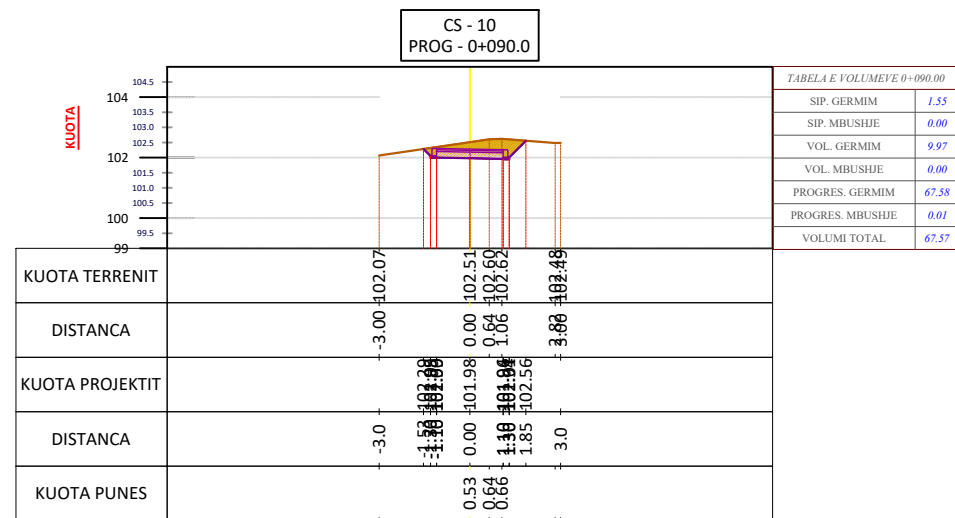
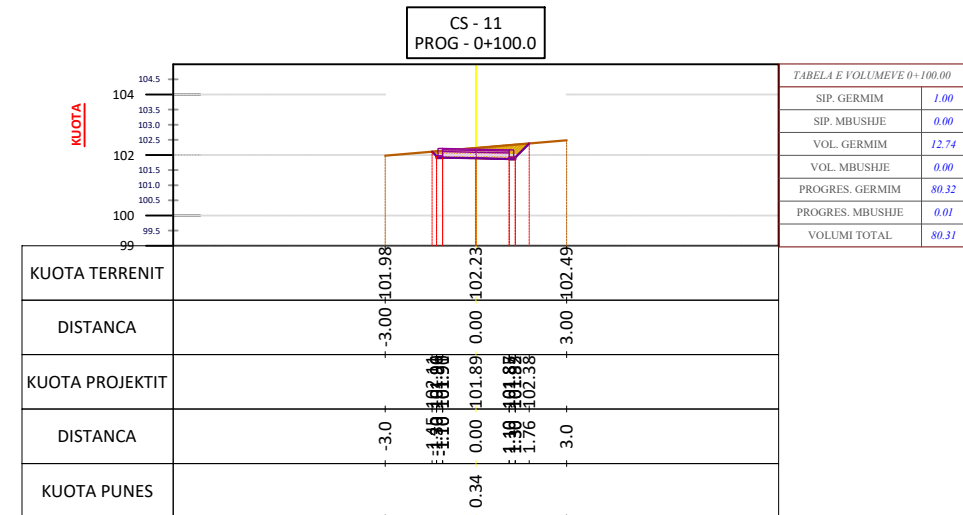
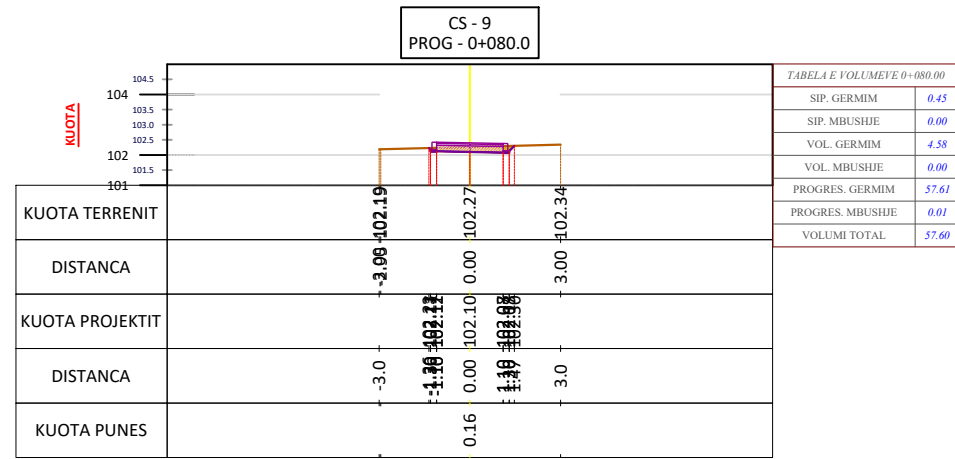

BASHKIA CERRIK



**ZetaKonsult sh.p.k**

Address: Rr. "Myrteza Topi", Nd 18, Hyrja 7, Ap 38, TIRANE

Cel: +355 (0)69 33 52 077

e-mail: zetakonsultshpk@gmail.com



**EMERTIMI I OBJEKTIT:**

NDERTIM I SHESHIT REKREATIV SHTERMEN, BASHKIA CERRIK

FAZA E PROJEKTIT : PROJEKT ZBATIMI

EMERTESA E FLETES  
PROFLET TERTHORE (pedonale kryesore)

SHKALLA Shk: 1/250

FLETA 11

**GRUPI I PROJEKTIMIT:**

Inxh. Ndert. Lorenc HOXHA  
Inxh. Ndert. Flutura Duro

Dt 10/09/2024

FORMATI A3

# Profilet Terthore SH 1:250

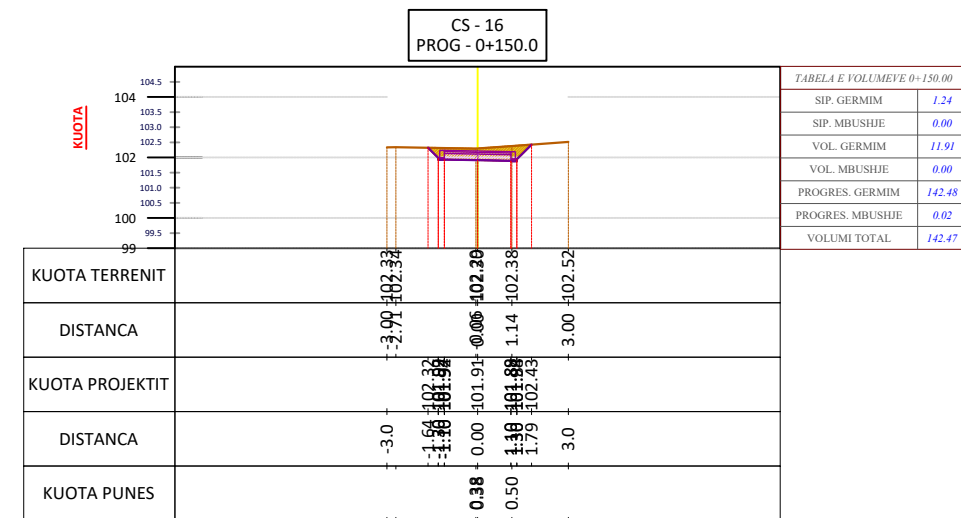
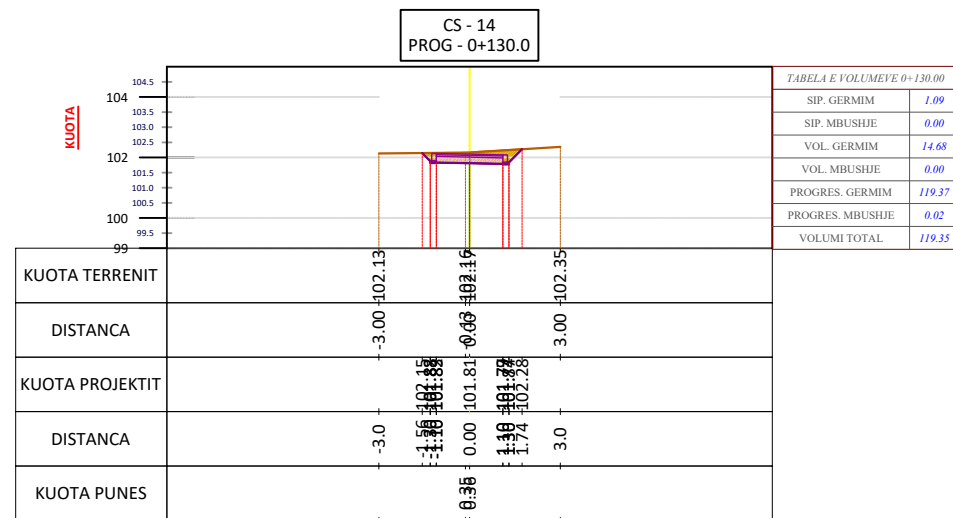
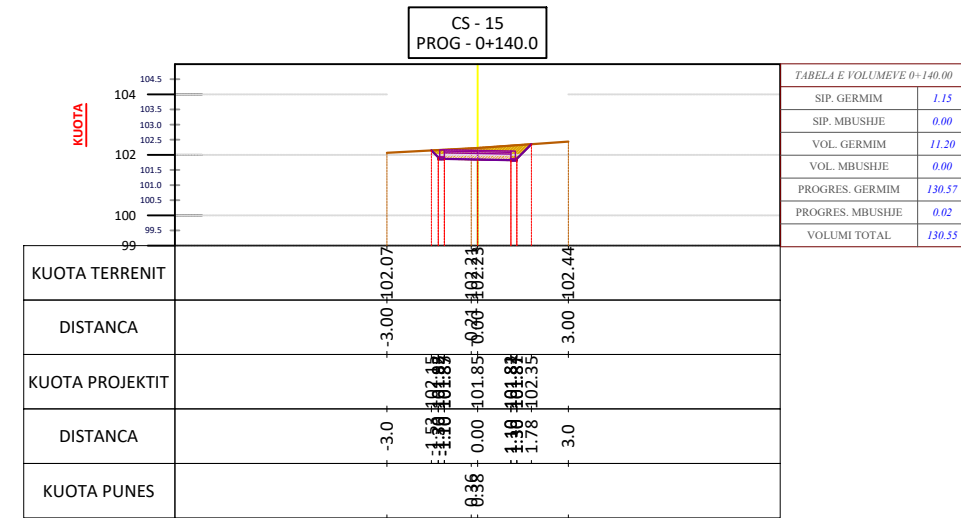
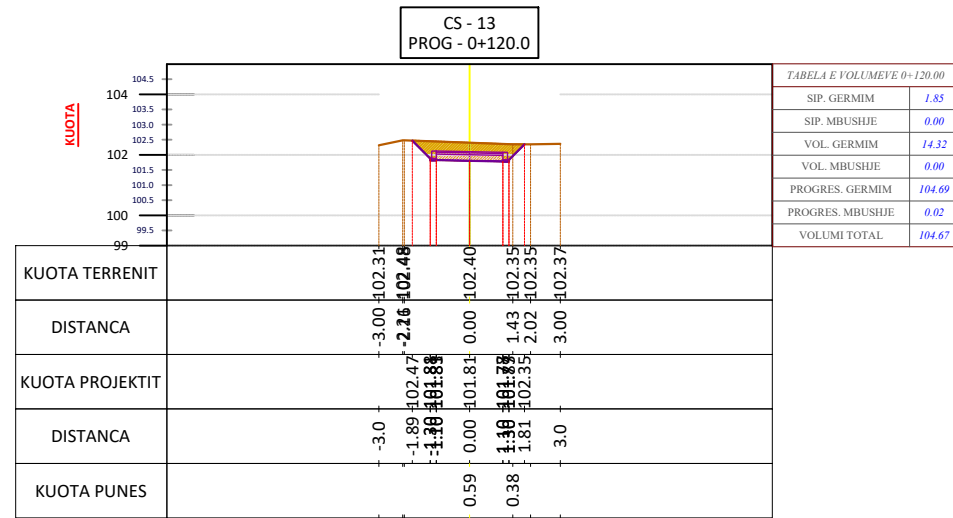

# Profilet Terthore SH 1:250

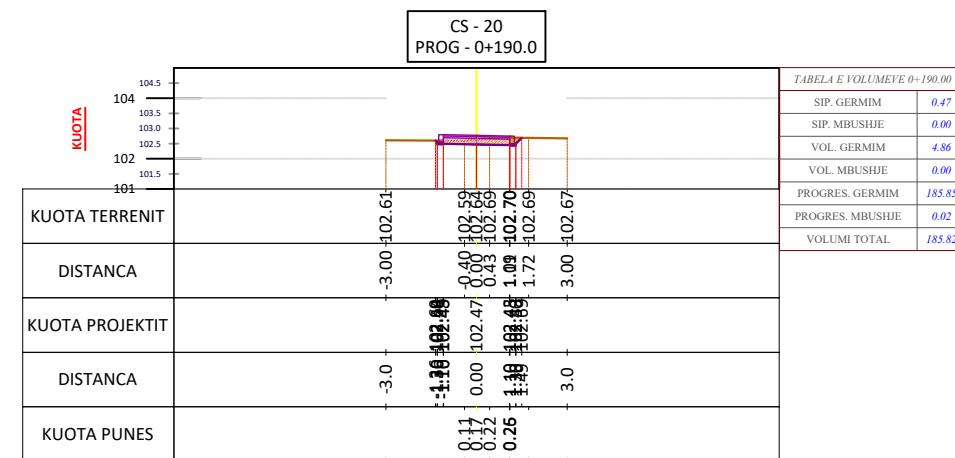
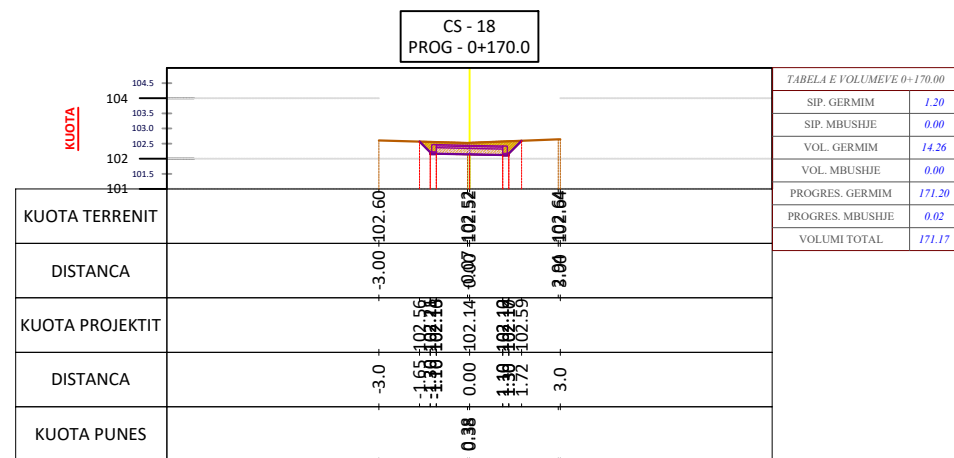
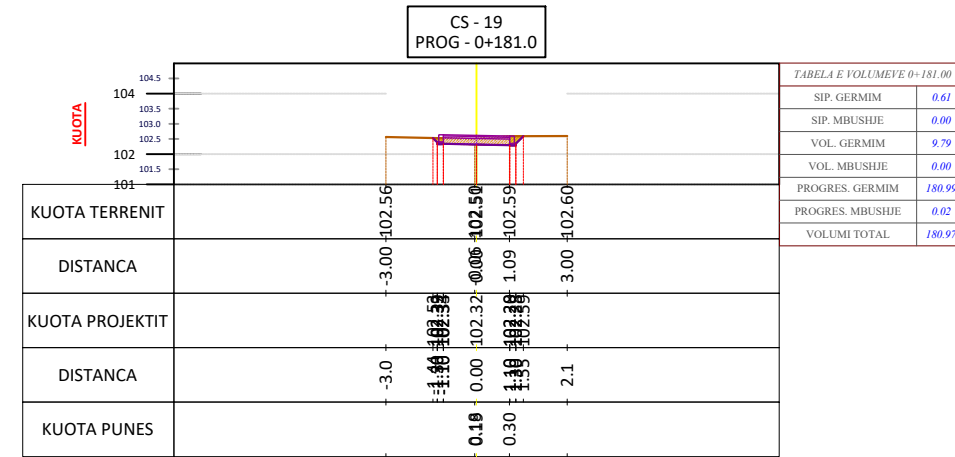
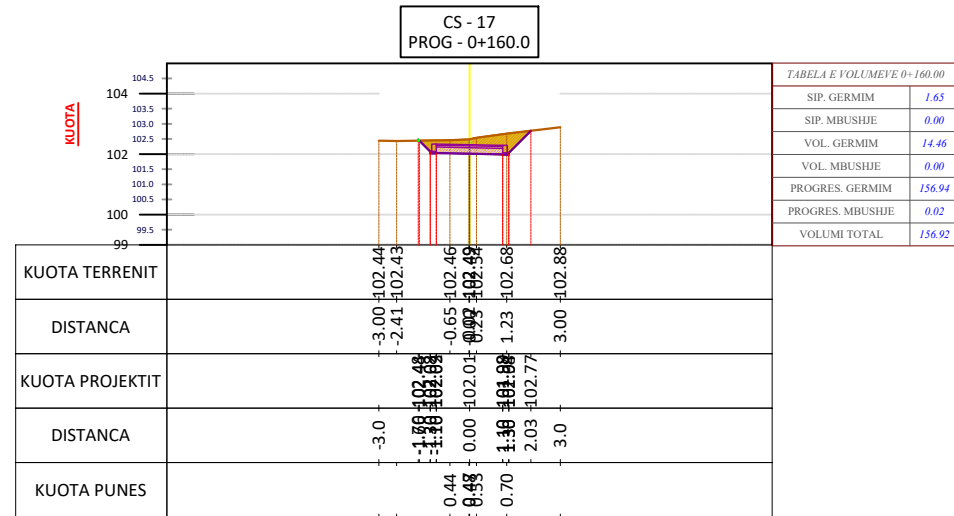

BASHKIA CERRIK



**ZetaKonsult sh.p.k**

Address: Rr. "Myrteza Topi", Nd 18, Hyrja 7, Ap 38, TIRANE

Cel: +355 (0)69 33 52 077

e-mail: zetakonsultshpk@gmail.com



**EMERTIMI I OBJEKTIT:**  
NDERTIM I SHESHIT REKREATIV SHTERMEN, BASHKIA CERRIK

FAZA E PROJEKTIT : PROJEKT ZBATIMI

EMERTESA E FLETES  
PROFLET TERTHORE (pedonale kryesore)

SHKALLA Shk: 1/250

FLETA 13

GRUPI I PROJEKTIMIT:

Inxh. Ndert. Lorenc HOXHA  
Inxh. Ndert. Flutura Duro

Dt 10/09/2024

FORMATI A3

# Profilet Terthore SH 1:250

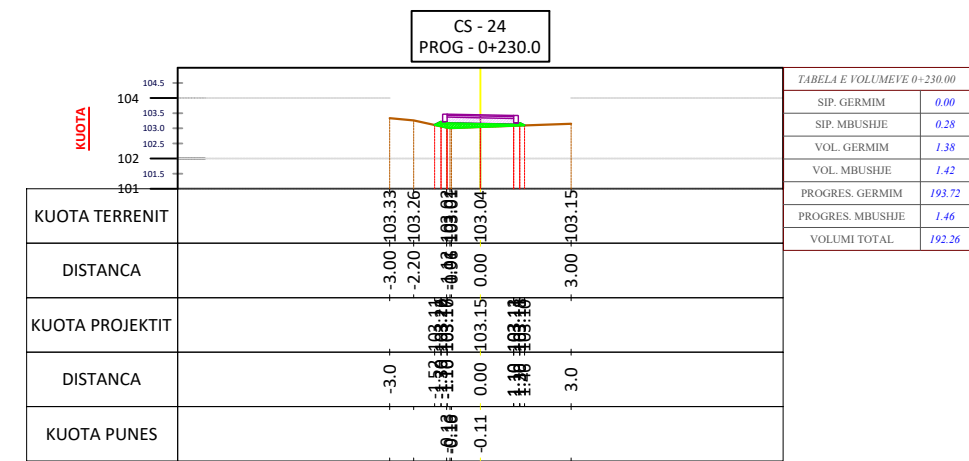
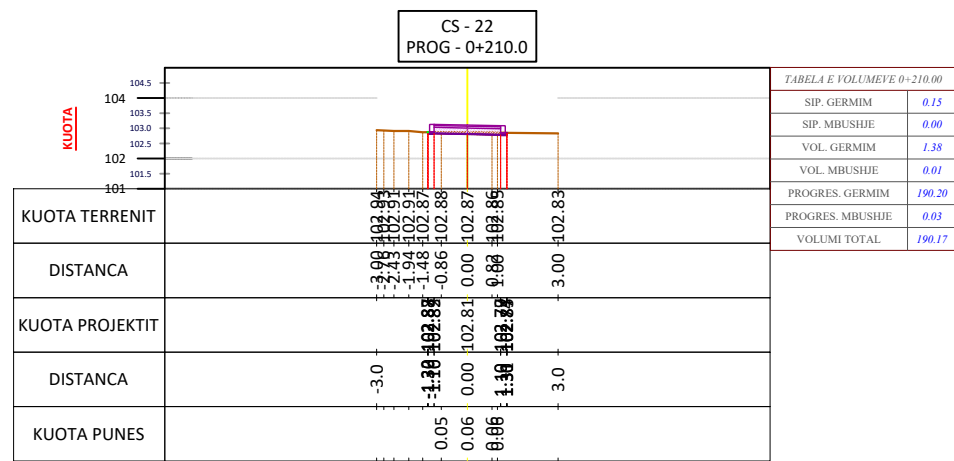
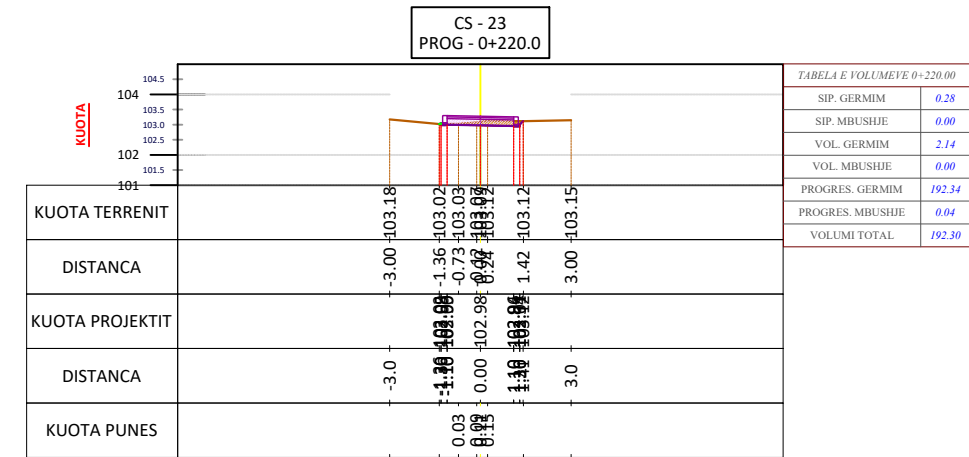
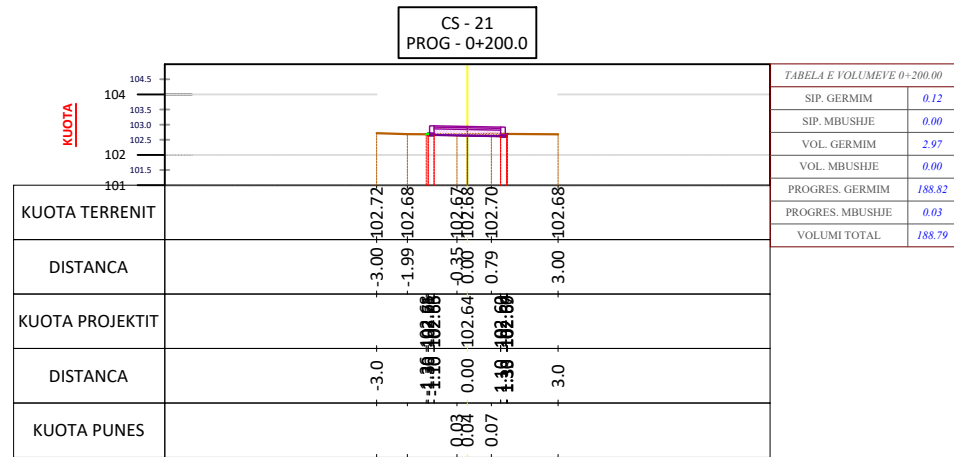

# Profillet Terthore SH 1:250

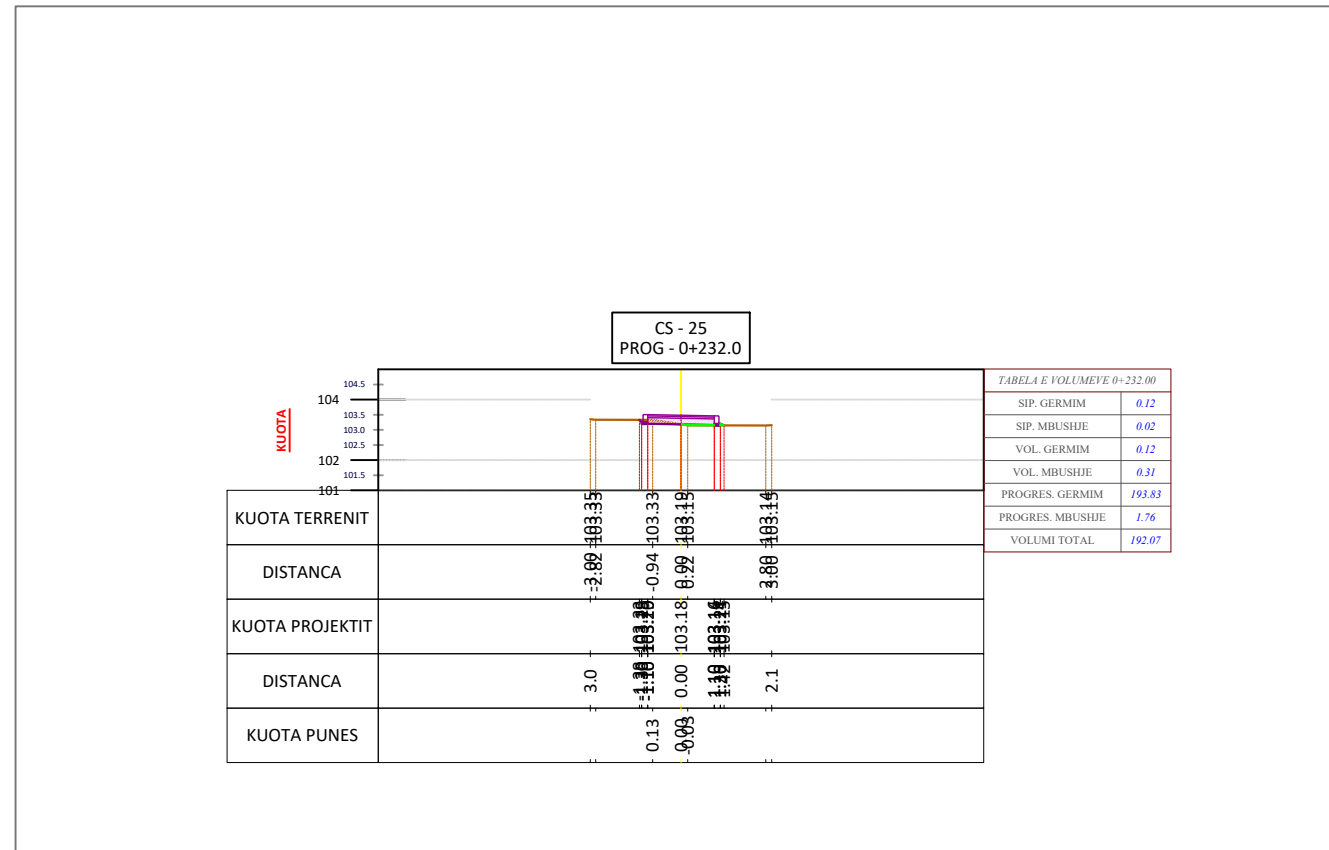



## Tabela Volumeve SH 1:250



### VOLUMET

Station	Fill Area	Cut Area	Fill Volume	Cut Volume	Cumulative Fill Vol	Cumulative Cut Vol
0+000.00	0.00	1.20	0.00	0.00	0.00	0.00
0+010.00	0.00	0.71	0.00	9.58	0.00	9.58
0+020.00	0.00	0.29	0.00	5.01	0.00	14.59
0+030.00	0.00	0.71	0.00	5.01	0.01	19.60
0+040.00	0.00	0.92	0.00	8.15	0.01	27.75
0+050.00	0.00	1.06	0.00	9.89	0.01	37.64
0+060.00	0.00	0.77	0.00	9.16	0.01	46.80
0+070.00	0.00	0.48	0.00	6.23	0.01	53.02
0+080.00	0.00	0.45	0.00	4.58	0.01	57.61
0+090.00	0.00	1.55	0.00	9.97	0.01	67.58
0+100.00	0.00	1.00	0.00	12.74	0.01	80.32
0+110.00	0.00	1.01	0.00	10.05	0.01	90.37
0+120.00	0.00	1.85	0.00	14.32	0.02	104.69
0+130.00	0.00	1.09	0.00	14.68	0.02	119.37
0+140.00	0.00	1.15	0.00	11.20	0.02	130.57
0+150.00	0.00	1.24	0.00	11.91	0.02	142.48
0+160.00	0.00	1.65	0.00	14.46	0.02	156.94
0+170.00	0.00	1.20	0.00	14.26	0.02	171.20
0+181.00	0.00	0.61	0.00	9.79	0.02	180.99
0+190.00	0.00	0.47	0.00	4.86	0.02	185.85

### VOLUMET

Station	Fill Area	Cut Area	Fill Volume	Cut Volume	Cumulative Fill Vol	Cumulative Cut Vol
0+200.00	0.00	0.12	0.00	2.97	0.03	188.82
0+210.00	0.00	0.15	0.01	1.38	0.03	190.20
0+220.00	0.00	0.28	0.00	2.14	0.04	192.34
0+230.00	0.28	0.00	1.42	1.38	1.46	193.72
0+232.00	0.02	0.12	0.31	0.12	1.76	193.83



# Profil Gjatesor SH 1:500

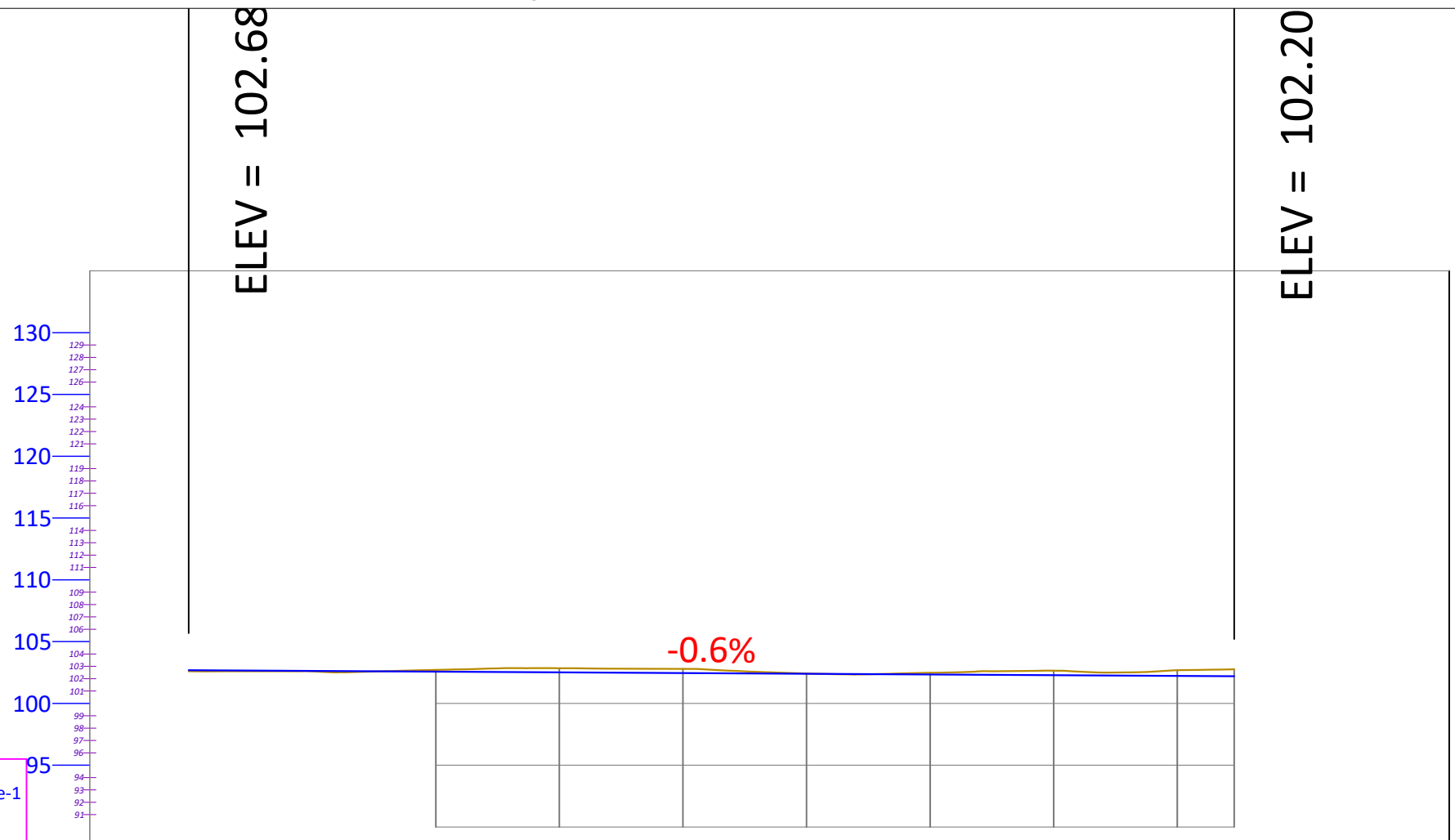

PROFILI GJATESOR  
Aks Pedonale Dytesore-1  
SH\_H - 1:1000  
SH\_V - 1:1000

NR I PRERJES	PK - 1	PK - 2	PK - 3	PK - 4	PK - 5	PK - 6	PK - 7	PK - 8	PK - 9	PK - 10
DIST. PJESORE	10.0 m	10.0 m	10.0 m	10.0 m	10.0 m	10.0 m	10.0 m	10.0 m	10.0 m	4.6 m
DIST. PROGRESIVE	0+000	0+010	0+020	0+030	0+040	0+050	0+060	0+070	0+080	0+085
KUOTA TOKES	102.59	102.59	102.71	102.84	102.79	102.42	102.47	102.65	102.68	102.76
KUOTA PROJEKTIT	102.68	102.62	102.57	102.51	102.45	102.40	102.34	102.28	102.23	102.20
KUOTA PUNES	-0.09	-0.03	0.14	0.33	0.34	0.02	0.13	0.36	0.46	0.56
GJEO. HORIZONTALE	$\varphi = 7^{\circ}45'00''$ $\varphi = 9^{\circ}21'31''$ $\varphi = 12^{\circ}37'48''$ $\varphi = 13^{\circ}00'14''$ $\varphi = 13^{\circ}01'07''$ $\varphi = 13^{\circ}20'11''$ $L = 8.36$ $\varphi = 38^{\circ}53'55''$ $\varphi = 27^{\circ}39'49''$ $\varphi = 30^{\circ}22'44''$ $\varphi = 28^{\circ}04'33''$ $\varphi = 27^{\circ}10'51''$ $\varphi = 19^{\circ}25'01''$ $\varphi = 23^{\circ}37'51''$ $L = 4.24$ $L = 6.44$ $L = 7.73$ $L = 2.85$ $L = 2.44$ $L = 3.05$ $L = 3.28$ $L = 6.12$ $L = 6.68$ $L = 6.69$ $L = 5.47$ $L = 7.24$ $L = 5.00$ $L = 7.12$ $R = 31.31$ $R = 39.45$ $R = 35.09$ $R = 16.83$ $R = 7.60$ $R = 3.73$ $R = 8.06$ $R = 9.01$ $R = 13.84$ $R = 12.52$ $R = 11.16$ $R = 15.26$ $R = 14.74$ $R = 17.26$									
GJEO. VERTIKALE	$L = 84.60$ $i = -0.57\%$									
KILOMETRAZHI	0.01	0.02	0.04	0.06	0.08	0.10	0.12	0.14	0.16	0.18



**ZetaKonsult sh.p.k**  
 Address: Rr. "Myrteza Topi", Nd 18, Hyrja 7, Ap 38, TIRANE  
 Cel: +355 (0)69 33 52 077  
 e-mail: zetakonsultshpk@gmail.com



**EMERTIMI I OBJEKTIT:**  
 NDERTIM I SHESHIT REKREATIV SHTERMEN, BASHKIA CERRIK

FAZA E PROJEKTIT : PROJEKT ZBATIMI

EMERTESA E FLETES  
 PROFIL GJATESOR (pedonale dytesore-1)

SHKALLA Shk: 1/500 FLETA 17

GRUPI I PROJEKTIMIT:  
 Inxh. Ndert. Lorenc HOXHA  
 Inxh. Ndert. Flutura Duro

Dt 10/09/2024

FORMATI A3

# Profillet Terthore SH 1:250

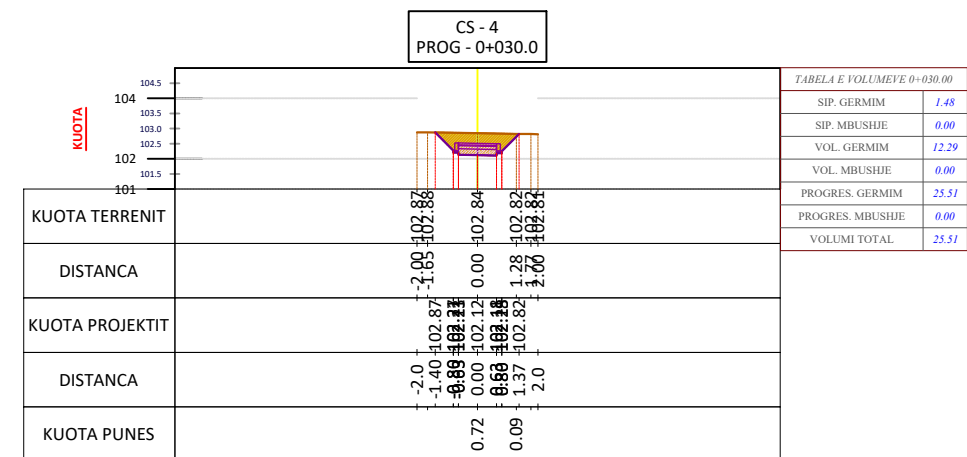
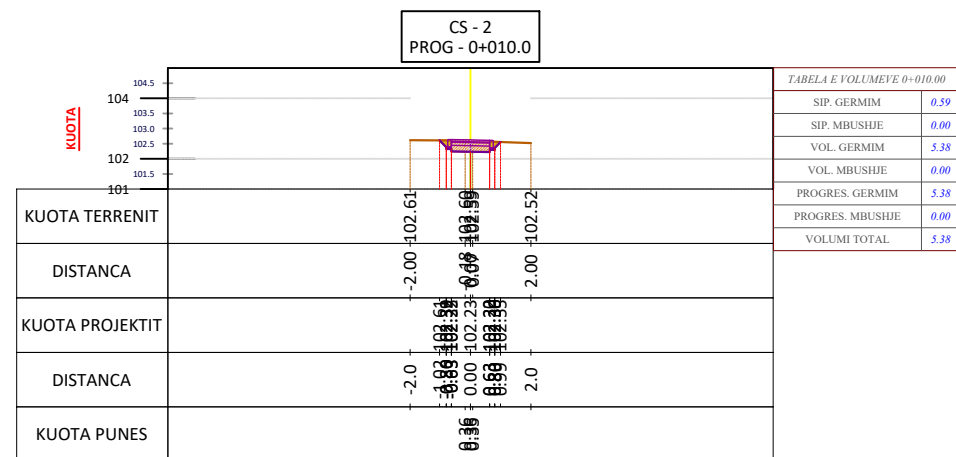
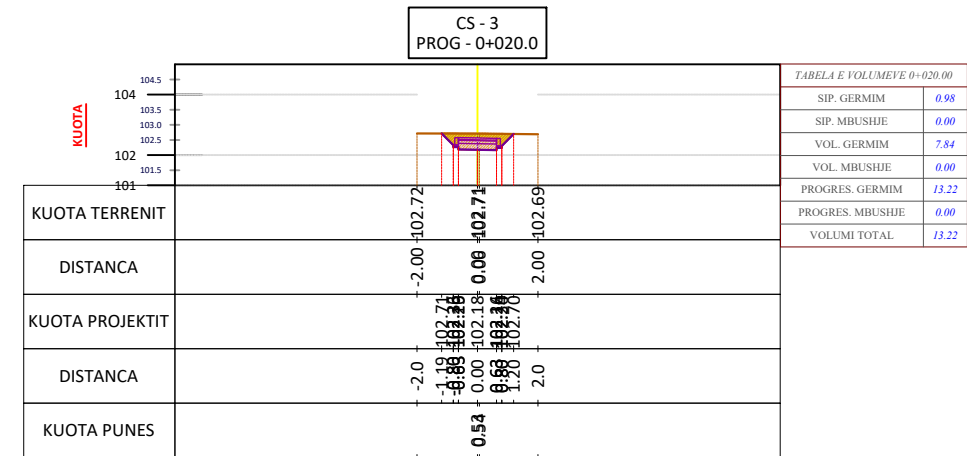
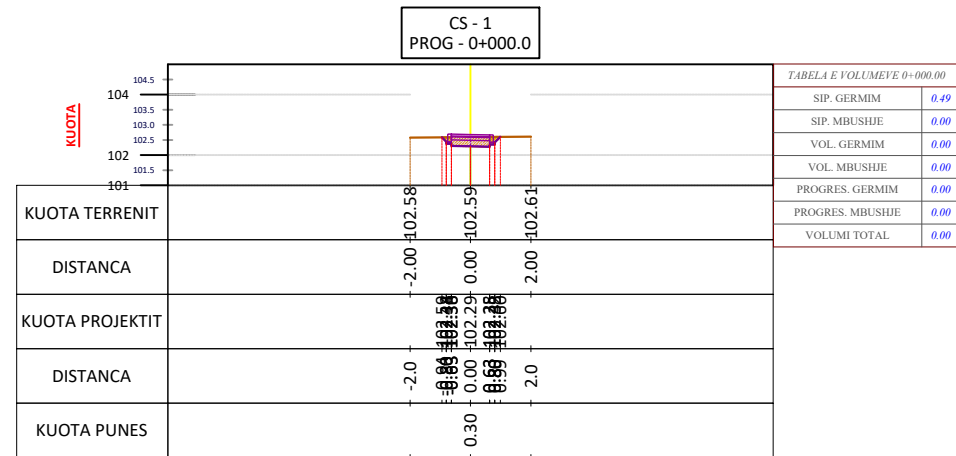

# Profillet Terthore SH 1:250

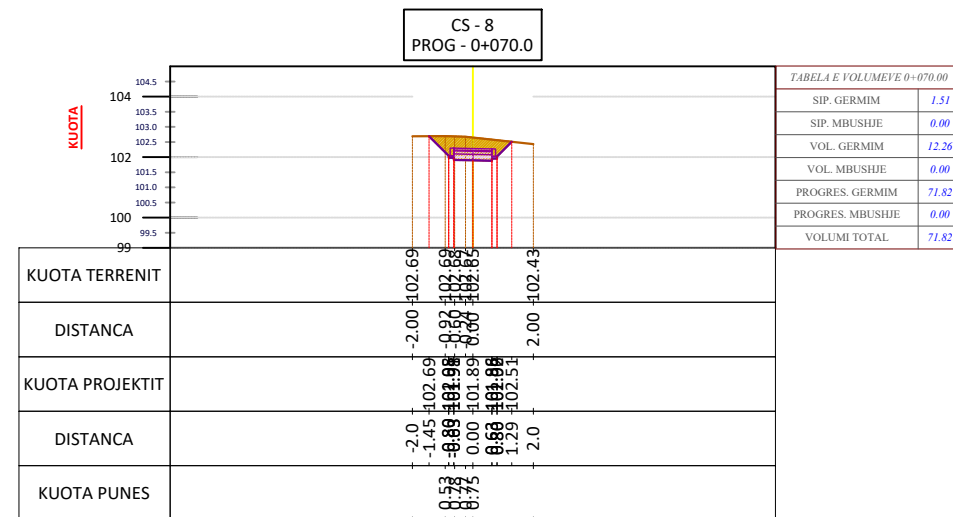
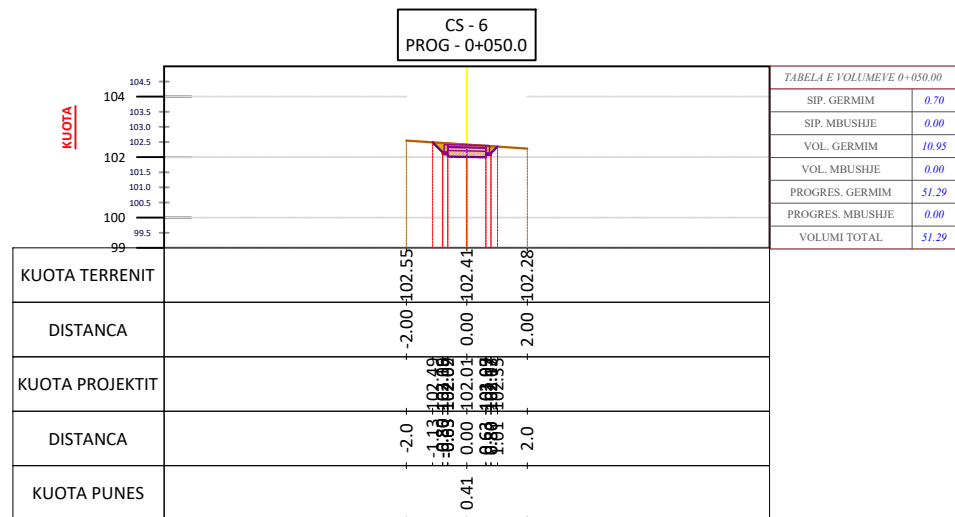
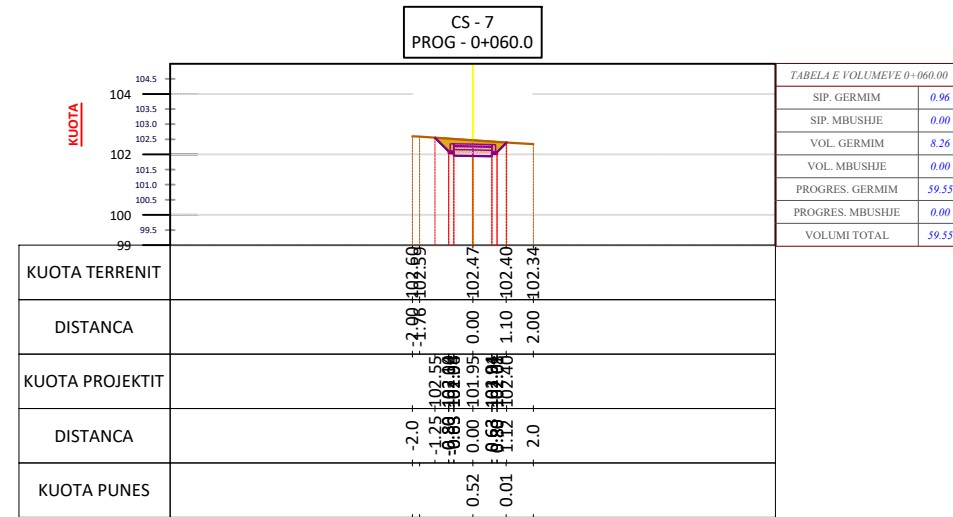
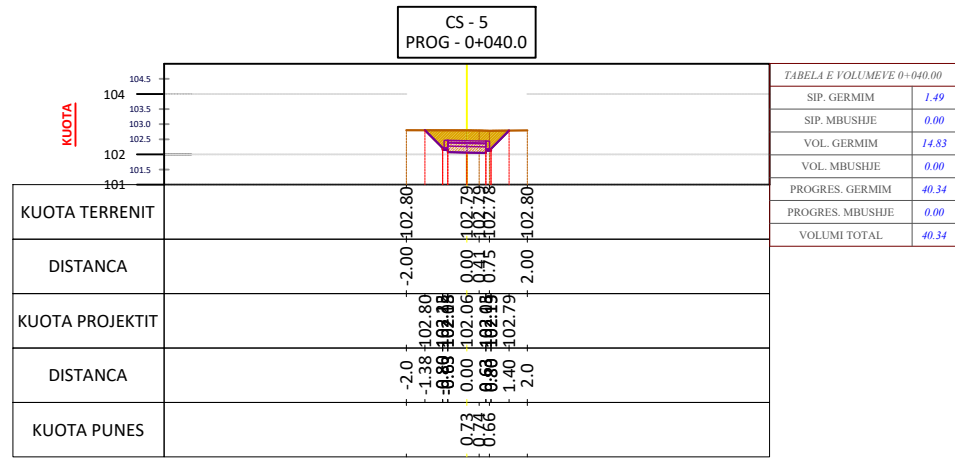

# Profillet Terthore SH 1:250

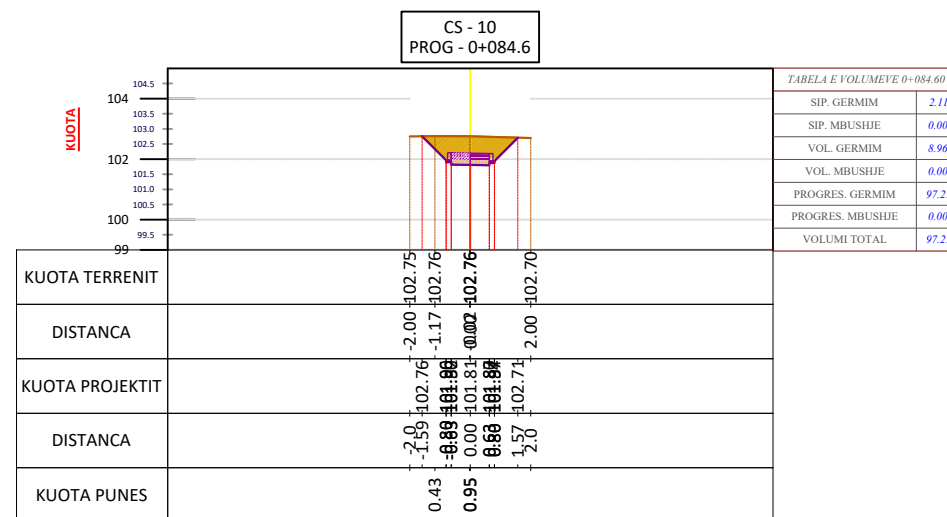
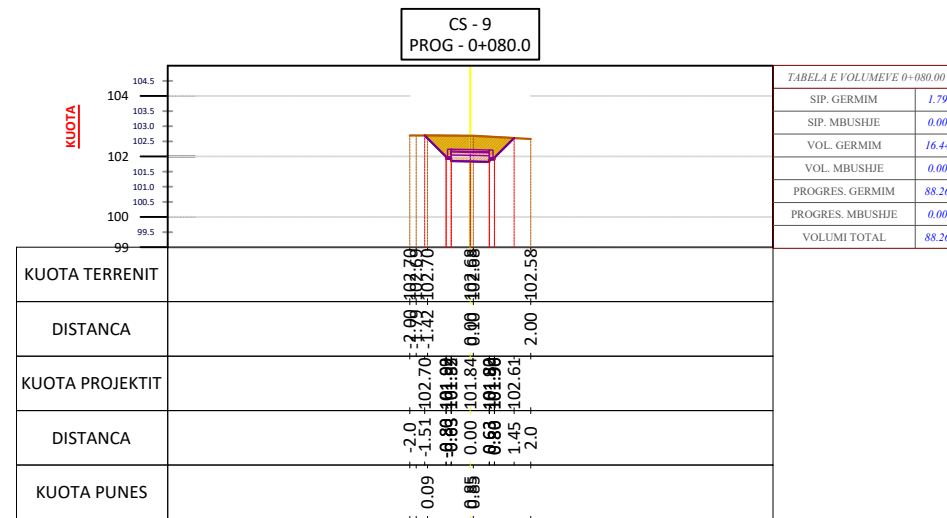

**Tabela Volumeve SH 1:250**



VOLUMET						
Station	Fill Area	Cut Area	Fill Volume	Cut Volume	Cumulative Fill Vol	Cumulative Cut Vol
0+000.00	0.00	0.49	0.00	0.00	0.00	0.00
0+010.00	0.00	0.59	0.00	5.38	0.00	5.38
0+020.00	0.00	0.98	0.00	7.84	0.00	13.22
0+030.00	0.00	1.48	0.00	12.29	0.00	25.51
0+040.00	0.00	1.49	0.00	14.83	0.00	40.34
0+050.00	0.00	0.70	0.00	10.95	0.00	51.29
0+060.00	0.00	0.96	0.00	8.26	0.00	59.55
0+070.00	0.00	1.51	0.00	12.26	0.00	71.82
0+080.00	0.00	1.79	0.00	16.44	0.00	88.26
0+084.60	0.00	2.11	0.00	8.96	0.00	97.21



# Profil Gjatesor SH 1:500

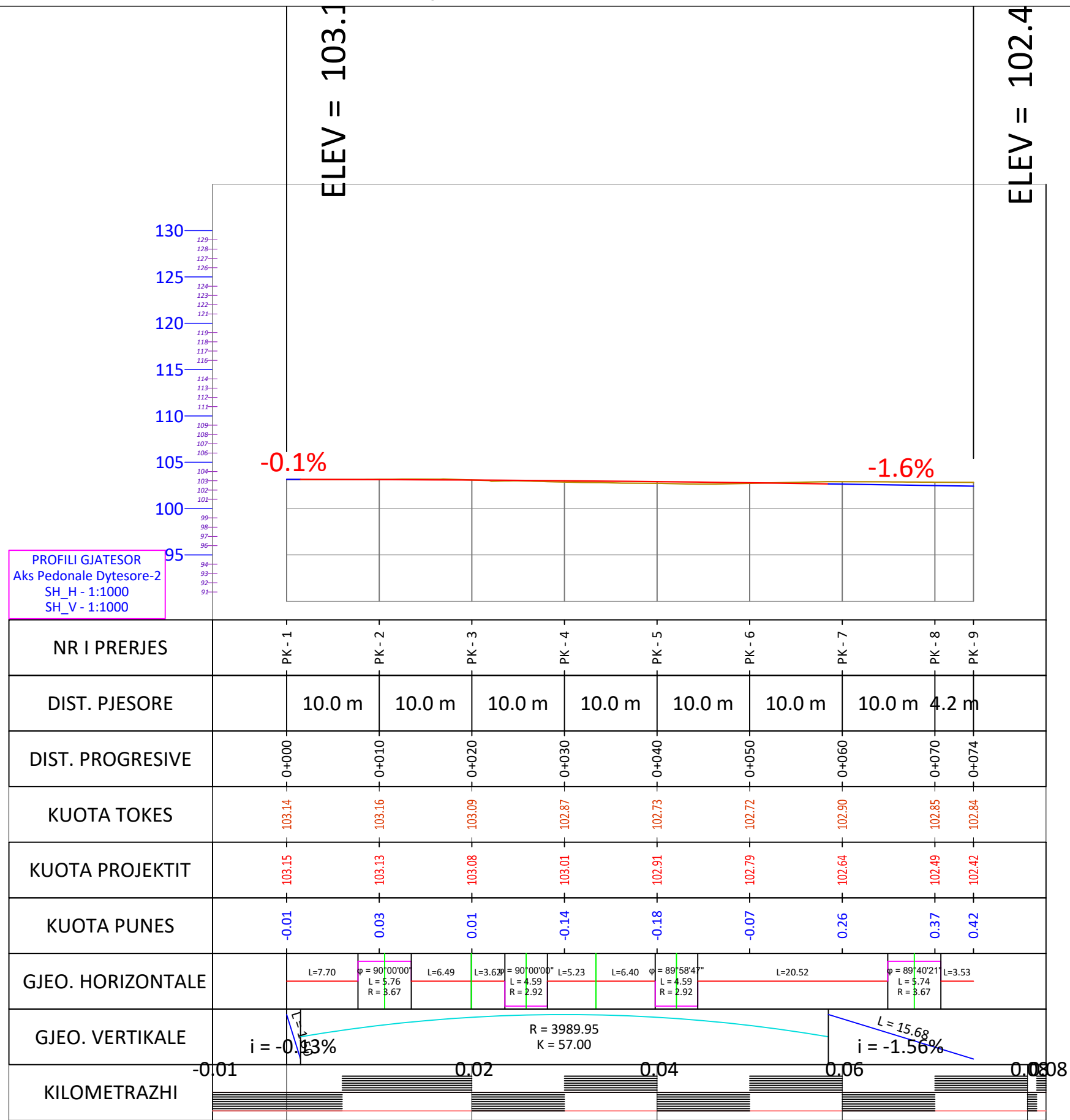

PROFILI GJATESOR  
Aks Pedonale Dytesore-2  
SH\_H - 1:1000  
SH\_V - 1:1000



**BASHKIA CERRIK**

**ZetaKonsult sh.p.k**  
Address:Rr."Myrteza Topi",Nd 18, Hyrja 7, Ap 38, TIRANE  
Cel:+355 (0)69 33 52 077  
e-mail:zetakonsultshpk@gmail.com

**EMERTIMI I OBJEKTIT:**  
NDERTIM I SHESHIT REKREATIV SHTERMEN, BASHKIA CERRIK

FAZA E PROJEKTIT :PROJEKT ZBATIMI

**EMERTESA E FLETES**  
PROFIL GJATESOR(pedonale dytesore-2)

SHKALLA Shk:1/500 FLETA 22

**GRUPI I PROJEKTIMIT:**  
Inxh. Ndert.Lorenc HOXHA  
Inxh.Ndert.Flutura Duro

Dt10/09/2024

FORMATI A3

# Profilet Terthore SH 1:250

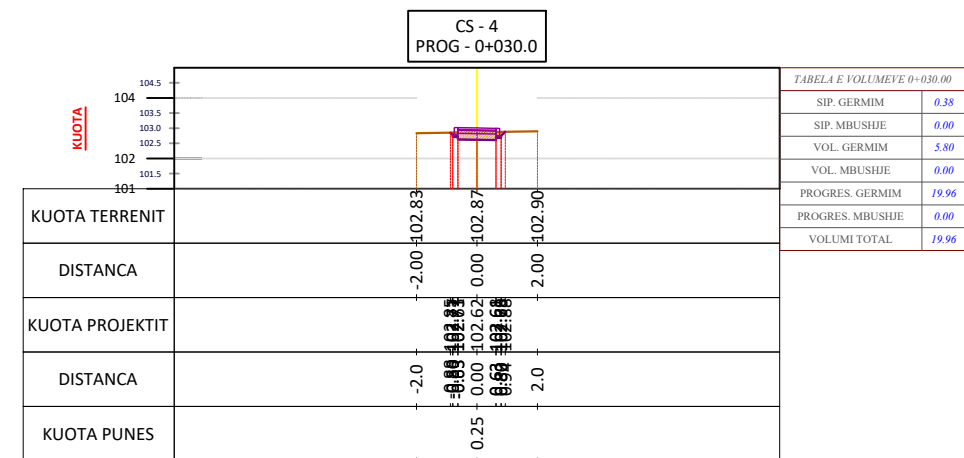
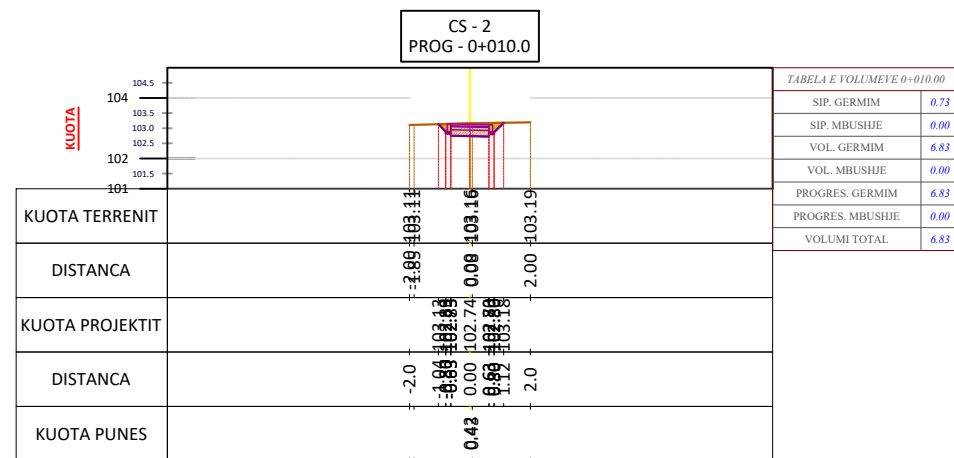
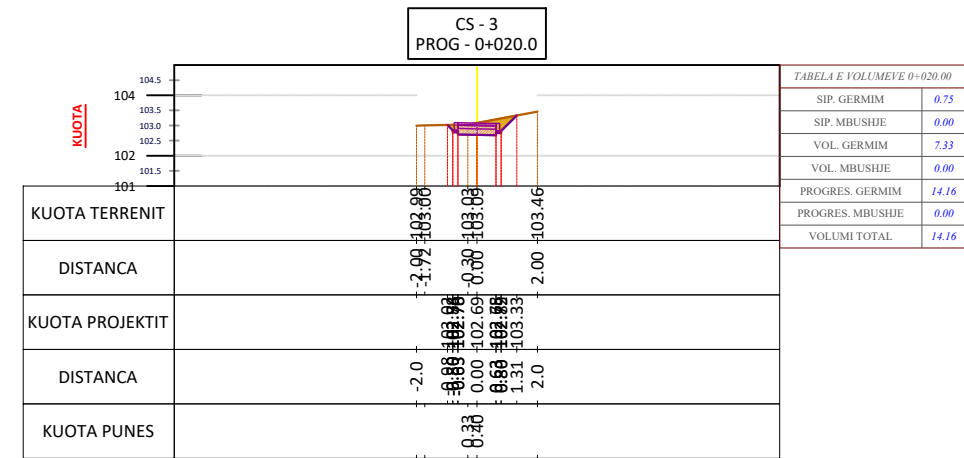
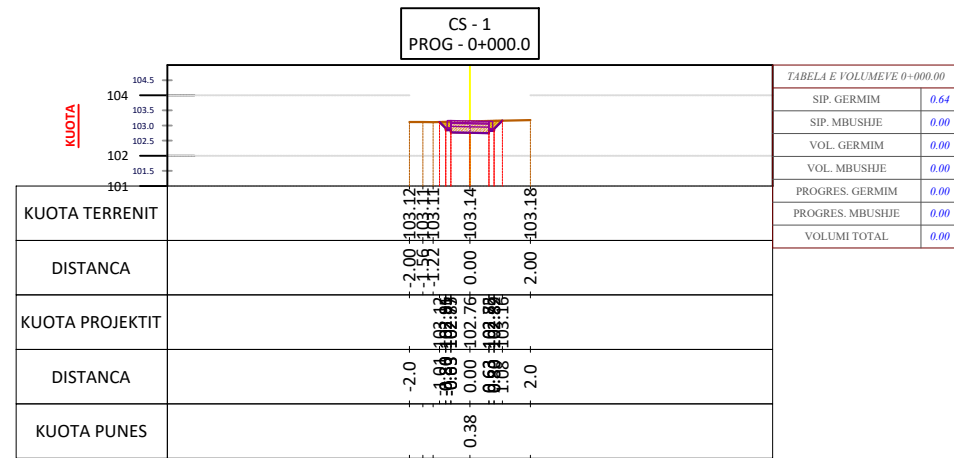



# Profillet Terthore SH 1:250

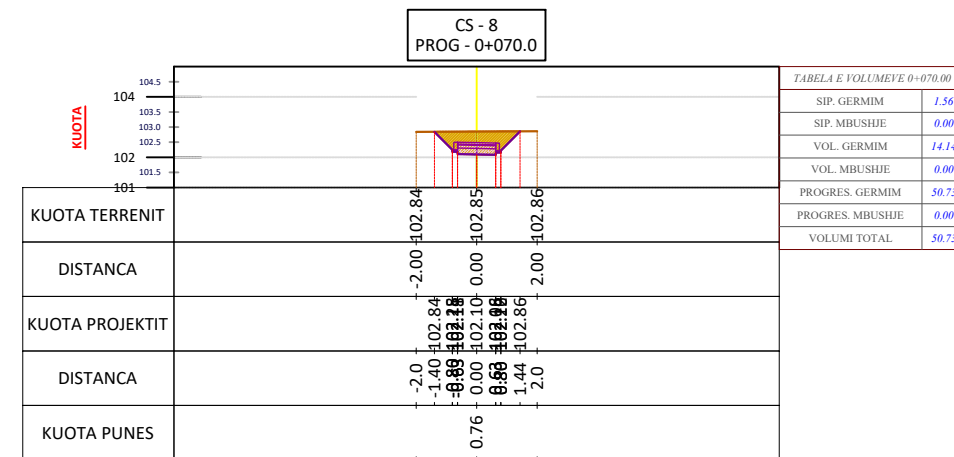
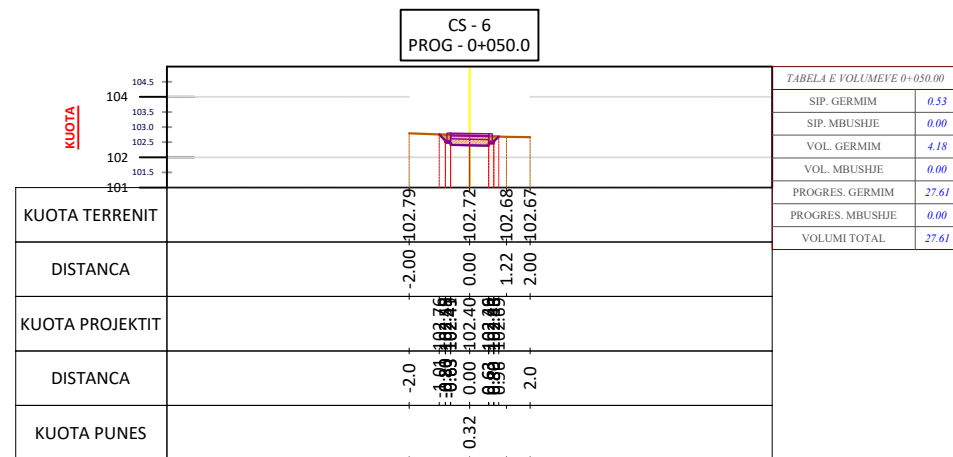
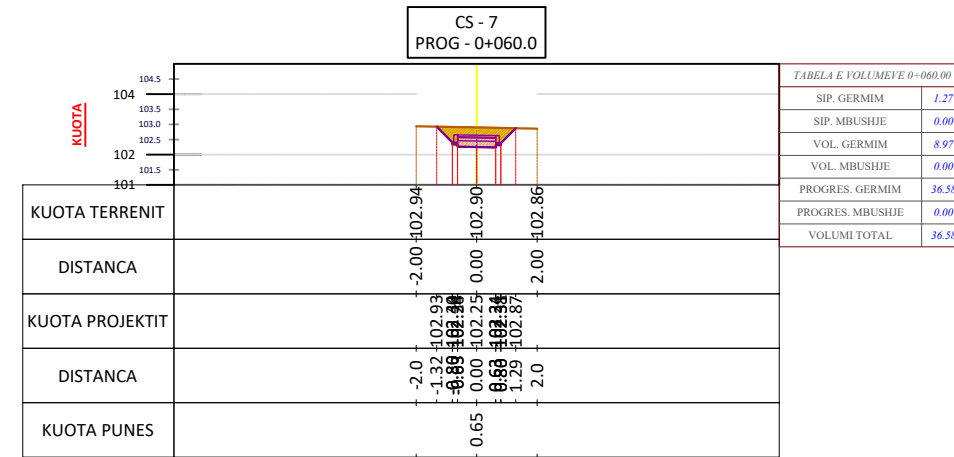
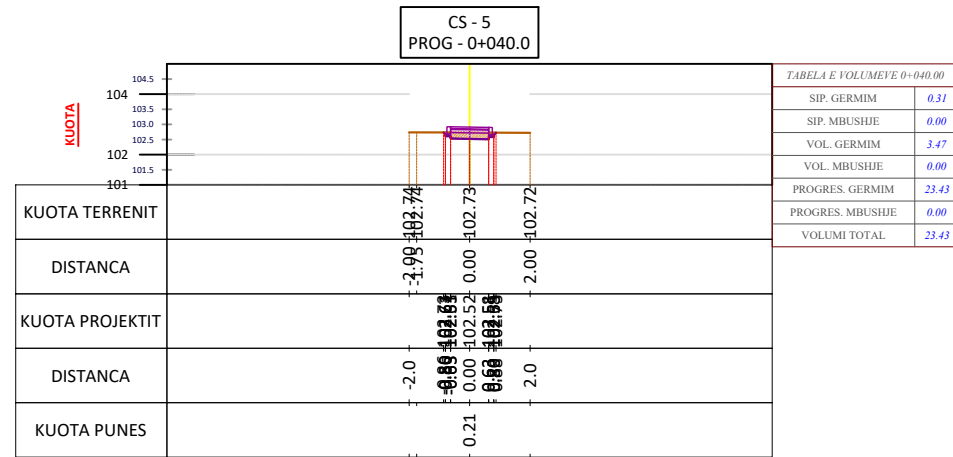

BASHKIA CERRIK



**ZetaKonsult sh.p.k**

Address: Rr. "Myrteza Topi", Nd 18, Hyrja 7, Ap 38, TIRANE

Cel: +355 (0)69 33 52 077

e-mail: zetakonsultshpk@gmail.com



**EMERTIMI I OBJEKTIT:**

NDERTIM I SHESHIT REKREATIV SHTERMEN, BASHKIA CERRIK

FAZA E PROJEKTIT : PROJEKT ZBATIMI

EMERTESA E FLETES  
PROFLET TERTHORE (pedonale  
dytesore-2)

SHKALLA Shk: 1/250

FLETA 24

GRUPI I PROJEKTIMIT:

Inxh. Ndert. Lorenc HOXHA  
Inxh. Ndert. Flutura Duro

Dt 10/09/2024

FORMATI A3

# Profillet Terthore SH 1:250

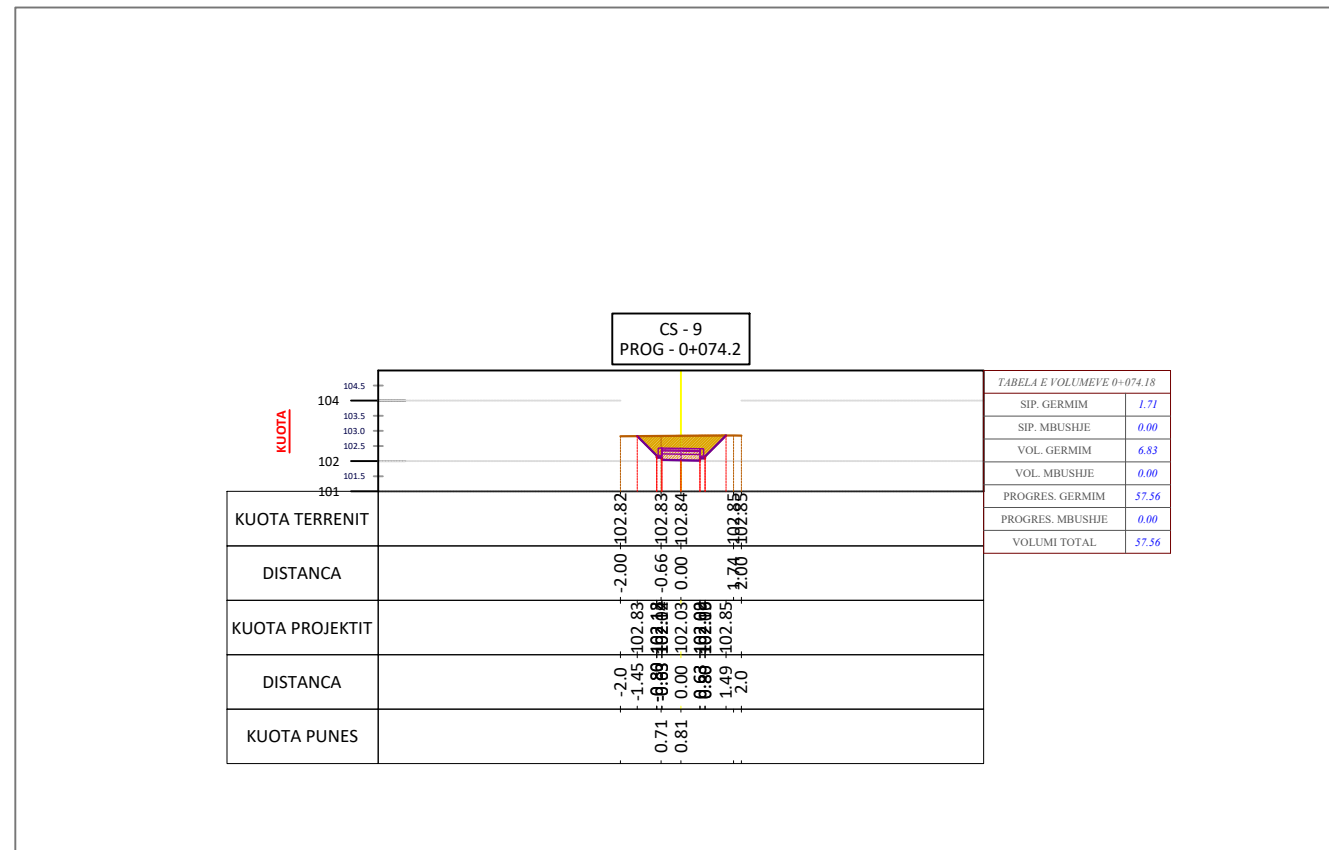

## Tabela Volumeve SH 1:250



VOLUMET						
Station	Fill Area	Cut Area	Fill Volume	Cut Volume	Cumulative Fill Vol	Cumulative Cut Vol
0+000.00	0.00	0.64	0.00	0.00	0.00	0.00
0+010.00	0.00	0.73	0.00	6.83	0.00	6.83
0+020.00	0.00	0.75	0.00	7.33	0.00	14.16
0+030.00	0.00	0.38	0.00	5.80	0.00	19.96
0+040.00	0.00	0.31	0.00	3.47	0.00	23.43
0+050.00	0.00	0.53	0.00	4.18	0.00	27.61
0+060.00	0.00	1.27	0.00	8.97	0.00	36.58
0+070.00	0.00	1.56	0.00	14.14	0.00	50.73
0+074.18	0.00	1.71	0.00	6.83	0.00	57.56

BASHKIA CERRIK



**ZetaKonsult sh.p.k**

Address:Rr."Myrteza Topi",Nd 18, Hyrja 7, Ap 38, TIRANE

Cel:+355 (0)69 33 52 077

e-mail:zetakonsultshpk@gmail.com



**EMERTIMI I OBJEKTIT:**

NDERTIM I SHESHIT REKREATIV SHTERMEN,BASHKIA CERRIK

FAZA E PROJEKTIT :PROJEKT ZBATIMI

EMERTESA E FLETES  
TABELA VOLUMEVE  
(pedonale dytesore-2)

SHKALLA Shk:1/250

FLETA 26

**GRUPI I PROJEKTIMIT:**

Inxh. Ndert.Lorenc HOXHA  
Inxh.Ndert.Flutura Duro

Dt10/09/2024

FORMATI A3

### Profil Gjatesor SH 1:500

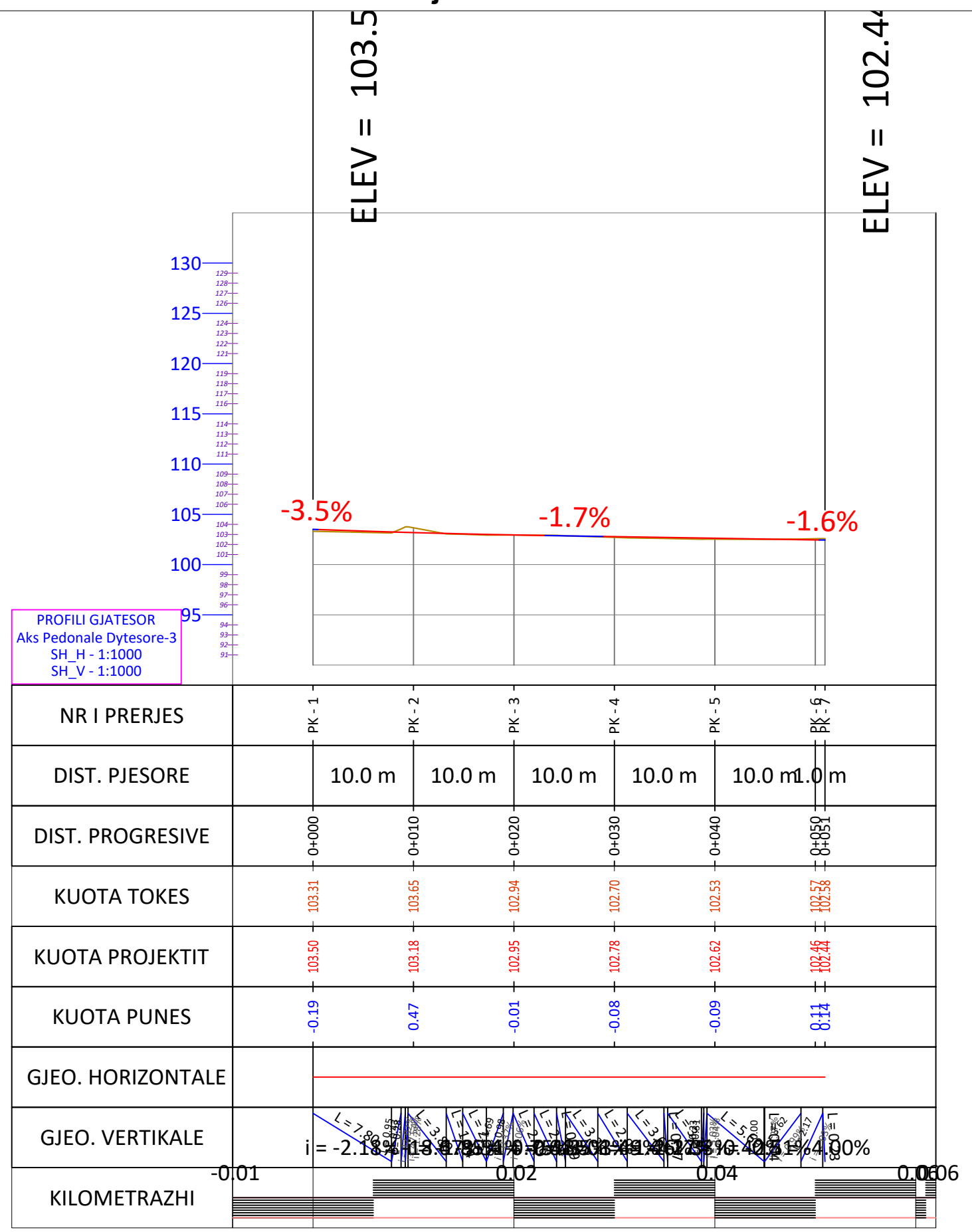

PROFILI GJATESOR  
Aks Pedonale Dytesore-3  
SH\_H - 1:1000  
SH\_V - 1:1000



**ZetaKonsult sh.p.k**  
 Address:Rr."Myrteza Topi",Nd 18, Hyrja 7, Ap 38, TIRANE  
 Cel:+355 (0)69 33 52 077  
 e-mail:zetakonsultshpk@gmail.com

**EMERTIMI I OBJEKTIT:**  
 NDERTIM I SHESHIT REKREATIV SHTERMEN,BASHKIA CERRIK

FAZA E PROJEKTIT :PROJEKT ZBATIMI

EMERTESA E FLETES  
 PROFIL GJATESOR(pedonale dytesore-3)

SHKALLA Shk:1/500 FLETA 27

GRUPI I PROJEKTIMIT:  
 Inxh. Ndert.Lorenc HOXHA  
 Inxh.Ndert.Flutura Duro

Dt10/09/2024

FORMATI A3

# Profillet Terthore SH 1:250

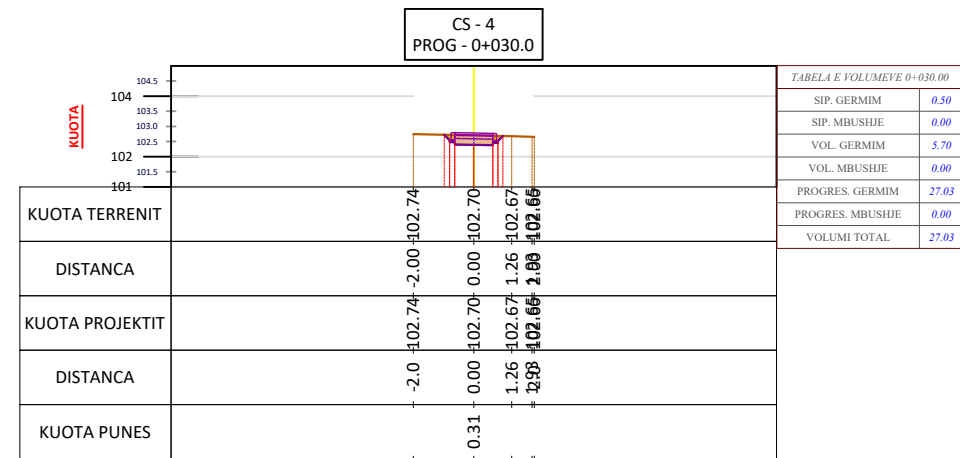
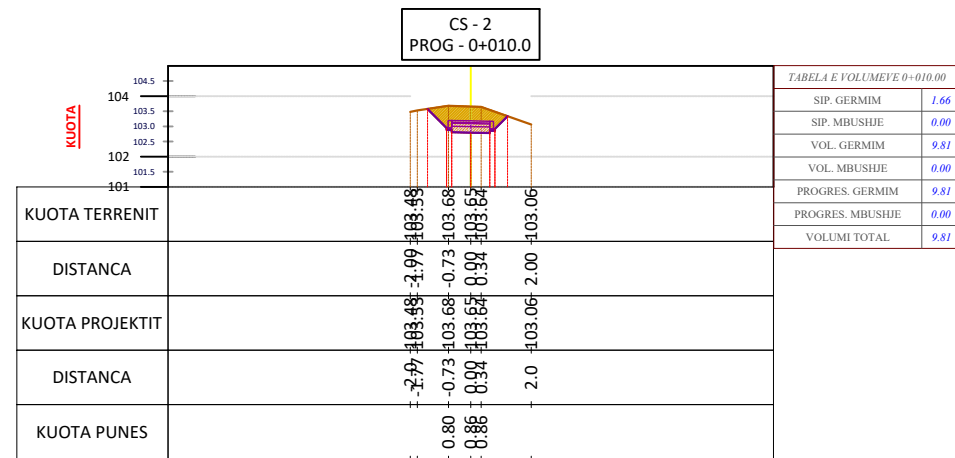
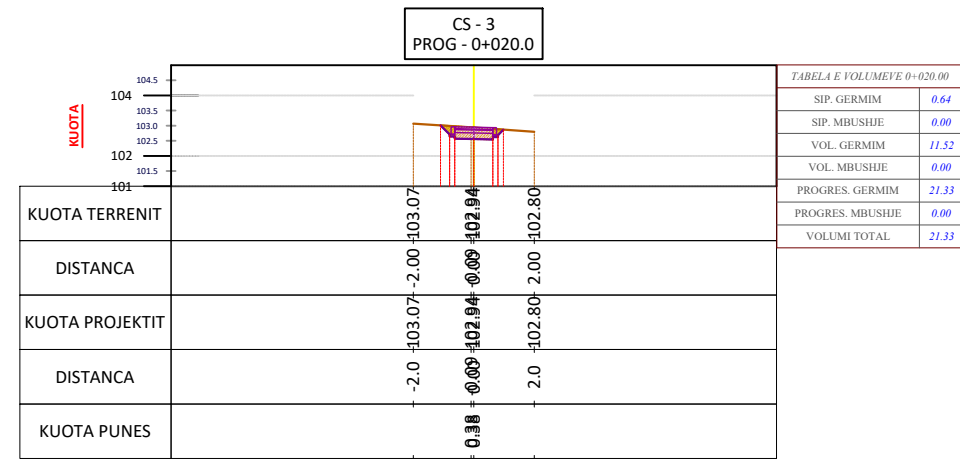
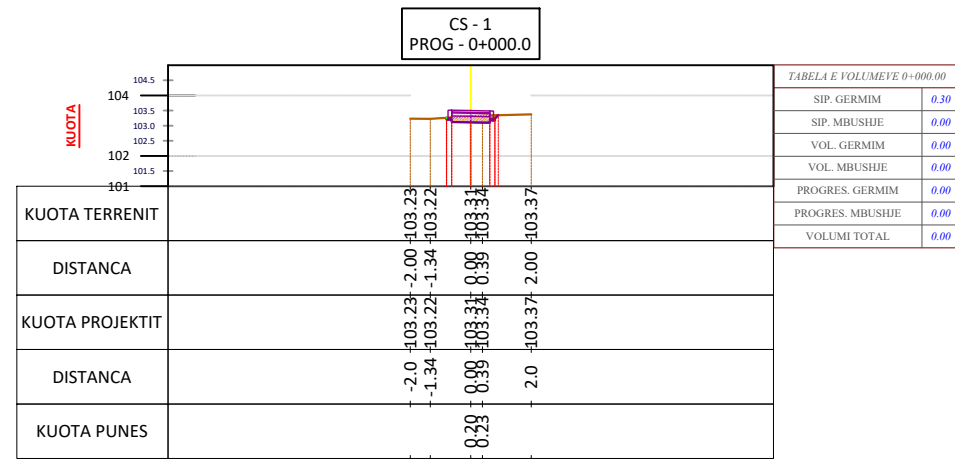

# Profilet Terthore SH 1:250

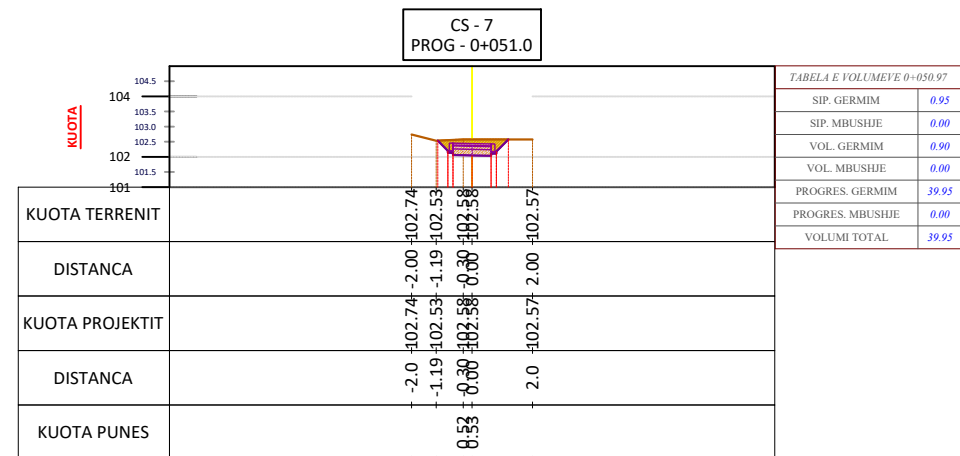
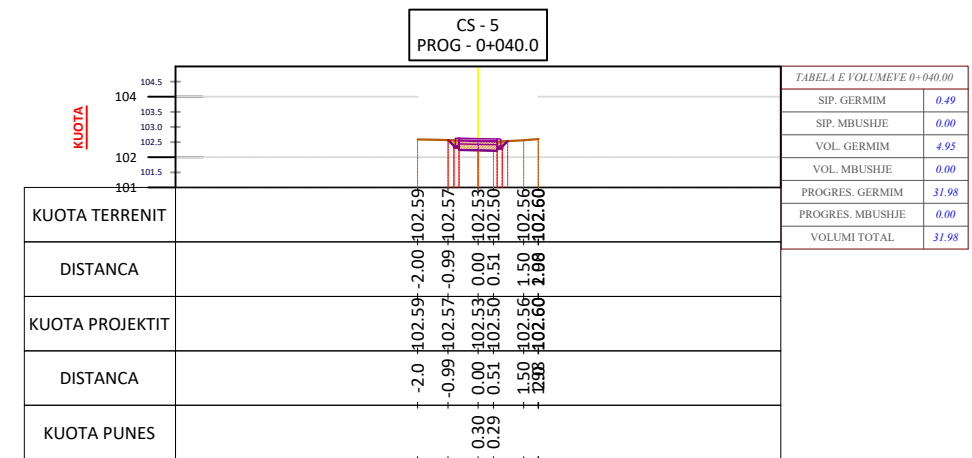
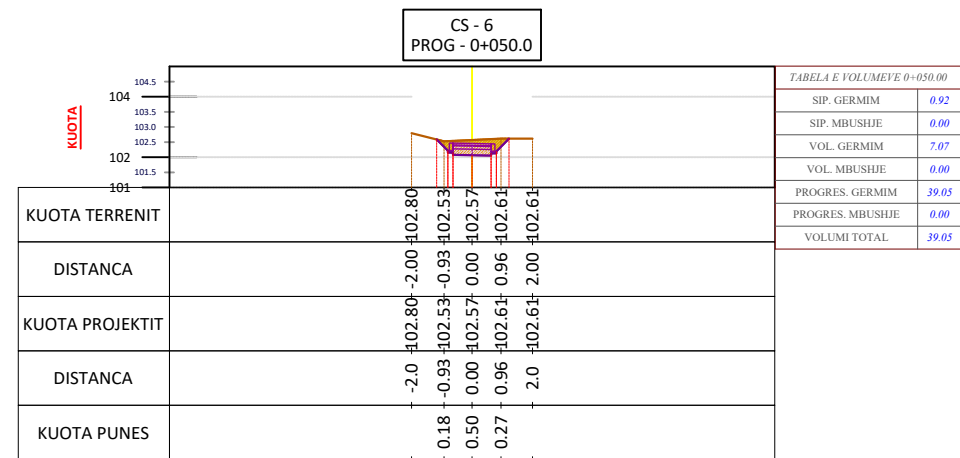

## Tabela Volumeve SH 1:250



VOLUMET						
Station	Fill Area	Cut Area	Fill Volume	Cut Volume	Cumulative Fill Vol	Cumulative Cut Vol
0+000.00	0.00	0.30	0.00	0.00	0.00	0.00
0+010.00	0.00	1.66	0.00	9.81	0.00	9.81
0+020.00	0.00	0.64	0.00	11.52	0.00	21.33
0+030.00	0.00	0.50	0.00	5.70	0.00	27.03
0+040.00	0.00	0.49	0.00	4.95	0.00	31.98
0+050.00	0.00	0.92	0.00	7.07	0.00	39.05
0+050.97	0.00	0.95	0.00	0.90	0.00	39.95

BASHKIA CERRIK



**ZetaKonsult sh.p.k**

Address:Rr."Myrteza Topi",Nd 18, Hyrja 7, Ap 38, TIRANE

Cel:+355 (0)69 33 52 077

e-mail:zetakonsultshpk@gmail.com



**EMERTIMI I OBJEKTIT:**

NDERTIM I SHESHIT REKREATIV SHTERMEN,BASHKIA CERRIK

FAZA E PROJEKTIT :PROJEKT ZBATIMI

EMERTESA E FLETES  
TABELA VOLUMEVE  
(pedonale dytesore-3)

SHKALLA Shk:1/250

FLETA 30

**GRUPI I PROJEKTIMIT:**

Inxh. Ndert.Lorenc HOXHA  
Inxh.Ndert.Flutura Duro

Dt10/09/2024

FORMATI A3

### Profil Gjatesor SH 1:500

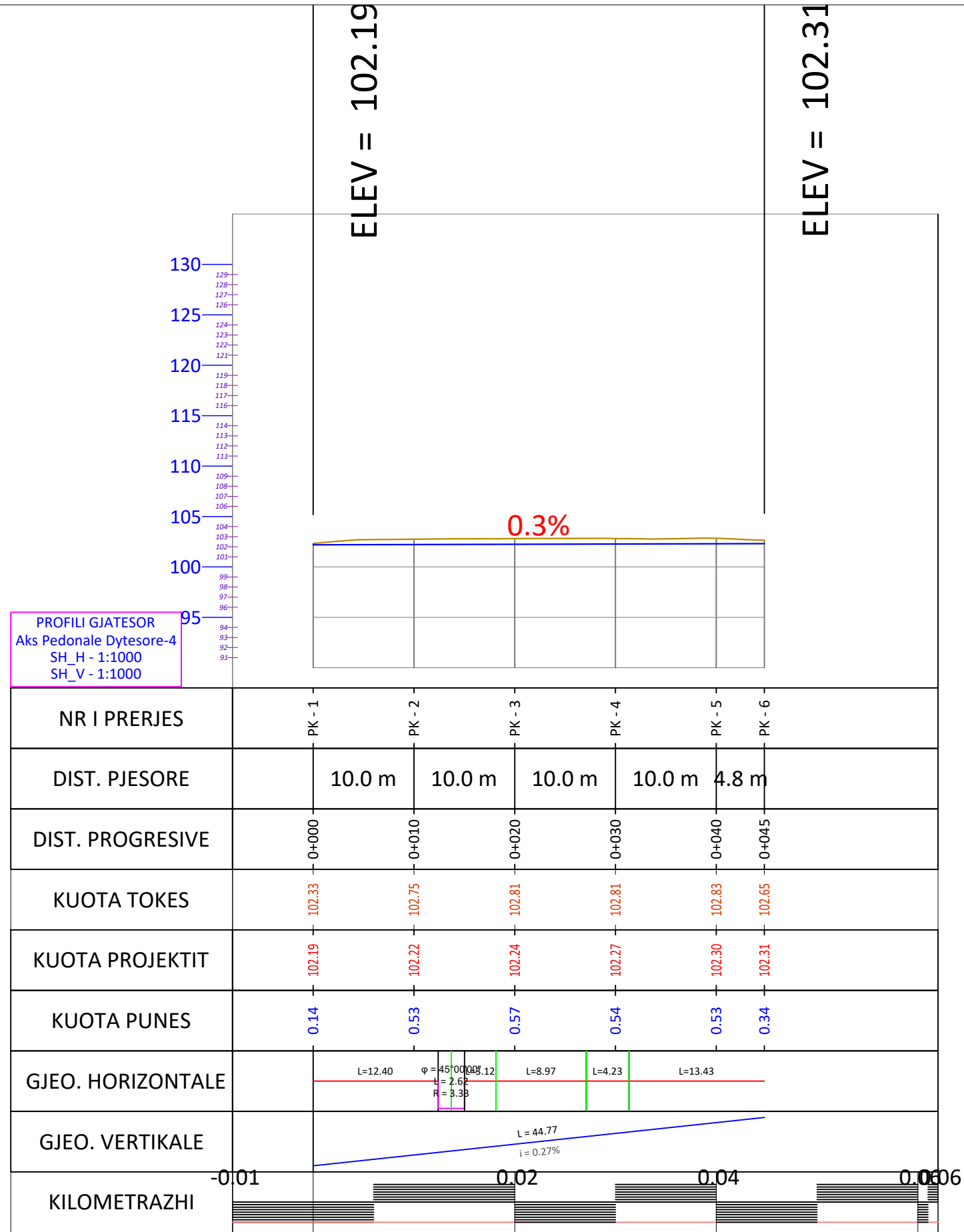

PROFILI GJATESOR  
 Aks Pedonale Dytesore-4  
 SH\_H - 1:1000  
 SH\_V - 1:1000



**ZetaKonsult sh.p.k**  
 Address:Rr."Myrteza Topi",Nd 18, Hyrja 7, Ap 38, TIRANE  
 Cel:+355 (0)69 33 52 077  
 e-mail:zetakonsultshpk@gmail.com

**EMERTIMI I OBJEKTIT:**  
 NDERTIM I SHESHIT REKREATIV SHTERMEN,BASHKIA CERRIK

FAZA E PROJEKTIT :PROJEKT ZBATIMI

EMERTESA E FLETES  
 PROFIL GJATESOR(pedonale dytesore-4)

SHKALLA Shk:1/500 FLETA 31

GRUPI I PROJEKTIMIT:  
 Inxh. Ndert.Lorenc HOXHA  
 Inxh.Ndert.Flutura Duro

Dt10/09/2024

FORMATI A3



# Profilet Terthore SH 1:250

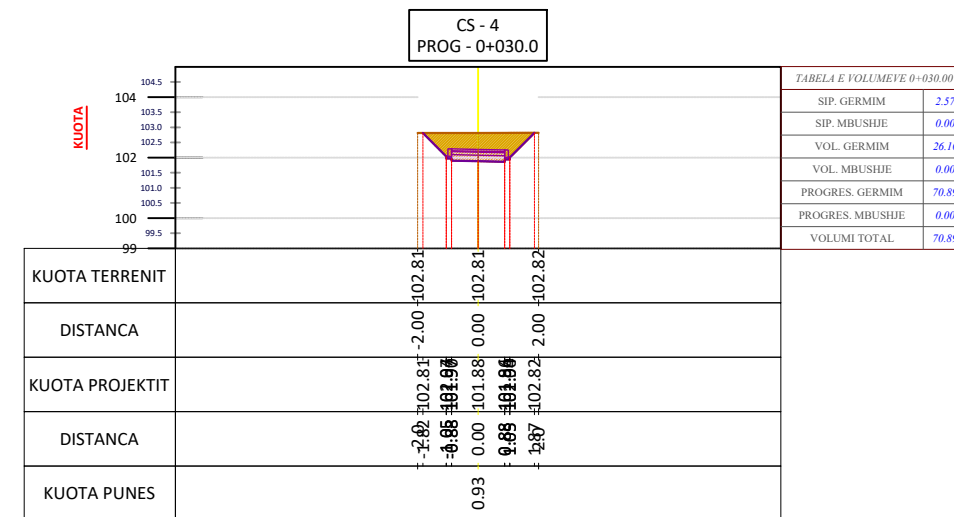
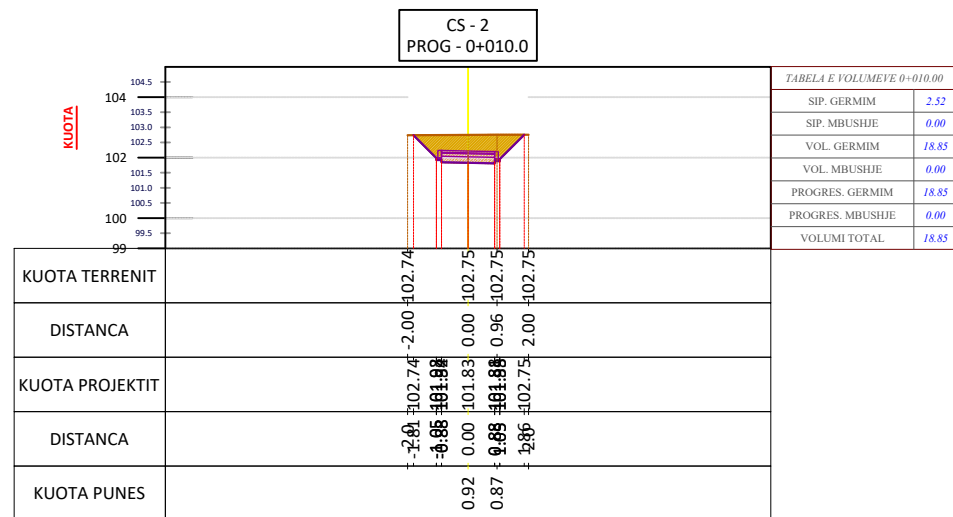
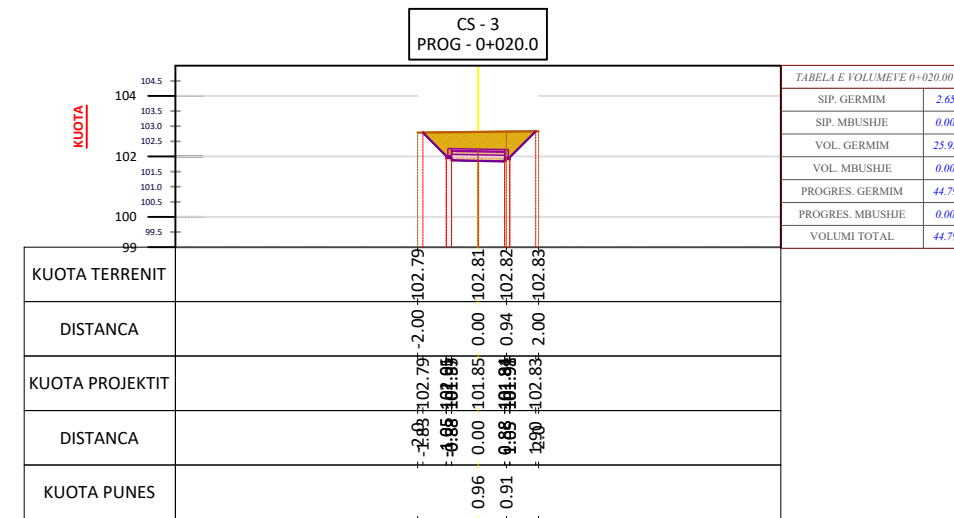
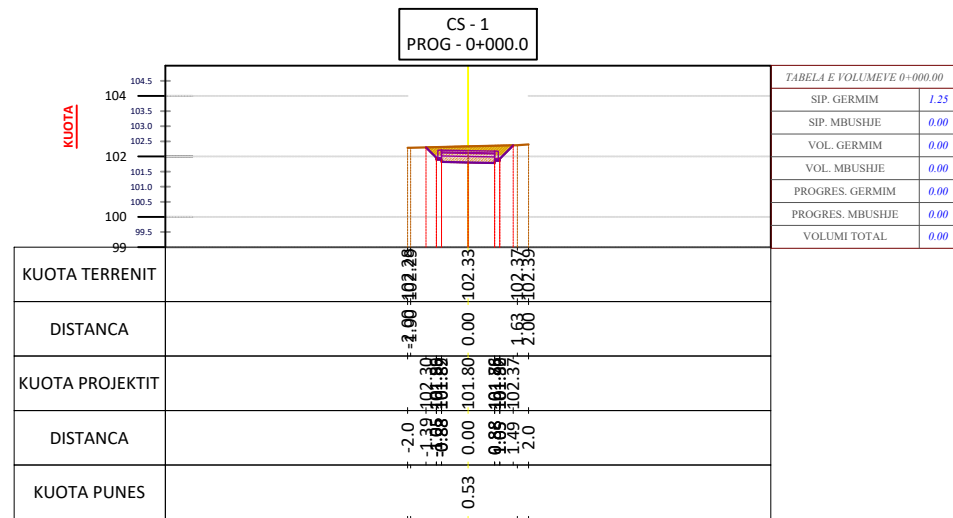

BASHKIA CERRIK



**ZetaKonsult sh.p.k**

Address: Rr. "Myrteza Topi", Nd 18, Hyrja 7, Ap 38, TIRANE

Cel: +355 (0)69 33 52 077

e-mail: zetakonsultshpk@gmail.com



**EMERTIMI I OBJEKTIT:**  
NDERTIM I SHESHIT REKREATIV SHTERMEN, BASHKIA CERRIK

FAZA E PROJEKTIT : PROJEKT ZBATIMI

EMERTESA E FLETES  
PROFLET TERTHORE (pedonale dytesore-4)

SHKALLA Shk: 1/250

FLETA 32

GRUPI I PROJEKTIMIT:

Inxh. Ndert. Lorenc HOXHA  
Inxh. Ndert. Flutura Duro

Dt 10/09/2024

FORMATI A3

# Profillet Terthore SH 1:250

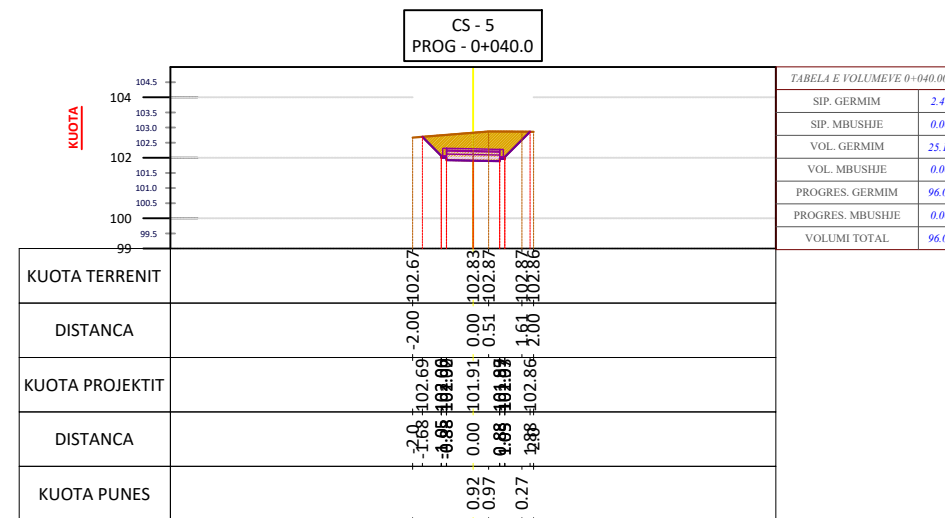
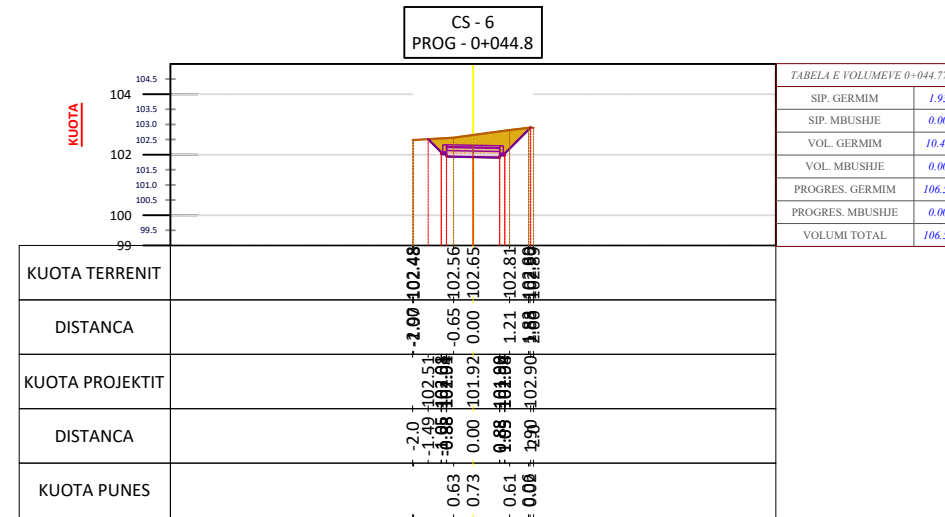

### Tabela Volumeve SH 1:250



VOLUMET						
Station	Fill Area	Cut Area	Fill Volume	Cut Volume	Cumulative Fill Vol	Cumulative Cut Vol
0+000.00	0.00	1.25	0.00	0.00	0.00	0.00
0+010.00	0.00	2.52	0.00	18.85	0.00	18.85
0+020.00	0.00	2.65	0.00	25.95	0.00	44.79
0+030.00	0.00	2.57	0.00	26.10	0.00	70.89
0+040.00	0.00	2.46	0.00	25.15	0.00	96.05
0+044.77	0.00	1.93	0.00	10.47	0.00	106.52



# Profil Gjatesor SH 1:500

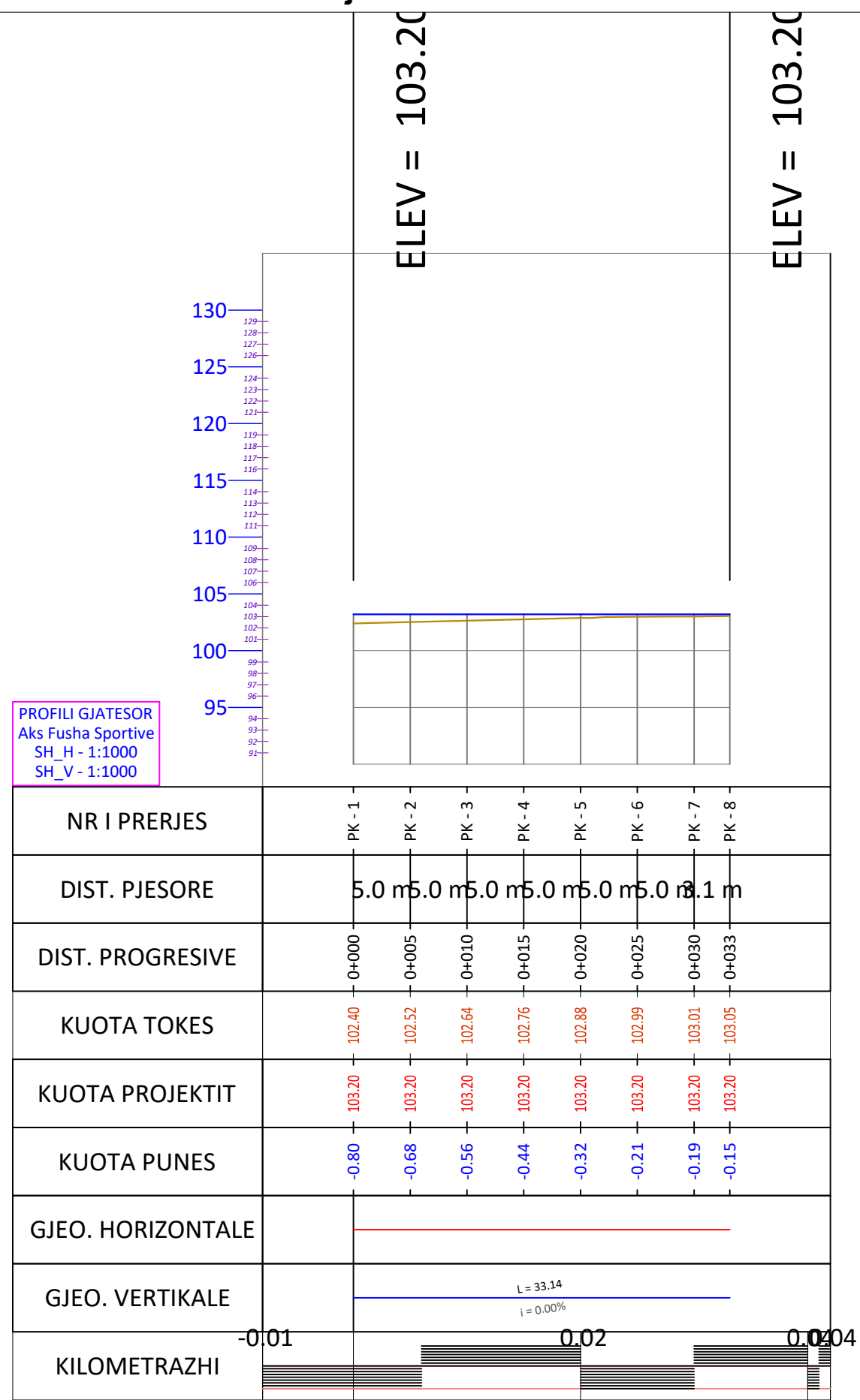

**ZetaKonsult sh.p.k**  
 Address:Rr."Myrteza Topi",Nd 18, Hyrja 7, Ap 38, TIRANE  
 Cel: +355 (0)69 33 52 077  
 e-mail:zetakonsultshpk@gmail.com



**EMERTIMI I OBJEKTIT:**  
 NDERTIM I SHESHIT REKREATIV SHTERMEN, BASHKIA CERRIK

---

FAZA E PROJEKTIT :PROJEKT ZBATIMI

EMERTESA E FLETES  
 PROFIL GJATESOR(fusha sportive)

---

SHKALLA Shk:1/500      FLETA 35

GRUPI I PROJEKTIMIT:

---

Inxh. Ndert.Lorenc HOXHA  
 Inxh.Ndert.Flutura Duro

Dt10/09/2024

---

FORMATI A3

# Profillet Terthore SH 1:250

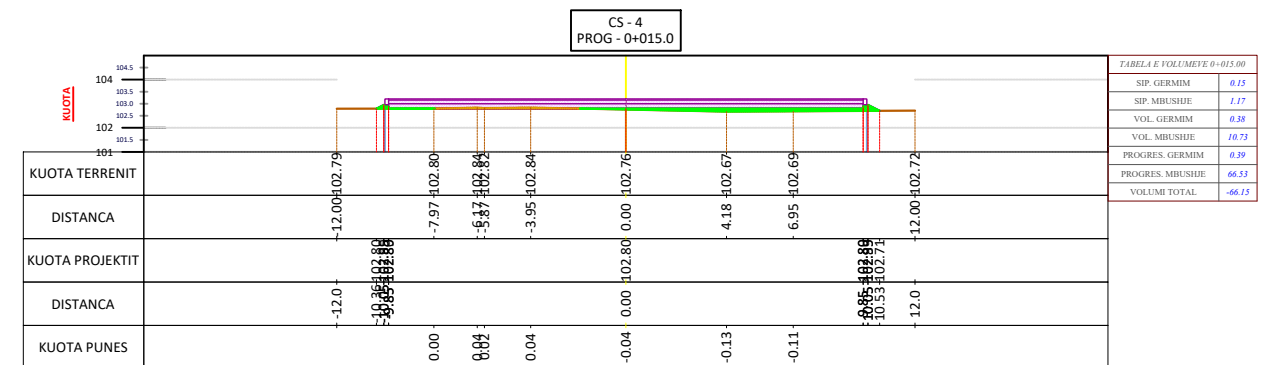
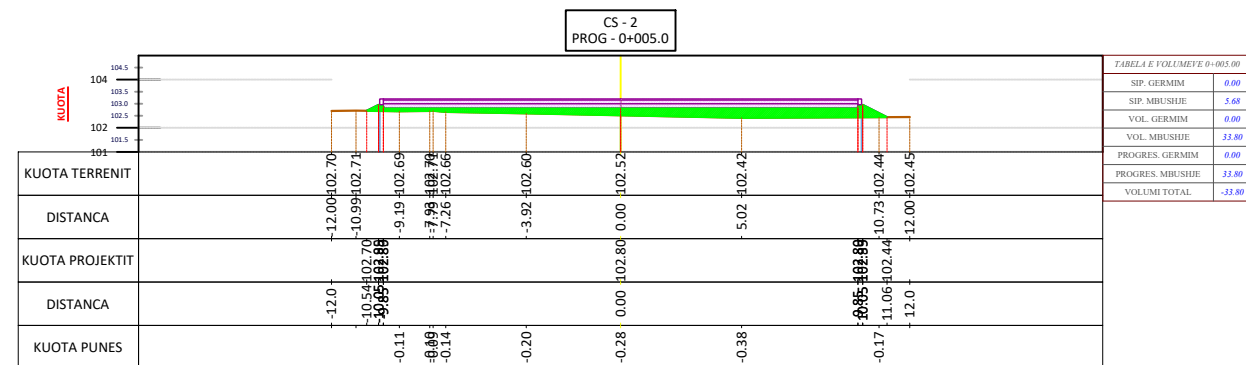
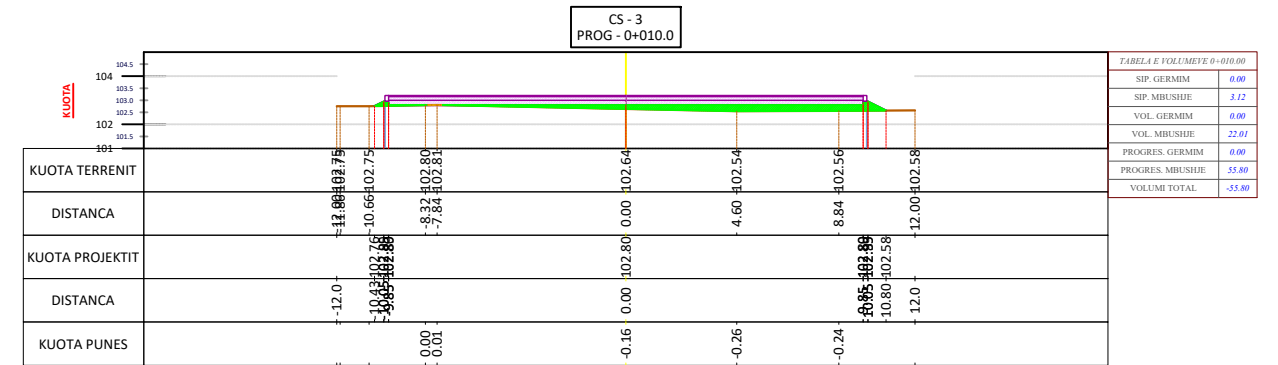
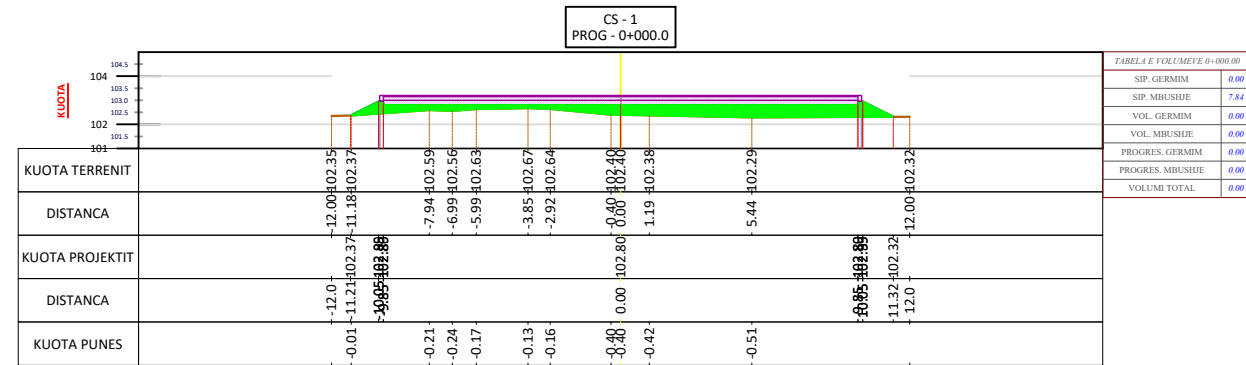

BASHKIA CERRIK



**ZetaKonsult sh.p.k**

Address: Rr. "Myrteza Topi", Nd 18, Hyrja 7, Ap 38, TIRANE

Cel: +355 (0)69 33 52 077

e-mail: zetakonsultshpk@gmail.com



**EMERTIMI I OBJEKTIT:**  
NDERTIM I SHESHIT REKREATIV SHTERMEN, BASHKIA CERRIK

FAZA E PROJEKTIT : PROJEKT ZBATIMI

EMERTESA E FLETES  
PROFILET TERTHORE (fusha sportive)

SHKALLA Shk: 1/250

FLETA 36

GRUPI I PROJEKTIMIT:

Inxh. Ndert. Lorenc HOXHA  
Inxh. Ndert. Flutura Duro

Dt 10/09/2024

FORMATI A3

# Profillet Terthore SH 1:250

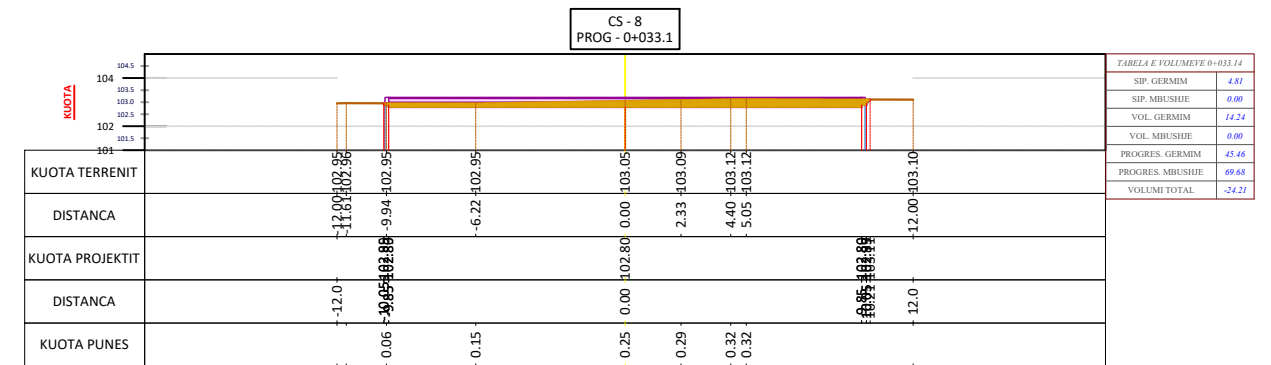
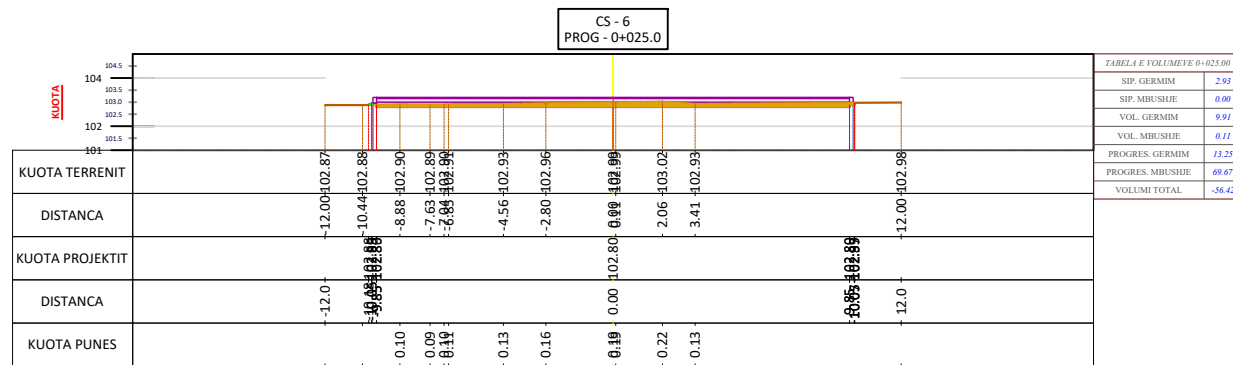
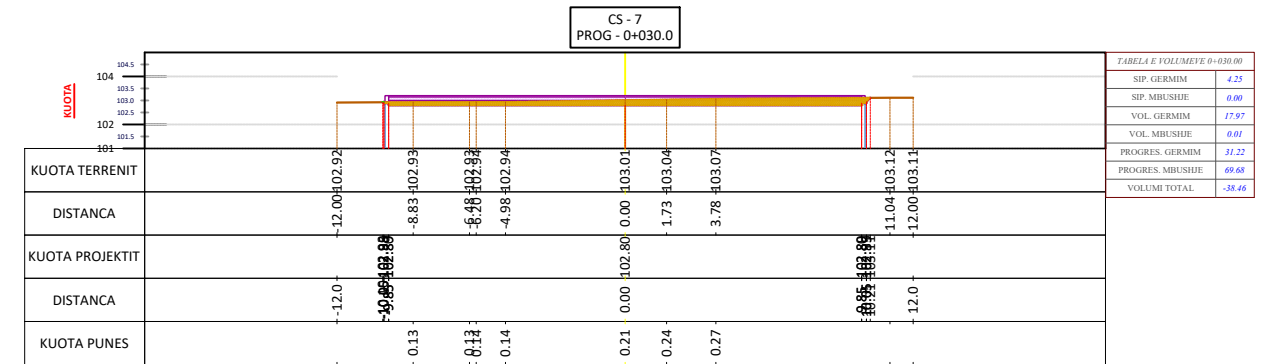
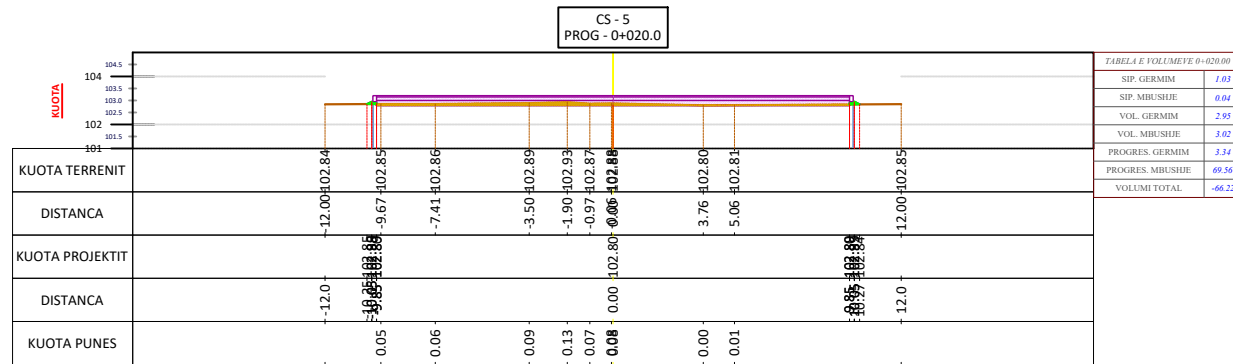

BASHKIA CERRIK



**ZetaKonsult sh.p.k**

Address: Rr. "Myrteza Topi", Nd 18, Hyrja 7, Ap 38, TIRANE

Cel: +355 (0)69 33 52 077

e-mail: zetakonsultshpk@gmail.com



**EMERTIMI I OBJEKTIT:**  
NDERTIM I SHESHIT REKREATIV SHTERMEN, BASHKIA CERRIK

FAZA E PROJEKTTIT : PROJEKT ZBATIMI

**EMERTESA E FLETES**  
PROFLET TERTHORE (fusha sportive)

SHKALLA Shk: 1/250

FLETA 37

**GRUPI I PROJEKTTIMIT:**

Inxh. Ndert. Lorenc HOXHA  
Inxh. Ndert. Flutura Duro

Dt 10/09/2024

FORMATI A3

## Tabela Volumeve SH 1:250



VOLUMET						
Station	Fill Area	Cut Area	Fill Volume	Cut Volume	Cumulative Fill Vol	Cumulative Cut Vol
0+000.00	7.84	0.00	0.00	0.00	0.00	0.00
0+005.00	5.68	0.00	33.80	0.00	33.80	0.00
0+010.00	3.12	0.00	22.01	0.00	55.80	0.00
0+015.00	1.17	0.15	10.73	0.38	66.53	0.39
0+020.00	0.04	1.03	3.02	2.95	69.56	3.34
0+025.00	0.00	2.93	0.11	9.91	69.67	13.25
0+030.00	0.00	4.25	0.01	17.97	69.68	31.22
0+033.14	0.00	4.81	0.00	14.24	69.68	45.46



## Profil Gjatesor SH 1:500

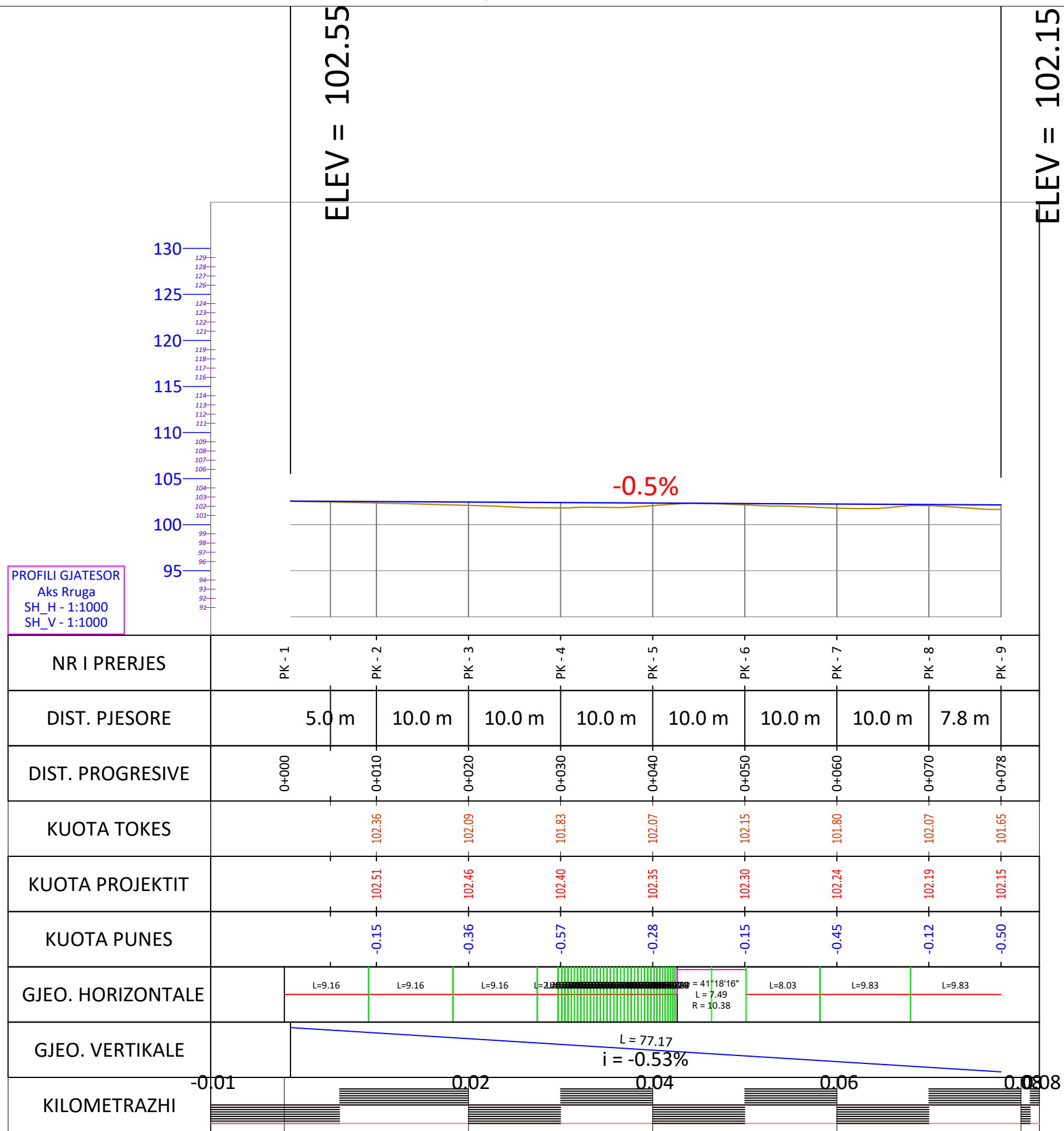

PROFILI GJATESOR  
 Aks Rruga  
 SH\_H - 1:1000  
 SH\_V - 1:1000



BASHKIA CERRIK



**ZetaKonsult sh.p.k**

Address: Rr. "Myrteza Topi", Nd 18, Hyrja 7, Ap 38, TIRANE

Cel: +355 (0)69 33 52 077

e-mail: zetakonsultshpk@gmail.com



**EMERTIMI I OBJEKTIT:**  
 NDERTIM I SHESHIT REKREATIV SHTERMEN, BASHKIA CERRIK

FAZA E PROJEKTIT : PROJEKT ZBATIMI

EMERTESA E FLETES  
 PROFIL GJATESOR (rruge me asfalt)

SHKALLA Shk: 1/500

FLETA 39

GRUPI I PROJEKTIMIT:

Inxh. Ndert. Lorenc HOXHA  
 Inxh. Ndert. Flutura Duro

Dt 10/09/2024

FORMATI A3



# Profilet Terthore SH 1:250

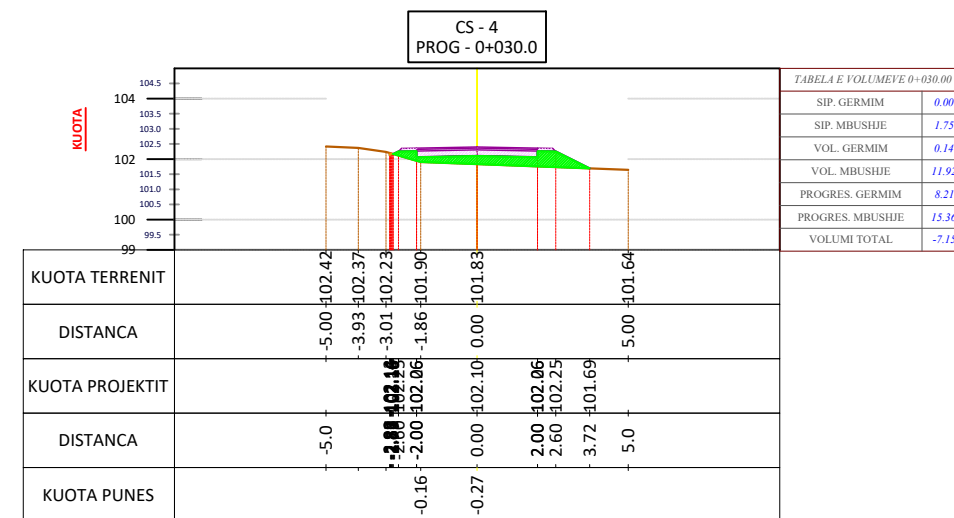
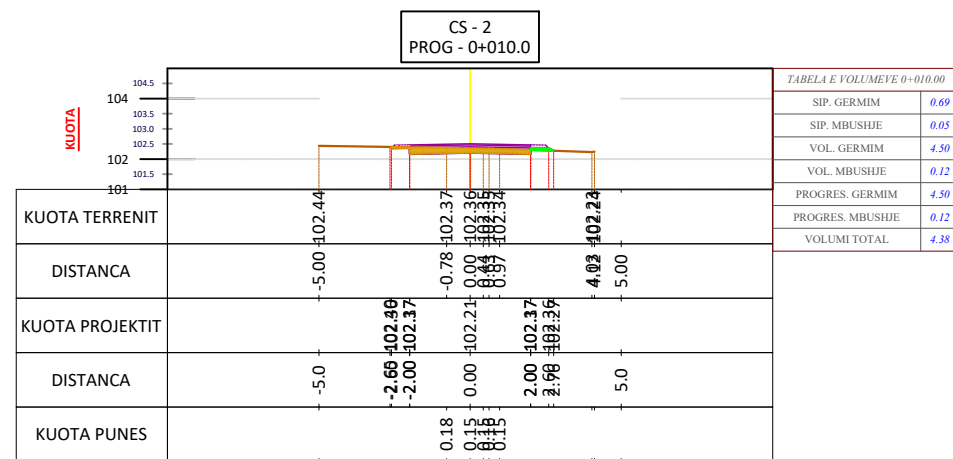
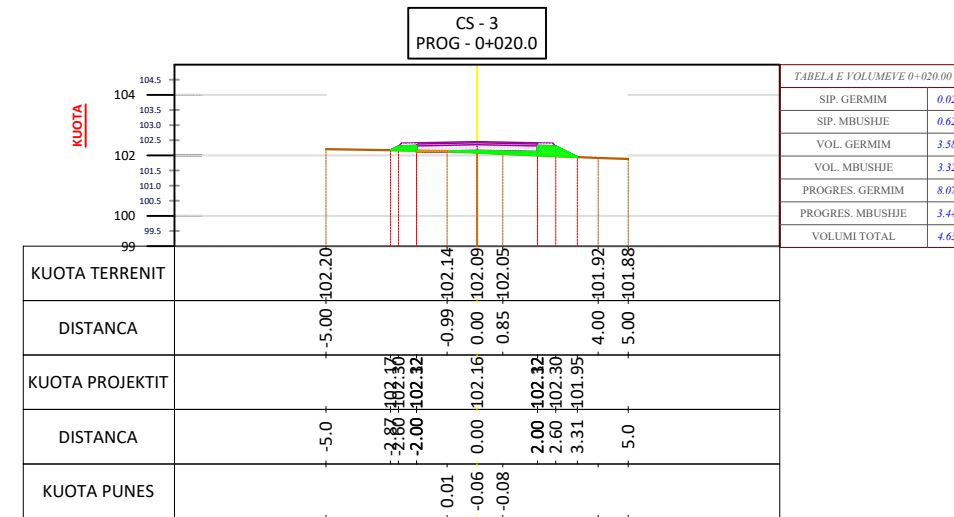
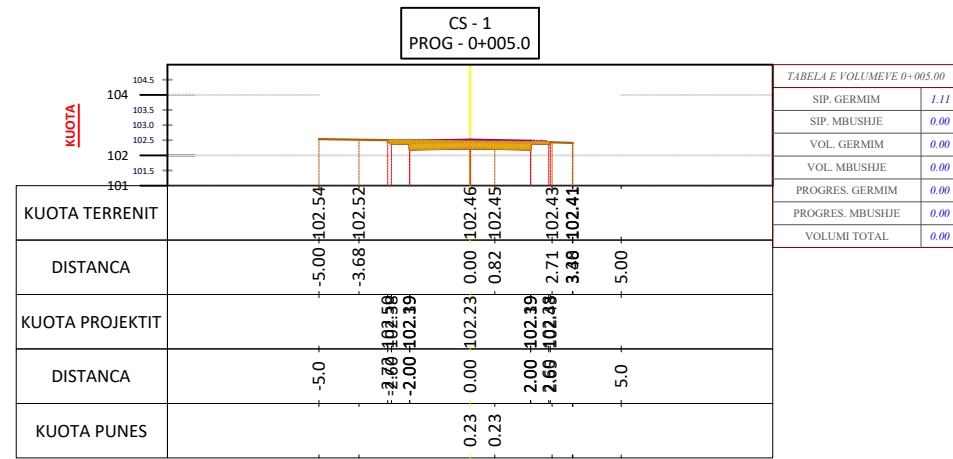

BASHKIA CERRIK



**ZetaKonsult sh.p.k**

Address: Rr. "Myrteza Topi", Nd 18, Hyrja 7, Ap 38, TIRANE

Cel: +355 (0)69 33 52 077

e-mail: zetakonsultshpk@gmail.com



**EMERTIMI I OBJEKTIT:**  
NDERTIM I SHESHIT REKREATIV SHTERMEN, BASHKIA CERRIK

FAZA E PROJEKTIT : PROJEKT ZBATIMI

**EMERTESA E FLETES**  
PROFLET TERTHORE (rruge me asfalt)

SHKALLA Shk: 1/250

FLETA 40

**GRUPI I PROJEKTIMIT:**

Inxh. Ndert. Lorenc HOXHA  
Inxh. Ndert. Flutura Duro

Dt 10/09/2024

FORMATI A3

# Profilet Terthore SH 1:250

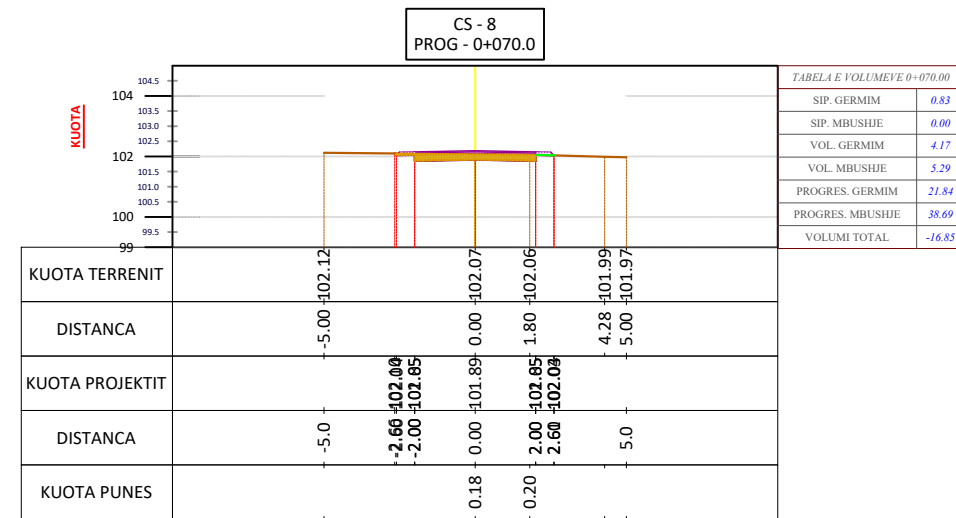
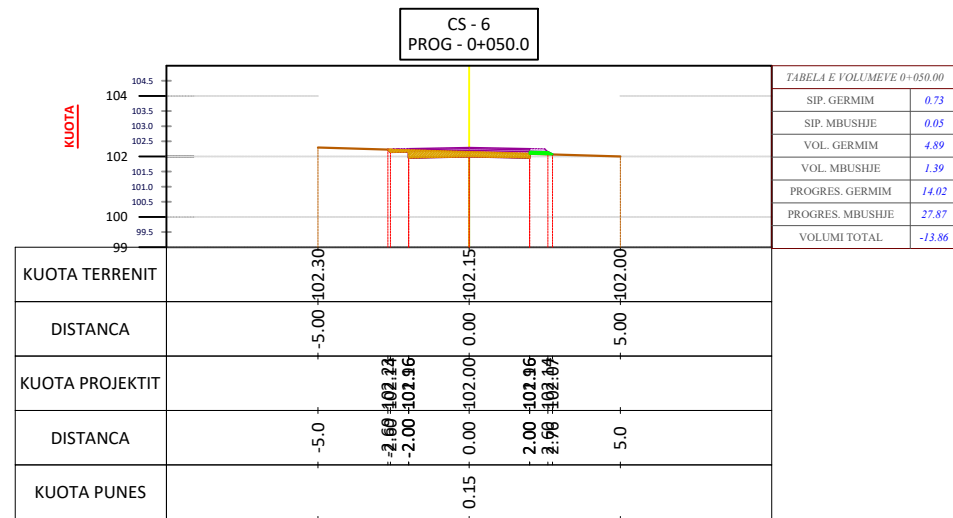
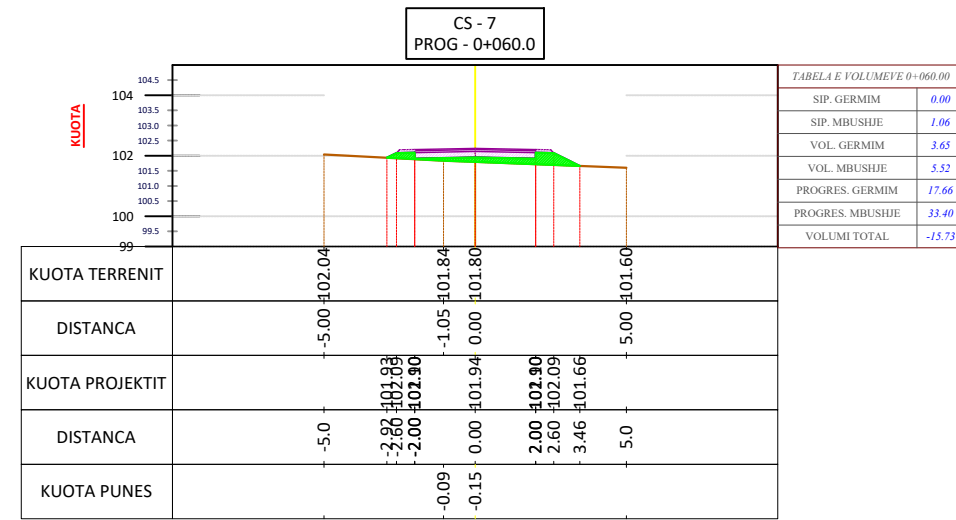
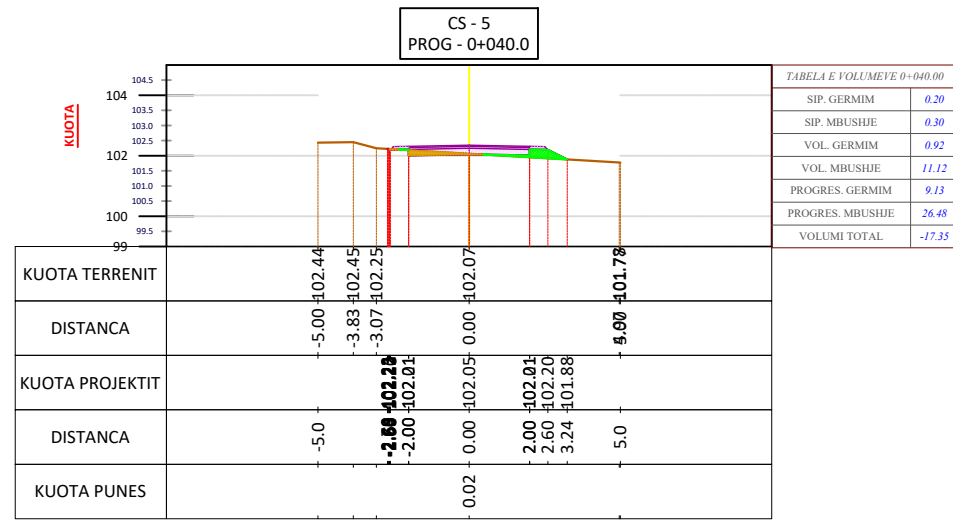

BASHKIA CERRIK



**ZetaKonsult sh.p.k**

Address: Rr. "Myrteza Topi", Nd 18, Hyrja 7, Ap 38, TIRANE

Cel: +355 (0)69 33 52 077

e-mail: zetakonsultshpk@gmail.com



**EMERTIMI I OBJEKTIT:**  
NDERTIM I SHESHIT REKREATIV SHTERMEN, BASHKIA CERRIK

FAZA E PROJEKTIT : PROJEKT ZBATIMI

**EMERTESA E FLETES**  
PROFLET TERTHORE (ruge me asfalt)

SHKALLA Shk: 1/250

FLETA 41

**GRUPI I PROJEKTIMIT:**

Inxh. Ndert. Lorenc HOXHA  
Inxh. Ndert. Flutura Duro

Dt 10/09/2024

FORMATI A3

# Profillet Terthore SH 1:250

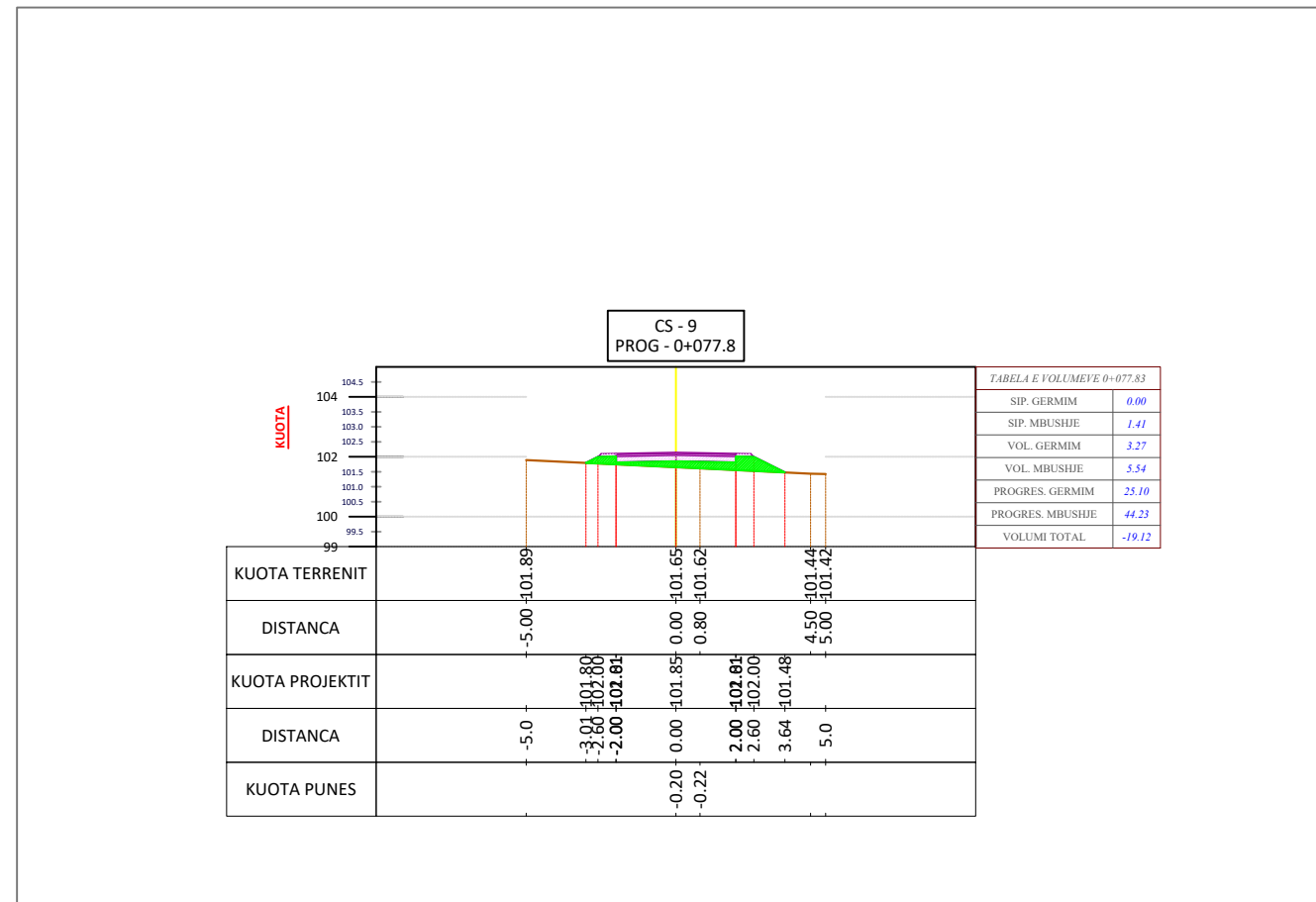

BASHKIA CERRIK



**ZetaKonsult sh.p.k**

Address: Rr. "Myrteza Topi", Nd 18, Hyrja 7, Ap 38, TIRANE

Cel: +355 (0)69 33 52 077

e-mail: zetakonsultshpk@gmail.com



**EMERTIMI I OBJEKTIT:**

NDERTIM I SHESHIT REKREATIV SHTERMEN, BASHKIA CERRIK

FAZA E PROJEKTIT : PROJEKT ZBATIMI

EMERTESA E FLETES  
PROFLET TERTHORE (rruge me asfalt)

SHKALLA Shk: 1/250

FLETA 42

GRUPI I PROJEKTIMIT:

Inxh. Ndert. Lorenc HOXHA  
Inxh. Ndert. Flutura Duro

Dt 10/09/2024

FORMATI A3

### Tabela Volumeve SH 1:250



VOLUMET						
Station	Fill Area	Cut Area	Fill Volume	Cut Volume	Cumulative Fill Vol	Cumulative Cut Vol
0+005.00	0.00	1.11	0.00	0.00	0.00	0.00
0+010.00	0.05	0.69	0.12	4.50	0.12	4.50
0+020.00	0.62	0.02	3.32	3.58	3.44	8.07
0+030.00	1.75	0.00	11.92	0.14	15.36	8.21
0+040.00	0.30	0.20	11.12	0.92	26.48	9.13
0+050.00	0.05	0.73	1.39	4.89	27.87	14.02
0+060.00	1.06	0.00	5.52	3.65	33.40	17.66
0+070.00	0.00	0.83	5.29	4.17	38.69	21.84
0+077.83	1.41	0.00	5.54	3.27	44.23	25.10



# Planimetria e dhomave te zhveshjes SH 1:50

PLANIMETRIA

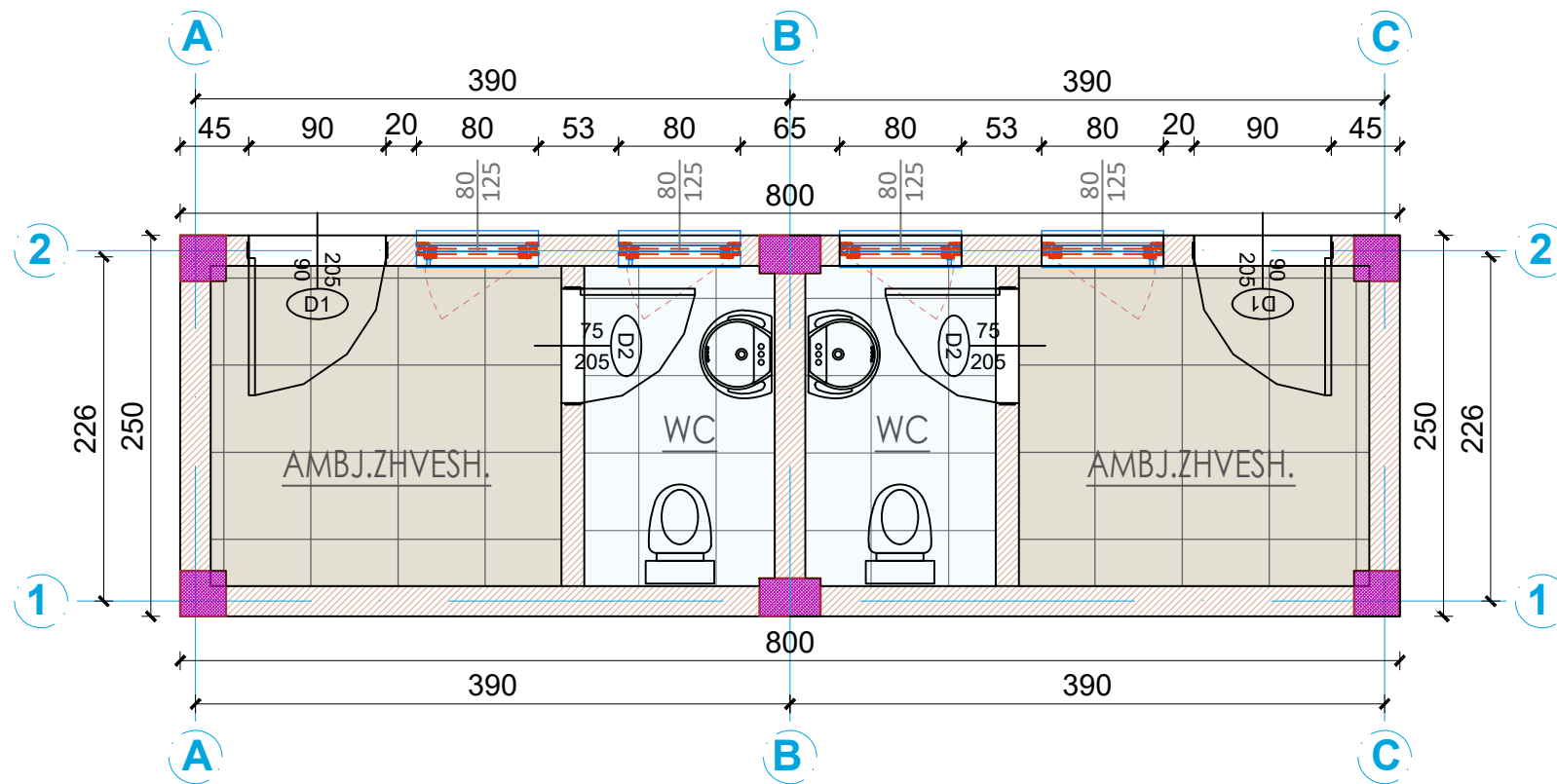

PLANIMETRIA TEKNIKE

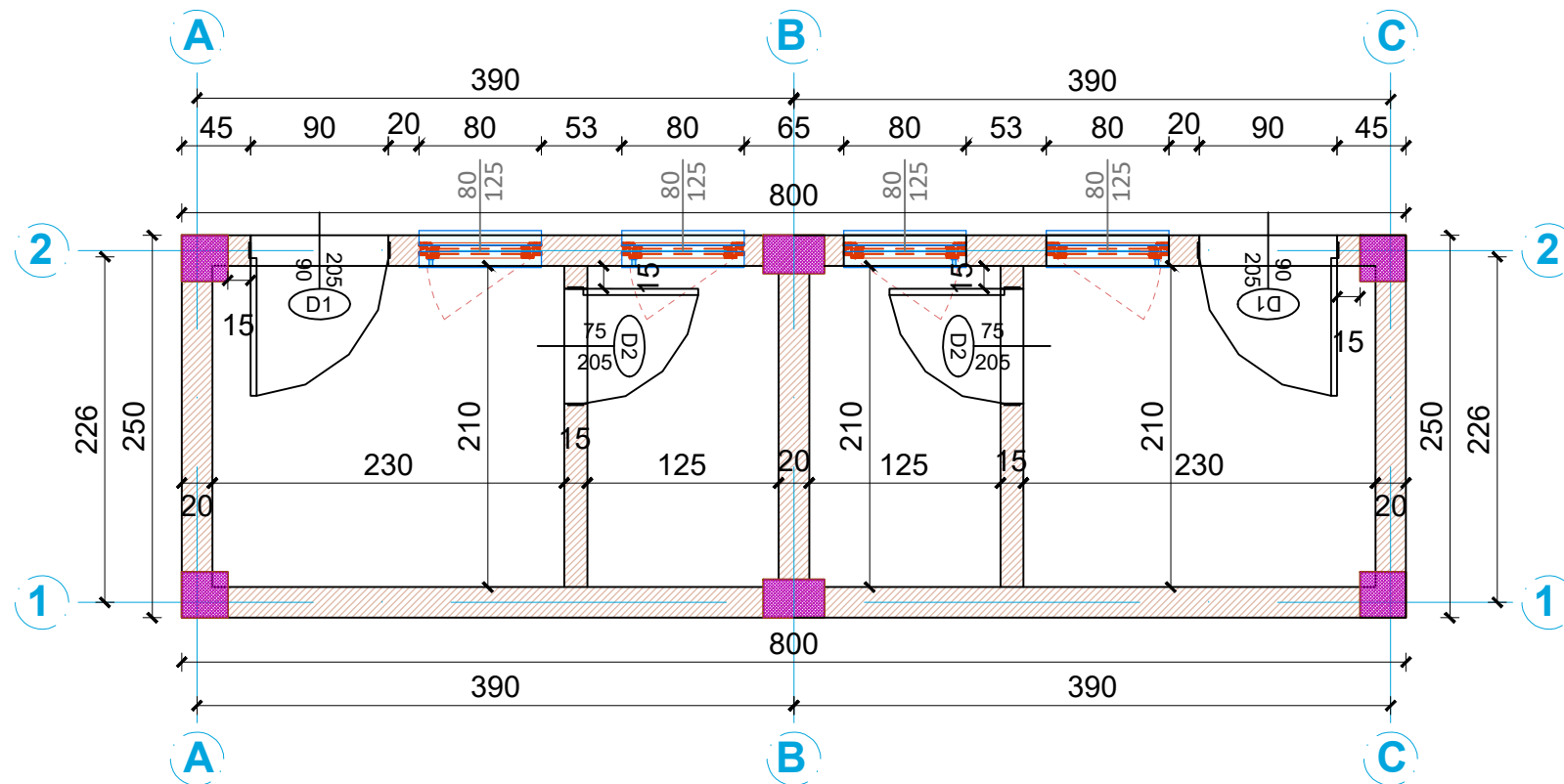

BASHKIA CERRIK



**ZetaKonsult sh.p.k**

Address:Rr."Myrteza Topi",Nd 18, Hyrja 7, Ap 38, TIRANE

Cel: +355 (0)69 33 52 077

e-mail:zetakonsultshpk@gmail.com



**EMERTIMI I OBJEKTIT:**

NDERTIM I SHESHIT REKREATIV SHTERMEN, BASHKIA CERRIK

FAZA E PROJEKTIT :PROJEKT ZBATIMI

**EMERTESA E FLETES**

Planimetria e dhomave te zhveshjes

SHKALLA Shk:1/50

FLETA 44

**GRUPI I PROJEKTIMIT:**

Inxh. Ndert.Lorenc HOXHA  
Inxh.Ndert.Flutura Duro

Dt10/09/2024

FORMATI A3

# Fasada ballore e dhomave te zhveshjes SH 1:50

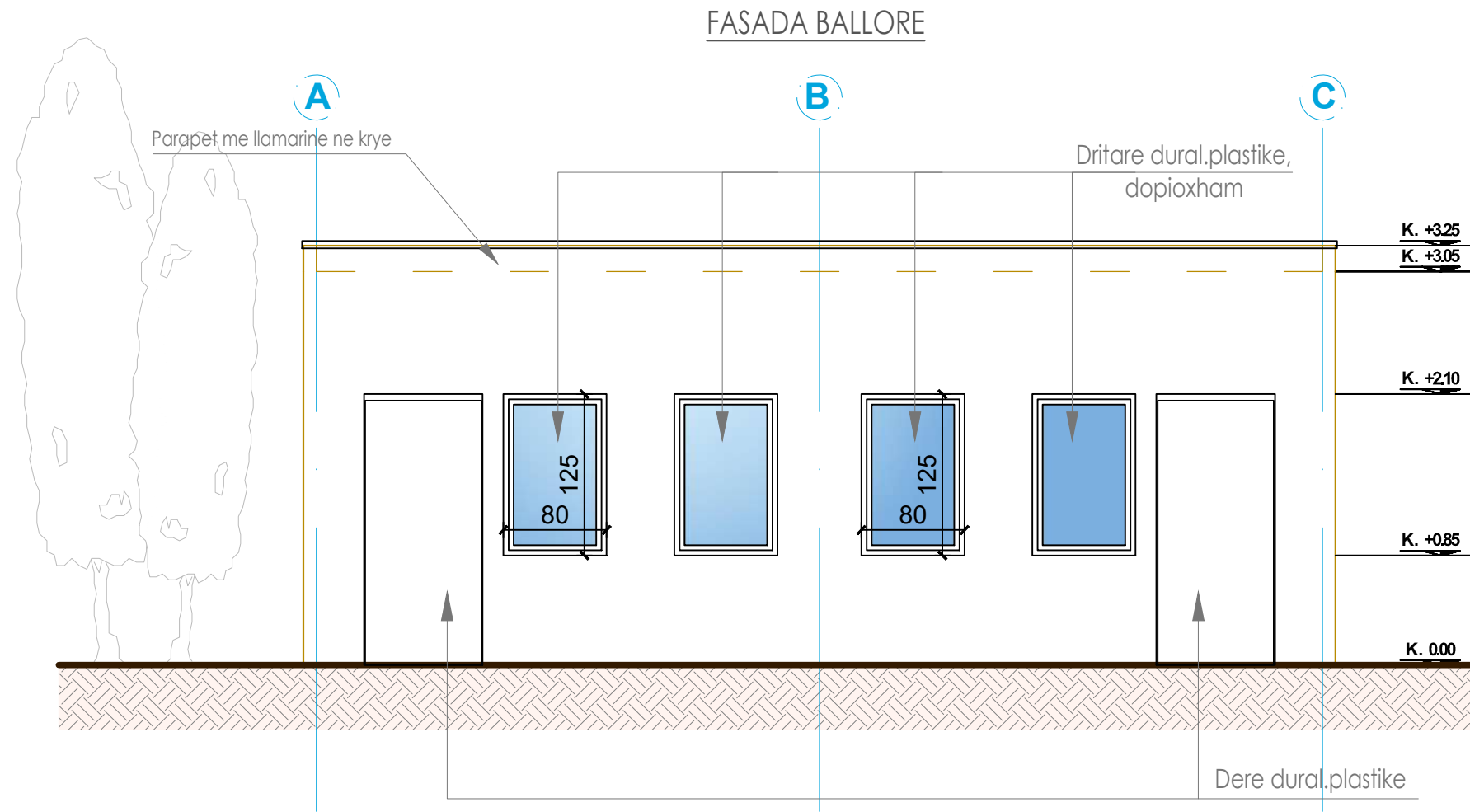

BASHKIA CERRIK



**ZetaKonsult sh.p.k**

Address:Rr."Myrteza Topi",Nd 18, Hyrja 7, Ap 38, TIRANE

Cel: +355 (0)69 33 52 077

e-mail:zetakonsultshpk@gmail.com



**EMERTIMI I OBJEKTIT:**  
NDERTIM I SHESHIT REKREATIV SHTERMEN, BASHKIA  
CERRIK

FAZA E PROJEKTIT :PROJEKT ZBATIMI

**EMERTESA E FLETES**  
Fasada ballore e dhomave te zhveshjes

SHKALLA Shk:1/50

FLETA 45

**GRUPI I PROJEKTIMIT:**

Inxh. Ndert.Lorenc HOXHA  
Inxh.Ndert.Flutura Duro

Dt10/09/2024

FORMATI A3

# Plani i shkarkimeve dhe furnizimit me uje per dhomat e zhveshjes SH 1:75



PLANIMETRIA E F.U

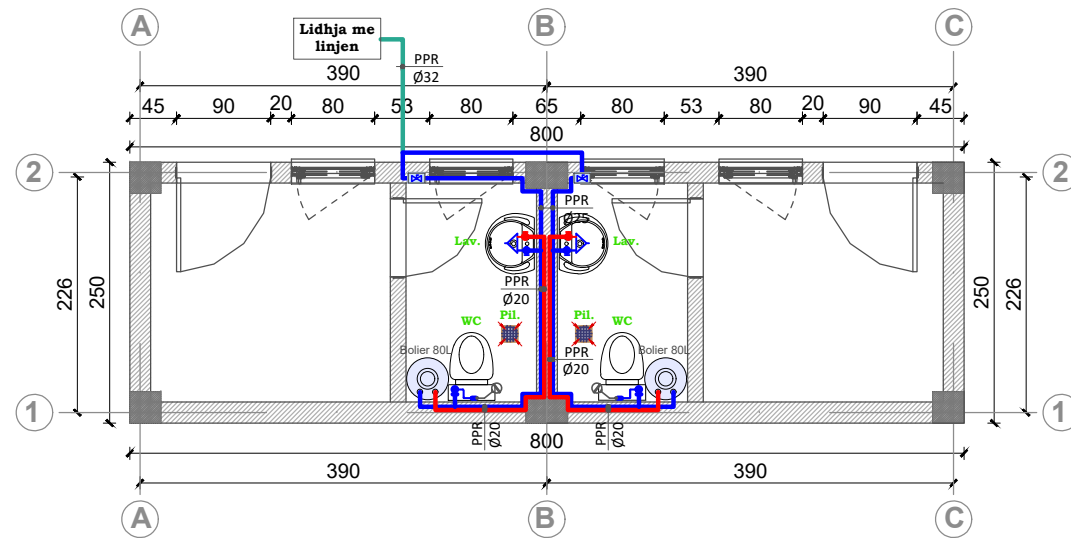

PLANIMETRIA E SHKARKIMEVE

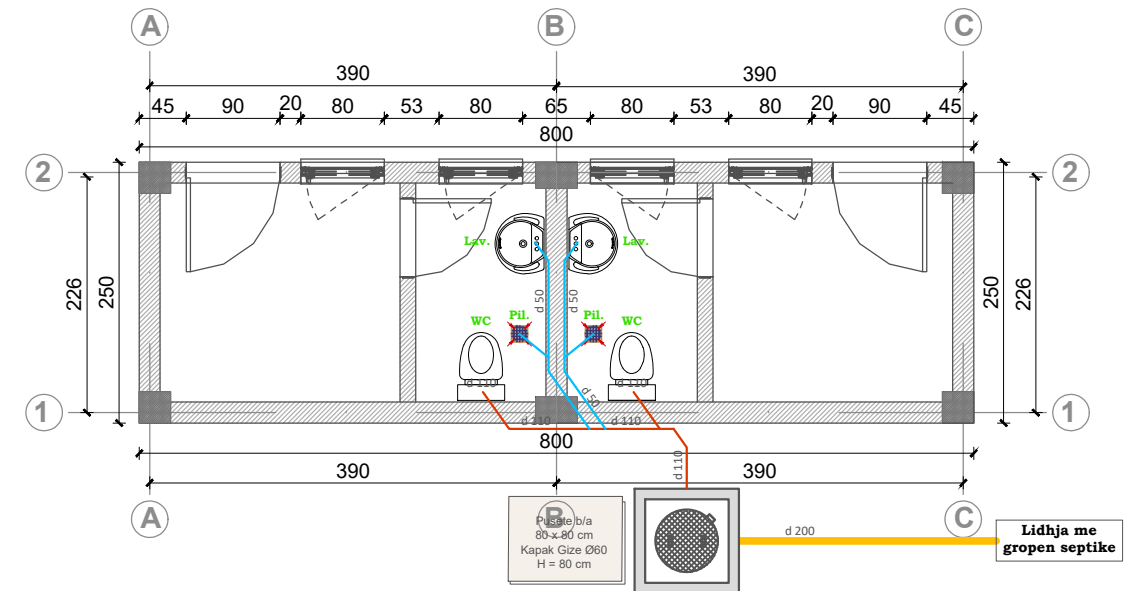

**LEGJENDA**

- LINJA E FURNIZIMIT ME UJE TE FTOHTE
- LINJA E FURNIZIMIT ME UJE TE NGROHTE
- VALVOL ON/OFF
- MISHELATOR
- GALEXHANT
- VALVOL ME SFERE

**LEGJENDA**

- TUB SHKARKIMI I UJRAVE TE ZEZA TE JASHTME
- TUB SHKARKIMI I UJRAVE TE ZEZA TE BRENDSHME Ø110
- TUB SHKARKIMI I UJRAVE TE ZEZA TE BRENDSHME Ø40-75
- PUSETE SHKARKIMI TE UJRAVE TE ZEZA
- PILETE DYSHEMEJE
- HIDROSANITARE (WC, LAVAMAN)

BASHKIA CERRIK



**ZetaKonsult sh.p.k**

Address:Rr."Myrteza Topi",Nd 18, Hyrja 7, Ap 38, TIRANE  
 Cel:+355 (0)69 33 52 077  
 e-mail:zetakonsultshpk@gmail.com



**EMERTIMI I OBJEKTIT:**

NDERTIM I SHESHIT REKREATIV SHTERMEN,BASHKIA CERRIK

FAZA E PROJEKTIT :PROJEKT ZBATIMI

**EMERTESA E FLETES**

Plani i shkarkimeve dhe furnizimit me uje per dhomat e zhveshjes

SHKALLA Shk:1/75

FLETA 46

**GRUPI I PROJEKTIMIT:**

Inxh. Ndert.Lorenc HOXHA  
 Inxh.Ndert.Flutura Duro

Dt10/09/2024

FORMATI A3

# Planimetria e ndricimit dhe prizave per dhomat e zhveshjes SH 1:75



PLANIMETRIA E NDRICIMIT

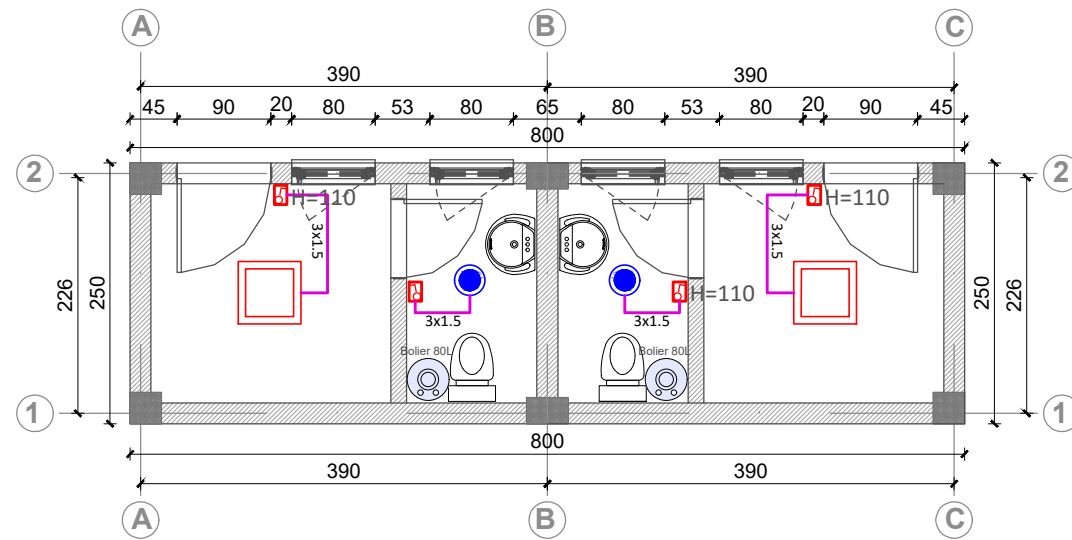

PLANIMETRIA E PRIZAVE/FUQISE

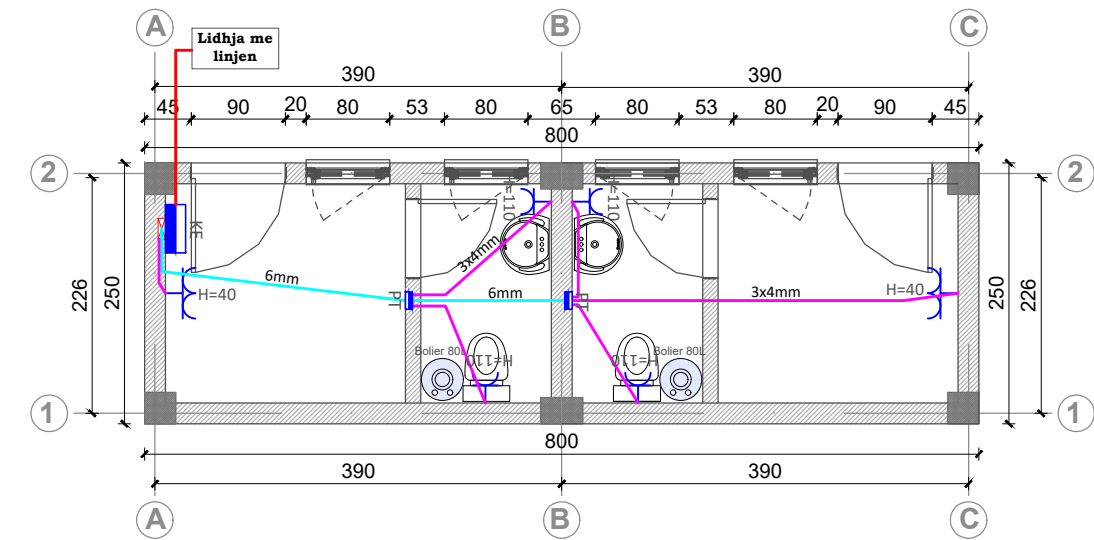

**LEGJENDA**

- Celes ndricimi
- Ndricules LED 60x60cm
- Ndricules LED spot
- Percjelles bakri 1.5mm, i instaluar ne tub plastik Ø.25mm
- Percjelles 4 mm i instaluar ne tub plastik Ø.25mm
- Percjelles 6mm i instaluar ne tub plastik Ø.32mm
- Kablo per furnizim nga rrjeti, futur ne toke ne tub

**LEGJENDA**

- Prizë shuko universale 16A, 230V, me ushqim nga rrjeti, instaluar ne kuti plastike 3-module
- Prizë shuko dyshe 230V,16A, me ushqim nga rrjeti, instaluar ne kuti plastike 4-module
- Panel/Kuader Elektrik
- Kuti shpendarese PT, brenda murit
- Percjelles bakri 1.5mm, i instaluar ne tub plastik Ø.25mm
- Percjelles 4 mm i instaluar ne tub plastik Ø.25mm
- Percjelles 6mm i instaluar ne tub plastik Ø.32mm
- Kablo per furnizim nga rrjeti, futur ne toke ne tub

BASHKIA CERRIK



**ZetaKonsult sh.p.k**

Address:Rr."Myrteza Topi",Nd 18, Hyrja 7, Ap 38, TIRANE  
 Cel: +355 (0)69 33 52 077  
 e-mail:zetakonsultshpk@gmail.com



**EMERTIMI I OBJEKTIT:**  
 NDERTIM I SHESHIT REKREATIV SHTERMEN, BASHKIA CERRIK

FAZA E PROJEKTIT :PROJEKT ZBATIMI

**EMERTESA E FLETES**  
 Planimetria e ndricimit dhe prizave per dhomat e zhveshjes

SHKALLA Shk:1/75

FLETA 47

**GRUPI I PROJEKTIMIT:**

Inxh. Ndert.Lorenc HOXHA  
 Inxh.Ndert.Flutura Duro

Dt10/09/2024

FORMATI A3



# Detaje teknike per dhomat e zhveshjes SH 1:20



MUR I jashtem i tualettit  
LARTESIA E HIDROIZOLIMIT BIKOMPONENT 40CM

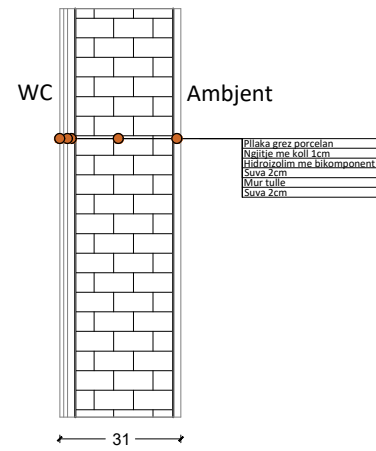

MUR I brendshem i tualettit/interior toilets wall  
LARTESIA E HIDROIZOLIMIT MR BIKOMPONENT 120CM

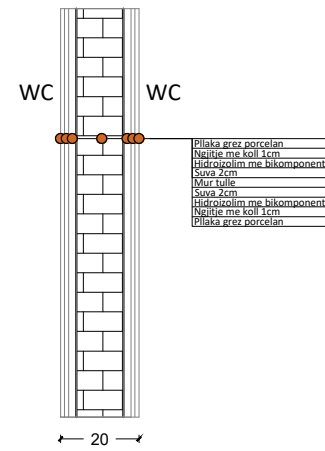

SHTRESAT E SHTRIMIT TE TUALETEVE

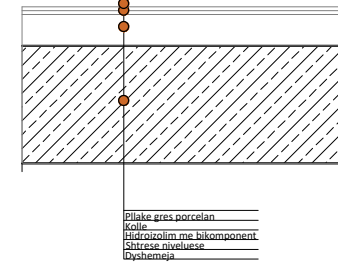

DETAJ DYSHEMEJE AMBIENTESH

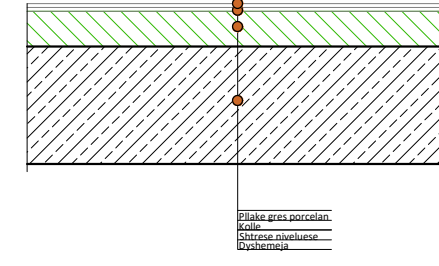

BASHKIA CERRIK



**ZetaKonsult sh.p.k**

Address:Rr."Myrteza Topi",Nd 18, Hyrja 7, Ap 38, TIRANE

Cel: +355 (0)69 33 52 077

e-mail:zetakonsultshpk@gmail.com



**EMERTIMI I OBJEKTIT:**

NDERTIM I SHESHIT REKREATIV SHTERMEN, BASHKIA CERRIK

FAZA E PROJEKTIT :PROJEKT ZBATIMI

**EMERTESA E FLETES**

Detaje teknike per dhomat e zhveshjes

SHKALLA Shk:1/20

FLETA 48

**GRUPI I PROJEKTIMIT:**

Inxh. Ndert.Lorenc HOXHA  
Inxh.Ndert.Flutura Duro

Dt10/09/2024

FORMATI A3

# Plani i themeleve per dhomat e zhveshjes SH 1:50



## PLANI I THEMELEVE, KUOTE -0.30m

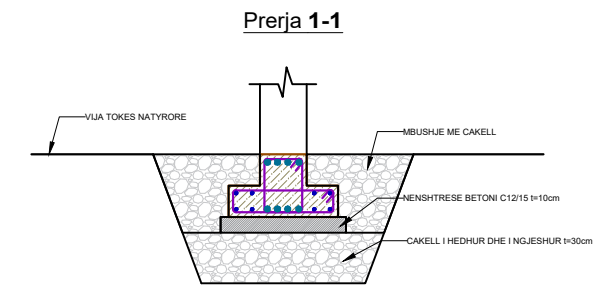
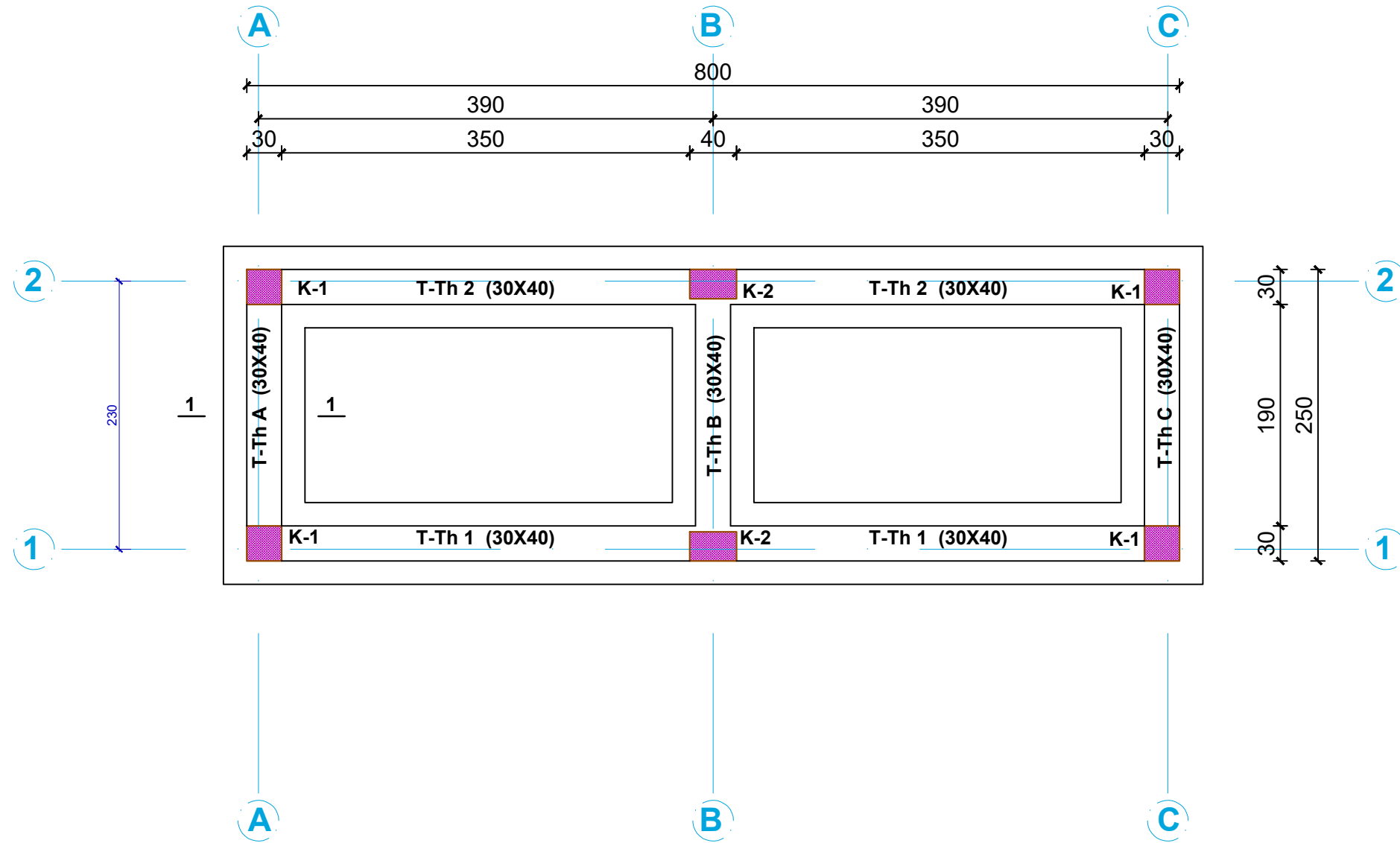

BASHKIA CERRIK



**ZetaKonsult sh.p.k**

Address: Rr. "Myrteza Topi", Nd 18, Hyrja 7, Ap 38, TIRANE  
 Cel: +355 (0)69 33 52 077  
 e-mail: zetakonsultshpk@gmail.com



**EMERTIMI I OBJEKTIT:**  
 NDERTIM I SHESHIT REKREATIV SHTERMEN, BASHKIA CERRIK

FAZA E PROJEKTIT : PROJEKT ZBATIMI

**EMERTESA E FLETES**  
 Plani i themeleve per dhomat e zhveshjes

SHKALLA Shk: 1/50

FLETA 49

**GRUPI I PROJEKTIMIT:**

Inxh. Ndert. Lorenc HOXHA  
 Inxh. Ndert. Flutura Duro

Dt 10/09/2024

FORMATI A3



**PLANI I STRUKTURAVE, KUOTE +3.05m**

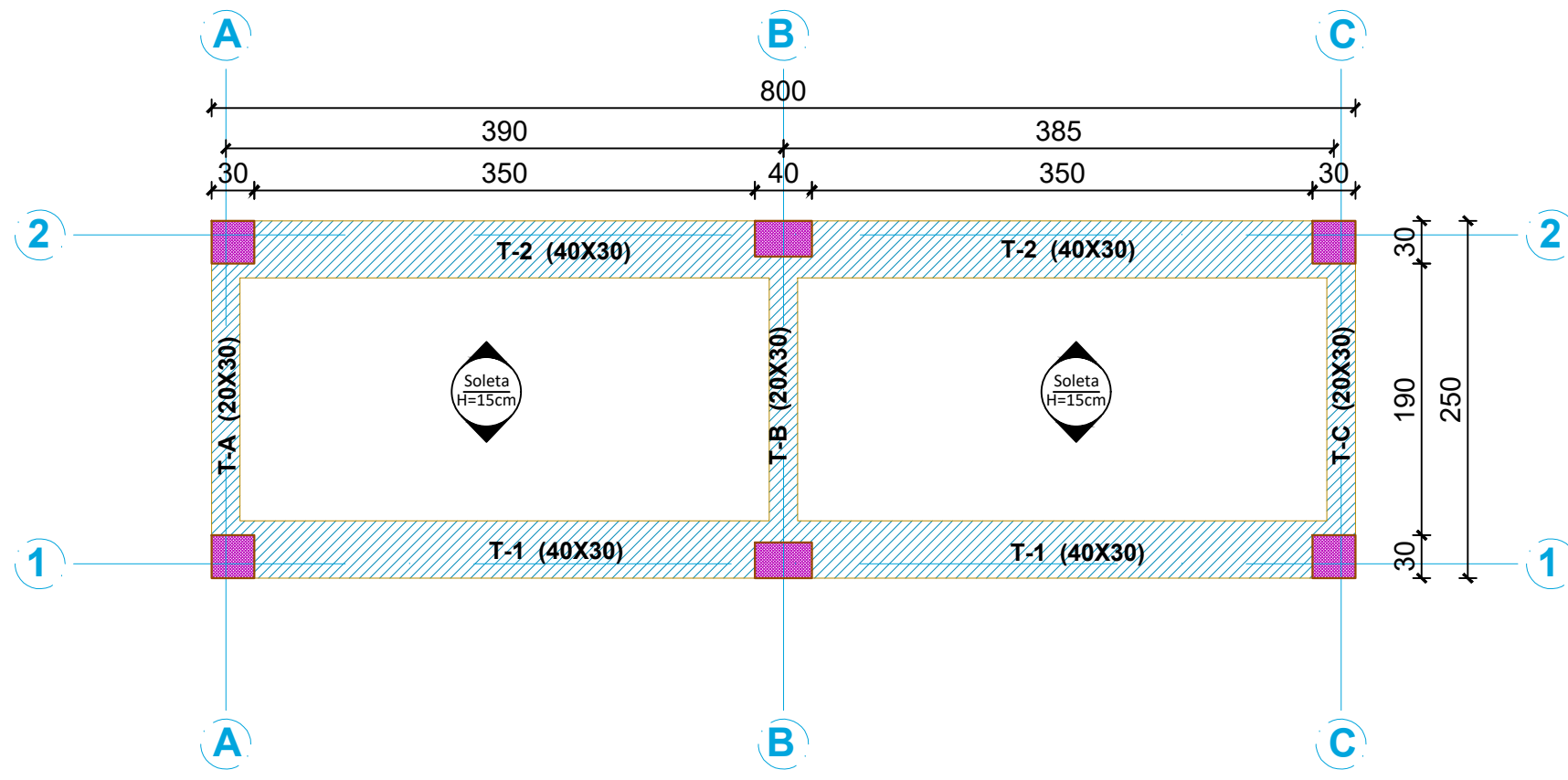

BASHKIA CERRIK



**ZetaKonsult sh.p.k**

Address:Rr."Myrteza Topi",Nd 18, Hyrja 7, Ap 38, TIRANE  
 Cel: +355 (0)69 33 52 077  
 e-mail:zetakonsultshpk@gmail.com



**EMERTIMI I OBJEKTIT:**

NDERTIM I SHESHIT REKREATIV SHTERMEN, BASHKIA CERRIK

FAZA E PROJEKTIT :PROJEKT ZBATIMI

**EMERTESA E FLETES**

Plani i strukturave per dhomat e zhveshjes

SHKALLA Shk:1/50

FLETA 50

**GRUPI I PROJEKTIMIT:**

Inxh. Ndert.Lorenc HOXHA  
 Inxh.Ndert.Flutura Duro

Dt10/09/2024

FORMATI A3

PRERJE GJATESORE E  
TRAUT TE THEMELIT T-TH 1 & T-TH 2

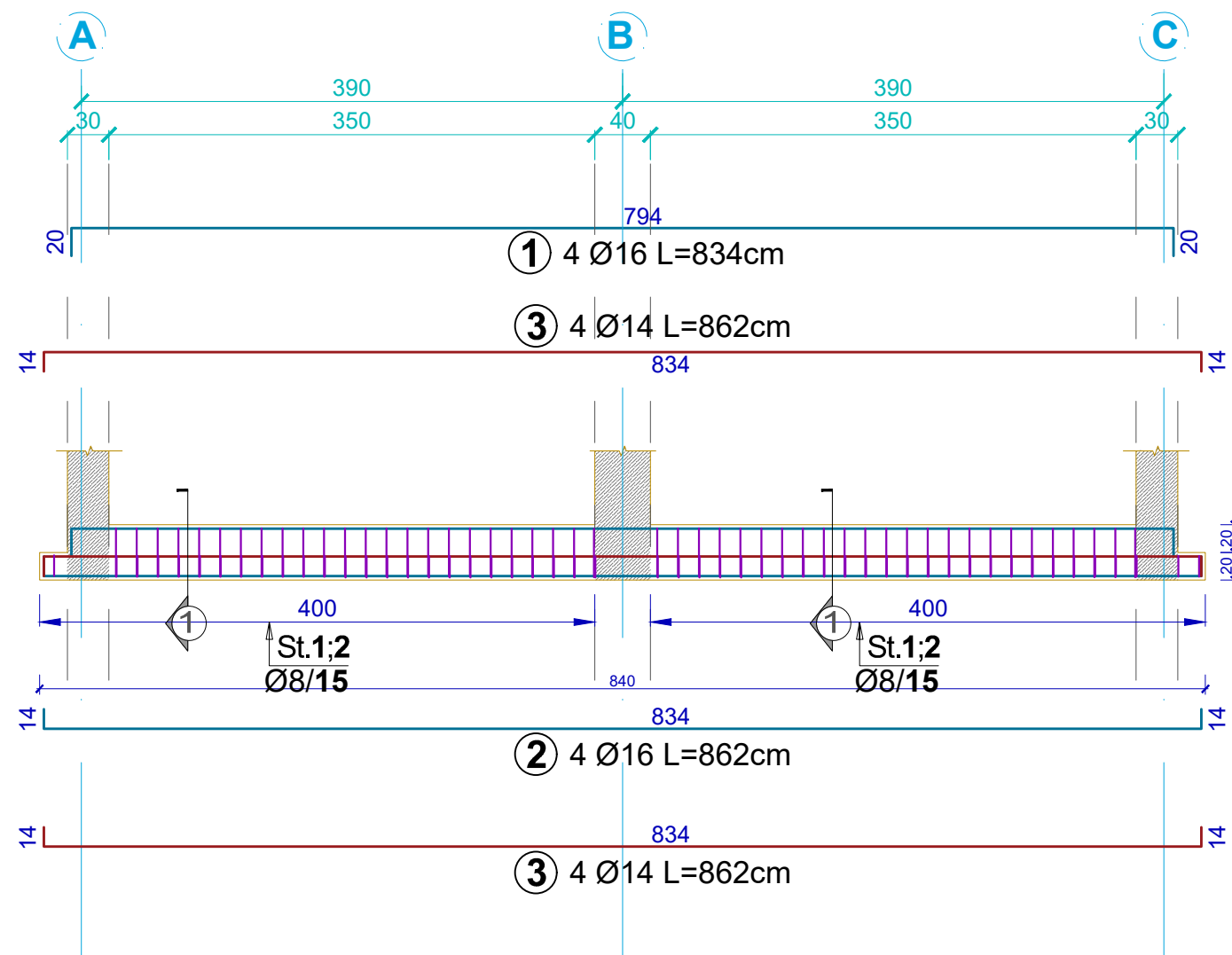

PRERJE TERTHORE

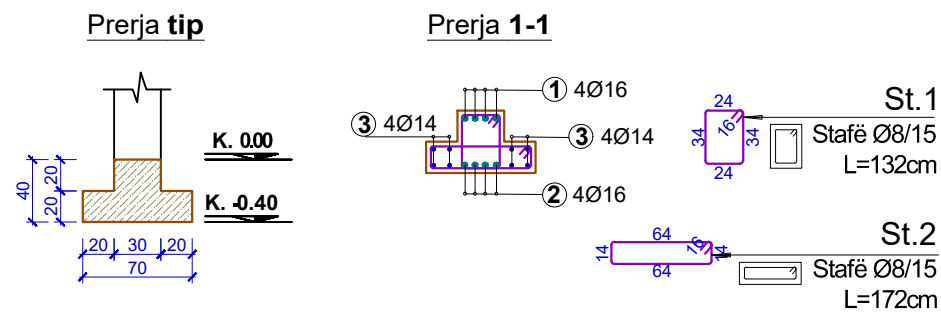

BASHKIA CERRIK



ZetaKonsult sh.p.k

Address:Rr."Myrteza Topi",Nd 18, Hyrja 7, Ap 38, TIRANE  
Cel: +355 (0)69 33 52 077  
e-mail:zetakonsultshpk@gmail.com



EMERTIMI I OBJEKTIT:  
NDERTIM I SHESHIT REKREATIV SHTERMEN, BASHKIA  
CERRIK

FAZA E PROJEKTIT :PROJEKT ZBATIMI

EMERTESA E FLETES  
Prerja gjatesore e traut te themelit per  
dhomat e zhveshjes

SHKALLA Shk:1/50

FLETA 51

GRUPI I PROJEKTIMIT:

Inxh. Ndert.Lorenc HOXHA  
Inxh.Ndert.Flutura Duro

Dt10/09/2024

FORMATI A3



**PRERJE GJATESORE E TRAUT T-1 & T-2**

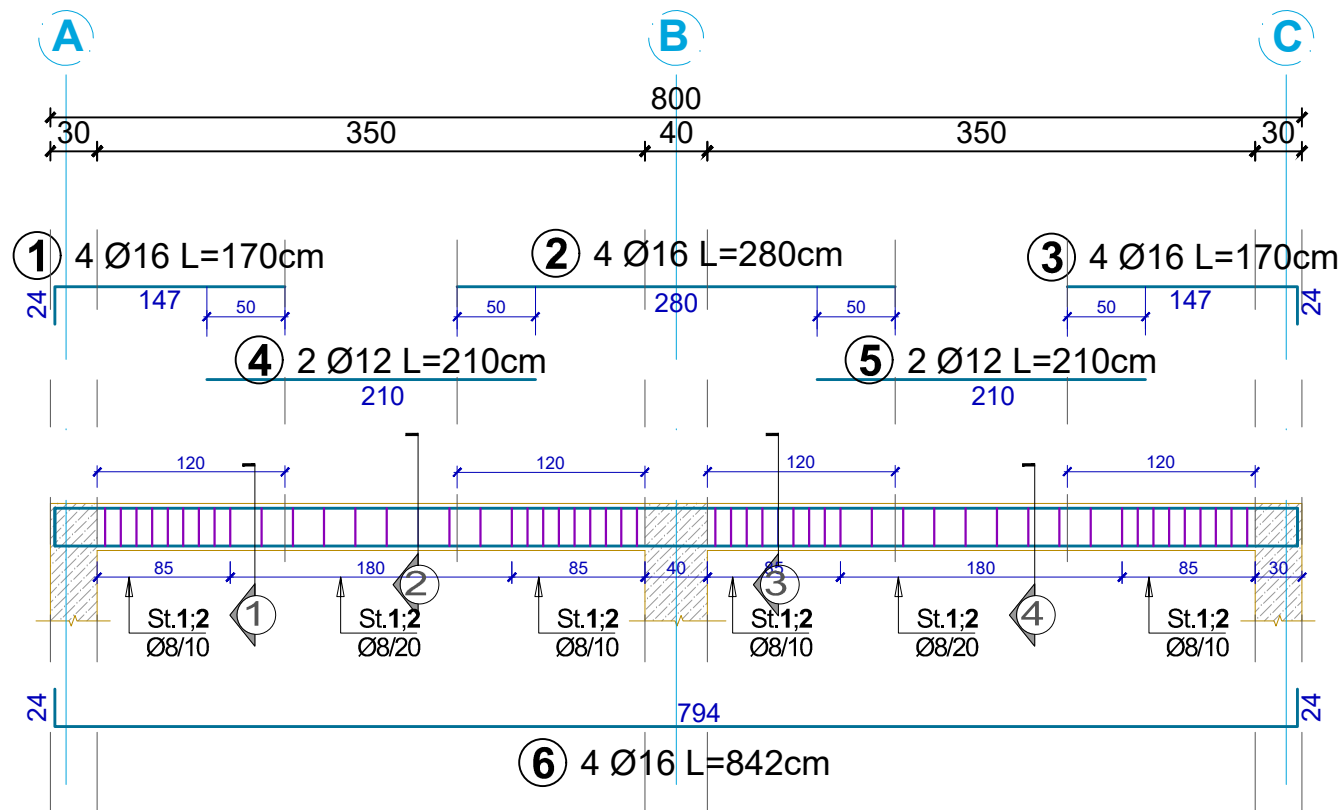

**PRERJE GJATESORE E TRAUT T-A, T-B, T-C**

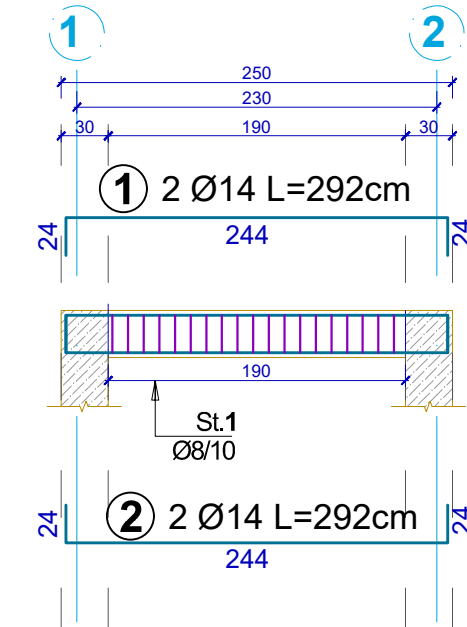

**PRERJE TERTHORE**

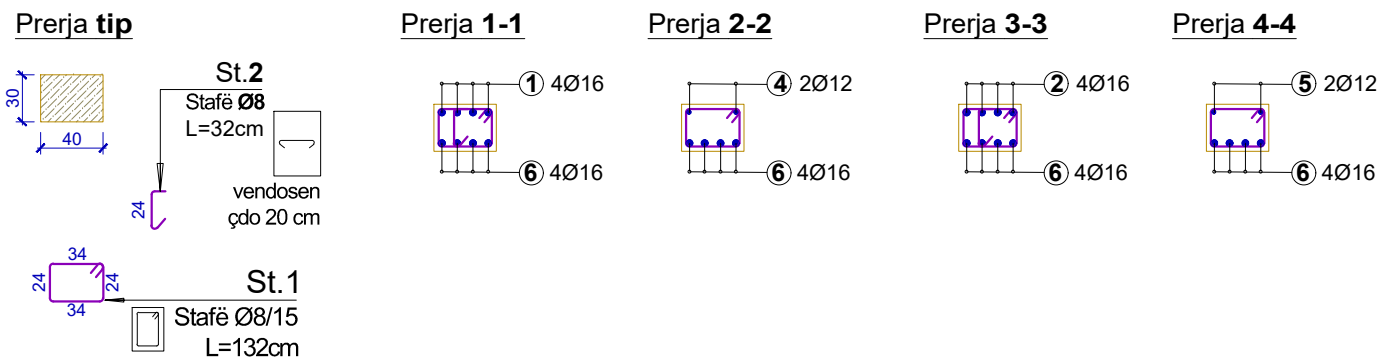

**PRERJE TERTHORE**





**PRERJE GJATESORE E TRAUT TE THEMELIT  
T-TH A & T-TH B & T-TH C**

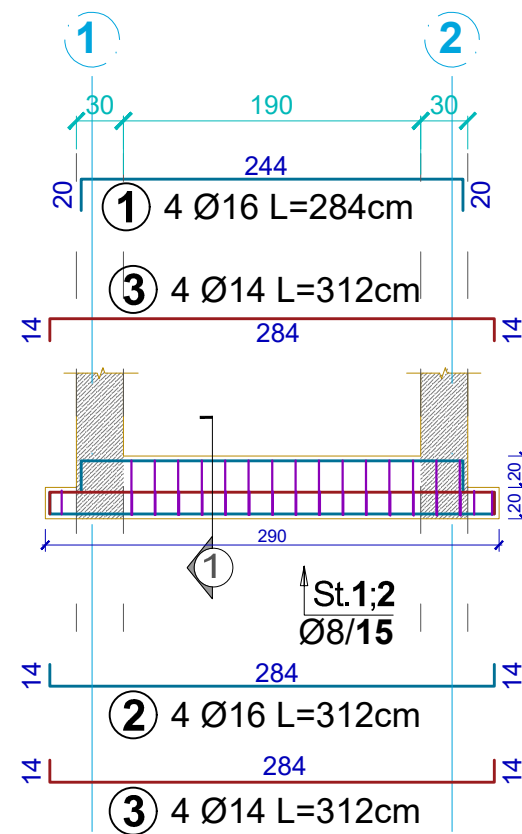

**PRERJE TERTHORE**

Prerja tip

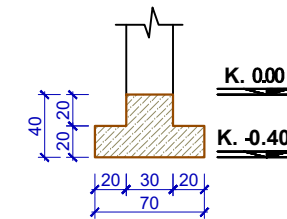

Prerja 1-1

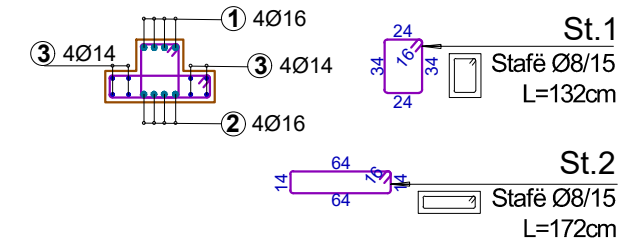



**KONSTRUIMI I SOLETES, KUOTE +3.05m**

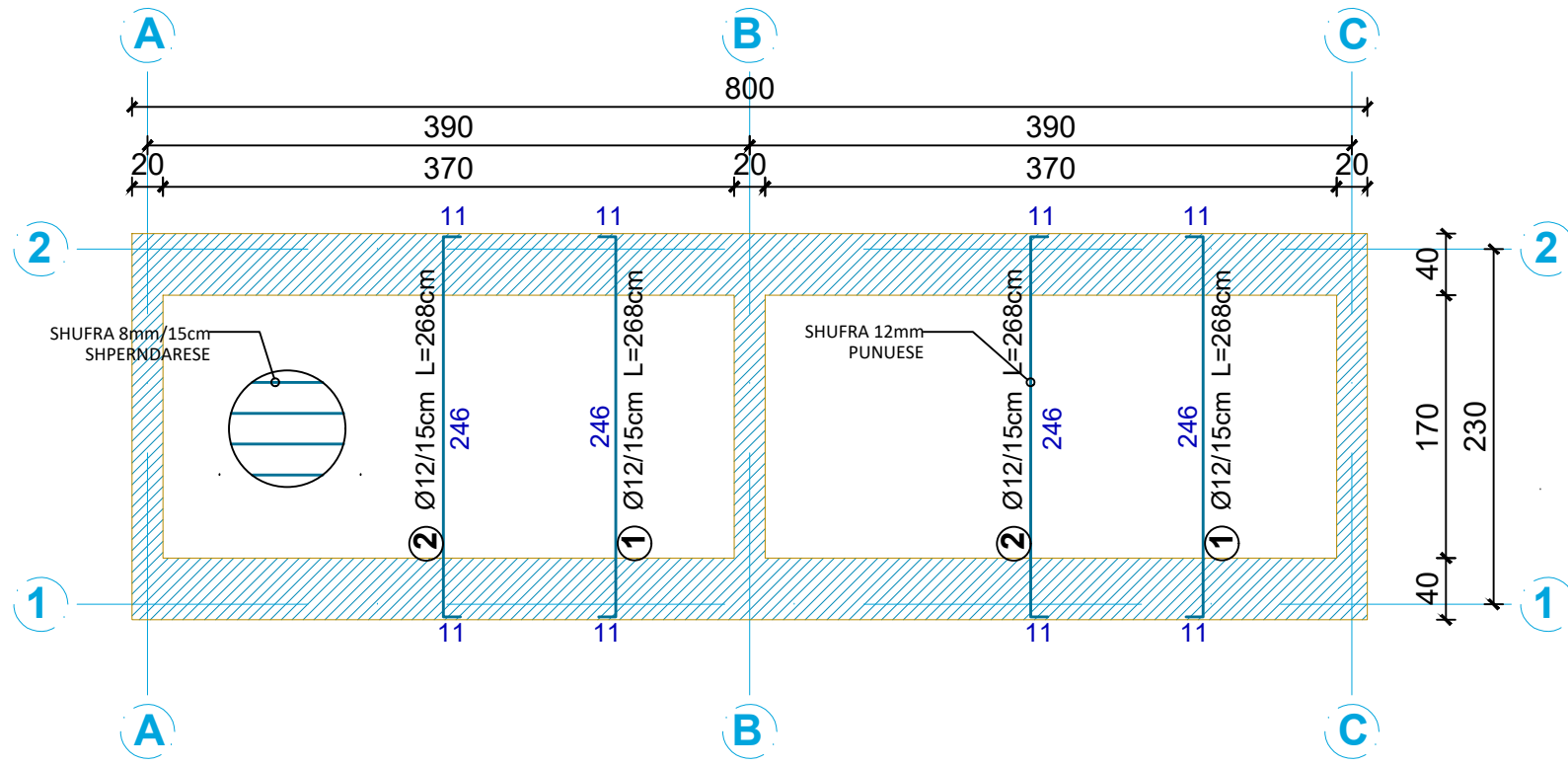

*Detaj i elementeve te thelle te planit te shtrukurave*

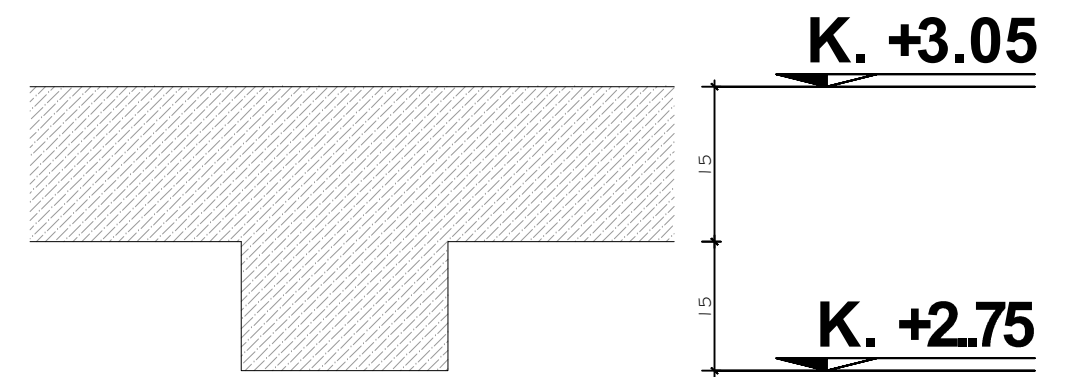

**PRERJE E GODINES**

BASHKIA CERRIK



**ZetaKonsult sh.p.k**

Address:Rr."Myrteza Topi",Nd 18, Hyrja 7, Ap 38, TIRANE  
 Cel: +355 (0)69 33 52 077  
 e-mail:zetakonsultshpk@gmail.com



**EMERTIMI I OBJEKTIT:**

NDERTIM I SHESHIT REKREATIV SHTERMEN, BASHKIA CERRIK

FAZA E PROJEKTIT :PROJEKT ZBATIMI

**EMERTESA E FLETES**

Konstruimi i soletes dhe detaje teknike per dhomat e zhveshjes

SHKALLA Shk:1/50

FLETA 54

**GRUPI I PROJEKTIMIT:**

Inxh. Ndert.Lorenc HOXHA  
 Inxh.Ndert.Flutura Duro

Dt10/09/2024

FORMATI A3



PRERJE E GODINES

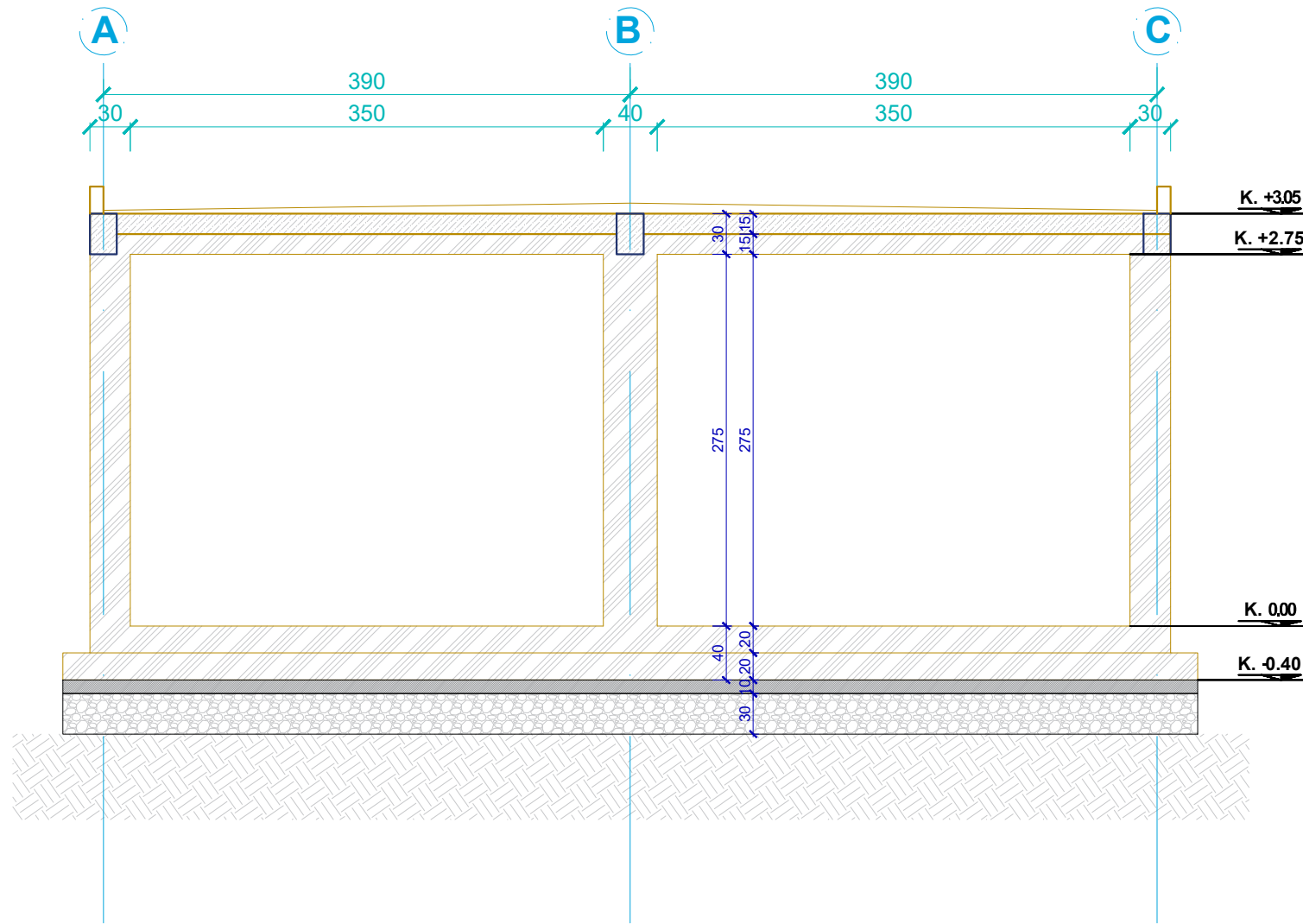

PRERJE E PARAPETIT B/A

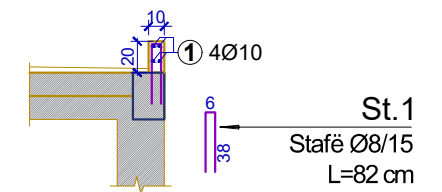





## PRERJE E KOLLONES K-1 (30x30) 4 COPE

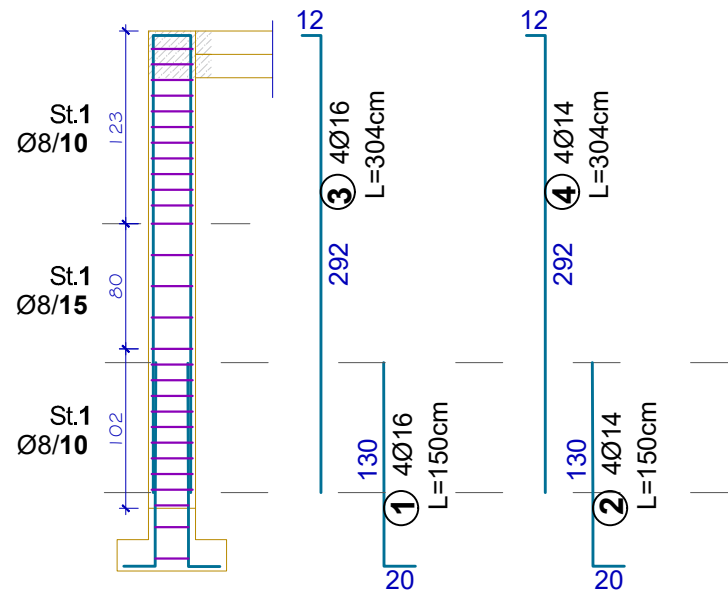

## PRERJE E KOLLONES K-2 (25x40) 4 COPE

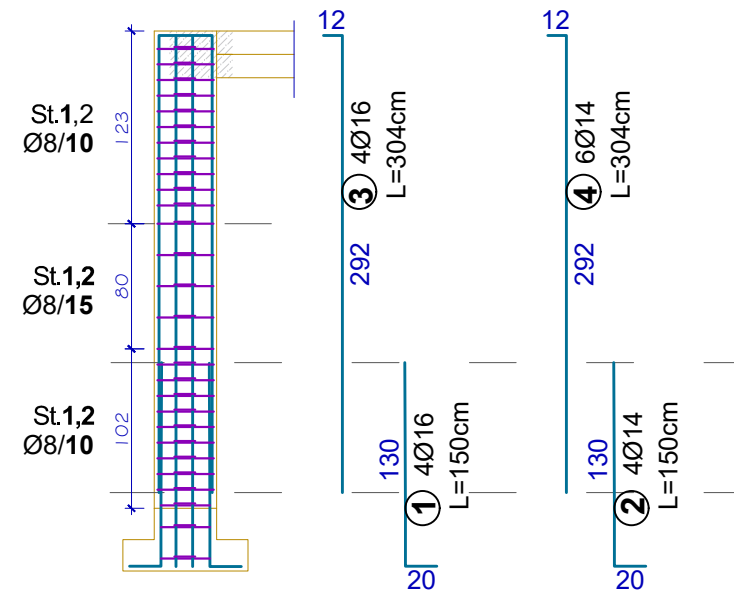

### PRERJE TERTHORE

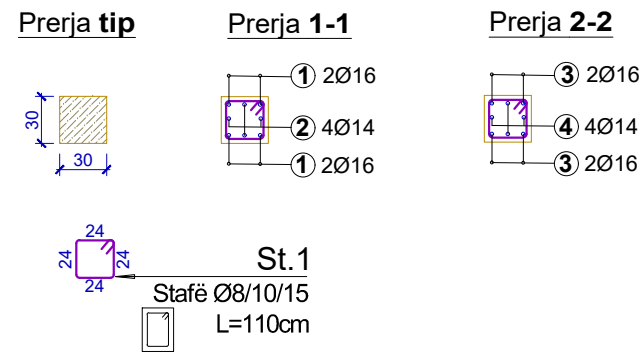

### PRERJE TERTHORE

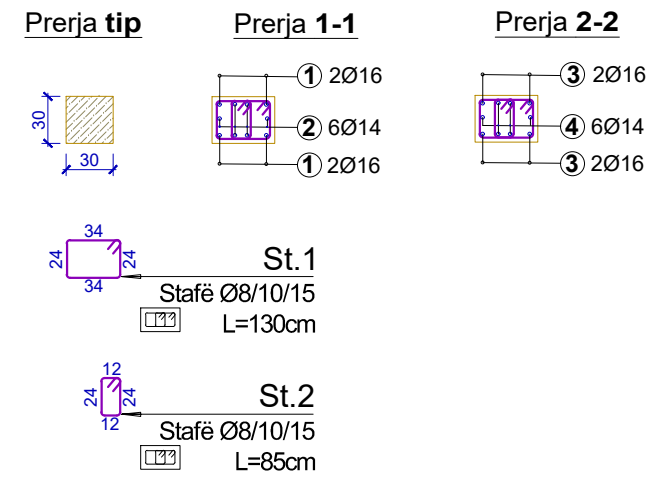

# Planimetria e dimensionuar teknike e fushes SH 1:100

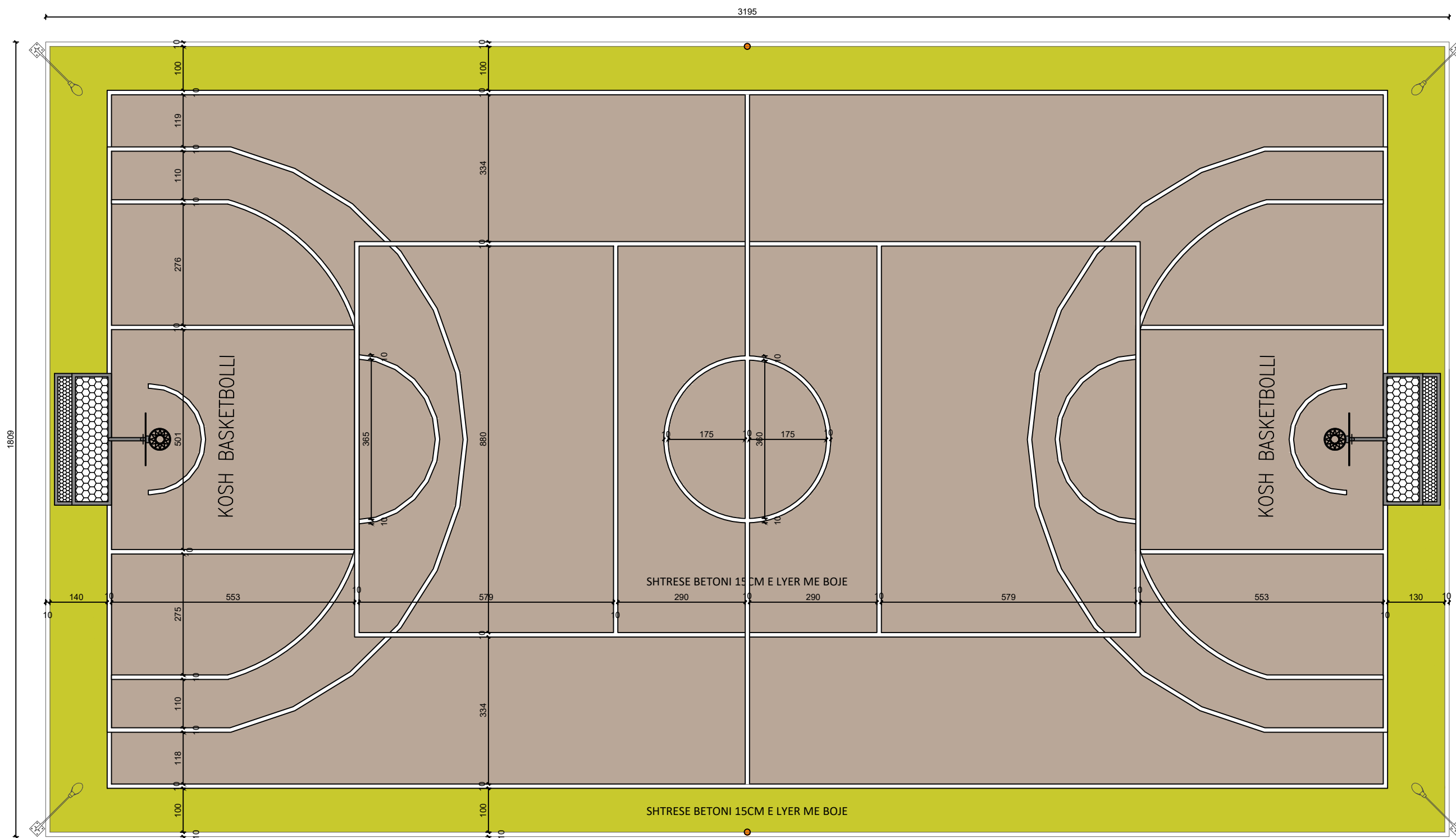

POZICION KU  
MUND TE  
VENDOSSET  
RRJETE

BASHKIA CERRIK



ZetaKonsult sh.p.k

Address:Rr."Myrteza Topi",Nd 18, Hyrja 7, Ap 38, TIRANE

Cel:+355 (0)69 33 52 077

e-mail:zetakonsultshpk@gmail.com



EMERTIMI I OBJEKTIT:

NDERTIM I SHESHIT REKREATIV SHTERMEN,BASHKIA CERRIK

FAZA E PROJEKTIT :PROJEKT ZBATIMI

EMERTESA E FLETES

Planimetria e dimensionuar teknike e fushes

SHKALLA Shk:1/100

FLETA 57

GRUPI I PROJEKTIMIT:

Inxh. Ndert.Lorenc HOXHA  
Inxh.Ndert.Flutura Duro

Dt10/09/2024

FORMATI A3

# Prerja dhe detaje teknike te fushes SH 1:100

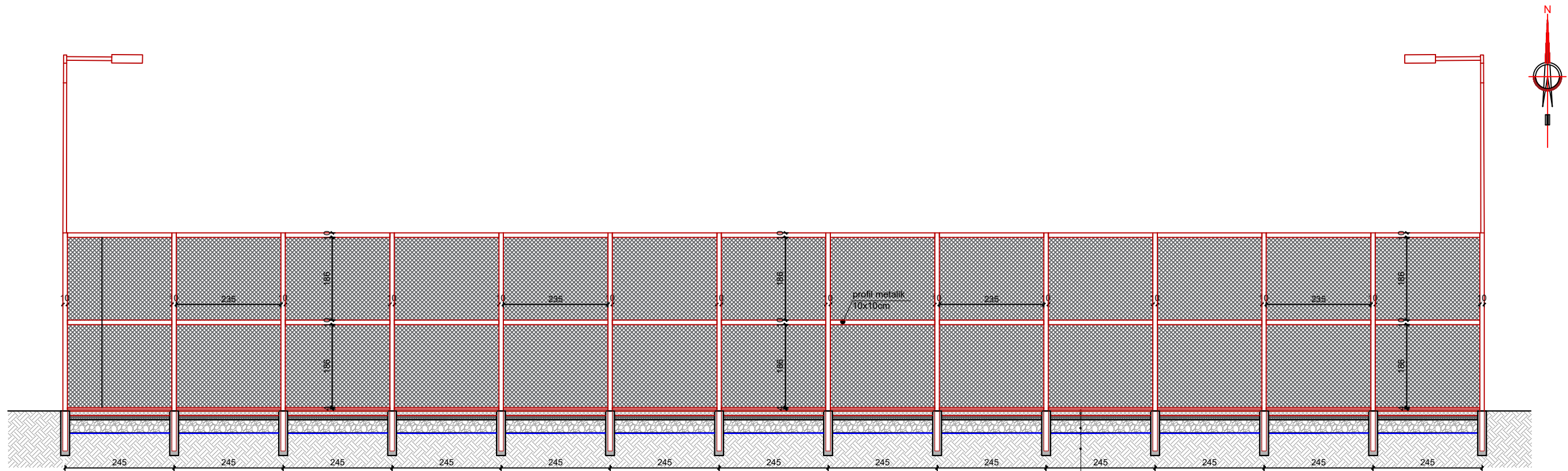

Shtrese betoni industrial me trajtim me  
helikopter, boje, puder/cim., kuarc, etj 10cm  
Nenshtrese betoni C16/20 me zgare  
hekuri (15cm)  
stabilizant (10cm)  
zhavor/cakell (20cm)  
Toke natyrale

DETAJI 1 - RRETHIMI I FUSHES

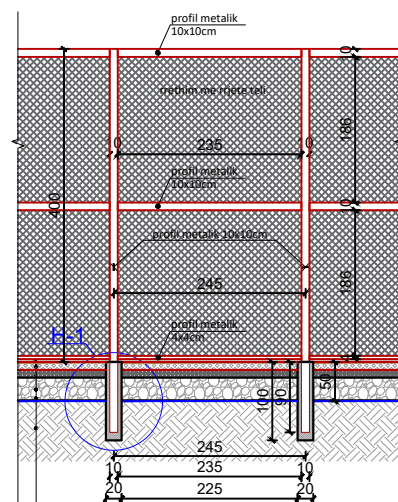

Shtrese betoni industrial me trajtim me  
helikopter, boje, puder/cim., kuarc, etj 10cm  
Shtrese betoni C20/25 me zgare  
hekuri (15cm)  
stabilizant (10cm)  
zhavor/cakell (20cm)  
Toke natyrale

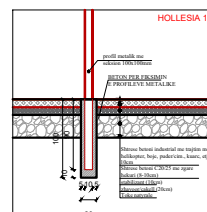
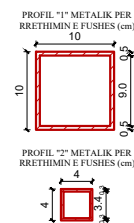

BASHKIA CERRIK



ZetaKonsult sh.p.k

Address: Rr. "Myrteza Topi", Nd 18, Hyrja 7, Ap 38, TIRANE

Cel: +355 (0)69 33 52 077

e-mail: zetakonsultshpk@gmail.com



EMERTIMI I OBJEKTIT:  
NDERTIM I SHESHIT REKREATIV SHTERMEN, BASHKIA  
CERRIK

FAZA E PROJEKTIT : PROJEKT ZBATIMI

EMERTESA E FLETES  
Prerja dhe detaje teknike te te fushes

SHKALLA Shk: 1/100

FLETA 58

GRUPI I PROJEKTIMIT:

Inxh. Ndert. Lorenc HOXHA  
Inxh. Ndert. Flutura Duro

Dt 10/09/2024

FORMATI A3

# Planimetria e fushes SH 1:100

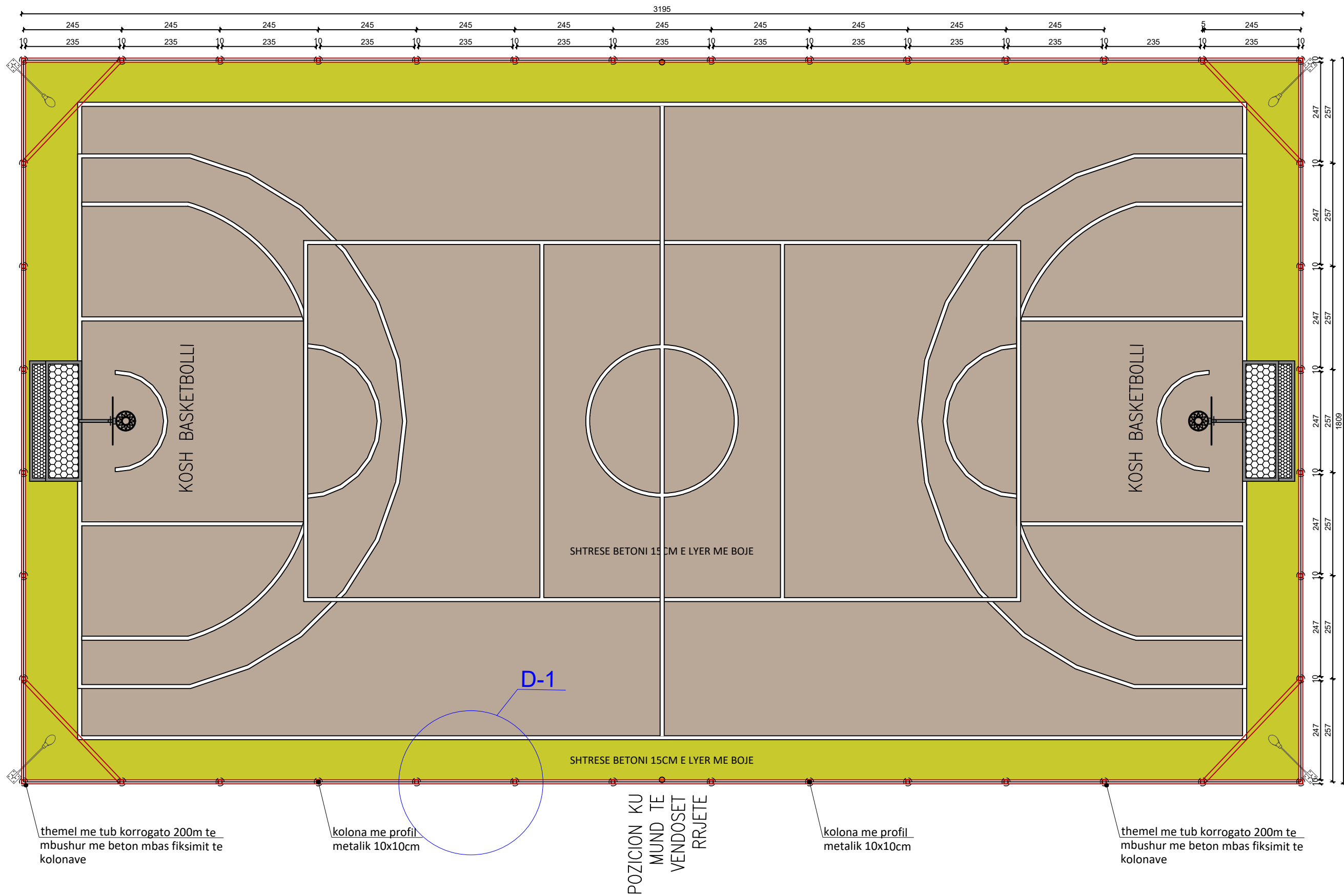

**BASHKIA CERRIK**

**ZetaKonsult sh.p.k**  
 Address: Rr. "Myrteza Topi", Nd 18, Hyrja 7, Ap 38, TIRANE  
 Cel: +355 (0)69 33 52 077  
 e-mail: zetakonsultshpk@gmail.com

**EMERTIMI I OBJEKTIT:**  
 NDERTIM I SHESHIT REKREATIV SHTERMEN, BASHKIA CERRIK

**FAZA E PROJEKTIT:** PROJEKT ZBATIMI

**EMERTESA E FLETES**  
 Planimetria e fushes

**SHKALLA** Shk: 1/100      **FLETA** 59

**GRUPI I PROJEKTIMIT:**  
 Inxh. Ndert. Lorenc HOXHHA  
 Inxh. Ndert. Flutura Duro

Dt 10/09/2024

**FORMATI A3**

# Plani i dyshemese dhe detaje teknike per vendosjen e gabines SH 1:50

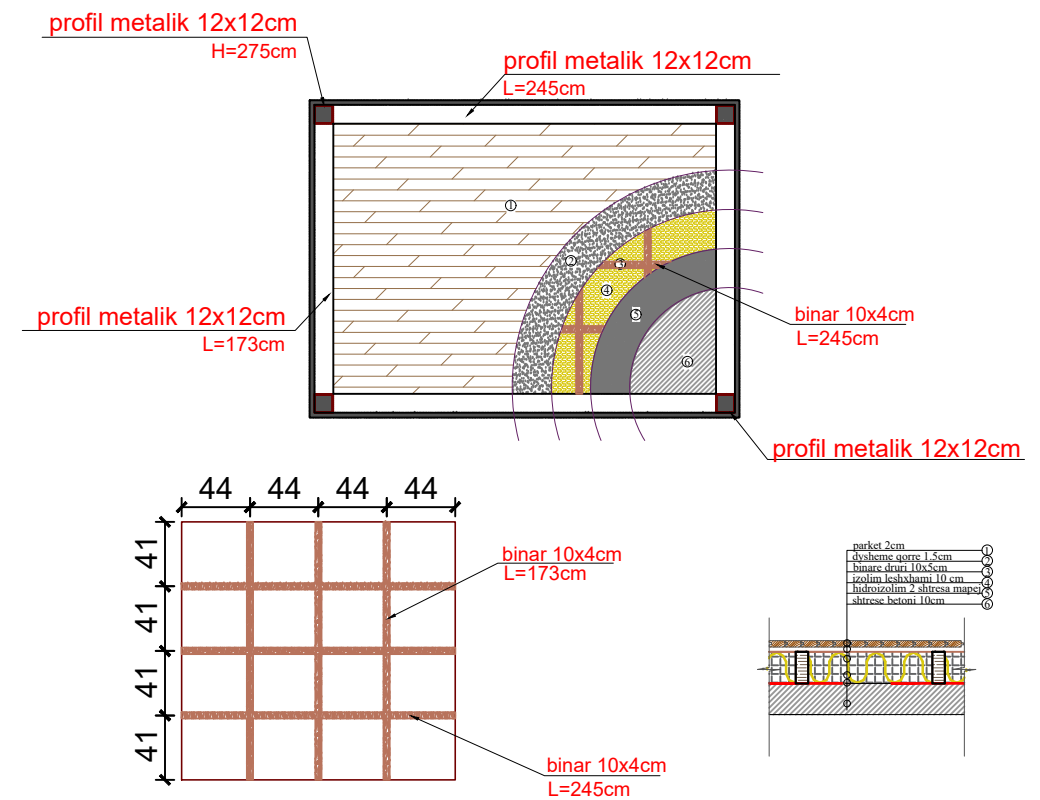
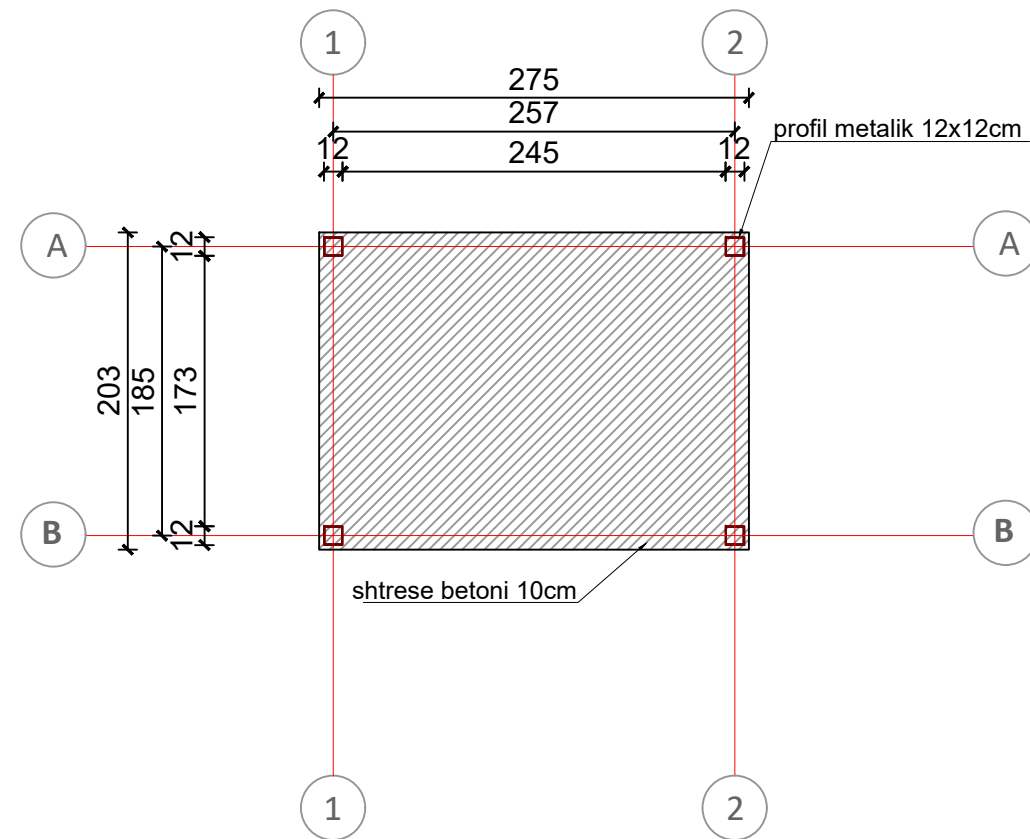

BASHKIA CERRIK



**ZetaKonsult sh.p.k**

Address: Rr. "Myrteza Topi", Nd 18, Hyrja 7, Ap 38, TIRANE  
 Cel: +355 (0)69 33 52 077  
 e-mail: zetakonsultshpk@gmail.com



**EMERTIMI I OBJEKTIT:**  
 NDERTIM I SHESHIT REKREATIV SHTERMEN, BASHKIA  
 CERRIK

FAZA E PROJEKTIT : PROJEKT ZBATIMI

**EMERTESA E FLETES**  
 Plani i dyshemese dhe detaje teknike per  
 vendosjes e gabines

SHKALLA Shk: 1/50

FLETA 60

**GRUPI I PROJEKTIMIT:**

Inxh. Ndert. Lorenc HOXHA  
 Inxh. Ndert. Flutura Duro

Dt 10/09/2024

FORMATI A3

# Planimetria e dimensionuar e gabines SH 1:30

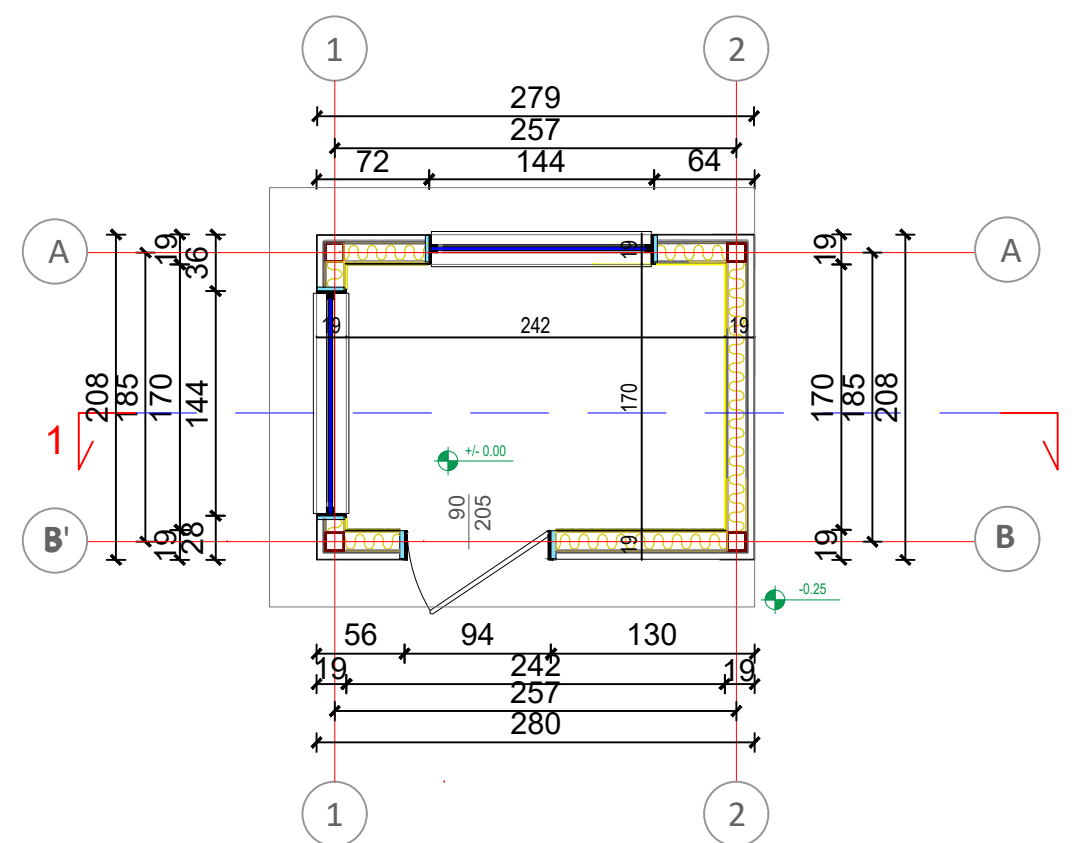
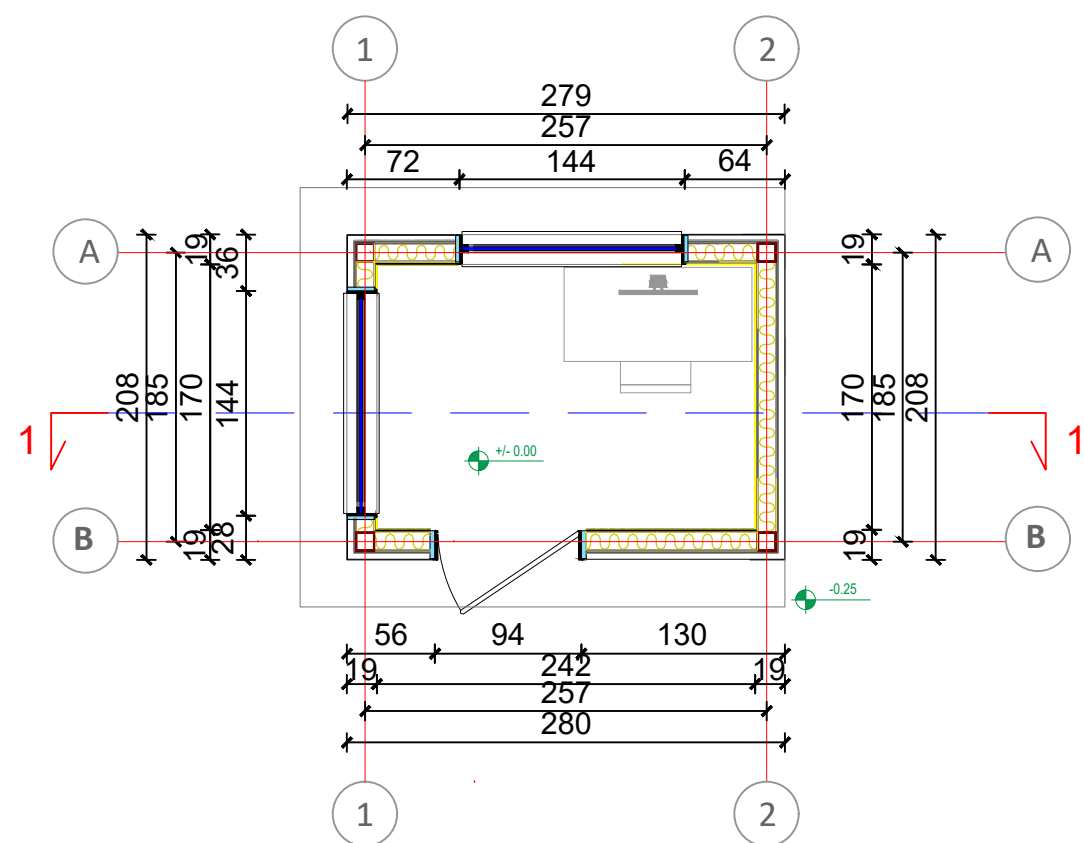

BASHKIA CERRIK



**ZetaKonsult sh.p.k**

Address: Rr. "Myrteza Topi", Nd 18, Hyrja 7, Ap 38, TIRANE

Cel: +355 (0)69 33 52 077

e-mail: zetakonsultshpk@gmail.com



**EMERTIMI I OBJEKTIT:**

NDERTIM I SHESHIT REKREATIV SHTERMEN, BASHKIA CERRIK

FAZA E PROJEKTIT : PROJEKT ZBATIMI

**EMERTESA E FLETES**

Planimetria e dimensionuar e gabines

SHKALLA Shk: 1/50

FLETA 61

**GRUPI I PROJEKTIMIT:**

Inxh. Ndert. Lorenc HOXHA  
Inxh. Ndert. Flutura Duro

Dt 10/09/2024

FORMATI A3

# Prerje dhe detaje teknike te gabines SH 1:50

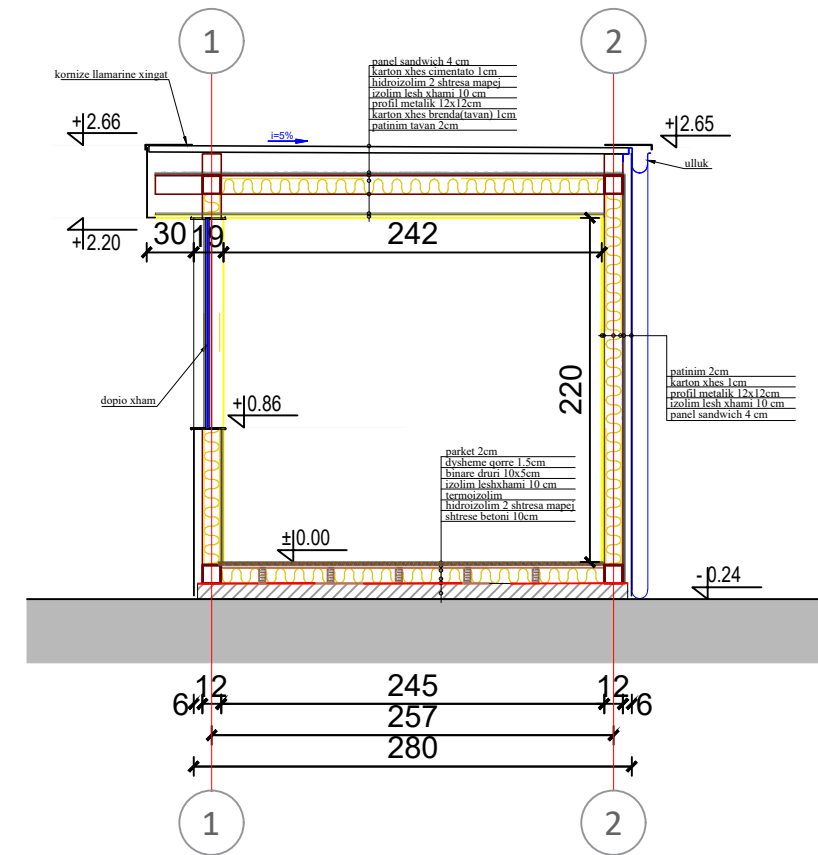
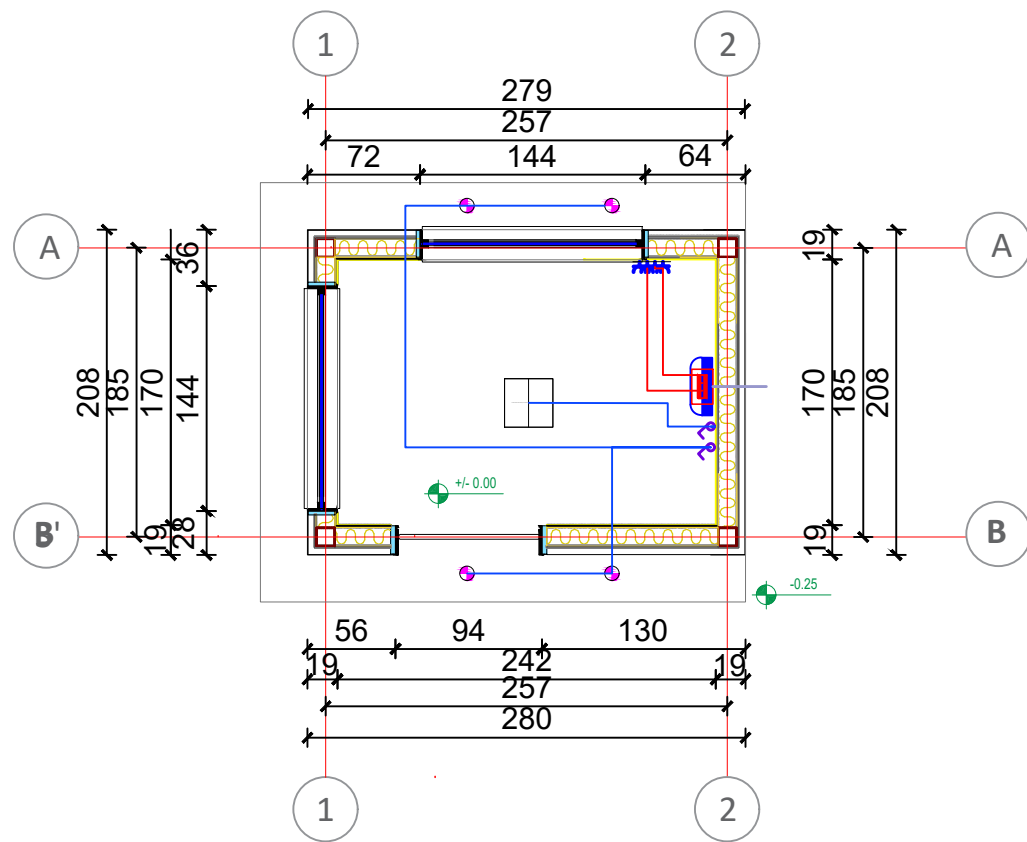

BASHKIA CERRIK



**ZetaKonsult sh.p.k**

Address: Rr. "Myrteza Topi", Nd 18, Hyrja 7, Ap 38, TIRANE  
 Cel: +355 (0)69 33 52 077  
 e-mail: zetakonsultshpk@gmail.com



**EMERTIMI I OBJEKTIT:**

NDERTIM I SHESHIT REKREATIV SHTERMEN, BASHKIA CERRIK

FAZA E PROJEKTIT : PROJEKT ZBATIMI

**EMERTESA E FLETES**

Prerje dhe detaje teknike te gabines

SHKALLA Shk: 1/50

FLETA 62

**GRUPI I PROJEKTIMIT:**

Inxh. Ndert. Lorenc HOXHA  
 Inxh. Ndert. Flutura Duro

Dt 10/09/2024

FORMATI A3

# Plani i mbuleses dhe fasada e gabines SH 1:50

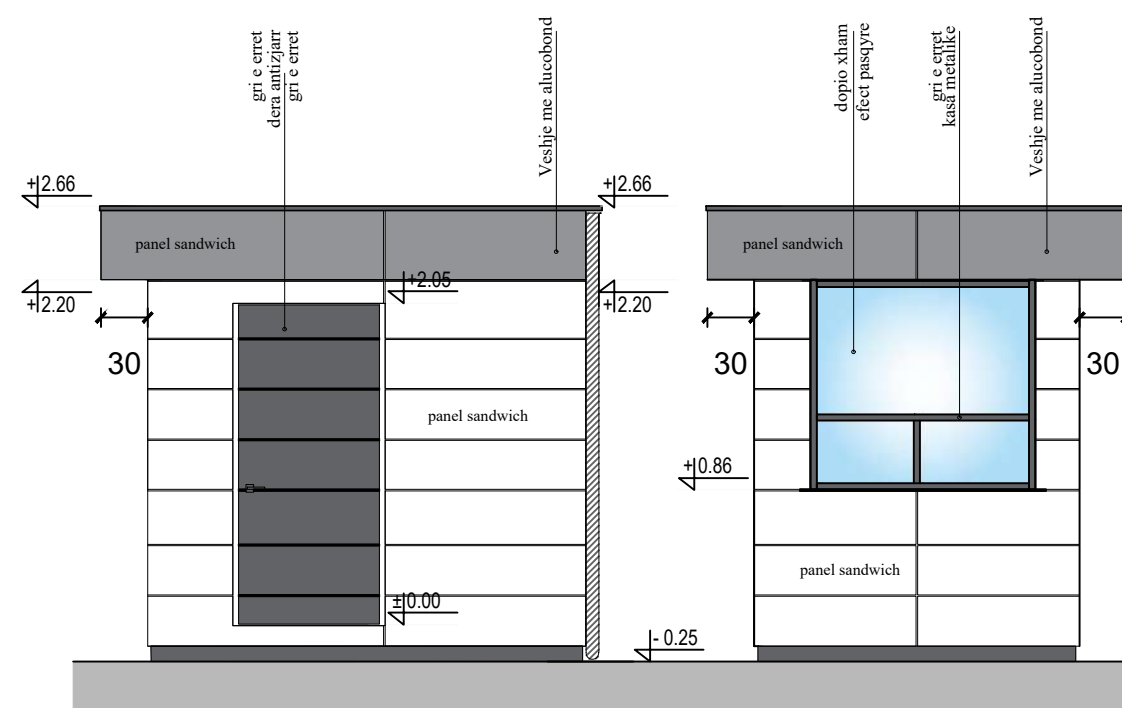
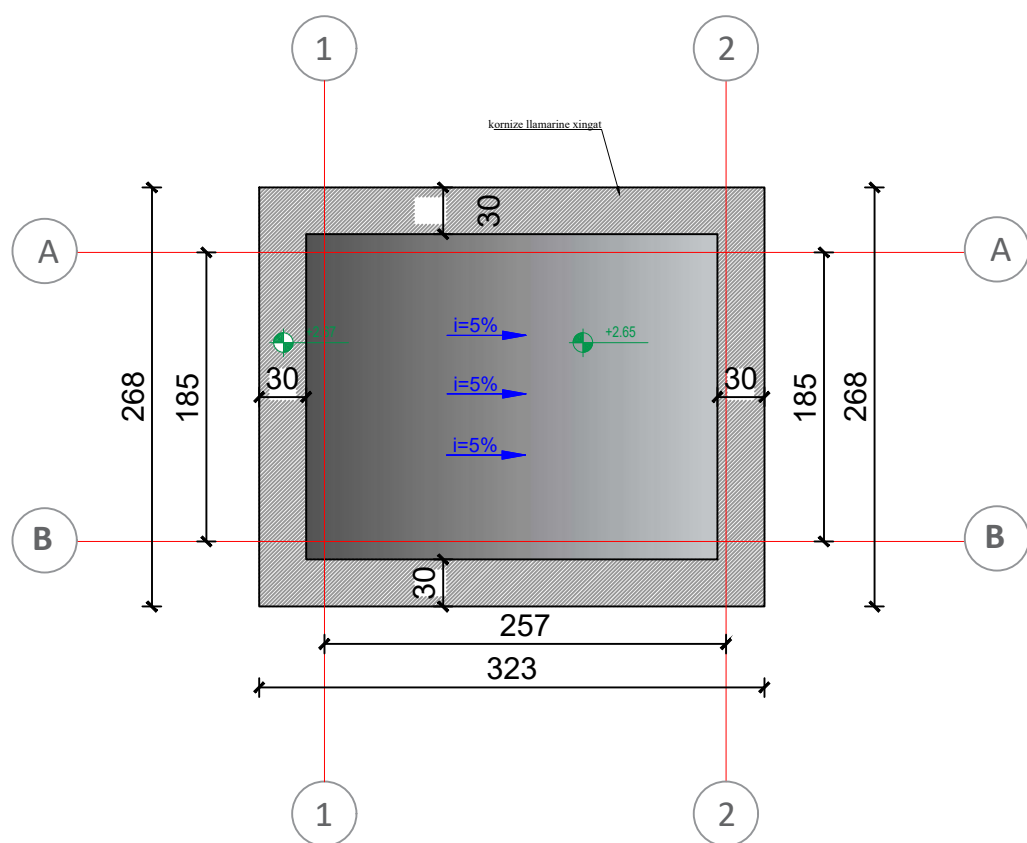

BASHKIA CERRIK



**ZetaKonsult sh.p.k**

Address:Rr."Myrteza Topi",Nd 18, Hyrja 7, Ap 38, TIRANE

Cel:+355 (0)69 33 52 077

e-mail:zetakonsultshpk@gmail.com



**EMERTIMI I OBJEKTIT:**

NDERTIM I SHESHIT REKREATIV SHTERMEN,BASHKIA CERRIK

FAZA E PROJEKTIT :PROJEKT ZBATIMI

**EMERTESA E FLETES**

Plani i mbuleses dhe fasada e gabines

SHKALLA Shk:1/50

FLETA 63

**GRUPI I PROJEKTIMIT:**

Inxh. Ndert.Lorenc HOXHA  
Inxh.Ndert.Flutura Duro

Dt10/09/2024

FORMATI A3