



BASHKIA ROSKOVEC

DREJTORIA E PLANIFIKIMIT DHE ZHVILLIMIT TE TERRITORIT

# OBJEKTI: RIPARIM I SHKARJES NE VARREZAT KURJAN



	Porosites <b>Bashkia Roskovec</b>	Projekt RIPARIM I SHKARJES NE VARREZAT KURJAN	Grupi i Projektimit : Ing. Aldi HOXHA Ing. Samuela PLAKA Ing. Eldison KOCAQI	Drejtor i P.Z.H.T : Eneida HOXHA	Titull flete KAPAKU	Date	Flete A3 Nr. <b>00</b>
	Miratoi Kryetar: Majlinda BUFI					Shkalla	

477894.610  
 4508889.435

 478018.230  
 4508889.435

**Legjenda**

 Shtresë  
 Bazë

Parcelat





Ndërtësat

 Rendi 3 (Kufi  
 Bashki)

 Rendi 2 (Kufi  
 Qarku)

Rendi 1 (Kufiri Tokësor)

 Rendi 1 (Kufiri Tokësor)

 Rendi 1 (Vijë Bregdeti)

 478018.230  
 4508810.895

 477894.610  
 4508810.895

<https://geoportal.asig.gov.al> ofron të dhëna gjeohapësinore të ofruara nga autoritetet publike përgjegjëse.

Përgjegjësia për saktësinë e të dhënave është e autoritetit publik që i ka krijuar ato.

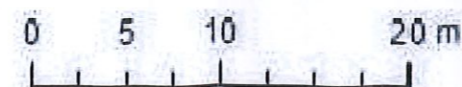

Sistemi koordinativ: KRGJSH

Projektimi: KRGJSH

	Porosites Bashkia Rëskovec	Projekt RIPARIM I SHKARJES NE VARREZAT KURJAN	Grupi i Projektimit : Ing. Aldi HOXHA Ing. Samuela PLAKA Ing. Eldison KOCAQI	Drejtor i P.Z.H.T : Eneida HOXHA	Titull flete ORTOFOTO	Date	Flete A3 Nr. 01
	Miratoi Kryetar: Majlinda BUFI					Shkalla	



477894.810

4508310.895



Porosites  
Bashkia Roskovec  
Miratoi  
Kryetar: Majlinda BUFI

Projekt  
RIPARIM I SHKARJES NE VARREZAT  
KURJAN

Grupi i Projektimit :  
Ing. Aldi HOXHA  
Ing. Samuela PLAKA  
Ing. Eldison KOCAQI

Drejtor i P.Z.H.T :  
Eneida HOXHA

Titull flete  
PLANVENDOSJE E MURIT

Date

Shkalla

Flete A3 Nr.

02

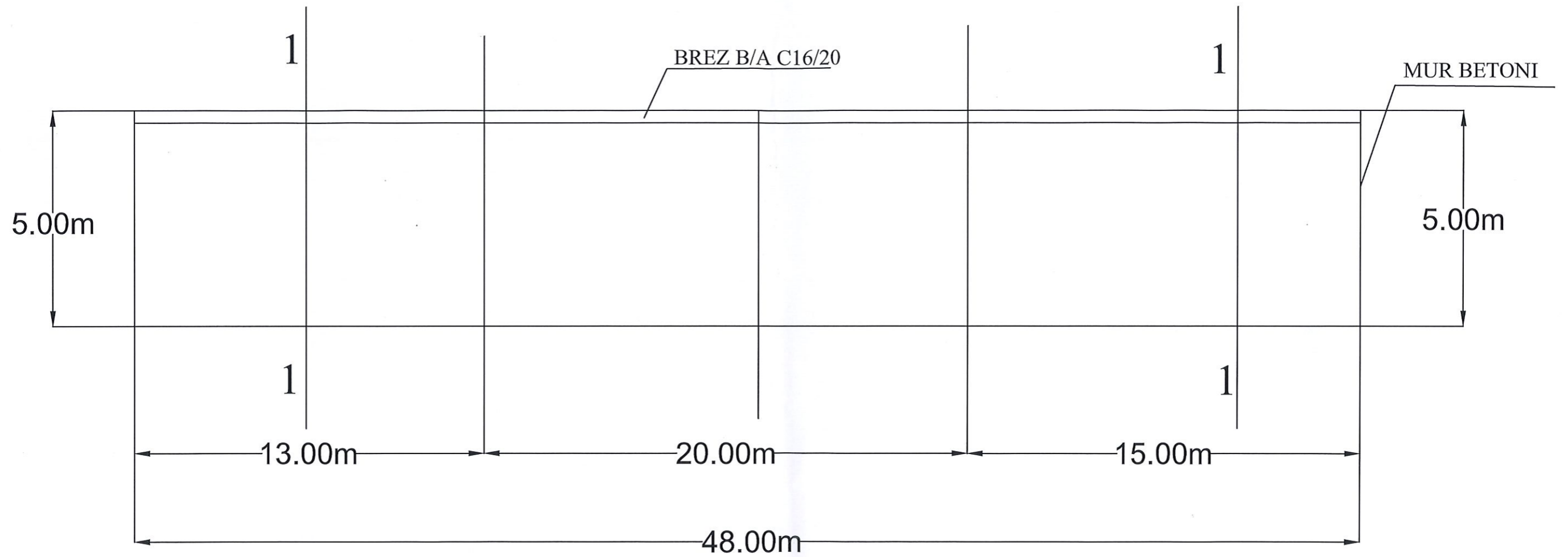

Porosites  
**Bashkia Roskovec**  
 Miratoi  
 Kryetar: **Majlinda BUFI**



Projekt  
 RIPARIM I SHKARJES NE VARREZAT  
 KURJAN

Grupi i Projektimit :      Drejtor i P.ZH.T :  
 Ing. Aldi HOXHA      *[Signature]* Eneida HOXHA  
 Ing. Samuela PLAKA      *[Signature]*  
 Ing. Eldison KOCAQI      *[Signature]*

Titull flete  
**PRERJE GJATESORE**

Date  
 Shkalla

Flete A3 Nr.  
**03**

# PRERJA 1-1

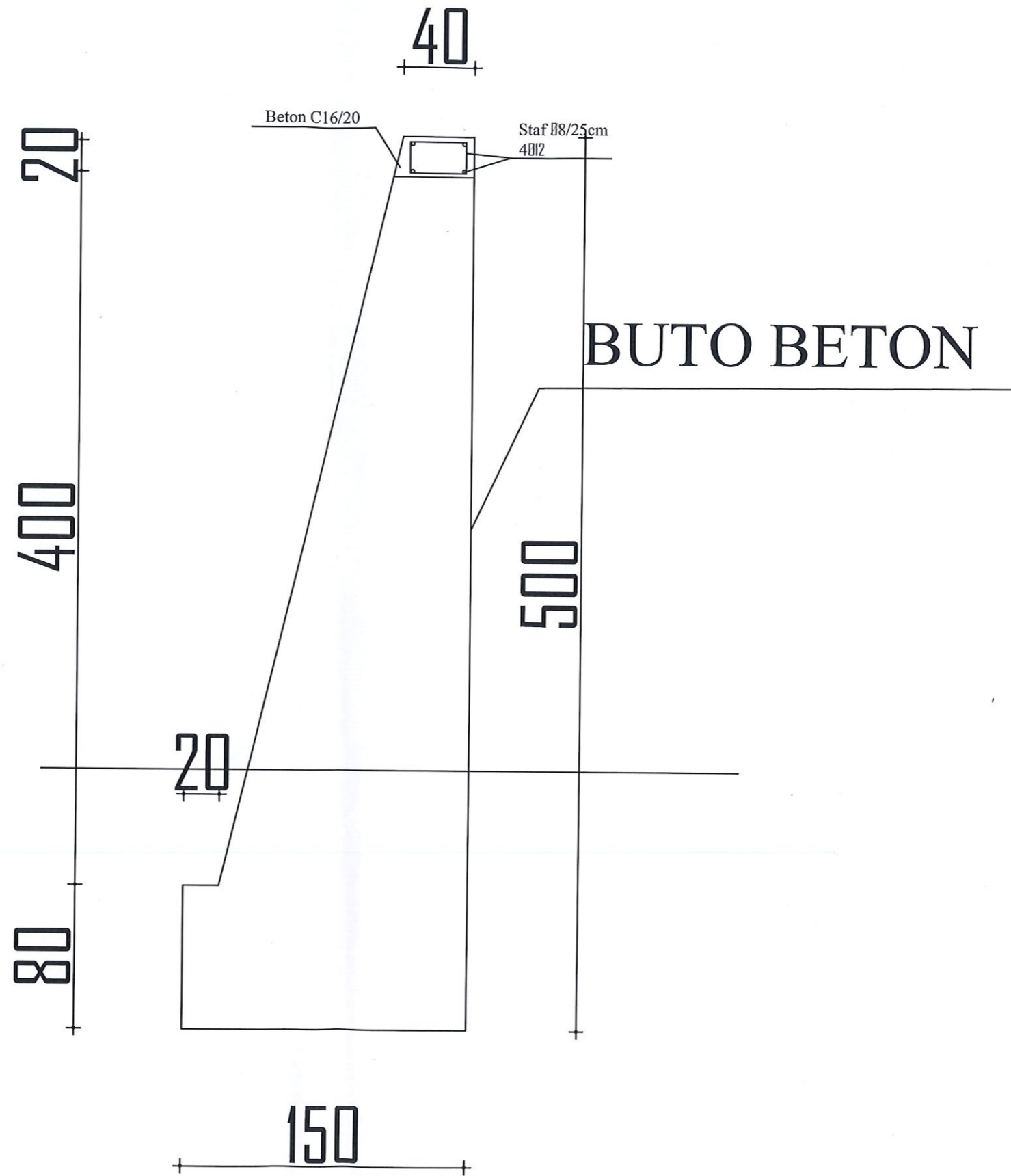

Porosites  
**Bashkia Roskovec**  
 Miratoi  
 Kryetar: **Majlinda BUFI**



Projekt  
 RIPARIM I SHKARJES NE VARREZAT  
 KURJAN

Grupi i Projektimit :  
 Ing. Aldi HOXHA  
 Ing. Samuela PLAKA  
 Ing. Eldison KOCAQI

Drejtor i P.ZH.T :  
**Eneida HOXHA**

Titull flete  
**PRERJE TERTHORE**

Date  
 Shkalla

Flete A3 Nr.  
**04**