

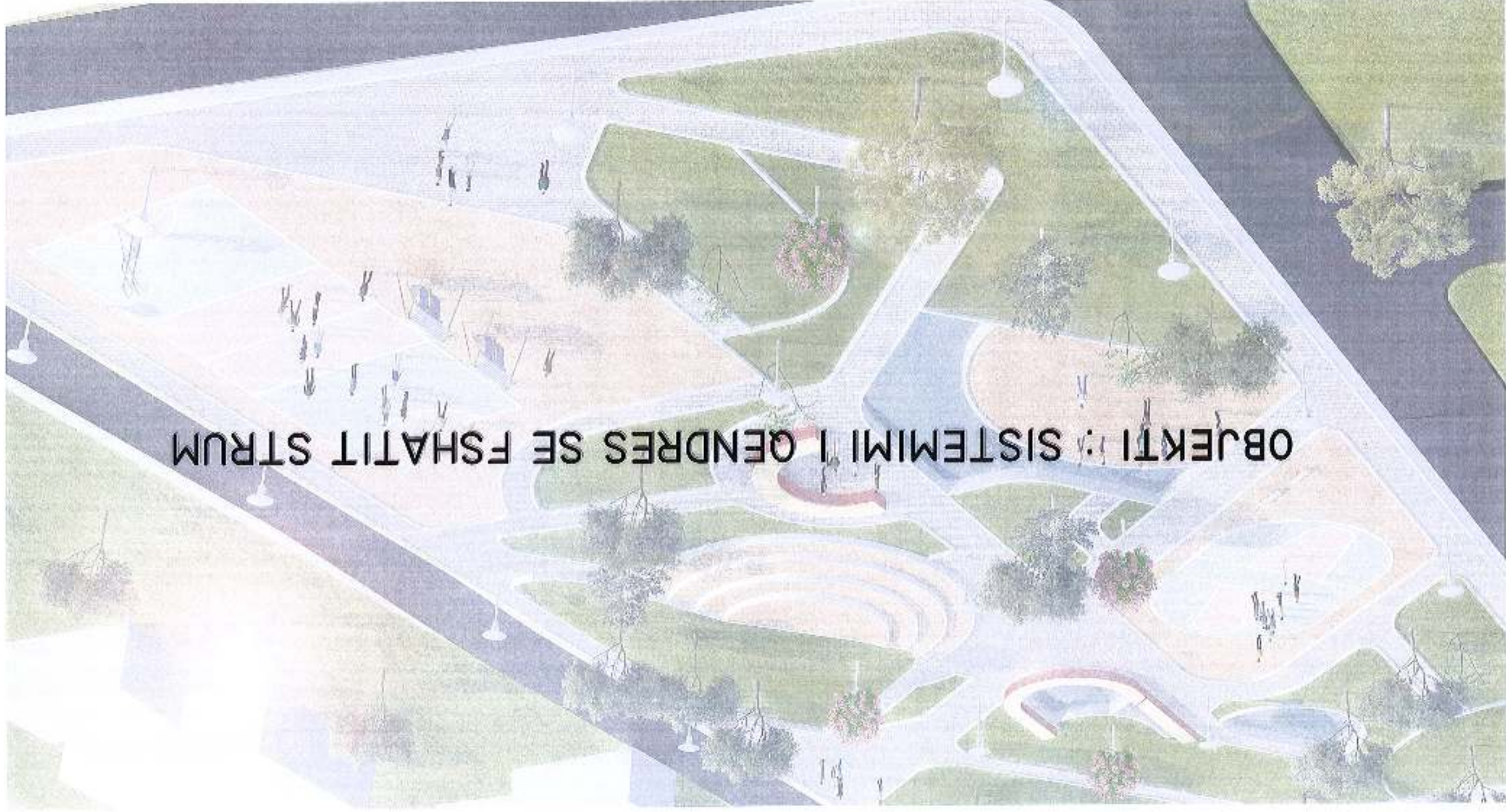

BASHKIA ROSKOVEC

DREJTORIA E PLANIFIKIMIT DHE ZHVILLIMIT TE TERRITORIT



OBJEKTI : SISTEMIMI I QENDRES SE FSHATIT STRUM

SHENIM : NDRYSHIMET NE PROJEKT DUHET TE MIRATOHEN ME PARE NGA GRUPI I PROJEKTIMIT, DHE DREJTORIA E PLANIFIKIMIT DHE ZHVILLIMIT TE TERRITORIT.

PROJECTE  
BASHKIA ROSKOVEC  
MIRATOI  
KRYETAR: MAJLINDA BURRI

FUNDAN  
ARK. KEJSI VOLI  
ING. ELDISON KOCALI  
ING. ERIGELT SJNI  
ING. ETMAZ IDRIZI

DREJTOR I P.Z.H.T :  
RAKIP HAZIRAJ

EMERTIM FLETE  
KAPAKU I PROJEKTIT

DATE  
30. 04. 2018  
SHKALLA

FLETE A3  
NR.  
00





Postilles:  
Bashkia Roskovec



Projekt: 2020/01  
SISTEMIMI I DENDRES SE  
FSHATIT STRUM

Grupi Projektues:  
Ark. Kujtim VLLI  
Ing. Edison KOCALI  
Ing. Ergje GJINI  
Ing. Shqiponja

Projekt: 2015/01  
RAKIP HAZOAJ  
RAKIP HAZOAJ

Titulli:  
ZONIMI I PROJEKTT  
(ORTOFOTO 2015)

Sheqer:  
1:500

Data:  
2015/08

Letra 42 Nr.  
10



KRGJSH

"Rruga e Ligentit"

"Rruga Bashkimi"

"Rruga e Ligentit"

"Rruga Bashkimi"





Ministria e Energjitikës dhe Infrastrukturës  
Kryetari: Majlinda Buri  
Bashkia Roskovec

Projekt: 2020/11  
SISTEMI I DENDRES SE FSHATIT STRUM

Grupi Projektues:  
Ark. Kapti Vll.  
Ing. Edison Ruzhici  
Ing. Erigjet Gashi  
Ing. Liriaz IDRIZI

Drejtori P.A.I.J.:  
RAKIP HAZZAJ

Titulli i hartës:  
EVIDENTIM I GJENDJES EKZISTUESE TE SHESHIT TE NDERTIMIT

Dati:  
20/11/2018

Skala:  
1:1

Letra e H-  
02







Flisures  
 Bashkia Reskovec  
 Nr. 1  
 Kryetar: Majlinda Buri



Projekt - stacion  
**SISTEMIMI I DENDRES SE FSHATIT STRUM**





Emri i projektantit  
 Ark. Kaja Ylli  
 Ing. Edison Kocaj  
 Ing. Ergut Sllari  
 Ing. Elmaz Idrizi

Ingjier: PNT  
 RAKIP HAZIZA

Titulli  
**RRETHIMET DHE PRISHJET E PARASHIKUARA NE PROJEKTIN**

Date  
 20/04/2018  
 Skala  
 1:500

Fig. 23-4  
**03**

- LEGJENDE**
-  ZONAT E NDERHYRJES
  -  VIA E PROJEKTTI TE RI
  -  MURET PER PRISHJE
  -  GARDHET PER PRISHJE

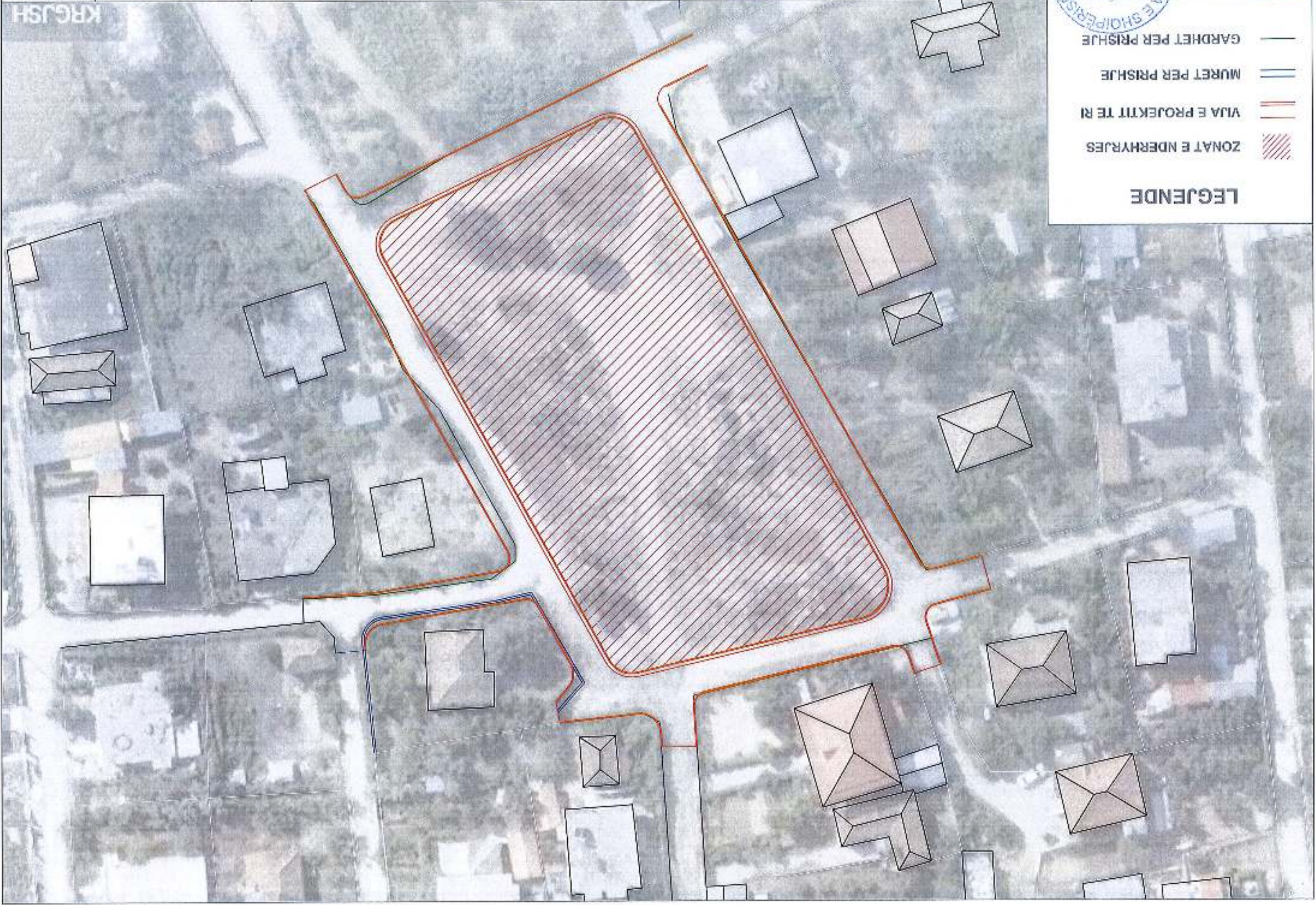

KRGLISH





Bashkia Roskovec  
 Kryetari: Majlinda Buri  
 Nr. 1500  
 Detyruesi:

Projekt zbatimi  
**SISTEMI I DENDRES SE FSHATIT STRUM**

Grupi Projektimi  
 Ark. Kujtim Vllashti  
 Ing. Edison Kucani  
 Ing. Ergje Guri  
 Ing. Elmaz Kodri  
 Detyruesi ZHT:  
**RAKIP HAZIJA**

Titull i tabeles  
**PLANIMETRIA E PERGJITHSHE E OBJEKTTI**

Data  
 20/04/2018  
 Skala  
 1:500

Fletja Nr. 04

- LEGJENDE**
- OBJEKTIET NE ZONE
  - STOLA DRURI
  - AMFITEATER BETONI
  - BETON I STAMPUAR
  - MUR I RI QE NDERTOHET
  - SIFERPAGE E GJELBERUAR
  - TROTUAR ME PLLAKA
  - SHTRIM ME CAKELL
  - RRUGE EKZISTUESE
  - FUSHE SPORTIVE







Prishtinë  
Bashkia e Roshkovës  
Kryetari: Majlinda BUFI



Projekt: stacioni  
SISTEMIMI I DENDRES SE  
FSHATIT STRUM

Enxheli Projektimi  
Dok. Kujti VOKI  
Ing. Edison KOCALI  
Ing. Ergjesh BAJMI  
Ing. Elmaz IDRIZI

Disjner: 2017  
RAKIP HAZIZAJ

Titulli: Parku  
FUNKSIONALITETI I ZONAVE TE PARKUT

Datë: 30/04/2018  
Skala: 1:500

Fig. 43 H



DENDRA E FSHATIT STRUM

ZONA E DENDRIMIT

ZONA E LOJERAVE  
PER FEMAJE

ZONA E FUSHES SPORTIVE





Portshes  
 Bashkia e Shkupit  
 Kryetar: Mejinda Buri



Projekt-shpallim  
**SISTEMI I DENDRES SE FSHATIT STRUM**

Grupi Projektues  
 Ark. Kujtim Vllas  
 Ing. Eshon Kocani  
 Ing. Erigjet Gashi  
 Ing. Elmaz Drazhi

Dr. Elton Peci  
**RAKIP HAZIRAKI**

Titulli: **PLANIMETRIA E DIMENSIONUAR E OBJEKTIT**

Numri: 1071  
 Shtet: SHQIPËRI

Forma: 05

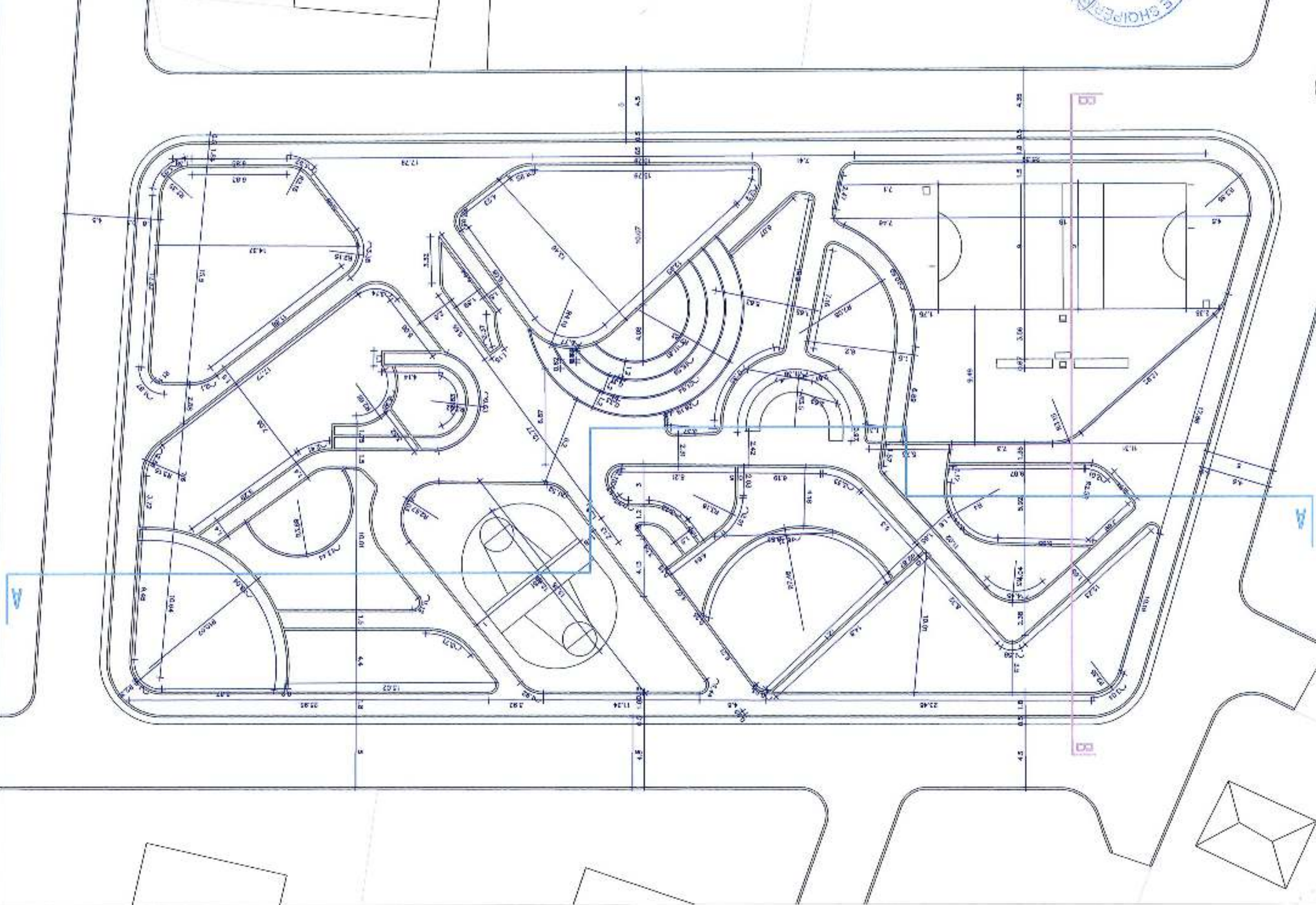





Kryetari: Majlinda Bllizi  
 Ministri  
 Bashkia e Prishtines  
 Bashkia e Prishtines



Projekti: SHUMI  
 FSHATI STRUM  
 SISTEMIMI I DENDRES SE

Dr. Ing. Fehmi Haxhiu  
 Ark. Kujtim Vllas  
 Ing. Edlira KUCALI  
 Ing. Ergje GJINI  
 Ing. Enxhë DORZI

Dr. Ing. Fehmi Haxhiu  
 Ark. Kujtim Vllas  
 Ing. Edlira KUCALI  
 Ing. Ergje GJINI  
 Ing. Enxhë DORZI

PLANIMETRIA E KULLIMIT TE UJERAVE  
 SIPAS PËRREKSES SE TERRENTIT

SHALI  
 1333  
 Data: 30/04/2018

06  
 Folia 03/04

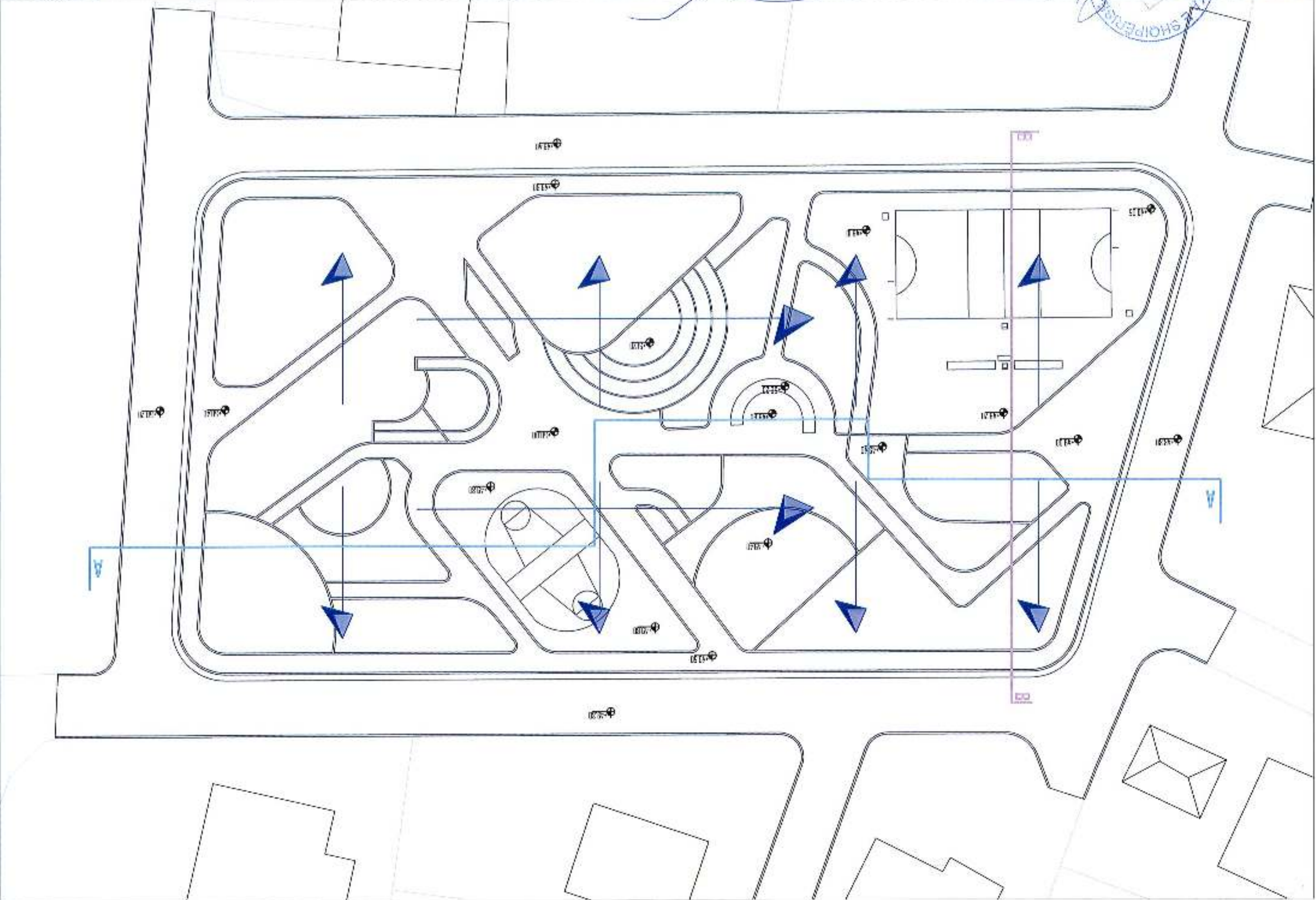





Kryetari  
Bashkia e Shkupit  
Kryetari: Hajrullah BASHI



Projektacioni  
SISTEMI I DENDRES SE  
FSHATIT STRUM

Grupi Projektimi  
Ark. Kujtim VLLI  
Ing. Edison KOCANI  
Ing. Ergjesh GJINI  
Ing. Elmaz IDRIZI

Grupi Projektimi  
RAKIP HAZIZA  
Ing. Elmaz IDRIZI

Imri i shtetit  
PLANIMETRIA E POZICIONIMIT TE NDORRIMIT

SHKALLA	1:500
DATA	30/04/2018

Figura 42 M  
07

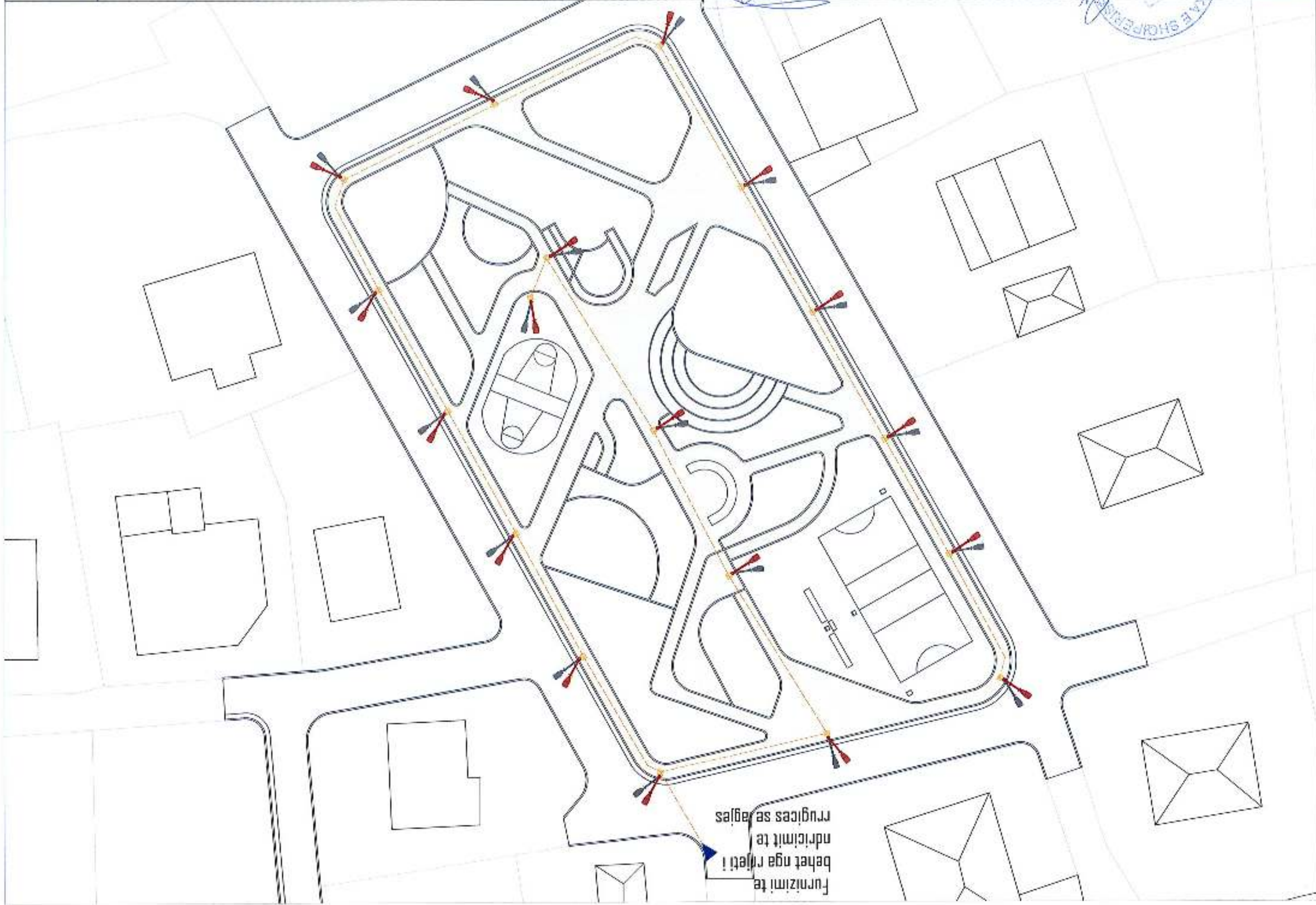

Furnizimi te  
behet nga rrjeti i  
ndorrimt te rregjues se rregjues



# SKEMA E FURNIZIMIT ME ENERGIJ ELEKTRIKE

Furnizimi te behet nga  
rrejeti i ndricimit te  
rruges se lagjes

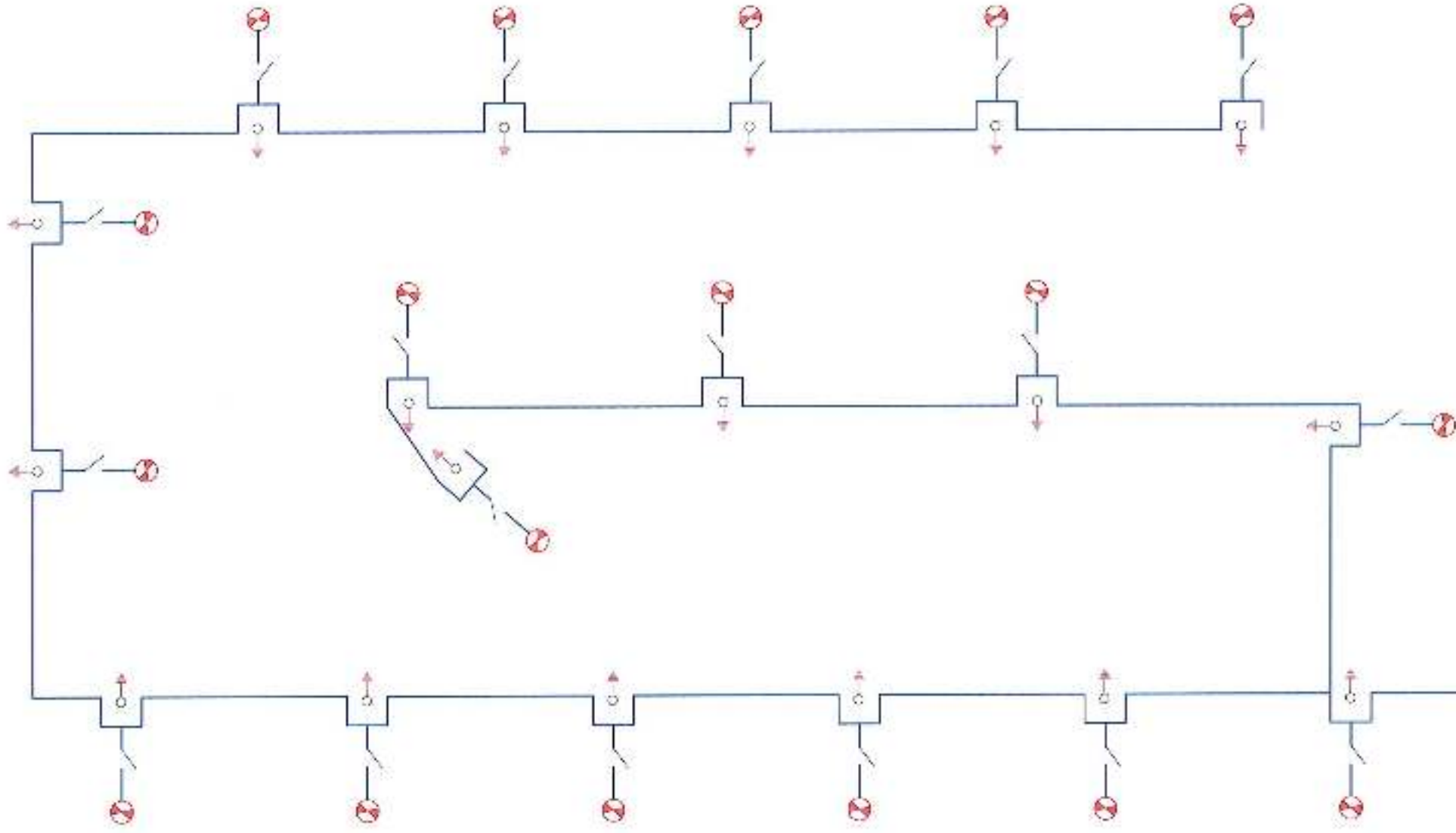

Simboli	Emertimi i elementit
	Ndricuesi
	Automat 2P, 6A
	Morseta e lidhjes se ndricuesit
	Takezimi i shtyllës

SKEMA E FURNIZIMIT ME ENERGIJ  
ELEKTRIKE

Numri i hartës

Projektimi: P.M.T

RAKIP HAZIZI

Proj. i Prilimit

Ar. Kaja VDI

Ing. Eklosion KOCALI

Ing. English GJINI

Ing. Eklosion DORZI

FSHATIT STRUM  
SISTEMIMI I DENDRES SE

Projekt - shkrim



Kryetar: Majlinda BURR  
Bashkia Roshkovec

Forcetes



Shteta

1300

Date

03/04/2018

08

Hartë Nr. 4-





Pa-rtetës: Bashkia e Gjakovës  
Kryetar: Majlinda Buri



Projekt-20200  
SISTEMI I BENDRES SE FSHATIT STRUM

Enxhiti Projektant:  
Ark. Kujtim VOCI  
Ing. Edison KOCALI  
Ing. Ergjith SURI  
Ing. Elmaz IBERZI

Udhëzuesi Projektant:  
RAKIP HAZZANI

Tëllimtar  
DETAJE TE MONTIMIT TE NDRICIMIT

Shtab

Data  
30/04/2018

Blloku 43 M  
09

Detaji i montimit te shtylles

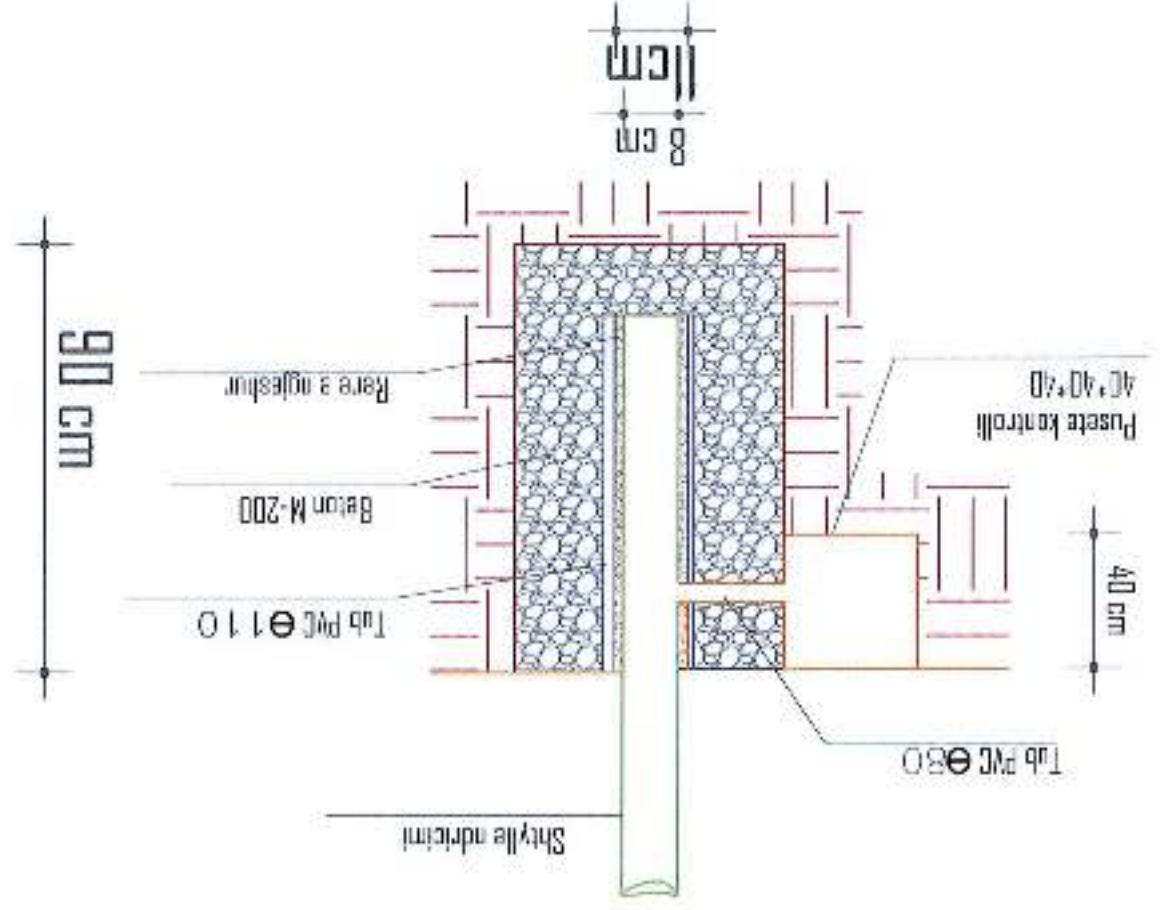

Detaji i kalimit te kabllit ne pusete

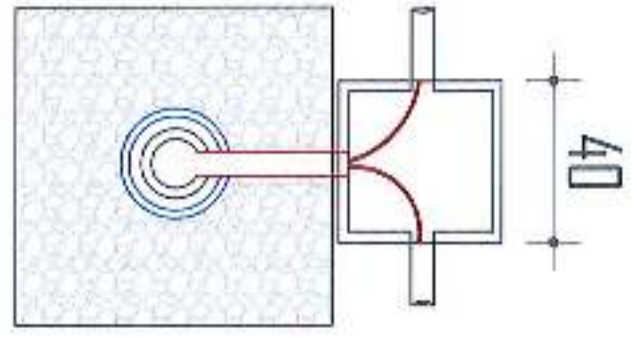

Detaji i montimit te Tokozimit te shtylles

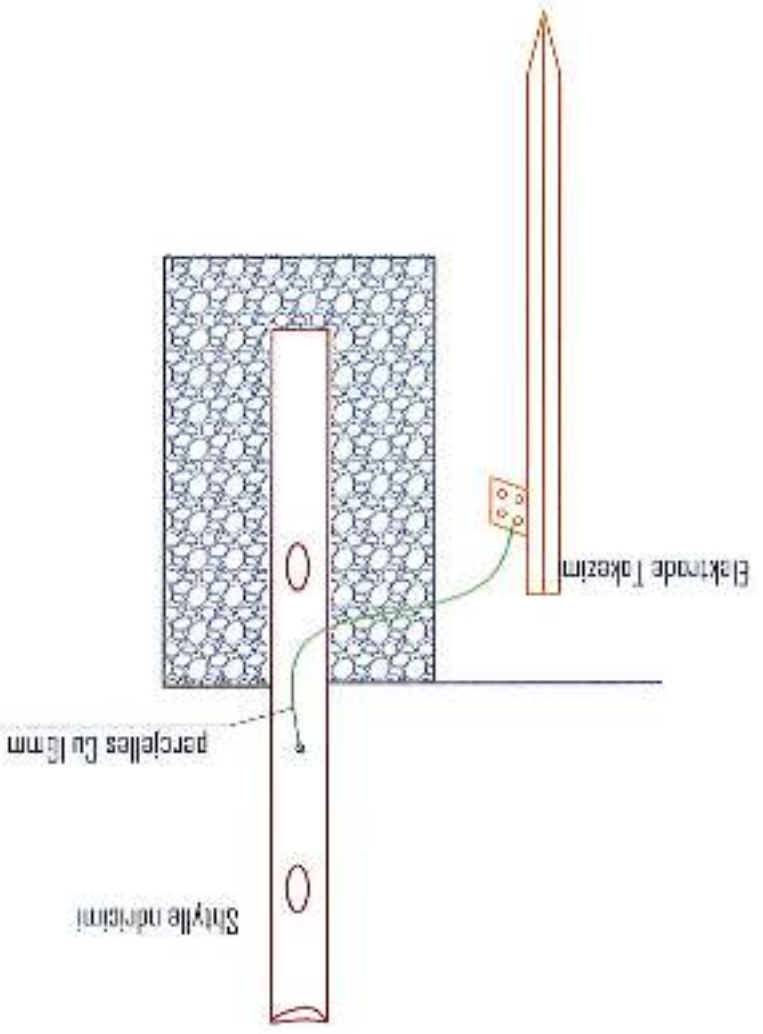



Detaji i instalimit te kablove dhe lidhja e ndricuesit

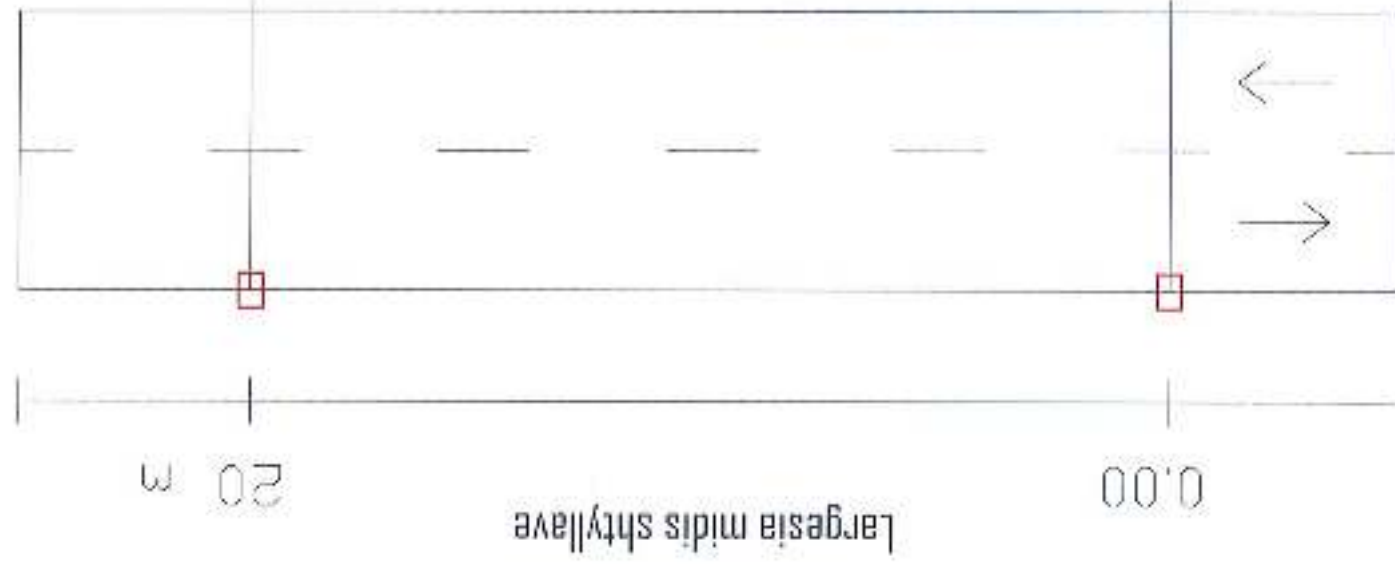
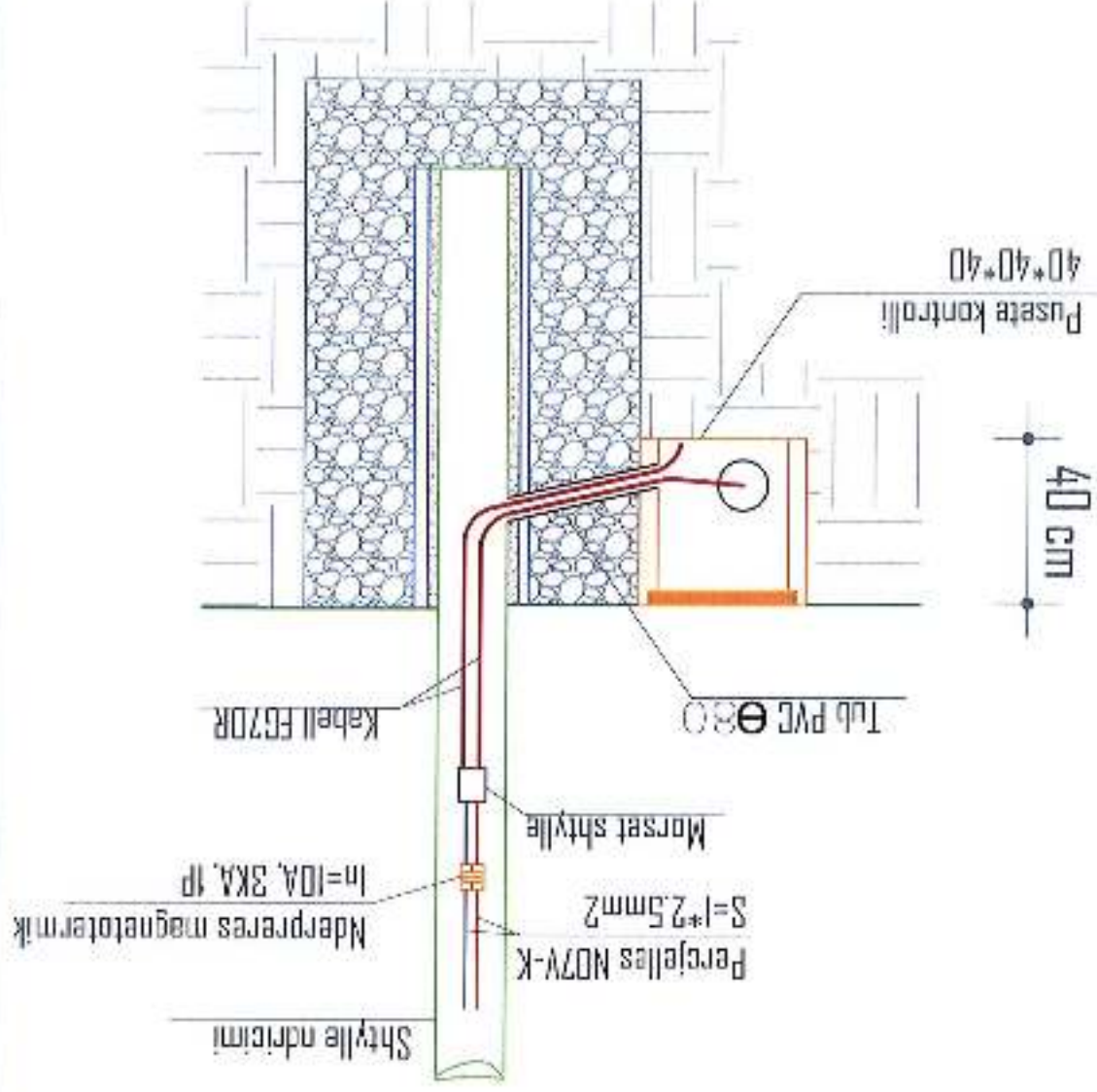

largësia midis shtyllave

20 m

0.00





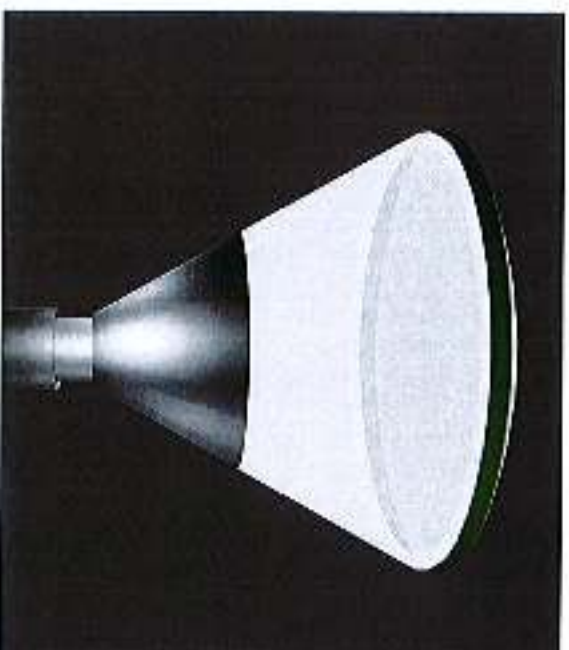
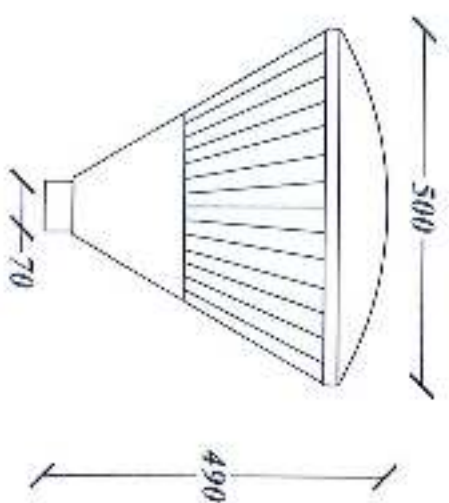

### TE DHENJA TEKNIKE

- Shitylla cilindrike, celiku me lartesi 3m-5m dhe Ø1-Ø9mm.
- Ngjyra: a) RAL 7035. Ngjyra e shlyelles mund te ndryshoje sipas kerkeses.
- Bluzori : rezisten ndaj goditjeve i qendrueshem ndaj rrezave UV, sherben per te drejtuar rrezat poshte.
- Mbuluesa: Flete alumini e lyster me boje te zezë nga jashte , e barribe brenda.
- Barimi i drites: Metal halid Sodium, IND.Ekonomike.
- Sikailla e mbrojtjes: IP-65
- Fiksimit: Mhoshetur
- Aplikimi: per dizejninin e sheshëve , rrugëve urbane, parkëve.

### LAMPJA ME SHKARKIM

- Fuqia: 70-110W
- Tipi I llampes: Metal halide, Sodium
- Fluksi I ndricimit: 5600-6500 lm
- Reflektori: Alumini i oksiduar e i Inciduar
- Parroillampa: E27
- Siperndarja e fluksit Simetrik
- Klasa e izolacionit: I

### LAMPJA IND

- Fuqia: 40-65W
- Tipi I llampes: llampe me induksion
- Fluksi I ndricimit: 2900-1550 lm
- Temperatura e ngjyres: 3000-4000K
- Reflektori: Alumini i oksiduar e i Inciduar
- Siperndarja e fluksit: Simetrik
- Klasa e izolacionit: I

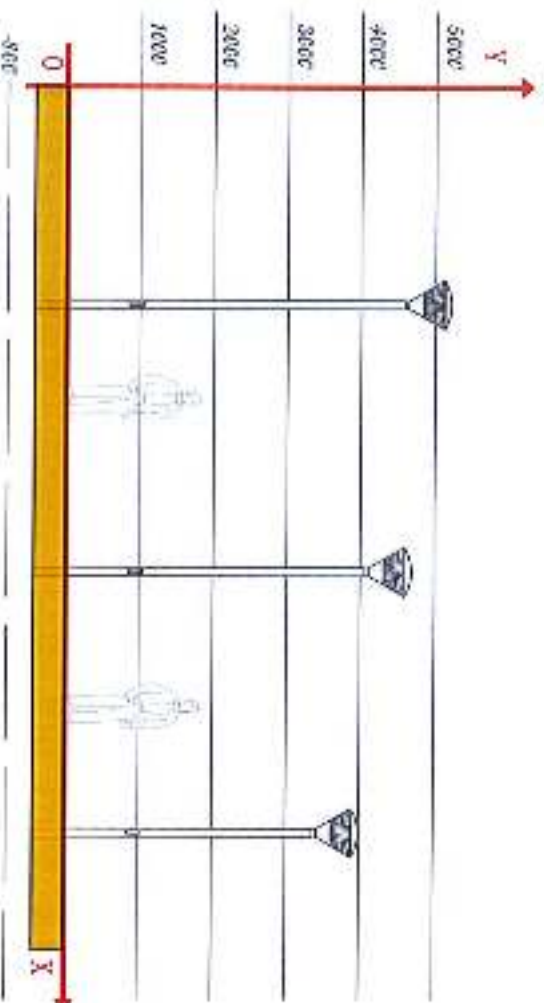

Titulli i detyrës  
**SISTEMI I DENDRES SE FSHATIT STRUM**

Emri i projektantit  
 Prof. Kujtim VUJ  
 Emri i ekspertit teknik  
 Ing. Esmeralda KURTI  
 Ing. Esmeralda KURTI  
 Ing. Elton ILLI  
 Emri i bashkëpunëtorit  
 SHKURRI HAZZAZI  
 Emri i bashkëpunëtorit  
 Ing. Elton ILLI

Titulli i detyrës  
**DETAJE TE NDRICUESVE TE POZICIONUAR ME H=3.5 m**

Skala	3000/1
Skala	1/50

Titulli i detyrës  
**11**





RAKIP HAZRAT  
DIREKTOR P.2011

Ar. Kujtim Veli  
Ing. Edisson Kocani  
Ing. Erjona Dajti  
Ing. Elmas Idrizi

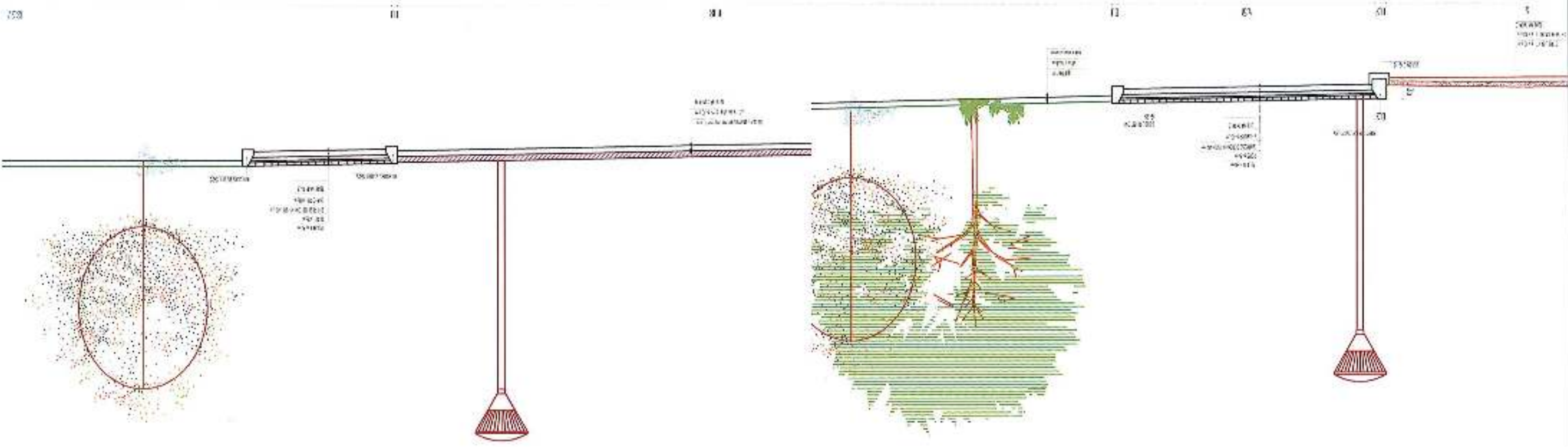

DETALJ-SH 1:75

DETALJ-SH 1:75



PRERJA A-A





Republika e Kosovës  
Bashkia e Prishtinës  
Kryetari: Majlinda Buri  
Deputet: Rashide Roskovec



Projektimi i Sistemit të Energjisë Elektrike  
FSHATIT STRUM  
SISTEMINI I DENDRES SE

Arif Kajtazi  
Inj. Kajtazi  
Inj. Edison Kocaku  
Inj. Enxhel Guri  
Inj. Enxhel Idrizi

Dirigjenti i P.A.J.  
Rokip Hazdaj

PRRJA B-B E TERRENT  
Ish. Hoxha

Skala: 1:50  
Data: 30/04/2018

13

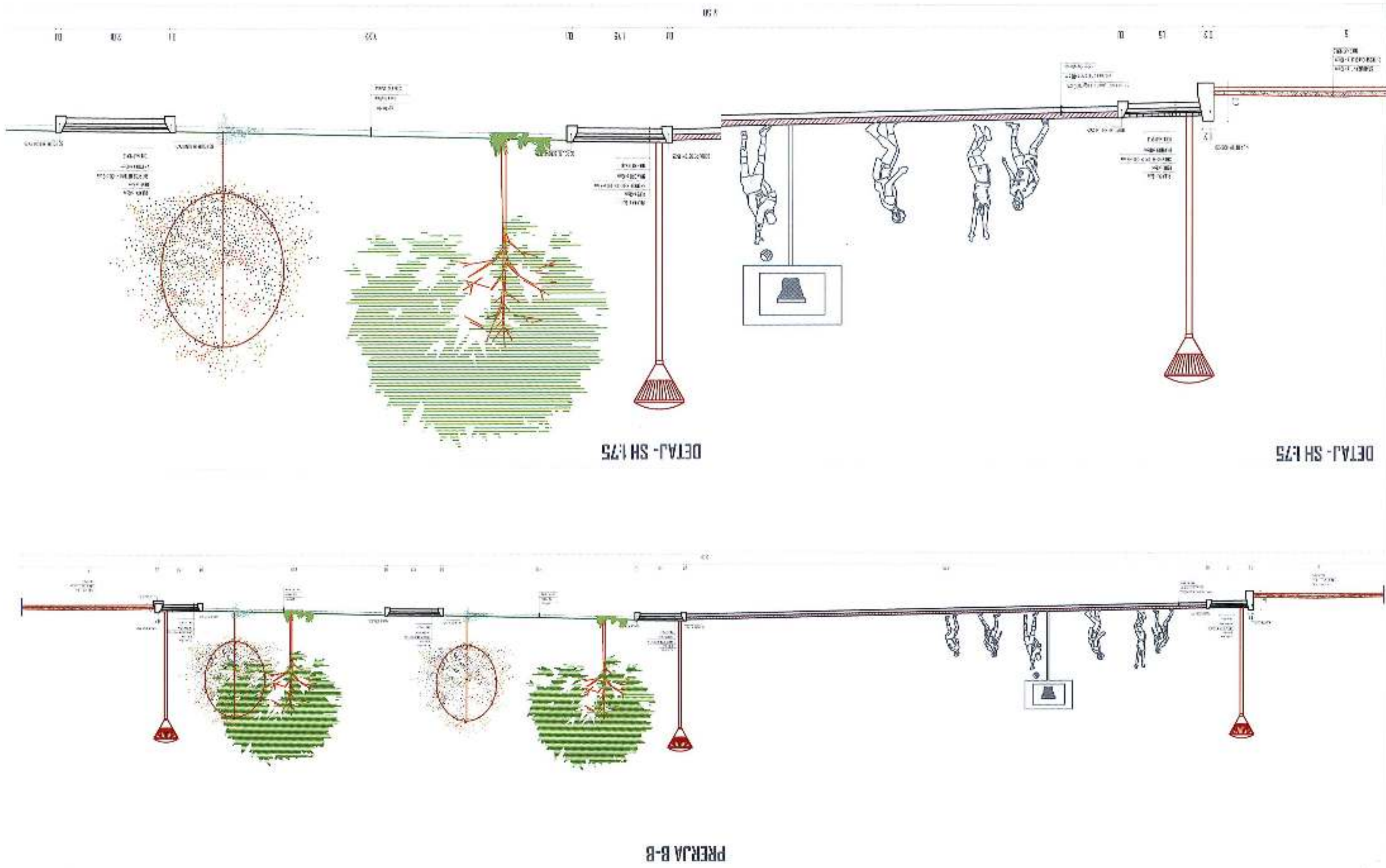





Republika e Kosovës  
 Bashkia e Roskovec  
 Kryetari: Majlinda BUFI



Projekt - zbatim  
**SISTEMIMI I DENDRES SE FSHATIT STRUM**

Grupi Projektues:  
 Ark. Kujai YDJA  
 Ing. Et'hem KOCALI  
 Ing. Erigjet GJINI  
 Ing. Elnaz IDRIZI

Erhonorimi: P.R.1  
**RAKIP HAZIZAJ**

Titulli i projektit:  
**PANJE 3DIMENSIONALE**

Datë:  
 20/04/2018

Skala:  
 1:500

17  
 Figura N.2.1



**DENDORA E FSHATIT STRUM**





Numri: 100/2018  
Kryetari: Majlinda Buri



Projekti: 100/2018  
SISTEMIMI I QENDRES SE  
FSHATIT STRUM

Prof. Prishtine  
Ark. Kujtim Vllas  
Ing. Edison Kocari  
Ing. Erigjet Gashi  
Ing. Elmira Idrizi

09/11/2018  
RAKIP HAZZAJ  
Drejtori PZHT

Titulli: PAMJE 3DIMENSIONALE

Data: 30/09/2018  
Skala: 1:500

Blloku 15



QENDRA E FSHATIT STRUM





Ministria e Punëve  
Publike

Bashkia Roskovec

Kryetari: Majlinda BUFI



Projekt: Bashkia Roskovec  
SISTEMI I DENDRES SE  
FSHATIT STRUM

Projekt: Profeshional  
Ark. Kaps: VOLI  
Ing. Edison KOCALI  
Ing. Ergjeft GJINI  
Ing. Elmira IDRIZI

Projekt: 2011  
RAKIP HAZIRAJ

Titulli: PAMJE 3DIMENSIONALE

Shekulli: Shekulli

Numri: 30/04/2018

16



DENDORA E FSHATIT STRUM





Projekt: Bashkia Roskovec  
 Mbrojt: Kryetari: Majlinda BUFI



Projekt - 2018 m  
**SISTEMIMI I DENDRES SE FSHATIT STRUM**

Projekti i përbërësit:  
 Ark. Kujat YU  
 Ing. Ertan KUCI  
 Ing. Elmaz IDRIZI

*Handwritten signatures and initials*

Titulli i titullit:  
**PAMJE 3DIMENSIONALE**

Shkallë: 1:500  
 Data: 30/04/2018

17  
 Ekipi i autorit



**DENDRA E FSHATIT STRUM**